

GEOTECHNICAL REPORT

**Freeman Logistics
Freeman Road East and 19th Avenue Northwest
Pierce County, Washington**

Project No. T-8565

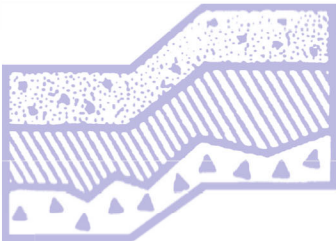

Terra Associates, Inc.

Prepared for:

**Vector Development Company
Kirkland, Washington**

**August 11, 2021
Revised July 11, 2022**

TABLE OF CONTENTS

	<u>Page No.</u>
1.0 Project Description	1
2.0 Scope of Work	1
3.0 Site Conditions	2
3.1 Surface	2
3.2 Soils	2
3.3 Groundwater	3
4.0 Seismic Considerations	3
4.1 Seismic Site Class	3
4.2 Soil Liquefaction	3
5.0 Discussion and Recommendations	4
5.1 General	4
5.2 Site Preparation and Grading	5
5.3 Surcharge	6
5.4 Excavations	7
5.5 Foundations	7
5.6 Lateral Earth Pressures for Retaining Walls	8
5.7 Slab-on-Grade Floors	8
5.8 Stormwater Detention Vault and Pond	9
5.9 Drainage	10
5.10 Utilities	10
5.11 Pavements	11
6.0 Additional Services	12
7.0 Limitations	12

Figures

Vicinity Map	Figure 1
Exploration Location Plan	Figure 2
Typical Settlement Marker	Figure 3
Typical Wall Drainage Detail	Figure 4

Appendices

Field Exploration and Laboratory Testing	Appendix A
Liquefaction Analyses	Appendix B

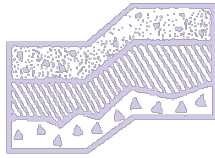

TERRA ASSOCIATES, Inc.

Consultants in Geotechnical Engineering, Geology
and
Environmental Earth Sciences

August 11, 2021
Revised July 11, 2022
Project No. T-8565

Mr. Tyler Litzenberger
Vector Development Company
11335 Northeast 122nd Way, Suite 105
Kirkland, Washington 98034

Subject: Geotechnical Report
Freeman Logistics
Freeman Road East and 19th Avenue Northwest
Pierce County, Washington

Dear Mr. Litzenberger:

As requested, we have conducted a geotechnical engineering study for the subject project. The attached report presents our findings and recommendations for the geotechnical aspects of project design and construction.

The native soils observed in the test pits are alluvial deposits generally consisting of interbedded layers of loose to medium dense, silt, fine sand, and silty fine sand to fine sandy silt. The CPT data shows similar interbedded alluvial soils extending to the CPT termination depths. Lesser amounts of peat were observed; however, CPT-101 indicated about 12 feet of peat. Groundwater levels observed generally range between depths of about 5 and 9 feet.

In our opinion, soil and groundwater conditions observed at the site would be suitable for support of the development as planned provided the recommendations contained herein are incorporated into design and construction.

Mr. Tyler Litzenberger
August 11, 2021
Revised July 11, 2022

We trust the information presented in this report is sufficient for your current needs. If you have any questions or require additional information, please call.

Sincerely yours,

TERRA ASSOCIATES, INC.



Stephanie L. King, E.I.T.
Staff Engineer



John Sadler, L.E.G., L.H.G.
Senior Engineering Geologist



7-11-2022

Geotechnical Report Freeman Logistics Freeman Road East and 19th Avenue Northwest Pierce County, Washington

1.0 PROJECT DESCRIPTION

We understand that the proposed project is an industrial development. Site development and building plans are currently not available; however, we expect that the development would consist of several industrial/warehouse-type buildings. Typical construction for this type of structure consists of precast concrete tilt-up perimeter wall panels with interior columns spaced at 30 to 50 feet. Building floors would be constructed at grade with dock-high access on one or more sides of the building. Structural loading is expected to be light to moderate, with isolated columns carrying loads of 50 to 100 kips and bearing walls carrying 4 to 8 kips per foot.

The recommendations in this report are based on our understanding of the design features outlined above. We should review design drawings as they become available to verify that our recommendations have been properly interpreted and to supplement them, if required.

2.0 SCOPE OF WORK

Our scope of work for this project included a subsurface exploration, laboratory testing, office review, engineering analysis, and preparation of this report. In June 2021 our subsurface exploration consisted of the excavation of 13 test pits to maximum depths of about 8.5 to 9.5 feet using a track-mounted excavator. In July 2021, we further explored subsurface conditions with two 60-foot-deep cone penetration tests (CPTs), and one approximately 55-foot deep CPT. In June 2022, we supplemented data by excavating an additional 5 test pits to maximum depths of approximately 12 to 13 feet and pushed two additional CPTs to 60 feet. Our subsurface characterization also included conditions observed in ten test pits excavated at the site by Terra Associates, Inc. in January and March of 2019.

Using the results of our subsurface explorations and laboratory testing, analyses were undertaken to develop geotechnical recommendations for project design and construction. Specifically, this report addresses the following:

- Soil and groundwater conditions.
- Seismic considerations.
- Site preparation and grading, including recommendations for building preload or surcharge to mitigate floor and foundation settlement.

- Excavations.
- Foundations.
- Slab-on-grade floors.
- Lateral earth pressures for wall design.
- Stormwater detention vault and pond.
- Drainage.
- Utilities.
- Pavements.

3.0 SITE CONDITIONS

3.1 Surface

The site is an approximate 21-acre assemblage of 13 parcels located northeast of and adjacent to the intersection of Freeman Road East and 19th Avenue Northwest in Pierce County, Washington. The site location is shown on Figure 1.

All but one of the parcels are occupied by single-family residences and/or outbuildings. Site topography is relatively flat. Site vegetation consists of lawn and landscape trees and shrubs around the residences, brush, pasture grasses, and scattered trees. The southeastern parcel, located north of and adjacent to 19th Avenue Northwest, approximately 250 feet east of Freeman Road East, is currently planted with row crops.

3.2 Soils

The native soils observed in the test pits are alluvial deposits generally consisting of interbedded layers of loose to medium dense, silt, fine sand, and silty fine sand to fine sandy silt. The CPT data shows interbedded alluvial soils extending to the termination depths at all three test locations. Soil behavior types determined from the CPT data generally consist of about 10 feet of loose to medium dense sand to silty sand and very soft to stiff silt and clay overlying approximately 30 feet of medium dense sand, and silty sand to sandy silt. Soil behavior types below 40 feet generally consists of medium dense to very dense sand, sand with gravel, and silty sand with occasional soft to stiff silt and clay layers. Our most recent explorations indicate similar soils. Very trace amounts of peat was observed in Test Pits TP-101 and TP-103 between approximate depths of 10 to 12 feet.

The *Geologic Map of the Tacoma 1:100,000-scale Quadrangle, Washington*, by J.E. Schuster, A.A. Cabibbo, J.F. Schilter, and I.J. Hubert, (2015), shows surficial geology at the site consisting of Holocene alluvium (Qa). The soils observed in our subsurface explorations are consistent with this geologic map unit.

Detailed descriptions of the subsurface conditions observed in our subsurface explorations are given on the Test Pit Logs. The Test Pit Logs and CPT Data are attached in Appendix A. The approximate test pit and CPT locations are shown on Figure 2.

3.3 Groundwater

We observed groundwater seepage in 5 of the 13 test pits excavated in June 2021. The observed seepage was generally light and occurred below depths of about 7 to 8.5 feet. Light to moderate groundwater seepage was observed below depths of about 5 to 9 feet in 7 of the 10 test pits excavated in January and March of 2019. No groundwater seepage was observed in test pits excavated in June 2022. Hydrostatic levels determined from pore pressure dissipation testing at CPT-1 and CPT-3 in July 2021 were about 5.3 feet and about 7.7 feet below ground surface, respectively. Hydrostatic levels determined in June 2022 were at 6.3 feet below ground surface.

The depths to groundwater at the site will fluctuate on a seasonal basis with maximum levels occurring during the wet winter and spring months. We expect that the groundwater conditions observed in our test pits and CPT dissipation testing are slightly above seasonal low levels. The groundwater conditions observed in the test pits excavated during January and March of 2019 are likely more representative of a seasonal high groundwater level.

4.0 SEISMIC CONSIDERATIONS

4.1 Seismic Site Class

Soil conditions at the site, as discussed in the following section, will be subject to the soil liquefaction phenomenon. Because of this condition, per the current International Building Code (IBC), subsurface conditions would be assigned site class “F” which would require performing a site-specific seismic analysis to determine seismic forces for structural design. However, the IBC allows for using code derived seismic values for the soil conditions indicated if the buildings fundamental period is equal to or less than .5 seconds. We expect that these industrial buildings will fall into this category. In this case, based on soil conditions encountered and our knowledge of the area geology, site class “D” can be used to determine seismic design forces.

4.2 Soil Liquefaction

Liquefaction is a phenomenon where there is a reduction or complete loss of soil strength due to an increase in water pressure induced by vibrations. Liquefaction mainly affects geologically recent deposits of fine grained sands underlying the groundwater table. Soils of this nature derive their strength from intergranular friction. The generated water pressure or pore pressure essentially separates the soil grains and eliminates this intergranular friction; thus, eliminating the soil’s strength.

We completed a liquefaction analysis using the computer program LiquefyPro published by CivilTech Corporation. The analysis was completed using a site-modified peak ground acceleration (PGA_M) of 0.6g representing the peak horizontal acceleration for the maximum considered earthquake (MCE) having a 2 percent probability of exceedance in 50 years. The value was obtained for Latitude 47.21246369°N and Longitude -122.31922986°W using the Structural Engineers Association of California (SEAOC) U.S. Seismic Design Maps website (<https://seismicmaps.org/>) accessed on August 5, 2021.

The results of our analysis indicate that soil liquefaction could occur during the design earthquake event resulting in total settlements ranging between about 2.8 and 5.8 inches with about one-half of this settlement likely being differential in nature. In our opinion, this amount of settlement would not structurally impair the building. However, cosmetic damage to the structure in the form of misaligned doors and windows, cracking, and floor settlement could occur. Some utility connections may also be impacted. If the owner is not willing to accept the risk of building damage requiring repair should liquefaction-induced settlements occur, foundations should be supported on ground improved using stone columns designed to mitigate soil liquefaction settlements below the building foundations. The results of the liquefaction analysis are attached in Appendix B.

5.0 DISCUSSION AND RECOMMENDATIONS

5.1 General

In our opinion, there are no geotechnical considerations that would preclude development of the site as planned. The fine grained native soils observed at the site will consolidate under static dead loads imposed by the structures and by product loading on structure floor slabs. To mitigate the potential for post-construction settlement due to this consolidation, we recommend surcharging the building location. Surcharging will involve placing the structural fill required to achieve the finish floor elevation and then placing an additional 4 feet of fill above this elevation and allowing settlements to occur under this load before building construction is initiated. We expect that these settlements would occur in about four to six weeks following full application of the surcharge fill.

After completing the surcharge, building construction can begin. The buildings can be supported on conventional spread footings bearing on a minimum of 2 feet of compacted structural fill. Overexcavation of native soils and replacement with structural fill will likely be required where deeper footing depths are required, such as below the perimeter foundations adjacent to the loading dock areas or where perimeter footings are deepened for seismic resistance.

The fine-grained native soils at the site will be difficult to compact as structural fill when wet or dry of optimum. The ability to use soils from site excavations as structural fill will depend on the soil moisture content and the prevailing weather conditions at the time of construction. The contractor should be prepared to dry the native soils by aeration during the normally dry summer season to facilitate compaction as structural fill. Alternatively, stabilizing the moisture in the native soil with cement or lime can be considered. If grading activities will take place during the winter season, the contractor should be prepared to import clean granular material for use as structural fill and backfill.

The following sections provide detailed recommendations regarding the above issues and other geotechnical design considerations. These recommendations should be incorporated into the final design drawings and construction specifications.

5.2 Site Preparation and Grading

In general, it will not be necessary to strip the organic surface layer where structural fill thicknesses above existing grade are a minimum of four feet and three feet in building and pavement areas, respectively. Clearing of trees should include removal of the entire tree root ball. Where structural fill thicknesses are less than the recommended minimums, both the organic surface soil and vegetation should be stripped from below building and pavement areas. Where necessary, stripping depths to remove the grass vegetation and topsoil would be on the order of 2 to 14 inches. Stripped vegetation debris should be removed from the site. Organic soils will not be suitable for use as structural fill but may be used for limited depths in nonstructural areas or for landscaping purposes.

We recommend removing existing building foundations and slabs and abandoning underground septic systems and other buried utilities from the planned development area. Abandoned utility pipes that fall outside of new building areas can be left in place provided they are sealed to prevent intrusion of groundwater seepage and soil.

Prior to placing fill or constructing footings, all exposed bearing surfaces should be observed by a representative of Terra Associates, Inc. to verify that soil conditions are as expected and suitable for support of new fill or building elements. Our representative may request proofrolling the exposed subgrade for pavement and floor slab support with a loaded 10-yard dump truck. If unstable soils are observed and cannot be stabilized in place by compaction, the affected soils should be excavated and removed to firm bearing and grade restored with new structural fill. If the depth of excavation to remove unstable soils is excessive the use of stabilization fabrics such as Mirafi 500X in conjunction with clean granular fill can be considered. Based on our experience, stable subgrade can generally be achieved with a minimum of 18 inches of clean granular fill over the stabilization fabric.

All building footings should obtain support on a minimum of 2 feet of granular structural fill. The fill should extend laterally from the edge of footing a minimum distance of 1-foot.

Our study indicates the native soils contain a sufficient percentage of fines (silt and clay size particles) that will make them difficult to compact as structural fill if they are too wet or too dry. Accordingly, the ability to use these native soils from site excavations as structural fill will depend on their moisture content and the prevailing weather conditions when site grading activities take place. Native soils that are too wet to properly compact could be dried by aeration during dry weather conditions or mixed with an additive such as cement or lime to stabilize the soil and facilitate compaction. If an additive is used, additional Best Management Practices (BMPs) for its use will need to be incorporated into the Temporary Erosion and Sedimentation Control plan (TESC) for the project.

If grading activities are planned during the wet winter months, and the onsite soils become too wet to achieve adequate compaction, the owner or contractor should be prepared to treat soils with lime, cement, or import wet weather structural fill. For this purpose, we recommend importing a granular soil that meets the following grading requirements:

U.S. Sieve Size	Percent Passing
6 inches	100
No. 4	75 maximum
No. 200	5 maximum*

*Based on the ¾-inch fraction

Prior to use, Terra Associates, Inc. should examine and test all materials to be imported to the site for use as structural fill. If building subgrades constructed using native soils will be exposed during wet weather, it would be advisable to place 12 inches of this granular structural fill on the building pad to prevent deterioration of the floor subgrade.

Structural fill should be placed in uniform loose layers not exceeding 12 inches and compacted to a minimum of 95 percent of the soil's maximum dry density, as determined by American Society for Testing and Materials (ASTM) Test Designation D-1557 (Modified Proctor). The moisture content of the soil at the time of compaction should be within 2 percent of its optimum, as determined by this same ASTM standard. In nonstructural areas, the degree of compaction can be reduced to 90 percent.

5.3 Surcharge

We recommend surcharging the building areas to limit building and floor slab settlements to tolerable levels. For this procedure, we recommend placing structural fill in the building area to the design floor elevation and then placing an additional four feet of fill above this grade and delaying building construction until settlement under this fill load has occurred. The surcharge fill should extend a minimum of two feet beyond the building perimeter.

Total settlement under the surcharge fill is estimated in the range of four to five inches. These settlements are expected to occur in about four to six weeks following full application of the surcharge fill.

To verify the amount of settlement and the time rate of movement, the preload program should be monitored by installing settlement markers. The settlement markers should be installed on the existing grade prior to placing any building or preload fills. Once installed, elevations of both the fill height and marker should be taken daily until the full height of the preload is in place. Once fully preloaded, readings should continue weekly until the anticipated settlements have occurred. A typical settlement marker detail is provided as Figure 3.

It is critical that the grading contractor recognize the importance of the settlement marker installations. All efforts must be made to protect the markers from damage during fill placement. It is difficult, if not impossible, to evaluate the progress of the preload program if the markers are damaged or destroyed by construction equipment. As a result, it may be necessary to install new markers and extend the surcharging time period in order to ensure that settlements have ceased and building construction can begin.

Following the successful completion of the preload program, with foundations designed as recommended in Section 5.5 of this report, you should expect maximum total and differential post-construction static settlements of one-half inch for perimeter foundations and one inch for interior columns.

5.4 Excavations

All excavations at the site associated with confined spaces, such as lower building level retaining walls, must be completed in accordance with local, state, or federal requirements. Based on the Washington State Department of Labor and Industries current occupational safety and health regulations, the site soils would be classified as a Type C soil.

For properly dewatered excavations in Type C soils that are greater than 4 feet and less than 20 feet in depth, the side slopes should be laid back at an inclination of 1.5:1 (Horizontal:Vertical) or flatter. If there is insufficient room to complete the excavations in this manner, or if excavations greater than 20 feet in depth are planned, using temporary shoring to support the excavations may need to be considered.

Based on our study, groundwater seepage should be anticipated within excavations extending below depths of about five to seven feet. Excavations extending below these depths will likely encounter groundwater seepage with volumes and flow rates sufficient to require some level of dewatering. Shallow excavations that do not extend more than two feet below the groundwater table can likely be dewatered by conventional sump-pumping procedures along with a system of collection trenches. Deeper excavations will likely require dewatering by well points or isolated deep-pump wells. The utility subcontractor should be prepared to implement excavation dewatering by well point or deep-pump wells, as needed. This will be an especially critical consideration for any deep excavations such as stormwater detention vaults, lift stations, and sanitary sewer tie-ins.

This information is provided solely for the benefit of the owner and other design consultants and should not be construed to imply that Terra Associates, Inc. assumes responsibility for job site safety. It is understood that job site safety is the sole responsibility of the project contractor.

5.5 Foundations

Assuming the owner is willing to accept the risk of building damage due to soil liquefaction during a seismic event, in our opinion, following the successful completion of the surcharge program the building may be supported on conventional spread footing foundations bearing on a minimum of two feet of structural fill that is placed and compacted as recommended in the Site Grading and Preparation Section of this report. Foundations exposed to the weather should bear at a minimum depth of one and one-half feet below adjacent grades for frost protection. If the owner is not willing to accept this risk, building foundations should be supported on ground improved with stone columns specifically designed to mitigate the liquefaction settlements.

We recommend designing foundations for a net allowable bearing capacity of 2,500 pounds per square foot (psf). For short-term loads, such as wind and seismic, a one-third increase in this allowable capacity can be used. With the expected building loads and this bearing stress applied, in general, total, and differential settlements should not exceed one-half inch for perimeter foundations and 1 inch for interior column supports.

For designing foundations to resist lateral loads, a base friction coefficient of 0.35 can be used. Passive earth pressures acting on the sides of the footings can also be considered. We recommend calculating this lateral resistance using an equivalent fluid weight of 300 pounds per cubic foot (pcf). We do not recommend including the upper 12 inches of soil in this computation because it can be affected by weather or disturbed by future grading activity. This value assumes the foundation will be constructed neat against competent native soil or backfilled with structural fill, as described in Section 5.2 of this report. The values recommended include a safety factor of 1.5.

5.6 Lateral Earth Pressures for Retaining Walls

The magnitude of earth pressure development on below-grade walls, such as basement or retaining walls, will partly depend on the quality of the wall backfill. We recommend placing and compacting wall backfill as structural fill as described in Section 5.2 of this report. To guard against hydrostatic pressure development, drainage must be installed behind the wall. A typical wall drainage detail is shown on Figure 4.

With wall backfill placed and compacted, as recommended and drainage properly installed, unrestrained walls can be designed for an active earth pressure equivalent to a fluid weighing 35 pcf. For restrained walls, an additional uniform lateral pressure of 100 psf should be added to the 35 pcf. For evaluating the walls under seismic loading, a uniform earth pressure equivalent to $8H$ psf, where H is the height of the retained earth in feet, can be used. These values assume a horizontal backfill condition and that no other surcharge loading, such as traffic, sloping embankments, or adjacent buildings, will act on the wall. If such conditions exist, then the imposed loading must be included in the wall design.

Friction at the base of the wall foundation and passive earth pressure will provide resistance to these lateral loads. Values for these parameters are provided in Section 5.5.

5.7 Slab-on-Grade Floors

Slab-on-grade floors may be supported on subgrades prepared as recommended in Section 5.2 of this report. Immediately below the floor slabs, we recommend placing a four-inch thick capillary break layer of clean, free-draining, coarse sand or fine gravel that has less than 5 percent passing the No. 200 sieve. This material will reduce the potential for upward capillary movement of water through the underlying soil and subsequent wetting of the floor slabs.

The capillary break layer will not prevent moisture intrusion through the slab caused by water vapor transmission. Where moisture by vapor transmission is undesirable, such as covered floor areas, a common practice is to place a durable plastic membrane on the capillary break layer and then cover the membrane with a layer of clean sand or fine gravel to protect it from damage during construction, and aid in uniform curing of the concrete slab. It should be noted that if the sand or gravel layer overlying the membrane is saturated prior to pouring the slab, it will be ineffective in assisting in uniform curing of the slab and can actually serve as a water supply for moisture transmission through the slab and affecting floor coverings.

Therefore, in our opinion, covering the membrane with a layer of sand or gravel should be avoided if floor slab construction occurs during the wet winter months and the layer cannot be effectively drained. We recommend floor designers and contractors refer to the American Concrete Institute (ACI) Manual of Concrete Practice for further information regarding vapor barrier installation below slab-on-grade floors.

For design of the floor slabs on grade, a subgrade modulus (ks) of 100 pounds per cubic inch (pci) can be used.

5.8 Stormwater Detention Vault and Pond

Detention Vault

If onsite stormwater detention will be provided by a below-grade vault, vault foundations can be designed following the recommendations outlined in Section 5.5. We anticipate that the relatively shallow groundwater table would make drainage of vault walls impractical. For preliminary design purposes, we recommend using a groundwater level set 5 feet below ground surface. We recommend designing the vault walls above the groundwater table for an earth pressure imposed by an equivalent fluid weighing 50 pcf. Below the groundwater table the undrained walls should be designed for an earth pressure equivalent to a fluid weighing 85 pcf. For evaluating walls under seismic loading, an additional uniform earth pressure equivalent to $8H$ psf, where H is the height of the below-grade wall in feet, can be used. These values assume a horizontal backfill condition. Where applicable a uniform horizontal traffic surcharge value of 75 psf should be included in design of vault walls.

The vault structure will be subject to uplift pressures. The weight of the structure and the weight of the backfill soil above its foundation will provide resistance to uplift. A soil unit weight of 120 pcf can be used for the vault backfill provided the backfill is placed and compacted as structural fill, as recommended above.

Detention Pond

We expect that detention ponds would be formed by a combination of excavation below current site grades and placement of fill to construct perimeter containment berms. Based on subsurface conditions observed in January and March 2019, we expect that the wintertime water table would limit the functional depth of a stormwater detention pond at the site to about 5 feet below existing surface grade.

Because of exposure to fluctuating stored water levels, soils exposed above the dead storage elevation on the interior side slopes of the ponds may be subject to some risk of periodic shallow instability or sloughing. Establishing interior slopes at a 3:1 gradient will significantly reduce or eliminate this potential. Exterior berm slopes and interior slopes above the maximum water surface should be graded to a finished inclination no steeper than 2:1. Finished slope faces should be thoroughly compacted and vegetated to guard against erosion. Fill material used to establish the top of berm elevation should be placed and compacted structurally, as recommended in Section 5.2 of this report. Perimeter berms should have a minimum crest width of five feet.

5.9 Drainage

Surface

Final exterior grades should promote free and positive drainage away from the buildings at all times. Water must not be allowed to pond or collect adjacent to foundations or within the immediate building areas. We recommend providing a positive drainage away from the building perimeters.

Subsurface

We expect that building floor elevations will be elevated above existing surface grades, and that permanent hard surfaces will extend to the building over most of its perimeter. With these conditions, it is our opinion that building foundation drains would not be required; however, footing drains associated with retaining wall drainage are still required.

5.10 Utilities

Utility pipes should be bedded and backfilled in accordance with American Public Works Associates (APWA) or local jurisdictional specifications. As a minimum, trench backfill should be placed and compacted as structural fill as described in Section 5.2 of this report. At the time of our study, soil moisture contents were generally above optimum at likely utility depths; therefore, drying back or other means to condition the material will probably be necessary to facilitate proper compaction. If utility construction takes place during the winter, it may be necessary to import suitable wet weather fill for utility trench backfilling.

For any structure installed below a depth of about five feet, buoyancy effects must be considered. Buoyancy or uplift will be resisted by the weight of the structure and the weight of the soil overlying its foundation or cover. For backfill placed as structural fill, a soil unit weight of 120 pcf can be used.

Buoyancy, or an unbalanced hydrostatic head, will also impact the trench bottom stability. Where an unbalanced hydrostatic head exists in the trench excavation, the trench bottom can heave and, subsequently, become unstable causing installed utility pipes to settle when overburdened stresses from utility trench backfill are replaced. Two methods for stabilizing the trench bottoms can be considered. The first involves using well point dewatering systems to lower the groundwater table adjacent to utility excavation and prevent development of an unbalanced hydrostatic head. Single-stage well point dewatering systems are typically effective for utility excavations occurring to depths of 15 to 20 feet. The second method that can be used to mitigate heave or unstable soil conditions at the trench bottom involves overexcavation of the affected soils and replacement with additional free-draining bedding material. As a general rule, the depth of overexcavation below the pipe invert and replacement with free-draining bedding material would be equivalent to one foot for every two feet of unbalanced hydrostatic head.

5.11 Pavements

Pavements should be constructed on subgrades prepared as recommended in Section 5.2 of this report. Regardless of the degree of relative compaction achieved, the subgrade must be firm and relatively unyielding before paving. Proofrolling the subgrade with heavy construction equipment should be completed to verify this condition.

The pavement design section is dependent upon the supporting capability of the subgrade soils and the traffic conditions to which it will be subjected. We expect traffic at the facility will consist of cars and light trucks, along with heavy traffic in the form of tractor-trailer-rigs. For design considerations, we have assumed traffic in parking and in car/light truck access pavement areas can be represented by an 18-kip Equivalent Single Axle Loading (ESAL) of 50,000 over a 20-year design life. For heavy traffic pavement areas, we have assumed an ESAL of 300,000 would be representative of the expected loading. These ESALs represent loading approximately equivalent to 3 and 18, loaded (80,000-pound GVW) tractor-trailer rigs traversing the pavement daily in each area, respectively.

With a stable subgrade prepared as recommended for the design ESAL values, we recommend the following pavement sections:

Light Traffic/Car Access:

- 2 inches of hot mix asphalt (HMA) over 6 inches of crushed rock base (CRB)
- 4 inches full depth HMA

Heavy Traffic/Truck Access:

- 3 inches of HMA over 8 inches of CRB
- 6 inches full depth HMA

For exterior Portland cement concrete (PCC) pavement, we recommend the following:

- 6 inches of PCC over 2 inches of CRB
 - 28-day compressive strength – 4,000 psi
 - Control joints spaced at a maximum of 15 feet

Soil cement stabilization or constructing a soil cement base for support of the pavement section can also be considered as an alternate to the above conventional pavement sections. Assuming a properly constructed soil cement base having a minimum thickness of 12 inches and a minimum 7-day compressive strength of 100 pounds per square inch (psi), the following pavement sections are recommended:

Light Traffic/Car Access:

- 2 inches of HMA over 12 inches of soil cement base (SCB)

Heavy Traffic/Truck Access:

- 3 inches of HMA over 12 inches of SCB
- 6 inches of PCC over 12 inches of SCB

The design of the soil cement base should be completed using samples of the subgrade exposed at the time of construction.

The paving materials used should conform to the Washington State Department of Transportation (WSDOT) specifications for half-inch class HMA and CRB.

Long-term pavement performance will depend on surface drainage. A poorly-drained pavement section will be subject to premature failure as a result of surface water infiltrating into the subgrade soils and reducing their supporting capability. For optimum pavement performance, we recommend surface drainage gradients of at least two percent. Some degree of longitudinal and transverse cracking of the pavement surface should be expected over time. Regular maintenance should be planned to seal cracks when they occur.

6.0 ADDITIONAL SERVICES

Terra Associates, Inc. should review the final design and specifications in order to verify that earthwork recommendations have been properly interpreted and incorporated into project design and construction. We should also provide geotechnical services during construction in order to observe compliance with the design concepts, specifications, and recommendations. This will allow for design changes if subsurface conditions differ from those anticipated prior to the start of construction.

7.0 LIMITATIONS

We prepared this report in accordance with generally accepted geotechnical engineering practices. This report is the property of Terra Associates, Inc. and is intended for specific application to the Freeman Logistics project. This report is for the exclusive use of Vector Development Company and its authorized representatives.

The analyses and recommendations presented in this report are based upon data obtained from the test pits excavated onsite. Variations in soil conditions can occur, the nature and extent of which may not become evident until construction. If variations appear evident, Terra Associates, Inc. should be requested to reevaluate the recommendations in this report prior to proceeding with construction.



REFERENCE: WSDOT GEOPORTAL

NOT TO SCALE

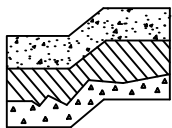

Terra Associates, Inc.

Consultants in Geotechnical Engineering
Geology and
Environmental Earth Sciences

VICINITY MAP
FREEMAN LOGISTICS
PIERCE COUNTY, WASHINGTON

Proj. No. T-8565

Date JULY 2022

Figure 1

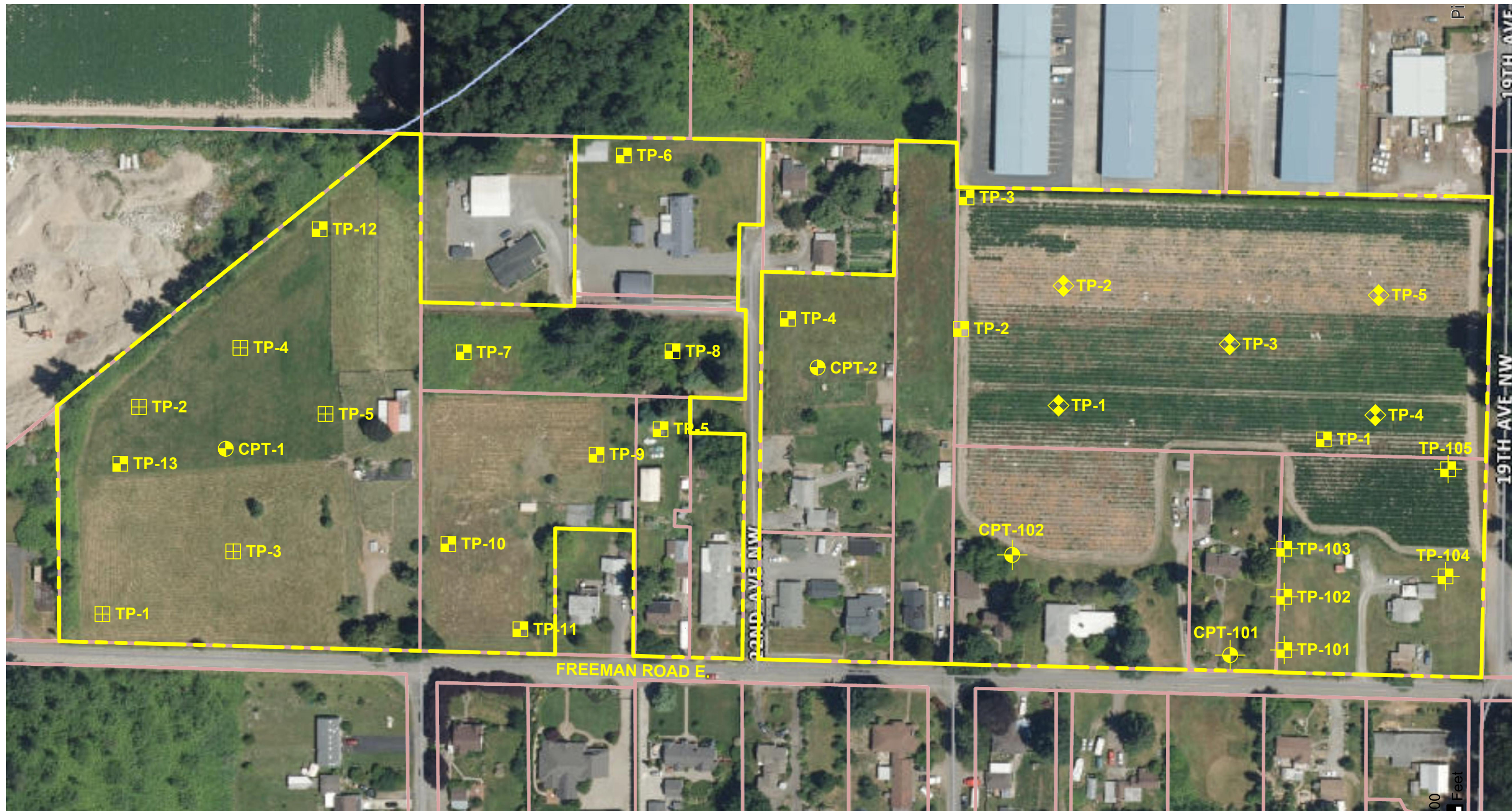

NOTE:
THIS SITE PLAN IS SCHEMATIC. ALL LOCATIONS AND DIMENSIONS ARE APPROXIMATE. IT IS INTENDED FOR REFERENCE ONLY AND SHOULD NOT BE USED FOR DESIGN OR CONSTRUCTION PURPOSES.

REFERENCE:
PIERCE COUNTY PUBLIC GIS

- LEGEND:**
- APPROXIMATE TEST PIT LOCATION (JUN 2021)
 - ▣ APPROXIMATE TEST PIT LOCATION (MAR 2019)
 - ▤ APPROXIMATE TEST PIT LOCATION (JUN 2022)
 - ◆ APPROXIMATE TEST PIT LOCATION (JAN 2019)
 - ⊕ APPROXIMATE CPT LOCATION (JUN 2021)
 - ⊗ APPROXIMATE CPT LOCATION (JUN 2022)

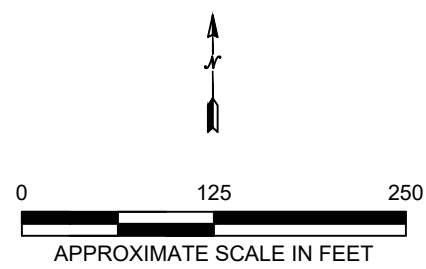

Terra Associates, Inc.
Consultants in Geotechnical Engineering
Geology and
Environmental Earth Sciences

**EXPLORATION LOCATION PLAN
FREEMAN LOGISTICS
PIERCE COUNTY, WASHINGTON**

Proj. No.T-8565	Date JULY 2022	Figure 2
-----------------	----------------	----------

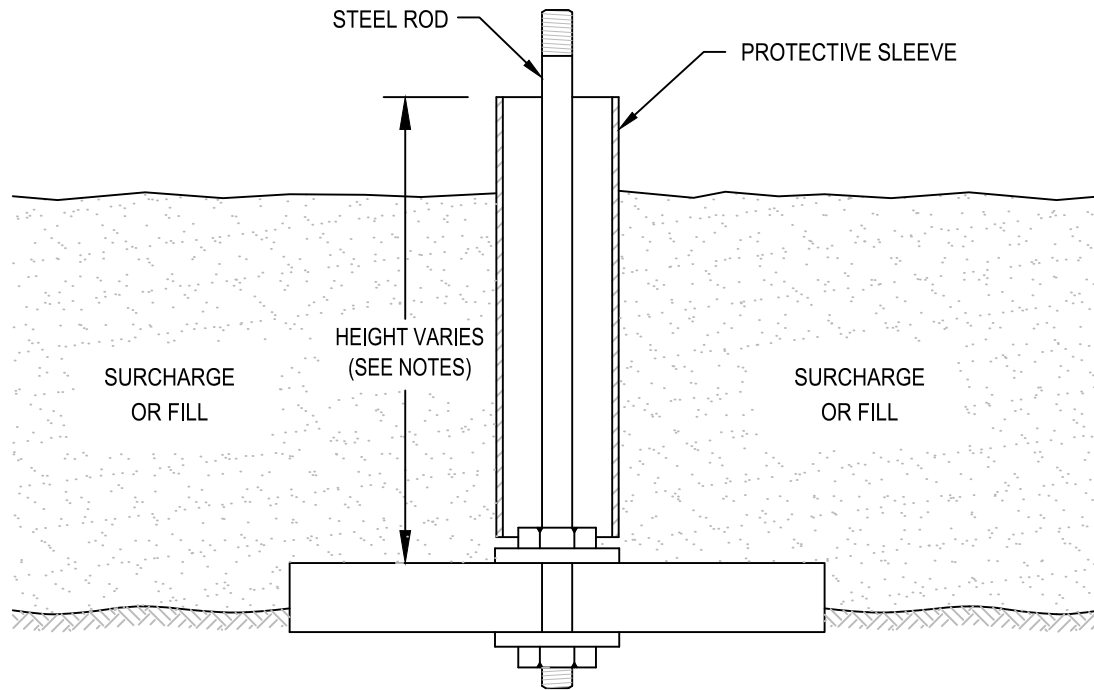

NOT TO SCALE

NOTES:

1. BASE CONSISTS OF 3/4" THICK, 2'x2' PLYWOOD WITH CENTER DRILLED 5/8" DIAMETER HOLE.
2. BEDDING MATERIAL, IF REQUIRED, SHOULD CONSIST OF CLEAN COARSE SAND.
3. MARKER ROD IS 1/2" DIAMETER STEEL ROD THREADED AT BOTH ENDS.
4. MARKER ROD IS ATTACHED TO BASE BY NUT AND WASHER ON EACH SIDE OF BASE.
5. PROTECTIVE SLEEVE SURROUNDING MARKER ROD SHOULD CONSIST OF 2" DIAMETER PLASTIC TUBING. SLEEVE IS NOT ATTACHED TO ROD OR BASE.
6. ADDITIONAL SECTIONS OF STEEL ROD CAN BE CONNECTED WITH THREADED COUPLINGS.
7. ADDITIONAL SECTIONS OF PLASTIC PROTECTIVE SLEEVE CAN BE CONNECTED WITH PRESS-FIT PLASTIC COUPLINGS.
8. STEEL MARKER ROD SHOULD EXTEND AT LEAST 6" ABOVE TOP OF PLASTIC PROTECTIVE SLEEVE.
9. PLASTIC PROTECTIVE SLEEVE SHOULD EXTEND AT LEAST 1" ABOVE TOP OF FILL SURFACE.

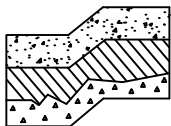

Terra Associates, Inc.

Consultants in Geotechnical Engineering
Geology and
Environmental Earth Sciences

TYPICAL SETTLEMENT MARKER DETAIL
FREEMAN LOGISTICS
PIERCE COUNTY, WASHINGTON

Proj. No.T-8565

Date JULY 2022

Figure 3

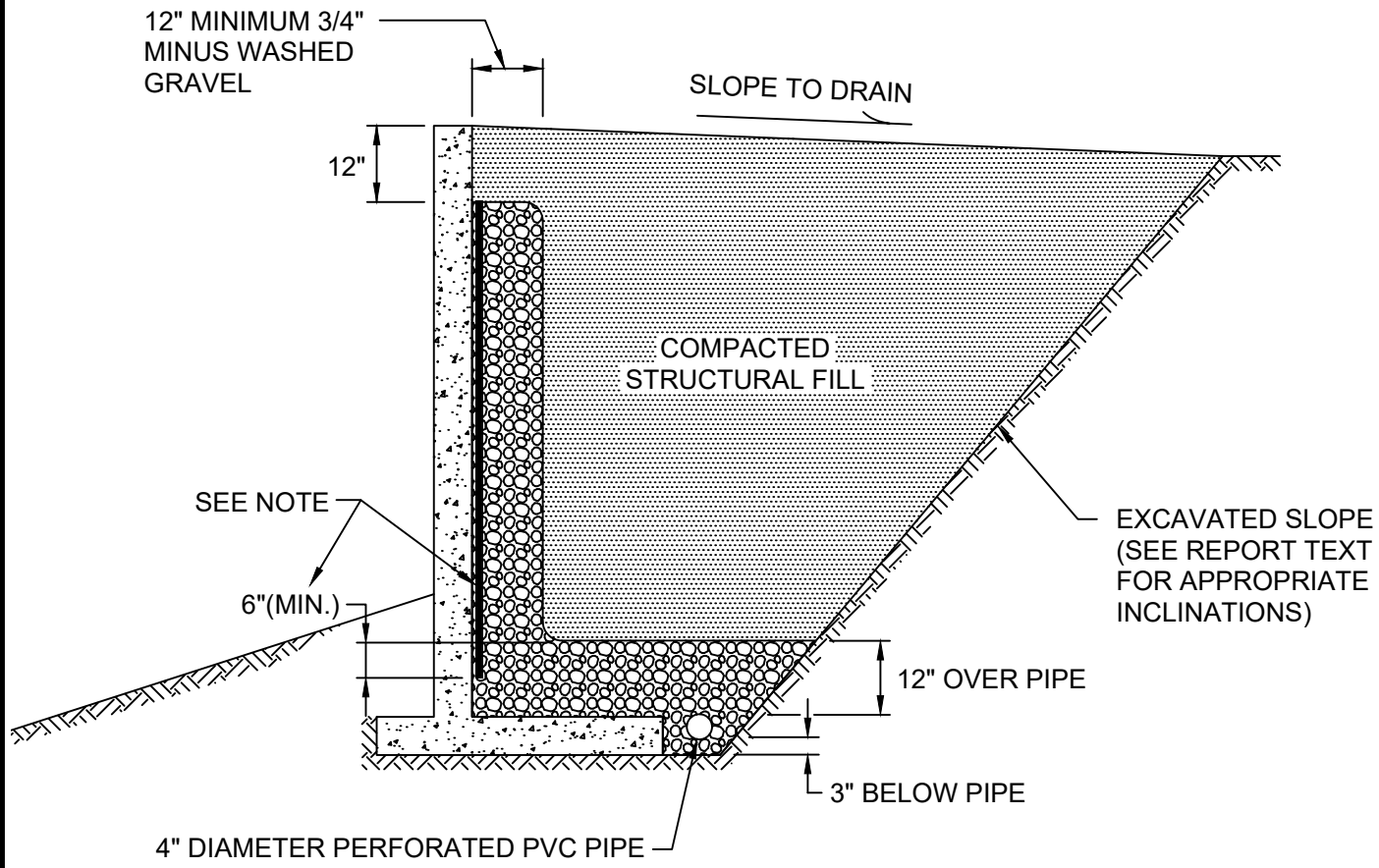

NOT TO SCALE

NOTE:

MIRADRAIN G100N PREFABRICATED DRAINAGE PANELS OR SIMILAR PRODUCT CAN BE SUBSTITUTED FOR THE 12-INCH WIDE GRAVEL DRAIN BEHIND WALL. DRAINAGE PANELS SHOULD EXTEND A MINIMUM OF SIX INCHES INTO 12-INCH THICK DRAINAGE GRAVEL LAYER OVER PERFORATED DRAIN PIPE.

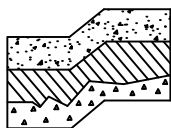

Terra Associates, Inc.
 Consultants in Geotechnical Engineering
 Geology and
 Environmental Earth Sciences

TYPICAL WALL DRAINAGE DETAIL
 FREEMAN LOGISTICS
 PIERCE COUNTY, WASHINGTON

Proj. No.T-8565

Date JULY 2022

Figure 4

APPENDIX A
FIELD EXPLORATION AND LABORATORY TESTING

Freeman Logistics
Pierce County, Washington

On June 25, 2021, we explored subsurface conditions at the site by excavating 23 test pits dug to maximum depths of about 8.5 to 10 feet using a track-mounted excavator and conducting 3 cone penetration tests (CPTs) to depths ranging from about 55 to 60 feet. On June 22, 2022, we supplemented this data by excavating an additional 5 test pits to maximum depths of approximately 12 to 13 feet and on June 9, 2022, we conducted 2 additional CPTs. The test pit and CPT locations were approximately determined in the field by pacing and sighting from existing site features. The approximate test pit and CPT locations are shown on Figure 2. The logs of our test pits are attached as Figures A-2 through A-19. Test Pit Logs from our previous site studies are also attached.



An engineering geologist and geotechnical engineer from our office conducted the field explorations, classified the soils observed in the test pits, maintained a written log of each test pit, collected representative soil samples, and performed a visual site reconnaissance. All soil samples were visually classified in accordance with the Unified Soil Classification System (USCS) described on Figure A-1.

Representative soil samples obtained from the test pits were placed in closed containers and taken to our laboratory for further examination and testing. The moisture content of each soil sample was measured and is reported on the Test Pit Log. Grain size analyses were performed on eight soil samples. The results of the grain size analyses are shown on Figures A-20 through A-22. The results of grain size analyses of soil samples collected during our previous site studies are included with the attached Test Pit Logs.

In Situ Engineering, under subcontract to Terra Associates, Inc., performed the CPTs at locations selected by Terra Associates, Inc. The CPT consists of pushing an instrumented, approximately 1 1/2-inch diameter cone into the ground at a constant rate. During advancement, continuous measurements are made of the resistance to penetration of the cone and the friction of the outer surface of a sleeve. The cone is also equipped with a porous filter and a pressure transducer for measuring the generated groundwater or pore water pressure. Measurements of tip and sleeve frictional resistance, pore pressure, and interpreted soil conditions are summarized in graphical form on the attached CPT Logs.

MAJOR DIVISIONS			LETTER SYMBOL	TYPICAL DESCRIPTION
COARSE GRAINED SOILS More than 50% material larger than No. 200 sieve size	GRAVELS More than 50% of coarse fraction is larger than No. 4 sieve	Clean Gravels (less than 5% fines)	GW	Well-graded gravels, gravel-sand mixtures, little or no fines.
			GP	Poorly-graded gravels, gravel-sand mixtures, little or no fines.
		Gravels with fines	GM	Silty gravels, gravel-sand-silt mixtures, non-plastic fines.
			GC	Clayey gravels, gravel-sand-clay mixtures, plastic fines.
	SANDS More than 50% of coarse fraction is smaller than No. 4 sieve	Clean Sands (less than 5% fines)	SW	Well-graded sands, sands with gravel, little or no fines.
			SP	Poorly-graded sands, sands with gravel, little or no fines.
		Sands with fines	SM	Silty sands, sand-silt mixtures, non-plastic fines.
			SC	Clayey sands, sand-clay mixtures, plastic fines.
FINE GRAINED SOILS More than 50% material smaller than No. 200 sieve size	SILTS AND CLAYS Liquid Limit is less than 50%		ML	Inorganic silts, rock flour, clayey silts with slight plasticity.
			CL	Inorganic clays of low to medium plasticity. (Lean clay)
			OL	Organic silts and organic clays of low plasticity.
	SILTS AND CLAYS Liquid Limit is greater than 50%		MH	Inorganic silts, elastic.
			CH	Inorganic clays of high plasticity. (Fat clay)
			OH	Organic clays of high plasticity.
HIGHLY ORGANIC SOILS			PT	Peat.

DEFINITION OF TERMS AND SYMBOLS

COHESIONLESS	<u>Density</u>	<u>Standard Penetration Resistance in Blows/Foot</u>	 2" OUTSIDE DIAMETER SPILT SPOON SAMPLER
	Very Loose Loose Medium Dense Dense Very Dense	0-4 4-10 10-30 30-50 >50	 2.4" INSIDE DIAMETER RING SAMPLER OR SHELBY TUBE SAMPLER
COHESIVE	<u>Consistency</u>	<u>Standard Penetration Resistance in Blows/Foot</u>	 WATER LEVEL (Date)
	Very Soft Soft Medium Stiff Stiff Very Stiff Hard	0-2 2-4 4-8 8-16 16-32 >32	Tr TORVANE READINGS, tsf Pp PENETROMETER READING, tsf DD DRY DENSITY, pounds per cubic foot LL LIQUID LIMIT, percent PI PLASTIC INDEX N STANDARD PENETRATION, blows per foot

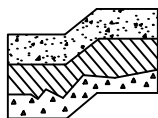

Terra Associates, Inc.
Consultants in Geotechnical Engineering
Geology and
Environmental Earth Sciences

UNIFIED SOIL CLASSIFICATION SYSTEM
FREEMAN LOGISTICS
PIERCE COUNTY, WASHINGTON

Proj. No.T-8565

Date JULY 2022

Figure A-1

LOG OF TEST PIT NO. 1

FIGURE A-2

PROJECT NAME: Freeman Logistics PROJ. NO: T-8565 LOGGED BY: JCS

LOCATION: Pierce County, Washington SURFACE CONDITIONS: Bare APPROX. ELEV: NA

DATE LOGGED: June 25, 2021 DEPTH TO GROUNDWATER: NA DEPTH TO CAVING: NA

Depth (ft)	Sample No.	Description	Consistency/ Relative Density	W (%)
0		Brown silty SAND to sandy SILT, fine grained, moist. (SM/ML)		
1	1			18.4
2				
3		Gray-brown to gray SILT, moist, numerous iron-oxide stained root casts. (ML)		
4	2		Medium Dense	31.0
5				
6				
7				
8	3	Dark gray-brown silty SAND to SAND with silt, fine grained, moist. (SM/SP-SM)		20.4
9		Test pit terminated at 8.5 feet. No groundwater seepage.		
10				

NOTE: This subsurface information pertains only to this test pit location and should not be interpreted as being indicative of other locations at the site.

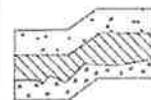

Terra Associates, Inc.
 Consultants in Geotechnical Engineering
 Geology and
 Environmental Earth Sciences

LOG OF TEST PIT NO. 2

FIGURE A-3

PROJECT NAME: Freeman Logistics **PROJ. NO:** T-8565 **LOGGED BY:** JCS

LOCATION: Pierce County, Washington **SURFACE CONDITIONS:** Bare **APPROX. ELEV:** NA

DATE LOGGED: June 25, 2021 **DEPTH TO GROUNDWATER:** NA **DEPTH TO CAVING:** NA

Depth (ft)	Sample No.	Description	Consistency/ Relative Density	W (%)
0		Brown silty SAND to sandy SILT, fine grained, moist. (SM/ML)	Medium Dense	
1				
2		Gray-brown to gray SILT, moist, numerous iron-oxide stained root casts. (ML)		
3				
4				
5				
6				
7		Interbedded gray-brown to brown SILT and dark gray-brown fine SAND, moist to wet. (ML and SP)		
8				
9	1	Test pit terminated at 9 feet. No groundwater seepage.		35.4
10				

NOTE: This subsurface information pertains only to this test pit location and should not be interpreted as being indicative of other locations at the site.

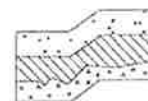

Terra Associates, Inc.
 Consultants in Geotechnical Engineering
 Geology and
 Environmental Earth Sciences

LOG OF TEST PIT NO. 3

FIGURE A-4

PROJECT NAME: Freeman Logistics **PROJ. NO:** T-8565 **LOGGED BY:** JCS

LOCATION: Pierce County, Washington **SURFACE CONDITIONS:** Bare **APPROX. ELEV:** NA

DATE LOGGED: June 25, 2021 **DEPTH TO GROUNDWATER:** 8.5 ft **DEPTH TO CAVING:** NA

Depth (ft)	Sample No.	Description	Consistency/ Relative Density	W (%)
0		FILL: Brown SILT, dry to moist, dark brown organic layer at 2.5 feet. (ML)		
1				
2				
3		Gray-brown SILT, moist, numerous iron-oxide stained root casts. (ML)		
4	1	Orange-brown silty SAND to sandy SILT, fine sand, moist. (SM/ML)	Medium Dense	34.9
5	2	Dark gray-brown SAND, fine to medium grained, moist (wet below 8.5 feet. (SP)		5.7
6				
7				
8				
9		Test pit terminated at 9 feet. Light groundwater seepage below 8.5 feet.		
10				

NOTE: This subsurface information pertains only to this test pit location and should not be interpreted as being indicative of other locations at the site.

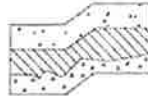

Terra Associates, Inc.
Consultants in Geotechnical Engineering
 Geology and
 Environmental Earth Sciences

LOG OF TEST PIT NO. 4

FIGURE A-5

PROJECT NAME: Freeman Logistics **PROJ. NO:** T-8565 **LOGGED BY:** JCS

LOCATION: Pierce County, Washington **SURFACE CONDITIONS:** Grasses **APPROX. ELEV:** NA

DATE LOGGED: June 25, 2021 **DEPTH TO GROUNDWATER:** 7.5 ft **DEPTH TO CAVING:** NA

Depth (ft)	Sample No.	Description	Consistency/ Relative Density	W (%)
0		3 inches Sod and Topsoil.		
1		Brown SILT, dry to moist. (ML)		
2		Dark gray-brown SAND, fine grained, moist. (SP)		6.8
3	1			
4		Gray-brown SILT, moist, mottled. (ML)		37.5
5	2		Medium Dense	
6		Interbedded dark gray SILT and dark gray-brown fine SAND, moist to wet. (ML and SP)		
7				
8				
9		Test pit terminated at 9 feet. Light groundwater seepage below 7.5 feet.		
10				

NOTE: This subsurface information pertains only to this test pit location and should not be interpreted as being indicative of other locations at the site.

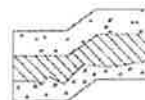

Terra Associates, Inc.
 Consultants in Geotechnical Engineering
 Geology and
 Environmental Earth Sciences

LOG OF TEST PIT NO. 5

FIGURE A-6

PROJECT NAME: Freeman Logistics **PROJ. NO:** T-8565 **LOGGED BY:** JCS

LOCATION: Pierce County, Washington **SURFACE CONDITIONS:** Bare **APPROX. ELEV:** NA

DATE LOGGED: June 25, 2021 **DEPTH TO GROUNDWATER:** NA **DEPTH TO CAVING:** NA

Depth (ft)	Sample No.	Description	Consistency/ Relative Density	W (%)
0		Brown to gray-brown SILT, moist, mottled below 3.5 feet. (ML)	Medium Dense	28
1				
2				
3				
4				
5	1	Dark gray-brown silty SAND, fine grained, moist. (SM)	Loose to Medium Dense	36.9
6				
7				
8	2	Gray SILT, wet. (ML)		
9		Test pit terminated at 9 feet. No groundwater seepage.		
10				

NOTE: This subsurface information pertains only to this test pit location and should not be interpreted as being indicative of other locations at the site.

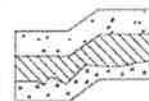

Terra Associates, Inc.
 Consultants in Geotechnical Engineering
 Geology and Environmental Earth Sciences

LOG OF TEST PIT NO. 6

FIGURE A-7

PROJECT NAME: Freeman Logistics **PROJ. NO:** T-8565 **LOGGED BY:** JCS

LOCATION: Pierce County, Washington **SURFACE CONDITIONS:** Grass Lawn **APPROX. ELEV:** NA

DATE LOGGED: June 25, 2021 **DEPTH TO GROUNDWATER:** NA **DEPTH TO CAVING:** NA

Depth (ft)	Sample No.	Description	Consistency/ Relative Density	W (%)
0		2 inches Sod and Topsoil.		
1		Brown to gray-brown SILT, moist, scattered mottling. (ML)		
2				
3		Dark gray-brown SAND, fine grained, moist. (SP)		
4			Medium Dense	
5		Gray-brown silty SAND to sandy SILT, fine sand, moist to wet. (SM/ML)		
6				
7		Gray SILT to sandy SILT, fine sand, moist to wet. (ML)		
8				
9				
10		Test pit terminated at 9.5 feet. No groundwater seepage.		

NOTE: This subsurface information pertains only to this test pit location and should not be interpreted as being indicative of other locations at the site.

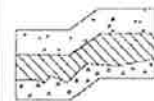

Terra Associates, Inc.
 Consultants in Geotechnical Engineering
 Geology and Environmental Earth Sciences

LOG OF TEST PIT NO. 7

FIGURE A-8

PROJECT NAME: Freeman Logistics PROJ. NO: T-8565 LOGGED BY: JCS

LOCATION: Pierce County, Washington SURFACE CONDITIONS: Grasses/Brush APPROX. ELEV: NA

DATE LOGGED: June 25, 2021 DEPTH TO GROUNDWATER: 8 ft DEPTH TO CAVING: NA

Depth (ft)	Sample No.	Description	Consistency/ Relative Density	W (%)
0		4 inches Sod and Topsoil.		
1		Brown to gray-brown SILT, moist. (ML)		
2				
3				
4	1	Gray-brown SAND with silt to silty SAND, fine grained, moist. (SP-SM/SM)	Medium Dense	32.9
5		Gray-brown to gray SILT, moist, scattered iron-oxide stained pockets. (ML)		
6				
7				
8		Dark gray-brown SAND, fine grained, wet. (SP)		
9		Test pit terminated at 9 feet. Light groundwater seepage below 8 feet.		
10				

NOTE: This subsurface information pertains only to this test pit location and should not be interpreted as being indicative of other locations at the site.

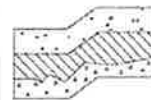

Terra Associates, Inc.
 Consultants in Geotechnical Engineering
 Geology and
 Environmental Earth Sciences

LOG OF TEST PIT NO. 8

FIGURE A-9

PROJECT NAME: Freeman Logistics **PROJ. NO:** T-8565 **LOGGED BY:** JCS

LOCATION: Pierce County, Washington **SURFACE CONDITIONS:** Brush **APPROX. ELEV:** NA

DATE LOGGED: June 25, 2021 **DEPTH TO GROUNDWATER:** NA **DEPTH TO CAVING:** NA

Depth (ft)	Sample No.	Description	Consistency/ Relative Density	W (%)
0		6 inches Sod and Topsoil.		
1	1	Brown to gray-brown SILT, moist, scattered mottling, scattered dark gray fine sand layers. (ML)	Medium Dense	19.1
2				
3				
4				
5				
6				
7		Gray SILT, wet. (ML)	Loose	
8				
9	2	Test pit terminated at 9 feet. No groundwater seepage.		35.8
10				

NOTE: This subsurface information pertains only to this test pit location and should not be interpreted as being indicative of other locations at the site.

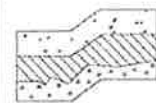

Terra Associates, Inc.
 Consultants in Geotechnical Engineering
 Geology and
 Environmental Earth Sciences

LOG OF TEST PIT NO. 9

FIGURE A-10

PROJECT NAME: Freeman Logistics **PROJ. NO:** T-8565 **LOGGED BY:** JCS

LOCATION: Pierce County, Washington **SURFACE CONDITIONS:** Grasses **APPROX. ELEV:** NA

DATE LOGGED: June 25, 2021 **DEPTH TO GROUNDWATER:** 7 ft **DEPTH TO CAVING:** NA

Depth (ft)	Sample No.	Description	Consistency/ Relative Density	W (%)
0		4 inches Sod and Topsoil.		
1		Brown to gray-brown SILT, dry to moist, scattered mottling. (ML)		
2				
3				
4				
5	1	Gray-brown SILT, moist, significant iron-oxide staining. (ML)	Medium Dense	41.7
6				
7				
8	2	Dark gray SAND, fine grained, moist. (SP)		27.9
9				
10		Test pit terminated at 9 feet. Light groundwater seepage below 7 feet.		

NOTE: This subsurface information pertains only to this test pit location and should not be interpreted as being indicative of other locations at the site.

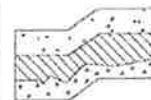

Terra Associates, Inc.
 Consultants in Geotechnical Engineering
 Geology and
 Environmental Earth Sciences

LOG OF TEST PIT NO. 10

FIGURE A-11

PROJECT NAME: Freeman Logistics **PROJ. NO:** T-8565 **LOGGED BY:** JCS

LOCATION: Pierce County, Washington **SURFACE CONDITIONS:** Grasses **APPROX. ELEV:** NA

DATE LOGGED: June 25, 2021 **DEPTH TO GROUNDWATER:** NA **DEPTH TO CAVING:** NA

Depth (ft)	Sample No.	Description	Consistency/ Relative Density	W (%)
0		4 inches Sod and Topsoil.		
1		Brown to gray-brown SILT, dry to moist, scattered mottling. (ML)		
2				
3			Medium Dense	
4				
5		Gray-brown SILT, moist, significant iron-oxide staining. (ML)		
6				
7		Gray-brown to gray SILT, wet, scattered dark gray-brown fine sand layers. (ML)		
8			Loose to Medium Dense	
9		Test pit terminated at 9 feet. No groundwater seepage.		
10				

NOTE: This subsurface information pertains only to this test pit location and should not be interpreted as being indicative of other locations at the site.

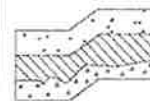

Terra Associates, Inc.
 Consultants in Geotechnical Engineering
 Geology and Environmental Earth Sciences

LOG OF TEST PIT NO. 11

FIGURE A-12

PROJECT NAME: Freeman Logistics PROJ. NO: T-8565 LOGGED BY: JCS

LOCATION: Pierce County, Washington SURFACE CONDITIONS: Grasses APPROX. ELEV: NA

DATE LOGGED: June 25, 2021 DEPTH TO GROUNDWATER: NA DEPTH TO CAVING: NA

Depth (ft)	Sample No.	Description	Consistency/ Relative Density	W (%)
0		Brown to gray-brown SILT, dry to moist, mottled below 1.5 feet. (ML)	Medium Dense	
1				
2				
3				
4		Interbedded gray-brown SILT and dark gray-brown fine SAND, moist. (ML and SP)		
5				
6		Dark gray SAND, fine grained, moist to wet, scattered dark gray silty fine sand layers. (SP)		
7				
8				
9		Test pit terminated at 9 feet. No groundwater seepage.		
10				

NOTE: This subsurface information pertains only to this test pit location and should not be interpreted as being indicative of other locations at the site.



Terra Associates, Inc.
Consultants in Geotechnical Engineering
 Geology and
 Environmental Earth Sciences

LOG OF TEST PIT NO. 12

FIGURE A-13

PROJECT NAME: Freeman Logistics **PROJ. NO:** T-8565 **LOGGED BY:** JCS

LOCATION: Pierce County, Washington **SURFACE CONDITIONS:** Grasses **APPROX. ELEV:** NA

DATE LOGGED: June 25, 2021 **DEPTH TO GROUNDWATER:** NA **DEPTH TO CAVING:** NA

Depth (ft)	Sample No.	Description	Consistency/ Relative Density	W (%)
0		3 inches Sod and Topsoil.		
1		Brown to gray-brown SILT, dry to moist, mottled below 2 feet. (ML)		
2				
3		Interbedded gray SILT and dark gray-brown fine SAND, moist to wet. (ML and SP)		
4			Medium Dense	30.2
5				
6	1	Dark gray SAND, fine grained, moist to wet, scattered dark gray silty fine sand layers. (SP)		
7				
8				
9		Test pit terminated at 9 feet. No groundwater seepage.		
10				

NOTE: This subsurface information pertains only to this test pit location and should not be interpreted as being indicative of other locations at the site.

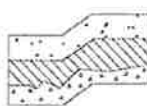

Terra
Associates, Inc.
Consultants in Geotechnical Engineering
Geology and
Environmental Earth Sciences

LOG OF TEST PIT NO. 13

FIGURE A-14

PROJECT NAME: Freeman Logistics **PROJ. NO:** T-8565 **LOGGED BY:** JCS

LOCATION: Pierce County, Washington **SURFACE CONDITIONS:** Grasses **APPROX. ELEV:** NA

DATE LOGGED: June 25, 2021 **DEPTH TO GROUNDWATER:** 8 ft **DEPTH TO CAVING:** NA

Depth (ft)	Sample No.	Description	Consistency/ Relative Density	W (%)
0		3 inches Sod and Topsoil.		
1		Brown to gray-brown SILT, dry to moist, mottled below 2 feet. (ML)		
2				
3		Interbedded gray SILT and dark gray-brown fine SAND, moist to wet. (ML and SP)		
4			Medium Dense	
5		Dark gray SAND, fine grained, moist to wet, scattered dark gray silty fine sand layers. (SP)		
6				
7				
8				
9		Test pit terminated at 9 feet. Light to moderate groundwater seepage below 8 feet		
10				

NOTE: This subsurface information pertains only to this test pit location and should not be interpreted as being indicative of other locations at the site.

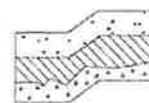

Terra Associates, Inc.
 Consultants in Geotechnical Engineering
 Geology and
 Environmental Earth Sciences

LOG OF TEST PIT NO. TP-101

FIGURE A-15

PROJECT NAME: Freeman Logistics PROJ. NO: T-8565 LOGGED BY: SLK

LOCATION: Pierce County, Washington SURFACE CONDITIONS: Long Grass APPROX. ELEV: N/A

DATE LOGGED: June 22, 2022 DEPTH TO GROUNDWATER: N/A DEPTH TO CAVING: 7 to 12 feet

Depth (ft)	Sample No.	Description	Consistency/ Relative Density	W (%)
0		Black SILT with sand, fine sand, moist, moderate organic inclusions. (ML) (Topsoil)	Loose	
1		Brown silty SAND, fine to medim sand, moist. (SM)		7.4
2				
3		Grayish-brown silty SAND/sandy SILT, wet, slightly mottled. (SM/ML)	Medium Dense	31.6
4				
5				
6				
7		Brown sandy SILT/silty SAND, wet, fine sand, very minor peat inclusions. (SP)		39.0
8				
9			Loose/Medium Dense	
10				
11				
12		Test pit terminated at 12 feet. No groundwater seepage observed. Moderate caving observed from 7 to 12 feet.		30.7
13				
14				

NOTE: This subsurface information pertains only to this test pit location and should not be interpreted as being indicative of other locations at the site.

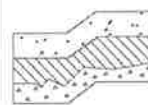

Terra Associates, Inc.
 Consultants in Geotechnical Engineering
 Geology and Environmental Earth Sciences

LOG OF TEST PIT NO. TP-102

FIGURE A-16

PROJECT NAME: Freeman Logistics PROJ. NO: T-8565 LOGGED BY: SLK

LOCATION: Pierce County, Washington SURFACE CONDITIONS: Long Grass APPROX. ELEV: N/A

DATE LOGGED: June 22, 2022 DEPTH TO GROUNDWATER: N/A DEPTH TO CAVING: 7 to 12 feet

Depth (ft)	Sample No.	Description	Consistency/ Relative Density	W (%)
0		(10 inches Topsoil)	Loose	
1		Brown silty SAND, fine to medium sand, moist, scattered organics. (SM)	Medium Dense	20.0
2				
3		Bedded layers of grayish-brown and red/orange silty SAND and sandy SILT, fine sand, moist, heavily mottled. (SM/ML)	Loose/Medium Dense	34.8
4				
5				
6			Loose/Medium Dense	30.3
7		Brown sandy SILT/silty SAND, fine sand, moist, some mottling. (ML/SM)		
8			Medium Dense/Dense	29.8
9				
10				
11			Medium Dense/Dense	31.9
12		Gray silty SAND/sandy SILT, fine sand, moist, weakly cemented. (SM/ML)		
13		Test pit terminated at 13 feet. No groundwater seepage observed. Moderate caving observed from 7 to 12 feet.		
14				
15				

NOTE: This subsurface information pertains only to this test pit location and should not be interpreted as being indicative of other locations at the site.

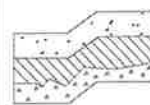

Terra Associates, Inc.
 Consultants in Geotechnical Engineering
 Geology and
 Environmental Earth Sciences

LOG OF TEST PIT NO. TP-103

FIGURE A-17

PROJECT NAME: Freeman Logistics PROJ. NO: T-8565 LOGGED BY: SLK

LOCATION: Pierce County, Washington SURFACE CONDITIONS: Long Grass APPROX. ELEV: N/A

DATE LOGGED: June 22, 2022 DEPTH TO GROUNDWATER: N/A DEPTH TO CAVING: 4.5 to 11 feet

Depth (ft)	Sample No.	Description	Consistency/ Relative Density	W (%)
0		(6 inches Topsoil)	Loose	
1		Intermixed brown silty SAND and dark gray SAND with silt, fine to medium sand, moist. (SM/SP-SM)	Medium Dense	7.8
2				
3		Dark gray SAND, fine to medium sand, moist, trace silt. (SP)	Loose/Medium Dense	42.6
4				
5		Grayish-brown sandy SILT/silty SAND, fine sand, moist, mottled. (ML/SM)		
6			Medium Dense	47.5
7				
8				
9				
10			Medium Dense	46.8
11		Gray silty SAND/sandy SILT, fine sand, moist to wet, trace peat. (SM/ML)		
12		Test pit terminated at 12 feet. No groundwater seepage observed. Moderate caving observed from 4.5 to 11 feet.		
13				
14				

NOTE: This subsurface information pertains only to this test pit location and should not be interpreted as being indicative of other locations at the site.

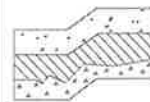

Terra Associates, Inc.
 Consultants in Geotechnical Engineering
 Geology and
 Environmental Earth Sciences

LOG OF TEST PIT NO. TP-104

FIGURE A-18

PROJECT NAME: Freeman Logistics PROJ. NO: T-8565 LOGGED BY: SLK

LOCATION: Pierce County, Washington SURFACE CONDITIONS: Long Grass APPROX. ELEV: N/A

DATE LOGGED: June 22, 2022 DEPTH TO GROUNDWATER: N/A DEPTH TO CAVING: 8.5 to 13 feet

Depth (ft)	Sample No.	Description	Consistency/ Relative Density	W (%)
0		Black SILT with sand, fine sand, moist, moderate organic inclusions. (ML) (Topsoil)	Loose	40.1
1		Brown silty SAND, fine to medim sand, moist, scattered roots. (SM)	Medium Dense	
2		Grayish-brown and red/orange sandy SILT, fine sand, moist, heavily mottled. (ML)		
3				30.9
4				
5				
6				
7				
8				
9		Bedded layers of dark gray and grayish-brown silty SAND and sandy SILT, fine sand, moist. (SM/ML)	Loose/Medium Dense	
10				
11				
12				
13		Test pit terminated at 13 feet. No groundwater seepage observed. Light to moderate caving observed from 8.5 to 13 feet.		29.3
14				
15				

NOTE: This subsurface information pertains only to this test pit location and should not be interpreted as being indicative of other locations at the site.

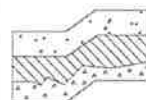

Terra Associates, Inc.
 Consultants in Geotechnical Engineering
 Geology and Environmental Earth Sciences

LOG OF TEST PIT NO. TP-105

FIGURE A-19

PROJECT NAME: Freeman Logistics PROJ. NO: T-8565 LOGGED BY: SLK

LOCATION: Pierce County, Washington SURFACE CONDITIONS: Long Grass APPROX. ELEV: N/A

DATE LOGGED: June 22, 2022 DEPTH TO GROUNDWATER: N/A DEPTH TO CAVING: 8 to 12 feet

Depth (ft)	Sample No.	Description	Consistency/ Relative Density	W (%)
0		(8 inches Topsoil)		
1		FILL: Brown sandy SILT, fine to medim sand, moist, scattered roots. (SM)	Loose	
2		*Plastic membrane observed at about 1.5 feet.		
3		Grayish-brown silty SAND/sandy SILT, fine sand, moist. (SM/ML)		
4			Medium Dense	
5				
6				37.2
7				
8				
9				
10		Gray silty SAND/sandy SILT, fine sand, moist to wet, some mottling. (SM/ML)	Loose/Medium Dense	
11				
12		Test pit terminated at 12 feet. No groundwater seepage observed.		
13		Moderate caving observed from 8 to 12 feet.		
14				25.3

NOTE: This subsurface information pertains only to this test pit location and should not be interpreted as being indicative of other locations at the site.

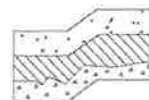

Terra Associates, Inc.
 Consultants in Geotechnical Engineering
 Geology and
 Environmental Earth Sciences

Particle Size Distribution Report

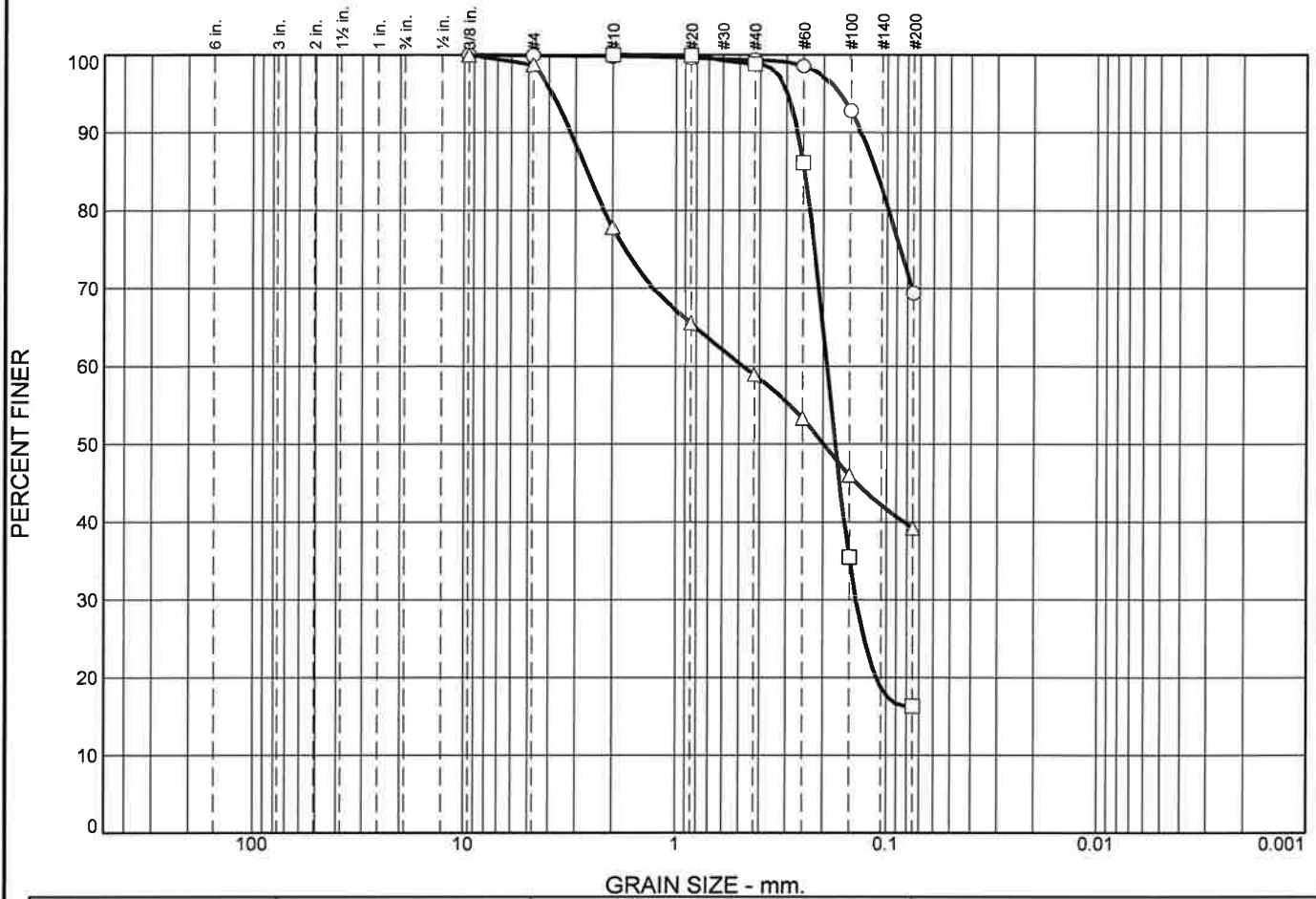

	% +3"	% Gravel		% Sand			% Fines			
		Coarse	Fine	Coarse	Medium	Fine	Silt	Clay		
○	0.0	0.0	0.1	0.1	0.5	29.9	69.4			
□	0.0	0.0	0.0	0.0	1.2	82.5	16.3			
△	0.0	0.0	1.3	20.9	18.9	19.7	39.2			
×	LL	PL	D ₈₅	D ₆₀	D ₅₀	D ₃₀	D ₁₅	D ₁₀	C _c	C _u
○			0.1137							
□			0.2463	0.1912	0.1745	0.1395				
△			2.6410	0.4781	0.1982					

Material Description	USCS	AASHTO
○ sandy SILT	ML	
□ silty SAND	SM	
△ silty SAND	SM	

<p>Project No. T-8565 Client: Vector Development Company</p> <p>Project: Freeman Logistics</p> <p>○ Location: TP-1 Depth: 1'</p> <p>□ Location: TP-1 Depth: 8'</p> <p>△ Location: TP-3 Depth: 3.5'</p> <p style="text-align: center;">Terra Associates, Inc.</p> <p style="text-align: center;">Kirkland, WA</p>	<p>Remarks:</p> <p style="text-align: right;">Figure A-20</p>
---	---

Tested By: FQ

Particle Size Distribution Report

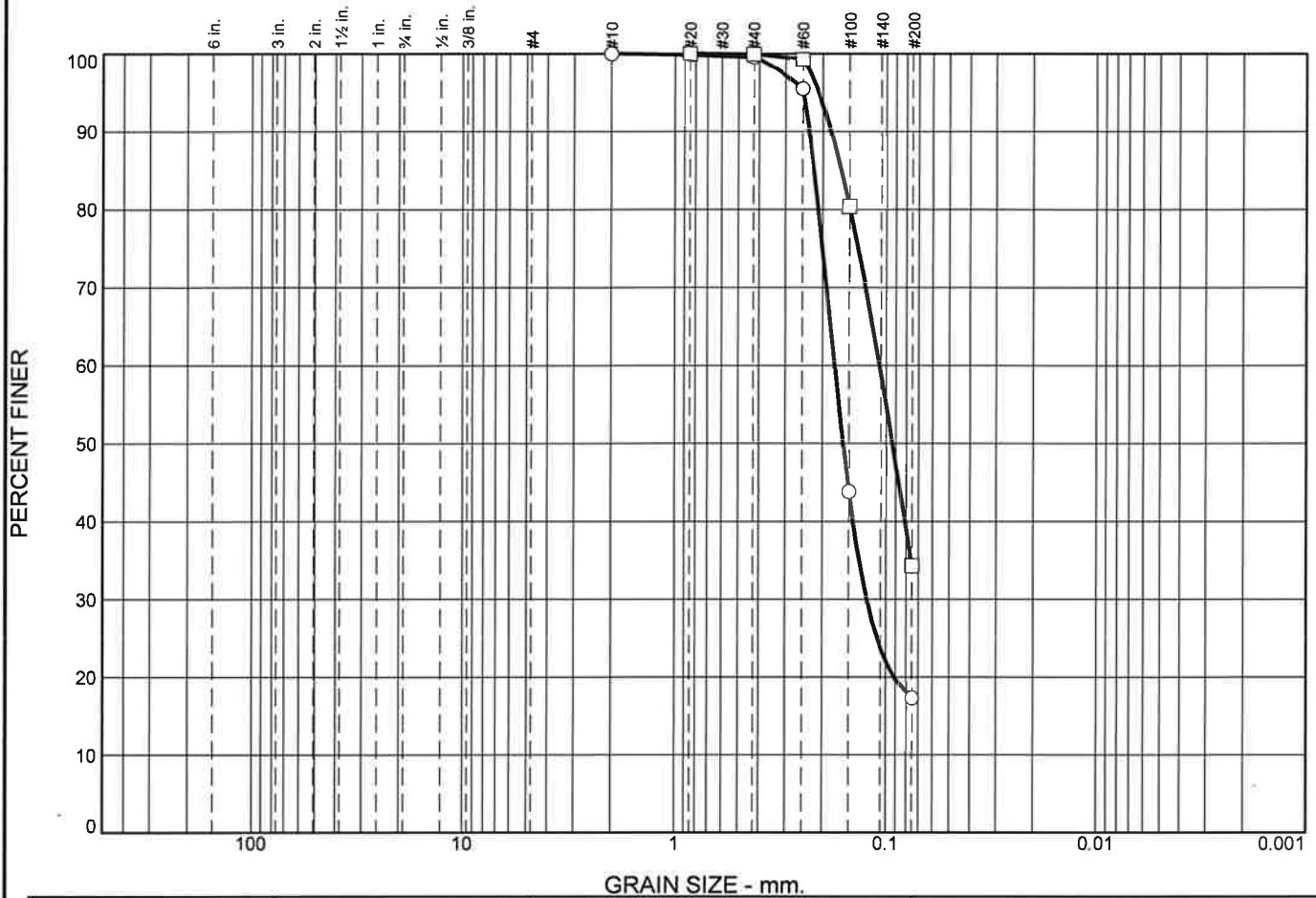

GRAIN SIZE - mm.

	% +3"	% Gravel		% Sand			% Fines			
		Coarse	Fine	Coarse	Medium	Fine	Silt	Clay		
○	0.0	0.0	0.0	0.0	0.5	82.2	17.3			
□	0.0	0.0	0.0	0.0	0.1	65.6	34.3			
×	LL	PL	D ₈₅	D ₆₀	D ₅₀	D ₃₀	D ₁₅	D ₁₀	C _c	C _u
○			0.2200	0.1752	0.1598	0.1235				
□			0.1640	0.1077	0.0932					

Material Description	USCS	AASHTO
○ silty SAND	SM	
□ silty SAND	SM	

<p>Project No. T-8565 Client: Vector Development Company</p> <p>Project: Freeman Logistics</p> <p>○ Location: TP-5 Depth: 5'</p> <p>□ Location: TP-12 Depth: 6'</p> <p style="text-align: center;">Terra Associates, Inc.</p> <p style="text-align: center;">Kirkland, WA</p>	<p>Remarks:</p> <p style="text-align: right;">Figure A-21</p>
---	---

Tested By: FQ

Particle Size Distribution Report

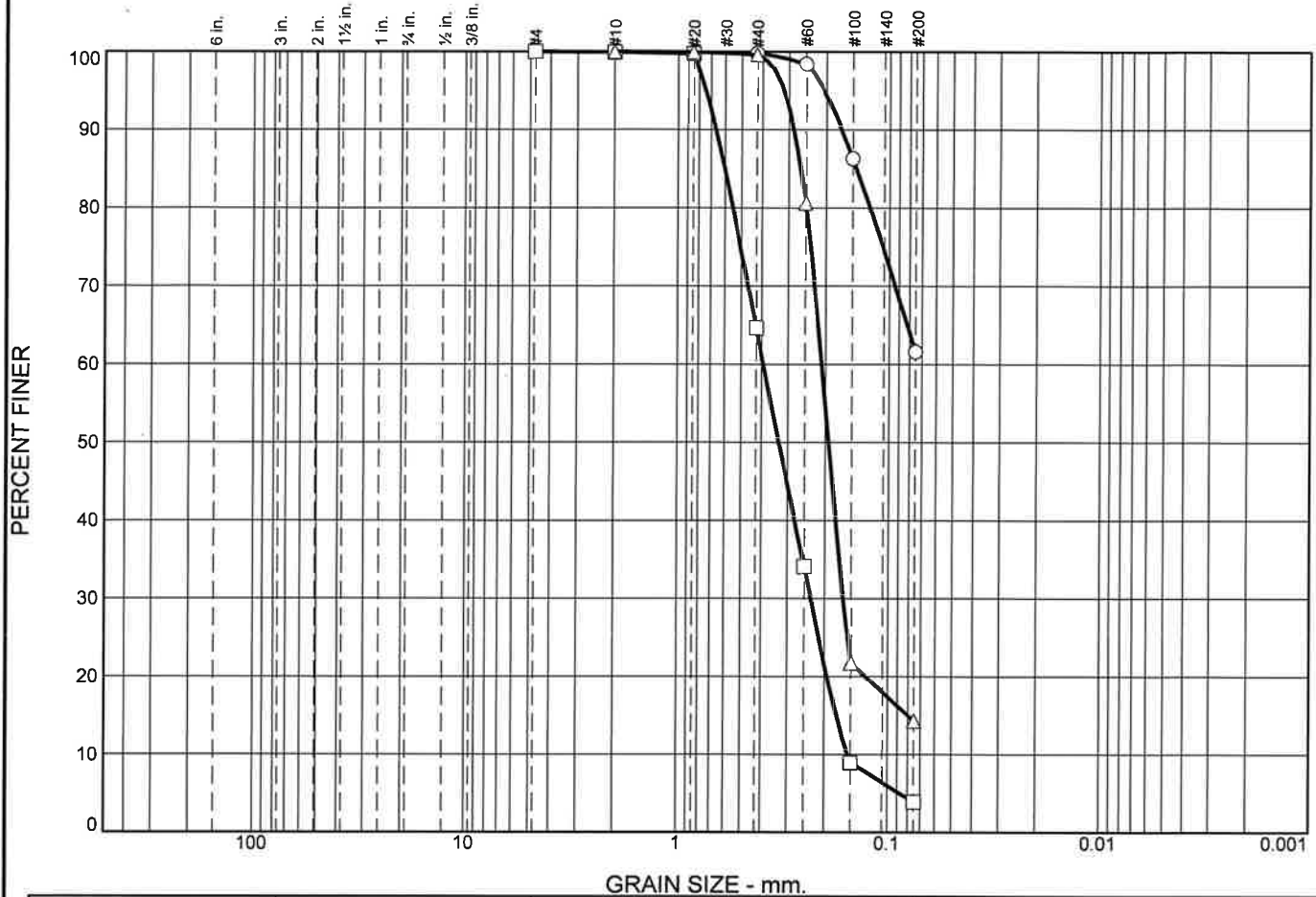

	% +3"	% Gravel		% Sand			% Fines			
		Coarse	Fine	Coarse	Medium	Fine	Silt	Clay		
○	0.0	0.0	0.0	0.1	0.1	38.2	61.6			
□	0.0	0.0	0.0	0.1	35.3	60.7	3.9			
△	0.0	0.0	0.0	0.0	0.4	85.3	14.3			
⊗	LL	PL	D ₈₅	D ₆₀	D ₅₀	D ₃₀	D ₁₅	D ₁₀	C _c	C _u
○			0.1440							
□			0.6016	0.3932	0.3306	0.2327	0.1753	0.1550	0.89	2.54
△			0.2635	0.2081	0.1925	0.1633	0.0801			

Material Description	USCS	AASHTO
○ sandy SILT	ML	
□ poorly graded SAND	SP	
△ silty SAND	SM	

Project No. T-8565 Project: Freeman Logistics	Client: Vector Development Company	Remarks: ○ Tested on June 28, 2022 □ Tested on June 24, 2022 △ Tested on June 24, 2022
○ Location: TP-101 (6/2022) Depth: -13 feet □ Location: TP-103 (6/2022) Depth: -4 feet △ Location: TP-105 (6/2022) Depth: -10 feet		
Terra Associates, Inc. Kirkland, WA		

Figure A-22

Tested By: KJ

PREVIOUS TEST PIT LOGS AND GRAIN SIZE ANALYSES

LOG OF TEST PIT NO. 1

FIGURE 4

PROJECT NAME: Sessler Parcel **PROJ. NO:** T-8136 **LOGGED BY:** EHE

LOCATION: Fife, Washington **SURFACE CONDITIONS:** Pasture Field **APPROX. ELEV:** N/A

DATE LOGGED: March 22, 2019 **DEPTH TO GROUNDWATER:** 6 Feet **DEPTH TO CAVING:** 6 Feet

Depth (ft)	Sample No.	Description	Consistency/ Relative Density	W (%)
0		(4 inches TOPSOIL and ORGANICS)		
1		Tan to brown silty SAND to sandy SILT, fine to medium sand, moist, minor to moderate mottling after 3 feet, trace to some clay. (SM/ML)		
2	1		Loose to Medium Dense	31.4
3				
4				
5				
6	2	Gray to brown silty SAND, fine to coarse sand, moist to wet, minor to moderate mottling. (SM)	Medium Dense	36.6
7				
8	3	Gray-blue to gray silty SAND, fine to coarse sand, wet to saturated. (SM)	Medium Dense to Dense	32.5
9				
10		Test pit terminated at approximately 9 feet. Minor groundwater seepage observed 6 feet. Minor caving observed between 6 and 8 feet.		
11				
12				
13				
14				
15				

NOTE: This subsurface information pertains only to this test pit location and should not be interpreted as being indicative of other locations at the site.

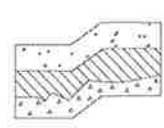

Terra Associates, Inc.
 Consultants in Geotechnical Engineering
 Geology and
 Environmental Earth Sciences

LOG OF TEST PIT NO. 2

FIGURE 5

PROJECT NAME: Sessler Parcel **PROJ. NO:** T-8136 **LOGGED BY:** EHE

LOCATION: Fife, Washington **SURFACE CONDITIONS:** Pasture Field **APPROX. ELEV:** N/A

DATE LOGGED: March 22, 2019 **DEPTH TO GROUNDWATER:** 5 Feet **DEPTH TO CAVING:** 5 Feet

Depth (ft)	Sample No.	Description	Consistency/ Relative Density	W (%)
0		(4 inches TOPSOIL and ORGANICS)	Loose	
1		Tan to brown silty SAND to sandy SILT, fine to medium sand, moist, minor to moderate mottling below 2 feet, minor roots to 2 feet. (SM/ML)	Loose to Medium Dense	37.1
2	1			
3				
4				
5	2	Gray to brown sandy SILT, fine to medium sand, moist to wet, minor mottling to 6.5 feet, some clay. (ML)	Medium Dense	41.0
6				
7	3	Tan to gray silty SAND, fine to coarse sand, wet to saturated. (SM)	Medium Dense to Dense	33.6
8				
9		Test pit terminated at approximately 9 feet. Minor to moderate groundwater seepage observed between 5 and 8 feet. Minor caving observed between 5 and 8 feet.		
10				
11				
12				
13				
14				
15				

NOTE: This subsurface information pertains only to this test pit location and should not be interpreted as being indicative of other locations at the site.

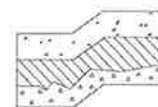

Terra
Associates, Inc.

Consultants in Geotechnical Engineering
Geology and
Environmental Earth Sciences

LOG OF TEST PIT NO. 3

FIGURE 6

PROJECT NAME: Sessler Parcel **PROJ. NO:** T-8136 **LOGGED BY:** EHE

LOCATION: Fife, Washington **SURFACE CONDITIONS:** Pasture Field **APPROX. ELEV:** N/A

DATE LOGGED: March 22, 2019 **DEPTH TO GROUNDWATER:** 7 Feet **DEPTH TO CAVING:** 7.5 Feet

Depth (ft)	Sample No.	Description	Consistency/ Relative Density	W (%)
0		(4 inches TOPSOIL and ORGANICS)	Loose	
1		Tan to brown silty SAND to sandy SILT, fine to medium sand, moist, minor to moderate mottling below 2 feet, trace to some clay. (SM/ML)		
2				
3	1		Loose to Medium Dense	35.8
4				
5				
6	2	Gray-blue to gray silty SAND, fine to medium sand, moist, minor mottling, some clay. (SM)	Medium Dense to Dense	47.2
7		Gray to tan sandy SILT with clay, fine to medium sand, moist to wet. (ML)		
8	3	Gray-blue to gray silty SAND, fine to coarse sand, wet to saturated. (SM)	Medium Dense	23.6
9				
10		Test pit terminated at approximately 9.5 feet. Minor groundwater seepage observed at 7 feet. Minor caving observed between 7.5 and 9.5 feet.		
11				
12				
13				
14				
15				

NOTE: This subsurface information pertains only to this test pit location and should not be interpreted as being indicative of other locations at the site.

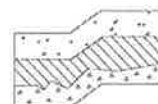

Terra Associates, Inc.
 Consultants in Geotechnical Engineering
 Geology and
 Environmental Earth Sciences

LOG OF TEST PIT NO. 4

FIGURE 7

PROJECT NAME: Sessler Parcel PROJ. NO: T-8136 LOGGED BY: EHE

LOCATION: Fife, Washington SURFACE CONDITIONS: Pasture Field APPROX. ELEV: N/A

DATE LOGGED: March 22, 2019 DEPTH TO GROUNDWATER: N/A DEPTH TO CAVING: N/A

Depth (ft)	Sample No.	Description	Consistency/ Relative Density	W (%)
0		(4 inches TOPSOIL and ORGANICS)		
1	1	Tan to brown silty SAND to sandy SILT, fine to medium sand, moist, minor to moderate mottling below 2 feet, minor organic roots up to 2.5 feet, trace to some clay. (SM/ML)	Loose to Medium Dense	34.5
2				
3				
4				
5	2	Gray to brown silty SAND, fine to coarse sand, moist. (SM)	Medium Dense to Dense	29.7
6		Tan to brown sandy SILT, fine to medium sand, moist, minor mottling, some clay. (ML)	Dense	
7	3	Gray-blue to gray silty SAND, fine to coarse sand, moist to wet. (SM)	Medium Dense to Dense	26.1
8				
9				
10				
11		Test pit terminated at approximately 10 feet. No groundwater seepage observed. No caving observed.		
12				
13				
14				
15				

NOTE: This subsurface information pertains only to this test pit location and should not be interpreted as being indicative of other locations at the site.

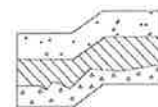

Terra
Associates, Inc.

Consultants in Geotechnical Engineering
Geology and
Environmental Earth Sciences

LOG OF TEST PIT NO. 5

FIGURE 8

PROJECT NAME: Sessler Parcel **PROJ. NO:** T-8136 **LOGGED BY:** EHE

LOCATION: Fife, Washington **SURFACE CONDITIONS:** Pasture Field **APPROX. ELEV:** N/A

DATE LOGGED: March 22, 2019 **DEPTH TO GROUNDWATER:** 7 Feet **DEPTH TO CAVING:** 8 Feet

Depth (ft)	Sample No.	Description	Consistency/ Relative Density	W (%)
0		(4 inches TOPSOIL and ORGANICS)	Loose	
1		Tan to brown silty SAND to sandy SILT, fine to medium sand, moist, minor to moderate mottling between 2 and 5 feet, trace to some clay. (SM/ML)	Loose to Medium Dense	33.2
2	1			
3				
4				
5				
6				
7	2	Gray to brown silty SAND, fine to coarse sand, moist to wet. (SM)	Medium Dense	31.1
8	3	Tan to brown sandy SILT, fine to medium sand, wet, some clay. (ML)		
9	4	Gray-blue to gray silty SAND, fine to coarse sand, wet to saturated. (SM)		36.4
10		Test pit terminated at approximately 10 feet. Minor to moderate groundwater seepage from 7 to 10 feet. Minor caving observd between 8 and 10 feet.		
11				
12				
13				
14				
15				

NOTE: This subsurface information pertains only to this test pit location and should not be interpreted as being indicative of other locations at the site.

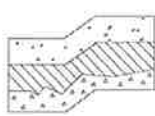

Terra Associates, Inc.
 Consultants in Geotechnical Engineering
 Geology and
 Environmental Earth Sciences

Particle Size Distribution Report

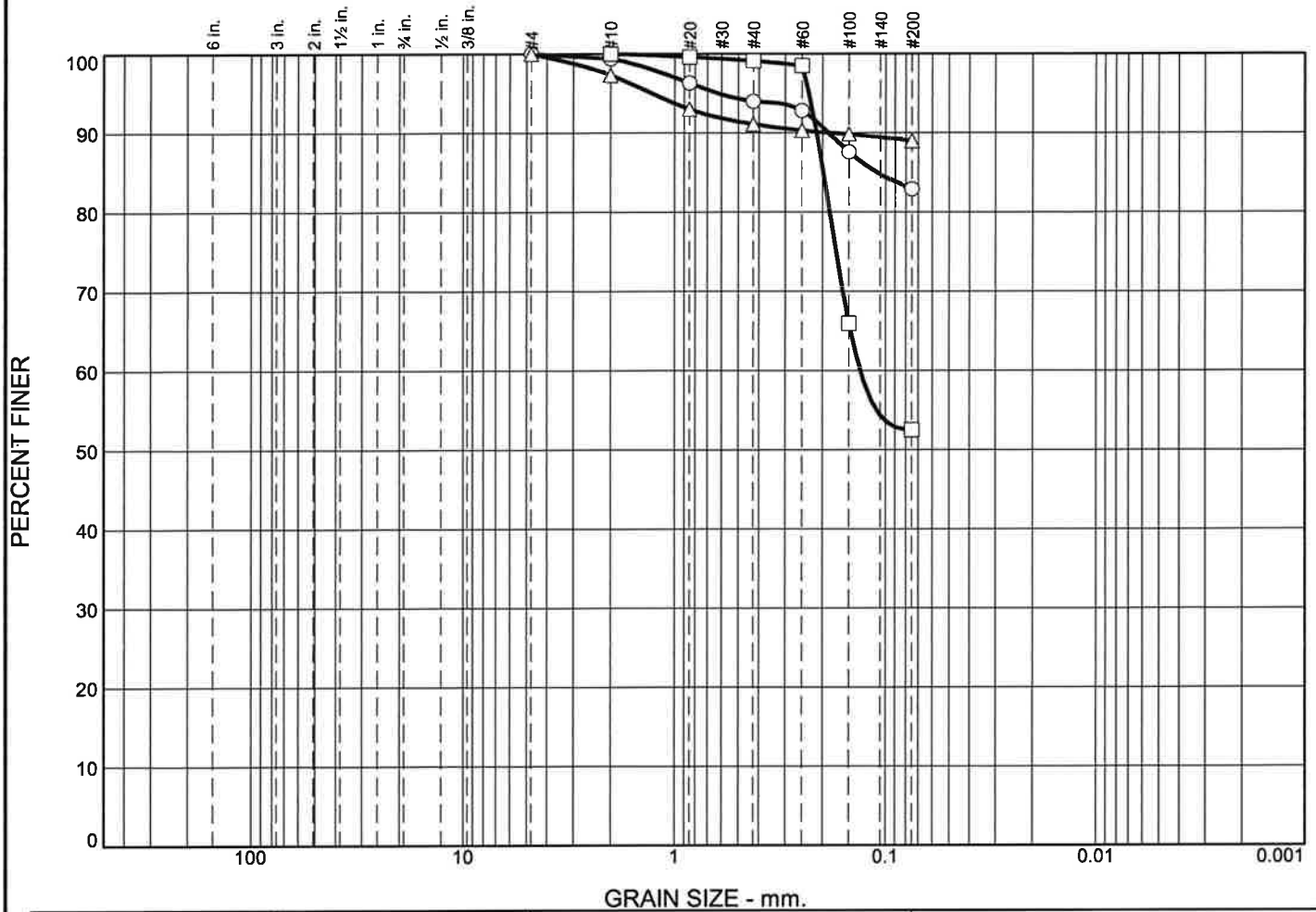

	% +3"	% Gravel		% Sand			% Fines			
		Coarse	Fine	Coarse	Medium	Fine	Silt	Clay		
○	0.0	0.0	0.0	0.6	5.4	11.1	82.9			
□	0.0	0.0	0.0	0.0	0.9	46.6	52.5			
△	0.0	0.0	0.0	2.7	6.2	2.1	89.0			
×	LL	PL	D ₈₅	D ₆₀	D ₅₀	D ₃₀	D ₁₅	D ₁₀	C _c	C _u
○			0.1106							
□			0.1980	0.1323						
△										

Material Description	USCS	AASHTO
○ SILT with sand	ML	
□ Sandy SILT	ML	
△ SILT	ML	

Project No. T-8136 **Client:** Mr. John Sessler c/o Vector Development Company

Project: Sessler Parcel
Pierce County, Washington

○ **Location:** Test Pit TP-1 **Depth:** -2.5 feet
 □ **Location:** Test Pit TP-2 **Depth:** -7.5 feet
 △ **Location:** Test Pit TP-3 **Depth:** -6 feet

Terra Associates, Inc.

Kirkland, WA

Remarks:

- Tested on April 11, 2019
- Tested on April 11, 2019
- △ Tested on April 11, 2019

Figure 9

Tested By: FQ

Particle Size Distribution Report

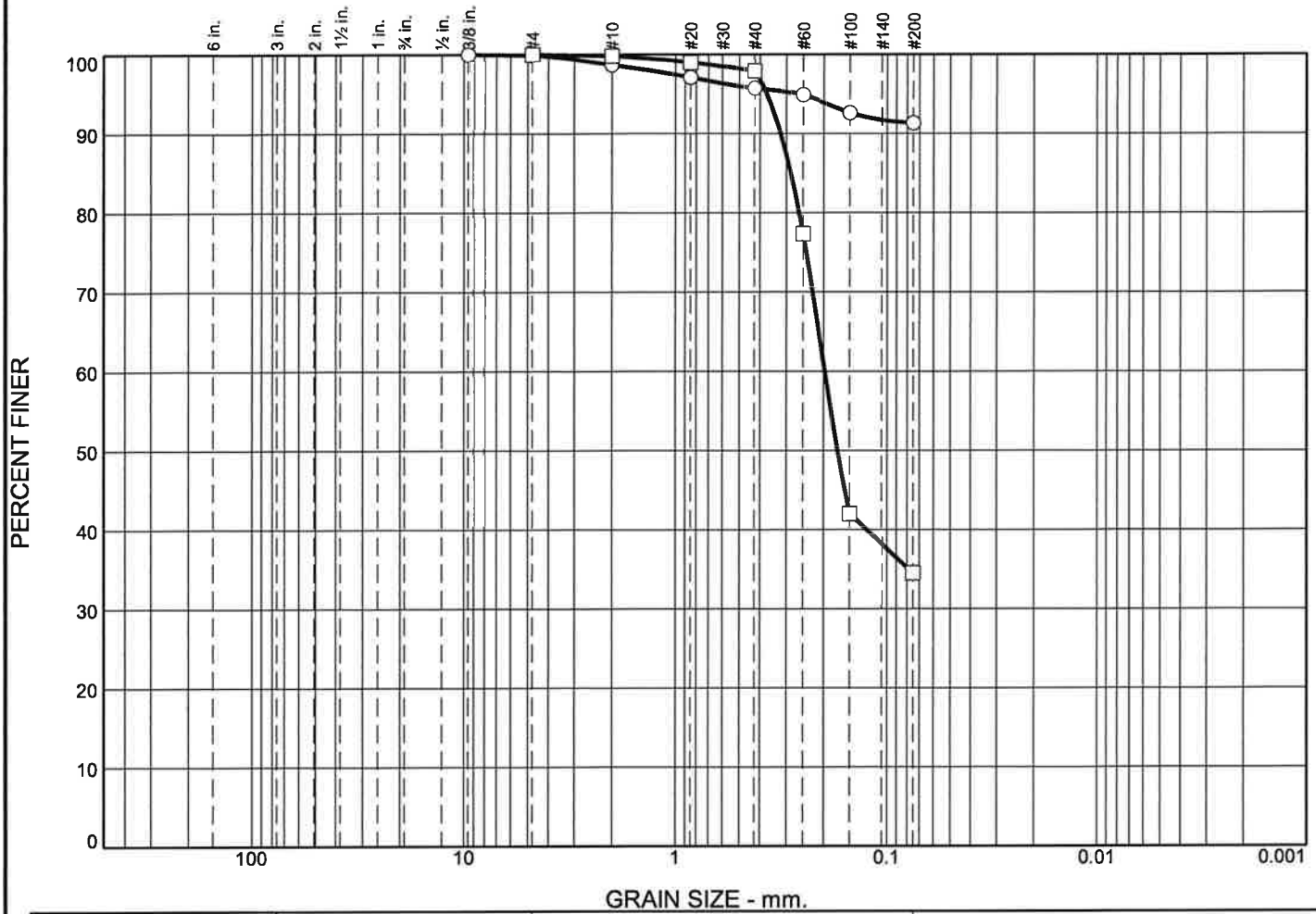

	% +3"	% Gravel		% Sand			% Fines			
		Coarse	Fine	Coarse	Medium	Fine	Silt	Clay		
<input type="radio"/>	0.0	0.0	0.1	1.2	3.0	4.4	91.3			
<input type="checkbox"/>	0.0	0.0	0.0	0.2	1.9	63.4	34.5			
<input checked="" type="checkbox"/>	LL	PL	D ₈₅	D ₆₀	D ₅₀	D ₃₀	D ₁₅	D ₁₀	C _c	C _u
<input type="radio"/>										
<input type="checkbox"/>			0.2858	0.1970	0.1716					

Material Description	USCS	AASHTO
<input type="radio"/> SILT	ML	
<input type="checkbox"/> Silty SAND	SM	

Project No. T-8136 Project: Sessler Parcel Pierce County, Washington <input type="radio"/> Location: Test Pit TP-4 <input type="checkbox"/> Location: Test Pit TP-5	Client: Mr. John Sessler c/o Vector Development Company Depth: -2.5 feet Depth: -5.5 feet	Remarks: <input type="radio"/> Tested on April 11, 2019 <input type="checkbox"/> Tested on April 11, 2019
Terra Associates, Inc. Kirkland, WA		Figure 10

Tested By: FQ

LOG OF TEST PIT NO. 1

FIGURE 4

PROJECT NAME: Grelis Property **PROJ. NO:** T-8089 **LOGGED BY:** EHE

LOCATION: Pierce County, Washington **SURFACE CONDITIONS:** Dewy Farm Field **APPROX. ELEV:** N/A

DATE LOGGED: January 10, 2019 **DEPTH TO GROUNDWATER:** 7 Feet **DEPTH TO CAVING:** 9 Feet

Depth (ft)	Sample No.	Description	Consistency/ Relative Density	W (%)
0		(TOPSOIL and ORGANIC DEBRIS)		
1		Brown sandy SILT to silty SAND with minor organics and rooting, moist. (ML-SM)	Loose	31.5
2				
3		Gray to brown sandy SILT to silty SAND with heavy orange to red-brown mottling. (ML-SM)		
4				
5			Medium Dense	
6				
7		Gray silty SAND to sandy SILT with some light orange mottling. (SM-ML)		
8				
9				
10		Test pit terminated at approximately 10 feet. Light groundwater seepage observed at 7 feet.		
11				
12				
13				
14				
15				

NOTE: This subsurface information pertains only to this test pit location and should not be interpreted as being indicative of other locations at the site.



Terra Associates, Inc.
 Consultants in Geotechnical Engineering
 Geology and Environmental Earth Sciences

LOG OF TEST PIT NO. 2

FIGURE 5

PROJECT NAME: Grelis Property **PROJ. NO:** T-8089 **LOGGED BY:** EHE

LOCATION: Pierce County, Washington **SURFACE CONDITIONS:** Dewy Farm Field **APPROX. ELEV:** N/A

DATE LOGGED: January 10, 2019 **DEPTH TO GROUNDWATER:** 6 Feet **DEPTH TO CAVING:** 8.5 Feet

Depth (ft)	Sample No.	Description	Consistency/ Relative Density	W (%)
0		(TOPSOIL and ORGANIC DEBRIS)		
1		Gray-brown silty SAND to sandy SILT with minor organics and rooting, moist. (SM-ML)	Loose	27.7
2				
3		Gray to brown silty SAND to sandy SILT with some clay and heavy orange to red-brown mottling, moist to wet. (SM-ML)		
4				
5			Medium Dense	
6				
7		Gray silty SAND to sandy SILT, wet to saturated. (ML-SM)		
8				
9		Test pit terminated at approximately 9 feet. Moderate to heavy groundwater seepage observed at 6 feet. Heavy caving at 8.5 feet.		
10				
11				
12				
13				
14				
15				

NOTE: This subsurface information pertains only to this test pit location and should not be interpreted as being indicative of other locations at the site.

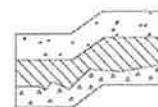

Terra
Associates, Inc.

Consultants in Geotechnical Engineering
Geology and
Environmental Earth Sciences

LOG OF TEST PIT NO. 3

FIGURE 6

PROJECT NAME: Grelis Property **PROJ. NO:** T-8089 **LOGGED BY:** EHE

LOCATION: Pierce County, Washington **SURFACE CONDITIONS:** Dewy Farm Field **APPROX. ELEV:** N/A

DATE LOGGED: January 10, 2019 **DEPTH TO GROUNDWATER:** N/A **DEPTH TO CAVING:** 9.5 Feet

Depth (ft)	Sample No.	Description	Consistency/ Relative Density	W (%)
0		(TOPSOIL and ORGANIC DEBRIS)		
1		Gray to brown silty SAND to sandy SILT with minor organics and rooting, moist. (SM-ML)	Loose	25.1
2				
3				
4		Gray to brown silty SAND to sandy SILT with heavy orange to red-brown mottling and occasional clay lenses, moist. (SM-ML)	Medium Dense	
5				
6				
7		Gray silty SAND, moist to wet. (SM)		
8				
9				
10		Test pit terminated at approximately 10 feet. No groundwater seepage observed.		
11				
12				
13				
14				
15				

NOTE: This subsurface information pertains only to this test pit location and should not be interpreted as being indicative of other locations at the site.

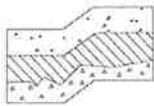

Terra Associates, Inc.
Consultants in Geotechnical Engineering
 Geology and
 Environmental Earth Sciences

LOG OF TEST PIT NO. 4

FIGURE 7

PROJECT NAME: Grelis Property **PROJ. NO:** T-8089 **LOGGED BY:** EHE

LOCATION: Pierce County, Washington **SURFACE CONDITIONS:** Dewy Farm Field **APPROX. ELEV:** N/A

DATE LOGGED: January 10, 2019 **DEPTH TO GROUNDWATER:** 8.75 Feet **DEPTH TO CAVING:** 9 Feet

Depth (ft)	Sample No.	Description	Consistency/ Relative Density	W (%)
0		(TOPSOIL and ORGANIC DEBRIS)	Loose	
1		Gray to brown silty SAND to sandy SILT with minor organics and rooting, moist. (SM-ML)	Loose to Medium Dense	
2		Gray to brown silty SAND to sandy SILT with variable (trace to some) clay and heavy orange to red-brown mottling, moist. (SM-ML)		
3				
4			Loose	
5				
6				
7		Gray SILT with clay and light orange mottling and a 0.5-foot pocket of woody debris, moist to wet. (ML)		50.1
8			Soft	
9				
10		Test pit terminated at approximately 10 feet. Light groundwater seepage observed at 8.75 feet.		
11				
12				
13				
14				
15				

NOTE: This subsurface information pertains only to this test pit location and should not be interpreted as being indicative of other locations at the site.

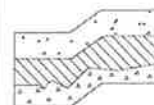

Terra Associates, Inc.
 Consultants in Geotechnical Engineering
 Geology and
 Environmental Earth Sciences

LOG OF TEST PIT NO. 5

FIGURE 8

PROJECT NAME: Grelis Property **PROJ. NO:** T-8089 **LOGGED BY:** EHE

LOCATION: Pierce County, Washington **SURFACE CONDITIONS:** Dewy Farm Field **APPROX. ELEV:** N/A

DATE LOGGED: January 10, 2019 **DEPTH TO GROUNDWATER:** N/A **DEPTH TO CAVING:** 9 Feet

Depth (ft)	Sample No.	Description	Consistency/ Relative Density	W (%)
0		(TOPSOIL and ORGANIC DEBRIS)		
1		Gray to brown silty SAND to sandy SILT with minor organics and rooting, moist. (SM-ML)	Loose	
2				
3		Gray to brown silty SAND to sandy SILT with light orange mottling. (SM-ML)		
4				
5		Gray silty SAND to sandy SILT with heavy orange to red-brown mottling. (SM-ML)		21.6
6			Medium Dense	
7		Gray to black silty SAND, moist. (SM)		
8				16.5
9				
10		Test pit terminated at approximately 10 feet. No groundwater seepage observed.		
11				
12				
13				
14				
15				

NOTE: This subsurface information pertains only to this test pit location and should not be interpreted as being indicative of other locations at the site.

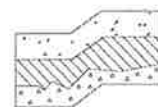

Terra
Associates, Inc.

Consultants in Geotechnical Engineering
Geology and
Environmental Earth Sciences

Particle Size Distribution Report

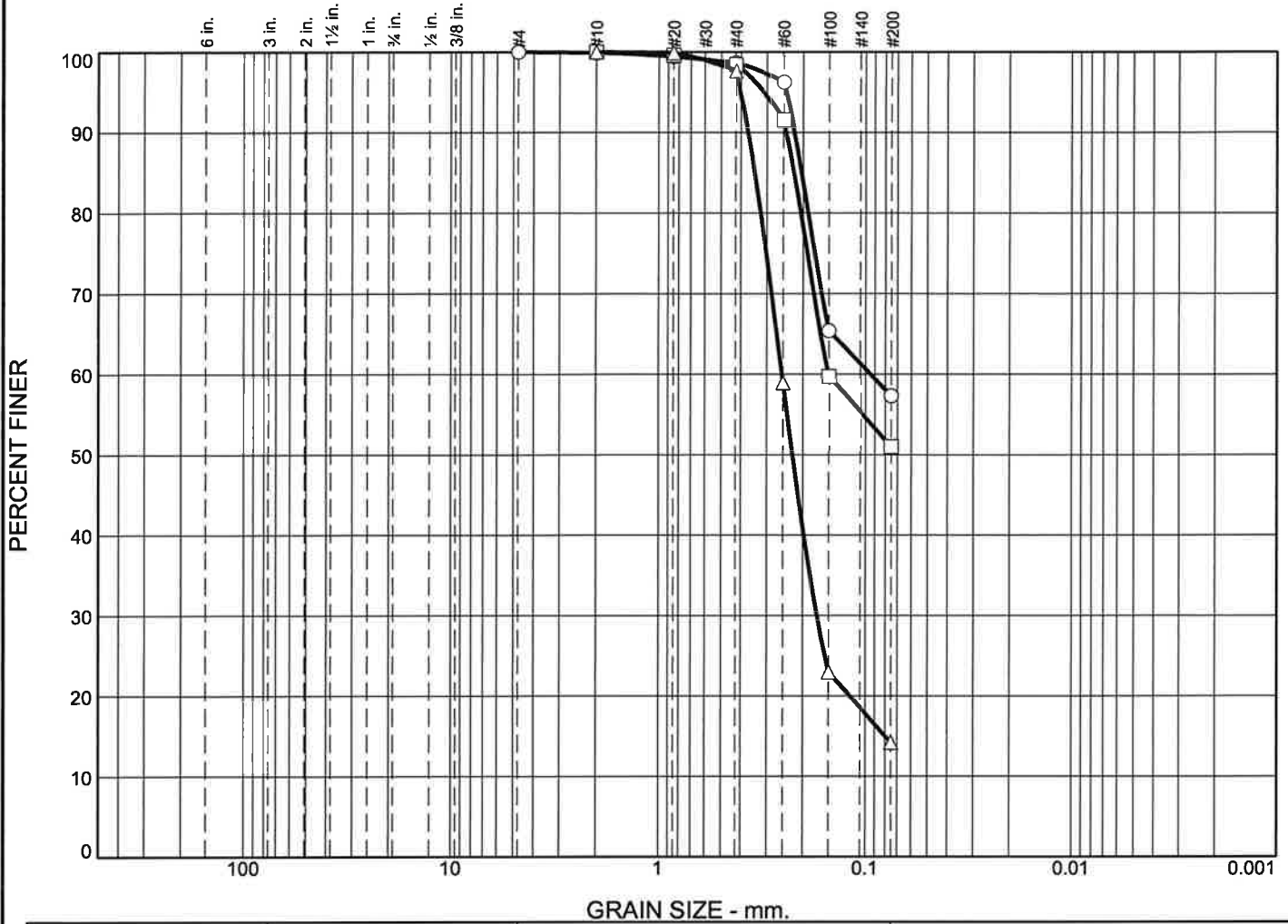

	% +3"	% Gravel		% Sand			% Fines	
		Coarse	Fine	Coarse	Medium	Fine	Silt	Clay
○	0.0	0.0	0.0	0.1	1.3	41.3	57.3	
□	0.0	0.0	0.0	0.0	1.6	47.4	51.0	
△	0.0	0.0	0.0	0.0	2.4	83.4	14.2	

	LL	PL	D ₈₅	D ₆₀	D ₅₀	D ₃₀	D ₁₅	D ₁₀	C _c	C _u
□			0.2217	0.1509						
△			0.3431	0.2532	0.2249	0.1711	0.0799			

Material Description	USCS	AASHTO
○ Sandy Silt	ML	
□ Sandy Silt	ML-SM	
△ Silty Sand	SM	

Project No. T-8089	Client: Dennis Grellis
Project: Grellis Property	
Pierce County, Washington	
○ Location: Test Pit TP-1	Depth: 7.5 feet
□ Location: Test Pit TP-2	Depth: 8 feet
△ Location: Test Pit TP-3	Depth: 7.5 feet
Terra Associates, Inc.	
Kirkland, WA	

Remarks:

Particle Size Distribution Report

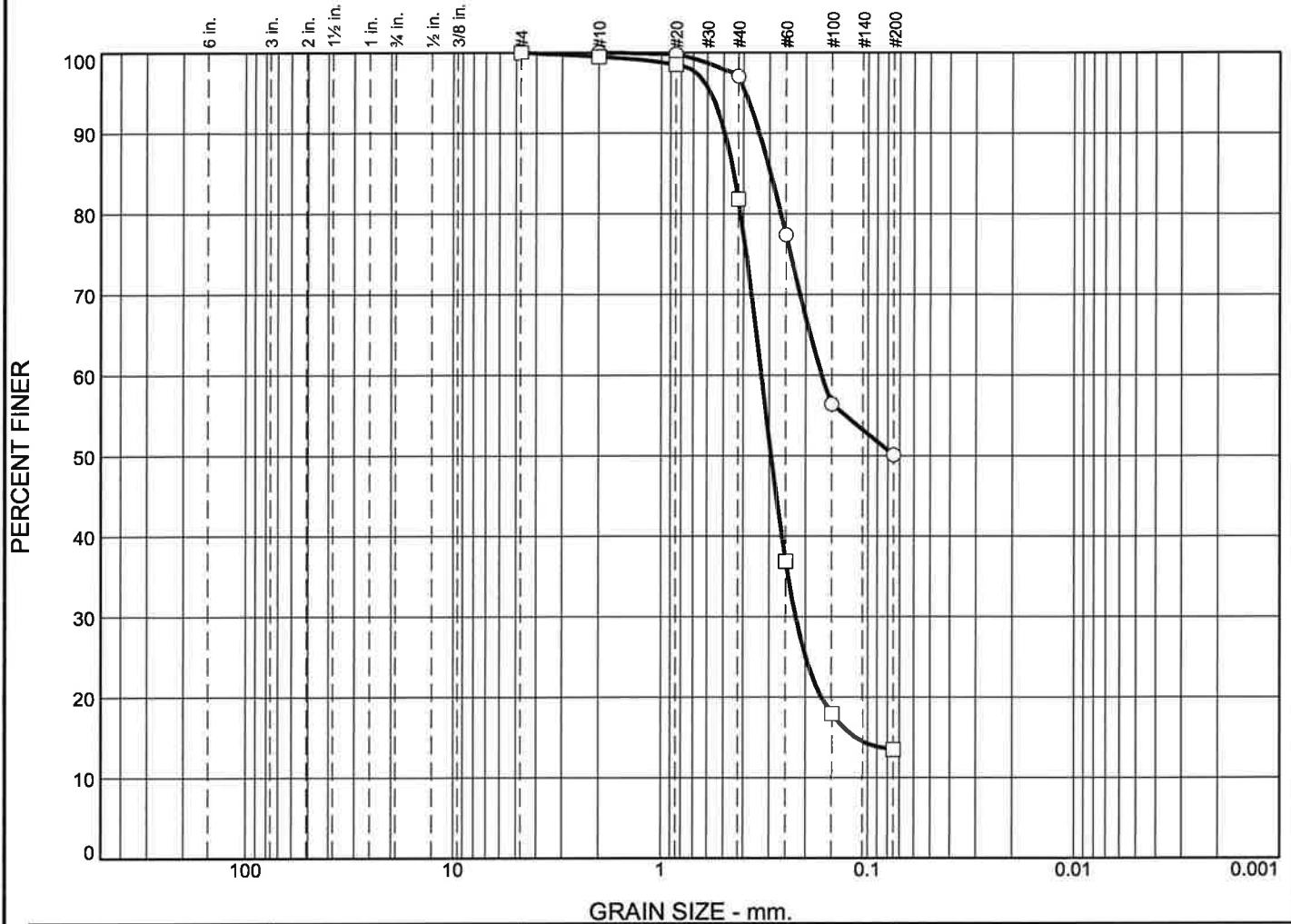

	% +3"	% Gravel		% Sand			% Fines			
		Coarse	Fine	Coarse	Medium	Fine	Silt	Clay		
○	0.0	0.0	0.0	0.0	3.0	46.9	50.1			
□	0.0	0.0	0.0	0.5	17.7	68.3	13.5			
×	LL	PL	D ₈₅	D ₆₀	D ₅₀	D ₃₀	D ₁₅	D ₁₀	C _c	C _u
○			0.2971	0.1678						
□			0.4473	0.3276	0.2937	0.2232	0.1151			

Material Description	USCS	AASHTO
○ Sandy Silt/Silty Sand		
□ Silty Sand	SM	

<p>Project No. T-8089 Client: Dennis Grellis</p> <p>Project: Grellis Property Pierce County, Washington</p> <p>○ Location: Test Pit TP-5 Depth: 5.5 feet</p> <p>□ Location: Test Pit TP-5 Depth: 8 feet</p>	<p>Remarks:</p>
<p>Terra Associates, Inc.</p> <p>Kirkland, WA</p>	

CPT LOGS

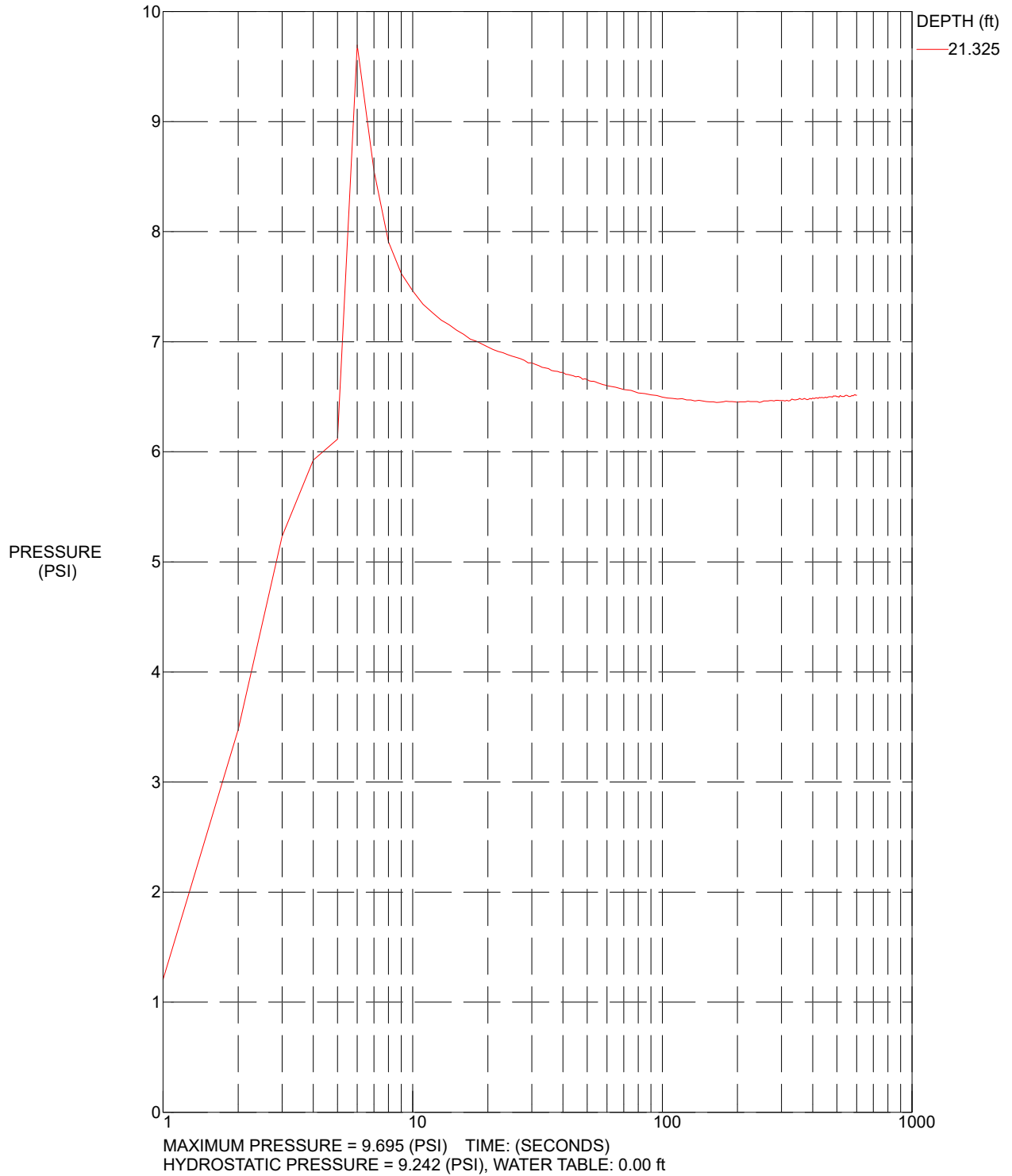
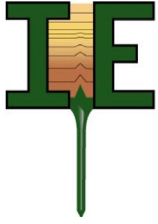

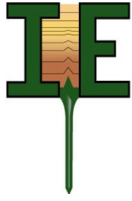

CPT-101

CPT CONTRACTOR: In Situ Engineering
 CUSTOMER: Terra Associates
 LOCATION: Puyallup
 JOB NUMBER: T-8565

OPERATOR: Okbay/Forinash
 CONE ID: DDG1263
 TEST DATE: 6/9/2022 11:11:29 AM
 PREDRILL:
 BACKFILL:
 SURFACE PATCH:

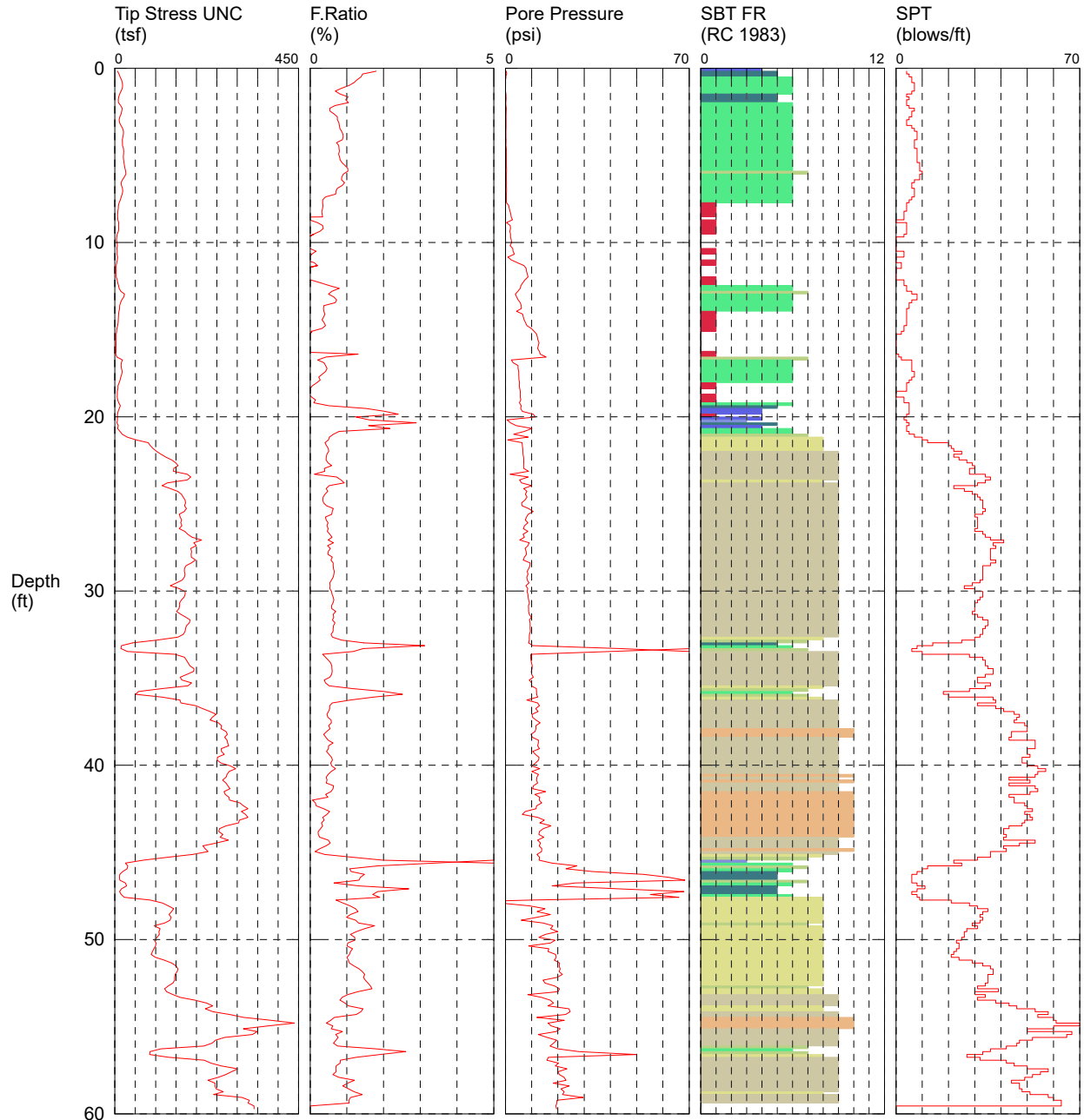

- | | | | |
|---|---|--|--|
| <ul style="list-style-type: none"> ■ 1 sensitive fine grained ■ 2 organic material ■ 3 clay | <ul style="list-style-type: none"> ■ 4 silty clay to clay ■ 5 clayey silt to silty clay ■ 6 sandy silt to clayey silt | <ul style="list-style-type: none"> ■ 7 silty sand to sandy silt ■ 8 sand to silty sand ■ 9 sand | <ul style="list-style-type: none"> ■ 10 gravelly sand to sand ■ 11 very stiff fine grained (*) ■ 12 sand to clayey sand (*) |
|---|---|--|--|

*SBT/SPT CORRELATION: UBC-1983



CPT-102

CPT CONTRACTOR: In Situ Engineering
 CUSTOMER: Terra Associates
 LOCATION: Puyallup
 JOB NUMBER: T-8565

OPERATOR: Okbay/Forinash
 CONE ID: DDG1263
 TEST DATE: 6/9/2022 1:01:45 PM
 PREDRILL:
 BACKFILL:
 SURFACE PATCH:

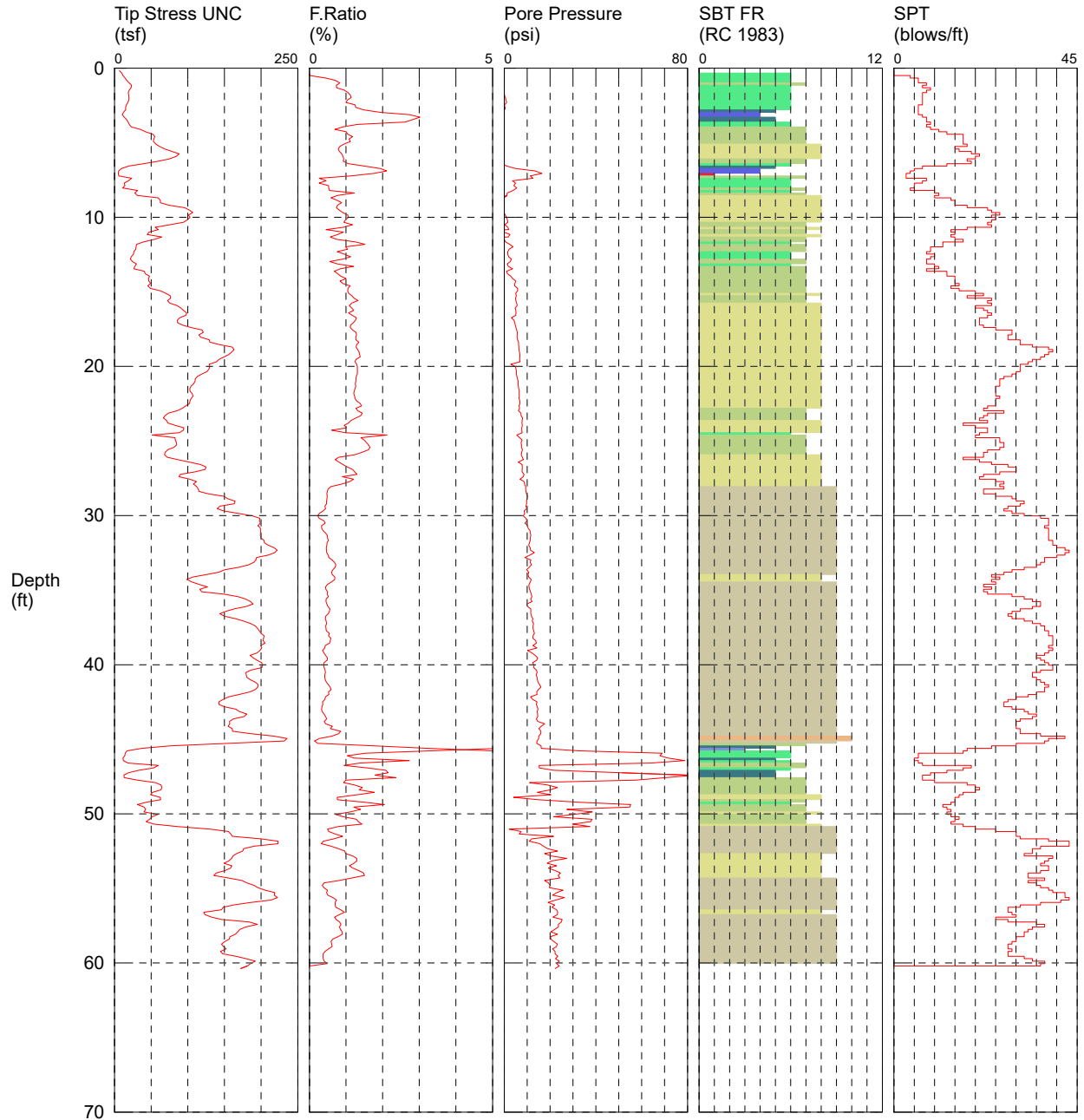

- | | | | |
|--------------------------|-----------------------------|----------------------------|--------------------------------|
| 1 sensitive fine grained | 4 silty clay to clay | 7 silty sand to sandy silt | 10 gravelly sand to sand |
| 2 organic material | 5 clayey silt to silty clay | 8 sand to silty sand | 11 very stiff fine grained (*) |
| 3 clay | 6 sandy silt to clayey silt | 9 sand | 12 sand to clayey sand (*) |

*SBT/SPT CORRELATION: UBC-1983

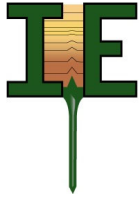

CPT-01

CPT CONTRACTOR: In Situ Engineering
 CUSTOMER: Terra Associates
 LOCATION: Puyallup
 JOB NUMBER: T-8565

OPERATOR: Mayfield/Okbay
 CONE ID: DDG1394
 TEST DATE: 7/8/2021 10:05:10 AM
 PREDRILL:
 BACKFILL: 20% Bentonite Grout + Bentonite Chip
 SURFACE PATCH:

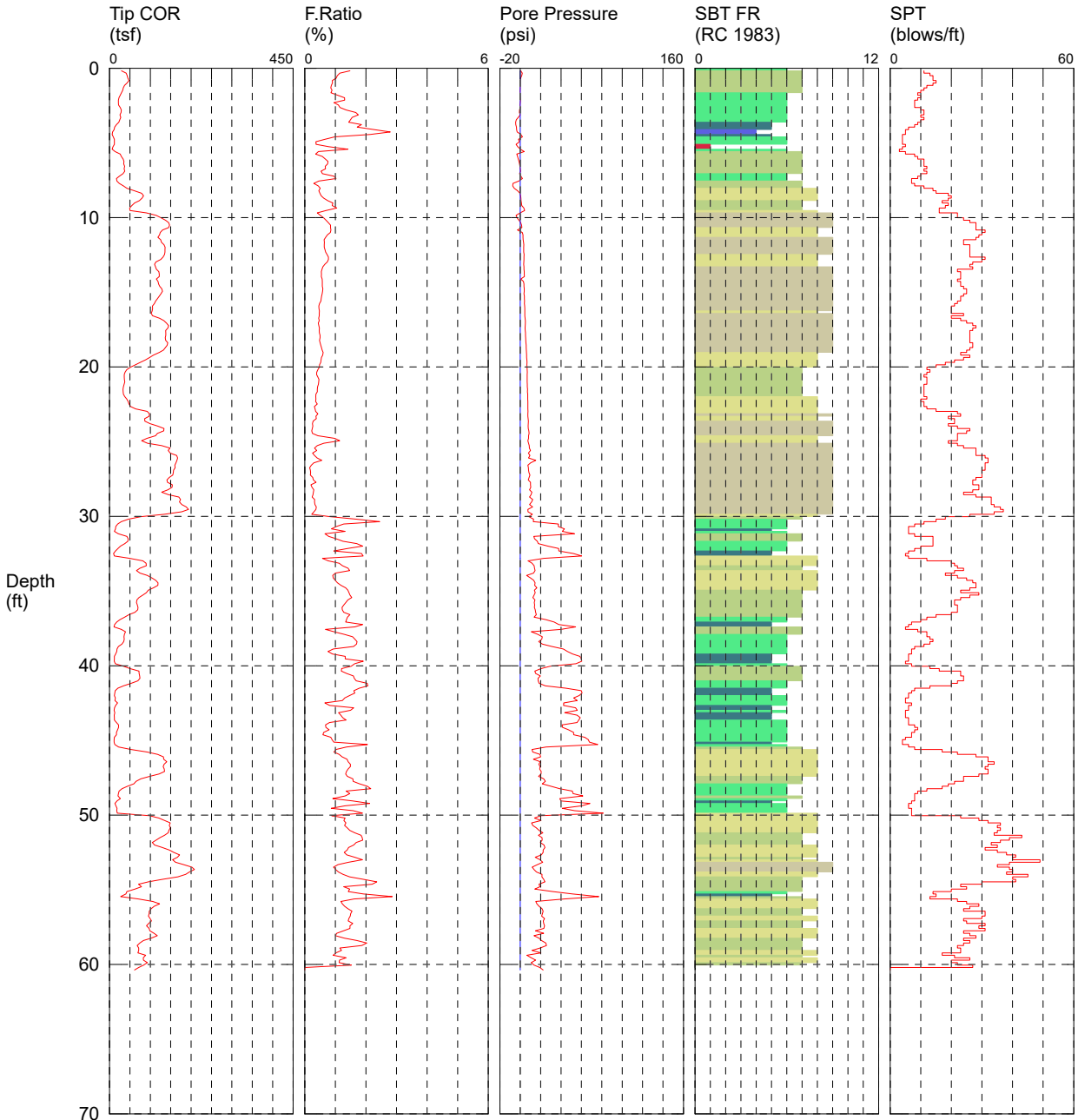

COMMENT:

- | | | | |
|---|---|--|--|
| <ul style="list-style-type: none"> ■ 1 sensitive fine grained ■ 2 organic material ■ 3 clay | <ul style="list-style-type: none"> ■ 4 silty clay to clay ■ 5 clayey silt to silty clay ■ 6 sandy silt to clayey silt | <ul style="list-style-type: none"> ■ 7 silty sand to sandy silt ■ 8 sand to silty sand ■ 9 sand | <ul style="list-style-type: none"> ■ 10 gravelly sand to sand ■ 11 very stiff fine grained (*) ■ 12 sand to clayey sand (*) |
|---|---|--|--|

*SBT/SPT CORRELATION: UBC-1983

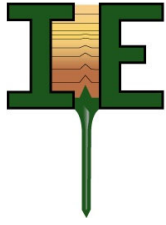

CPT-01

OPERATOR: Mayfield/Okbay
CUSTOMER: Terra Associates
LOCATION: Puyallup
JOB NUMBER: T-8565

CPT CONTRACTOR: In Situ Engineering
CONE ID: DDG1394
TEST DATE: 07/08/2021

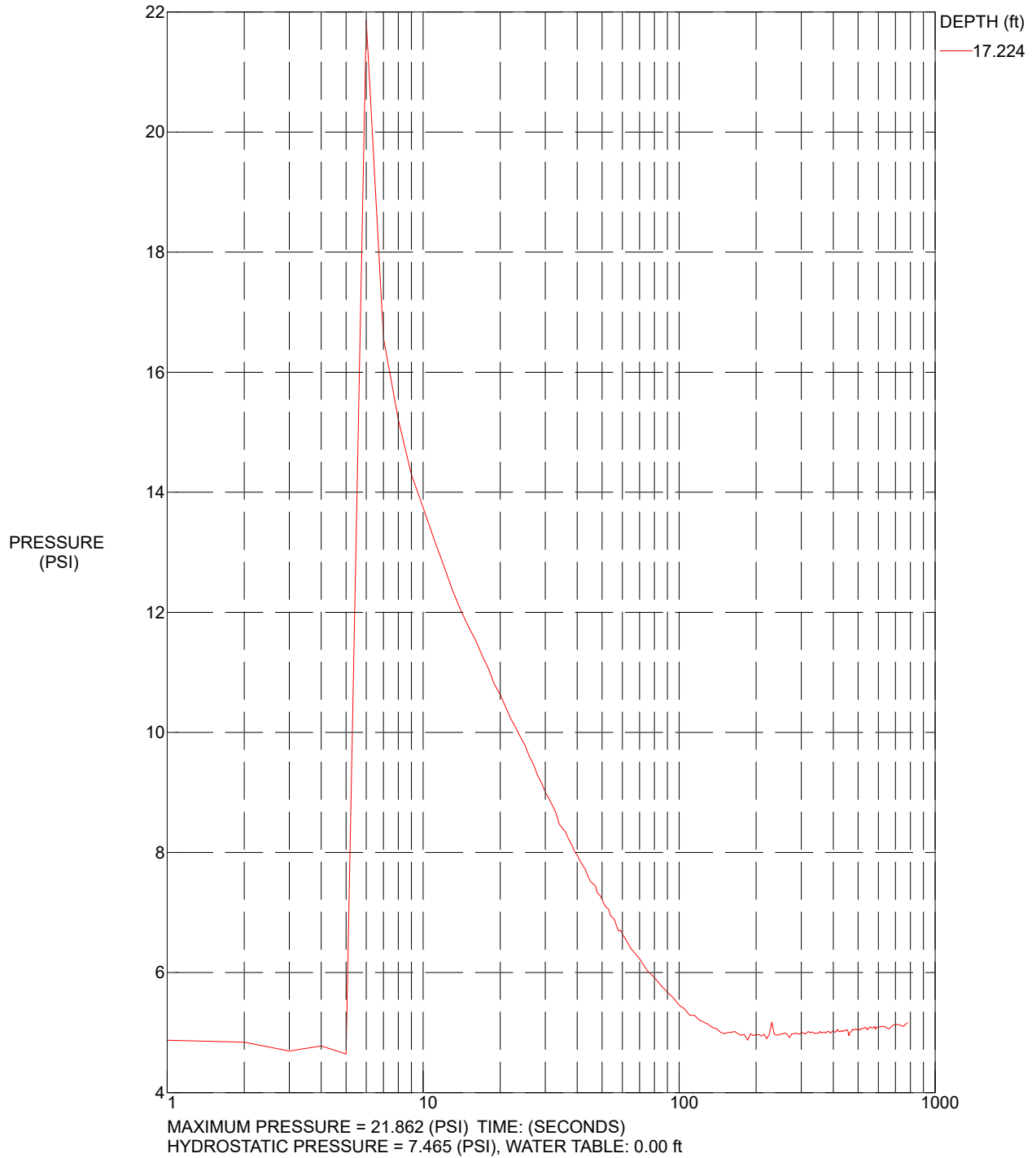

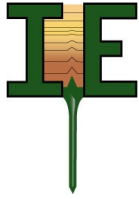

CPT-02

CPT CONTRACTOR: In Situ Engineering
 CUSTOMER: Terra Associates
 LOCATION: Puyallup
 JOB NUMBER: T-8565

OPERATOR: Mayfield/Okbay
 CONE ID: DDG1394
 TEST DATE: 7/8/2021 1:09:48 PM
 PREDRILL:
 BACKFILL: 20% Bentonite Grout + Bentonite Chip
 SURFACE PATCH:

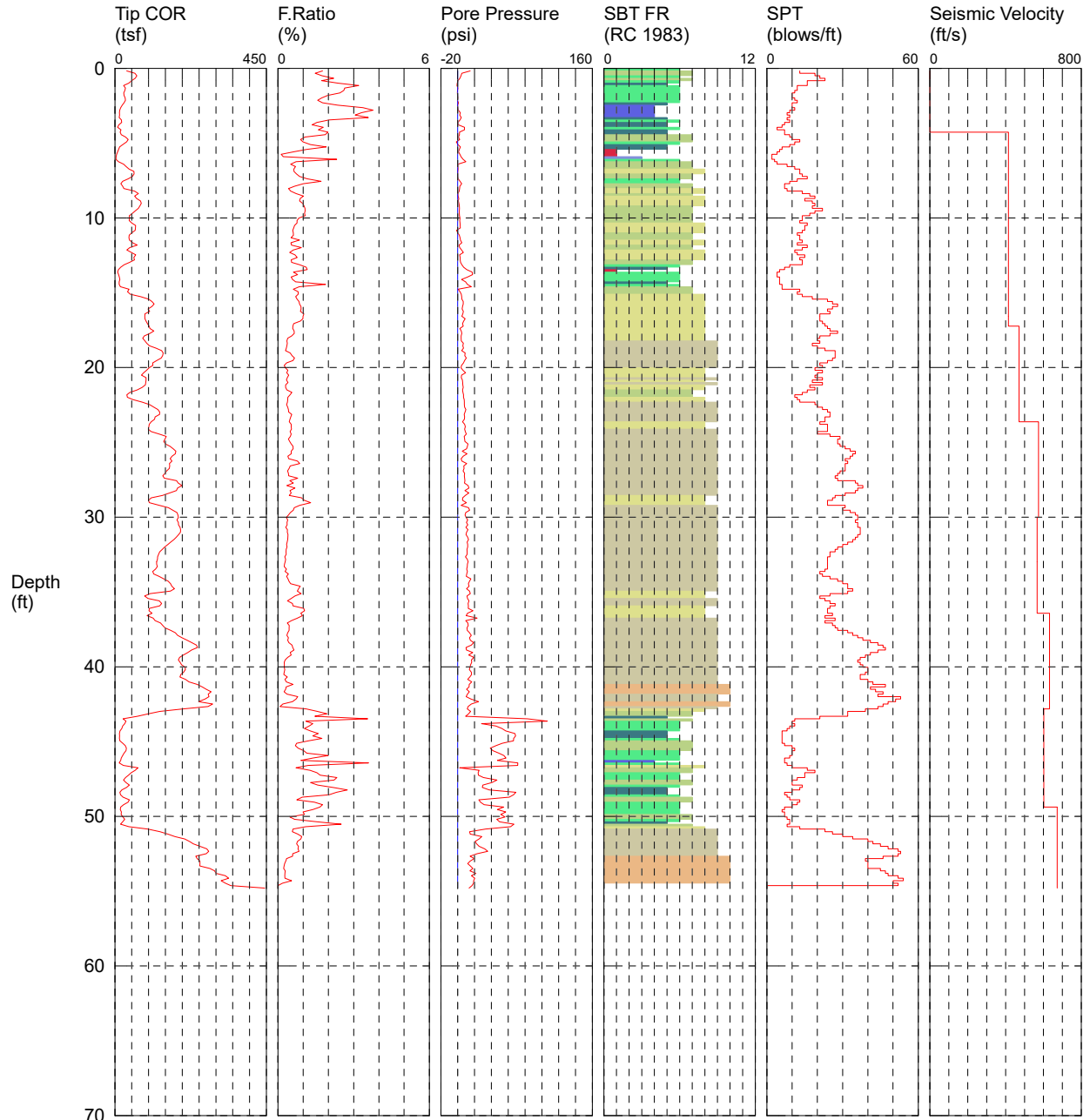

COMMENT:

- | | | | |
|---|---|--|--|
| <ul style="list-style-type: none"> ■ 1 sensitive fine grained ■ 2 organic material ■ 3 clay | <ul style="list-style-type: none"> ■ 4 silty clay to clay ■ 5 clayey silt to silty clay ■ 6 sandy silt to clayey silt | <ul style="list-style-type: none"> ■ 7 silty sand to sandy silt ■ 8 sand to silty sand ■ 9 sand | <ul style="list-style-type: none"> ■ 10 gravelly sand to sand ■ 11 very stiff fine grained (*) ■ 12 sand to clayey sand (*) |
|---|---|--|--|

*SBT/SPT CORRELATION: UBC-1983

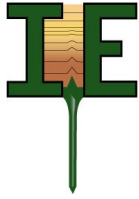

CPT-03

CPT CONTRACTOR: In Situ Engineering
 CUSTOMER: Terra Associates
 LOCATION: Puyallup
 JOB NUMBER: T-8565

OPERATOR: Mayfield/Okbay
 CONE ID: DDG1394
 TEST DATE: 7/8/2021 11:30:56 AM
 PREDRILL:
 BACKFILL: 20% Bentonite Grout + Bentonite Chip
 SURFACE PATCH:

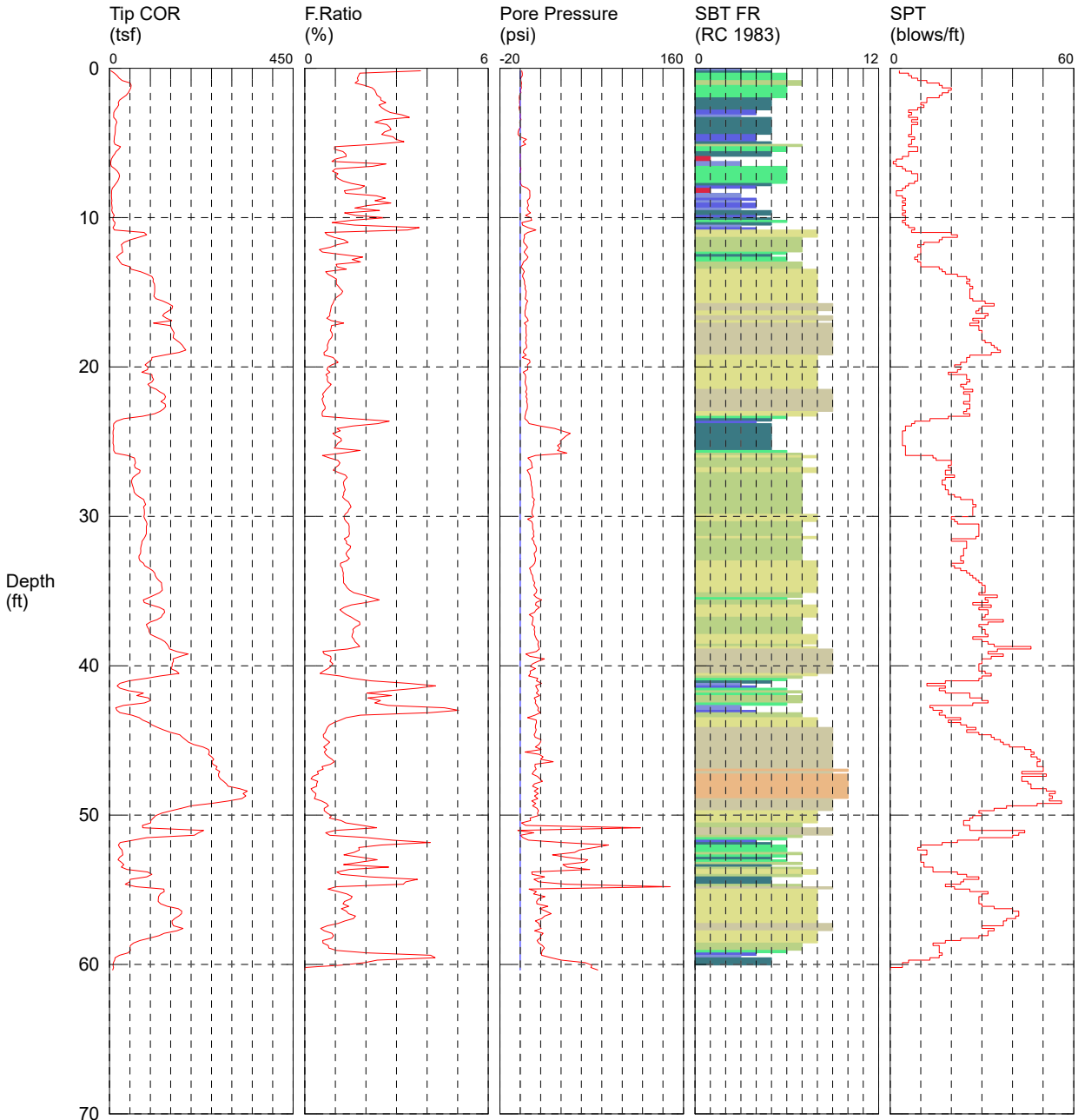

COMMENT:

- | | | | |
|--------------------------|-----------------------------|----------------------------|--------------------------------|
| 1 sensitive fine grained | 4 silty clay to clay | 7 silty sand to sandy silt | 10 gravelly sand to sand |
| 2 organic material | 5 clayey silt to silty clay | 8 sand to silty sand | 11 very stiff fine grained (*) |
| 3 clay | 6 sandy silt to clayey silt | 9 sand | 12 sand to clayey sand (*) |

*SBT/SPT CORRELATION: UBC-1983

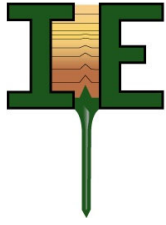

CPT-03

OPERATOR: Mayfield/Okbay
CUSTOMER: Terra Associates
LOCATION: Puyallup
JOB NUMBER: T-8565

CPT CONTRACTOR: In Situ Engineering
CONE ID: DDG1394
TEST DATE: 07/08/2021

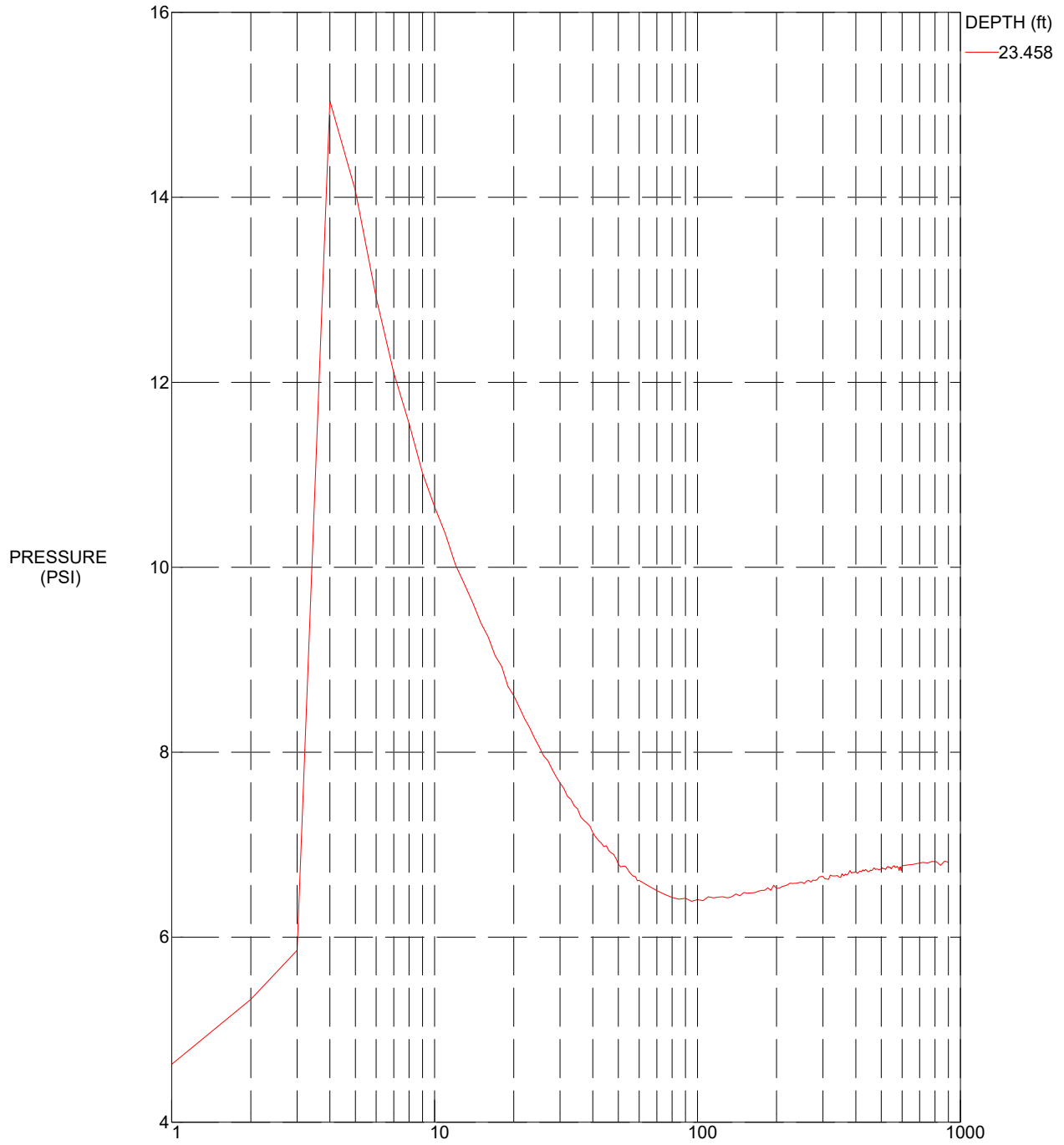

MAXIMUM PRESSURE = 15.041 (PSI) TIME: (SECONDS)
HYDROSTATIC PRESSURE = 10.167 (PSI), WATER TABLE: 0.00 ft

APPENDIX B
LIQUEFACTION ANALYSES

LIQUEFACTION ANALYSIS

Freeman Logistics

Hole No.=CPT-1 Water Depth=5.3 ft

Magnitude=7
Acceleration=0.6g

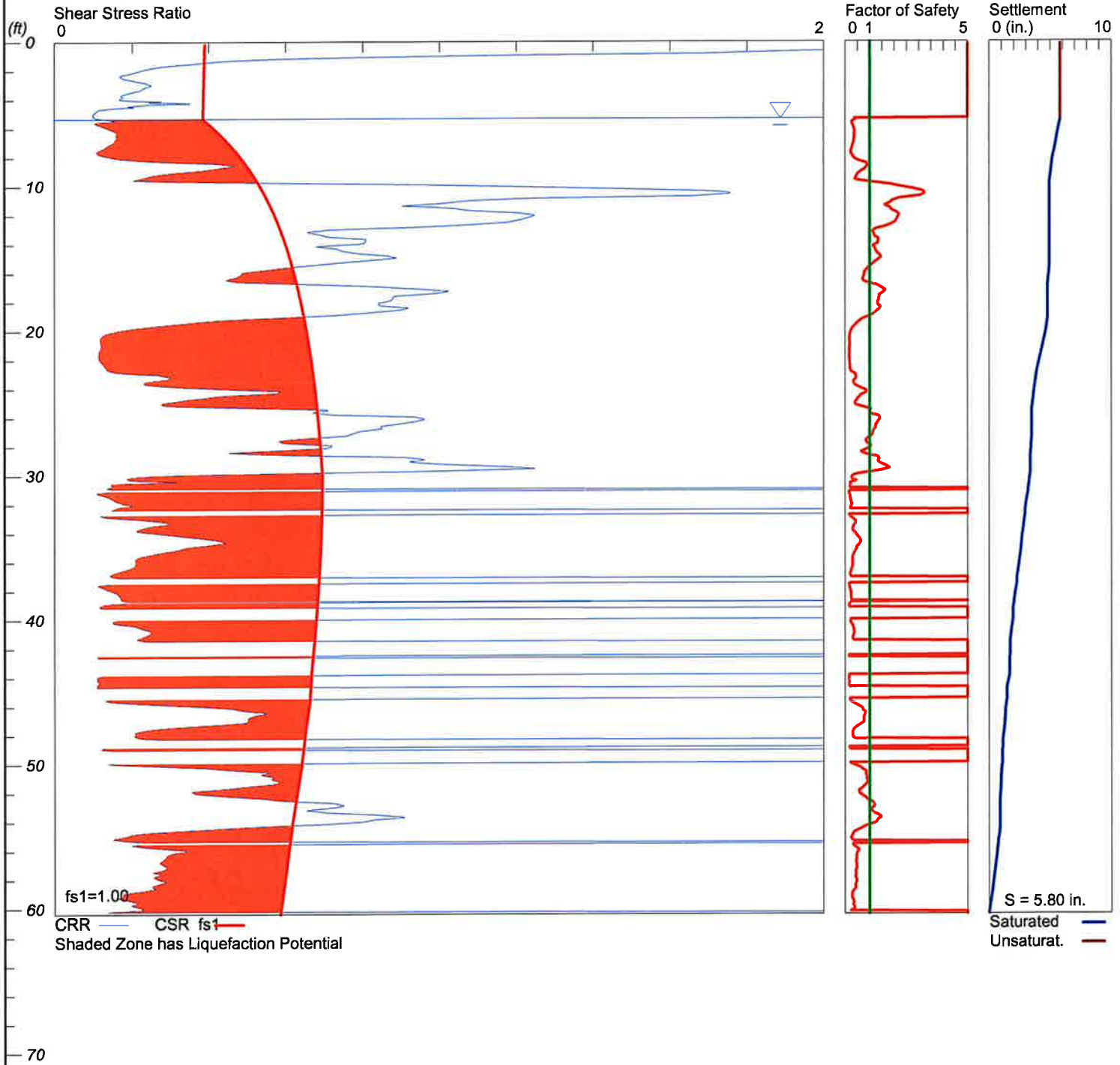

LiquefyPro CivilTech Software USA www.civiltech.com

LIQUEFACTION ANALYSIS

Freeman Logistics

Hole No.=CPT-2 Water Depth=7.5 ft

Magnitude=7
Acceleration=0.6g

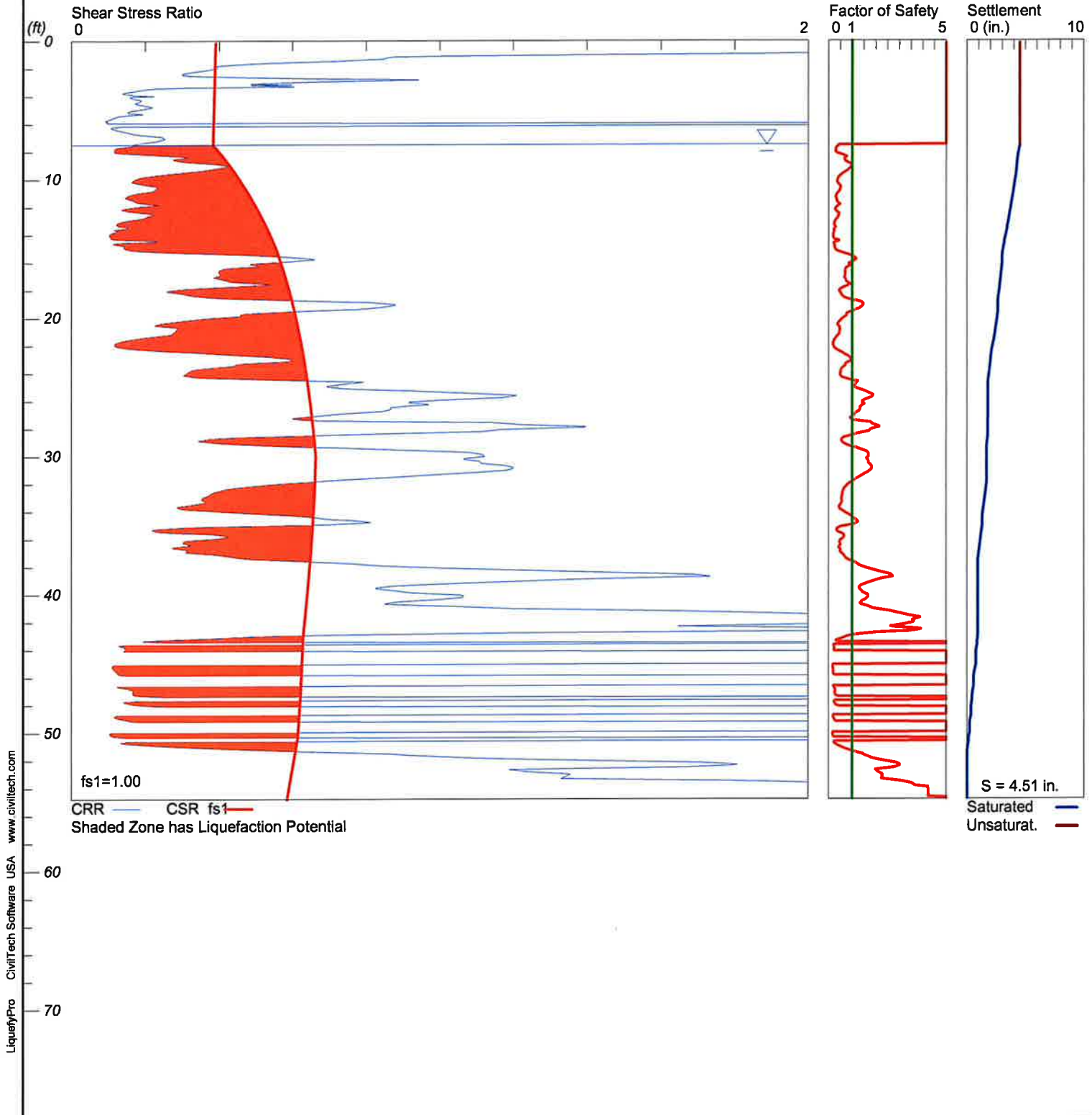

LiquifyPro CivilTech Software USA www.civiltech.com

LIQUEFACTION ANALYSIS

Freeman Logistics

Hole No.=CPT-3 Water Depth=7.7 ft

Magnitude=7
Acceleration=0.6g

