

ENGINEERING ANALYSIS FOR: EAST TOWN CROSSING APARTMENTS PIONEER & SHAW PUYALLUP, WA BUILDING E



PIERUCCIONI E&C, LLC
CHON PIERUCCIONI, PE
3128 N. BENNETT ST.
TACOMA, WA 98407

REUSE OF DOCUMENTS
THIS DOCUMENT AND THE SEALS AND SIGNS
INCORPORATED HEREIN ARE THE PROPERTY OF
PIERUCCIONI ENGINEERING, LLC. NO PART OF
THIS DOCUMENT SHALL BE REPRODUCED OR
TRANSMITTED IN ANY FORM OR BY ANY
MEANS, ELECTRONIC OR MECHANICAL,
INCLUDING PHOTOCOPYING, RECORDING,
OR BY ANY INFORMATION STORAGE AND
RETRIEVAL SYSTEM, WITHOUT THE
WRITTEN AUTHORIZATION OF PIERUCCIONI E&C, LLC.

EAST TOWN CROSSING
BUILDING "E"
PIONEER & SHAW PUYALLUP WA

DESIGN CRITERIA

BUILDING CODE: 2018 INTERNATIONAL BUILDING CODE (IBC) AS AMENDED BY THE LOCAL JURISDICTION.

VERTICAL LOADS

ROOF LIVE LOAD: 25 PSF (SNOW)
 ROOF DEAD LOAD: 25 PSF
 RESIDENTIAL FLOOR LIVE LOAD: 40 PSF (REDUCIBLE) : 60 PSF (FOR DECKS)
 STAIRWAY LANDING AREAS: 150 PSF (INCLUDING $l_p=1.5$)
 FLOOR DEAD LOAD: 30 PSF (INCLUDES 1 1/2" GYP TOPPING)
SNOW DESIGN DATA (ASCE 7-16) WIND DESIGN DATA (ASCE 7-16)
 FLAT SNOW LOAD: N/A BASIC WIND SPEED (ASD) $V=85$ MPH
 SNOW EXPOSURE FACTOR, $C_e=1.0$, ULTIMATE WIND SPEED $V=110$ MPH
 SNOW IMPORTANCE FACTOR, $I_s=1.0$, RISK CATEGORY: II EXPOSURE: B
 THERMAL FACTOR, $C_t=1.1$ IMPORTANCE FACTOR, $I_w=1.0$
 TOPOGRAPHIC FACTOR, $K_{zt}=1.0$

SEISMIC DESIGN DATA (ASCE7-16)

SEISMIC RESPONSE SYSTEM: WOOD SHEARWALLS
 EQUIVALENT LATERAL FORCE PROCEDURE (ASCE 7-16)
 RISK CATEGORY: II SEISMIC IMPORTANCE FACTOR, $I_e=1.0$
 MAPPED SPECTRAL RESPONSE ACCELERATION: $S_s=1.24$, $S_1=0.476$
 DESIGN SPECTRAL RESPONSE ACCELERATION: $S_{ds}=0.831$, $S_{d1}=0.476$
 SITE CLASS: D SEISMIC DESIGN CATEGORY: D
 SEISMIC RESPONSE COEFFICIENT: $C_s=0.091$
 DESIGN BASE SHEAR: 111,513#
SOIL PROPERTIES:
 BEARING CAPACITY: 2,000 PSF
 LATERAL CAPACITY: 250 PSF/FT

REVISIONS

A			---

REVISIONS

ENGINEER:	CP
CHECKED BY:	CP
DATE:	2024.01.12
TITLE:	STRUCTURAL ANALYSIS
PROJECT #:	----

2nd Floor Framing			
Member Name	Results (Max UTIL %)	Current Solution	Comments
Floor Joist 16' and Under	Passed (96% M)	1 piece(s) 11 7/8" TJI® 110 @ 16" OC	
Floor Joist 17'-8"	Passed (98% M)	1 piece(s) 11 7/8" TJI® 210 @ 16" OC	
Floor Joist 19'-4"	Passed (72% M)	1 piece(s) 11 7/8" TJI® 360 @ 16" OC	
Floor Joist 20'-7" (with offset 3rd flr.)	Passed (82% R)	2 piece(s) 11 7/8" TJI® 560 @ 16" OC	
Short Stair Stringers	Passed (68% R)	1 piece(s) 4 x 12 HF No.2	
Long Short Stair Stringers	Passed (98% ΔL)	1 piece(s) 3 1/2" x 12" 24F-V4 DF Glulam	
Top Landing Beam	Passed (98% R)	1 piece(s) 5 1/2" x 13 1/2" 24F-V4 DF Glulam	
10'-10" Deck Joist	Passed (71% R)	1 piece(s) 2 x 12 HF No.2 @ 16" OC	
Deck Cantilever Ledger 2'	Passed (47% R)	2 piece(s) 2 x 12 HF No.2	
Grid 2.6 (F-G.3) Flush Beam	Passed (85% R)	1 piece(s) 5 1/2" x 11 7/8" 24F-V4 DF Glulam	
Grid 2.6 (G.9-H.8) Flush Beam	Passed (92% R)	1 piece(s) 5 1/2" x 11 7/8" 24F-V4 DF Glulam	
Grid 2.4 (H.8-I.8) Door Header	Passed (46% R)	1 piece(s) 4 x 8 DF No.2	
Grid 2.4 (J.2-K.8) Door Header	Passed (73% M)	1 piece(s) 4 x 8 DF No.2	
Grid 5.5 (H-H.8) Door Header	Passed (77% R)	1 piece(s) 4 x 8 DF No.2	
Grid 5.5 (G.1-G.3) Flush Beam	Passed (62% R)	1 piece(s) 3 1/2" x 11 7/8" 24F-V4 DF Glulam	
Grid G.1 (5.2-5.3) Door Header	Passed (45% R)	1 piece(s) 4 x 8 DF No.2	
Grid 6 (G.1-G.3) Flush Beam	Passed (69% R)	1 piece(s) 3 1/2" x 11 7/8" 24F-V4 DF Glulam	
Grid 2.5 (D.4-D.6) Flush Beam	Passed (86% R)	1 piece(s) 3 1/2" x 11 7/8" 24F-V4 DF Glulam	
Grid 3.3 (D.8-E.1) Flush Beam	Passed (87% R)	1 piece(s) 3 1/2" x 11 7/8" 24F-V4 DF Glulam	
Grid 5.3 (D.5-E.2) Flush Beam	Passed (90% R)	1 piece(s) 3 1/2" x 11 7/8" 24F-V4 DF Glulam	
Grid 6 (D.3-D.6) Flush Beam	Passed (96% R)	1 piece(s) 3 1/2" x 11 7/8" 24F-V4 DF Glulam	

3rd Floor Framing			
Member Name	Results (Max UTIL %)	Current Solution	Comments
Floor Joist 16' and Under	Passed (96% M)	1 piece(s) 11 7/8" TJI® 110 @ 16" OC	
Floor Joist 17'-8"	Passed (98% M)	1 piece(s) 11 7/8" TJI® 210 @ 16" OC	
Floor Joist 19'-4"	Passed (72% M)	1 piece(s) 11 7/8" TJI® 360 @ 16" OC	
Floor Joist 20'-7"	Passed (59% ΔT)	1 piece(s) 11 7/8" TJI® 560 @ 16" OC	
7'-6" Landing Joists	Passed (100% R)	1 piece(s) 2 x 12 HF No.2 @ 16" OC	
Top Landing Beam	Passed (99% ΔL)	1 piece(s) 5 1/2" x 12" 24F-V4 DF Glulam	
Short Stair Stringers	Passed (68% R)	1 piece(s) 4 x 12 HF No.2	
4' Mid Landing Joists	Passed (49% R)	1 piece(s) 2 x 12 HF No.2 @ 16" OC	
Mid Landing Beam	Passed (100% ΔL)	1 piece(s) 3 1/2" x 12" 24F-V4 DF Glulam	
10'-10" Deck Joist	Passed (71% R)	1 piece(s) 2 x 12 HF No.2 @ 16" OC	
Deck Cantilever Ledger 2'	Passed (47% R)	2 piece(s) 2 x 12 HF No.2	
6' Window Header	Passed (17% M)	1 piece(s) 4 x 10 DF No.2	
Grid 2.6 (F-G.5) Flush Beam	Passed (76% M+)	1 piece(s) 5 1/2" x 11 7/8" 24F-V4 DF Glulam	
Grid 2.6 (H-H.8) Flush Beam	Passed (64% R)	1 piece(s) 3 1/2" x 11 7/8" 24F-V4 DF Glulam	
Grid 2.4 (H.8-I.8) Door Header	Passed (46% R)	1 piece(s) 4 x 8 DF No.2	
Grid 2.4 (J.2-K.8) Door Header	Passed (73% M)	1 piece(s) 4 x 8 DF No.2	
Grid 5.5 (H-H.8) Door Header	Passed (34% R)	1 piece(s) 4 x 8 DF No.2	
Grid 5.5 (G.4-G.8) Door Header	Passed (89% M)	1 piece(s) 4 x 8 DF No.2	
Grid 5.5 (G.1-G.3) Flush Beam	Passed (31% R)	1 piece(s) 3 1/2" x 11 7/8" 24F-V4 DF Glulam	
Grid G.1 (5.2-5.3) Door Header	Passed (31% V)	1 piece(s) 4 x 8 DF No.2	
Grid 6 (G.1-G.3) Flush Beam	Passed (34% R)	1 piece(s) 3 1/2" x 11 7/8" 24F-V4 DF Glulam	
Grid 2.5 (D.4-D.6) Flush Beam	Passed (52% R)	1 piece(s) 3 1/2" x 11 7/8" 24F-V4 DF Glulam	
Grid 3.3 (D.8-E.1) Flush Beam	Passed (43% R)	1 piece(s) 3 1/2" x 11 7/8" 24F-V4 DF Glulam	
Grid 5.3 (D.5-E.2) Flush Beam	Passed (90% R)	1 piece(s) 3 1/2" x 11 7/8" 24F-V4 DF Glulam	
Grid 6 (D.3-D.6) Flush Beam	Passed (48% R)	1 piece(s) 3 1/2" x 11 7/8" 24F-V4 DF Glulam	

Forteweb Software Operator	Job Notes
Chon Pieruccioni Pieruccioni Engineering (206) 949-7866 cpieru@hotmail.com	



Roof Framing			
Member Name	Results (Max UTIL %)	Current Solution	Comments
Grid I Entry Roof Beam	Passed (91% R)	1 piece(s) 3 1/2" x 10 1/2" 24F-V4 DF Glulam	
Grid L 10' Deck Roof Beam	Passed (101% R)	1 piece(s) 3 1/2" x 10 1/2" 24F-V4 DF Glulam	
6' Window Header	Passed (90% R)	1 piece(s) 4 x 10 DF No.2	
Grid B 11' Deck Roof Beam	Passed (100% R)	1 piece(s) 3 1/2" x 10 1/2" 24F-V4 DF Glulam	
Deck Roof Cantilever Beam	Failed (81% R) Passed	1 piece(s) 5 1/2" x 10 1/2" 24F-V4 DF Glulam	An excessive uplift of -2576 lbs at support located at 4" failed this product.

ForteWEB Software Operator	Job Notes
Chon Pieruccioni Pieruccioni Engineering (206) 949-7866 cpieru@hotmail.com	



3/7/2024 3:51:26 PM UTC
ForteWEB v3.7
File Name: East Town Crossing Building E

2nd Floor Framing, Floor Joist 16' and Under
1 piece(s) 11 7/8" TJI® 110 @ 16" OC

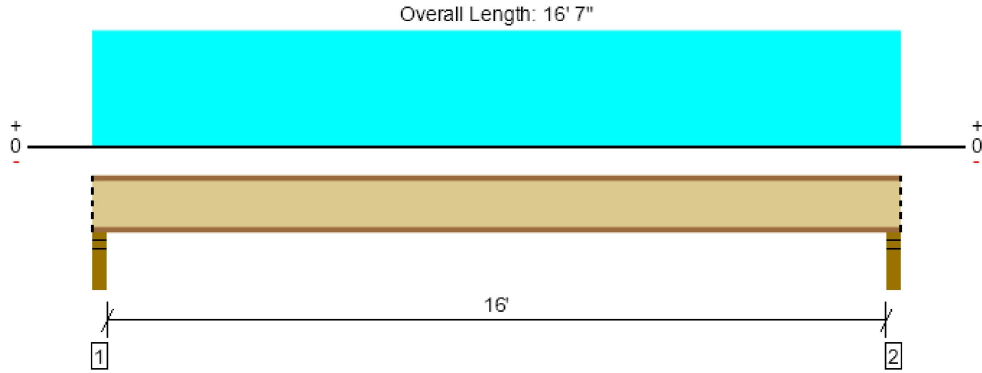

Drawing is Conceptual. All locations are measured from the outside face of left support (or left cantilever end). All dimensions are horizontal.

Design Results	Actual @ Location	Allowed	Result	LDF	Load: Combination (Pattern)
Member Reaction (lbs)	774 @ 2 1/2"	1375 (3.50")	Passed (56%)	1.00	1.0 D + 1.0 L (All Spans)
Shear (lbs)	747 @ 3 1/2"	1560	Passed (48%)	1.00	1.0 D + 1.0 L (All Spans)
Moment (Ft-lbs)	3049 @ 8' 3 1/2"	3160	Passed (96%)	1.00	1.0 D + 1.0 L (All Spans)
Live Load Defl. (in)	0.275 @ 8' 3 1/2"	0.539	Passed (L/704)	--	1.0 D + 1.0 L (All Spans)
Total Load Defl. (in)	0.482 @ 8' 3 1/2"	0.808	Passed (L/403)	--	1.0 D + 1.0 L (All Spans)
TJ-Pro™ Rating	48	40	Passed	--	--

Member Length : 16' 7"
 System : Floor
 Member Type : Joist
 Building Use : Residential
 Building Code : IBC 2018
 Design Methodology : ASD

- Deflection criteria: LL (L/360) and TL (L/240).
- Allowed moment does not reflect the adjustment for the beam stability factor.
- A structural analysis of the deck has not been performed.
- Deflection analysis is based on composite action with a single layer of 23/32" Weyerhaeuser Edge™ Panel (24" Span Rating) that is glued and nailed down.
- Additional considerations for the TJ-Pro™ Rating include: 5/8" Gypsum ceiling.

Supports	Bearing Length			Loads to Supports (lbs)			Accessories
	Total	Available	Required	Dead	Floor Live	Factored	
1 - Stud wall - HF	3.50"	3.50"	1.75"	332	442	774	Blocking
2 - Stud wall - HF	3.50"	3.50"	1.75"	332	442	774	Blocking

• Blocking Panels are assumed to carry no loads applied directly above them and the full load is applied to the member being designed.

Lateral Bracing	Bracing Intervals	Comments
Top Edge (Lu)	3' 1" o/c	
Bottom Edge (Lu)	16' 7" o/c	

- TJI joists are only analyzed using Maximum Allowable bracing solutions.
- Maximum allowable bracing intervals based on applied load.

Vertical Load	Location	Spacing	Dead (0.90)	Floor Live (1.00)	Comments
1 - Uniform (PSF)	0 to 16' 7"	16"	30.0	40.0	Default Load

Weyerhaeuser Notes
 Weyerhaeuser warrants that the sizing of its products will be in accordance with Weyerhaeuser product design criteria and published design values. Weyerhaeuser expressly disclaims any other warranties related to the software. Use of this software is not intended to circumvent the need for a design professional as determined by the authority having jurisdiction. The designer of record, builder or framer is responsible to assure that this calculation is compatible with the overall project. Accessories (Rim Board, Blocking Panels and Squash Blocks) are not designed by this software. Products manufactured at Weyerhaeuser facilities are third-party certified to sustainable forestry standards. Weyerhaeuser Engineered Lumber Products have been evaluated by ICC-ES under evaluation reports ESR-1153 and ESR-1387 and/or tested in accordance with applicable ASTM standards. For current code evaluation reports, Weyerhaeuser product literature and installation details refer to www.weyerhaeuser.com/woodproducts/document-library.
 The product application, input design loads, dimensions and support information have been provided by ForteWEB Software Operator

ForteWEB Software Operator	Job Notes
Chon Pieruccioni Pieruccioni Engineering (206) 949-7866 cpieru@hotmail.com	



2nd Floor Framing, Floor Joist 17'-8"
1 piece(s) 11 7/8" TJI@ 210 @ 16" OC

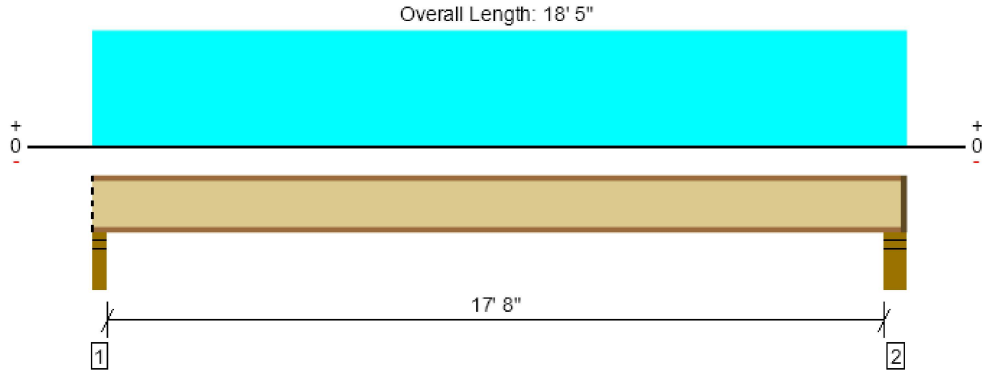

Drawing is Conceptual. All locations are measured from the outside face of left support (or left cantilever end). All dimensions are horizontal.

Design Results	Actual @ Location	Allowed	Result	LDF	Load: Combination (Pattern)
Member Reaction (lbs)	856 @ 18' 1/2"	1460 (3.50")	Passed (59%)	1.00	1.0 D + 1.0 L (All Spans)
Shear (lbs)	824 @ 3 1/2"	1655	Passed (50%)	1.00	1.0 D + 1.0 L (All Spans)
Moment (Ft-lbs)	3710 @ 9' 1 1/2"	3795	Passed (98%)	1.00	1.0 D + 1.0 L (All Spans)
Live Load Defl. (in)	0.352 @ 9' 1 1/2"	0.594	Passed (L/609)	--	1.0 D + 1.0 L (All Spans)
Total Load Defl. (in)	0.615 @ 9' 1 1/2"	0.892	Passed (L/348)	--	1.0 D + 1.0 L (All Spans)
TJ-Pro™ Rating	44	40	Passed	--	--

Member Length : 18' 3 1/2"
 System : Floor
 Member Type : Joist
 Building Use : Residential
 Building Code : IBC 2018
 Design Methodology : ASD

- Deflection criteria: LL (L/360) and TL (L/240).
- Allowed moment does not reflect the adjustment for the beam stability factor.
- A structural analysis of the deck has not been performed.
- Deflection analysis is based on composite action with a single layer of 23/32" Weyerhaeuser Edge™ Panel (24" Span Rating) that is glued and nailed down.
- Additional considerations for the TJ-Pro™ Rating include: 5/8" Gypsum ceiling.

Supports	Bearing Length			Loads to Supports (lbs)			Accessories
	Total	Available	Required	Dead	Floor Live	Factored	
1 - Stud wall - HF	3.50"	3.50"	1.75"	365	487	852	Blocking
2 - Stud wall - HF	5.50"	4.00"	1.75"	372	496	867	1 1/2" Rim Board

- Rim Board is assumed to carry all loads applied directly above it, bypassing the member being designed.
- Blocking Panels are assumed to carry no loads applied directly above them and the full load is applied to the member being designed.

Lateral Bracing	Bracing Intervals	Comments
Top Edge (Lu)	3' 7" o/c	
Bottom Edge (Lu)	18' 4" o/c	

- TJI joists are only analyzed using Maximum Allowable bracing solutions.
- Maximum allowable bracing intervals based on applied load.

Vertical Load	Location	Spacing	Dead (0.90)	Floor Live (1.00)	Comments
1 - Uniform (PSF)	0 to 18' 5"	16"	30.0	40.0	Default Load

Weyerhaeuser Notes

Weyerhaeuser warrants that the sizing of its products will be in accordance with Weyerhaeuser product design criteria and published design values. Weyerhaeuser expressly disclaims any other warranties related to the software. Use of this software is not intended to circumvent the need for a design professional as determined by the authority having jurisdiction. The designer of record, builder or framer is responsible to assure that this calculation is compatible with the overall project. Accessories (Rim Board, Blocking Panels and Squash Blocks) are not designed by this software. Products manufactured at Weyerhaeuser facilities are third-party certified to sustainable forestry standards. Weyerhaeuser Engineered Lumber Products have been evaluated by ICC-ES under evaluation reports ESR-1153 and ESR-1387 and/or tested in accordance with applicable ASTM standards. For current code evaluation reports, Weyerhaeuser product literature and installation details refer to www.weyerhaeuser.com/woodproducts/document-library.

The product application, input design loads, dimensions and support information have been provided by ForteWEB Software Operator

ForteWEB Software Operator	Job Notes
Chon Pieruccioni Pieruccioni Engineering (206) 949-7866 cpieru@hotmail.com	



2nd Floor Framing, Floor Joist 19'-4"
1 piece(s) 11 7/8" TJI® 360 @ 16" OC

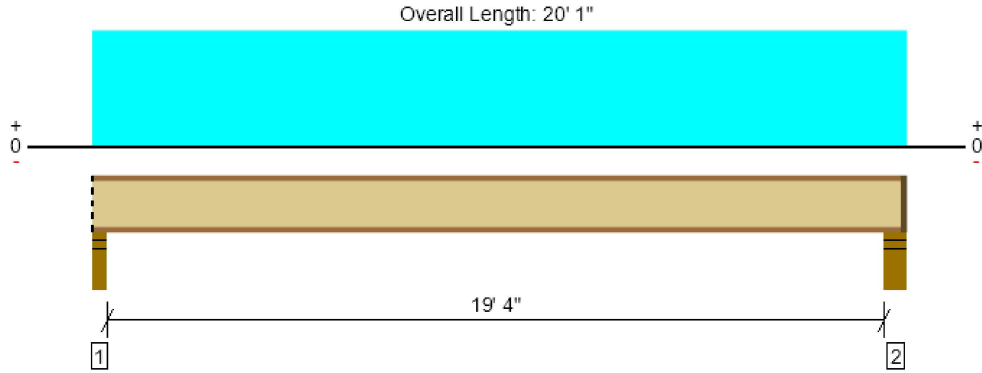

Drawing is Conceptual. All locations are measured from the outside face of left support (or left cantilever end). All dimensions are horizontal.

Design Results	Actual @ Location	Allowed	Result	LDF	Load: Combination (Pattern)
Member Reaction (lbs)	933 @ 19' 8 1/2"	1505 (3.50")	Passed (62%)	1.00	1.0 D + 1.0 L (All Spans)
Shear (lbs)	902 @ 3 1/2"	1705	Passed (53%)	1.00	1.0 D + 1.0 L (All Spans)
Moment (Ft-lbs)	4436 @ 9' 11 1/2"	6180	Passed (72%)	1.00	1.0 D + 1.0 L (All Spans)
Live Load Defl. (in)	0.395 @ 9' 11 1/2"	0.650	Passed (L/593)	--	1.0 D + 1.0 L (All Spans)
Total Load Defl. (in)	0.691 @ 9' 11 1/2"	0.975	Passed (L/339)	--	1.0 D + 1.0 L (All Spans)
TJ-Pro™ Rating	43	40	Passed	--	--

Member Length : 19' 11 1/2"
 System : Floor
 Member Type : Joist
 Building Use : Residential
 Building Code : IBC 2018
 Design Methodology : ASD

- Deflection criteria: LL (L/360) and TL (L/240).
- Allowed moment does not reflect the adjustment for the beam stability factor.
- A structural analysis of the deck has not been performed.
- Deflection analysis is based on composite action with a single layer of 23/32" Weyerhaeuser Edge™ Panel (24" Span Rating) that is glued and nailed down.
- Additional considerations for the TJ-Pro™ Rating include: 5/8" Gypsum ceiling.

Supports	Bearing Length			Loads to Supports (lbs)			Accessories
	Total	Available	Required	Dead	Floor Live	Factored	
1 - Stud wall - HF	3.50"	3.50"	1.75"	398	531	929	Blocking
2 - Stud wall - HF	5.50"	4.00"	1.75"	405	540	945	1 1/2" Rim Board

- Rim Board is assumed to carry all loads applied directly above it, bypassing the member being designed.
- Blocking Panels are assumed to carry no loads applied directly above them and the full load is applied to the member being designed.

Lateral Bracing	Bracing Intervals	Comments
Top Edge (Lu)	4' 4" o/c	
Bottom Edge (Lu)	20' o/c	

- TJI joists are only analyzed using Maximum Allowable bracing solutions.
- Maximum allowable bracing intervals based on applied load.

Vertical Load	Location	Spacing	Dead (0.90)	Floor Live (1.00)	Comments
1 - Uniform (PSF)	0 to 20' 1"	16"	30.0	40.0	Default Load

Weyerhaeuser Notes

Weyerhaeuser warrants that the sizing of its products will be in accordance with Weyerhaeuser product design criteria and published design values. Weyerhaeuser expressly disclaims any other warranties related to the software. Use of this software is not intended to circumvent the need for a design professional as determined by the authority having jurisdiction. The designer of record, builder or framer is responsible to assure that this calculation is compatible with the overall project. Accessories (Rim Board, Blocking Panels and Squash Blocks) are not designed by this software. Products manufactured at Weyerhaeuser facilities are third-party certified to sustainable forestry standards. Weyerhaeuser Engineered Lumber Products have been evaluated by ICC-ES under evaluation reports ESR-1153 and ESR-1387 and/or tested in accordance with applicable ASTM standards. For current code evaluation reports, Weyerhaeuser product literature and installation details refer to www.weyerhaeuser.com/woodproducts/document-library.

The product application, input design loads, dimensions and support information have been provided by ForteWEB Software Operator

ForteWEB Software Operator	Job Notes
Chon Pieruccioni Pieruccioni Engineering (206) 949-7866 cpieru@hotmail.com	



2nd Floor Framing, Floor Joist 20'-7" (with offset 3rd flr.)
2 piece(s) 11 7/8" TJI@ 560 @ 16" OC

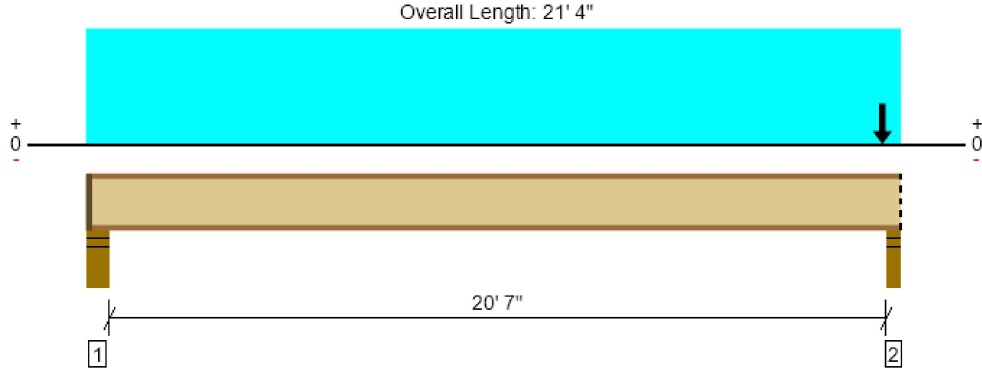

Drawing is Conceptual. All locations are measured from the outside face of left support (or left cantilever end). All dimensions are horizontal.

Design Results	Actual @ Location	Allowed	Result	LDF	Load: Combination (Pattern)
Member Reaction (lbs)	2825 @ 21' 1 1/2"	3450 (3.50")	Passed (82%)	1.00	1.0 D + 1.0 L (All Spans)
Shear (lbs)	2798 @ 21' 1/2"	4100	Passed (68%)	1.00	1.0 D + 1.0 L (All Spans)
Moment (Ft-lbs)	5279 @ 11' 1/8"	19000	Passed (28%)	1.00	1.0 D + 1.0 L (All Spans)
Live Load Defl. (in)	0.196 @ 10' 9 15/16"	0.692	Passed (L/999+)	--	1.0 D + 1.0 L (All Spans)
Total Load Defl. (in)	0.343 @ 10' 9 15/16"	1.038	Passed (L/727)	--	1.0 D + 1.0 L (All Spans)
TJ-Pro™ Rating	56	40	Passed	--	--

Member Length : 21' 2 1/2"
 System : Floor
 Member Type : Joist
 Building Use : Residential
 Building Code : IBC 2018
 Design Methodology : ASD

- Deflection criteria: LL (L/360) and TL (L/240).
- Allowed moment does not reflect the adjustment for the beam stability factor.
- A structural analysis of the deck has not been performed.
- Deflection analysis is based on composite action with a single layer of 23/32" Weyerhaeuser Edge™ Panel (24" Span Rating) that is glued and nailed down.
- Additional considerations for the TJ-Pro™ Rating include: 5/8" Gypsum ceiling.

Supports	Bearing Length			Loads to Supports (lbs)			Accessories
	Total	Available	Required	Dead	Floor Live	Factored	
1 - Stud wall - HF	5.50"	4.00"	1.75"	440	587	1028	1 1/2" Rim Board
2 - Stud wall - HF	3.50"	3.50"	2.31"	1211	1615	2825	Blocking

- Rim Board is assumed to carry all loads applied directly above it, bypassing the member being designed.
- Blocking Panels are assumed to carry no loads applied directly above them and the full load is applied to the member being designed.

Lateral Bracing	Bracing Intervals	Comments
Top Edge (Lu)	11' o/c	
Bottom Edge (Lu)	21' 3" o/c	

- TJI joists are only analyzed using Maximum Allowable bracing solutions.
- Maximum allowable bracing intervals based on applied load.

Vertical Loads	Location	Spacing	Dead (0.90)	Floor Live (1.00)	Comments
1 - Uniform (PSF)	0 to 21' 4"	16"	30.0	40.0	2nd floor load
2 - Point (lb)	20' 10 1/4"	N/A	798	1064	3rd Floor offset wall load

Weyerhaeuser Notes
 Weyerhaeuser warrants that the sizing of its products will be in accordance with Weyerhaeuser product design criteria and published design values. Weyerhaeuser expressly disclaims any other warranties related to the software. Use of this software is not intended to circumvent the need for a design professional as determined by the authority having jurisdiction. The designer of record, builder or framer is responsible to assure that this calculation is compatible with the overall project. Accessories (Rim Board, Blocking Panels and Squash Blocks) are not designed by this software. Products manufactured at Weyerhaeuser facilities are third-party certified to sustainable forestry standards. Weyerhaeuser Engineered Lumber Products have been evaluated by ICC-ES under evaluation reports ESR-1153 and ESR-1387 and/or tested in accordance with applicable ASTM standards. For current code evaluation reports, Weyerhaeuser product literature and installation details refer to www.weyerhaeuser.com/woodproducts/document-library.
 The product application, input design loads, dimensions and support information have been provided by ForteWEB Software Operator

ForteWEB Software Operator	Job Notes
Chon Pieruccioni Pieruccioni Engineering (206) 949-7866 cpieru@hotmail.com	



2nd Floor Framing, Short Stair Stringers
1 piece(s) 4 x 12 HF No.2

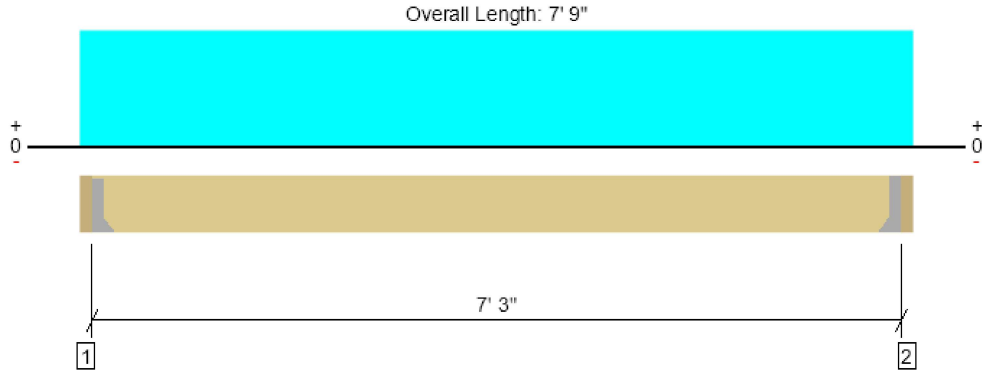

Drawing is Conceptual. All locations are measured from the outside face of left support (or left cantilever end). All dimensions are horizontal.

Design Results	Actual @ Location	Allowed	Result	LDF	Load: Combination (Pattern)
Member Reaction (lbs)	1450 @ 3"	2126 (1.50")	Passed (68%)	--	1.0 D + 1.0 L (All Spans)
Shear (lbs)	1075 @ 1' 2 1/4"	3938	Passed (27%)	1.00	1.0 D + 1.0 L (All Spans)
Moment (Ft-lbs)	2628 @ 3' 10 1/2"	5752	Passed (46%)	1.00	1.0 D + 1.0 L (All Spans)
Live Load Defl. (in)	0.035 @ 3' 10 1/2"	0.181	Passed (L/999+)	--	1.0 D + 1.0 L (All Spans)
Total Load Defl. (in)	0.046 @ 3' 10 1/2"	0.363	Passed (L/999+)	--	1.0 D + 1.0 L (All Spans)

Member Length : 7' 3"
 System : Floor
 Member Type : Flush Beam
 Building Use : Residential
 Building Code : IBC 2018
 Design Methodology : ASD

- Deflection criteria: LL (L/480) and TL (L/240).
- Allowed moment does not reflect the adjustment for the beam stability factor.
- Applicable calculations are based on NDS.

Supports	Bearing Length			Loads to Supports (lbs)			Accessories
	Total	Available	Required	Dead	Floor Live	Factored	
1 - Hanger on 11 1/4" GLB beam	3.00"	Hanger ¹	1.50"	385	1163	1547	See note ¹
2 - Hanger on 11 1/4" GLB beam	3.00"	Hanger ¹	1.50"	385	1163	1547	See note ¹

- At hanger supports, the Total Bearing dimension is equal to the width of the material that is supporting the hanger
- ¹ See Connector grid below for additional information and/or requirements.

Lateral Bracing	Bracing Intervals	Comments
Top Edge (Lu)	7' 3" o/c	
Bottom Edge (Lu)	7' 3" o/c	

•Maximum allowable bracing intervals based on applied load.

Connector: Simpson Strong-Tie							
Support	Model	Seat Length	Top Fasteners	Face Fasteners	Member Fasteners	Accessories	
1 - Face Mount Hanger	LUS410	2.00"	N/A	8-10d	6-10d		
2 - Face Mount Hanger	LUS410	2.00"	N/A	8-10d	6-10d		

• Refer to manufacturer notes and instructions for proper installation and use of all connectors.

Vertical Loads	Location (Side)	Tributary Width	Dead (0.90)	Floor Live (1.00)	Comments
0 - Self Weight (PLF)	3" to 7' 6"	N/A	10.0	--	
1 - Uniform (PSF)	0 to 7' 9" (Front)	2'	45.0	150.0	Default Load

Weyerhaeuser Notes

Weyerhaeuser warrants that the sizing of its products will be in accordance with Weyerhaeuser product design criteria and published design values. Weyerhaeuser expressly disclaims any other warranties related to the software. Use of this software is not intended to circumvent the need for a design professional as determined by the authority having jurisdiction. The designer of record, builder or framer is responsible to assure that this calculation is compatible with the overall project. Accessories (Rim Board, Blocking Panels and Squash Blocks) are not designed by this software. Products manufactured at Weyerhaeuser facilities are third-party certified to sustainable forestry standards. Weyerhaeuser Engineered Lumber Products have been evaluated by ICC-ES under evaluation reports ESR-1153 and ESR-1387 and/or tested in accordance with applicable ASTM standards. For current code evaluation reports, Weyerhaeuser product literature and installation details refer to www.weyerhaeuser.com/woodproducts/document-library.

The product application, input design loads, dimensions and support information have been provided by ForteWEB Software Operator

ForteWEB Software Operator	Job Notes
Chon Pieruccini Pieruccini Engineering (206) 949-7866 cpieru@hotmail.com	



2nd Floor Framing, Long Short Stair Stringers
1 piece(s) 3 1/2" x 12" 24F-V4 DF Glulam

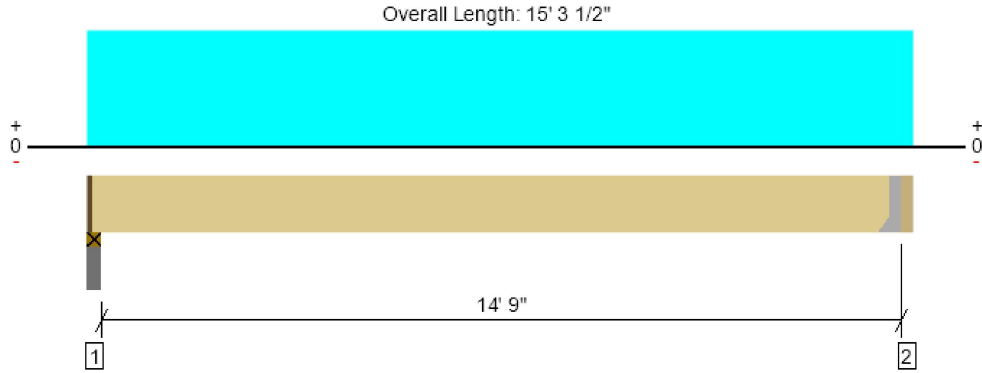

Drawing is Conceptual. All locations are measured from the outside face of left support (or left cantilever end). All dimensions are horizontal.

Design Results	Actual @ Location	Allowed	Result	LDF	Load: Combination (Pattern)
Member Reaction (lbs)	3002 @ 2"	3189 (2.25")	Passed (94%)	--	1.0 D + 1.0 L (All Spans)
Shear (lbs)	2576 @ 14' 1/2"	7420	Passed (35%)	1.00	1.0 D + 1.0 L (All Spans)
Pos Moment (Ft-lbs)	11069 @ 7' 7 1/4"	16800	Passed (66%)	1.00	1.0 D + 1.0 L (All Spans)
Live Load Defl. (in)	0.364 @ 7' 7 1/4"	0.372	Passed (L/490)	--	1.0 D + 1.0 L (All Spans)
Total Load Defl. (in)	0.486 @ 7' 7 1/4"	0.744	Passed (L/367)	--	1.0 D + 1.0 L (All Spans)

Member Length : 14' 11 1/4"
 System : Floor
 Member Type : Flush Beam
 Building Use : Residential
 Building Code : IBC 2018
 Design Methodology : ASD

- Deflection criteria: LL (L/480) and TL (L/240).
- Allowed moment does not reflect the adjustment for the beam stability factor.
- Critical positive moment adjusted by a volume/size factor of 1.00 that was calculated using length L = 14' 10 1/2".
- The effects of positive or negative camber have not been accounted for when calculating deflection.
- The specified glulam is assumed to have its strong laminations at the bottom of the beam. Install with proper side up as indicated by the manufacturer.
- Applicable calculations are based on NDS.

Supports	Bearing Length			Loads to Supports (lbs)			Accessories
	Total	Available	Required	Dead	Floor Live	Factored	
1 - Plate on concrete - HF	3.50"	2.25"	2.12"	761	2281	3042	1 1/4" Rim Board
2 - Hanger on 12" GLB beam	3.00"	Hanger ¹	1.50"	768	2306	3074	See note ¹

- Rim Board is assumed to carry all loads applied directly above it, bypassing the member being designed.
- At hanger supports, the Total Bearing dimension is equal to the width of the material that is supporting the hanger
- ¹ See Connector grid below for additional information and/or requirements.

Lateral Bracing	Bracing Intervals	Comments
Top Edge (Lu)	14' 11" o/c	
Bottom Edge (Lu)	14' 11" o/c	

•Maximum allowable bracing intervals based on applied load.

Connector: Simpson Strong-Tie						
Support	Model	Seat Length	Top Fasteners	Face Fasteners	Member Fasteners	Accessories
2 - Face Mount Hanger	HHUS410	3.00"	N/A	30-10d	10-10d	

- Refer to manufacturer notes and instructions for proper installation and use of all connectors.

Vertical Loads	Location (Side)	Tributary Width	Dead (0.90)	Floor Live (1.00)	Comments
0 - Self Weight (PLF)	1 1/4" to 15' 1/2"	N/A	10.2	--	
1 - Uniform (PSF)	0 to 15' 3 1/2" (Front)	2'	45.0	150.0	Default Load

Weyerhaeuser Notes

Weyerhaeuser warrants that the sizing of its products will be in accordance with Weyerhaeuser product design criteria and published design values. Weyerhaeuser expressly disclaims any other warranties related to the software. Use of this software is not intended to circumvent the need for a design professional as determined by the authority having jurisdiction. The designer of record, builder or framer is responsible to assure that this calculation is compatible with the overall project. Accessories (Rim Board, Blocking Panels and Squash Blocks) are not designed by this software. Products manufactured at Weyerhaeuser facilities are third-party certified to sustainable forestry standards. Weyerhaeuser Engineered Lumber Products have been evaluated by ICC-ES under evaluation reports ESR-1153 and ESR-1387 and/or tested in accordance with applicable ASTM standards. For current code evaluation reports, Weyerhaeuser product literature and installation details refer to www.woyehaeuser.com/woodproducts/document-library.

The product application, input design loads, dimensions and support information have been provided by ForteWEB Software Operator

ForteWEB Software Operator	Job Notes
Chon Pieruccioni Pieruccioni Engineering (206) 949-7866 cpieru@hotmail.com	



2nd Floor Framing, Top Landing Beam
1 piece(s) 5 1/2" x 13 1/2" 24F-V4 DF Glulam

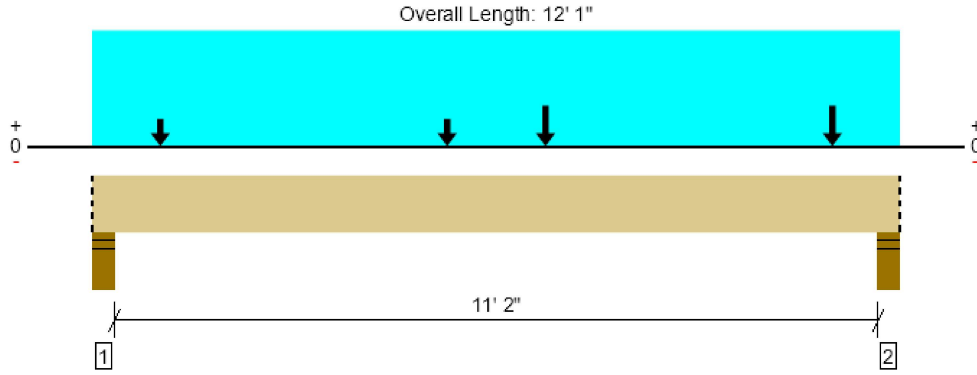

Drawing is Conceptual. All locations are measured from the outside face of left support (or left cantilever end). All dimensions are horizontal.

Design Results	Actual @ Location	Allowed	Result	LDF	Load: Combination (Pattern)
Member Reaction (lbs)	11985 @ 11' 9"	12251 (5.50")	Passed (98%)	--	1.0 D + 1.0 L (All Spans)
Shear (lbs)	8786 @ 10' 6"	13118	Passed (67%)	1.00	1.0 D + 1.0 L (All Spans)
Pos Moment (Ft-lbs)	31091 @ 6' 8 3/4"	33413	Passed (93%)	1.00	1.0 D + 1.0 L (All Spans)
Live Load Defl. (in)	0.261 @ 6' 1"	0.285	Passed (L/525)	--	1.0 D + 1.0 L (All Spans)
Total Load Defl. (in)	0.346 @ 6' 1"	0.571	Passed (L/396)	--	1.0 D + 1.0 L (All Spans)

Member Length : 12' 1"
 System : Floor
 Member Type : Flush Beam
 Building Use : Residential
 Building Code : IBC 2018
 Design Methodology : ASD

- Deflection criteria: LL (L/480) and TL (L/240).
- Allowed moment does not reflect the adjustment for the beam stability factor.
- Critical positive moment adjusted by a volume/size factor of 1.00 that was calculated using length L = 11' 5".
- The effects of positive or negative camber have not been accounted for when calculating deflection.
- The specified glulam is assumed to have its strong laminations at the bottom of the beam. Install with proper side up as indicated by the manufacturer.
- Applicable calculations are based on NDS.

Supports	Bearing Length			Loads to Supports (lbs)			Accessories
	Total	Available	Required	Dead	Floor Live	Factored	
1 - Stud wall - HF	5.50"	5.50"	4.69"	2563	7873	10437	Blocking
2 - Stud wall - HF	5.50"	5.50"	5.38"	2952	9033	11985	Blocking

• Blocking Panels are assumed to carry no loads applied directly above them and the full load is applied to the member being designed.

Lateral Bracing	Bracing Intervals	Comments
Top Edge (Lu)	12' 1" o/c	
Bottom Edge (Lu)	12' 1" o/c	

•Maximum allowable bracing intervals based on applied load.

Vertical Loads	Location (Side)	Tributary Width	Dead (0.90)	Floor Live (1.00)	Comments
0 - Self Weight (PLF)	0 to 12' 1"	N/A	18.0	--	
1 - Uniform (PSF)	0 to 12' 1" (Front)	5' 6"	45.0	150.0	Default Load
2 - Point (lb)	5' 3 3/4" (Front)	N/A	385	1163	Linked from: Short Stair Stringers, Support 1
3 - Point (lb)	1' 1/4" (Front)	N/A	385	1163	Linked from: Short Stair Stringers, Support 1
4 - Point (lb)	6' 9 3/8" (Front)	N/A	768	2306	Linked from: Long Short Stair Stringers, Support 2
5 - Point (lb)	11' 7/8" (Front)	N/A	768	2306	Linked from: Long Short Stair Stringers, Support 2

FORTEWEB Software Operator	Job Notes
Chon Pieruccioni Pieruccioni Engineering (206) 949-7866 cpieru@hotmail.com	



Weyerhaeuser Notes

Weyerhaeuser warrants that the sizing of its products will be in accordance with Weyerhaeuser product design criteria and published design values. Weyerhaeuser expressly disclaims any other warranties related to the software. Use of this software is not intended to circumvent the need for a design professional as determined by the authority having jurisdiction. The designer of record, builder or framer is responsible to assure that this calculation is compatible with the overall project. Accessories (Rim Board, Blocking Panels and Squash Blocks) are not designed by this software. Products manufactured at Weyerhaeuser facilities are third-party certified to sustainable forestry standards. Weyerhaeuser Engineered Lumber Products have been evaluated by ICC-ES under evaluation reports ESR-1153 and ESR-1387 and/or tested in accordance with applicable ASTM standards. For current code evaluation reports, Weyerhaeuser product literature and installation details refer to www.weyerhaeuser.com/woodproducts/document-library.

The product application, input design loads, dimensions and support information have been provided by ForteWEB Software Operator

ForteWEB Software Operator	Job Notes
Chon Pieruccioni Pieruccioni Engineering (206) 949-7866 cpieru@hotmail.com	



2nd Floor Framing, 10'-10" Deck Joist
1 piece(s) 2 x 12 HF No.2 @ 16" OC

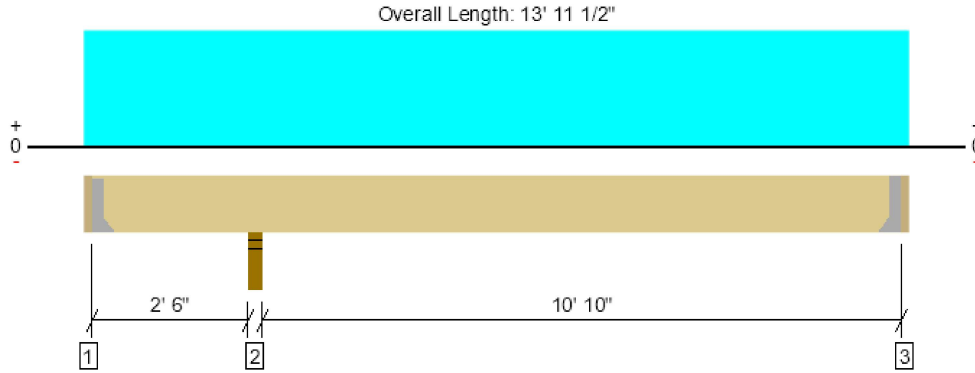

Drawing is Conceptual. All locations are measured from the outside face of left support (or left cantilever end). All dimensions are horizontal.

Design Results	Actual @ Location	Allowed	Result	LDF	Load: Combination (Pattern)
Member Reaction (lbs)	1510 @ 2' 9 3/4"	2126 (3.50")	Passed (71%)	--	1.0 D + 1.0 L (All Spans)
Shear (lbs)	663 @ 3' 10 3/4"	1688	Passed (39%)	1.00	1.0 D + 1.0 L (All Spans)
Moment (Ft-lbs)	-1477 @ 2' 9 3/4"	2577	Passed (57%)	1.00	1.0 D + 1.0 L (All Spans)
Live Load Defl. (in)	0.059 @ 8' 10 11/16"	0.366	Passed (L/999+)	--	1.0 D + 1.0 L (Alt Spans)
Total Load Defl. (in)	0.089 @ 8' 10 3/4"	0.549	Passed (L/999+)	--	1.0 D + 1.0 L (Alt Spans)
TJ-Pro™ Rating	N/A	N/A	N/A	--	N/A

Member Length : 13' 7 1/2"
 System : Floor
 Member Type : Joist
 Building Use : Residential
 Building Code : IBC 2018
 Design Methodology : ASD

- Deflection criteria: LL (L/360) and TL (L/240).
- Allowed moment does not reflect the adjustment for the beam stability factor.
- A 15% increase in the moment capacity has been added to account for repetitive member usage.
- -480 lbs uplift at support located at 2". Strapping or other restraint may be required.
- Applicable calculations are based on NDS.
- No composite action between deck and joist was considered in analysis.

Supports	Bearing Length			Loads to Supports (lbs)			Accessories
	Total	Available	Required	Dead	Floor Live	Factored	
1 - Hanger on 11 1/4" HF beam	2.00"	Hanger ¹	1.50"	-127	114/-354	-480	See note ¹
2 - Stud wall - HF	3.50"	3.50"	2.49"	503	1007	1510	None
3 - Hanger on 11 1/4" HF beam	2.00"	Hanger ¹	1.50"	181	364	545	See note ¹

- At hanger supports, the Total Bearing dimension is equal to the width of the material that is supporting the hanger
- ¹ See Connector grid below for additional information and/or requirements.

Lateral Bracing	Bracing Intervals	Comments
Top Edge (Lu)	11' o/c	
Bottom Edge (Lu)	7' 11" o/c	

- Maximum allowable bracing intervals based on applied load.

Connector: Simpson Strong-Tie							
Support	Model	Seat Length	Top Fasteners	Face Fasteners	Member Fasteners	Accessories	
1 - Face Mount Hanger	LUS28	1.75"	N/A	6-10dx1.5	3-10d		
3 - Face Mount Hanger	LUS28	1.75"	N/A	6-10dx1.5	3-10d		

- Refer to manufacturer notes and instructions for proper installation and use of all connectors.

Vertical Load	Location (Side)	Spacing	Dead (0.90)	Floor Live (1.00)	Comments
1 - Uniform (PSF)	0 to 13' 11 1/2"	16"	30.0	60.0	Default Load

Weyerhaeuser Notes
 Weyerhaeuser warrants that the sizing of its products will be in accordance with Weyerhaeuser product design criteria and published design values. Weyerhaeuser expressly disclaims any other warranties related to the software. Use of this software is not intended to circumvent the need for a design professional as determined by the authority having jurisdiction. The designer of record, builder or framer is responsible to assure that this calculation is compatible with the overall project. Accessories (Rim Board, Blocking Panels and Squash Blocks) are not designed by this software. Products manufactured at Weyerhaeuser facilities are third-party certified to sustainable forestry standards. Weyerhaeuser Engineered Lumber Products have been evaluated by ICC-ES under evaluation reports ESR-1153 and ESR-1387 and/or tested in accordance with applicable ASTM standards. For current code evaluation reports, Weyerhaeuser product literature and installation details refer to www.woyehaeuser.com/woodproducts/document-library.
 The product application, input design loads, dimensions and support information have been provided by ForteWEB Software Operator

ForteWEB Software Operator	Job Notes
Chon Pieruccioni Pieruccioni Engineering (206) 949-7866 cpieru@hotmail.com	



2nd Floor Framing, Deck Cantilever Ledger 2'
2 piece(s) 2 x 12 HF No.2

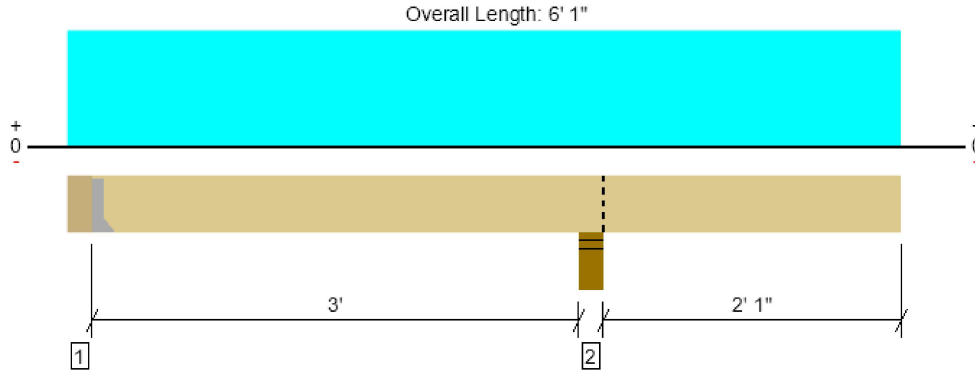

Drawing is Conceptual. All locations are measured from the outside face of left support (or left cantilever end). All dimensions are horizontal.

Design Results	Actual @ Location	Allowed	Result	LDF	Load: Combination (Pattern)
Member Reaction (lbs)	855 @ 6"	1823 (1.50")	Passed (47%)	--	1.0 D + 1.0 L (Alt Spans)
Shear (lbs)	814 @ 2' 6 3/4"	3375	Passed (24%)	1.00	1.0 D + 1.0 L (All Spans)
Moment (Ft-lbs)	-1738 @ 3' 9"	4482	Passed (39%)	1.00	1.0 D + 1.0 L (All Spans)
Live Load Defl. (in)	0.017 @ 6' 1"	0.200	Passed (2L/999+)	--	1.0 D + 1.0 L (Alt Spans)
Total Load Defl. (in)	0.023 @ 6' 1"	0.233	Passed (2L/999+)	--	1.0 D + 1.0 L (Alt Spans)

Member Length : 5' 7"
 System : Floor
 Member Type : Flush Beam
 Building Use : Residential
 Building Code : IBC 2018
 Design Methodology : ASD

- Deflection criteria: LL (L/360) and TL (L/240).
- Overhang deflection criteria: LL (0.2") and TL (2L/240).
- Right cantilever length exceeds 1/3 member length or 1/2 back span length. Additional bracing should be considered.
- Allowed moment does not reflect the adjustment for the beam stability factor.
- Applicable calculations are based on NDS.

Supports	Bearing Length			Loads to Supports (lbs)			Accessories
	Total	Available	Required	Dead	Floor Live	Factored	
1 - Hanger on 11 1/4" HF beam	6.00"	Hanger ¹	1.50"	277	893/-142	1170	See note ¹
2 - Stud wall - HF	6.00"	6.00"	2.52"	1048	2014	3062	Blocking

- Blocking Panels are assumed to carry no loads applied directly above them and the full load is applied to the member being designed.
- At hanger supports, the Total Bearing dimension is equal to the width of the material that is supporting the hanger
- ¹ See Connector grid below for additional information and/or requirements.

Lateral Bracing	Bracing Intervals	Comments
Top Edge (Lu)	5' 7" o/c	
Bottom Edge (Lu)	5' 7" o/c	

•Maximum allowable bracing intervals based on applied load.

Connector: Simpson Strong-Tie							
Support	Model	Seat Length	Top Fasteners	Face Fasteners	Member Fasteners	Accessories	
1 - Face Mount Hanger	LUS28-2	2.00"	N/A	6-10d	3-10d		

- Refer to manufacturer notes and instructions for proper installation and use of all connectors.

Vertical Loads	Location (Side)	Tributary Width	Dead (0.90)	Floor Live (1.00)	Comments
0 - Self Weight (PLF)	6" to 6' 1"	N/A	8.6	--	
1 - Uniform (PSF)	0 to 6' 1" (Front)	7'	30.0	60.0	Default Load

Weyerhaeuser Notes

Weyerhaeuser warrants that the sizing of its products will be in accordance with Weyerhaeuser product design criteria and published design values. Weyerhaeuser expressly disclaims any other warranties related to the software. Use of this software is not intended to circumvent the need for a design professional as determined by the authority having jurisdiction. The designer of record, builder or framer is responsible to assure that this calculation is compatible with the overall project. Accessories (Rim Board, Blocking Panels and Squash Blocks) are not designed by this software. Products manufactured at Weyerhaeuser facilities are third-party certified to sustainable forestry standards. Weyerhaeuser Engineered Lumber Products have been evaluated by ICC-ES under evaluation reports ESR-1153 and ESR-1387 and/or tested in accordance with applicable ASTM standards. For current code evaluation reports, Weyerhaeuser product literature and installation details refer to www.woyehaeuser.com/woodproducts/document-library.

The product application, input design loads, dimensions and support information have been provided by ForteWEB Software Operator

ForteWEB Software Operator	Job Notes
Chon Pieruccioni Pieruccioni Engineering (206) 949-7866 cpieru@hotmail.com	



2nd Floor Framing, Grid 2.6 (F-G.3) Flush Beam
1 piece(s) 5 1/2" x 11 7/8" 24F-V4 DF Glulam

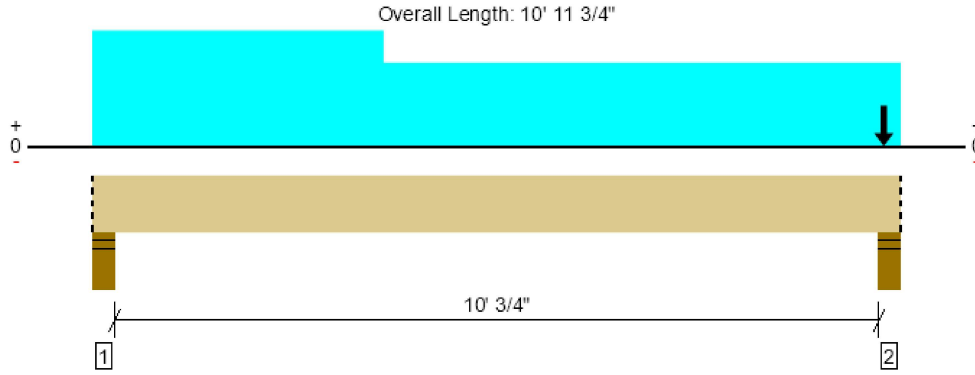

Drawing is Conceptual. All locations are measured from the outside face of left support (or left cantilever end). All dimensions are horizontal.

Design Results	Actual @ Location	Allowed	Result	LDF	Load: Combination (Pattern)
Member Reaction (lbs)	10433 @ 10' 7 3/4"	12251 (5.50")	Passed (85%)	--	1.0 D + 1.0 L (All Spans)
Shear (lbs)	3786 @ 1' 5 3/8"	11539	Passed (33%)	1.00	1.0 D + 1.0 L (All Spans)
Pos Moment (Ft-lbs)	11612 @ 5' 3"	25853	Passed (45%)	1.00	1.0 D + 1.0 L (All Spans)
Live Load Defl. (in)	0.091 @ 5' 5 3/16"	0.258	Passed (L/999+)	--	1.0 D + 1.0 L (All Spans)
Total Load Defl. (in)	0.162 @ 5' 5 3/16"	0.516	Passed (L/764)	--	1.0 D + 1.0 L (All Spans)

Member Length : 10' 11 3/4"
 System : Floor
 Member Type : Flush Beam
 Building Use : Residential
 Building Code : IBC 2018
 Design Methodology : ASD

- Deflection criteria: LL (L/480) and TL (L/240).
- Allowed moment does not reflect the adjustment for the beam stability factor.
- Critical positive moment adjusted by a volume/size factor of 1.00 that was calculated using length L = 10' 3 3/4".
- The effects of positive or negative camber have not been accounted for when calculating deflection.
- The specified glulam is assumed to have its strong laminations at the bottom of the beam. Install with proper side up as indicated by the manufacturer.
- Applicable calculations are based on NDS.

Supports	Bearing Length			Loads to Supports (lbs)			Accessories
	Total	Available	Required	Dead	Floor Live	Factored	
1 - Stud wall - HF	5.50"	5.50"	2.41"	2354	3022	5376	Blocking
2 - Stud wall - HF	5.50"	5.50"	4.68"	4582	5850	10433	Blocking

• Blocking Panels are assumed to carry no loads applied directly above them and the full load is applied to the member being designed.

Lateral Bracing	Bracing Intervals	Comments
Top Edge (Lu)	11' o/c	
Bottom Edge (Lu)	11' o/c	

•Maximum allowable bracing intervals based on applied load.

Vertical Loads	Location (Side)	Tributary Width	Dead (0.90)	Floor Live (1.00)	Comments
0 - Self Weight (PLF)	0 to 10' 11 3/4"	N/A	15.9	--	
1 - Uniform (PSF)	0 to 3' 11 1/2" (Front)	15' 5 1/2"	30.0	40.0	Default Load
2 - Uniform (PSF)	3' 11 1/2" to 10' 11 3/4" (Front)	11' 2"	30.0	40.0	Default Load
3 - Point (lb)	10' 9" (Top)	N/A	2574	3289	Linked from: Grid 2.6 (F-G.5) Flush Beam, Support 2

Weyerhaeuser Notes

Weyerhaeuser warrants that the sizing of its products will be in accordance with Weyerhaeuser product design criteria and published design values. Weyerhaeuser expressly disclaims any other warranties related to the software. Use of this software is not intended to circumvent the need for a design professional as determined by the authority having jurisdiction. The designer of record, builder or framer is responsible to assure that this calculation is compatible with the overall project. Accessories (Rim Board, Blocking Panels and Squash Blocks) are not designed by this software. Products manufactured at Weyerhaeuser facilities are third-party certified to sustainable forestry standards. Weyerhaeuser Engineered Lumber Products have been evaluated by ICC-ES under evaluation reports ESR-1153 and ESR-1387 and/or tested in accordance with applicable ASTM standards. For current code evaluation reports, Weyerhaeuser product literature and installation details refer to www.weyerhaeuser.com/woodproducts/document-library.

The product application, input design loads, dimensions and support information have been provided by ForteWEB Software Operator

ForteWEB Software Operator	Job Notes
Chon Pieruccioni Pieruccioni Engineering (206) 949-7866 cpieru@hotmail.com	



2nd Floor Framing, Grid 2.6 (G.9-H.8) Flush Beam
1 piece(s) 5 1/2" x 11 7/8" 24F-V4 DF Glulam

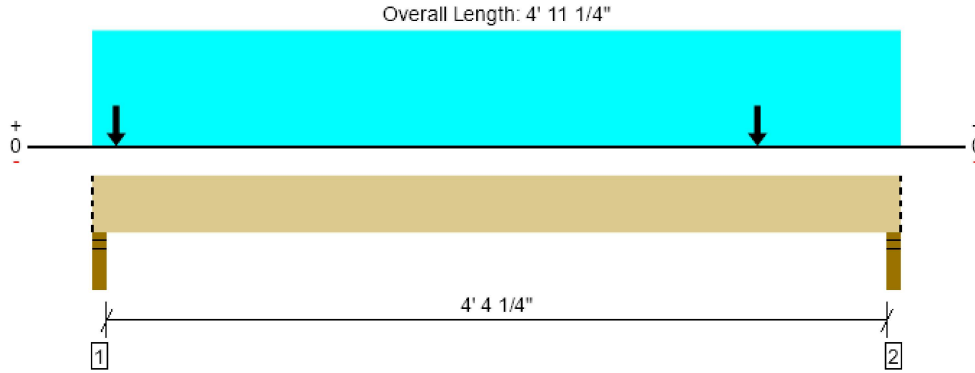

Drawing is Conceptual. All locations are measured from the outside face of left support (or left cantilever end). All dimensions are horizontal.

Design Results	Actual @ Location	Allowed	Result	LDF	Load: Combination (Pattern)
Member Reaction (lbs)	7141 @ 2"	7796 (3.50")	Passed (92%)	--	1.0 D + 1.0 L (All Spans)
Shear (lbs)	3257 @ 3' 7 7/8"	11539	Passed (28%)	1.00	1.0 D + 1.0 L (All Spans)
Pos Moment (Ft-lbs)	4949 @ 2' 9 3/4"	25853	Passed (19%)	1.00	1.0 D + 1.0 L (All Spans)
Live Load Defl. (in)	0.008 @ 2' 6 5/16"	0.115	Passed (L/999+)	--	1.0 D + 1.0 L (All Spans)
Total Load Defl. (in)	0.014 @ 2' 6 5/16"	0.230	Passed (L/999+)	--	1.0 D + 1.0 L (All Spans)

Member Length : 4' 11 1/4"
 System : Floor
 Member Type : Flush Beam
 Building Use : Residential
 Building Code : IBC 2018
 Design Methodology : ASD

- Deflection criteria: LL (L/480) and TL (L/240).
- Allowed moment does not reflect the adjustment for the beam stability factor.
- Critical positive moment adjusted by a volume/size factor of 1.00 that was calculated using length L = 4' 7 1/4".
- The effects of positive or negative camber have not been accounted for when calculating deflection.
- The specified glulam is assumed to have its strong laminations at the bottom of the beam. Install with proper side up as indicated by the manufacturer.
- Applicable calculations are based on NDS.

Supports	Bearing Length			Loads to Supports (lbs)			Accessories
	Total	Available	Required	Dead	Floor Live	Factored	
1 - Stud wall - HF	3.50"	3.50"	3.21"	3098	4043	7141	Blocking
2 - Stud wall - HF	3.50"	3.50"	2.77"	2677	3491	6167	Blocking

• Blocking Panels are assumed to carry no loads applied directly above them and the full load is applied to the member being designed.

Lateral Bracing	Bracing Intervals	Comments
Top Edge (Lu)	4' 11" o/c	
Bottom Edge (Lu)	4' 11" o/c	

•Maximum allowable bracing intervals based on applied load.

Vertical Loads	Location (Side)	Tributary Width	Dead (0.90)	Floor Live (1.00)	Comments
0 - Self Weight (PLF)	0 to 4' 11 1/4"	N/A	15.9	--	
1 - Uniform (PSF)	0 to 4' 11 1/4" (Front)	19' 11 1/2"	30.0	40.0	Default Load
2 - Point (lb)	4' 3/4" (Top)	N/A	1370	1796	Linked from: Grid 2.6 (H-H.8) Flush Beam, Support 2
3 - Point (lb)	1 3/4" (Top)	N/A	1370	1796	Linked from: Grid 2.6 (H-H.8) Flush Beam, Support 1

Weyerhaeuser Notes
 Weyerhaeuser warrants that the sizing of its products will be in accordance with Weyerhaeuser product design criteria and published design values. Weyerhaeuser expressly disclaims any other warranties related to the software. Use of this software is not intended to circumvent the need for a design professional as determined by the authority having jurisdiction. The designer of record, builder or framer is responsible to assure that this calculation is compatible with the overall project. Accessories (Rim Board, Blocking Panels and Squash Blocks) are not designed by this software. Products manufactured at Weyerhaeuser facilities are third-party certified to sustainable forestry standards. Weyerhaeuser Engineered Lumber Products have been evaluated by ICC-ES under evaluation reports ESR-1153 and ESR-1387 and/or tested in accordance with applicable ASTM standards. For current code evaluation reports, Weyerhaeuser product literature and installation details refer to www.weyerhaeuser.com/woodproducts/document-library.
 The product application, input design loads, dimensions and support information have been provided by ForteWEB Software Operator

ForteWEB Software Operator	Job Notes
Chon Pieruccioni Pieruccioni Engineering (206) 949-7866 cpieru@hotmail.com	



2nd Floor Framing, Grid 2.4 (H.8-I.8) Door Header
1 piece(s) 4 x 8 DF No.2

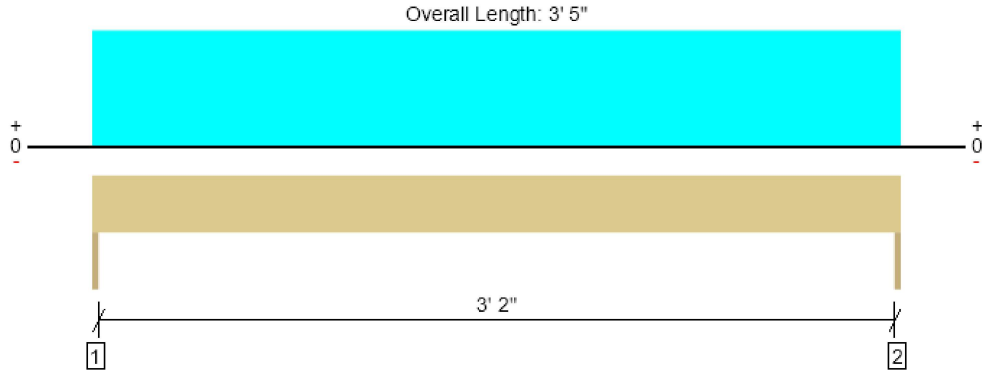

Drawing is Conceptual. All locations are measured from the outside face of left support (or left cantilever end). All dimensions are horizontal.

Design Results	Actual @ Location	Allowed	Result	LDF	Load: Combination (Pattern)
Member Reaction (lbs)	1523 @ 0	3281 (1.50")	Passed (46%)	--	1.0 D + 1.0 L (All Spans)
Shear (lbs)	873 @ 8 3/4"	3045	Passed (29%)	1.00	1.0 D + 1.0 L (All Spans)
Moment (Ft-lbs)	1301 @ 1' 8 1/2"	2989	Passed (44%)	1.00	1.0 D + 1.0 L (All Spans)
Live Load Defl. (in)	0.009 @ 1' 8 1/2"	0.114	Passed (L/999+)	--	1.0 D + 1.0 L (All Spans)
Total Load Defl. (in)	0.015 @ 1' 8 1/2"	0.171	Passed (L/999+)	--	1.0 D + 1.0 L (All Spans)

Member Length : 3' 5"
 System : Wall
 Member Type : Header
 Building Use : Residential
 Building Code : IBC 2018
 Design Methodology : ASD

- Deflection criteria: LL (L/360) and TL (L/240).
- Allowed moment does not reflect the adjustment for the beam stability factor.
- Applicable calculations are based on NDS.

Supports	Bearing Length			Loads to Supports (lbs)			Accessories
	Total	Available	Required	Dead	Floor Live	Factored	
1 - Trimmer - HF	1.50"	1.50"	1.50"	659	864	1523	None
2 - Trimmer - HF	1.50"	1.50"	1.50"	659	864	1523	None

Lateral Bracing	Bracing Intervals	Comments
Top Edge (Lu)	3' 5" o/c	
Bottom Edge (Lu)	3' 5" o/c	

•Maximum allowable bracing intervals based on applied load.

Vertical Loads	Location	Tributary Width	Dead (0.90)	Floor Live (1.00)	Comments
0 - Self Weight (PLF)	0 to 3' 5"	N/A	6.4	--	
1 - Uniform (PSF)	0 to 3' 5"	12' 7 3/4"	30.0	40.0	Default Load

Weyerhaeuser Notes

Weyerhaeuser warrants that the sizing of its products will be in accordance with Weyerhaeuser product design criteria and published design values. Weyerhaeuser expressly disclaims any other warranties related to the software. Use of this software is not intended to circumvent the need for a design professional as determined by the authority having jurisdiction. The designer of record, builder or framer is responsible to assure that this calculation is compatible with the overall project. Accessories (Rim Board, Blocking Panels and Squash Blocks) are not designed by this software. Products manufactured at Weyerhaeuser facilities are third-party certified to sustainable forestry standards. Weyerhaeuser Engineered Lumber Products have been evaluated by ICC-ES under evaluation reports ESR-1153 and ESR-1387 and/or tested in accordance with applicable ASTM standards. For current code evaluation reports, Weyerhaeuser product literature and installation details refer to www.woyehaeuser.com/woodproducts/document-library.

The product application, input design loads, dimensions and support information have been provided by ForteWEB Software Operator

ForteWEB Software Operator	Job Notes
Chon Pieruccioni Pieruccioni Engineering (206) 949-7866 cpieru@hotmail.com	



2nd Floor Framing, Grid 2.4 (J.2-K.8) Door Header
1 piece(s) 4 x 8 DF No.2

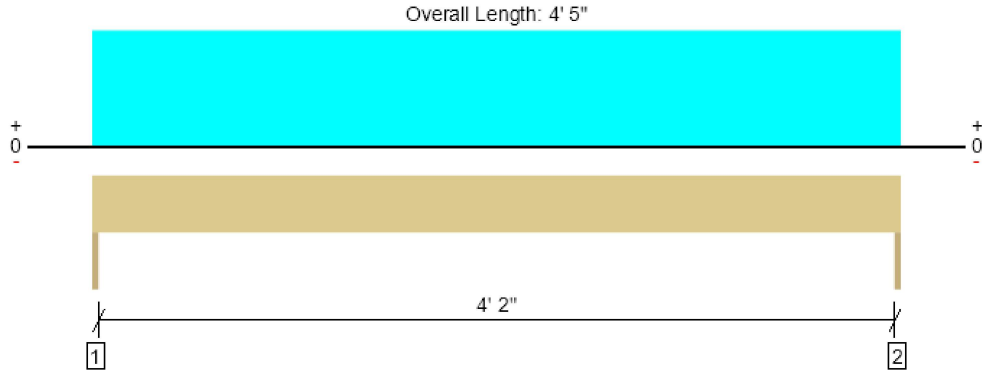

Drawing is Conceptual. All locations are measured from the outside face of left support (or left cantilever end). All dimensions are horizontal.

Design Results	Actual @ Location	Allowed	Result	LDF	Load: Combination (Pattern)
Member Reaction (lbs)	1969 @ 0	3281 (1.50")	Passed (60%)	--	1.0 D + 1.0 L (All Spans)
Shear (lbs)	1319 @ 8 3/4"	3045	Passed (43%)	1.00	1.0 D + 1.0 L (All Spans)
Moment (Ft-lbs)	2174 @ 2' 2 1/2"	2989	Passed (73%)	1.00	1.0 D + 1.0 L (All Spans)
Live Load Defl. (in)	0.024 @ 2' 2 1/2"	0.147	Passed (L/999+)	--	1.0 D + 1.0 L (All Spans)
Total Load Defl. (in)	0.043 @ 2' 2 1/2"	0.221	Passed (L/999+)	--	1.0 D + 1.0 L (All Spans)

Member Length : 4' 5"
 System : Wall
 Member Type : Header
 Building Use : Residential
 Building Code : IBC 2018
 Design Methodology : ASD

- Deflection criteria: LL (L/360) and TL (L/240).
- Allowed moment does not reflect the adjustment for the beam stability factor.
- Applicable calculations are based on NDS.

Supports	Bearing Length			Loads to Supports (lbs)			Accessories
	Total	Available	Required	Dead	Floor Live	Factored	
1 - Trimmer - HF	1.50"	1.50"	1.50"	852	1117	1969	None
2 - Trimmer - HF	1.50"	1.50"	1.50"	852	1117	1969	None

Lateral Bracing	Bracing Intervals	Comments
Top Edge (Lu)	4' 5" o/c	
Bottom Edge (Lu)	4' 5" o/c	

•Maximum allowable bracing intervals based on applied load.

Vertical Loads	Location	Tributary Width	Dead (0.90)	Floor Live (1.00)	Comments
0 - Self Weight (PLF)	0 to 4' 5"	N/A	6.4	--	
1 - Uniform (PSF)	0 to 4' 5"	12' 7 3/4"	30.0	40.0	Default Load

Weyerhaeuser Notes
 Weyerhaeuser warrants that the sizing of its products will be in accordance with Weyerhaeuser product design criteria and published design values. Weyerhaeuser expressly disclaims any other warranties related to the software. Use of this software is not intended to circumvent the need for a design professional as determined by the authority having jurisdiction. The designer of record, builder or framer is responsible to assure that this calculation is compatible with the overall project. Accessories (Rim Board, Blocking Panels and Squash Blocks) are not designed by this software. Products manufactured at Weyerhaeuser facilities are third-party certified to sustainable forestry standards. Weyerhaeuser Engineered Lumber Products have been evaluated by ICC-ES under evaluation reports ESR-1153 and ESR-1387 and/or tested in accordance with applicable ASTM standards. For current code evaluation reports, Weyerhaeuser product literature and installation details refer to www.weyerhaeuser.com/woodproducts/document-library.
 The product application, input design loads, dimensions and support information have been provided by ForteWEB Software Operator

ForteWEB Software Operator	Job Notes
Chon Pieruccioni Pieruccioni Engineering (206) 949-7866 cpieru@hotmail.com	



2nd Floor Framing, Grid 5.5 (H-H.8) Door Header
1 piece(s) 4 x 8 DF No.2

Overall Length: 3' 5 1/2"

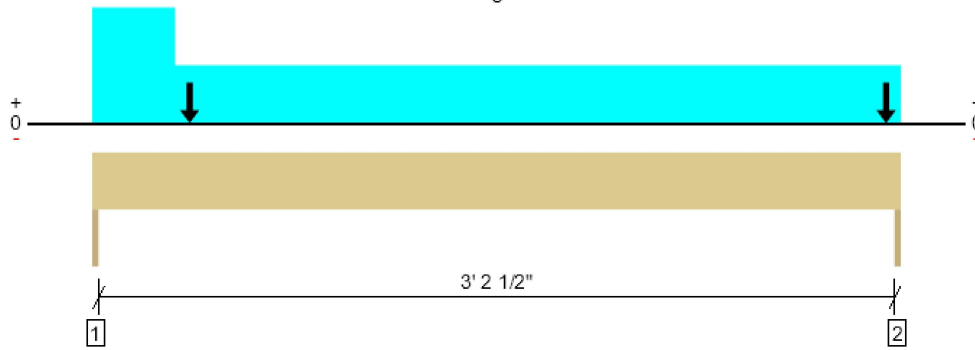

Drawing is Conceptual. All locations are measured from the outside face of left support (or left cantilever end). All dimensions are horizontal.

Design Results	Actual @ Location	Allowed	Result	LDF	Load: Combination (Pattern)
Member Reaction (lbs)	2520 @ 3' 5 1/2"	3281 (1.50")	Passed (77%)	--	1.0 D + 1.0 L (All Spans)
Shear (lbs)	1180 @ 8 3/4"	3045	Passed (39%)	1.00	1.0 D + 1.0 L (All Spans)
Moment (Ft-lbs)	1362 @ 1' 6 1/4"	2989	Passed (46%)	1.00	1.0 D + 1.0 L (All Spans)
Live Load Defl. (in)	0.010 @ 1' 8 5/16"	0.115	Passed (L/999+)	--	1.0 D + 1.0 L (All Spans)
Total Load Defl. (in)	0.017 @ 1' 8 5/16"	0.173	Passed (L/999+)	--	1.0 D + 1.0 L (All Spans)

Member Length : 3' 5 1/2"
 System : Wall
 Member Type : Header
 Building Use : Residential
 Building Code : IBC 2018
 Design Methodology : ASD

- Deflection criteria: LL (L/360) and TL (L/240).
- Allowed moment does not reflect the adjustment for the beam stability factor.
- Applicable calculations are based on NDS.

Supports	Bearing Length			Loads to Supports (lbs)			Accessories
	Total	Available	Required	Dead	Floor Live	Factored	
1 - Trimmer - HF	1.50"	1.50"	1.50"	1089	1425	2514	None
2 - Trimmer - HF	1.50"	1.50"	1.50"	1093	1427	2520	None

Lateral Bracing	Bracing Intervals	Comments
Top Edge (Lu)	3' 6" o/c	
Bottom Edge (Lu)	3' 6" o/c	

•Maximum allowable bracing intervals based on applied load.

Vertical Loads	Location	Tributary Width	Dead (0.90)	Floor Live (1.00)	Comments
0 - Self Weight (PLF)	0 to 3' 5 1/2"	N/A	6.4	--	
1 - Uniform (PSF)	0 to 3' 5 1/2"	10' 3"	30.0	40.0	2nd Floor
2 - Uniform (PSF)	0 to 4 1/4"	10' 3"	30.0	40.0	3rd Floor
3 - Point (lb)	5"	N/A	484	632	Linked from: Grid 5,5 (H-H.8) Door Header, Support 1
4 - Point (lb)	3' 4 3/4"	N/A	484	632	Linked from: Grid 5,5 (H-H.8) Door Header, Support 2

Weyerhaeuser Notes

Weyerhaeuser warrants that the sizing of its products will be in accordance with Weyerhaeuser product design criteria and published design values. Weyerhaeuser expressly disclaims any other warranties related to the software. Use of this software is not intended to circumvent the need for a design professional as determined by the authority having jurisdiction. The designer of record, builder or framer is responsible to assure that this calculation is compatible with the overall project. Accessories (Rim Board, Blocking Panels and Squash Blocks) are not designed by this software. Products manufactured at Weyerhaeuser facilities are third-party certified to sustainable forestry standards. Weyerhaeuser Engineered Lumber Products have been evaluated by ICC-ES under evaluation reports ESR-1153 and ESR-1387 and/or tested in accordance with applicable ASTM standards. For current code evaluation reports, Weyerhaeuser product literature and installation details refer to www.weyerhaeuser.com/woodproducts/document-library.

The product application, input design loads, dimensions and support information have been provided by ForteWEB Software Operator

ForteWEB Software Operator	Job Notes
Chon Pieruccioni Pieruccioni Engineering (206) 949-7866 cpieru@hotmail.com	



2nd Floor Framing, Grid 5.5 (G.1-G.3) Flush Beam
1 piece(s) 3 1/2" x 11 7/8" 24F-V4 DF Glulam

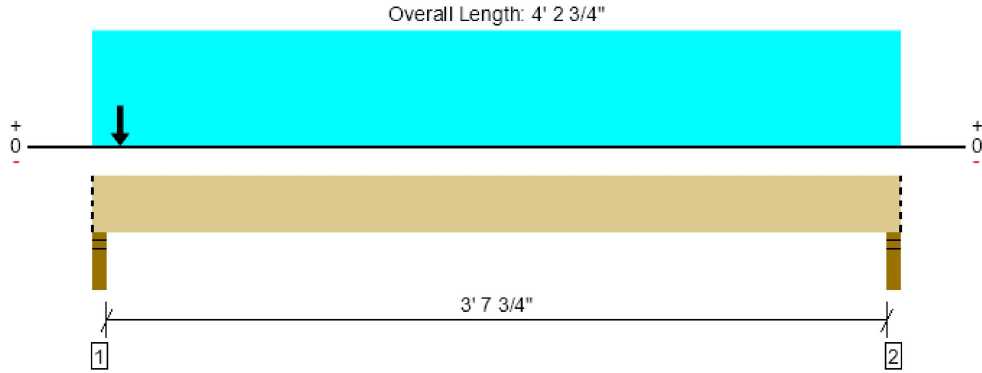

Drawing is Conceptual. All locations are measured from the outside face of left support (or left cantilever end). All dimensions are horizontal.

Design Results	Actual @ Location	Allowed	Result	LDF	Load: Combination (Pattern)
Member Reaction (lbs)	3078 @ 2"	4961 (3.50")	Passed (62%)	--	1.0 D + 1.0 L (All Spans)
Shear (lbs)	606 @ 1' 3 3/8"	7343	Passed (8%)	1.00	1.0 D + 1.0 L (All Spans)
Pos Moment (Ft-lbs)	1380 @ 2' 1 3/8"	16452	Passed (8%)	1.00	1.0 D + 1.0 L (All Spans)
Live Load Defl. (in)	0.002 @ 2' 1 3/8"	0.097	Passed (L/999+)	--	1.0 D + 1.0 L (All Spans)
Total Load Defl. (in)	0.004 @ 2' 1 3/8"	0.195	Passed (L/999+)	--	1.0 D + 1.0 L (All Spans)

Member Length : 4' 2 3/4"
 System : Floor
 Member Type : Flush Beam
 Building Use : Residential
 Building Code : IBC 2018
 Design Methodology : ASD

- Deflection criteria: LL (L/480) and TL (L/240).
- Allowed moment does not reflect the adjustment for the beam stability factor.
- Critical positive moment adjusted by a volume/size factor of 1.00 that was calculated using length L = 3' 10 3/4".
- The effects of positive or negative camber have not been accounted for when calculating deflection.
- The specified glulam is assumed to have its strong laminations at the bottom of the beam. Install with proper side up as indicated by the manufacturer.
- Applicable calculations are based on NDS.

Supports	Bearing Length			Loads to Supports (lbs)			Accessories
	Total	Available	Required	Dead	Floor Live	Factored	
1 - Stud wall - HF	3.50"	3.50"	2.17"	1344	1734	3078	Blocking
2 - Stud wall - HF	3.50"	3.50"	1.50"	672	867	1539	Blocking

• Blocking Panels are assumed to carry no loads applied directly above them and the full load is applied to the member being designed.

Lateral Bracing	Bracing Intervals	Comments
Top Edge (Lu)	4' 3" o/c	
Bottom Edge (Lu)	4' 3" o/c	

•Maximum allowable bracing intervals based on applied load.

Vertical Loads	Location (Side)	Tributary Width	Dead (0.90)	Floor Live (1.00)	Comments
0 - Self Weight (PLF)	0 to 4' 2 3/4"	N/A	10.1	--	
1 - Uniform (PSF)	0 to 4' 2 3/4" (Front)	10' 3"	30.0	40.0	Default Load
2 - Point (lb)	1 3/4" (Top)	N/A	672	867	Linked from: Grid 5.5 (G.1-G.3) Flush Beam, Support 1

Weyerhaeuser Notes

Weyerhaeuser warrants that the sizing of its products will be in accordance with Weyerhaeuser product design criteria and published design values. Weyerhaeuser expressly disclaims any other warranties related to the software. Use of this software is not intended to circumvent the need for a design professional as determined by the authority having jurisdiction. The designer of record, builder or framer is responsible to assure that this calculation is compatible with the overall project. Accessories (Rim Board, Blocking Panels and Squash Blocks) are not designed by this software. Products manufactured at Weyerhaeuser facilities are third-party certified to sustainable forestry standards. Weyerhaeuser Engineered Lumber Products have been evaluated by ICC-ES under evaluation reports ESR-1153 and ESR-1387 and/or tested in accordance with applicable ASTM standards. For current code evaluation reports, Weyerhaeuser product literature and installation details refer to www.eyerhaeuser.com/woodproducts/document-library.

The product application, input design loads, dimensions and support information have been provided by ForteWEB Software Operator

ForteWEB Software Operator	Job Notes
Chon Pieruccioni Pieruccioni Engineering (206) 949-7866 cpieru@hotmail.com	



2nd Floor Framing, Grid G.1 (5.2-5.3) Door Header
1 piece(s) 4 x 8 DF No.2

Overall Length: 2' 5"

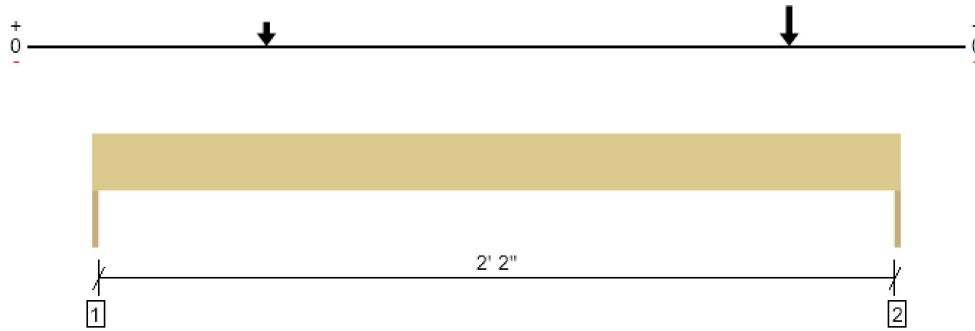

Drawing is Conceptual. All locations are measured from the outside face of left support (or left cantilever end). All dimensions are horizontal.

Design Results	Actual @ Location	Allowed	Result	LDF	Load: Combination (Pattern)
Member Reaction (lbs)	1462 @ 2' 5"	3281 (1.50")	Passed (45%)	--	1.0 D + 1.0 L (All Spans)
Shear (lbs)	588 @ 1' 8 1/4"	3045	Passed (19%)	1.00	1.0 D + 1.0 L (All Spans)
Moment (Ft-lbs)	487 @ 2' 1"	2989	Passed (16%)	1.00	1.0 D + 1.0 L (All Spans)
Live Load Defl. (in)	0.002 @ 1' 3 1/8"	0.081	Passed (L/999+)	--	1.0 D + 1.0 L (All Spans)
Total Load Defl. (in)	0.003 @ 1' 3 1/8"	0.121	Passed (L/999+)	--	1.0 D + 1.0 L (All Spans)

Member Length : 2' 5"
 System : Wall
 Member Type : Header
 Building Use : Residential
 Building Code : IBC 2018
 Design Methodology : ASD

- Deflection criteria: LL (L/360) and TL (L/240).
- Allowed moment does not reflect the adjustment for the beam stability factor.
- Applicable calculations are based on NDS.

Supports	Bearing Length			Loads to Supports (lbs)			Accessories
	Total	Available	Required	Dead	Floor Live	Factored	
1 - Trimmer - HF	1.50"	1.50"	1.50"	307	378	684	None
2 - Trimmer - HF	1.50"	1.50"	1.50"	644	818	1462	None

Lateral Bracing	Bracing Intervals	Comments
Top Edge (Lu)	2' 5" o/c	
Bottom Edge (Lu)	2' 5" o/c	

•Maximum allowable bracing intervals based on applied load.

Vertical Loads	Location	Tributary Width	Dead (0.90)	Floor Live (1.00)	Comments
0 - Self Weight (PLF)	0 to 2' 5"	N/A	6.4	--	
1 - Point (lb)	2' 1"	N/A	672	867	Linked from: Grid 5.5 (G.1-G.3) Flush Beam, Support 2
2 - Point (lb)	6 1/4"	N/A	263	329	Linked from: Grid G.1 (5.2-5.3) Door Header, Support 1

Weyerhaeuser Notes
 Weyerhaeuser warrants that the sizing of its products will be in accordance with Weyerhaeuser product design criteria and published design values. Weyerhaeuser expressly disclaims any other warranties related to the software. Use of this software is not intended to circumvent the need for a design professional as determined by the authority having jurisdiction. The designer of record, builder or framer is responsible to assure that this calculation is compatible with the overall project. Accessories (Rim Board, Blocking Panels and Squash Blocks) are not designed by this software. Products manufactured at Weyerhaeuser facilities are third-party certified to sustainable forestry standards. Weyerhaeuser Engineered Lumber Products have been evaluated by ICC-ES under evaluation reports ESR-1153 and ESR-1387 and/or tested in accordance with applicable ASTM standards. For current code evaluation reports, Weyerhaeuser product literature and installation details refer to www.woyehaeuser.com/woodproducts/document-library.
 The product application, input design loads, dimensions and support information have been provided by ForteWEB Software Operator

ForteWEB Software Operator	Job Notes
Chon Pieruccioni Pieruccioni Engineering (206) 949-7866 cpieru@hotmail.com	



2nd Floor Framing, Grid 6 (G.1-G.3) Flush Beam
1 piece(s) 3 1/2" x 11 7/8" 24F-V4 DF Glulam

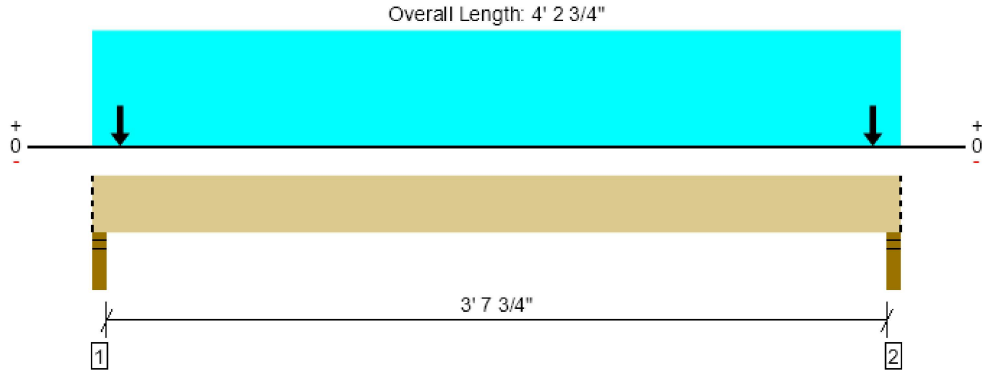

Drawing is Conceptual. All locations are measured from the outside face of left support (or left cantilever end). All dimensions are horizontal.

Design Results	Actual @ Location	Allowed	Result	LDF	Load: Combination (Pattern)
Member Reaction (lbs)	3423 @ 2"	4961 (3.50")	Passed (69%)	--	1.0 D + 1.0 L (All Spans)
Shear (lbs)	674 @ 1' 3 3/8"	7343	Passed (9%)	1.00	1.0 D + 1.0 L (All Spans)
Pos Moment (Ft-lbs)	1535 @ 2' 1 3/8"	16452	Passed (9%)	1.00	1.0 D + 1.0 L (All Spans)
Live Load Defl. (in)	0.003 @ 2' 1 3/8"	0.097	Passed (L/999+)	--	1.0 D + 1.0 L (All Spans)
Total Load Defl. (in)	0.005 @ 2' 1 3/8"	0.195	Passed (L/999+)	--	1.0 D + 1.0 L (All Spans)

Member Length : 4' 2 3/4"
 System : Floor
 Member Type : Flush Beam
 Building Use : Residential
 Building Code : IBC 2018
 Design Methodology : ASD

- Deflection criteria: LL (L/480) and TL (L/240).
- Allowed moment does not reflect the adjustment for the beam stability factor.
- Critical positive moment adjusted by a volume/size factor of 1.00 that was calculated using length L = 3' 10 3/4".
- The effects of positive or negative camber have not been accounted for when calculating deflection.
- The specified glulam is assumed to have its strong laminations at the bottom of the beam. Install with proper side up as indicated by the manufacturer.
- Applicable calculations are based on NDS.

Supports	Bearing Length			Loads to Supports (lbs)			Accessories
	Total	Available	Required	Dead	Floor Live	Factored	
1 - Stud wall - HF	3.50"	3.50"	2.42"	1492	1932	3423	Blocking
2 - Stud wall - HF	3.50"	3.50"	2.42"	1492	1932	3423	Blocking

• Blocking Panels are assumed to carry no loads applied directly above them and the full load is applied to the member being designed.

Lateral Bracing	Bracing Intervals	Comments
Top Edge (Lu)	4' 3" o/c	
Bottom Edge (Lu)	4' 3" o/c	

•Maximum allowable bracing intervals based on applied load.

Vertical Loads	Location (Side)	Tributary Width	Dead (0.90)	Floor Live (1.00)	Comments
0 - Self Weight (PLF)	0 to 4' 2 3/4"	N/A	10.1	--	
1 - Uniform (PSF)	0 to 4' 2 3/4" (Front)	11' 5"	30.0	40.0	Default Load
2 - Point (lb)	1 3/4" (Top)	N/A	746	966	Linked from: Grid 6 (G.1-G.3) Flush Beam, Support 1
3 - Point (lb)	4' 1" (Top)	N/A	746	966	Linked from: Grid 6 (G.1-G.3) Flush Beam, Support 1

Weyerhaeuser Notes

Weyerhaeuser warrants that the sizing of its products will be in accordance with Weyerhaeuser product design criteria and published design values. Weyerhaeuser expressly disclaims any other warranties related to the software. Use of this software is not intended to circumvent the need for a design professional as determined by the authority having jurisdiction. The designer of record, builder or framer is responsible to assure that this calculation is compatible with the overall project. Accessories (Rim Board, Blocking Panels and Squash Blocks) are not designed by this software. Products manufactured at Weyerhaeuser facilities are third-party certified to sustainable forestry standards. Weyerhaeuser Engineered Lumber Products have been evaluated by ICC-ES under evaluation reports ESR-1153 and ESR-1387 and/or tested in accordance with applicable ASTM standards. For current code evaluation reports, Weyerhaeuser product literature and installation details refer to www.weyerhaeuser.com/woodproducts/document-library.

The product application, input design loads, dimensions and support information have been provided by ForteWEB Software Operator

ForteWEB Software Operator	Job Notes
Chon Pieruccioni Pieruccioni Engineering (206) 949-7866 cpieru@hotmail.com	



3/7/2024 3:51:26 PM UTC
 ForteWEB v3.7, Engine: V8.4.0.40, Data: V8.1.5.0

File Name: East Town Crossing Building E

2nd Floor Framing, Grid 2.5 (D.4-D.6) Flush Beam
1 piece(s) 3 1/2" x 11 7/8" 24F-V4 DF Glulam

Overall Length: 5' 10 1/4"

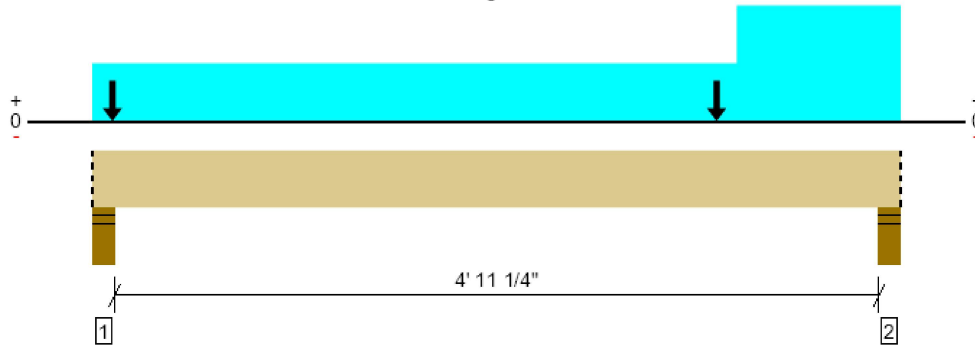

Drawing is Conceptual. All locations are measured from the outside face of left support (or left cantilever end). All dimensions are horizontal.

Design Results	Actual @ Location	Allowed	Result	LDF	Load: Combination (Pattern)
Member Reaction (lbs)	6690 @ 5' 6 1/4"	7796 (5.50")	Passed (86%)	--	1.0 D + 1.0 L (All Spans)
Shear (lbs)	3451 @ 4' 4 7/8"	7343	Passed (47%)	1.00	1.0 D + 1.0 L (All Spans)
Pos Moment (Ft-lbs)	5483 @ 3' 5 3/16"	16452	Passed (33%)	1.00	1.0 D + 1.0 L (All Spans)
Live Load Defl. (in)	0.017 @ 3' 1/4"	0.130	Passed (L/999+)	--	1.0 D + 1.0 L (All Spans)
Total Load Defl. (in)	0.031 @ 3' 1/4"	0.259	Passed (L/999+)	--	1.0 D + 1.0 L (All Spans)

Member Length : 5' 10 1/4"
 System : Floor
 Member Type : Flush Beam
 Building Use : Residential
 Building Code : IBC 2018
 Design Methodology : ASD

- Deflection criteria: LL (L/480) and TL (L/240).
- Allowed moment does not reflect the adjustment for the beam stability factor.
- Critical positive moment adjusted by a volume/size factor of 1.00 that was calculated using length L = 5' 2 1/4".
- The effects of positive or negative camber have not been accounted for when calculating deflection.
- The specified glulam is assumed to have its strong laminations at the bottom of the beam. Install with proper side up as indicated by the manufacturer.
- Applicable calculations are based on NDS.

Supports	Bearing Length			Loads to Supports (lbs)			Accessories
	Total	Available	Required	Dead	Floor Live	Factored	
1 - Stud wall - HF	5.50"	5.50"	4.59"	2818	3682	6500	Blocking
2 - Stud wall - HF	5.50"	5.50"	4.72"	2894	3795	6690	Blocking

• Blocking Panels are assumed to carry no loads applied directly above them and the full load is applied to the member being designed.

Lateral Bracing	Bracing Intervals	Comments
Top Edge (Lu)	5' 10" o/c	
Bottom Edge (Lu)	5' 10" o/c	

•Maximum allowable bracing intervals based on applied load.

Vertical Loads	Location (Side)	Tributary Width	Dead (0.90)	Floor Live (1.00)	Comments
0 - Self Weight (PLF)	0 to 5' 10 1/4"	N/A	10.1	--	
1 - Uniform (PSF)	0 to 5' 10 1/4" (Front)	16' 2"	30.0	40.0	2nd Floor
2 - Uniform (PSF)	4' 8" to 5' 10 1/4" (Front)	16' 2"	30.0	40.0	3rd Floor
3 - Point (lb)	1 3/4" (Top)	N/A	1119	1462	Linked from: Grid 2.5 (D.4-D.6) Flush Beam, Support 1
4 - Point (lb)	4' 6 1/4" (Top)	N/A	1119	1462	Linked from: Grid 2.5 (D.4-D.6) Flush Beam, Support 2

Weyerhaeuser Notes

Weyerhaeuser warrants that the sizing of its products will be in accordance with Weyerhaeuser product design criteria and published design values. Weyerhaeuser expressly disclaims any other warranties related to the software. Use of this software is not intended to circumvent the need for a design professional as determined by the authority having jurisdiction. The designer of record, builder or framer is responsible to assure that this calculation is compatible with the overall project. Accessories (Rim Board, Blocking Panels and Squash Blocks) are not designed by this software. Products manufactured at Weyerhaeuser facilities are third-party certified to sustainable forestry standards. Weyerhaeuser Engineered Lumber Products have been evaluated by ICC-ES under evaluation reports ESR-1153 and ESR-1387 and/or tested in accordance with applicable ASTM standards. For current code evaluation reports, Weyerhaeuser product literature and installation details refer to www.woyehaeuser.com/woodproducts/document-library.

The product application, input design loads, dimensions and support information have been provided by ForteWEB Software Operator

ForteWEB Software Operator	Job Notes
Chon Pieruccioni Pieruccioni Engineering (206) 949-7866 cpieru@hotmail.com	



3/7/2024 3:51:26 PM UTC
 ForteWEB v3.7, Engine: V8.4.0.40, Data: V8.1.5.0

File Name: East Town Crossing Building E

2nd Floor Framing, Grid 3.3 (D.8-E.1) Flush Beam
1 piece(s) 3 1/2" x 11 7/8" 24F-V4 DF Glulam

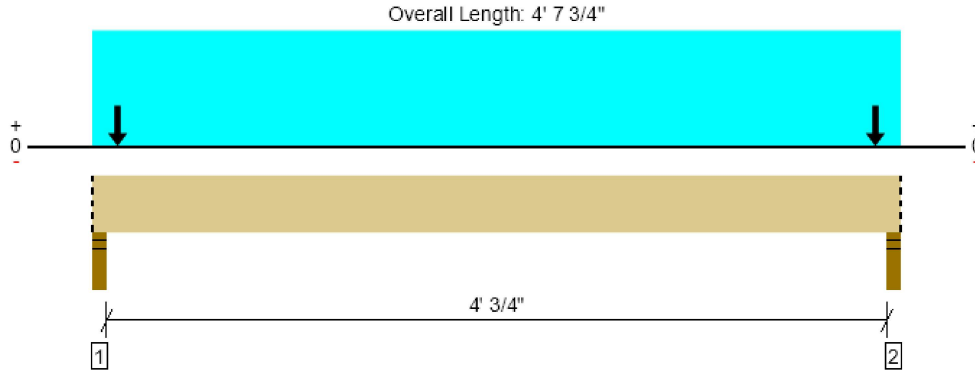

Drawing is Conceptual. All locations are measured from the outside face of left support (or left cantilever end). All dimensions are horizontal.

Design Results	Actual @ Location	Allowed	Result	LDF	Load: Combination (Pattern)
Member Reaction (lbs)	4302 @ 2"	4961 (3.50")	Passed (87%)	--	1.0 D + 1.0 L (All Spans)
Shear (lbs)	965 @ 1' 3 3/8"	7343	Passed (13%)	1.00	1.0 D + 1.0 L (All Spans)
Pos Moment (Ft-lbs)	2153 @ 2' 3 7/8"	16452	Passed (13%)	1.00	1.0 D + 1.0 L (All Spans)
Live Load Defl. (in)	0.005 @ 2' 3 7/8"	0.108	Passed (L/999+)	--	1.0 D + 1.0 L (All Spans)
Total Load Defl. (in)	0.008 @ 2' 3 7/8"	0.216	Passed (L/999+)	--	1.0 D + 1.0 L (All Spans)

Member Length : 4' 7 3/4"
 System : Floor
 Member Type : Flush Beam
 Building Use : Residential
 Building Code : IBC 2018
 Design Methodology : ASD

- Deflection criteria: LL (L/480) and TL (L/240).
- Allowed moment does not reflect the adjustment for the beam stability factor.
- Critical positive moment adjusted by a volume/size factor of 1.00 that was calculated using length L = 4' 3 3/4".
- The effects of positive or negative camber have not been accounted for when calculating deflection.
- The specified glulam is assumed to have its strong laminations at the bottom of the beam. Install with proper side up as indicated by the manufacturer.
- Applicable calculations are based on NDS.

Supports	Bearing Length			Loads to Supports (lbs)			Accessories
	Total	Available	Required	Dead	Floor Live	Factored	
1 - Stud wall - HF	3.50"	3.50"	3.03"	1870	2432	4302	Blocking
2 - Stud wall - HF	3.50"	3.50"	3.03"	1870	2432	4302	Blocking

• Blocking Panels are assumed to carry no loads applied directly above them and the full load is applied to the member being designed.

Lateral Bracing	Bracing Intervals	Comments
Top Edge (Lu)	4' 8" o/c	
Bottom Edge (Lu)	4' 8" o/c	

•Maximum allowable bracing intervals based on applied load.

Vertical Loads	Location (Side)	Tributary Width	Dead (0.90)	Floor Live (1.00)	Comments
0 - Self Weight (PLF)	0 to 4' 7 3/4"	N/A	10.1	--	
1 - Uniform (PSF)	0 to 4' 7 3/4" (Front)	13' 1"	30.0	40.0	Default Load
2 - Point (lb)	1 3/4" (Top)	N/A	935	1216	Linked from: Grid 3.3 (D.8-E.1) Flush Beam, Support 1
3 - Point (lb)	4' 6" (Top)	N/A	935	1216	Linked from: Grid 3.3 (D.8-E.1) Flush Beam, Support 2

Weyerhaeuser Notes

Weyerhaeuser warrants that the sizing of its products will be in accordance with Weyerhaeuser product design criteria and published design values. Weyerhaeuser expressly disclaims any other warranties related to the software. Use of this software is not intended to circumvent the need for a design professional as determined by the authority having jurisdiction. The designer of record, builder or framer is responsible to assure that this calculation is compatible with the overall project. Accessories (Rim Board, Blocking Panels and Squash Blocks) are not designed by this software. Products manufactured at Weyerhaeuser facilities are third-party certified to sustainable forestry standards. Weyerhaeuser Engineered Lumber Products have been evaluated by ICC-ES under evaluation reports ESR-1153 and ESR-1387 and/or tested in accordance with applicable ASTM standards. For current code evaluation reports, Weyerhaeuser product literature and installation details refer to www.weyerhaeuser.com/woodproducts/document-library.

The product application, input design loads, dimensions and support information have been provided by ForteWEB Software Operator

ForteWEB Software Operator	Job Notes
Chon Pieruccioni Pieruccioni Engineering (206) 949-7866 cpieru@hotmail.com	



2nd Floor Framing, Grid 5.3 (D.5-E.2) Flush Beam
1 piece(s) 3 1/2" x 11 7/8" 24F-V4 DF Glulam

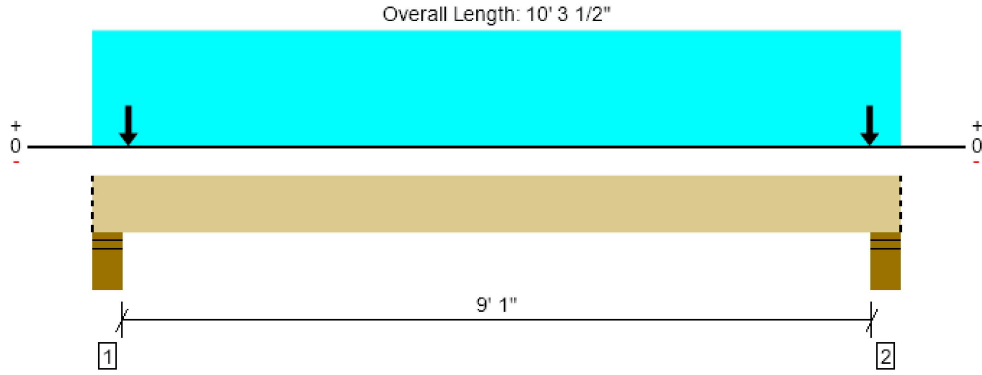

Drawing is Conceptual. All locations are measured from the outside face of left support (or left cantilever end). All dimensions are horizontal.

Design Results	Actual @ Location	Allowed	Result	LDF	Load: Combination (Pattern)
Member Reaction (lbs)	9240 @ 5 3/4"	10277 (7.25")	Passed (90%)	--	1.0 D + 1.0 L (All Spans)
Shear (lbs)	3289 @ 1' 7 1/8"	7343	Passed (45%)	1.00	1.0 D + 1.0 L (All Spans)
Pos Moment (Ft-lbs)	10082 @ 5' 1 3/4"	16452	Passed (61%)	1.00	1.0 D + 1.0 L (All Spans)
Live Load Defl. (in)	0.102 @ 5' 1 3/4"	0.233	Passed (L/999+)	--	1.0 D + 1.0 L (All Spans)
Total Load Defl. (in)	0.180 @ 5' 1 3/4"	0.467	Passed (L/623)	--	1.0 D + 1.0 L (All Spans)

Member Length : 10' 3 1/2"
 System : Floor
 Member Type : Flush Beam
 Building Use : Residential
 Building Code : IBC 2018
 Design Methodology : ASD

- Deflection criteria: LL (L/480) and TL (L/240).
- Allowed moment does not reflect the adjustment for the beam stability factor.
- Critical positive moment adjusted by a volume/size factor of 1.00 that was calculated using length L = 9' 4".
- The effects of positive or negative camber have not been accounted for when calculating deflection.
- The specified glulam is assumed to have its strong laminations at the bottom of the beam. Install with proper side up as indicated by the manufacturer.
- Applicable calculations are based on NDS.

Supports	Bearing Length			Loads to Supports (lbs)			Accessories
	Total	Available	Required	Dead	Floor Live	Factored	
1 - Stud wall - HF	7.25"	7.25"	6.52"	4018	5222	9240	Blocking
2 - Stud wall - HF	7.25"	7.25"	6.52"	4018	5222	9240	Blocking

• Blocking Panels are assumed to carry no loads applied directly above them and the full load is applied to the member being designed.

Lateral Bracing	Bracing Intervals	Comments
Top Edge (Lu)	10' 4" o/c	
Bottom Edge (Lu)	10' 4" o/c	

•Maximum allowable bracing intervals based on applied load.

Vertical Loads	Location (Side)	Tributary Width	Dead (0.90)	Floor Live (1.00)	Comments
0 - Self Weight (PLF)	0 to 10' 3 1/2"	N/A	10.1	--	
1 - Uniform (PSF)	0 to 10' 3 1/2" (Front)	13' 1"	30.0	40.0	Default Load
2 - Point (lb)	5 1/2" (Top)	N/A	1946	2529	Linked from: Grid 5.3 (D.5-E.2) Flush Beam, Support 1
3 - Point (lb)	9' 10 3/4" (Top)	N/A	1946	2529	Linked from: Grid 5.3 (D.5-E.2) Flush Beam, Support 2

Weyerhaeuser Notes
 Weyerhaeuser warrants that the sizing of its products will be in accordance with Weyerhaeuser product design criteria and published design values. Weyerhaeuser expressly disclaims any other warranties related to the software. Use of this software is not intended to circumvent the need for a design professional as determined by the authority having jurisdiction. The designer of record, builder or framer is responsible to assure that this calculation is compatible with the overall project. Accessories (Rim Board, Blocking Panels and Squash Blocks) are not designed by this software. Products manufactured at Weyerhaeuser facilities are third-party certified to sustainable forestry standards. Weyerhaeuser Engineered Lumber Products have been evaluated by ICC-ES under evaluation reports ESR-1153 and ESR-1387 and/or tested in accordance with applicable ASTM standards. For current code evaluation reports, Weyerhaeuser product literature and installation details refer to www.weyerhaeuser.com/woodproducts/document-library.
 The product application, input design loads, dimensions and support information have been provided by ForteWEB Software Operator

ForteWEB Software Operator	Job Notes
Chon Pieruccioni Pieruccioni Engineering (206) 949-7866 cpieru@hotmail.com	



2nd Floor Framing, Grid 6 (D.3-D.6) Flush Beam
1 piece(s) 3 1/2" x 11 7/8" 24F-V4 DF Glulam

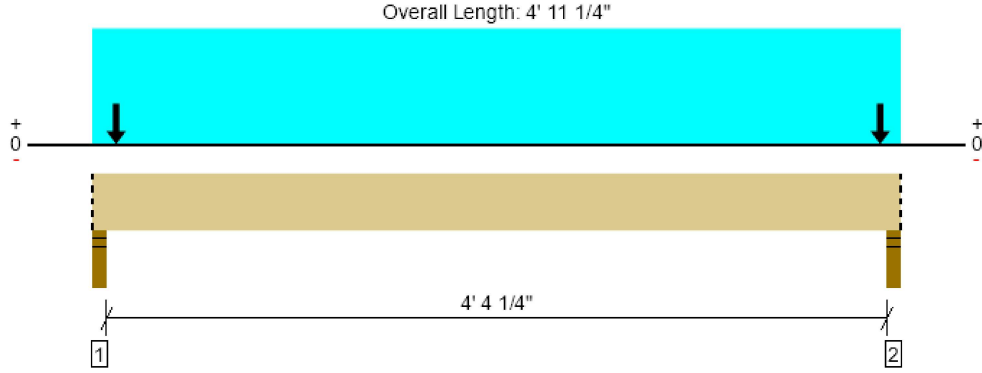

Drawing is Conceptual. All locations are measured from the outside face of left support (or left cantilever end). All dimensions are horizontal.

Design Results	Actual @ Location	Allowed	Result	LDF	Load: Combination (Pattern)
Member Reaction (lbs)	4744 @ 2"	4961 (3.50")	Passed (96%)	--	1.0 D + 1.0 L (All Spans)
Shear (lbs)	1141 @ 1' 3 3/8"	7343	Passed (16%)	1.00	1.0 D + 1.0 L (All Spans)
Pos Moment (Ft-lbs)	2546 @ 2' 5 5/8"	16452	Passed (15%)	1.00	1.0 D + 1.0 L (All Spans)
Live Load Defl. (in)	0.006 @ 2' 5 5/8"	0.115	Passed (L/999+)	--	1.0 D + 1.0 L (All Spans)
Total Load Defl. (in)	0.011 @ 2' 5 5/8"	0.230	Passed (L/999+)	--	1.0 D + 1.0 L (All Spans)

Member Length : 4' 11 1/4"
 System : Floor
 Member Type : Flush Beam
 Building Use : Residential
 Building Code : IBC 2018
 Design Methodology : ASD

- Deflection criteria: LL (L/480) and TL (L/240).
- Allowed moment does not reflect the adjustment for the beam stability factor.
- Critical positive moment adjusted by a volume/size factor of 1.00 that was calculated using length L = 4' 7 1/4".
- The effects of positive or negative camber have not been accounted for when calculating deflection.
- The specified glulam is assumed to have its strong laminations at the bottom of the beam. Install with proper side up as indicated by the manufacturer.
- Applicable calculations are based on NDS.

Supports	Bearing Length			Loads to Supports (lbs)			Accessories
	Total	Available	Required	Dead	Floor Live	Factored	
1 - Stud wall - HF	3.50"	3.50"	3.35"	2062	2682	4744	Blocking
2 - Stud wall - HF	3.50"	3.50"	3.35"	2062	2682	4744	Blocking

• Blocking Panels are assumed to carry no loads applied directly above them and the full load is applied to the member being designed.

Lateral Bracing	Bracing Intervals	Comments
Top Edge (Lu)	4' 11" o/c	
Bottom Edge (Lu)	4' 11" o/c	

•Maximum allowable bracing intervals based on applied load.

Vertical Loads	Location (Side)	Tributary Width	Dead (0.90)	Floor Live (1.00)	Comments
0 - Self Weight (PLF)	0 to 4' 11 1/4"	N/A	10.1	--	
1 - Uniform (PSF)	0 to 4' 11 1/4" (Front)	13' 7"	30.0	40.0	Default Load
2 - Point (lb)	1 3/4" (Top)	N/A	1031	1341	Linked from: Grid 6 (D.3-D.6) Flush Beam, Support 1
3 - Point (lb)	4' 9 3/4" (Back)	N/A	1031	1341	Linked from: Grid 6 (D.3-D.6) Flush Beam, Support 2

Weyerhaeuser Notes
 Weyerhaeuser warrants that the sizing of its products will be in accordance with Weyerhaeuser product design criteria and published design values. Weyerhaeuser expressly disclaims any other warranties related to the software. Use of this software is not intended to circumvent the need for a design professional as determined by the authority having jurisdiction. The designer of record, builder or framer is responsible to assure that this calculation is compatible with the overall project. Accessories (Rim Board, Blocking Panels and Squash Blocks) are not designed by this software. Products manufactured at Weyerhaeuser facilities are third-party certified to sustainable forestry standards. Weyerhaeuser Engineered Lumber Products have been evaluated by ICC-ES under evaluation reports ESR-1153 and ESR-1387 and/or tested in accordance with applicable ASTM standards. For current code evaluation reports, Weyerhaeuser product literature and installation details refer to www.weyerhaeuser.com/woodproducts/document-library.
 The product application, input design loads, dimensions and support information have been provided by ForteWEB Software Operator

ForteWEB Software Operator	Job Notes
Chon Pieruccioni Pieruccioni Engineering (206) 949-7866 cpieru@hotmail.com	



3rd Floor Framing, Floor Joist 16' and Under
1 piece(s) 11 7/8" TJI® 110 @ 16" OC

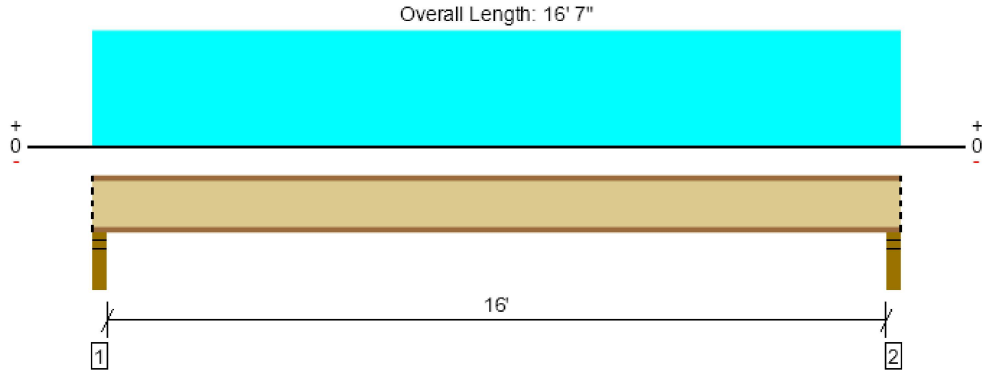

Drawing is Conceptual. All locations are measured from the outside face of left support (or left cantilever end). All dimensions are horizontal.

Design Results	Actual @ Location	Allowed	Result	LDF	Load: Combination (Pattern)
Member Reaction (lbs)	774 @ 2 1/2"	1375 (3.50")	Passed (56%)	1.00	1.0 D + 1.0 L (All Spans)
Shear (lbs)	747 @ 3 1/2"	1560	Passed (48%)	1.00	1.0 D + 1.0 L (All Spans)
Moment (Ft-lbs)	3049 @ 8' 3 1/2"	3160	Passed (96%)	1.00	1.0 D + 1.0 L (All Spans)
Live Load Defl. (in)	0.275 @ 8' 3 1/2"	0.539	Passed (L/704)	--	1.0 D + 1.0 L (All Spans)
Total Load Defl. (in)	0.482 @ 8' 3 1/2"	0.808	Passed (L/403)	--	1.0 D + 1.0 L (All Spans)
TJ-Pro™ Rating	48	40	Passed	--	--

Member Length : 16' 7"
 System : Floor
 Member Type : Joist
 Building Use : Residential
 Building Code : IBC 2018
 Design Methodology : ASD

- Deflection criteria: LL (L/360) and TL (L/240).
- Allowed moment does not reflect the adjustment for the beam stability factor.
- A structural analysis of the deck has not been performed.
- Deflection analysis is based on composite action with a single layer of 23/32" Weyerhaeuser Edge™ Panel (24" Span Rating) that is glued and nailed down.
- Additional considerations for the TJ-Pro™ Rating include: 5/8" Gypsum ceiling.

Supports	Bearing Length			Loads to Supports (lbs)			Accessories
	Total	Available	Required	Dead	Floor Live	Factored	
1 - Stud wall - HF	3.50"	3.50"	1.75"	332	442	774	Blocking
2 - Stud wall - HF	3.50"	3.50"	1.75"	332	442	774	Blocking

• Blocking Panels are assumed to carry no loads applied directly above them and the full load is applied to the member being designed.

Lateral Bracing	Bracing Intervals	Comments
Top Edge (Lu)	3' 1" o/c	
Bottom Edge (Lu)	16' 7" o/c	

- TJI joists are only analyzed using Maximum Allowable bracing solutions.
- Maximum allowable bracing intervals based on applied load.

Vertical Load	Location	Spacing	Dead (0.90)	Floor Live (1.00)	Comments
1 - Uniform (PSF)	0 to 16' 7"	16"	30.0	40.0	Default Load

Weyerhaeuser Notes
 Weyerhaeuser warrants that the sizing of its products will be in accordance with Weyerhaeuser product design criteria and published design values. Weyerhaeuser expressly disclaims any other warranties related to the software. Use of this software is not intended to circumvent the need for a design professional as determined by the authority having jurisdiction. The designer of record, builder or framer is responsible to assure that this calculation is compatible with the overall project. Accessories (Rim Board, Blocking Panels and Squash Blocks) are not designed by this software. Products manufactured at Weyerhaeuser facilities are third-party certified to sustainable forestry standards. Weyerhaeuser Engineered Lumber Products have been evaluated by ICC-ES under evaluation reports ESR-1153 and ESR-1387 and/or tested in accordance with applicable ASTM standards. For current code evaluation reports, Weyerhaeuser product literature and installation details refer to www.weyerhaeuser.com/woodproducts/document-library.
 The product application, input design loads, dimensions and support information have been provided by ForteWEB Software Operator

ForteWEB Software Operator	Job Notes
Chon Pieruccioni Pieruccioni Engineering (206) 949-7866 cpieru@hotmail.com	



3rd Floor Framing, Floor Joist 17'-8"
1 piece(s) 11 7/8" TJI@ 210 @ 16" OC

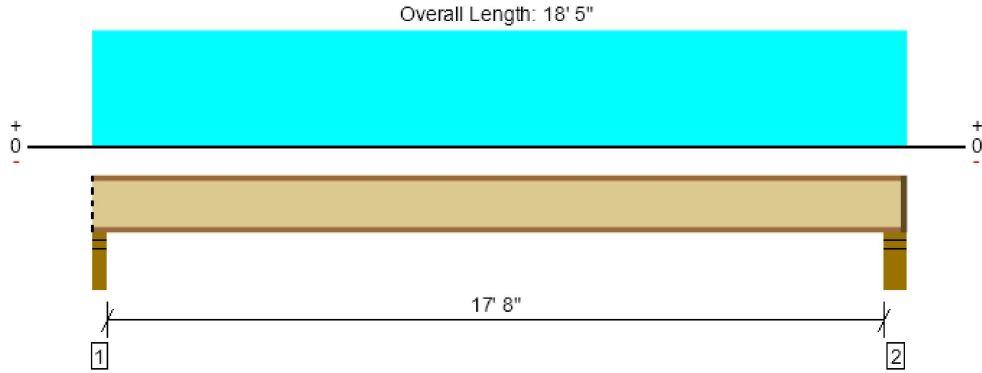

Drawing is Conceptual. All locations are measured from the outside face of left support (or left cantilever end). All dimensions are horizontal.

Design Results	Actual @ Location	Allowed	Result	LDF	Load: Combination (Pattern)
Member Reaction (lbs)	856 @ 18' 1/2"	1460 (3.50")	Passed (59%)	1.00	1.0 D + 1.0 L (All Spans)
Shear (lbs)	824 @ 3 1/2"	1655	Passed (50%)	1.00	1.0 D + 1.0 L (All Spans)
Moment (Ft-lbs)	3710 @ 9' 1 1/2"	3795	Passed (98%)	1.00	1.0 D + 1.0 L (All Spans)
Live Load Defl. (in)	0.352 @ 9' 1 1/2"	0.594	Passed (L/609)	--	1.0 D + 1.0 L (All Spans)
Total Load Defl. (in)	0.615 @ 9' 1 1/2"	0.892	Passed (L/348)	--	1.0 D + 1.0 L (All Spans)
TJ-Pro™ Rating	44	40	Passed	--	--

Member Length : 18' 3 1/2"
 System : Floor
 Member Type : Joist
 Building Use : Residential
 Building Code : IBC 2018
 Design Methodology : ASD

- Deflection criteria: LL (L/360) and TL (L/240).
- Allowed moment does not reflect the adjustment for the beam stability factor.
- A structural analysis of the deck has not been performed.
- Deflection analysis is based on composite action with a single layer of 23/32" Weyerhaeuser Edge™ Panel (24" Span Rating) that is glued and nailed down.
- Additional considerations for the TJ-Pro™ Rating include: 5/8" Gypsum ceiling.

Supports	Bearing Length			Loads to Supports (lbs)			Accessories
	Total	Available	Required	Dead	Floor Live	Factored	
1 - Stud wall - HF	3.50"	3.50"	1.75"	365	487	852	Blocking
2 - Stud wall - HF	5.50"	4.00"	1.75"	372	496	867	1 1/2" Rim Board

- Rim Board is assumed to carry all loads applied directly above it, bypassing the member being designed.
- Blocking Panels are assumed to carry no loads applied directly above them and the full load is applied to the member being designed.

Lateral Bracing	Bracing Intervals	Comments
Top Edge (Lu)	3' 7" o/c	
Bottom Edge (Lu)	18' 4" o/c	

- TJI joists are only analyzed using Maximum Allowable bracing solutions.
- Maximum allowable bracing intervals based on applied load.

Vertical Load	Location	Spacing	Dead (0.90)	Floor Live (1.00)	Comments
1 - Uniform (PSF)	0 to 18' 5"	16"	30.0	40.0	Default Load

Weyerhaeuser Notes
 Weyerhaeuser warrants that the sizing of its products will be in accordance with Weyerhaeuser product design criteria and published design values. Weyerhaeuser expressly disclaims any other warranties related to the software. Use of this software is not intended to circumvent the need for a design professional as determined by the authority having jurisdiction. The designer of record, builder or framer is responsible to assure that this calculation is compatible with the overall project. Accessories (Rim Board, Blocking Panels and Squash Blocks) are not designed by this software. Products manufactured at Weyerhaeuser facilities are third-party certified to sustainable forestry standards. Weyerhaeuser Engineered Lumber Products have been evaluated by ICC-ES under evaluation reports ESR-1153 and ESR-1387 and/or tested in accordance with applicable ASTM standards. For current code evaluation reports, Weyerhaeuser product literature and installation details refer to www.weyerhaeuser.com/woodproducts/document-library.
 The product application, input design loads, dimensions and support information have been provided by ForteWEB Software Operator

ForteWEB Software Operator	Job Notes
Chon Pieruccioni Pieruccioni Engineering (206) 949-7866 cpieru@hotmail.com	



3rd Floor Framing, Floor Joist 19'-4"
1 piece(s) 11 7/8" TJI@ 360 @ 16" OC

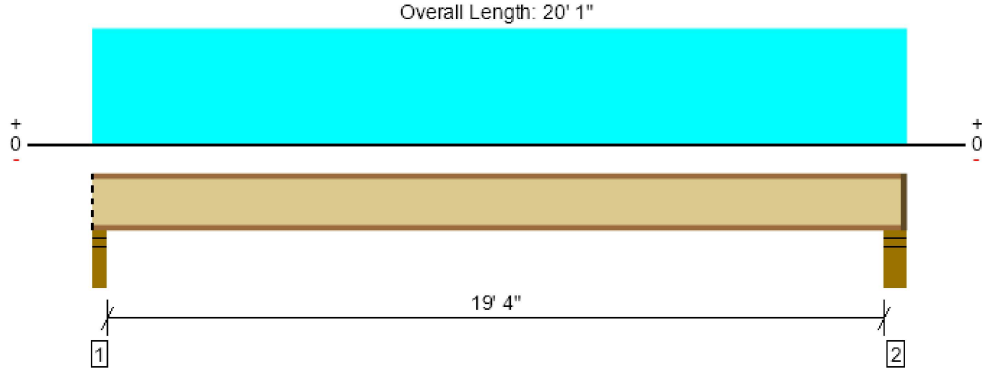

Drawing is Conceptual. All locations are measured from the outside face of left support (or left cantilever end). All dimensions are horizontal.

Design Results	Actual @ Location	Allowed	Result	LDF	Load: Combination (Pattern)
Member Reaction (lbs)	933 @ 19' 8 1/2"	1505 (3.50")	Passed (62%)	1.00	1.0 D + 1.0 L (All Spans)
Shear (lbs)	902 @ 3 1/2"	1705	Passed (53%)	1.00	1.0 D + 1.0 L (All Spans)
Moment (Ft-lbs)	4436 @ 9' 11 1/2"	6180	Passed (72%)	1.00	1.0 D + 1.0 L (All Spans)
Live Load Defl. (in)	0.395 @ 9' 11 1/2"	0.650	Passed (L/593)	--	1.0 D + 1.0 L (All Spans)
Total Load Defl. (in)	0.691 @ 9' 11 1/2"	0.975	Passed (L/339)	--	1.0 D + 1.0 L (All Spans)
TJ-Pro™ Rating	43	40	Passed	--	--

Member Length : 19' 11 1/2"
 System : Floor
 Member Type : Joist
 Building Use : Residential
 Building Code : IBC 2018
 Design Methodology : ASD

- Deflection criteria: LL (L/360) and TL (L/240).
- Allowed moment does not reflect the adjustment for the beam stability factor.
- A structural analysis of the deck has not been performed.
- Deflection analysis is based on composite action with a single layer of 23/32" Weyerhaeuser Edge™ Panel (24" Span Rating) that is glued and nailed down.
- Additional considerations for the TJ-Pro™ Rating include: 5/8" Gypsum ceiling.

Supports	Bearing Length			Loads to Supports (lbs)			Accessories
	Total	Available	Required	Dead	Floor Live	Factored	
1 - Stud wall - HF	3.50"	3.50"	1.75"	398	531	929	Blocking
2 - Stud wall - HF	5.50"	4.00"	1.75"	405	540	945	1 1/2" Rim Board

- Rim Board is assumed to carry all loads applied directly above it, bypassing the member being designed.
- Blocking Panels are assumed to carry no loads applied directly above them and the full load is applied to the member being designed.

Lateral Bracing	Bracing Intervals	Comments
Top Edge (Lu)	4' 4" o/c	
Bottom Edge (Lu)	20' o/c	

- TJI joists are only analyzed using Maximum Allowable bracing solutions.
- Maximum allowable bracing intervals based on applied load.

Vertical Load	Location	Spacing	Dead (0.90)	Floor Live (1.00)	Comments
1 - Uniform (PSF)	0 to 20' 1"	16"	30.0	40.0	Default Load

Weyerhaeuser Notes

Weyerhaeuser warrants that the sizing of its products will be in accordance with Weyerhaeuser product design criteria and published design values. Weyerhaeuser expressly disclaims any other warranties related to the software. Use of this software is not intended to circumvent the need for a design professional as determined by the authority having jurisdiction. The designer of record, builder or framer is responsible to assure that this calculation is compatible with the overall project. Accessories (Rim Board, Blocking Panels and Squash Blocks) are not designed by this software. Products manufactured at Weyerhaeuser facilities are third-party certified to sustainable forestry standards. Weyerhaeuser Engineered Lumber Products have been evaluated by ICC-ES under evaluation reports ESR-1153 and ESR-1387 and/or tested in accordance with applicable ASTM standards. For current code evaluation reports, Weyerhaeuser product literature and installation details refer to www.weyerhaeuser.com/woodproducts/document-library.

The product application, input design loads, dimensions and support information have been provided by ForteWEB Software Operator

ForteWEB Software Operator	Job Notes
Chon Pieruccioni Pieruccioni Engineering (206) 949-7866 cpieru@hotmail.com	



3rd Floor Framing, Floor Joist 20'-7"
1 piece(s) 11 7/8" TJI@ 560 @ 16" OC

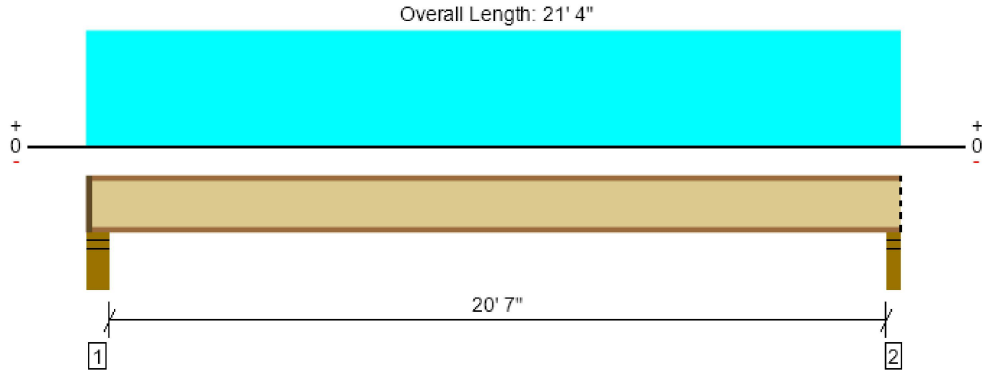

Drawing is Conceptual. All locations are measured from the outside face of left support (or left cantilever end). All dimensions are horizontal.

Design Results	Actual @ Location	Allowed	Result	LDF	Load: Combination (Pattern)
Member Reaction (lbs)	992 @ 4 1/2"	1725 (3.50")	Passed (57%)	1.00	1.0 D + 1.0 L (All Spans)
Shear (lbs)	961 @ 5 1/2"	2050	Passed (47%)	1.00	1.0 D + 1.0 L (All Spans)
Moment (Ft-lbs)	5023 @ 10' 9"	9500	Passed (53%)	1.00	1.0 D + 1.0 L (All Spans)
Live Load Defl. (in)	0.353 @ 10' 9"	0.692	Passed (L/706)	--	1.0 D + 1.0 L (All Spans)
Total Load Defl. (in)	0.617 @ 10' 9"	1.038	Passed (L/404)	--	1.0 D + 1.0 L (All Spans)
TJ-Pro™ Rating	46	40	Passed	--	--

Member Length : 21' 2 1/2"
 System : Floor
 Member Type : Joist
 Building Use : Residential
 Building Code : IBC 2018
 Design Methodology : ASD

- Deflection criteria: LL (L/360) and TL (L/240).
- Allowed moment does not reflect the adjustment for the beam stability factor.
- A structural analysis of the deck has not been performed.
- Deflection analysis is based on composite action with a single layer of 23/32" Weyerhaeuser Edge™ Panel (24" Span Rating) that is glued and nailed down.
- Additional considerations for the TJ-Pro™ Rating include: 5/8" Gypsum ceiling.

Supports	Bearing Length			Loads to Supports (lbs)			Accessories
	Total	Available	Required	Dead	Floor Live	Factored	
1 - Stud wall - HF	5.50"	4.00"	1.75"	430	573	1003	1 1/2" Rim Board
2 - Stud wall - HF	3.50"	3.50"	1.75"	423	564	988	Blocking

- Rim Board is assumed to carry all loads applied directly above it, bypassing the member being designed.
- Blocking Panels are assumed to carry no loads applied directly above them and the full load is applied to the member being designed.

Lateral Bracing	Bracing Intervals	Comments
Top Edge (Lu)	7' 10" o/c	
Bottom Edge (Lu)	21' 3" o/c	

- TJI joists are only analyzed using Maximum Allowable bracing solutions.
- Maximum allowable bracing intervals based on applied load.

Vertical Load	Location	Spacing	Dead (0.90)	Floor Live (1.00)	Comments
1 - Uniform (PSF)	0 to 21' 4"	16"	30.0	40.0	Default Load

Weyerhaeuser Notes
 Weyerhaeuser warrants that the sizing of its products will be in accordance with Weyerhaeuser product design criteria and published design values. Weyerhaeuser expressly disclaims any other warranties related to the software. Use of this software is not intended to circumvent the need for a design professional as determined by the authority having jurisdiction. The designer of record, builder or framer is responsible to assure that this calculation is compatible with the overall project. Accessories (Rim Board, Blocking Panels and Squash Blocks) are not designed by this software. Products manufactured at Weyerhaeuser facilities are third-party certified to sustainable forestry standards. Weyerhaeuser Engineered Lumber Products have been evaluated by ICC-ES under evaluation reports ESR-1153 and ESR-1387 and/or tested in accordance with applicable ASTM standards. For current code evaluation reports, Weyerhaeuser product literature and installation details refer to www.weyerhaeuser.com/woodproducts/document-library.
 The product application, input design loads, dimensions and support information have been provided by ForteWEB Software Operator

ForteWEB Software Operator	Job Notes
Chon Pieruccioni Pieruccioni Engineering (206) 949-7866 cpieru@hotmail.com	



3rd Floor Framing, 7'-6" Landing Joists
1 piece(s) 2 x 12 HF No.2 @ 16" OC

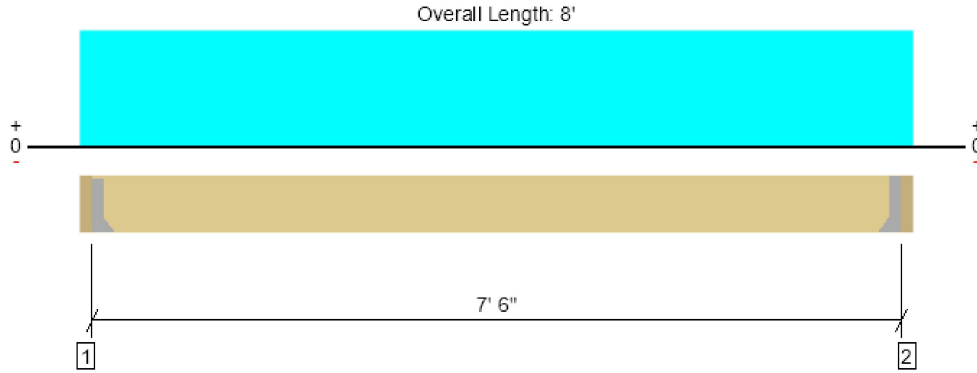

Drawing is Conceptual. All locations are measured from the outside face of left support (or left cantilever end). All dimensions are horizontal.

Design Results	Actual @ Location	Allowed	Result	LDF	Load: Combination (Pattern)
Member Reaction (lbs)	975 @ 3"	975 (1.60")	Passed (100%)	--	1.0 D + 1.0 L (All Spans)
Shear (lbs)	731 @ 1' 2 1/4"	1688	Passed (43%)	1.00	1.0 D + 1.0 L (All Spans)
Moment (Ft-lbs)	1828 @ 4'	2577	Passed (71%)	1.00	1.0 D + 1.0 L (All Spans)
Live Load Defl. (in)	0.062 @ 4'	0.250	Passed (L/999+)	--	1.0 D + 1.0 L (All Spans)
Total Load Defl. (in)	0.080 @ 4'	0.375	Passed (L/999+)	--	1.0 D + 1.0 L (All Spans)
TJ-Pro™ Rating	N/A	N/A	N/A	--	N/A

Member Length : 7' 6"
 System : Floor
 Member Type : Joist
 Building Use : Residential
 Building Code : IBC 2018
 Design Methodology : ASD

- Deflection criteria: LL (L/360) and TL (L/240).
- Allowed moment does not reflect the adjustment for the beam stability factor.
- A 15% increase in the moment capacity has been added to account for repetitive member usage.
- Applicable calculations are based on NDS.
- No composite action between deck and joist was considered in analysis.

Supports	Bearing Length			Loads to Supports (lbs)			Accessories
	Total	Available	Required	Dead	Floor Live	Factored	
1 - Hanger on 11 1/4" LSL beam	3.00"	Hanger ¹	1.60"	240	800	1040	See note ¹
2 - Hanger on 11 1/4" LSL beam	3.00"	Hanger ¹	1.60"	240	800	1040	See note ¹

- At hanger supports, the Total Bearing dimension is equal to the width of the material that is supporting the hanger
- ¹ See Connector grid below for additional information and/or requirements.

Lateral Bracing	Bracing Intervals	Comments
Top Edge (Lu)	5' 10" o/c	
Bottom Edge (Lu)	7' 6" o/c	

•Maximum allowable bracing intervals based on applied load.

Connector: Simpson Strong-Tie							
Support	Model	Seat Length	Top Fasteners	Face Fasteners	Member Fasteners	Accessories	
1 - Face Mount Hanger	LUS28	1.75"	N/A	6-10dx1.5	4-10d		
2 - Face Mount Hanger	LUS28	1.75"	N/A	6-10dx1.5	4-10d		

• Refer to manufacturer notes and instructions for proper installation and use of all connectors.

Vertical Load	Location (Side)	Spacing	Dead (0.90)	Floor Live (1.00)	Comments
1 - Uniform (PSF)	0 to 8'	16"	45.0	150.0	Default Load

Weyerhaeuser Notes

Weyerhaeuser warrants that the sizing of its products will be in accordance with Weyerhaeuser product design criteria and published design values. Weyerhaeuser expressly disclaims any other warranties related to the software. Use of this software is not intended to circumvent the need for a design professional as determined by the authority having jurisdiction. The designer of record, builder or framer is responsible to assure that this calculation is compatible with the overall project. Accessories (Rim Board, Blocking Panels and Squash Blocks) are not designed by this software. Products manufactured at Weyerhaeuser facilities are third-party certified to sustainable forestry standards. Weyerhaeuser Engineered Lumber Products have been evaluated by ICC-ES under evaluation reports ESR-1153 and ESR-1387 and/or tested in accordance with applicable ASTM standards. For current code evaluation reports, Weyerhaeuser product literature and installation details refer to www.weyerhaeuser.com/woodproducts/document-library.

The product application, input design loads, dimensions and support information have been provided by ForteWEB Software Operator

ForteWEB Software Operator	Job Notes
Chon Pieruccioni Pieruccioni Engineering (206) 949-7866 cpieru@hotmail.com	



3rd Floor Framing, Top Landing Beam
1 piece(s) 5 1/2" x 12" 24F-V4 DF Glulam

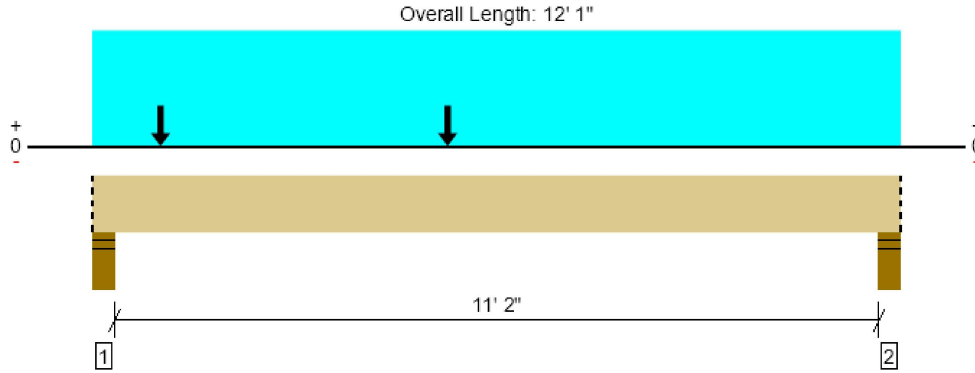

Drawing is Conceptual. All locations are measured from the outside face of left support (or left cantilever end). All dimensions are horizontal.

Design Results	Actual @ Location	Allowed	Result	LDF	Load: Combination (Pattern)
Member Reaction (lbs)	9199 @ 4"	12251 (5.50")	Passed (75%)	--	1.0 D + 1.0 L (All Spans)
Shear (lbs)	6904 @ 1' 5 1/2"	11660	Passed (59%)	1.00	1.0 D + 1.0 L (All Spans)
Pos Moment (Ft-lbs)	23175 @ 5' 4 3/8"	26400	Passed (88%)	1.00	1.0 D + 1.0 L (All Spans)
Live Load Defl. (in)	0.282 @ 5' 11 15/16"	0.285	Passed (L/486)	--	1.0 D + 1.0 L (All Spans)
Total Load Defl. (in)	0.372 @ 5' 11 15/16"	0.571	Passed (L/368)	--	1.0 D + 1.0 L (All Spans)

Member Length : 12' 1"
 System : Floor
 Member Type : Flush Beam
 Building Use : Residential
 Building Code : IBC 2018
 Design Methodology : ASD

- Deflection criteria: LL (L/480) and TL (L/240).
- Allowed moment does not reflect the adjustment for the beam stability factor.
- Critical positive moment adjusted by a volume/size factor of 1.00 that was calculated using length L = 11' 5".
- The effects of positive or negative camber have not been accounted for when calculating deflection.
- The specified glulam is assumed to have its strong laminations at the bottom of the beam. Install with proper side up as indicated by the manufacturer.
- Applicable calculations are based on NDS.

Supports	Bearing Length			Loads to Supports (lbs)			Accessories
	Total	Available	Required	Dead	Floor Live	Factored	
1 - Stud wall - HF	5.50"	5.50"	4.13"	2239	6960	9199	Blocking
2 - Stud wall - HF	5.50"	5.50"	3.43"	1851	5788	7639	Blocking

• Blocking Panels are assumed to carry no loads applied directly above them and the full load is applied to the member being designed.

Lateral Bracing	Bracing Intervals	Comments
Top Edge (Lu)	12' 1" o/c	
Bottom Edge (Lu)	12' 1" o/c	

•Maximum allowable bracing intervals based on applied load.

Vertical Loads	Location (Side)	Tributary Width	Dead (0.90)	Floor Live (1.00)	Comments
0 - Self Weight (PLF)	0 to 12' 1"	N/A	16.0	--	
1 - Uniform (PSF)	0 to 12' 1" (Front)	5' 9"	45.0	150.0	Default Load
2 - Point (lb)	1' 1/4" (Front)	N/A	385	1163	Linked from: Short Stair Stringers, Support 1
3 - Point (lb)	5' 3 3/4" (Front)	N/A	385	1163	Linked from: Short Stair Stringers, Support 1

Weyerhaeuser Notes

Weyerhaeuser warrants that the sizing of its products will be in accordance with Weyerhaeuser product design criteria and published design values. Weyerhaeuser expressly disclaims any other warranties related to the software. Use of this software is not intended to circumvent the need for a design professional as determined by the authority having jurisdiction. The designer of record, builder or framer is responsible to assure that this calculation is compatible with the overall project. Accessories (Rim Board, Blocking Panels and Squash Blocks) are not designed by this software. Products manufactured at Weyerhaeuser facilities are third-party certified to sustainable forestry standards. Weyerhaeuser Engineered Lumber Products have been evaluated by ICC-ES under evaluation reports ESR-1153 and ESR-1387 and/or tested in accordance with applicable ASTM standards. For current code evaluation reports, Weyerhaeuser product literature and installation details refer to www.woyehaeuser.com/woodproducts/document-library.

The product application, input design loads, dimensions and support information have been provided by ForteWEB Software Operator

ForteWEB Software Operator	Job Notes
Chon Pieruccioni Pieruccioni Engineering (206) 949-7866 cpieru@hotmail.com	



3rd Floor Framing, Short Stair Stringers
1 piece(s) 4 x 12 HF No.2

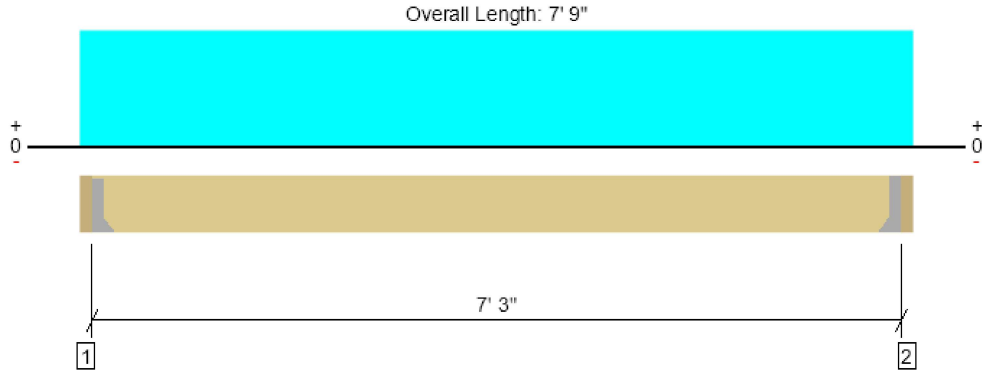

Drawing is Conceptual. All locations are measured from the outside face of left support (or left cantilever end). All dimensions are horizontal.

Design Results	Actual @ Location	Allowed	Result	LDF	Load: Combination (Pattern)
Member Reaction (lbs)	1450 @ 3"	2126 (1.50")	Passed (68%)	--	1.0 D + 1.0 L (All Spans)
Shear (lbs)	1075 @ 1' 2 1/4"	3938	Passed (27%)	1.00	1.0 D + 1.0 L (All Spans)
Moment (Ft-lbs)	2628 @ 3' 10 1/2"	5752	Passed (46%)	1.00	1.0 D + 1.0 L (All Spans)
Live Load Defl. (in)	0.035 @ 3' 10 1/2"	0.181	Passed (L/999+)	--	1.0 D + 1.0 L (All Spans)
Total Load Defl. (in)	0.046 @ 3' 10 1/2"	0.363	Passed (L/999+)	--	1.0 D + 1.0 L (All Spans)

Member Length : 7' 3"
 System : Floor
 Member Type : Flush Beam
 Building Use : Residential
 Building Code : IBC 2018
 Design Methodology : ASD

- Deflection criteria: LL (L/480) and TL (L/240).
- Allowed moment does not reflect the adjustment for the beam stability factor.
- Applicable calculations are based on NDS.

Supports	Bearing Length			Loads to Supports (lbs)			Accessories
	Total	Available	Required	Dead	Floor Live	Factored	
1 - Hanger on 11 1/4" GLB beam	3.00"	Hanger ¹	1.50"	385	1163	1547	See note ¹
2 - Hanger on 11 1/4" GLB beam	3.00"	Hanger ¹	1.50"	385	1163	1547	See note ¹

- At hanger supports, the Total Bearing dimension is equal to the width of the material that is supporting the hanger
- ¹ See Connector grid below for additional information and/or requirements.

Lateral Bracing	Bracing Intervals	Comments
Top Edge (Lu)	7' 3" o/c	
Bottom Edge (Lu)	7' 3" o/c	

•Maximum allowable bracing intervals based on applied load.

Connector: Simpson Strong-Tie							
Support	Model	Seat Length	Top Fasteners	Face Fasteners	Member Fasteners	Accessories	
1 - Face Mount Hanger	LUS410	2.00"	N/A	8-10d	6-10d		
2 - Face Mount Hanger	LUS410	2.00"	N/A	8-10d	6-10d		

• Refer to manufacturer notes and instructions for proper installation and use of all connectors.

Vertical Loads	Location (Side)	Tributary Width	Dead (0.90)	Floor Live (1.00)	Comments
0 - Self Weight (PLF)	3" to 7' 6"	N/A	10.0	--	
1 - Uniform (PSF)	0 to 7' 9" (Front)	2'	45.0	150.0	Default Load

Weyerhaeuser Notes
 Weyerhaeuser warrants that the sizing of its products will be in accordance with Weyerhaeuser product design criteria and published design values. Weyerhaeuser expressly disclaims any other warranties related to the software. Use of this software is not intended to circumvent the need for a design professional as determined by the authority having jurisdiction. The designer of record, builder or framer is responsible to assure that this calculation is compatible with the overall project. Accessories (Rim Board, Blocking Panels and Squash Blocks) are not designed by this software. Products manufactured at Weyerhaeuser facilities are third-party certified to sustainable forestry standards. Weyerhaeuser Engineered Lumber Products have been evaluated by ICC-ES under evaluation reports ESR-1153 and ESR-1387 and/or tested in accordance with applicable ASTM standards. For current code evaluation reports, Weyerhaeuser product literature and installation details refer to www.weyerhaeuser.com/woodproducts/document-library.
 The product application, input design loads, dimensions and support information have been provided by ForteWEB Software Operator

ForteWEB Software Operator	Job Notes
Chon Pieruccioni Pieruccioni Engineering (206) 949-7866 cpieru@hotmail.com	



3rd Floor Framing, 4' Mid Landing Joists
1 piece(s) 2 x 12 HF No.2 @ 16" OC

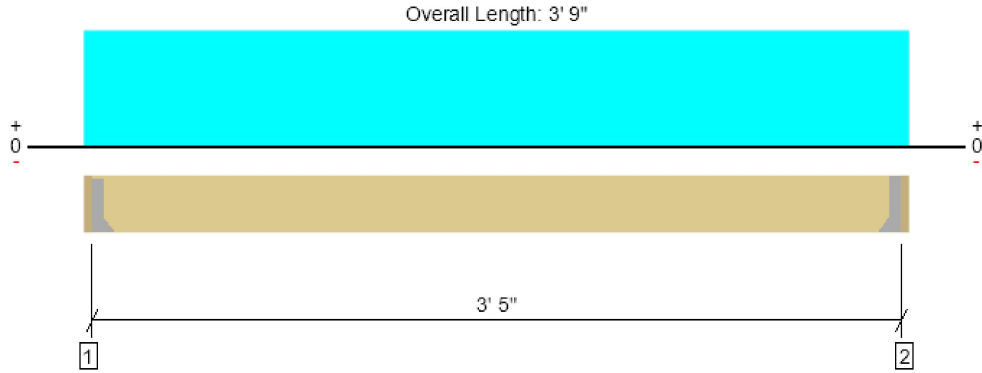

Drawing is Conceptual. All locations are measured from the outside face of left support (or left cantilever end). All dimensions are horizontal.

Design Results	Actual @ Location	Allowed	Result	LDF	Load: Combination (Pattern)
Member Reaction (lbs)	444 @ 2"	911 (1.50")	Passed (49%)	--	1.0 D + 1.0 L (All Spans)
Shear (lbs)	200 @ 1' 1 1/4"	1688	Passed (12%)	1.00	1.0 D + 1.0 L (All Spans)
Moment (Ft-lbs)	379 @ 1' 10 1/2"	2577	Passed (15%)	1.00	1.0 D + 1.0 L (All Spans)
Live Load Defl. (in)	0.003 @ 1' 10 1/2"	0.114	Passed (L/999+)	--	1.0 D + 1.0 L (All Spans)
Total Load Defl. (in)	0.003 @ 1' 10 1/2"	0.171	Passed (L/999+)	--	1.0 D + 1.0 L (All Spans)
TJ-Pro™ Rating	N/A	N/A	N/A	--	N/A

Member Length : 3' 5"
 System : Floor
 Member Type : Joist
 Building Use : Residential
 Building Code : IBC 2018
 Design Methodology : ASD

- Deflection criteria: LL (L/360) and TL (L/240).
- Allowed moment does not reflect the adjustment for the beam stability factor.
- A 15% increase in the moment capacity has been added to account for repetitive member usage.
- Applicable calculations are based on NDS.
- No composite action between deck and joist was considered in analysis.

Supports	Bearing Length			Loads to Supports (lbs)			Accessories
	Total	Available	Required	Dead	Floor Live	Factored	
1 - Hanger on 11 1/4" LSL beam	2.00"	Hanger ¹	1.50"	113	375	488	See note ¹
2 - Hanger on 11 1/4" LSL beam	2.00"	Hanger ¹	1.50"	113	375	488	See note ¹

- At hanger supports, the Total Bearing dimension is equal to the width of the material that is supporting the hanger
- ¹ See Connector grid below for additional information and/or requirements.

Lateral Bracing	Bracing Intervals	Comments
Top Edge (Lu)	3' 5" o/c	
Bottom Edge (Lu)	3' 5" o/c	

•Maximum allowable bracing intervals based on applied load.

Connector: Simpson Strong-Tie							
Support	Model	Seat Length	Top Fasteners	Face Fasteners	Member Fasteners	Accessories	
1 - Face Mount Hanger	LUS28	1.75"	N/A	6-10dx1.5	3-10d		
2 - Face Mount Hanger	LUS28	1.75"	N/A	6-10dx1.5	3-10d		

• Refer to manufacturer notes and instructions for proper installation and use of all connectors.

Vertical Load	Location (Side)	Spacing	Dead (0.90)	Floor Live (1.00)	Comments
1 - Uniform (PSF)	0 to 3' 9"	16"	45.0	150.0	Default Load

Weyerhaeuser Notes
 Weyerhaeuser warrants that the sizing of its products will be in accordance with Weyerhaeuser product design criteria and published design values. Weyerhaeuser expressly disclaims any other warranties related to the software. Use of this software is not intended to circumvent the need for a design professional as determined by the authority having jurisdiction. The designer of record, builder or framer is responsible to assure that this calculation is compatible with the overall project. Accessories (Rim Board, Blocking Panels and Squash Blocks) are not designed by this software. Products manufactured at Weyerhaeuser facilities are third-party certified to sustainable forestry standards. Weyerhaeuser Engineered Lumber Products have been evaluated by ICC-ES under evaluation reports ESR-1153 and ESR-1387 and/or tested in accordance with applicable ASTM standards. For current code evaluation reports, Weyerhaeuser product literature and installation details refer to www.weyerhaeuser.com/woodproducts/document-library.
 The product application, input design loads, dimensions and support information have been provided by ForteWEB Software Operator

ForteWEB Software Operator	Job Notes
Chon Pieruccioni Pieruccioni Engineering (206) 949-7866 cpieru@hotmail.com	



3rd Floor Framing, Mid Landing Beam
1 piece(s) 3 1/2" x 12" 24F-V4 DF Glulam

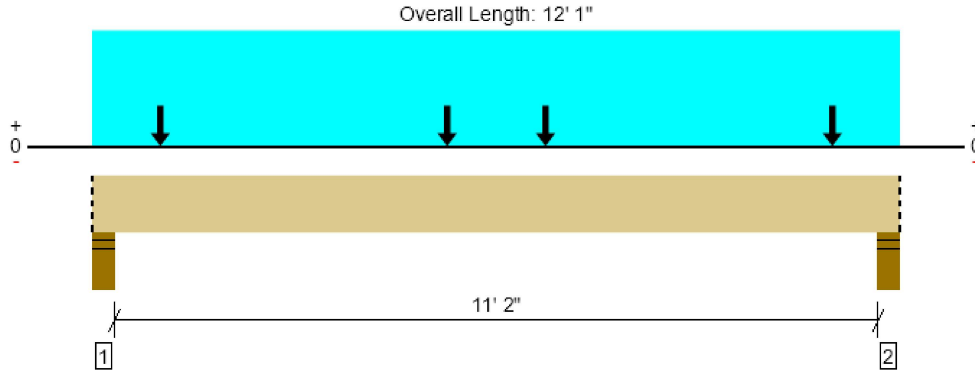

Drawing is Conceptual. All locations are measured from the outside face of left support (or left cantilever end). All dimensions are horizontal.

Design Results	Actual @ Location	Allowed	Result	LDF	Load: Combination (Pattern)
Member Reaction (lbs)	5517 @ 11' 9"	7796 (5.50")	Passed (71%)	--	1.0 D + 1.0 L (All Spans)
Shear (lbs)	4291 @ 1' 5 1/2"	7420	Passed (58%)	1.00	1.0 D + 1.0 L (All Spans)
Pos Moment (Ft-lbs)	15276 @ 6' 7/16"	16800	Passed (91%)	1.00	1.0 D + 1.0 L (All Spans)
Live Load Defl. (in)	0.285 @ 6' 1/2"	0.285	Passed (L/481)	--	1.0 D + 1.0 L (All Spans)
Total Load Defl. (in)	0.380 @ 6' 1/2"	0.571	Passed (L/361)	--	1.0 D + 1.0 L (All Spans)

Member Length : 12' 1"
 System : Floor
 Member Type : Flush Beam
 Building Use : Residential
 Building Code : IBC 2018
 Design Methodology : ASD

- Deflection criteria: LL (L/480) and TL (L/240).
- Allowed moment does not reflect the adjustment for the beam stability factor.
- Critical positive moment adjusted by a volume/size factor of 1.00 that was calculated using length L = 11' 5".
- The effects of positive or negative camber have not been accounted for when calculating deflection.
- The specified glulam is assumed to have its strong laminations at the bottom of the beam. Install with proper side up as indicated by the manufacturer.
- Applicable calculations are based on NDS.

Supports	Bearing Length			Loads to Supports (lbs)			Accessories
	Total	Available	Required	Dead	Floor Live	Factored	
1 - Stud wall - HF	5.50"	5.50"	3.89"	1375	4136	5511	Blocking
2 - Stud wall - HF	5.50"	5.50"	3.89"	1376	4141	5517	Blocking

• Blocking Panels are assumed to carry no loads applied directly above them and the full load is applied to the member being designed.

Lateral Bracing	Bracing Intervals	Comments
Top Edge (Lu)	12' 1" o/c	
Bottom Edge (Lu)	12' 1" o/c	

•Maximum allowable bracing intervals based on applied load.

Vertical Loads	Location (Side)	Tributary Width	Dead (0.90)	Floor Live (1.00)	Comments
0 - Self Weight (PLF)	0 to 12' 1"	N/A	10.2	--	
1 - Uniform (PSF)	0 to 12' 1" (Front)	2'	45.0	150.0	Default Load
2 - Point (lb)	1' 1/4" (Front)	N/A	385	1163	Linked from: Short Stair Stringers, Support 1
3 - Point (lb)	5' 3 3/4" (Front)	N/A	385	1163	Linked from: Short Stair Stringers, Support 1
4 - Point (lb)	6' 9 3/8" (Front)	N/A	385	1163	Linked from: Short Stair Stringers, Support 1
5 - Point (lb)	11' 7/8" (Front)	N/A	385	1163	Linked from: Short Stair Stringers, Support 1

FORTEWEB Software Operator	Job Notes
Chon Pieruccioni Pieruccioni Engineering (206) 949-7866 cpieru@hotmail.com	



Weyerhaeuser Notes

Weyerhaeuser warrants that the sizing of its products will be in accordance with Weyerhaeuser product design criteria and published design values. Weyerhaeuser expressly disclaims any other warranties related to the software. Use of this software is not intended to circumvent the need for a design professional as determined by the authority having jurisdiction. The designer of record, builder or framer is responsible to assure that this calculation is compatible with the overall project. Accessories (Rim Board, Blocking Panels and Squash Blocks) are not designed by this software. Products manufactured at Weyerhaeuser facilities are third-party certified to sustainable forestry standards. Weyerhaeuser Engineered Lumber Products have been evaluated by ICC-ES under evaluation reports ESR-1153 and ESR-1387 and/or tested in accordance with applicable ASTM standards. For current code evaluation reports, Weyerhaeuser product literature and installation details refer to www.weyerhaeuser.com/woodproducts/document-library.

The product application, input design loads, dimensions and support information have been provided by ForteWEB Software Operator

ForteWEB Software Operator	Job Notes
Chon Pieruccioni Pieruccioni Engineering (206) 949-7866 cpieru@hotmail.com	



3rd Floor Framing, 10'-10" Deck Joist
1 piece(s) 2 x 12 HF No.2 @ 16" OC

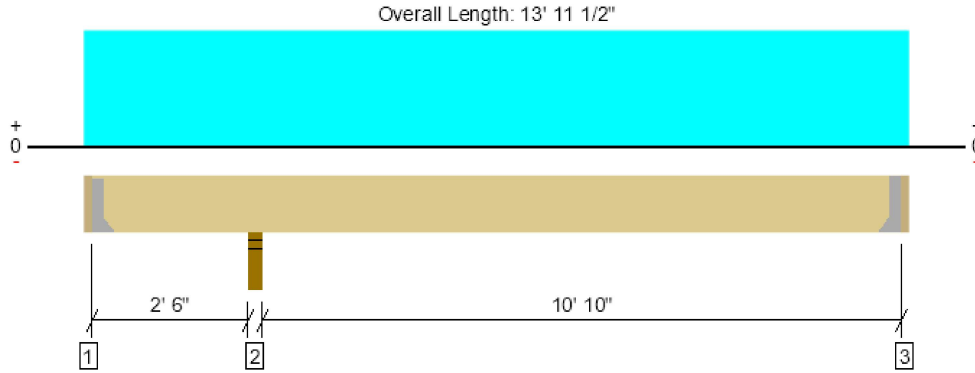

Drawing is Conceptual. All locations are measured from the outside face of left support (or left cantilever end). All dimensions are horizontal.

Design Results	Actual @ Location	Allowed	Result	LDF	Load: Combination (Pattern)
Member Reaction (lbs)	1510 @ 2' 9 3/4"	2126 (3.50")	Passed (71%)	--	1.0 D + 1.0 L (All Spans)
Shear (lbs)	663 @ 3' 10 3/4"	1688	Passed (39%)	1.00	1.0 D + 1.0 L (All Spans)
Moment (Ft-lbs)	-1477 @ 2' 9 3/4"	2577	Passed (57%)	1.00	1.0 D + 1.0 L (All Spans)
Live Load Defl. (in)	0.059 @ 8' 10 11/16"	0.366	Passed (L/999+)	--	1.0 D + 1.0 L (Alt Spans)
Total Load Defl. (in)	0.089 @ 8' 10 3/4"	0.549	Passed (L/999+)	--	1.0 D + 1.0 L (Alt Spans)
TJ-Pro™ Rating	N/A	N/A	N/A	--	N/A

Member Length : 13' 7 1/2"
 System : Floor
 Member Type : Joist
 Building Use : Residential
 Building Code : IBC 2018
 Design Methodology : ASD

- Deflection criteria: LL (L/360) and TL (L/240).
- Allowed moment does not reflect the adjustment for the beam stability factor.
- A 15% increase in the moment capacity has been added to account for repetitive member usage.
- -480 lbs uplift at support located at 2". Strapping or other restraint may be required.
- Applicable calculations are based on NDS.
- No composite action between deck and joist was considered in analysis.

Supports	Bearing Length			Loads to Supports (lbs)			Accessories
	Total	Available	Required	Dead	Floor Live	Factored	
1 - Hanger on 11 1/4" HF beam	2.00"	Hanger ¹	1.50"	-127	114/-354	-480	See note ¹
2 - Stud wall - HF	3.50"	3.50"	2.49"	503	1007	1510	None
3 - Hanger on 11 1/4" HF beam	2.00"	Hanger ¹	1.50"	181	364	545	See note ¹

- At hanger supports, the Total Bearing dimension is equal to the width of the material that is supporting the hanger
- ¹ See Connector grid below for additional information and/or requirements.

Lateral Bracing	Bracing Intervals	Comments
Top Edge (Lu)	11' o/c	
Bottom Edge (Lu)	7' 11" o/c	

•Maximum allowable bracing intervals based on applied load.

Connector: Simpson Strong-Tie							
Support	Model	Seat Length	Top Fasteners	Face Fasteners	Member Fasteners	Accessories	
1 - Face Mount Hanger	LUS28	1.75"	N/A	6-10dx1.5	3-10d		
3 - Face Mount Hanger	LUS28	1.75"	N/A	6-10dx1.5	3-10d		

- Refer to manufacturer notes and instructions for proper installation and use of all connectors.

Vertical Load	Location (Side)	Spacing	Dead (0.90)	Floor Live (1.00)	Comments
1 - Uniform (PSF)	0 to 13' 11 1/2"	16"	30.0	60.0	Default Load

Weyerhaeuser Notes
 Weyerhaeuser warrants that the sizing of its products will be in accordance with Weyerhaeuser product design criteria and published design values. Weyerhaeuser expressly disclaims any other warranties related to the software. Use of this software is not intended to circumvent the need for a design professional as determined by the authority having jurisdiction. The designer of record, builder or framer is responsible to assure that this calculation is compatible with the overall project. Accessories (Rim Board, Blocking Panels and Squash Blocks) are not designed by this software. Products manufactured at Weyerhaeuser facilities are third-party certified to sustainable forestry standards. Weyerhaeuser Engineered Lumber Products have been evaluated by ICC-ES under evaluation reports ESR-1153 and ESR-1387 and/or tested in accordance with applicable ASTM standards. For current code evaluation reports, Weyerhaeuser product literature and installation details refer to www.woyehaeuser.com/woodproducts/document-library.
 The product application, input design loads, dimensions and support information have been provided by ForteWEB Software Operator

ForteWEB Software Operator	Job Notes
Chon Pieruccioni Pieruccioni Engineering (206) 949-7866 cpieru@hotmail.com	



3rd Floor Framing, Deck Cantilever Ledger 2'
2 piece(s) 2 x 12 HF No.2

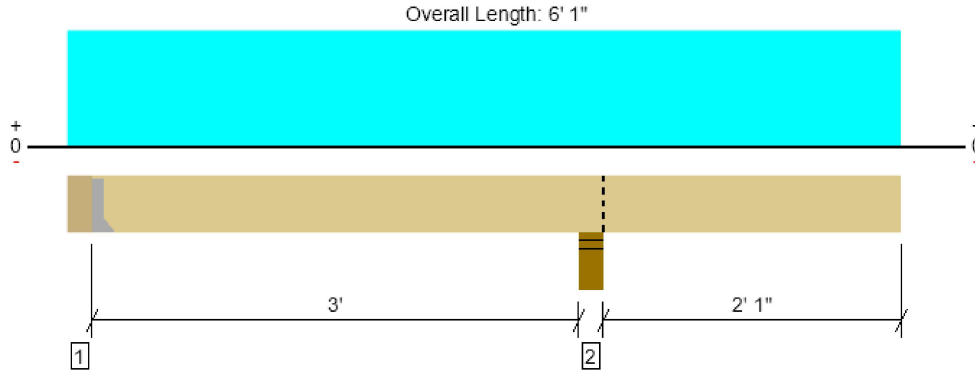

Drawing is Conceptual. All locations are measured from the outside face of left support (or left cantilever end). All dimensions are horizontal.

Design Results	Actual @ Location	Allowed	Result	LDF	Load: Combination (Pattern)
Member Reaction (lbs)	855 @ 6"	1823 (1.50")	Passed (47%)	--	1.0 D + 1.0 L (Alt Spans)
Shear (lbs)	814 @ 2' 6 3/4"	3375	Passed (24%)	1.00	1.0 D + 1.0 L (All Spans)
Moment (Ft-lbs)	-1738 @ 3' 9"	4482	Passed (39%)	1.00	1.0 D + 1.0 L (All Spans)
Live Load Defl. (in)	0.017 @ 6' 1"	0.200	Passed (2L/999+)	--	1.0 D + 1.0 L (Alt Spans)
Total Load Defl. (in)	0.023 @ 6' 1"	0.233	Passed (2L/999+)	--	1.0 D + 1.0 L (Alt Spans)

Member Length : 5' 7"
 System : Floor
 Member Type : Flush Beam
 Building Use : Residential
 Building Code : IBC 2018
 Design Methodology : ASD

- Deflection criteria: LL (L/360) and TL (L/240).
- Overhang deflection criteria: LL (0.2") and TL (2L/240).
- Right cantilever length exceeds 1/3 member length or 1/2 back span length. Additional bracing should be considered.
- Allowed moment does not reflect the adjustment for the beam stability factor.
- Applicable calculations are based on NDS.

Supports	Bearing Length			Loads to Supports (lbs)			Accessories
	Total	Available	Required	Dead	Floor Live	Factored	
1 - Hanger on 11 1/4" HF beam	6.00"	Hanger ¹	1.50"	277	893/-142	1170	See note ¹
2 - Stud wall - HF	6.00"	6.00"	2.52"	1048	2014	3062	Blocking

- Blocking Panels are assumed to carry no loads applied directly above them and the full load is applied to the member being designed.
- At hanger supports, the Total Bearing dimension is equal to the width of the material that is supporting the hanger
- ¹ See Connector grid below for additional information and/or requirements.

Lateral Bracing	Bracing Intervals	Comments
Top Edge (Lu)	5' 7" o/c	
Bottom Edge (Lu)	5' 7" o/c	

•Maximum allowable bracing intervals based on applied load.

Connector: Simpson Strong-Tie							
Support	Model	Seat Length	Top Fasteners	Face Fasteners	Member Fasteners	Accessories	
1 - Face Mount Hanger	LUS28-2	2.00"	N/A	6-10d	3-10d		

- Refer to manufacturer notes and instructions for proper installation and use of all connectors.

Vertical Loads	Location (Side)	Tributary Width	Dead (0.90)	Floor Live (1.00)	Comments
0 - Self Weight (PLF)	6" to 6' 1"	N/A	8.6	--	
1 - Uniform (PSF)	0 to 6' 1" (Front)	7'	30.0	60.0	Default Load

Weyerhaeuser Notes

Weyerhaeuser warrants that the sizing of its products will be in accordance with Weyerhaeuser product design criteria and published design values. Weyerhaeuser expressly disclaims any other warranties related to the software. Use of this software is not intended to circumvent the need for a design professional as determined by the authority having jurisdiction. The designer of record, builder or framer is responsible to assure that this calculation is compatible with the overall project. Accessories (Rim Board, Blocking Panels and Squash Blocks) are not designed by this software. Products manufactured at Weyerhaeuser facilities are third-party certified to sustainable forestry standards. Weyerhaeuser Engineered Lumber Products have been evaluated by ICC-ES under evaluation reports ESR-1153 and ESR-1387 and/or tested in accordance with applicable ASTM standards. For current code evaluation reports, Weyerhaeuser product literature and installation details refer to www.weyerhaeuser.com/woodproducts/document-library.

The product application, input design loads, dimensions and support information have been provided by ForteWEB Software Operator

ForteWEB Software Operator	Job Notes
Chon Pieruccioni Pieruccioni Engineering (206) 949-7866 cpieru@hotmail.com	



3rd Floor Framing, 6' Window Header
1 piece(s) 4 x 10 DF No.2

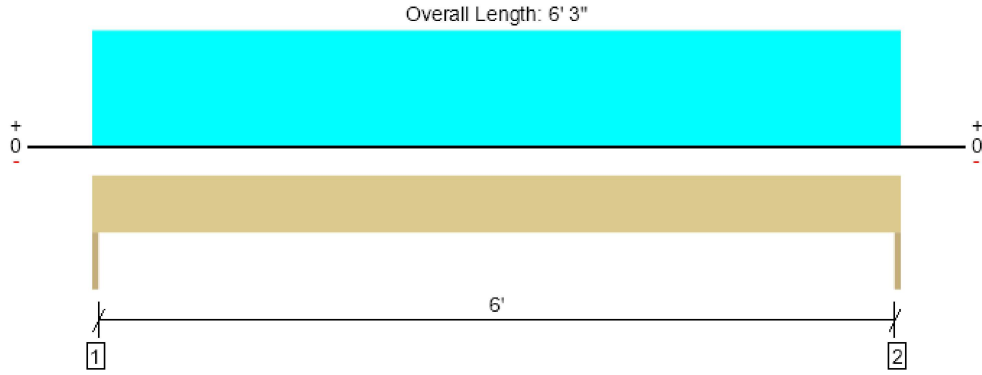

Drawing is Conceptual. All locations are measured from the outside face of left support (or left cantilever end). All dimensions are horizontal.

Design Results	Actual @ Location	Allowed	Result	LDF	Load: Combination (Pattern)
Member Reaction (lbs)	478 @ 0	3281 (1.50")	Passed (15%)	--	1.0 D + 1.0 L (All Spans)
Shear (lbs)	341 @ 10 3/4"	3885	Passed (9%)	1.00	1.0 D + 1.0 L (All Spans)
Moment (Ft-lbs)	746 @ 3' 1 1/2"	4492	Passed (17%)	1.00	1.0 D + 1.0 L (All Spans)
Live Load Defl. (in)	0.002 @ 3' 1 1/2"	0.208	Passed (L/999+)	--	1.0 D + 1.0 L (All Spans)
Total Load Defl. (in)	0.014 @ 3' 1 1/2"	0.313	Passed (L/999+)	--	1.0 D + 1.0 L (All Spans)

Member Length : 6' 3"
 System : Wall
 Member Type : Header
 Building Use : Residential
 Building Code : IBC 2018
 Design Methodology : ASD

- Deflection criteria: LL (L/360) and TL (L/240).
- Allowed moment does not reflect the adjustment for the beam stability factor.
- Applicable calculations are based on NDS.

Supports	Bearing Length			Loads to Supports (lbs)			Accessories
	Total	Available	Required	Dead	Floor Live	Factored	
1 - Trimmer - HF	1.50"	1.50"	1.50"	394	83	478	None
2 - Trimmer - HF	1.50"	1.50"	1.50"	394	83	478	None

Lateral Bracing	Bracing Intervals	Comments
Top Edge (Lu)	6' 3" o/c	
Bottom Edge (Lu)	6' 3" o/c	

•Maximum allowable bracing intervals based on applied load.

Vertical Loads	Location	Tributary Width	Dead (0.90)	Floor Live (1.00)	Comments
0 - Self Weight (PLF)	0 to 6' 3"	N/A	8.2	--	
1 - Uniform (PSF)	0 to 6' 3"	8"	15.0	40.0	Floor
2 - Uniform (PLF)	0 to 6' 3"	N/A	108.0	-	Wall

Weyerhaeuser Notes

Weyerhaeuser warrants that the sizing of its products will be in accordance with Weyerhaeuser product design criteria and published design values. Weyerhaeuser expressly disclaims any other warranties related to the software. Use of this software is not intended to circumvent the need for a design professional as determined by the authority having jurisdiction. The designer of record, builder or framer is responsible to assure that this calculation is compatible with the overall project. Accessories (Rim Board, Blocking Panels and Squash Blocks) are not designed by this software. Products manufactured at Weyerhaeuser facilities are third-party certified to sustainable forestry standards. Weyerhaeuser Engineered Lumber Products have been evaluated by ICC-ES under evaluation reports ESR-1153 and ESR-1387 and/or tested in accordance with applicable ASTM standards. For current code evaluation reports, Weyerhaeuser product literature and installation details refer to www.weyerhaeuser.com/woodproducts/document-library.

The product application, input design loads, dimensions and support information have been provided by ForteWEB Software Operator

ForteWEB Software Operator	Job Notes
Chon Pieruccioni Pieruccioni Engineering (206) 949-7866 cpieru@hotmail.com	



3rd Floor Framing, Grid 2.6 (F-G.5) Flush Beam
1 piece(s) 5 1/2" x 11 7/8" 24F-V4 DF Glulam

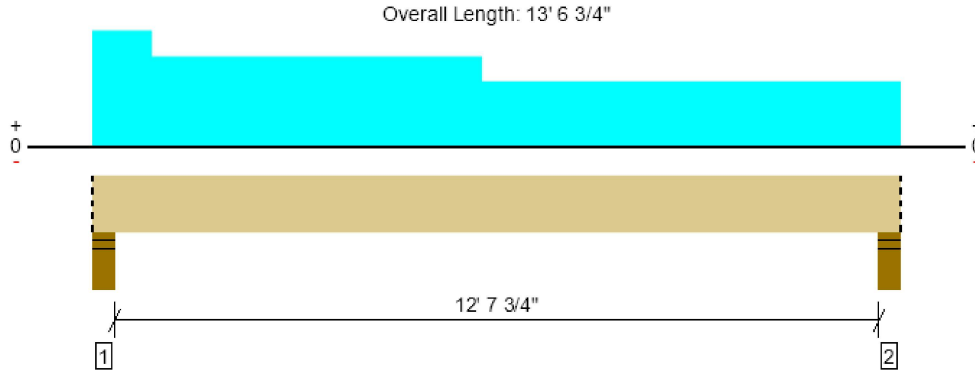

Drawing is Conceptual. All locations are measured from the outside face of left support (or left cantilever end). All dimensions are horizontal.

Design Results	Actual @ Location	Allowed	Result	LDF	Load: Combination (Pattern)
Member Reaction (lbs)	7234 @ 4"	12251 (5.50")	Passed (59%)	--	1.0 D + 1.0 L (All Spans)
Shear (lbs)	5329 @ 1' 5 3/8"	11539	Passed (46%)	1.00	1.0 D + 1.0 L (All Spans)
Pos Moment (Ft-lbs)	19626 @ 6' 3 5/8"	25853	Passed (76%)	1.00	1.0 D + 1.0 L (All Spans)
Live Load Defl. (in)	0.238 @ 6' 8 3/8"	0.322	Passed (L/650)	--	1.0 D + 1.0 L (All Spans)
Total Load Defl. (in)	0.424 @ 6' 8 3/8"	0.645	Passed (L/365)	--	1.0 D + 1.0 L (All Spans)

Member Length : 13' 6 3/4"
 System : Floor
 Member Type : Flush Beam
 Building Use : Residential
 Building Code : IBC 2018
 Design Methodology : ASD

- Deflection criteria: LL (L/480) and TL (L/240).
- Allowed moment does not reflect the adjustment for the beam stability factor.
- Critical positive moment adjusted by a volume/size factor of 1.00 that was calculated using length L = 12' 10 3/4".
- The effects of positive or negative camber have not been accounted for when calculating deflection.
- The specified glulam is assumed to have its strong laminations at the bottom of the beam. Install with proper side up as indicated by the manufacturer.
- Applicable calculations are based on NDS.

Supports	Bearing Length			Loads to Supports (lbs)			Accessories
	Total	Available	Required	Dead	Floor Live	Factored	
1 - Stud wall - HF	5.50"	5.50"	3.25"	3162	4072	7234	Blocking
2 - Stud wall - HF	5.50"	5.50"	2.63"	2574	3289	5863	Blocking

• Blocking Panels are assumed to carry no loads applied directly above them and the full load is applied to the member being designed.

Lateral Bracing	Bracing Intervals	Comments
Top Edge (Lu)	13' 7" o/c	
Bottom Edge (Lu)	13' 7" o/c	

•Maximum allowable bracing intervals based on applied load.

Vertical Loads	Location (Side)	Tributary Width	Dead (0.90)	Floor Live (1.00)	Comments
0 - Self Weight (PLF)	0 to 13' 6 3/4"	N/A	15.9	--	
1 - Uniform (PSF)	0 to 1' (Front)	19' 11 1/2"	30.0	40.0	Default Load
2 - Uniform (PSF)	1' to 6' 6 1/2" (Front)	15' 5 1/2"	30.0	40.0	Default Load
3 - Uniform (PSF)	6' 6 1/2" to 13' 6 3/4" (Front)	11' 2"	30.0	40.0	Default Load

Weyerhaeuser Notes

Weyerhaeuser warrants that the sizing of its products will be in accordance with Weyerhaeuser product design criteria and published design values. Weyerhaeuser expressly disclaims any other warranties related to the software. Use of this software is not intended to circumvent the need for a design professional as determined by the authority having jurisdiction. The designer of record, builder or framer is responsible to assure that this calculation is compatible with the overall project. Accessories (Rim Board, Blocking Panels and Squash Blocks) are not designed by this software. Products manufactured at Weyerhaeuser facilities are third-party certified to sustainable forestry standards. Weyerhaeuser Engineered Lumber Products have been evaluated by ICC-ES under evaluation reports ESR-1153 and ESR-1387 and/or tested in accordance with applicable ASTM standards. For current code evaluation reports, Weyerhaeuser product literature and installation details refer to www.weyerhaeuser.com/woodproducts/document-library.

The product application, input design loads, dimensions and support information have been provided by ForteWEB Software Operator

ForteWEB Software Operator	Job Notes
Chon Pieruccioni Pieruccioni Engineering (206) 949-7866 cpieru@hotmail.com	



3rd Floor Framing, Grid 2.6 (H-H.8) Flush Beam
1 piece(s) 3 1/2" x 11 7/8" 24F-V4 DF Glulam

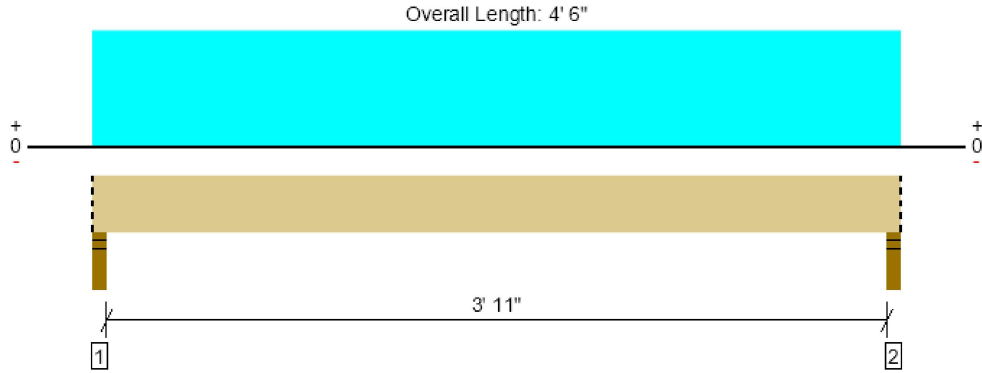

Drawing is Conceptual. All locations are measured from the outside face of left support (or left cantilever end). All dimensions are horizontal.

Design Results	Actual @ Location	Allowed	Result	LDF	Load: Combination (Pattern)
Member Reaction (lbs)	3166 @ 2"	4961 (3.50")	Passed (64%)	--	1.0 D + 1.0 L (All Spans)
Shear (lbs)	1363 @ 1' 3 3/8"	7343	Passed (19%)	1.00	1.0 D + 1.0 L (All Spans)
Pos Moment (Ft-lbs)	3054 @ 2' 3"	16452	Passed (19%)	1.00	1.0 D + 1.0 L (All Spans)
Live Load Defl. (in)	0.006 @ 2' 3"	0.104	Passed (L/999+)	--	1.0 D + 1.0 L (All Spans)
Total Load Defl. (in)	0.011 @ 2' 3"	0.208	Passed (L/999+)	--	1.0 D + 1.0 L (All Spans)

Member Length : 4' 6"
 System : Floor
 Member Type : Flush Beam
 Building Use : Residential
 Building Code : IBC 2018
 Design Methodology : ASD

- Deflection criteria: LL (L/480) and TL (L/240).
- Allowed moment does not reflect the adjustment for the beam stability factor.
- Critical positive moment adjusted by a volume/size factor of 1.00 that was calculated using length L = 4' 2".
- The effects of positive or negative camber have not been accounted for when calculating deflection.
- The specified glulam is assumed to have its strong laminations at the bottom of the beam. Install with proper side up as indicated by the manufacturer.
- Applicable calculations are based on NDS.

Supports	Bearing Length			Loads to Supports (lbs)			Accessories
	Total	Available	Required	Dead	Floor Live	Factored	
1 - Stud wall - HF	3.50"	3.50"	2.23"	1370	1796	3166	Blocking
2 - Stud wall - HF	3.50"	3.50"	2.23"	1370	1796	3166	Blocking

• Blocking Panels are assumed to carry no loads applied directly above them and the full load is applied to the member being designed.

Lateral Bracing	Bracing Intervals	Comments
Top Edge (Lu)	4' 6" o/c	
Bottom Edge (Lu)	4' 6" o/c	

•Maximum allowable bracing intervals based on applied load.

Vertical Loads	Location (Side)	Tributary Width	Dead (0.90)	Floor Live (1.00)	Comments
0 - Self Weight (PLF)	0 to 4' 6"	N/A	10.1	--	
1 - Uniform (PSF)	0 to 4' 6" (Front)	19' 11 1/2"	30.0	40.0	Default Load

Weyerhaeuser Notes

Weyerhaeuser warrants that the sizing of its products will be in accordance with Weyerhaeuser product design criteria and published design values. Weyerhaeuser expressly disclaims any other warranties related to the software. Use of this software is not intended to circumvent the need for a design professional as determined by the authority having jurisdiction. The designer of record, builder or framer is responsible to assure that this calculation is compatible with the overall project. Accessories (Rim Board, Blocking Panels and Squash Blocks) are not designed by this software. Products manufactured at Weyerhaeuser facilities are third-party certified to sustainable forestry standards. Weyerhaeuser Engineered Lumber Products have been evaluated by ICC-ES under evaluation reports ESR-1153 and ESR-1387 and/or tested in accordance with applicable ASTM standards. For current code evaluation reports, Weyerhaeuser product literature and installation details refer to www.eyerhaeuser.com/woodproducts/document-library.

The product application, input design loads, dimensions and support information have been provided by ForteWEB Software Operator

ForteWEB Software Operator	Job Notes
Chon Pieruccioni Pieruccioni Engineering (206) 949-7866 cpieru@hotmail.com	



3rd Floor Framing, Grid 2.4 (H.8-I.8) Door Header
1 piece(s) 4 x 8 DF No.2

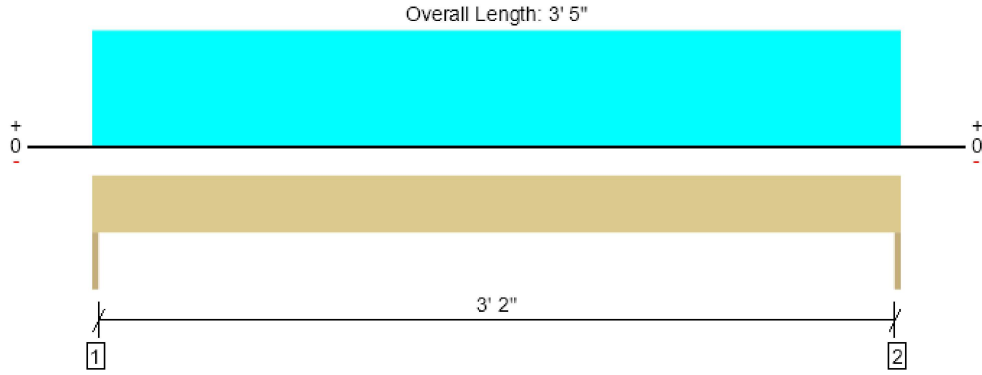

Drawing is Conceptual. All locations are measured from the outside face of left support (or left cantilever end). All dimensions are horizontal.

Design Results	Actual @ Location	Allowed	Result	LDF	Load: Combination (Pattern)
Member Reaction (lbs)	1523 @ 0	3281 (1.50")	Passed (46%)	--	1.0 D + 1.0 L (All Spans)
Shear (lbs)	873 @ 8 3/4"	3045	Passed (29%)	1.00	1.0 D + 1.0 L (All Spans)
Moment (Ft-lbs)	1301 @ 1' 8 1/2"	2989	Passed (44%)	1.00	1.0 D + 1.0 L (All Spans)
Live Load Defl. (in)	0.009 @ 1' 8 1/2"	0.114	Passed (L/999+)	--	1.0 D + 1.0 L (All Spans)
Total Load Defl. (in)	0.015 @ 1' 8 1/2"	0.171	Passed (L/999+)	--	1.0 D + 1.0 L (All Spans)

Member Length : 3' 5"
 System : Wall
 Member Type : Header
 Building Use : Residential
 Building Code : IBC 2018
 Design Methodology : ASD

- Deflection criteria: LL (L/360) and TL (L/240).
- Allowed moment does not reflect the adjustment for the beam stability factor.
- Applicable calculations are based on NDS.

Supports	Bearing Length			Loads to Supports (lbs)			Accessories
	Total	Available	Required	Dead	Floor Live	Factored	
1 - Trimmer - HF	1.50"	1.50"	1.50"	659	864	1523	None
2 - Trimmer - HF	1.50"	1.50"	1.50"	659	864	1523	None

Lateral Bracing	Bracing Intervals	Comments
Top Edge (Lu)	3' 5" o/c	
Bottom Edge (Lu)	3' 5" o/c	

•Maximum allowable bracing intervals based on applied load.

Vertical Loads	Location	Tributary Width	Dead (0.90)	Floor Live (1.00)	Comments
0 - Self Weight (PLF)	0 to 3' 5"	N/A	6.4	--	
1 - Uniform (PSF)	0 to 3' 5"	12' 7 3/4"	30.0	40.0	Default Load

Weyerhaeuser Notes
 Weyerhaeuser warrants that the sizing of its products will be in accordance with Weyerhaeuser product design criteria and published design values. Weyerhaeuser expressly disclaims any other warranties related to the software. Use of this software is not intended to circumvent the need for a design professional as determined by the authority having jurisdiction. The designer of record, builder or framer is responsible to assure that this calculation is compatible with the overall project. Accessories (Rim Board, Blocking Panels and Squash Blocks) are not designed by this software. Products manufactured at Weyerhaeuser facilities are third-party certified to sustainable forestry standards. Weyerhaeuser Engineered Lumber Products have been evaluated by ICC-ES under evaluation reports ESR-1153 and ESR-1387 and/or tested in accordance with applicable ASTM standards. For current code evaluation reports, Weyerhaeuser product literature and installation details refer to www.weyerhaeuser.com/woodproducts/document-library.
 The product application, input design loads, dimensions and support information have been provided by ForteWEB Software Operator

ForteWEB Software Operator	Job Notes
Chon Pieruccioni Pieruccioni Engineering (206) 949-7866 cpieru@hotmail.com	



3rd Floor Framing, Grid 2.4 (J.2-K.8) Door Header
1 piece(s) 4 x 8 DF No.2

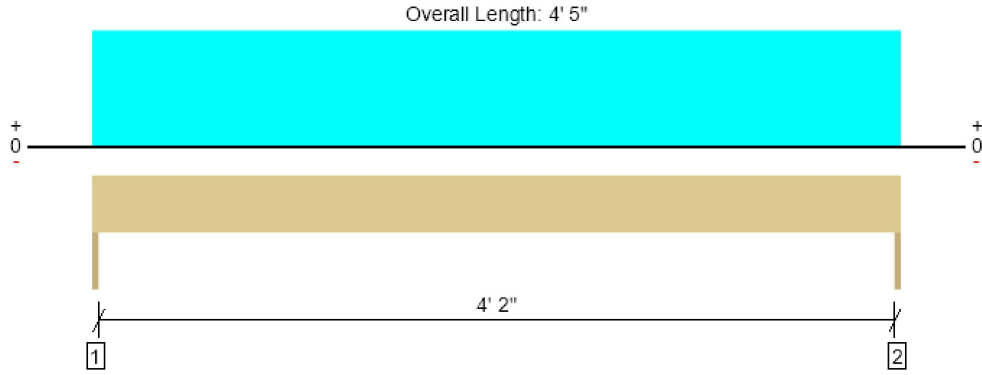

Drawing is Conceptual. All locations are measured from the outside face of left support (or left cantilever end). All dimensions are horizontal.

Design Results	Actual @ Location	Allowed	Result	LDF	Load: Combination (Pattern)
Member Reaction (lbs)	1969 @ 0	3281 (1.50")	Passed (60%)	--	1.0 D + 1.0 L (All Spans)
Shear (lbs)	1319 @ 8 3/4"	3045	Passed (43%)	1.00	1.0 D + 1.0 L (All Spans)
Moment (Ft-lbs)	2174 @ 2' 2 1/2"	2989	Passed (73%)	1.00	1.0 D + 1.0 L (All Spans)
Live Load Defl. (in)	0.024 @ 2' 2 1/2"	0.147	Passed (L/999+)	--	1.0 D + 1.0 L (All Spans)
Total Load Defl. (in)	0.043 @ 2' 2 1/2"	0.221	Passed (L/999+)	--	1.0 D + 1.0 L (All Spans)

Member Length : 4' 5"
 System : Wall
 Member Type : Header
 Building Use : Residential
 Building Code : IBC 2018
 Design Methodology : ASD

- Deflection criteria: LL (L/360) and TL (L/240).
- Allowed moment does not reflect the adjustment for the beam stability factor.
- Applicable calculations are based on NDS.

Supports	Bearing Length			Loads to Supports (lbs)			Accessories
	Total	Available	Required	Dead	Floor Live	Factored	
1 - Trimmer - HF	1.50"	1.50"	1.50"	852	1117	1969	None
2 - Trimmer - HF	1.50"	1.50"	1.50"	852	1117	1969	None

Lateral Bracing	Bracing Intervals	Comments
Top Edge (Lu)	4' 5" o/c	
Bottom Edge (Lu)	4' 5" o/c	

•Maximum allowable bracing intervals based on applied load.

Vertical Loads	Location	Tributary Width	Dead (0.90)	Floor Live (1.00)	Comments
0 - Self Weight (PLF)	0 to 4' 5"	N/A	6.4	--	
1 - Uniform (PSF)	0 to 4' 5"	12' 7 3/4"	30.0	40.0	Default Load

Weyerhaeuser Notes

Weyerhaeuser warrants that the sizing of its products will be in accordance with Weyerhaeuser product design criteria and published design values. Weyerhaeuser expressly disclaims any other warranties related to the software. Use of this software is not intended to circumvent the need for a design professional as determined by the authority having jurisdiction. The designer of record, builder or framer is responsible to assure that this calculation is compatible with the overall project. Accessories (Rim Board, Blocking Panels and Squash Blocks) are not designed by this software. Products manufactured at Weyerhaeuser facilities are third-party certified to sustainable forestry standards. Weyerhaeuser Engineered Lumber Products have been evaluated by ICC-ES under evaluation reports ESR-1153 and ESR-1387 and/or tested in accordance with applicable ASTM standards. For current code evaluation reports, Weyerhaeuser product literature and installation details refer to www.woodyhaeuser.com/woodproducts/document-library.

The product application, input design loads, dimensions and support information have been provided by ForteWEB Software Operator

ForteWEB Software Operator	Job Notes
Chon Pieruccioni Pieruccioni Engineering (206) 949-7866 cpieru@hotmail.com	



3rd Floor Framing, Grid 5.5 (H-H.8) Door Header
1 piece(s) 4 x 8 DF No.2

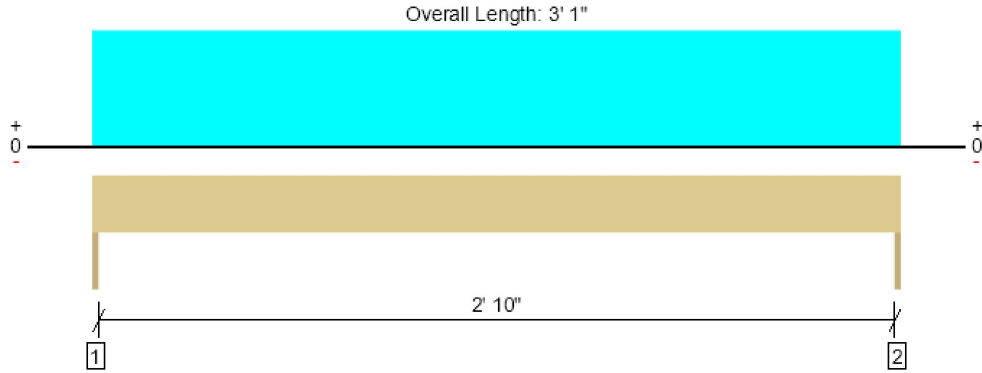

Drawing is Conceptual. All locations are measured from the outside face of left support (or left cantilever end). All dimensions are horizontal.

Design Results	Actual @ Location	Allowed	Result	LDF	Load: Combination (Pattern)
Member Reaction (lbs)	1116 @ 0	3281 (1.50")	Passed (34%)	--	1.0 D + 1.0 L (All Spans)
Shear (lbs)	588 @ 8 3/4"	3045	Passed (19%)	1.00	1.0 D + 1.0 L (All Spans)
Moment (Ft-lbs)	860 @ 1' 6 1/2"	2989	Passed (29%)	1.00	1.0 D + 1.0 L (All Spans)
Live Load Defl. (in)	0.005 @ 1' 6 1/2"	0.103	Passed (L/999+)	--	1.0 D + 1.0 L (All Spans)
Total Load Defl. (in)	0.008 @ 1' 6 1/2"	0.154	Passed (L/999+)	--	1.0 D + 1.0 L (All Spans)

Member Length : 3' 1"
 System : Wall
 Member Type : Header
 Building Use : Residential
 Building Code : IBC 2018
 Design Methodology : ASD

- Deflection criteria: LL (L/360) and TL (L/240).
- Allowed moment does not reflect the adjustment for the beam stability factor.
- Applicable calculations are based on NDS.

Supports	Bearing Length			Loads to Supports (lbs)			Accessories
	Total	Available	Required	Dead	Floor Live	Factored	
1 - Trimmer - HF	1.50"	1.50"	1.50"	484	632	1116	None
2 - Trimmer - HF	1.50"	1.50"	1.50"	484	632	1116	None

Lateral Bracing	Bracing Intervals	Comments
Top Edge (Lu)	3' 1" o/c	
Bottom Edge (Lu)	3' 1" o/c	

•Maximum allowable bracing intervals based on applied load.

Vertical Loads	Location	Tributary Width	Dead (0.90)	Floor Live (1.00)	Comments
0 - Self Weight (PLF)	0 to 3' 1"	N/A	6.4	--	
1 - Uniform (PSF)	0 to 3' 1"	10' 3"	30.0	40.0	Default Load

Weyerhaeuser Notes

Weyerhaeuser warrants that the sizing of its products will be in accordance with Weyerhaeuser product design criteria and published design values. Weyerhaeuser expressly disclaims any other warranties related to the software. Use of this software is not intended to circumvent the need for a design professional as determined by the authority having jurisdiction. The designer of record, builder or framer is responsible to assure that this calculation is compatible with the overall project. Accessories (Rim Board, Blocking Panels and Squash Blocks) are not designed by this software. Products manufactured at Weyerhaeuser facilities are third-party certified to sustainable forestry standards. Weyerhaeuser Engineered Lumber Products have been evaluated by ICC-ES under evaluation reports ESR-1153 and ESR-1387 and/or tested in accordance with applicable ASTM standards. For current code evaluation reports, Weyerhaeuser product literature and installation details refer to www.weyerhaeuser.com/woodproducts/document-library.

The product application, input design loads, dimensions and support information have been provided by ForteWEB Software Operator

ForteWEB Software Operator	Job Notes
Chon Pieruccioni Pieruccioni Engineering (206) 949-7866 cpieru@hotmail.com	



3rd Floor Framing, Grid 5.5 (G.4-G.8) Door Header
1 piece(s) 4 x 8 DF No.2

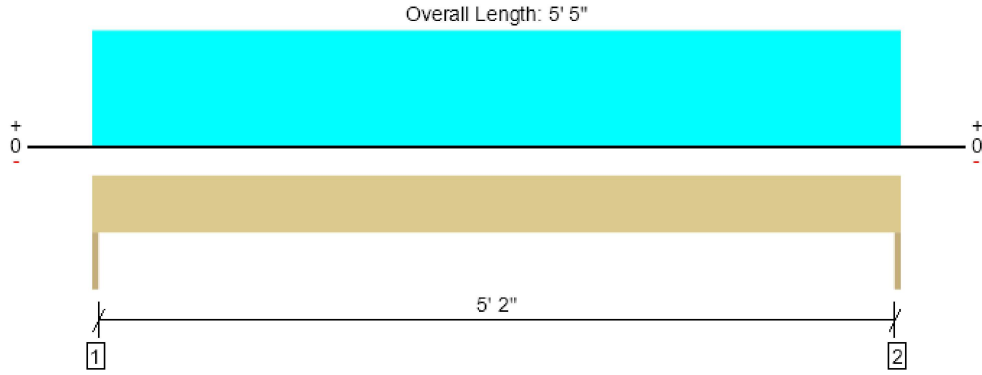

Drawing is Conceptual. All locations are measured from the outside face of left support (or left cantilever end). All dimensions are horizontal.

Design Results	Actual @ Location	Allowed	Result	LDF	Load: Combination (Pattern)
Member Reaction (lbs)	1961 @ 0	3281 (1.50")	Passed (60%)	--	1.0 D + 1.0 L (All Spans)
Shear (lbs)	1433 @ 8 3/4"	3045	Passed (47%)	1.00	1.0 D + 1.0 L (All Spans)
Moment (Ft-lbs)	2655 @ 2' 8 1/2"	2989	Passed (89%)	1.00	1.0 D + 1.0 L (All Spans)
Live Load Defl. (in)	0.045 @ 2' 8 1/2"	0.181	Passed (L/999+)	--	1.0 D + 1.0 L (All Spans)
Total Load Defl. (in)	0.079 @ 2' 8 1/2"	0.271	Passed (L/824)	--	1.0 D + 1.0 L (All Spans)

Member Length : 5' 5"
 System : Wall
 Member Type : Header
 Building Use : Residential
 Building Code : IBC 2018
 Design Methodology : ASD

- Deflection criteria: LL (L/360) and TL (L/240).
- Allowed moment does not reflect the adjustment for the beam stability factor.
- Applicable calculations are based on NDS.

Supports	Bearing Length			Loads to Supports (lbs)			Accessories
	Total	Available	Required	Dead	Floor Live	Factored	
1 - Trimmer - HF	1.50"	1.50"	1.50"	850	1110	1961	None
2 - Trimmer - HF	1.50"	1.50"	1.50"	850	1110	1961	None

Lateral Bracing	Bracing Intervals	Comments
Top Edge (Lu)	5' 5" o/c	
Bottom Edge (Lu)	5' 5" o/c	

•Maximum allowable bracing intervals based on applied load.

Vertical Loads	Location	Tributary Width	Dead (0.90)	Floor Live (1.00)	Comments
0 - Self Weight (PLF)	0 to 5' 5"	N/A	6.4	--	
1 - Uniform (PSF)	0 to 5' 5"	10' 3"	30.0	40.0	Default Load

Weyerhaeuser Notes

Weyerhaeuser warrants that the sizing of its products will be in accordance with Weyerhaeuser product design criteria and published design values. Weyerhaeuser expressly disclaims any other warranties related to the software. Use of this software is not intended to circumvent the need for a design professional as determined by the authority having jurisdiction. The designer of record, builder or framer is responsible to assure that this calculation is compatible with the overall project. Accessories (Rim Board, Blocking Panels and Squash Blocks) are not designed by this software. Products manufactured at Weyerhaeuser facilities are third-party certified to sustainable forestry standards. Weyerhaeuser Engineered Lumber Products have been evaluated by ICC-ES under evaluation reports ESR-1153 and ESR-1387 and/or tested in accordance with applicable ASTM standards. For current code evaluation reports, Weyerhaeuser product literature and installation details refer to www.woyehaeuser.com/woodproducts/document-library.

The product application, input design loads, dimensions and support information have been provided by ForteWEB Software Operator

ForteWEB Software Operator	Job Notes
Chon Pieruccioni Pieruccioni Engineering (206) 949-7866 cpieru@hotmail.com	



3rd Floor Framing, Grid 5.5 (G.1-G.3) Flush Beam
1 piece(s) 3 1/2" x 11 7/8" 24F-V4 DF Glulam

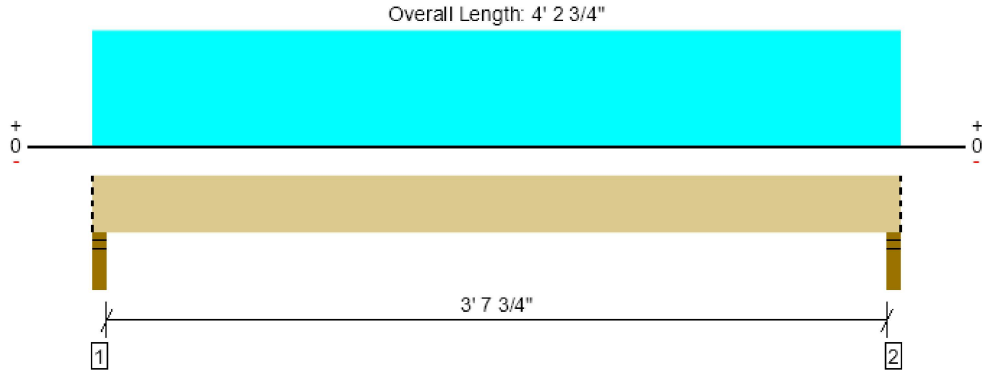

Drawing is Conceptual. All locations are measured from the outside face of left support (or left cantilever end). All dimensions are horizontal.

Design Results	Actual @ Location	Allowed	Result	LDF	Load: Combination (Pattern)
Member Reaction (lbs)	1539 @ 2"	4961 (3.50")	Passed (31%)	--	1.0 D + 1.0 L (All Spans)
Shear (lbs)	606 @ 1' 3 3/8"	7343	Passed (8%)	1.00	1.0 D + 1.0 L (All Spans)
Pos Moment (Ft-lbs)	1380 @ 2' 1 3/8"	16452	Passed (8%)	1.00	1.0 D + 1.0 L (All Spans)
Live Load Defl. (in)	0.002 @ 2' 1 3/8"	0.097	Passed (L/999+)	--	1.0 D + 1.0 L (All Spans)
Total Load Defl. (in)	0.004 @ 2' 1 3/8"	0.195	Passed (L/999+)	--	1.0 D + 1.0 L (All Spans)

Member Length : 4' 2 3/4"
 System : Floor
 Member Type : Flush Beam
 Building Use : Residential
 Building Code : IBC 2018
 Design Methodology : ASD

- Deflection criteria: LL (L/480) and TL (L/240).
- Allowed moment does not reflect the adjustment for the beam stability factor.
- Critical positive moment adjusted by a volume/size factor of 1.00 that was calculated using length L = 3' 10 3/4".
- The effects of positive or negative camber have not been accounted for when calculating deflection.
- The specified glulam is assumed to have its strong laminations at the bottom of the beam. Install with proper side up as indicated by the manufacturer.
- Applicable calculations are based on NDS.

Supports	Bearing Length			Loads to Supports (lbs)			Accessories
	Total	Available	Required	Dead	Floor Live	Factored	
1 - Stud wall - HF	3.50"	3.50"	1.50"	672	867	1539	Blocking
2 - Stud wall - HF	3.50"	3.50"	1.50"	672	867	1539	Blocking

• Blocking Panels are assumed to carry no loads applied directly above them and the full load is applied to the member being designed.

Lateral Bracing	Bracing Intervals	Comments
Top Edge (Lu)	4' 3" o/c	
Bottom Edge (Lu)	4' 3" o/c	

•Maximum allowable bracing intervals based on applied load.

Vertical Loads	Location (Side)	Tributary Width	Dead (0.90)	Floor Live (1.00)	Comments
0 - Self Weight (PLF)	0 to 4' 2 3/4"	N/A	10.1	--	
1 - Uniform (PSF)	0 to 4' 2 3/4" (Front)	10' 3"	30.0	40.0	Default Load

Weyerhaeuser Notes
 Weyerhaeuser warrants that the sizing of its products will be in accordance with Weyerhaeuser product design criteria and published design values. Weyerhaeuser expressly disclaims any other warranties related to the software. Use of this software is not intended to circumvent the need for a design professional as determined by the authority having jurisdiction. The designer of record, builder or framer is responsible to assure that this calculation is compatible with the overall project. Accessories (Rim Board, Blocking Panels and Squash Blocks) are not designed by this software. Products manufactured at Weyerhaeuser facilities are third-party certified to sustainable forestry standards. Weyerhaeuser Engineered Lumber Products have been evaluated by ICC-ES under evaluation reports ESR-1153 and ESR-1387 and/or tested in accordance with applicable ASTM standards. For current code evaluation reports, Weyerhaeuser product literature and installation details refer to www.weyerhaeuser.com/woodproducts/document-library.
 The product application, input design loads, dimensions and support information have been provided by ForteWEB Software Operator

ForteWEB Software Operator	Job Notes
Chon Pieruccioni Pieruccioni Engineering (206) 949-7866 cpieru@hotmail.com	



3rd Floor Framing, Grid G.1 (5.2-5.3) Door Header

1 piece(s) 4 x 8 DF No.2

Overall Length: 2' 5"

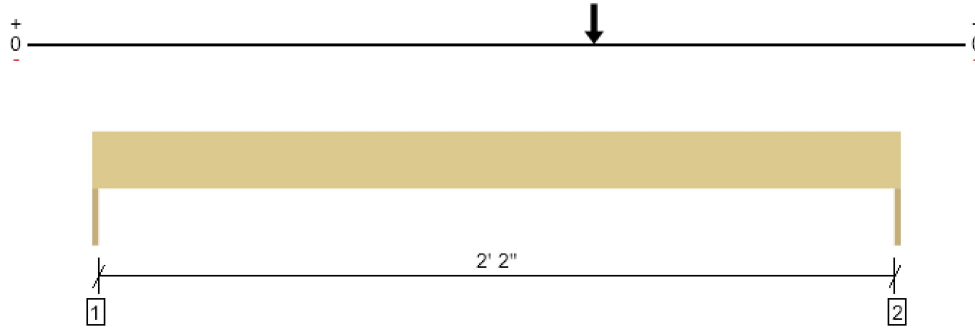

Drawing is Conceptual. All locations are measured from the outside face of left support (or left cantilever end). All dimensions are horizontal.

Design Results	Actual @ Location	Allowed	Result	LDF	Load: Combination (Pattern)
Member Reaction (lbs)	963 @ 2' 5"	3281 (1.50")	Passed (29%)	--	1.0 D + 1.0 L (All Spans)
Shear (lbs)	958 @ 1' 8 1/4"	3045	Passed (31%)	1.00	1.0 D + 1.0 L (All Spans)
Moment (Ft-lbs)	880 @ 1' 6"	2989	Passed (29%)	1.00	1.0 D + 1.0 L (All Spans)
Live Load Defl. (in)	0.002 @ 1' 2 7/8"	0.081	Passed (L/999+)	--	1.0 D + 1.0 L (All Spans)
Total Load Defl. (in)	0.004 @ 1' 2 7/8"	0.121	Passed (L/999+)	--	1.0 D + 1.0 L (All Spans)

Member Length : 2' 5"
 System : Wall
 Member Type : Header
 Building Use : Residential
 Building Code : IBC 2018
 Design Methodology : ASD

- Deflection criteria: LL (L/360) and TL (L/240).
- Allowed moment does not reflect the adjustment for the beam stability factor.
- Applicable calculations are based on NDS.

Supports	Bearing Length			Loads to Supports (lbs)			Accessories
	Total	Available	Required	Dead	Floor Live	Factored	
1 - Trimmer - HF	1.50"	1.50"	1.50"	263	329	592	None
2 - Trimmer - HF	1.50"	1.50"	1.50"	425	538	963	None

Lateral Bracing	Bracing Intervals	Comments
Top Edge (Lu)	2' 5" o/c	
Bottom Edge (Lu)	2' 5" o/c	

•Maximum allowable bracing intervals based on applied load.

Vertical Loads	Location	Tributary Width	Dead (0.90)	Floor Live (1.00)	Comments
0 - Self Weight (PLF)	0 to 2' 5"	N/A	6.4	--	
1 - Point (lb)	1' 6"	N/A	672	867	Linked from: Grid 5.5 (G.1-G.3) Flush Beam, Support 2

Weyerhaeuser Notes

Weyerhaeuser warrants that the sizing of its products will be in accordance with Weyerhaeuser product design criteria and published design values. Weyerhaeuser expressly disclaims any other warranties related to the software. Use of this software is not intended to circumvent the need for a design professional as determined by the authority having jurisdiction. The designer of record, builder or framer is responsible to assure that this calculation is compatible with the overall project. Accessories (Rim Board, Blocking Panels and Squash Blocks) are not designed by this software. Products manufactured at Weyerhaeuser facilities are third-party certified to sustainable forestry standards. Weyerhaeuser Engineered Lumber Products have been evaluated by ICC-ES under evaluation reports ESR-1153 and ESR-1387 and/or tested in accordance with applicable ASTM standards. For current code evaluation reports, Weyerhaeuser product literature and installation details refer to www.weyerhaeuser.com/woodproducts/document-library.

The product application, input design loads, dimensions and support information have been provided by ForteWEB Software Operator

ForteWEB Software Operator	Job Notes
Chon Pieruccioni Pieruccioni Engineering (206) 949-7866 cpieru@hotmail.com	



3rd Floor Framing, Grid 6 (G.1-G.3) Flush Beam
1 piece(s) 3 1/2" x 11 7/8" 24F-V4 DF Glulam

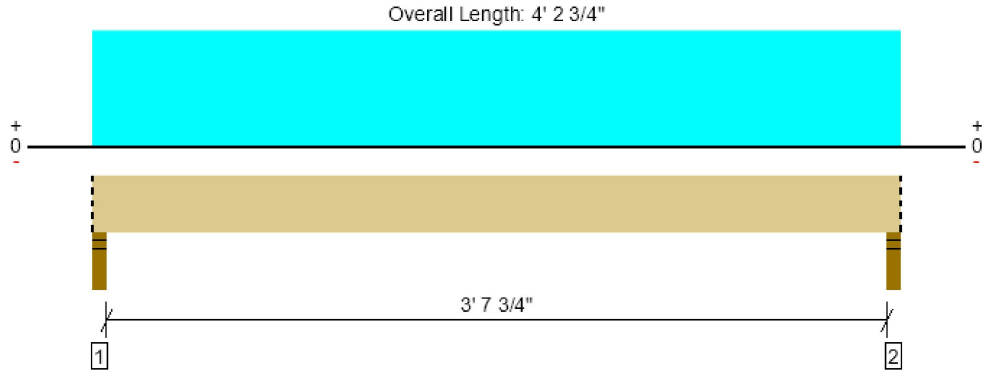

Drawing is Conceptual. All locations are measured from the outside face of left support (or left cantilever end). All dimensions are horizontal.

Design Results	Actual @ Location	Allowed	Result	LDF	Load: Combination (Pattern)
Member Reaction (lbs)	1711 @ 2"	4961 (3.50")	Passed (34%)	--	1.0 D + 1.0 L (All Spans)
Shear (lbs)	674 @ 1' 3 3/8"	7343	Passed (9%)	1.00	1.0 D + 1.0 L (All Spans)
Pos Moment (Ft-lbs)	1535 @ 2' 1 3/8"	16452	Passed (9%)	1.00	1.0 D + 1.0 L (All Spans)
Live Load Defl. (in)	0.003 @ 2' 1 3/8"	0.097	Passed (L/999+)	--	1.0 D + 1.0 L (All Spans)
Total Load Defl. (in)	0.005 @ 2' 1 3/8"	0.195	Passed (L/999+)	--	1.0 D + 1.0 L (All Spans)

Member Length : 4' 2 3/4"
 System : Floor
 Member Type : Flush Beam
 Building Use : Residential
 Building Code : IBC 2018
 Design Methodology : ASD

- Deflection criteria: LL (L/480) and TL (L/240).
- Allowed moment does not reflect the adjustment for the beam stability factor.
- Critical positive moment adjusted by a volume/size factor of 1.00 that was calculated using length L = 3' 10 3/4".
- The effects of positive or negative camber have not been accounted for when calculating deflection.
- The specified glulam is assumed to have its strong laminations at the bottom of the beam. Install with proper side up as indicated by the manufacturer.
- Applicable calculations are based on NDS.

Supports	Bearing Length			Loads to Supports (lbs)			Accessories
	Total	Available	Required	Dead	Floor Live	Factored	
1 - Stud wall - HF	3.50"	3.50"	1.50"	746	966	1711	Blocking
2 - Stud wall - HF	3.50"	3.50"	1.50"	746	966	1711	Blocking

• Blocking Panels are assumed to carry no loads applied directly above them and the full load is applied to the member being designed.

Lateral Bracing	Bracing Intervals	Comments
Top Edge (Lu)	4' 3" o/c	
Bottom Edge (Lu)	4' 3" o/c	

•Maximum allowable bracing intervals based on applied load.

Vertical Loads	Location (Side)	Tributary Width	Dead (0.90)	Floor Live (1.00)	Comments
0 - Self Weight (PLF)	0 to 4' 2 3/4"	N/A	10.1	--	
1 - Uniform (PSF)	0 to 4' 2 3/4" (Front)	11' 5"	30.0	40.0	Default Load

Weyerhaeuser Notes

Weyerhaeuser warrants that the sizing of its products will be in accordance with Weyerhaeuser product design criteria and published design values. Weyerhaeuser expressly disclaims any other warranties related to the software. Use of this software is not intended to circumvent the need for a design professional as determined by the authority having jurisdiction. The designer of record, builder or framer is responsible to assure that this calculation is compatible with the overall project. Accessories (Rim Board, Blocking Panels and Squash Blocks) are not designed by this software. Products manufactured at Weyerhaeuser facilities are third-party certified to sustainable forestry standards. Weyerhaeuser Engineered Lumber Products have been evaluated by ICC-ES under evaluation reports ESR-1153 and ESR-1387 and/or tested in accordance with applicable ASTM standards. For current code evaluation reports, Weyerhaeuser product literature and installation details refer to www.weyerhaeuser.com/woodproducts/document-library.

The product application, input design loads, dimensions and support information have been provided by ForteWEB Software Operator

ForteWEB Software Operator	Job Notes
Chon Pieruccioni Pieruccioni Engineering (206) 949-7866 cpieru@hotmail.com	



3rd Floor Framing, Grid 2.5 (D.4-D.6) Flush Beam
1 piece(s) 3 1/2" x 11 7/8" 24F-V4 DF Glulam

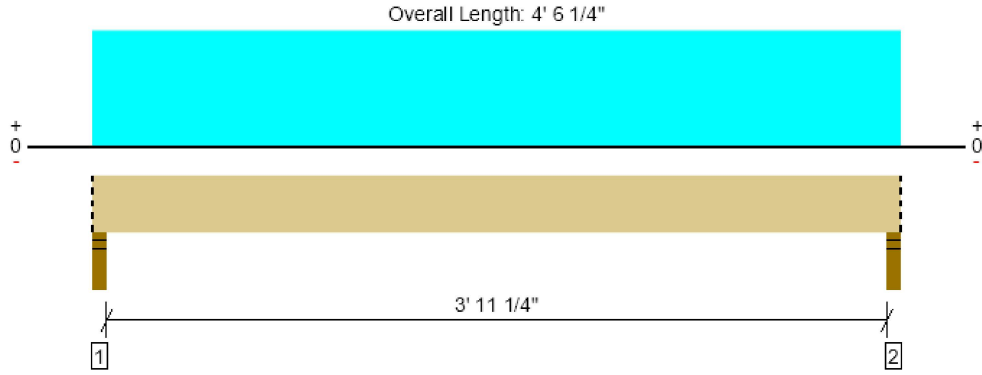

Drawing is Conceptual. All locations are measured from the outside face of left support (or left cantilever end). All dimensions are horizontal.

Design Results	Actual @ Location	Allowed	Result	LDF	Load: Combination (Pattern)
Member Reaction (lbs)	2581 @ 2"	4961 (3.50")	Passed (52%)	--	1.0 D + 1.0 L (All Spans)
Shear (lbs)	1118 @ 1' 3 3/8"	7343	Passed (15%)	1.00	1.0 D + 1.0 L (All Spans)
Pos Moment (Ft-lbs)	2503 @ 2' 3 1/8"	16452	Passed (15%)	1.00	1.0 D + 1.0 L (All Spans)
Live Load Defl. (in)	0.005 @ 2' 3 1/8"	0.105	Passed (L/999+)	--	1.0 D + 1.0 L (All Spans)
Total Load Defl. (in)	0.009 @ 2' 3 1/8"	0.209	Passed (L/999+)	--	1.0 D + 1.0 L (All Spans)

Member Length : 4' 6 1/4"
 System : Floor
 Member Type : Flush Beam
 Building Use : Residential
 Building Code : IBC 2018
 Design Methodology : ASD

- Deflection criteria: LL (L/480) and TL (L/240).
- Allowed moment does not reflect the adjustment for the beam stability factor.
- Critical positive moment adjusted by a volume/size factor of 1.00 that was calculated using length L = 4' 2 1/4".
- The effects of positive or negative camber have not been accounted for when calculating deflection.
- The specified glulam is assumed to have its strong laminations at the bottom of the beam. Install with proper side up as indicated by the manufacturer.
- Applicable calculations are based on NDS.

Supports	Bearing Length			Loads to Supports (lbs)			Accessories
	Total	Available	Required	Dead	Floor Live	Factored	
1 - Stud wall - HF	3.50"	3.50"	1.82"	1119	1462	2581	Blocking
2 - Stud wall - HF	3.50"	3.50"	1.82"	1119	1462	2581	Blocking

• Blocking Panels are assumed to carry no loads applied directly above them and the full load is applied to the member being designed.

Lateral Bracing	Bracing Intervals	Comments
Top Edge (Lu)	4' 6" o/c	
Bottom Edge (Lu)	4' 6" o/c	

•Maximum allowable bracing intervals based on applied load.

Vertical Loads	Location (Side)	Tributary Width	Dead (0.90)	Floor Live (1.00)	Comments
0 - Self Weight (PLF)	0 to 4' 6 1/4"	N/A	10.1	--	
1 - Uniform (PSF)	0 to 4' 6 1/4" (Front)	16' 2"	30.0	40.0	Default Load

Weyerhaeuser Notes

Weyerhaeuser warrants that the sizing of its products will be in accordance with Weyerhaeuser product design criteria and published design values. Weyerhaeuser expressly disclaims any other warranties related to the software. Use of this software is not intended to circumvent the need for a design professional as determined by the authority having jurisdiction. The designer of record, builder or framer is responsible to assure that this calculation is compatible with the overall project. Accessories (Rim Board, Blocking Panels and Squash Blocks) are not designed by this software. Products manufactured at Weyerhaeuser facilities are third-party certified to sustainable forestry standards. Weyerhaeuser Engineered Lumber Products have been evaluated by ICC-ES under evaluation reports ESR-1153 and ESR-1387 and/or tested in accordance with applicable ASTM standards. For current code evaluation reports, Weyerhaeuser product literature and installation details refer to www.weyerhaeuser.com/woodproducts/document-library.

The product application, input design loads, dimensions and support information have been provided by ForteWEB Software Operator

ForteWEB Software Operator	Job Notes
Chon Pieruccioni Pieruccioni Engineering (206) 949-7866 cpieru@hotmail.com	



3rd Floor Framing, Grid 3.3 (D.8-E.1) Flush Beam
1 piece(s) 3 1/2" x 11 7/8" 24F-V4 DF Glulam

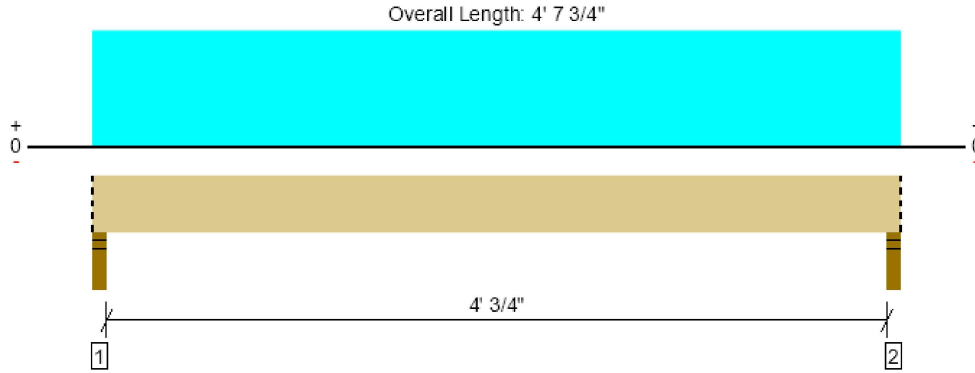

Drawing is Conceptual. All locations are measured from the outside face of left support (or left cantilever end). All dimensions are horizontal.

Design Results	Actual @ Location	Allowed	Result	LDF	Load: Combination (Pattern)
Member Reaction (lbs)	2151 @ 2"	4961 (3.50")	Passed (43%)	--	1.0 D + 1.0 L (All Spans)
Shear (lbs)	965 @ 1' 3 3/8"	7343	Passed (13%)	1.00	1.0 D + 1.0 L (All Spans)
Pos Moment (Ft-lbs)	2153 @ 2' 3 7/8"	16452	Passed (13%)	1.00	1.0 D + 1.0 L (All Spans)
Live Load Defl. (in)	0.005 @ 2' 3 7/8"	0.108	Passed (L/999+)	--	1.0 D + 1.0 L (All Spans)
Total Load Defl. (in)	0.008 @ 2' 3 7/8"	0.216	Passed (L/999+)	--	1.0 D + 1.0 L (All Spans)

Member Length : 4' 7 3/4"
 System : Floor
 Member Type : Flush Beam
 Building Use : Residential
 Building Code : IBC 2018
 Design Methodology : ASD

- Deflection criteria: LL (L/480) and TL (L/240).
- Allowed moment does not reflect the adjustment for the beam stability factor.
- Critical positive moment adjusted by a volume/size factor of 1.00 that was calculated using length L = 4' 3 3/4".
- The effects of positive or negative camber have not been accounted for when calculating deflection.
- The specified glulam is assumed to have its strong laminations at the bottom of the beam. Install with proper side up as indicated by the manufacturer.
- Applicable calculations are based on NDS.

Supports	Bearing Length			Loads to Supports (lbs)			Accessories
	Total	Available	Required	Dead	Floor Live	Factored	
1 - Stud wall - HF	3.50"	3.50"	1.52"	935	1216	2151	Blocking
2 - Stud wall - HF	3.50"	3.50"	1.52"	935	1216	2151	Blocking

• Blocking Panels are assumed to carry no loads applied directly above them and the full load is applied to the member being designed.

Lateral Bracing	Bracing Intervals	Comments
Top Edge (Lu)	4' 8" o/c	
Bottom Edge (Lu)	4' 8" o/c	

•Maximum allowable bracing intervals based on applied load.

Vertical Loads	Location (Side)	Tributary Width	Dead (0.90)	Floor Live (1.00)	Comments
0 - Self Weight (PLF)	0 to 4' 7 3/4"	N/A	10.1	--	
1 - Uniform (PSF)	0 to 4' 7 3/4" (Front)	13' 1"	30.0	40.0	Default Load

Weyerhaeuser Notes

Weyerhaeuser warrants that the sizing of its products will be in accordance with Weyerhaeuser product design criteria and published design values. Weyerhaeuser expressly disclaims any other warranties related to the software. Use of this software is not intended to circumvent the need for a design professional as determined by the authority having jurisdiction. The designer of record, builder or framer is responsible to assure that this calculation is compatible with the overall project. Accessories (Rim Board, Blocking Panels and Squash Blocks) are not designed by this software. Products manufactured at Weyerhaeuser facilities are third-party certified to sustainable forestry standards. Weyerhaeuser Engineered Lumber Products have been evaluated by ICC-ES under evaluation reports ESR-1153 and ESR-1387 and/or tested in accordance with applicable ASTM standards. For current code evaluation reports, Weyerhaeuser product literature and installation details refer to www.woyehaeuser.com/woodproducts/document-library.

The product application, input design loads, dimensions and support information have been provided by ForteWEB Software Operator

ForteWEB Software Operator	Job Notes
Chon Pieruccioni Pieruccioni Engineering (206) 949-7866 cpieru@hotmail.com	



3rd Floor Framing, Grid 5.3 (D.5-E.2) Flush Beam
1 piece(s) 3 1/2" x 11 7/8" 24F-V4 DF Glulam

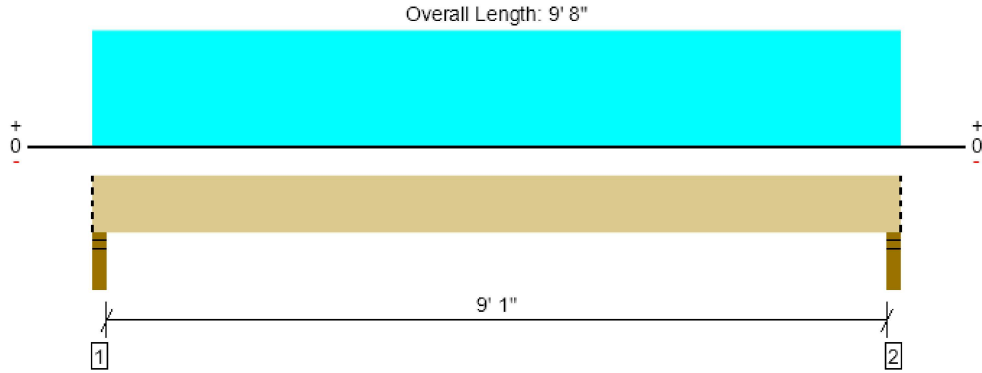

Drawing is Conceptual. All locations are measured from the outside face of left support (or left cantilever end). All dimensions are horizontal.

Design Results	Actual @ Location	Allowed	Result	LDF	Load: Combination (Pattern)
Member Reaction (lbs)	4475 @ 2"	4961 (3.50")	Passed (90%)	--	1.0 D + 1.0 L (All Spans)
Shear (lbs)	3289 @ 1' 3 3/8"	7343	Passed (45%)	1.00	1.0 D + 1.0 L (All Spans)
Pos Moment (Ft-lbs)	10082 @ 4' 10"	16452	Passed (61%)	1.00	1.0 D + 1.0 L (All Spans)
Live Load Defl. (in)	0.102 @ 4' 10"	0.233	Passed (L/999+)	--	1.0 D + 1.0 L (All Spans)
Total Load Defl. (in)	0.180 @ 4' 10"	0.467	Passed (L/623)	--	1.0 D + 1.0 L (All Spans)

Member Length : 9' 8"
 System : Floor
 Member Type : Flush Beam
 Building Use : Residential
 Building Code : IBC 2018
 Design Methodology : ASD

- Deflection criteria: LL (L/480) and TL (L/240).
- Allowed moment does not reflect the adjustment for the beam stability factor.
- Critical positive moment adjusted by a volume/size factor of 1.00 that was calculated using length L = 9' 4".
- The effects of positive or negative camber have not been accounted for when calculating deflection.
- The specified glulam is assumed to have its strong laminations at the bottom of the beam. Install with proper side up as indicated by the manufacturer.
- Applicable calculations are based on NDS.

Supports	Bearing Length			Loads to Supports (lbs)			Accessories
	Total	Available	Required	Dead	Floor Live	Factored	
1 - Stud wall - HF	3.50"	3.50"	3.16"	1946	2529	4475	Blocking
2 - Stud wall - HF	3.50"	3.50"	3.16"	1946	2529	4475	Blocking

• Blocking Panels are assumed to carry no loads applied directly above them and the full load is applied to the member being designed.

Lateral Bracing	Bracing Intervals	Comments
Top Edge (Lu)	9' 8" o/c	
Bottom Edge (Lu)	9' 8" o/c	

•Maximum allowable bracing intervals based on applied load.

Vertical Loads	Location (Side)	Tributary Width	Dead (0.90)	Floor Live (1.00)	Comments
0 - Self Weight (PLF)	0 to 9' 8"	N/A	10.1	--	
1 - Uniform (PSF)	0 to 9' 8" (Front)	13' 1"	30.0	40.0	Default Load

Weyerhaeuser Notes

Weyerhaeuser warrants that the sizing of its products will be in accordance with Weyerhaeuser product design criteria and published design values. Weyerhaeuser expressly disclaims any other warranties related to the software. Use of this software is not intended to circumvent the need for a design professional as determined by the authority having jurisdiction. The designer of record, builder or framer is responsible to assure that this calculation is compatible with the overall project. Accessories (Rim Board, Blocking Panels and Squash Blocks) are not designed by this software. Products manufactured at Weyerhaeuser facilities are third-party certified to sustainable forestry standards. Weyerhaeuser Engineered Lumber Products have been evaluated by ICC-ES under evaluation reports ESR-1153 and ESR-1387 and/or tested in accordance with applicable ASTM standards. For current code evaluation reports, Weyerhaeuser product literature and installation details refer to www.eyerhaeuser.com/woodproducts/document-library.

The product application, input design loads, dimensions and support information have been provided by ForteWEB Software Operator

ForteWEB Software Operator	Job Notes
Chon Pieruccioni Pieruccioni Engineering (206) 949-7866 cpieru@hotmail.com	



3rd Floor Framing, Grid 6 (D.3-D.6) Flush Beam
1 piece(s) 3 1/2" x 11 7/8" 24F-V4 DF Glulam

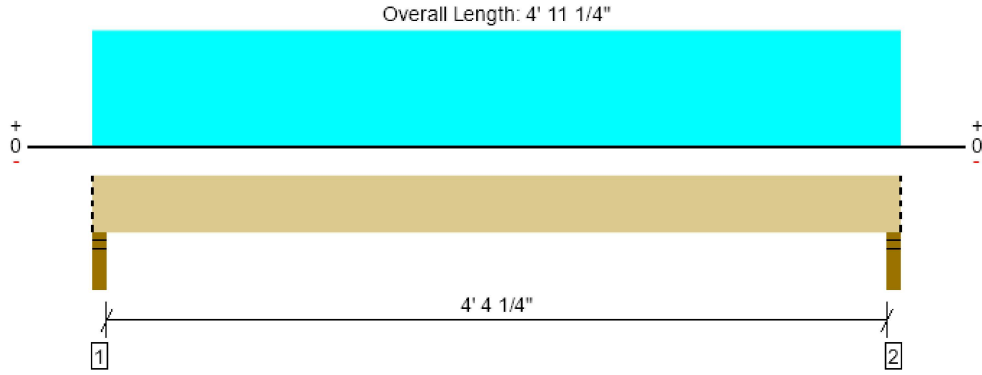

Drawing is Conceptual. All locations are measured from the outside face of left support (or left cantilever end). All dimensions are horizontal.

Design Results	Actual @ Location	Allowed	Result	LDF	Load: Combination (Pattern)
Member Reaction (lbs)	2372 @ 2"	4961 (3.50")	Passed (48%)	--	1.0 D + 1.0 L (All Spans)
Shear (lbs)	1141 @ 1' 3 3/8"	7343	Passed (16%)	1.00	1.0 D + 1.0 L (All Spans)
Pos Moment (Ft-lbs)	2546 @ 2' 5 5/8"	16452	Passed (15%)	1.00	1.0 D + 1.0 L (All Spans)
Live Load Defl. (in)	0.006 @ 2' 5 5/8"	0.115	Passed (L/999+)	--	1.0 D + 1.0 L (All Spans)
Total Load Defl. (in)	0.011 @ 2' 5 5/8"	0.230	Passed (L/999+)	--	1.0 D + 1.0 L (All Spans)

Member Length : 4' 11 1/4"
 System : Floor
 Member Type : Flush Beam
 Building Use : Residential
 Building Code : IBC 2018
 Design Methodology : ASD

- Deflection criteria: LL (L/480) and TL (L/240).
- Allowed moment does not reflect the adjustment for the beam stability factor.
- Critical positive moment adjusted by a volume/size factor of 1.00 that was calculated using length L = 4' 7 1/4".
- The effects of positive or negative camber have not been accounted for when calculating deflection.
- The specified glulam is assumed to have its strong laminations at the bottom of the beam. Install with proper side up as indicated by the manufacturer.
- Applicable calculations are based on NDS.

Supports	Bearing Length			Loads to Supports (lbs)			Accessories
	Total	Available	Required	Dead	Floor Live	Factored	
1 - Stud wall - HF	3.50"	3.50"	1.67"	1031	1341	2372	Blocking
2 - Stud wall - HF	3.50"	3.50"	1.67"	1031	1341	2372	Blocking

• Blocking Panels are assumed to carry no loads applied directly above them and the full load is applied to the member being designed.

Lateral Bracing	Bracing Intervals	Comments
Top Edge (Lu)	4' 11" o/c	
Bottom Edge (Lu)	4' 11" o/c	

•Maximum allowable bracing intervals based on applied load.

Vertical Loads	Location (Side)	Tributary Width	Dead (0.90)	Floor Live (1.00)	Comments
0 - Self Weight (PLF)	0 to 4' 11 1/4"	N/A	10.1	--	
1 - Uniform (PSF)	0 to 4' 11 1/4" (Front)	13' 7"	30.0	40.0	Default Load

Weyerhaeuser Notes

Weyerhaeuser warrants that the sizing of its products will be in accordance with Weyerhaeuser product design criteria and published design values. Weyerhaeuser expressly disclaims any other warranties related to the software. Use of this software is not intended to circumvent the need for a design professional as determined by the authority having jurisdiction. The designer of record, builder or framer is responsible to assure that this calculation is compatible with the overall project. Accessories (Rim Board, Blocking Panels and Squash Blocks) are not designed by this software. Products manufactured at Weyerhaeuser facilities are third-party certified to sustainable forestry standards. Weyerhaeuser Engineered Lumber Products have been evaluated by ICC-ES under evaluation reports ESR-1153 and ESR-1387 and/or tested in accordance with applicable ASTM standards. For current code evaluation reports, Weyerhaeuser product literature and installation details refer to www.woyehaeuser.com/woodproducts/document-library.

The product application, input design loads, dimensions and support information have been provided by ForteWEB Software Operator

ForteWEB Software Operator	Job Notes
Chon Pieruccioni Pieruccioni Engineering (206) 949-7866 cpieru@hotmail.com	



Roof Framing, Grid I Entry Roof Beam
1 piece(s) 3 1/2" x 10 1/2" 24F-V4 DF Glulam

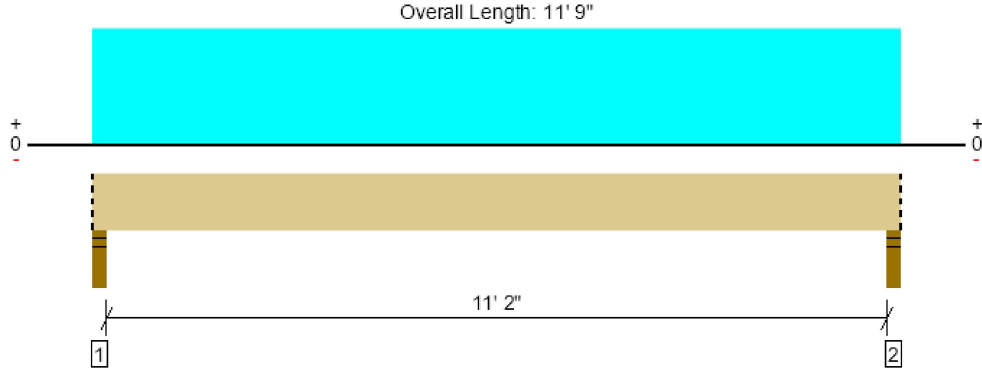

Drawing is Conceptual. All locations are measured from the outside face of left support (or left cantilever end). All dimensions are horizontal.

Design Results	Actual @ Location	Allowed	Result	LDF	Load: Combination (Pattern)
Member Reaction (lbs)	4533 @ 2"	4961 (3.50")	Passed (91%)	--	1.0 D + 1.0 S (All Spans)
Shear (lbs)	3633 @ 1' 2"	7466	Passed (49%)	1.15	1.0 D + 1.0 S (All Spans)
Pos Moment (Ft-lbs)	12571 @ 5' 10 1/2"	14792	Passed (85%)	1.15	1.0 D + 1.0 S (All Spans)
Live Load Defl. (in)	0.240 @ 5' 10 1/2"	0.571	Passed (L/571)	--	1.0 D + 1.0 S (All Spans)
Total Load Defl. (in)	0.486 @ 5' 10 1/2"	0.761	Passed (L/282)	--	1.0 D + 1.0 S (All Spans)

Member Length : 11' 9"
 System : Roof
 Member Type : Drop Beam
 Building Use : Residential
 Building Code : IBC 2018
 Design Methodology : ASD
 Member Pitch : 0.25/12

- Deflection criteria: LL (L/240) and TL (L/180).
- Allowed moment does not reflect the adjustment for the beam stability factor.
- Critical positive moment adjusted by a volume/size factor of 1.00 that was calculated using length L = 11' 5".
- The effects of positive or negative camber have not been accounted for when calculating deflection.
- The specified glulam is assumed to have its strong laminations at the bottom of the beam. Install with proper side up as indicated by the manufacturer.
- Applicable calculations are based on NDS.

Supports	Bearing Length			Loads to Supports (lbs)			Accessories
	Total	Available	Required	Dead	Snow	Factored	
1 - Stud wall - HF	3.50"	3.50"	3.20"	2293	2240	4533	Blocking
2 - Stud wall - HF	3.50"	3.50"	3.20"	2293	2240	4533	Blocking

• Blocking Panels are assumed to carry no loads applied directly above them and the full load is applied to the member being designed.

Lateral Bracing	Bracing Intervals	Comments
Top Edge (Lu)	11' 9" o/c	
Bottom Edge (Lu)	11' 9" o/c	

•Maximum allowable bracing intervals based on applied load.

Vertical Loads	Location (Side)	Tributary Width	Dead (0.90)	Snow (1.15)	Comments
0 - Self Weight (PLF)	0 to 11' 9"	N/A	8.9	--	
1 - Uniform (PSF)	0 to 11' 9" (Front)	15' 3"	25.0	25.0	Default Load

Weyerhaeuser Notes

Weyerhaeuser warrants that the sizing of its products will be in accordance with Weyerhaeuser product design criteria and published design values. Weyerhaeuser expressly disclaims any other warranties related to the software. Use of this software is not intended to circumvent the need for a design professional as determined by the authority having jurisdiction. The designer of record, builder or framer is responsible to assure that this calculation is compatible with the overall project. Accessories (Rim Board, Blocking Panels and Squash Blocks) are not designed by this software. Products manufactured at Weyerhaeuser facilities are third-party certified to sustainable forestry standards. Weyerhaeuser Engineered Lumber Products have been evaluated by ICC-ES under evaluation reports ESR-1153 and ESR-1387 and/or tested in accordance with applicable ASTM standards. For current code evaluation reports, Weyerhaeuser product literature and installation details refer to www.weyerhaeuser.com/woodproducts/document-library.

The product application, input design loads, dimensions and support information have been provided by ForteWEB Software Operator

ForteWEB Software Operator	Job Notes
Chon Pieruccioni Pieruccioni Engineering (206) 949-7866 cpieru@hotmail.com	



Roof Framing, Grid L 10' Deck Roof Beam
1 piece(s) 3 1/2" x 10 1/2" 24F-V4 DF Glulam

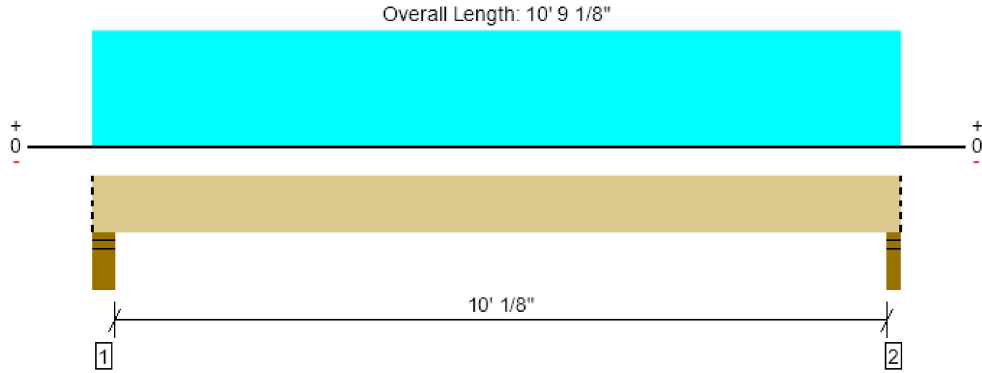

Drawing is Conceptual. All locations are measured from the outside face of left support (or left cantilever end). All dimensions are horizontal.

Design Results	Actual @ Location	Allowed	Result	LDF	Load: Combination (Pattern)
Member Reaction (lbs)	4992 @ 10' 7 1/8"	4961 (3.50")	Passed (101%)	--	1.0 D + 1.0 S (All Spans)
Shear (lbs)	3893 @ 1' 4"	7466	Passed (52%)	1.15	1.0 D + 1.0 S (All Spans)
Pos Moment (Ft-lbs)	12402 @ 5' 5 9/16"	14792	Passed (84%)	1.15	1.0 D + 1.0 S (All Spans)
Live Load Defl. (in)	0.192 @ 5' 5 9/16"	0.513	Passed (L/643)	--	1.0 D + 1.0 S (All Spans)
Total Load Defl. (in)	0.387 @ 5' 5 9/16"	0.684	Passed (L/318)	--	1.0 D + 1.0 S (All Spans)

Member Length : 10' 9 1/8"
 System : Roof
 Member Type : Drop Beam
 Building Use : Residential
 Building Code : IBC 2018
 Design Methodology : ASD
 Member Pitch : 0.25/12

- Deflection criteria: LL (L/240) and TL (L/180).
- Allowed moment does not reflect the adjustment for the beam stability factor.
- Critical positive moment adjusted by a volume/size factor of 1.00 that was calculated using length L = 10' 3 1/8".
- The effects of positive or negative camber have not been accounted for when calculating deflection.
- The specified glulam is assumed to have its strong laminations at the bottom of the beam. Install with proper side up as indicated by the manufacturer.
- Applicable calculations are based on NDS.

Supports	Bearing Length			Loads to Supports (lbs)			Accessories
	Total	Available	Required	Dead	Snow	Factored	
1 - Stud wall - HF	5.50"	5.50"	3.63"	2600	2550	5149	Blocking
2 - Stud wall - HF	3.50"	3.50"	3.52"	2520	2472	4992	Blocking

• Blocking Panels are assumed to carry no loads applied directly above them and the full load is applied to the member being designed.

Lateral Bracing	Bracing Intervals	Comments
Top Edge (Lu)	10' 9" o/c	
Bottom Edge (Lu)	10' 9" o/c	

•Maximum allowable bracing intervals based on applied load.

Vertical Loads	Location (Side)	Tributary Width	Dead (0.90)	Snow (1.15)	Comments
0 - Self Weight (PLF)	0 to 10' 9 1/8"	N/A	8.9	--	
1 - Uniform (PSF)	0 to 10' 9 1/8" (Front)	18' 8"	25.0	25.0	Default Load

Weyerhaeuser Notes

Weyerhaeuser warrants that the sizing of its products will be in accordance with Weyerhaeuser product design criteria and published design values. Weyerhaeuser expressly disclaims any other warranties related to the software. Use of this software is not intended to circumvent the need for a design professional as determined by the authority having jurisdiction. The designer of record, builder or framer is responsible to assure that this calculation is compatible with the overall project. Accessories (Rim Board, Blocking Panels and Squash Blocks) are not designed by this software. Products manufactured at Weyerhaeuser facilities are third-party certified to sustainable forestry standards. Weyerhaeuser Engineered Lumber Products have been evaluated by ICC-ES under evaluation reports ESR-1153 and ESR-1387 and/or tested in accordance with applicable ASTM standards. For current code evaluation reports, Weyerhaeuser product literature and installation details refer to www.weyerhaeuser.com/woodproducts/document-library.

The product application, input design loads, dimensions and support information have been provided by ForteWEB Software Operator

ForteWEB Software Operator	Job Notes
Chon Pieruccioni Pieruccioni Engineering (206) 949-7866 cpieru@hotmail.com	



Roof Framing, 6' Window Header
1 piece(s) 4 x 10 DF No.2

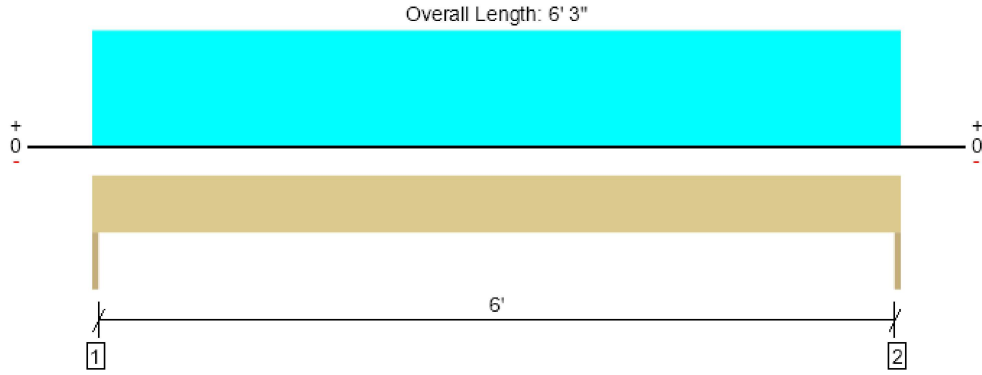

Drawing is Conceptual. All locations are measured from the outside face of left support (or left cantilever end). All dimensions are horizontal.

Design Results	Actual @ Location	Allowed	Result	LDF	Load: Combination (Pattern)
Member Reaction (lbs)	2956 @ 0	3281 (1.50")	Passed (90%)	--	1.0 D + 1.0 S (All Spans)
Shear (lbs)	2108 @ 10 3/4"	4468	Passed (47%)	1.15	1.0 D + 1.0 S (All Spans)
Moment (Ft-lbs)	4618 @ 3' 1 1/2"	5166	Passed (89%)	1.15	1.0 D + 1.0 S (All Spans)
Live Load Defl. (in)	0.044 @ 3' 1 1/2"	0.208	Passed (L/999+)	--	1.0 D + 1.0 S (All Spans)
Total Load Defl. (in)	0.088 @ 3' 1 1/2"	0.313	Passed (L/853)	--	1.0 D + 1.0 S (All Spans)

Member Length : 6' 3"
 System : Wall
 Member Type : Header
 Building Use : Residential
 Building Code : IBC 2018
 Design Methodology : ASD

- Deflection criteria: LL (L/360) and TL (L/240).
- Allowed moment does not reflect the adjustment for the beam stability factor.
- Applicable calculations are based on NDS.

Supports	Bearing Length			Loads to Supports (lbs)			Accessories
	Total	Available	Required	Dead	Snow	Factored	
1 - Trimmer - HF	1.50"	1.50"	1.50"	1491	1465	2956	None
2 - Trimmer - HF	1.50"	1.50"	1.50"	1491	1465	2956	None

Lateral Bracing	Bracing Intervals	Comments
Top Edge (Lu)	6' 3" o/c	
Bottom Edge (Lu)	6' 3" o/c	

•Maximum allowable bracing intervals based on applied load.

Vertical Loads	Location	Tributary Width	Dead (0.90)	Snow (1.15)	Comments
0 - Self Weight (PLF)	0 to 6' 3"	N/A	8.2	--	
1 - Uniform (PSF)	0 to 6' 3"	18' 9"	25.0	25.0	Default Load

Weyerhaeuser Notes
 Weyerhaeuser warrants that the sizing of its products will be in accordance with Weyerhaeuser product design criteria and published design values. Weyerhaeuser expressly disclaims any other warranties related to the software. Use of this software is not intended to circumvent the need for a design professional as determined by the authority having jurisdiction. The designer of record, builder or framer is responsible to assure that this calculation is compatible with the overall project. Accessories (Rim Board, Blocking Panels and Squash Blocks) are not designed by this software. Products manufactured at Weyerhaeuser facilities are third-party certified to sustainable forestry standards. Weyerhaeuser Engineered Lumber Products have been evaluated by ICC-ES under evaluation reports ESR-1153 and ESR-1387 and/or tested in accordance with applicable ASTM standards. For current code evaluation reports, Weyerhaeuser product literature and installation details refer to www.weyerhaeuser.com/woodproducts/document-library.
 The product application, input design loads, dimensions and support information have been provided by ForteWEB Software Operator

ForteWEB Software Operator	Job Notes
Chon Pieruccioni Pieruccioni Engineering (206) 949-7866 cpieru@hotmail.com	



Roof Framing, Grid B 11' Deck Roof Beam
1 piece(s) 3 1/2" x 10 1/2" 24F-V4 DF Glulam

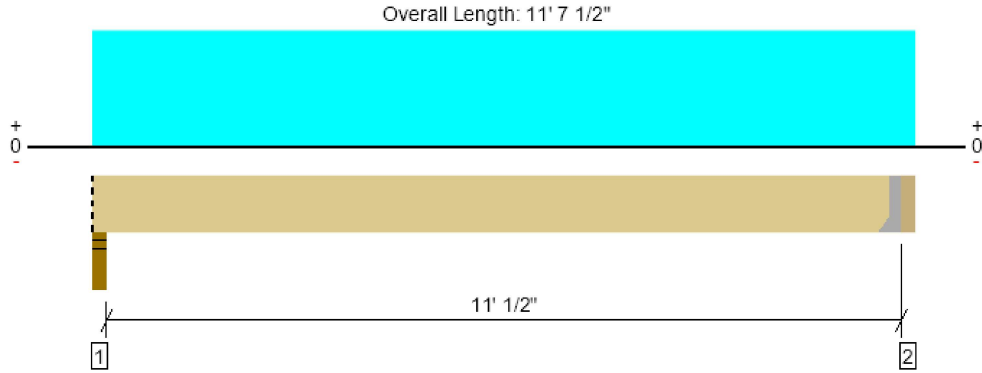

Drawing is Conceptual. All locations are measured from the outside face of left support (or left cantilever end). All dimensions are horizontal.

Design Results	Actual @ Location	Allowed	Result	LDF	Load: Combination (Pattern)
Member Reaction (lbs)	4622 @ 11' 4"	4622 (2.03")	Passed (100%)	--	1.0 D + 1.0 S (All Spans)
Shear (lbs)	3898 @ 10' 5 1/2"	7466	Passed (52%)	1.15	1.0 D + 1.0 S (All Spans)
Pos Moment (Ft-lbs)	12904 @ 5' 9"	14792	Passed (87%)	1.15	1.0 D + 1.0 S (All Spans)
Live Load Defl. (in)	0.236 @ 5' 9"	0.558	Passed (L/569)	--	1.0 D + 1.0 S (All Spans)
Total Load Defl. (in)	0.477 @ 5' 9"	0.745	Passed (L/281)	--	1.0 D + 1.0 S (All Spans)

Member Length : 11' 4"
 System : Roof
 Member Type : Drop Beam
 Building Use : Residential
 Building Code : IBC 2018
 Design Methodology : ASD
 Member Pitch : 0.25/12

- Deflection criteria: LL (L/240) and TL (L/180).
- Allowed moment does not reflect the adjustment for the beam stability factor.
- Critical positive moment adjusted by a volume/size factor of 1.00 that was calculated using length L = 11' 2".
- The effects of positive or negative camber have not been accounted for when calculating deflection.
- The specified glulam is assumed to have its strong laminations at the bottom of the beam. Install with proper side up as indicated by the manufacturer.
- Applicable calculations are based on NDS.

Supports	Bearing Length			Loads to Supports (lbs)			Accessories
	Total	Available	Required	Dead	Snow	Factored	
1 - Stud wall - HF	3.50"	3.50"	3.36"	2406	2354	4760	Blocking
2 - Hanger on 10 1/2" GLB beam	3.50"	Hanger ¹	2.03"	2456	2405	4861	See note ¹

- Blocking Panels are assumed to carry no loads applied directly above them and the full load is applied to the member being designed.
- At hanger supports, the Total Bearing dimension is equal to the width of the material that is supporting the hanger
- ¹ See Connector grid below for additional information and/or requirements.

Lateral Bracing	Bracing Intervals	Comments
Top Edge (Lu)	11' 4" o/c	
Bottom Edge (Lu)	11' 4" o/c	

•Maximum allowable bracing intervals based on applied load.

Connector: Simpson Strong-Tie							
Support	Model	Seat Length	Top Fasteners	Face Fasteners	Member Fasteners	Accessories	
2 - Face Mount Hanger	Connector not found	N/A	N/A	N/A	N/A		

- Refer to manufacturer notes and instructions for proper installation and use of all connectors.

Vertical Loads	Location (Side)	Tributary Width	Dead (0.90)	Snow (1.15)	Comments
0 - Self Weight (PLF)	0 to 11' 4"	N/A	8.9	--	
1 - Uniform (PSF)	0 to 11' 7 1/2" (Front)	16' 4 1/2"	25.0	25.0	Default Load

Weyerhaeuser Notes
 Weyerhaeuser warrants that the sizing of its products will be in accordance with Weyerhaeuser product design criteria and published design values. Weyerhaeuser expressly disclaims any other warranties related to the software. Use of this software is not intended to circumvent the need for a design professional as determined by the authority having jurisdiction. The designer of record, builder or framer is responsible to assure that this calculation is compatible with the overall project. Accessories (Rim Board, Blocking Panels and Squash Blocks) are not designed by this software. Products manufactured at Weyerhaeuser facilities are third-party certified to sustainable forestry standards. Weyerhaeuser Engineered Lumber Products have been evaluated by ICC-ES under evaluation reports ESR-1153 and ESR-1387 and/or tested in accordance with applicable ASTM standards. For current code evaluation reports, Weyerhaeuser product literature and installation details refer to www.woyehaeuser.com/woodproducts/document-library.
 The product application, input design loads, dimensions and support information have been provided by ForteWEB Software Operator

ForteWEB Software Operator	Job Notes
Chon Pieruccioni Pieruccioni Engineering (206) 949-7866 cpieru@hotmail.com	



Roof Framing, Deck Roof Cantilever Beam
1 piece(s) 5 1/2" x 10 1/2" 24F-V4 DF Glulam

An excessive uplift of -2576 lbs at support located at 4" failed this product. Uplift resisted by (2) ST6215 straps

Overall Length: 6' 5 1/2"

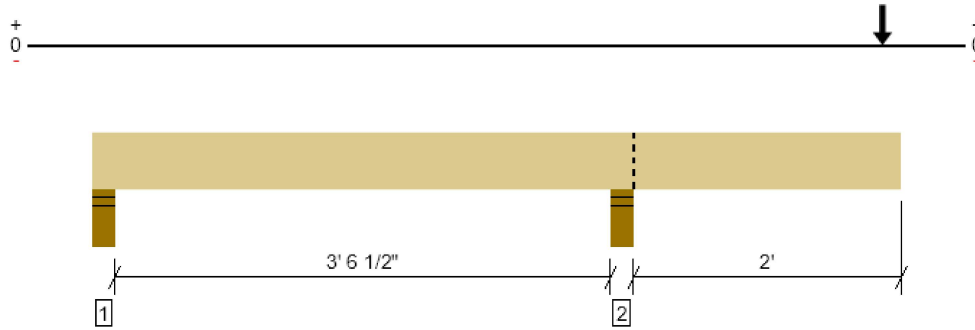

Drawing is Conceptual. All locations are measured from the outside face of left support (or left cantilever end). All dimensions are horizontal.

Design Results	Actual @ Location	Allowed	Result	LDF	Load: Combination (Pattern)
Member Reaction (lbs)	7528 @ 4' 2 3/4"	12254 (5.50")	Passed (61%)	--	1.0 D + 1.0 S (All Spans)
Shear (lbs)	4877 @ 5' 4"	11733	Passed (42%)	1.15	1.0 D + 1.0 S (All Spans)
Pos Moment (Ft-lbs)	0 @ N/A	N/A	Passed (N/A)	--	N/A
Neg Moment (Ft-lbs)	-10162 @ 4' 2 3/4"	17918	Passed (57%)	1.15	1.0 D + 1.0 S (All Spans)
Live Load Defl. (in)	0.041 @ 6' 5 1/2"	0.223	Passed (2L/999+)	--	1.0 D + 1.0 S (All Spans)
Total Load Defl. (in)	0.082 @ 6' 5 1/2"	0.297	Passed (2L/648)	--	1.0 D + 1.0 S (All Spans)

Member Length : 6' 5 1/2"
System : Roof
Member Type : Drop Beam
Building Use : Residential
Building Code : IBC 2018
Design Methodology : ASD
Member Pitch : 0.25/12

- Deflection criteria: LL (L/240) and TL (L/180).
- Overhang deflection criteria: LL (2L/240) and TL (2L/180).
- Allowed moment does not reflect the adjustment for the beam stability factor.
- Critical negative moment adjusted by a volume/size factor of 1.00 that was calculated using length L = 6' 1 1/2".
- The effects of positive or negative camber have not been accounted for when calculating deflection.
- The specified glulam is assumed to have its strong laminations at the bottom of the beam. Install with proper side up as indicated by the manufacturer.
- Applicable calculations are based on NDS.

Supports	Bearing Length			Loads to Supports (lbs)			Accessories
	Total	Available	Required	Dead	Snow	Factored	
1 - Stud wall - HF	5.50"	5.50"	1.50"	-1290	-1286	-2576	None
2 - Stud wall - HF	5.50"	5.50"	3.38"	3837	3691	7528	Blocking

• Blocking Panels are assumed to carry no loads applied directly above them and the full load is applied to the member being designed.

Lateral Bracing	Bracing Intervals	Comments
Top Edge (Lu)	6' 6" o/c	
Bottom Edge (Lu)	6' 6" o/c	

•Maximum allowable bracing intervals based on applied load.

Vertical Loads	Location (Side)	Tributary Width	Dead (0.90)	Snow (1.15)	Comments
0 - Self Weight (PLF)	0 to 6' 5 1/2"	N/A	14.0	--	
1 - Point (lb)	6' 3 3/4" (Front)	N/A	2456	2405	Linked from: Grid A 14' Deck Roof Beam, Support 2

Weyerhaeuser Notes

Weyerhaeuser warrants that the sizing of its products will be in accordance with Weyerhaeuser product design criteria and published design values. Weyerhaeuser expressly disclaims any other warranties related to the software. Use of this software is not intended to circumvent the need for a design professional as determined by the authority having jurisdiction. The designer of record, builder or framer is responsible to assure that this calculation is compatible with the overall project. Accessories (Rim Board, Blocking Panels and Squash Blocks) are not designed by this software. Products manufactured at Weyerhaeuser facilities are third-party certified to sustainable forestry standards. Weyerhaeuser Engineered Lumber Products have been evaluated by ICC-ES under evaluation reports ESR-1153 and ESR-1387 and/or tested in accordance with applicable ASTM standards. For current code evaluation reports, Weyerhaeuser product literature and installation details refer to www.weyerhaeuser.com/woodproducts/document-library.

The product application, input design loads, dimensions and support information have been provided by ForteWEB Software Operator

ForteWEB Software Operator	Job Notes
Chon Pieruccioni Pieruccioni Engineering (206) 949-7866 cpieru@hotmail.com	



GEOMETRY			SOIL PRESSURES (D+L)		
Footing Length (X-dir)	3.50	ft	Gross Allow. Soil Pressure	2.0	ksf
Footing Width (Z-dir)	3.50	ft	Soil Pressure at Corner 1	1.5	ksf
Footing Thickness	8.0	in OK	Soil Pressure at Corner 2	1.5	ksf
Soil Cover	0.00	ft	Soil Pressure at Corner 3	1.5	ksf
Column Length (X-dir)	6.0	in	Soil Pressure at Corner 4	1.5	ksf
Column Width (Z-dir)	6.0	in	Bearing Pressure Ratio	0.77	OK
Offset (X-dir)	0.00	in OK	Ftg. Area in Contact with Soil	100.0	%
Offset (Z-dir)	0.00	in OK	X-eccentricity / Ftg. Length	0.00	OK
Base Plate (L x W)	6.0 x 6.0	in	Z-eccentricity / Ftg. Width	0.00	OK

APPLIED LOADS

	Dead	Live	RLive	Snow	Wind	Seismic	
Axial Force P	4.4	13.7	0.0	0.0	0.0	0.0	kip
Moment about X Mx ..	0.0	0.0	0.0	0.0	0.0	0.0	k-ft
Moment about Z Mz ..	0.0	0.0	0.0	0.0	0.0	0.0	k-ft
Shear Force Vx	0.0	0.0	0.0	0.0	0.0	0.0	kip
Shear Force Vz	0.0	0.0	0.0	0.0	0.0	0.0	kip

OVERTURNING CALCULATIONS (Comb: 0.6D+0.6W)

- Overturning about X-X

- Moment Mx = 0.6 * 0.0 + 0.6 * 0.0 = 0.0 k-ft

- Shear Force Vz = 0.6 * 0.0 + 0.6 * 0.0 = 0.0 kip

Arm = 0.00 + 8.0 / 12 = 0.67 ft

Moment = 0.0 * 0.67 = 0.0 k-ft

- Passive Force = 0.0 kip

Arm = 0.27 ft

Moment = 0.0 k-ft

- Overturning moment X-X = 0.0 + 0.0 = 0.0 k-ft

- Resisting about X-X

- Footing weight = $0.6 * W * L * Thick * Density = 0.6 * 3.50 * 3.50 * 8.0 / 12 * 0.15 = 0.7$ kip

Arm = $W / 2 = 3.50 / 2 = 1.75$ ft

Moment = $0.7 * 1.75 = 1.3$ k-ft

- Pedestal weight = $0.6 * W * L * H * Density = 0.6 * 6.0 / 12 * 6.0 / 12 * 0.0 * 0.15 = 0.0$ kip

Arm = $W / 2 - Offset = 3.50 / 2 - 0.0 / 12 = 1.75$ ft

Moment = $0.0 * 1.75 = 0.0$ k-ft

- Soil cover = $0.6 * W * L * SC * Density = 0.6 * (3.50 * 3.50 - 6.0 / 12 * 6.0 / 12) * 0.0 * 110 = 0.0$ kip

Arm = $W / 2 = 3.50 / 2 = 1.75$ ft

Moment = $0.0 * 1.75 = 0.0$ k-ft

- Buoyancy = $0.6 * W * L * \gamma * (SC + Thick - WT) = 0.6 * 3.50 * 3.50 * 62 * (0.67) = -0.3$ kip

Arm = $W / 2 = 3.50 / 2 = 1.75$ ft

Moment = $0.3 * 1.75 = -0.5$ k-ft

- Axial force P = $0.6 * 4.4 + 0.6 * 0.0 = 2.6$ kip

Arm = $W / 2 - Offset = 3.50 / 2 - 0.0 / 12 = 1.75$ ft

Moment = $2.6 * 1.75 = 4.6$ k-ft

- Resisting moment X-X = $1.3 + 0.0 + 0.0 + 4.6 + -0.5 = 5.4$ k-ft

- Overturning safety factor X-X = $\frac{Resisting\ moment}{Overturning\ moment} = \frac{5.4}{0.0} = 53.71 > 1.50$ OK

- **Overturning about Z-Z**

- Moment $M_z = 0.6 * 0.0 + 0.6 * 0.0 = 0.0$ k-ft

- Shear Force $V_x = 0.6 * 0.0 + 0.6 * 0.0 = 0.0$ kip

Arm = $0.00 + 8.0 / 12 = 0.67$ ft

Moment = $0.0 * 0.67 = 0.0$ k-ft

- Passive Force = 0.0 kip

Arm = 0.27 ft

Moment = 0.0 k-ft

- Overturning moment Z-Z = $0.0 + 0.0 = 0.0$ k-ft

- **Resisting about Z-Z**

- Footing weight = $0.6 * W * L * Thick * Density = 0.6 * 3.50 * 3.50 * 8.0 / 12 * 0.15 = 0.7$ kip

Arm = $L / 2 = 3.50 / 2 = 1.75$ ft

Moment = $0.7 * 1.75 = 1.3$ k-ft

- Pedestal weight = $0.6 * W * L * H * Density = 0.6 * 6.0 / 12 * 6.0 / 12 * 0.0 * 0.15 = 0.0$ kip

Arm = $L / 2 - Offset = 3.50 / 2 - 0.0 / 12 = 1.75$ ft

Moment = $0.0 * 1.75 = 0.0$ k-ft

- Soil cover = $0.6 * W * L * SC * Density = 0.6 * (3.50 * 3.50 - 6.0 / 12 * 6.0 / 12) * 0.0 * 110 = 0.0$ kip

Arm = $L / 2 = 3.50 / 2 = 1.75$ ft

Moment = $0.0 * 1.75 = 0.0$ k-ft

- Buoyancy = $0.6 * W * L * \gamma * (SC + Thick - WT) = 0.6 * 3.50 * 3.50 * 62 * (0.67) = -0.3$ kip

Arm = $L / 2 = 3.50 / 2 = 1.75$ ft

Moment = $0.3 * 1.75 = -0.5$ k-ft

- Axial force $P = 0.6 * 4.4 + 0.6 * 0.0 = 2.6$ kip

Arm = $L / 2 - Offset = 3.50 / 2 - 0.0 / 12 = 1.75$ ft

Moment = $2.6 * 1.75 = 4.6$ k-ft

- Resisting moment Z-Z = $1.3 + 0.0 + 0.0 + 4.6 - 0.5 = 5.4$ k-ft

- Overturning safety factor Z-Z = $\frac{Resisting\ moment}{Overturning\ moment} = \frac{5.4}{0.0} = 53.71 > 1.50$ OK

SOIL BEARING PRESSURES (Comb: D+L)

Overturning moment X-X = $0.0 + 0.0 = 0.0$ k-ft

Resisting moment X-X = $2.1 + 0.0 + 0.0 + -0.9 + 31.7 = 32.9$ k-ft

Overturning moment Z-Z = $0.0 + 0.0 = 0.0$ k-ft

Resisting moment Z-Z = $2.1 + 0.0 + 0.0 + -0.9 + 31.7 = 32.9$ k-ft

Resisting force = $Footing + Pedestal + Soil - Buoyancy + P = 1.2 + 0.0 + 0.0 - 0.5 + 18.1 = 18.8$ kip

X-coordinate of resultant from maximum bearing corner:

$$X_p = \frac{Z-Resisting\ moment - Z-Overturning\ moment}{Resisting\ force} = \frac{32.9 - 0.0}{18.8} = 1.75\text{ ft}$$

Z-coordinate of resultant from maximum bearing corner:

$$Z_p = \frac{X-Resisting\ moment - X-Overturning\ moment}{Resisting\ force} = \frac{32.9 - 0.0}{18.8} = 1.75\text{ ft}$$

X-ecc = $Length / 2 - X_p = 3.50 / 2 - 1.75 = 0.00$ ft

Z-ecc = $Width / 2 - Z_p = 3.50 / 2 - 1.75 = 0.00$ ft

Area = $Width * Length = 3.50 * 3.50 = 12.3$ ft²

S_x = $Length * Width^2 / 6 = 3.50 * 3.50^2 / 6 = 7.1$ ft³

S_z = $Width * Length^2 / 6 = 3.50 * 3.50^2 / 6 = 7.1$ ft³

- Footing is in full bearing. Soil pressures are as follows:

P₁ = $P * (1/A + Z-ecc / S_x + X-ecc / S_z) = 18.8 * (1 / 12.3 + 0.00 / 7.1 + 0.00 / 7.1) = 1.54$ ksf

P₂ = $P * (1/A - Z-ecc / S_x + X-ecc / S_z) = 18.8 * (1 / 12.3 - 0.00 / 7.1 + 0.00 / 7.1) = 1.54$ ksf

P₃ = $P * (1/A - Z-ecc / S_x - X-ecc / S_z) = 18.8 * (1 / 12.3 - 0.00 / 7.1 - 0.00 / 7.1) = 1.54$ ksf

P₄ = $P * (1/A + Z-ecc / S_x - X-ecc / S_z) = 18.8 * (1 / 12.3 + 0.00 / 7.1 - 0.00 / 7.1) = 1.54$ ksf

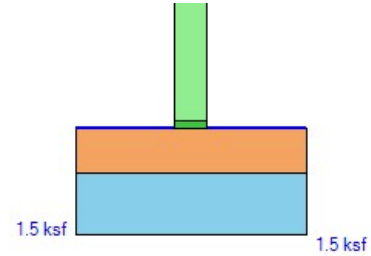
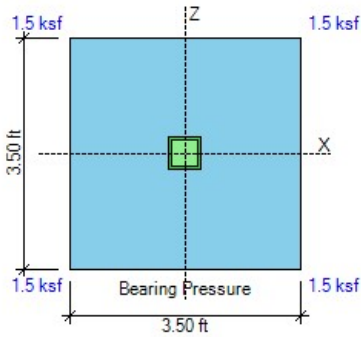

SLIDING CALCULATIONS (Comb: 0.6D+0.6W)

Internal friction angle = 28.0 deg

Passive coefficient $k_p = 4.33$ (per Coulomb)

Pressure at mid-depth = $k_p * Density * (Cover + Thick / 2) = 4.33 * 110 * (0.00 + 8.0 / 12 / 2) = 0.16$ ksf

X-Passive force = $Pressure * Thick * Width = 0.16 * 8.0 / 12 * 3.50 = 0.4$ kip

Z-Passive force = $Pressure * Thick * Length = 0.16 * 8.0 / 12 * 3.50 = 0.4$ kip

Friction force = $Resisting\ force * Friction\ coeff. = \text{Max}(0, 3.1 * 0.35) = 1.1$ kip

Use 100% of Passive + 100% of Friction for sliding resistance

$$\text{- Sliding safety factor X-X} = \frac{X\text{-Passive force} + Friction}{X\text{-Horizontal load}} = \frac{1.00 * 0.4 + 1.00 * 1.1}{0.0} = 14.44 > 1.50 \text{ OK}$$

$$\text{- Sliding safety factor Z-Z} = \frac{Z\text{-Passive force} + Friction}{Z\text{-Horizontal load}} = \frac{1.00 * 0.4 + 1.00 * 1.1}{0.0} = 14.44 > 1.50 \text{ OK}$$

UPLIFT CALCULATIONS (Comb: 0.6D+0.6W)

$$\text{- Uplift safety factor} = \frac{Pedestal + Footing + Cover - Buoyancy}{Uplift load} = \frac{0.0 + 0.7 + 0.0 - 0.3}{0.0} = 99.99 > 1.00 \text{ OK}$$

ONE-WAY SHEAR CALCULATIONS (Comb: 1.2D+1.6L+0.5Lr)

Concrete $f_c = 2.5$ ksi

Steel $f_y = 40.0$ ksi

Soil density = 110 pcf

d Top X-dir = $Thick - Cover - X\text{-diameter} / 2 = 8.0 - 2.0 - 0.8 / 2 = 5.6$ in

d Top Z-dir = $Thick - Cover - X\text{-diameter} - Z\text{-diameter} / 2 = 8.0 - 2.0 - 0.8 - 0.8 / 2 = 4.9$ in

d Bot X-dir = $Thick - Cover - X\text{-diameter} / 2 = 8.0 - 3.0 - 0.5 / 2 = 4.8$ in

d Bot Z-dir = $Thick - Cover - X\text{-diameter} - Z\text{-diameter} / 2 = 8.0 - 3.0 - 0.5 - 0.5 / 2 = 4.3$ in

$\phi V_{cx} = 2 * \phi * \sqrt{f_c} * Width * d / 1000 = 2 * 0.75 * \sqrt{2500} * 3.5 * 12 * 4.8 / 1000 = 15.0$ kip

ACI Eq. (22.5.5.1)

$\phi V_{cz} = 2 * \phi * \sqrt{f_c} * Length * d / 1000 = 2 * 0.75 * \sqrt{2500} * 3.5 * 12 * 4.3 / 1000 = 13.4$ kip

- Shear forces calculated as the volume of the bearing pressures under the effective areas:

One-way shear V_{ux} (- Side) = 8.8 kip < 15.0 kip OK

One-way shear V_{ux} (+ Side) = 8.7 kip < 15.0 kip OK

One-way shear V_{uz} (- Side) = 8.8 kip < 13.4 kip OK

One-way shear V_{uz} (+ Side) = 8.7 kip < 13.4 kip OK

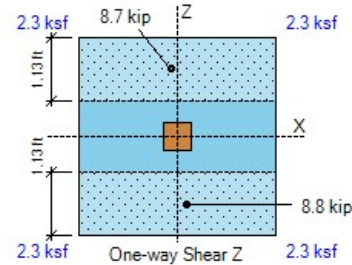
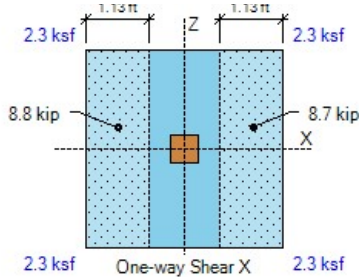

FLEXURE CALCULATIONS (Comb: 1.2D+1.6L+0.5Lr)

Plain $\phi M_{nx} = 5 * \phi * \sqrt{f_c} * L * Thick^2 / 6 = 5 * 0.60 * \sqrt{(2500)} * 3.50 * 8.0^2 / 6 / 1000 = 1.5 \text{ k-ft}$

ACI Eq. (14.5.2.1a)

Plain $\phi M_{nz} = 5 * \phi * \sqrt{f_c} * W * Thick^2 / 6 = 5 * 0.60 * \sqrt{(2500)} * 3.50 * 8.0^2 / 6 / 1000 = 1.5 \text{ k-ft}$

- Top Bars

No Top Reinforcement Provided at the Footing

Use Plain Concrete Flexural Strength at Top

- Top moments calculated as the overburden minus the bearing pressures times the lever arm:

Top moment -Mux (- Side) = 0.0 k-ft < 5.6 k-ft OK

Top moment -Mux (+ Side) = 0.0 k-ft < 5.6 k-ft OK

Top moment -Muz (- Side) = 0.0 k-ft < 5.6 k-ft OK

Top moment -Muz (+ Side) = 0.0 k-ft < 5.6 k-ft OK

- Bottom Bars

Use 5 #4 Z-Bars $\rho = A_s / b d = 1.0 / (3.50 * 12 * 4.3) = 0.0056$

$q = 0.0056 * 40 / 2.5 = 0.090$

Use 5 #4 X-Bars $\rho = A_s / b d = 1.0 / (3.50 * 12 * 4.8) = 0.0050$

$q = 0.0050 * 40 / 2.5 = 0.080$

$\beta = L / W = 3.50 / 3.50 = 1.00$ $\gamma_s = 2 * \beta / (\beta + 1) = 2 * 1.00 / (1.00 + 1) = 1.00$

ACI 13.3.3.3

Bending strength $\phi Mn = \phi * b * d^2 * f_c * q * (1 - 0.59 * q)$

ACI 22.2.2

$\phi M_{nx} = 0.90 * 3.50 * 12 * 4.3^2 * 2.5 * 0.090 * (1 - 0.59 * 0.090) = 12.1 \text{ k-ft}$

$\phi M_{nz} = 0.90 * 3.50 * 12 * 4.8^2 * 2.5 * 0.080 / 1.00 * (1 - 0.59 * 0.080 / 1.00) = 13.6 \text{ k-ft}$

- Bottom moments calculated as the bearing minus the overburden pressures times the lever arm:

Bottom moment Mux (- Side) = 8.8 k-ft < 12.1 k-ft OK ratio = 0.73

Bottom moment Mux (+ Side) = 8.8 k-ft < 12.1 k-ft OK ratio = 0.73

Bottom moment Muz (- Side) = 8.8 k-ft < 13.6 k-ft OK ratio = 0.65

Bottom moment Muz (+ Side) = 8.8 k-ft < 13.6 k-ft OK ratio = 0.65

X-As min = $0.0018 * Width * Thick = 0.0018 * 3.50 * 12 * 8.0 = 0.6 \text{ in}^2$ < 1.0 in² OK

ACI 8.6.1.1

Z-As min = $0.0018 * Length * Thick = 0.0018 * 3.50 * 12 * 8.0 = 0.6 \text{ in}^2$ < 1.0 in² OK

ACI 8.6.1.1

X-As max for 0.005 tension strain = 3.20 in² > 1.00 in² OK

ACI 21.2.2

Z-As max for 0.005 tension strain = 3.20 in² > 1.00 in² OK

ACI 21.2.2

X-Cover factor = $Min(2.5, (Cover + db / 2, Spacing / 2) / db) = Min(2.5, (3.0 + 0.50 / 2, 9.0 / 2) / 0.50) = 2.5$

Straight X-Ld = $Max(12.0, 3 / 40 * f_y / (f_c)^{1/2} * Grade * Size * Casting / Cover * db * ratio)$

ACI Eq. (25.4.2.3a)

X-Ld = $Max(12.0, 3 / 40 * 40.0 * 1000 / (2500)^{1/2} * 1.0 * 0.8 * 1.0 / 2.5 * 0.50 * 0.65) = 12.0 \text{ in}$

Hooked X-Ldh = $Max(8 db, 6, 0.02 * f_y / (f_c)^{1/2} * Confining * Location * Concrete * db * ratio) =$

ACI 25.4.3

X-Ldh = $Max(8 db, 6, 0.02 * 40.0 * 1000 / (2500)^{1/2} * 1.0 * 0.7 * 0.0 * 0.50 * 0.65) = 6.0 \text{ in}$

-X Ld provided = $(Length - Col) / 2 + Offset - Cover = 3.50 * 12 / 2 + 0.0 - 6.0 / 2 - 2.5 = 15.5 \text{ in}$ > 12.0 in OK

+X Ld provided = $(Length - Col) / 2 - Offset - Cover = 3.50 * 12 / 2 - 0.0 - 6.0 / 2 - 2.5 = 15.5 \text{ in}$ > 12.0 in OK 4 of 7

Z-Cover factor = $\text{Min}(2.5, (\text{Cover} + db / 2, \text{Spacing} / 2) / db) = \text{Min}(2.5, (3.0 + 0.50 / 2, 9.0 / 2) / 0.50) = 2.5$

Straight Z-Ld = $\text{Max}(12.0, 3 / 40 * fy / (fc)^{1/2} * \text{Grade} * \text{Size} * \text{Casting} / \text{Cover} * db * \text{ratio})$ ACI Eq. (25.4.2.3a)

Z-Ld = $\text{Max}(12.0, 3 / 40 * 40.0 * 1000 / (2500)^{1/2} * 1.0 * 0.8 * 1.0 / 2.5 * 0.50 * 0.65) = 12.0 \text{ in}$

Hooked Z-Ldh = $\text{Max}(8 db, 6, 0.02 * fy / (fc)^{1/2} * \text{Confining} * \text{Location} * \text{Concrete} * db * \text{ratio}) =$ ACI 25.4.3

Z-Ldh = $\text{Max}(8 db, 6, 0.02 * 40.0 * 1000 / (2500)^{1/2} * 1.0 * 0.7 * 0.0 * 0.50 * 0.73) = 6.0 \text{ in}$

-Z Ld provided = $(\text{Width} - \text{Col}) / 2 + \text{Offset} - \text{Cover} = 3.50 * 12 / 2 + 0.0 - 6.0 / 2 - 2.5 = 15.5 \text{ in} > 12.0 \text{ in OK}$

+Z Ld provided = $(\text{Width} - \text{Col}) / 2 - \text{Offset} - \text{Cover} = 3.50 * 12 / 2 - 0.0 - 6.0 / 2 - 2.5 = 15.5 \text{ in} > 12.0 \text{ in OK}$

X-bar spacing = 9.0 in < $\text{Min}(3 * t, 18.0) = 18.0 \text{ in OK}$ ACI 7.7.2.3

Z-bar spacing = 9.0 in < $\text{Min}(3 * t, 18.0) = 18.0 \text{ in OK}$

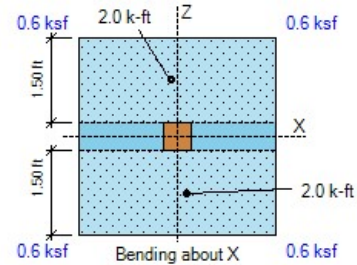
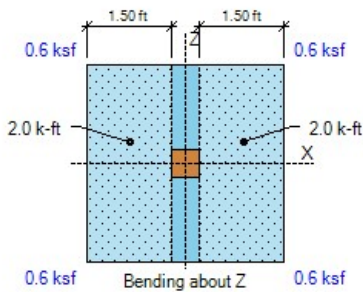

LOAD TRANSFER CALCULATIONS (Comb: 1.2D+1.6L+0.5Lr)

Area $A1 = col L * col W = 6.0 * 6.0 = 36.0 \text{ in}^2$

$Sx = col W * col L^2 / 6 = 6.0 * 6.0^2 / 6 = 36.0 \text{ in}^3$

$Sz = col L * col W^2 / 6 = 6.0 * 6.0^2 / 6 = 36.0 \text{ in}^3$

Bearing $Pbu = P / A1 + Mz / Sx + Mx / Sz = 27.2 / 36.0 + 0.0 * 12 / 36.0 + 0.0 * 12 / 36.0 = 0.8 \text{ ksi}$

Min edge = $\text{Min}(L / 2 - X\text{-offset} - col L / 2, W / 2 - Z\text{-offset} - col W / 2)$

Min edge = $\text{Min}(3.50 * 12 / 2 - 0.0 - 6.0 / 2, 3.50 * 12 / 2 - 0.0 - 6.0 / 2) = 18.0 \text{ in}$

Area $A2 = \text{Min}[L * W, (col L + 2 * \text{Min edge}) * (col W + 2 * \text{Min edge})]$

ACI R22.8.3.2

$A2 = \text{Min}[3.50 * 12 * 3.5 * 12, (6.0 + 2 * 18.0) * (6.0 + 2 * 18.0)] = 1764.0 \text{ in}^2$

Footing $\phi Pnc = \phi * 0.85 * fc * \text{Min}[2, \sqrt{(A2 / A1)}] = 0.65 * 0.85 * 2.5 * \text{Min}[2, \sqrt{(1764.0 / 36.0)}] = 2.8 \text{ ksi}$

Footing $\phi Pns = \phi * As * Fy / A1 = 0.0 \text{ ksi}$

ACI 22.8.3.2

Footing bearing $\phi Pn = \phi Pnc + \phi Pns = 2.8 + 0.0 = 2.8 \text{ ksi} > 0.8 \text{ psi OK}$

Hooked $L_{dh} = \text{Max}(8 db, 6, 0.02 * f_y / (f_c)^{1/2} * \text{Confining} * \text{Location} * \text{Concrete} * db * \text{ratio})$

ACI 25.4.3

$$L_{dh} = \text{Max}(8 db, 6, 0.02 * 60.0 * 1000 / (2500)^{1/2} * 1.0 * 0.7 * 0.0 * 0.75 * 0.13) = 6.0 \text{ in}$$

Ld provided = Dowel length = $3.00 * 12 = 36.0 \text{ in} > 23.5 \text{ in OK}$

Ldh provided = Footing thickness - Cover = $8.00 - 3.0 = 5.0 \text{ in} < 6.0 \text{ in NG}$

PUNCHING SHEAR CALCULATIONS (Comb: 1.2D+1.6L+0.5Lr)

X-Edge = $d/2 = 4.5 / 2 = 2.3 \text{ in}$ $as_x = 20$

Z-Edge = $d/2 = 4.5 / 2 = 2.3 \text{ in}$ $as_z = 20$

$as = as_x + as_z = 20 + 20 = 40$ Col type = Interior $\beta = L / W = 6.0 / 6.0 = 1.00$

ACI 22.6.5.2

Perimeter $bo = as_z / 10 * (L + d/2 + X\text{-Edge}) + as_x / 10 * (W + d/2 + Z\text{-Edge})$

ACI 22.6.4.2

$$bo = 20 / 10 * (6.0 + 4.5 / 2 + 2.3) + 20 / 10 * (6.0 + 4.5 / 2 + 2.3) = 42.0 \text{ in}$$

Area $A_{bo} = (L + d/2 + X\text{-Edge}) * (W + d/2 + Z\text{-Edge}) = (6.0 + 4.5 / 2 + 2.3) * (6.0 + 4.5 / 2 + 2.3) = 110.3 \text{ in}^2$

$\phi V_c = \phi * \text{Min}(2 + 4 / \beta, as * d / bo + 2, 4) * \sqrt{f_c}$

ACI 22.6.5.2

$$\phi V_c = 0.75 * \text{Min}(2 + 4 / 1.00, 40 * 4.5 / 42.0 + 2, 4) * \sqrt{2500} = 150.0 \text{ psi}$$

Punching force $F = P + \text{Overburden} * A_{bo} - \text{Bearing}$

$$F = 27.2 + 0.07 * 110.3 / 144 - 1.8 = 25.5 \text{ kip}$$

$b_1 = L + d/2 + X\text{-Edge} = 6.0 + 4.5 / 2 + 2.3 = 10.5 \text{ in}$ $b_2 = W + d/2 + Z\text{-Edge} = 6.0 + 4.5 / 2 + 2.3 = 10.5 \text{ in}$

$\gamma_{vx} \text{ factor} = 1 - \frac{1}{1 + (2/3) \sqrt{b_2 / b_1}} = 1 - \frac{1}{1 + (2/3) \sqrt{10.5 / 10.5}} = 0.40$

ACI Eq. (8.4.4.2.2)

$\gamma_{vz} \text{ factor} = 1 - \frac{1}{1 + (2/3) \sqrt{b_1 / b_2}} = 1 - \frac{1}{1 + (2/3) \sqrt{10.5 / 10.5}} = 0.40$

ACI Eq. (8.4.2.3.2)

$X_{2z} = b_1 / 2 = 10.5 / 2 = 5.3 \text{ in}$ $X_{2x} = b_2 / 2 = 10.5 / 2 = 5.3 \text{ in}$

$J_{cz} = b_1 * d^3 / 6 + b_1^3 * d / 6 + b_1^2 * b_2 * d / 2$

ACI R8.4.4.2.3

$$J_{cz} = 10.5 * 4.5^3 / 6 + 10.5^3 * 4.5 / 6 + 10.5^2 * 10.5 * 4.5 / 2 = 3632 \text{ in}^4$$

$J_{cx} = b_2 * d^3 / 6 + b_2^3 * d / 6 + b_2^2 * b_1 * d / 2$

ACI R8.4.4.2.3

$$J_{cx} = 10.5 * 4.5^3 / 6 + 10.5^3 * 4.5 / 6 + 10.5^2 * 10.5 * 4.5 / 2 = 3632 \text{ in}^4$$

Stress due to P = $F / (bo * d) * 1000 = 25.5 / (42.0 * 4.5) * 1000 = 134.9 \text{ psi}$

Stress due to Mx = $\gamma_{vx} * X\text{-OTM} * X_{2x} / J_{cx} = 0.40 * 0.0 * 12 * 5.3 / 3632 * 1000 = 0.0 \text{ psi}$

Stress due to Mz = $\gamma_{vz} * Z\text{-OTM} * X_{2z} / J_{cz} = 0.40 * 0.0 * 12 * 5.3 / 3632 * 1000 = 0.0 \text{ psi}$

Punching stress = $P\text{-stress} + Mx\text{-stress} + Mz\text{-stress} = 134.9 + 0.0 + 0.0 = 134.9 \text{ psi} < 150.0 \text{ psi OK}$

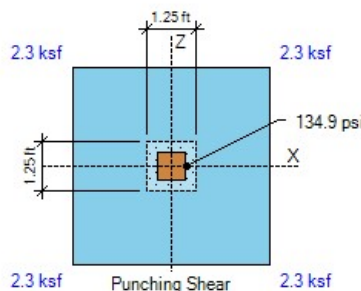

DESIGN CODES

Concrete Design ACI 318-14
Load Combinations ASCE 7-10/16

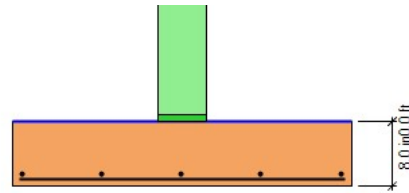

ELEVATION

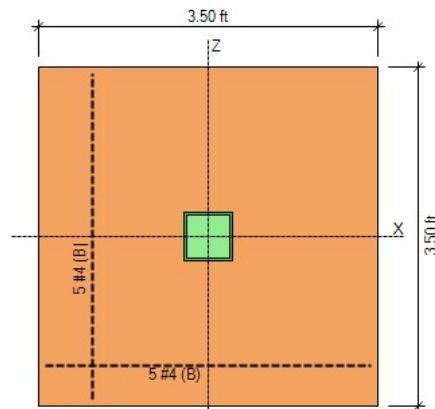

PLAN

GEOMETRY			SOIL PRESSURES (D+L)		
Footing Length (X-dir)	3.00	ft	Gross Allow. Soil Pressure	2.0	ksf
Footing Width (Z-dir)	3.00	ft	Soil Pressure at Corner 1	1.5	ksf
Footing Thickness	8.0	in OK	Soil Pressure at Corner 2	1.5	ksf
Soil Cover	0.00	ft	Soil Pressure at Corner 3	1.5	ksf
Column Length (X-dir)	6.0	in	Soil Pressure at Corner 4	1.5	ksf
Column Width (Z-dir)	6.0	in	Bearing Pressure Ratio	0.76	OK
Offset (X-dir)	0.00	in OK	Ftg. Area in Contact with Soil	100.0	%
Offset (Z-dir)	0.00	in OK	X-eccentricity / Ftg. Length	0.00	OK
Base Plate (L x W)	6.0 x 6.0	in	Z-eccentricity / Ftg. Width	0.00	OK

APPLIED LOADS

	Dead	Live	RLive	Snow	Wind	Seismic	
Axial Force P	8.0	5.2	0.0	0.0	0.0	0.0	kip
Moment about X Mx ..	0.0	0.0	0.0	0.0	0.0	0.0	k-ft
Moment about Z Mz ..	0.0	0.0	0.0	0.0	0.0	0.0	k-ft
Shear Force Vx	0.0	0.0	0.0	0.0	0.0	0.0	kip
Shear Force Vz	0.0	0.0	0.0	0.0	0.0	0.0	kip

OVERTURNING CALCULATIONS (Comb: 0.6D+0.6W)

- Overturning about X-X

- Moment Mx = 0.6 * 0.0 + 0.6 * 0.0 = 0.0 k-ft

- Shear Force Vz = 0.6 * 0.0 + 0.6 * 0.0 = 0.0 kip

Arm = 0.00 + 8.0 / 12 = 0.67 ft

Moment = 0.0 * 0.67 = 0.0 k-ft

- Passive Force = 0.0 kip

Arm = 0.27 ft

Moment = 0.0 k-ft

- Overturning moment X-X = 0.0 + 0.0 = 0.0 k-ft

- Resisting about X-X

- Footing weight = 0.6 * W * L * Thick * Density = 0.6 * 3.00 * 3.00 * 8.0 / 12 * 0.15 = 0.5 kip

Arm = W / 2 = 3.00 / 2 = 1.50 ft

Moment = 0.5 * 1.50 = 0.8 k-ft

- Pedestal weight = 0.6 * W * L * H * Density = 0.6 * 6.0 / 12 * 6.0 / 12 * 0.0 * 0.15 = 0.0 kip

Arm = W / 2 - Offset = 3.00 / 2 - 0.0 / 12 = 1.50 ft

Moment = 0.0 * 1.50 = 0.0 k-ft

- Soil cover = 0.6 * W * L * SC * Density = 0.6 * (3.00 * 3.00 - 6.0 / 12 * 6.0 / 12) * 0.0 * 110 = 0.0 kip

Arm = W / 2 = 3.00 / 2 = 1.50 ft

Moment = 0.0 * 1.50 = 0.0 k-ft

- Buoyancy = 0.6 * W * L * γ * (SC + Thick - WT) = 0.6 * 3.00 * 3.00 * 62 * (0.67) = -0.2 kip

Arm = W / 2 = 3.00 / 2 = 1.50 ft

Moment = 0.2 * 1.50 = -0.3 k-ft

- Axial force P = 0.6 * 8.0 + 0.6 * 0.0 = 4.8 kip

Arm = W / 2 - Offset = 3.00 / 2 - 0.0 / 12 = 1.50 ft

Moment = 4.8 * 1.50 = 7.2 k-ft

- Resisting moment X-X = 0.8 + 0.0 + 0.0 + 7.2 + -0.3 = 7.7 k-ft

- Overturning safety factor X-X = $\frac{\text{Resisting moment}}{\text{Overturning moment}} = \frac{7.7}{0.0} = 76.73 > 1.50$ OK

- **Overturning about Z-Z**

- Moment $M_z = 0.6 * 0.0 + 0.6 * 0.0 = 0.0$ k-ft

- Shear Force $V_x = 0.6 * 0.0 + 0.6 * 0.0 = 0.0$ kip

Arm = $0.00 + 8.0 / 12 = 0.67$ ft

Moment = $0.0 * 0.67 = 0.0$ k-ft

- Passive Force = 0.0 kip

Arm = 0.27 ft

Moment = 0.0 k-ft

- Overturning moment Z-Z = $0.0 + 0.0 = 0.0$ k-ft

- **Resisting about Z-Z**

- Footing weight = $0.6 * W * L * Thick * Density = 0.6 * 3.00 * 3.00 * 8.0 / 12 * 0.15 = 0.5$ kip

Arm = $L / 2 = 3.00 / 2 = 1.50$ ft

Moment = $0.5 * 1.50 = 0.8$ k-ft

- Pedestal weight = $0.6 * W * L * H * Density = 0.6 * 6.0 / 12 * 6.0 / 12 * 0.0 * 0.15 = 0.0$ kip

Arm = $L / 2 - Offset = 3.00 / 2 - 0.0 / 12 = 1.50$ ft

Moment = $0.0 * 1.50 = 0.0$ k-ft

- Soil cover = $0.6 * W * L * SC * Density = 0.6 * (3.00 * 3.00 - 6.0 / 12 * 6.0 / 12) * 0.0 * 110 = 0.0$ kip

Arm = $L / 2 = 3.00 / 2 = 1.50$ ft

Moment = $0.0 * 1.50 = 0.0$ k-ft

- Buoyancy = $0.6 * W * L * \gamma * (SC + Thick - WT) = 0.6 * 3.00 * 3.00 * 62 * (0.67) = -0.2$ kip

Arm = $L / 2 = 3.00 / 2 = 1.50$ ft

Moment = $0.2 * 1.50 = -0.3$ k-ft

- Axial force $P = 0.6 * 8.0 + 0.6 * 0.0 = 4.8$ kip

Arm = $L / 2 - Offset = 3.00 / 2 - 0.0 / 12 = 1.50$ ft

Moment = $4.8 * 1.50 = 7.2$ k-ft

- Resisting moment Z-Z = $0.8 + 0.0 + 0.0 + 7.2 + -0.3 = 7.7$ k-ft

- Overturning safety factor Z-Z = $\frac{Resisting\ moment}{Overturning\ moment} = \frac{7.7}{0.0} = 76.73 > 1.50$ OK

SOIL BEARING PRESSURES (Comb: D+L)

Overturning moment X-X = $0.0 + 0.0 = 0.0$ k-ft

Resisting moment X-X = $1.4 + 0.0 + 0.0 + -0.6 + 19.8 = 20.6$ k-ft

Overturning moment Z-Z = $0.0 + 0.0 = 0.0$ k-ft

Resisting moment Z-Z = $1.4 + 0.0 + 0.0 + -0.6 + 19.8 = 20.6$ k-ft

Resisting force = $Footing + Pedestal + Soil - Buoyancy + P = 0.9 + 0.0 + 0.0 - 0.4 + 13.2 = 13.7$ kip

X-coordinate of resultant from maximum bearing corner:

$$X_p = \frac{Z-Resisting\ moment - Z-Overturning\ moment}{Resisting\ force} = \frac{20.6 - 0.0}{13.7} = 1.50\text{ ft}$$

Z-coordinate of resultant from maximum bearing corner:

$$Z_p = \frac{X-Resisting\ moment - X-Overturning\ moment}{Resisting\ force} = \frac{20.6 - 0.0}{13.7} = 1.50\text{ ft}$$

X-ecc = $Length / 2 - X_p = 3.00 / 2 - 1.50 = 0.00$ ft

Z-ecc = $Width / 2 - Z_p = 3.00 / 2 - 1.50 = 0.00$ ft

Area = $Width * Length = 3.00 * 3.00 = 9.0$ ft²

S_x = $Length * Width^2 / 6 = 3.00 * 3.00^2 / 6 = 4.5$ ft³

S_z = $Width * Length^2 / 6 = 3.00 * 3.00^2 / 6 = 4.5$ ft³

- Footing is in full bearing. Soil pressures are as follows:

P₁ = $P * (1/A + Z-ecc / S_x + X-ecc / S_z) = 13.7 * (1 / 9.0 + 0.00 / 4.5 + 0.00 / 4.5) = 1.53$ ksf

P₂ = $P * (1/A - Z-ecc / S_x + X-ecc / S_z) = 13.7 * (1 / 9.0 - 0.00 / 4.5 + 0.00 / 4.5) = 1.53$ ksf

P₃ = $P * (1/A - Z-ecc / S_x - X-ecc / S_z) = 13.7 * (1 / 9.0 - 0.00 / 4.5 - 0.00 / 4.5) = 1.53$ ksf

P₄ = $P * (1/A + Z-ecc / S_x - X-ecc / S_z) = 13.7 * (1 / 9.0 + 0.00 / 4.5 - 0.00 / 4.5) = 1.53$ ksf

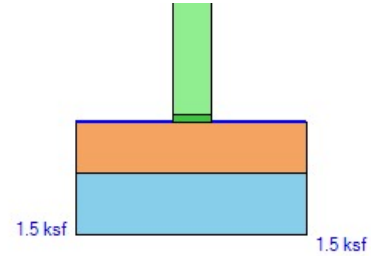
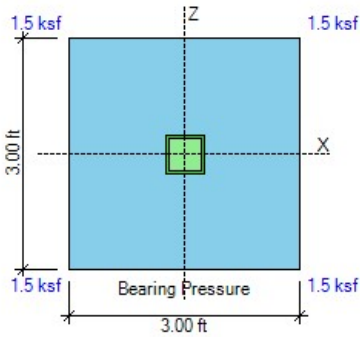

SLIDING CALCULATIONS (Comb: 0.6D+0.6W)

Internal friction angle = 28.0 deg

Passive coefficient $k_p = 4.33$ (per Coulomb)

Pressure at mid-depth = $k_p * Density * (Cover + Thick / 2) = 4.33 * 110 * (0.00 + 8.0 / 12 / 2) = 0.16$ ksf

X-Passive force = $Pressure * Thick * Width = 0.16 * 8.0 / 12 * 3.00 = 0.3$ kip

Z-Passive force = $Pressure * Thick * Length = 0.16 * 8.0 / 12 * 3.00 = 0.3$ kip

Friction force = $Resisting\ force * Friction\ coeff. = \text{Max}(0, 5.1 * 0.35) = 1.8$ kip

Use 100% of Passive + 100% of Friction for sliding resistance

$$\text{- Sliding safety factor X-X} = \frac{X\text{-Passive force} + Friction}{X\text{-Horizontal load}} = \frac{1.00 * 0.3 + 1.00 * 1.8}{0.0} = 21.08 > 1.50 \text{ OK}$$

$$\text{- Sliding safety factor Z-Z} = \frac{Z\text{-Passive force} + Friction}{Z\text{-Horizontal load}} = \frac{1.00 * 0.3 + 1.00 * 1.8}{0.0} = 21.08 > 1.50 \text{ OK}$$

UPLIFT CALCULATIONS (Comb: 0.6D+0.6W)

$$\text{- Uplift safety factor} = \frac{Pedestal + Footing + Cover - Buoyancy}{Uplift\ load} = \frac{0.0 + 0.5 + 0.0 - 0.2}{0.0} = 99.99 > 1.00 \text{ OK}$$

ONE-WAY SHEAR CALCULATIONS (Comb: 1.2D+1.6L+0.5Lr)

Concrete $f_c = 2.5$ ksi

Steel $f_y = 40.0$ ksi

Soil density = 110 pcf

Use Plain Concrete Shear Strength

$$\phi V_{cx} = \frac{4}{3} * \phi * \sqrt{f_c} * Width * t / 1000 = \frac{4}{3} * 0.60 * \sqrt{2500} * 3.0 * 12 * 8.0 / 1000 = 11.5 \text{ kip}$$

ACI 14.5.5.1

$$\phi V_{cz} = \frac{4}{3} * \phi * \sqrt{f_c} * Length * t / 1000 = \frac{4}{3} * 0.60 * \sqrt{2500} * 3.0 * 12 * 8.0 / 1000 = 11.5 \text{ kip}$$

- Shear forces calculated as the volume of the bearing pressures under the effective areas:

$$\text{One-way shear } V_{ux} \text{ (- Side)} = 3.5 \text{ kip} < 11.5 \text{ kip OK}$$

$$\text{One-way shear } V_{ux} \text{ (+ Side)} = 3.5 \text{ kip} < 11.5 \text{ kip OK}$$

$$\text{One-way shear } V_{uz} \text{ (- Side)} = 3.5 \text{ kip} < 11.5 \text{ kip OK}$$

$$\text{One-way shear } V_{uz} \text{ (+ Side)} = 3.5 \text{ kip} < 11.5 \text{ kip OK}$$

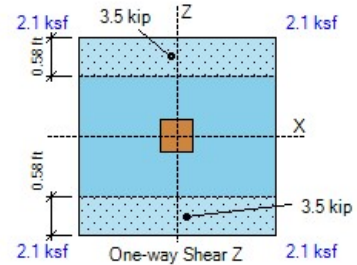
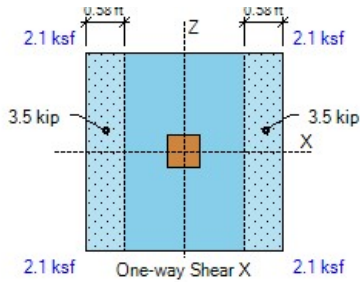

FLEXURE CALCULATIONS (Comb: 1.2D+1.6L+0.5Lr)

Plain $\phi M_{nx} = 5 * \phi * \sqrt{f_c} * L * Thick^2 / 6 = 5 * 0.60 * \sqrt{(2500)} * 3.00 * 8.0^2 / 6 / 1000 = 1.3$ k-ft

ACI Eq. (14.5.2.1a)

Plain $\phi M_{nz} = 5 * \phi * \sqrt{f_c} * W * Thick^2 / 6 = 5 * 0.60 * \sqrt{(2500)} * 3.00 * 8.0^2 / 6 / 1000 = 1.3$ k-ft

- Top Bars

No Top Reinforcement Provided at the Footing

Use Plain Concrete Flexural Strength at Top

- Top moments calculated as the overburden minus the bearing pressures times the lever arm:

Top moment -M_{ux} (- Side) = 0.0 k-ft < 4.8 k-ft OK

Top moment -M_{ux} (+ Side) = 0.0 k-ft < 4.8 k-ft OK

Top moment -M_{uz} (- Side) = 0.0 k-ft < 4.8 k-ft OK

Top moment -M_{uz} (+ Side) = 0.0 k-ft < 4.8 k-ft OK

- Bottom Bars

No Bottom Reinforcement Provided at the Footing

Use Plain Concrete Flexural Strength at Bottom

- Bottom moments calculated as the bearing pressure minus the overburden pressures times the lever arm:

Bottom moment M_{ux} (- Side) = 4.7 k-ft < 4.8 k-ft OK ratio = 0.97

Bottom moment M_{ux} (+ Side) = 4.7 k-ft < 4.8 k-ft OK ratio = 0.98

Bottom moment M_{uz} (- Side) = 4.7 k-ft < 4.8 k-ft OK ratio = 0.97

Bottom moment M_{uz} (+ Side) = 4.7 k-ft < 4.8 k-ft OK ratio = 0.98

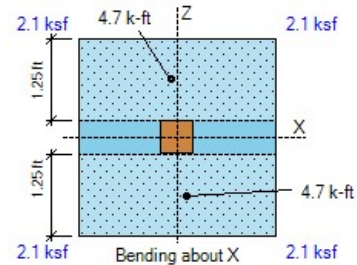
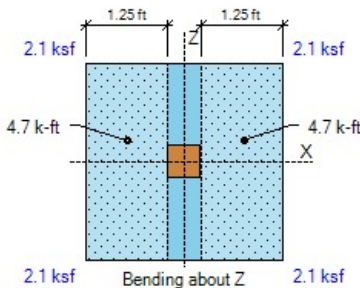

Project:
Engineer:
Descrip: Grid 3F Footing

Page # ____
1/11/2024

ASDIP Foundation 4.8.2.1

SPREAD FOOTING DESIGN

www.asdipsoft.com

LOAD TRANSFER CALCULATIONS (Comb: 1.2D+1.6L+0.5Lr)

$$\text{Area } A1 = \text{col } L * \text{col } W = 6.0 * 6.0 = 36.0 \text{ in}^2$$

$$Sx = \text{col } W * \text{col } L^2 / 6 = 6.0 * 6.0^2 / 6 = 36.0 \text{ in}^3$$

$$Sz = \text{col } L * \text{col } W^2 / 6 = 6.0 * 6.0^2 / 6 = 36.0 \text{ in}^3$$

$$\text{Bearing } Pbu = P / A1 + Mz / Sx + Mx / Sz = 17.9 / 36.0 + 0.0 * 12 / 36.0 + 0.0 * 12 / 36.0 = 0.5 \text{ ksi}$$

$$\text{Min edge} = \text{Min} (L / 2 - X\text{-offset} - \text{col } L / 2, W / 2 - Z\text{-offset} - \text{col } W / 2)$$

$$\text{Min edge} = \text{Min} (3.00 * 12 / 2 - 0.0 - 6.0 / 2, 3.00 * 12 / 2 - 0.0 - 6.0 / 2) = 15.0 \text{ in}$$

$$\text{Area } A2 = \text{Min} [L * W, (\text{col } L + 2 * \text{Min edge}) * (\text{col } W + 2 * \text{Min edge})]$$

ACI R22.8.3.2

$$A2 = \text{Min} [3.00 * 12 * 3.0 * 12, (6.0 + 2 * 15.0) * (6.0 + 2 * 15.0)] = 1296.0 \text{ in}^2$$

$$\text{Footing } \phi Pnc = \phi * 0.85 * fc * \text{Min} [2, \sqrt{(A2 / A1)}] = 0.65 * 0.85 * 2.5 * \text{Min} [2, \sqrt{(1296.0 / 36.0)}] = 2.8 \text{ ksi}$$

$$\text{Footing } \phi Pns = \phi * As * Fy / A1 = 0.0 \text{ ksi}$$

ACI 22.8.3.2

$$\text{Footing bearing } \phi Pn = \phi Pnc + \phi Pns = 2.8 + 0.0 = 2.8 \text{ ksi} > 0.5 \text{ psi OK}$$

Hooked $L_{dh} = \text{Max}(8 db, 6, 0.02 * f_y / (f_c)^{1/2} * \text{Confining} * \text{Location} * \text{Concrete} * db * \text{ratio})$

ACI 25.4.3

$$L_{dh} = \text{Max}(8 db, 6, 0.02 * 60.0 * 1000 / (2500)^{1/2} * 1.0 * 0.7 * 0.0 * 0.75 * 0.09) = 6.0 \text{ in}$$

Ld provided = Dowel length = $3.00 * 12 = 36.0 \text{ in} > 15.5 \text{ in OK}$

Ldh provided = Footing thickness - Cover = $8.00 - 3.0 = 5.0 \text{ in} < 6.0 \text{ in NG}$

PUNCHING SHEAR CALCULATIONS (Comb: 1.2D+1.6L+0.5Lr)

X-Edge = $\text{Length} / 2 - \text{Offset} - \text{Col} / 2 = 3.00 * 12 / 2 - 0.0 - 6.0 / 2 = 15.0 \text{ in}$ $asx = 10$

Z-Edge = $\text{Width} / 2 - \text{Offset} - \text{Col} / 2 = 3.00 * 12 / 2 - 0.0 - 6.0 / 2 = 15.0 \text{ in}$ $asz = 10$

$as = asx + asz = 10 + 10 = 20$ Col type = Corner $\beta = L / W = 6.0 / 6.0 = 1.00$

ACI 22.6.5.2

Perimeter $bo = asz / 10 * (L + d / 2 + X\text{-Edge}) + asx / 10 * (W + d / 2 + Z\text{-Edge})$

ACI 22.6.4.2

$$bo = 10 / 10 * (6.0 + 8.0 / 2 + 15.0) + 10 / 10 * (6.0 + 8.0 / 2 + 15.0) = 50.0 \text{ in}$$

Area $A_{bo} = (L + d / 2 + X\text{-Edge}) * (W + d / 2 + Z\text{-Edge}) = (6.0 + 8.0 / 2 + 15.0) * (6.0 + 8.0 / 2 + 15.0) = 625.0 \text{ in}^2$

Use Plain Concrete Shear Strength

$$\phi V_c = \phi * \text{Min}(1 + 2 / \beta, 2) * 4/3 * \sqrt{f_c}$$

ACI 14.5.5.1

$$\phi V_c = 0.60 * \text{Min}(1 + 2 / 1.00, 2) * 4/3 * \sqrt{2500} = 80.0 \text{ psi}$$

Punching force $F = P + \text{Overburden} * A_{bo} - \text{Bearing}$

$$F = 17.9 + 0.07 * 625.0 / 144 - 2.8 = 15.4 \text{ kip}$$

$b_1 = L + d / 2 + X\text{-Edge} = 6.0 + 8.0 / 2 + 15.0 = 25.0 \text{ in}$ $b_2 = W + d / 2 + Z\text{-Edge} = 6.0 + 8.0 / 2 + 15.0 = 25.0 \text{ in}$

$$\gamma_{vx} \text{ factor} = 1 - \frac{1}{1 + (2/3) \sqrt{b_2 / b_1}} = 1 - \frac{1}{1 + (2/3) \sqrt{25.0 / 25.0}} = 0.40$$

ACI Eq. (8.4.4.2.2)

$$\gamma_{vz} \text{ factor} = 1 - \frac{1}{1 + (2/3) \sqrt{b_1 / b_2}} = 1 - \frac{1}{1 + (2/3) \sqrt{25.0 / 25.0}} = 0.40$$

ACI Eq. (8.4.2.3.2)

$X_{2z} = b_1^2 / 2 / (b_1 + b_2) = 25.0^2 / 2 / (25.0 + 25.0) = 6.3 \text{ in}$ $X_{2x} = b_2^2 / 2 / (b_2 + b_1) = 6.3 \text{ in}$

$$J_{cz} = b_1 * d^3 / 12 + b_1^3 * d / 12 + b_1 * d * (b_1 / 2 - X_{2z})^2 + b_2 * d * X_{2z}^2$$

ACI R8.4.4.2.3

$$J_{cz} = 25.0 * 8.0^3 / 12 + 25.0^3 * 8.0 / 12 + 25.0 * 8.0 * (25.0 / 2 - 6.3)^2 + 25.0 * 8.0 * 6.3^2 = 27108 \text{ in}^4$$

$$J_{cx} = b_2 * d^3 / 12 + b_2^3 * d / 12 + b_2 * d * (b_2 / 2 - X_{2x})^2 + b_1 * d * X_{2x}^2$$

ACI R8.4.4.2.3

$$J_{cx} = 25.0 * 8.0^3 / 12 + 25.0^3 * 8.0 / 12 + 25.0 * 8.0 * (25.0 / 2 - 6.3)^2 + 25.0 * 8.0 * 6.3^2 = 27108 \text{ in}^4$$

Stress due to P = $F / (bo * d) * 1000 = 15.4 / (50.0 * 8.0) * 1000 = 38.5 \text{ psi}$

Stress due to Mx = $\gamma_{vx} * X\text{-OTM} * X_{2x} / J_{cx} = 0.40 * 0.0 * 12 * 6.3 / 27108 * 1000 = 0.0 \text{ psi}$

Stress due to Mz = $\gamma_{vz} * Z\text{-OTM} * X_{2z} / J_{cz} = 0.40 * 0.0 * 12 * 6.3 / 27108 * 1000 = 0.0 \text{ psi}$

Punching stress = $P\text{-stress} + Mx\text{-stress} + Mz\text{-stress} = 38.5 + 0.0 + 0.0 = 38.5 \text{ psi} < 80.0 \text{ psi OK}$

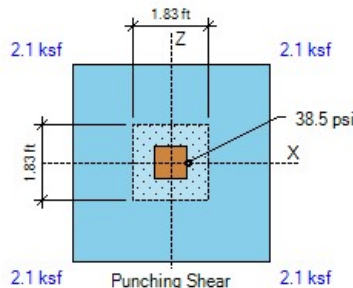

DESIGN CODES

Concrete Design ACI 318-14
Load Combinations ASCE 7-10/16

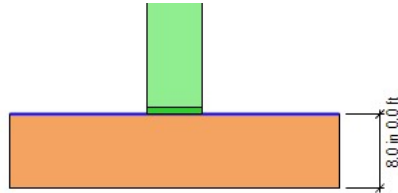

ELEVATION

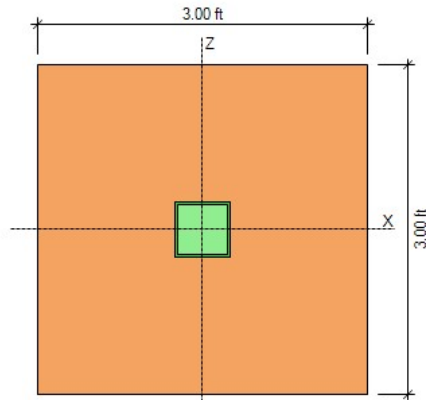

PLAN

Project:
 Engineer:
 Descrip: Grid 5G Footing

Page # ____
 1/11/2024

ASDIP Foundation 4.8.2.1

SPREAD FOOTING DESIGN

www.asdipsoft.com

GEOMETRY			SOIL PRESSURES (D+L)		
Footing Length (X-dir)	3.50	ft	Gross Allow. Soil Pressure	2.0	ksf
Footing Width (Z-dir)	3.50	ft	Soil Pressure at Corner 1	1.8	ksf
Footing Thickness	8.0	in OK	Soil Pressure at Corner 2	1.8	ksf
Soil Cover	0.00	ft	Soil Pressure at Corner 3	1.8	ksf
Column Length (X-dir)	6.0	in	Soil Pressure at Corner 4	1.8	ksf
Column Width (Z-dir)	6.0	in	Bearing Pressure Ratio	0.89	OK
Offset (X-dir)	0.00	in OK	Ftg. Area in Contact with Soil	100.0	%
Offset (Z-dir)	0.00	in OK	X-eccentricity / Ftg. Length	0.00	OK
Base Plate (L x W)	6.0 x 6.0	in	Z-eccentricity / Ftg. Width	0.00	OK

APPLIED LOADS

	Dead	Live	RLive	Snow	Wind	Seismic	
Axial Force P	5.2	16.0	0.0	0.0	0.0	0.0	kip
Moment about X Mx ..	0.0	0.0	0.0	0.0	0.0	0.0	k-ft
Moment about Z Mz ..	0.0	0.0	0.0	0.0	0.0	0.0	k-ft
Shear Force Vx	0.0	0.0	0.0	0.0	0.0	0.0	kip
Shear Force Vz	0.0	0.0	0.0	0.0	0.0	0.0	kip

OVERTURNING CALCULATIONS (Comb: 0.6D+0.6W)

- Overturning about X-X

- Moment Mx = 0.6 * 0.0 + 0.6 * 0.0 = 0.0 k-ft

- Shear Force Vz = 0.6 * 0.0 + 0.6 * 0.0 = 0.0 kip

Arm = 0.00 + 8.0 / 12 = 0.67 ft

Moment = 0.0 * 0.67 = 0.0 k-ft

- Passive Force = 0.0 kip

Arm = 0.27 ft

Moment = 0.0 k-ft

- Overturning moment X-X = 0.0 + 0.0 = 0.0 k-ft

- Resisting about X-X

- Footing weight = 0.6 * W * L * Thick * Density = 0.6 * 3.50 * 3.50 * 8.0 / 12 * 0.15 = 0.7 kip

Arm = W / 2 = 3.50 / 2 = 1.75 ft

Moment = 0.7 * 1.75 = 1.3 k-ft

- Pedestal weight = 0.6 * W * L * H * Density = 0.6 * 6.0 / 12 * 6.0 / 12 * 0.0 * 0.15 = 0.0 kip

Arm = W / 2 - Offset = 3.50 / 2 - 0.0 / 12 = 1.75 ft

Moment = 0.0 * 1.75 = 0.0 k-ft

- Soil cover = 0.6 * W * L * SC * Density = 0.6 * (3.50 * 3.50 - 6.0 / 12 * 6.0 / 12) * 0.0 * 110 = 0.0 kip

Arm = W / 2 = 3.50 / 2 = 1.75 ft

Moment = 0.0 * 1.75 = 0.0 k-ft

- Buoyancy = 0.6 * W * L * γ * (SC + Thick - WT) = 0.6 * 3.50 * 3.50 * 62 * (0.67) = -0.3 kip

Arm = W / 2 = 3.50 / 2 = 1.75 ft

Moment = 0.3 * 1.75 = -0.5 k-ft

- Axial force P = 0.6 * 5.2 + 0.6 * 0.0 = 3.1 kip

Arm = W / 2 - Offset = 3.50 / 2 - 0.0 / 12 = 1.75 ft

Moment = 3.1 * 1.75 = 5.5 k-ft

- Resisting moment X-X = 1.3 + 0.0 + 0.0 + 5.5 + -0.5 = 6.2 k-ft

- Overturning safety factor X-X = $\frac{\text{Resisting moment}}{\text{Overturning moment}} = \frac{6.2}{0.0} = 62.11 > 1.50$ OK

- Overturning about Z-Z

- Moment $M_z = 0.6 * 0.0 + 0.6 * 0.0 = 0.0$ k-ft

- Shear Force $V_x = 0.6 * 0.0 + 0.6 * 0.0 = 0.0$ kip

Arm = $0.00 + 8.0 / 12 = 0.67$ ft

Moment = $0.0 * 0.67 = 0.0$ k-ft

- Passive Force = 0.0 kip

Arm = 0.27 ft

Moment = 0.0 k-ft

- Overturning moment Z-Z = $0.0 + 0.0 = 0.0$ k-ft

- Resisting about Z-Z

- Footing weight = $0.6 * W * L * Thick * Density = 0.6 * 3.50 * 3.50 * 8.0 / 12 * 0.15 = 0.7$ kip

Arm = $L / 2 = 3.50 / 2 = 1.75$ ft

Moment = $0.7 * 1.75 = 1.3$ k-ft

- Pedestal weight = $0.6 * W * L * H * Density = 0.6 * 6.0 / 12 * 6.0 / 12 * 0.0 * 0.15 = 0.0$ kip

Arm = $L / 2 - Offset = 3.50 / 2 - 0.0 / 12 = 1.75$ ft

Moment = $0.0 * 1.75 = 0.0$ k-ft

- Soil cover = $0.6 * W * L * SC * Density = 0.6 * (3.50 * 3.50 - 6.0 / 12 * 6.0 / 12) * 0.0 * 110 = 0.0$ kip

Arm = $L / 2 = 3.50 / 2 = 1.75$ ft

Moment = $0.0 * 1.75 = 0.0$ k-ft

- Buoyancy = $0.6 * W * L * \gamma * (SC + Thick - WT) = 0.6 * 3.50 * 3.50 * 62 * (0.67) = -0.3$ kip

Arm = $L / 2 = 3.50 / 2 = 1.75$ ft

Moment = $0.3 * 1.75 = -0.5$ k-ft

- Axial force $P = 0.6 * 5.2 + 0.6 * 0.0 = 3.1$ kip

Arm = $L / 2 - Offset = 3.50 / 2 - 0.0 / 12 = 1.75$ ft

Moment = $3.1 * 1.75 = 5.5$ k-ft

- Resisting moment Z-Z = $1.3 + 0.0 + 0.0 + 5.5 + -0.5 = 6.2$ k-ft

- Overturning safety factor Z-Z = $\frac{Resisting\ moment}{Overturning\ moment} = \frac{6.2}{0.0} = 62.11 > 1.50$ OK

SOIL BEARING PRESSURES (Comb: D+L)

Overturning moment X-X = $0.0 + 0.0 = 0.0$ k-ft

Resisting moment X-X = $2.1 + 0.0 + 0.0 + -0.9 + 37.1 = 38.4$ k-ft

Overturning moment Z-Z = $0.0 + 0.0 = 0.0$ k-ft

Resisting moment Z-Z = $2.1 + 0.0 + 0.0 + -0.9 + 37.1 = 38.4$ k-ft

Resisting force = $Footing + Pedestal + Soil - Buoyancy + P = 1.2 + 0.0 + 0.0 - 0.5 + 21.2 = 21.9$ kip

X-coordinate of resultant from maximum bearing corner:

$$X_p = \frac{Z-Resisting\ moment - Z-Overturning\ moment}{Resisting\ force} = \frac{38.4 - 0.0}{21.9} = 1.75\text{ ft}$$

Z-coordinate of resultant from maximum bearing corner:

$$Z_p = \frac{X-Resisting\ moment - X-Overturning\ moment}{Resisting\ force} = \frac{38.4 - 0.0}{21.9} = 1.75\text{ ft}$$

X-ecc = $Length / 2 - X_p = 3.50 / 2 - 1.75 = 0.00$ ft

Z-ecc = $Width / 2 - Z_p = 3.50 / 2 - 1.75 = 0.00$ ft

Area = $Width * Length = 3.50 * 3.50 = 12.3$ ft²

Sx = $Length * Width^2 / 6 = 3.50 * 3.50^2 / 6 = 7.1$ ft³

Sz = $Width * Length^2 / 6 = 3.50 * 3.50^2 / 6 = 7.1$ ft³

- Footing is in full bearing. Soil pressures are as follows:

P1 = $P * (1/A + Z-ecc / S_x + X-ecc / S_z) = 21.9 * (1 / 12.3 + 0.00 / 7.1 + 0.00 / 7.1) = 1.79$ ksf

P2 = $P * (1/A - Z-ecc / S_x + X-ecc / S_z) = 21.9 * (1 / 12.3 - 0.00 / 7.1 + 0.00 / 7.1) = 1.79$ ksf

P3 = $P * (1/A - Z-ecc / S_x - X-ecc / S_z) = 21.9 * (1 / 12.3 - 0.00 / 7.1 - 0.00 / 7.1) = 1.79$ ksf

P4 = $P * (1/A + Z-ecc / S_x - X-ecc / S_z) = 21.9 * (1 / 12.3 + 0.00 / 7.1 - 0.00 / 7.1) = 1.79$ ksf

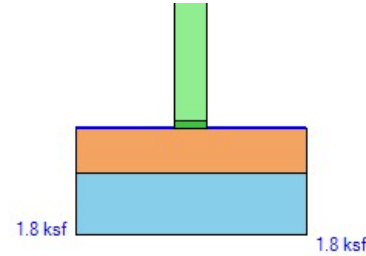
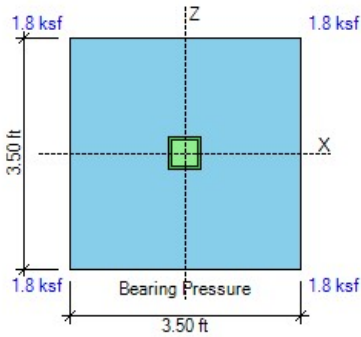

SLIDING CALCULATIONS (Comb: 0.6D+0.6W)

Internal friction angle = 28.0 deg

Passive coefficient $k_p = 4.33$ (per Coulomb)

Pressure at mid-depth = $k_p * Density * (Cover + Thick / 2) = 4.33 * 110 * (0.00 + 8.0 / 12 / 2) = 0.16$ ksf

X-Passive force = $Pressure * Thick * Width = 0.16 * 8.0 / 12 * 3.50 = 0.4$ kip

Z-Passive force = $Pressure * Thick * Length = 0.16 * 8.0 / 12 * 3.50 = 0.4$ kip

Friction force = $Resisting\ force * Friction\ coeff. = \text{Max}(0, 3.5 * 0.35) = 1.2$ kip

Use 100% of Passive + 100% of Friction for sliding resistance

$$\text{- Sliding safety factor X-X} = \frac{X\text{-Passive force} + \text{Friction}}{X\text{-Horizontal load}} = \frac{1.00 * 0.4 + 1.00 * 1.2}{0.0} = 16.12 > 1.50 \text{ OK}$$

$$\text{- Sliding safety factor Z-Z} = \frac{Z\text{-Passive force} + \text{Friction}}{Z\text{-Horizontal load}} = \frac{1.00 * 0.4 + 1.00 * 1.2}{0.0} = 16.12 > 1.50 \text{ OK}$$

UPLIFT CALCULATIONS (Comb: 0.6D+0.6W)

$$\text{- Uplift safety factor} = \frac{\text{Pedestal} + \text{Footing} + \text{Cover} - \text{Buoyancy}}{\text{Uplift load}} = \frac{0.0 + 0.7 + 0.0 - 0.3}{0.0} = 99.99 > 1.00 \text{ OK}$$

ONE-WAY SHEAR CALCULATIONS (Comb: 1.2D+1.6L+0.5Lr)

Concrete $f_c = 2.5$ ksi

Steel $f_y = 40.0$ ksi

Soil density = 110 pcf

d Top X-dir = $Thick - Cover - X\text{-diameter} / 2 = 8.0 - 2.0 - 0.8 / 2 = 5.6$ in

d Top Z-dir = $Thick - Cover - X\text{-diameter} - Z\text{-diameter} / 2 = 8.0 - 2.0 - 0.8 - 0.8 / 2 = 4.9$ in

d Bot X-dir = $Thick - Cover - X\text{-diameter} / 2 = 8.0 - 3.0 - 0.5 / 2 = 4.8$ in

d Bot Z-dir = $Thick - Cover - X\text{-diameter} - Z\text{-diameter} / 2 = 8.0 - 3.0 - 0.5 - 0.5 / 2 = 4.3$ in

$\phi V_{cx} = 2 * \phi * \sqrt{f_c} * Width * d / 1000 = 2 * 0.75 * \sqrt{2500} * 3.5 * 12 * 4.8 / 1000 = 15.0$ kip

ACI Eq. (22.5.5.1)

$\phi V_{cz} = 2 * \phi * \sqrt{f_c} * Length * d / 1000 = 2 * 0.75 * \sqrt{2500} * 3.5 * 12 * 4.3 / 1000 = 13.4$ kip

- Shear forces calculated as the volume of the bearing pressures under the effective areas:

One-way shear V_{ux} (- Side) = 10.2 kip < 15.0 kip OK

One-way shear V_{ux} (+ Side) = 10.2 kip < 15.0 kip OK

One-way shear V_{uz} (- Side) = 10.2 kip < 13.4 kip OK

One-way shear V_{uz} (+ Side) = 10.2 kip < 13.4 kip OK

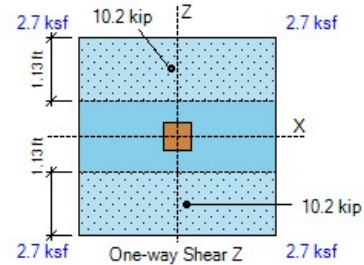
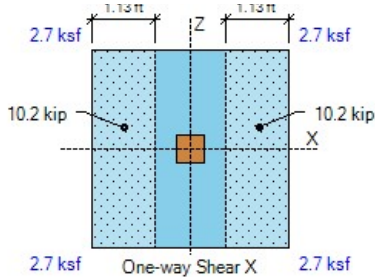

FLEXURE CALCULATIONS (Comb: 1.2D+1.6L+0.5Lr)

Plain $\phi M_{nx} = 5 * \phi * \sqrt{f_c} * L * Thick^2 / 6 = 5 * 0.60 * \sqrt{(2500)} * 3.50 * 8.0^2 / 6 / 1000 = 1.5 \text{ k-ft}$ ACI Eq. (14.5.2.1a)

Plain $\phi M_{nz} = 5 * \phi * \sqrt{f_c} * W * Thick^2 / 6 = 5 * 0.60 * \sqrt{(2500)} * 3.50 * 8.0^2 / 6 / 1000 = 1.5 \text{ k-ft}$

- Top Bars

No Top Reinforcement Provided at the Footing

Use Plain Concrete Flexural Strength at Top

- Top moments calculated as the overburden minus the bearing pressures times the lever arm:

Top moment -M_x (- Side) = 0.0 k-ft < 5.6 k-ft OK

Top moment -M_x (+ Side) = 0.0 k-ft < 5.6 k-ft OK

Top moment -M_z (- Side) = 0.0 k-ft < 5.6 k-ft OK

Top moment -M_z (+ Side) = 0.0 k-ft < 5.6 k-ft OK

- Bottom Bars

Use 5 #4 Z-Bars $\rho = A_s / b d = 1.0 / (3.50 * 12 * 4.3) = 0.0056$

$q = 0.0056 * 40 / 2.5 = 0.090$

Use 5 #4 X-Bars $\rho = A_s / b d = 1.0 / (3.50 * 12 * 4.8) = 0.0050$

$q = 0.0050 * 40 / 2.5 = 0.080$

$\beta = L / W = 3.50 / 3.50 = 1.00$ $\gamma_s = 2 * \beta / (\beta + 1) = 2 * 1.00 / (1.00 + 1) = 1.00$

ACI 13.3.3.3

Bending strength $\phi M_n = \phi * b * d^2 * f_c * q * (1 - 0.59 * q)$

ACI 22.2.2

$\phi M_{nx} = 0.90 * 3.50 * 12 * 4.3^2 * 2.5 * 0.090 * (1 - 0.59 * 0.090) = 12.1 \text{ k-ft}$

$\phi M_{nz} = 0.90 * 3.50 * 12 * 4.8^2 * 2.5 * 0.080 / 1.00 * (1 - 0.59 * 0.080 / 1.00) = 13.6 \text{ k-ft}$

- Bottom moments calculated as the bearing minus the overburden pressures times the lever arm:

Bottom moment M_x (- Side) = 10.3 k-ft < 12.1 k-ft OK ratio = 0.85

Bottom moment M_x (+ Side) = 10.3 k-ft < 12.1 k-ft OK ratio = 0.85

Bottom moment M_z (- Side) = 10.3 k-ft < 13.6 k-ft OK ratio = 0.76

Bottom moment M_z (+ Side) = 10.3 k-ft < 13.6 k-ft OK ratio = 0.76

X-As min = $0.0018 * Width * Thick = 0.0018 * 3.50 * 12 * 8.0 = 0.6 \text{ in}^2$ < 1.0 in² OK

ACI 8.6.1.1

Z-As min = $0.0018 * Length * Thick = 0.0018 * 3.50 * 12 * 8.0 = 0.6 \text{ in}^2$ < 1.0 in² OK

ACI 8.6.1.1

X-As max for 0.005 tension strain = 3.20 in² > 1.00 in² OK

ACI 21.2.2

Z-As max for 0.005 tension strain = 3.20 in² > 1.00 in² OK

ACI 21.2.2

X-Cover factor = $Min(2.5, (Cover + db / 2, Spacing / 2) / db) = Min(2.5, (3.0 + 0.50 / 2, 9.0 / 2) / 0.50) = 2.5$

Straight X-Ld = $Max(12.0, 3 / 40 * f_y / (f_c)^{1/2} * Grade * Size * Casting / Cover * db * ratio)$

ACI Eq. (25.4.2.3a)

X-Ld = $Max(12.0, 3 / 40 * 40.0 * 1000 / (2500)^{1/2} * 1.0 * 0.8 * 1.0 / 2.5 * 0.50 * 0.76) = 12.0 \text{ in}$

Hooked X-Ldh = $Max(8 db, 6, 0.02 * f_y / (f_c)^{1/2} * Confining * Location * Concrete * db * ratio) =$

ACI 25.4.3

X-Ldh = $Max(8 db, 6, 0.02 * 40.0 * 1000 / (2500)^{1/2} * 1.0 * 0.7 * 0.0 * 0.50 * 0.76) = 6.0 \text{ in}$

-X Ld provided = $(Length - Col) / 2 + Offset - Cover = 3.50 * 12 / 2 + 0.0 - 6.0 / 2 - 2.5 = 15.5 \text{ in}$ > 12.0 in OK

+X Ld provided = $(Length - Col) / 2 - Offset - Cover = 3.50 * 12 / 2 - 0.0 - 6.0 / 2 - 2.5 = 15.5 \text{ in}$ > 12.0 in OK

Z-Cover factor = $\text{Min}(2.5, (\text{Cover} + db / 2, \text{Spacing} / 2) / db) = \text{Min}(2.5, (3.0 + 0.50 / 2, 9.0 / 2) / 0.50) = 2.5$

Straight Z-Ld = $\text{Max}(12.0, 3 / 40 * fy / (fc)^{1/2} * \text{Grade} * \text{Size} * \text{Casting} / \text{Cover} * db * \text{ratio})$ ACI Eq. (25.4.2.3a)

Z-Ld = $\text{Max}(12.0, 3 / 40 * 40.0 * 1000 / (2500)^{1/2} * 1.0 * 0.8 * 1.0 / 2.5 * 0.50 * 0.76) = 12.0 \text{ in}$

Hooked Z-Ldh = $\text{Max}(8 db, 6, 0.02 * fy / (fc)^{1/2} * \text{Confining} * \text{Location} * \text{Concrete} * db * \text{ratio}) =$ ACI 25.4.3

Z-Ldh = $\text{Max}(8 db, 6, 0.02 * 40.0 * 1000 / (2500)^{1/2} * 1.0 * 0.7 * 0.0 * 0.50 * 0.85) = 6.0 \text{ in}$

-Z Ld provided = $(\text{Width} - \text{Col}) / 2 + \text{Offset} - \text{Cover} = 3.50 * 12 / 2 + 0.0 - 6.0 / 2 - 2.5 = 15.5 \text{ in} > 12.0 \text{ in OK}$

+Z Ld provided = $(\text{Width} - \text{Col}) / 2 - \text{Offset} - \text{Cover} = 3.50 * 12 / 2 - 0.0 - 6.0 / 2 - 2.5 = 15.5 \text{ in} > 12.0 \text{ in OK}$

X-bar spacing = 9.0 in < $\text{Min}(3 * t, 18.0) = 18.0 \text{ in OK}$ ACI 7.7.2.3

Z-bar spacing = 9.0 in < $\text{Min}(3 * t, 18.0) = 18.0 \text{ in OK}$

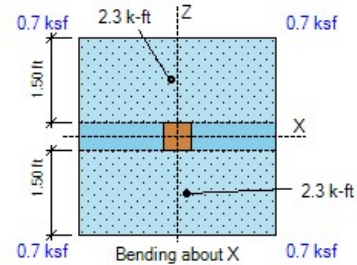
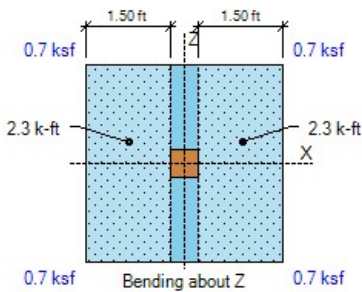

LOAD TRANSFER CALCULATIONS (Comb: 1.2D+1.6L+0.5Lr)

Area $A1 = col L * col W = 6.0 * 6.0 = 36.0 \text{ in}^2$

$Sx = col W * col L^2 / 6 = 6.0 * 6.0^2 / 6 = 36.0 \text{ in}^3$

$Sz = col L * col W^2 / 6 = 6.0 * 6.0^2 / 6 = 36.0 \text{ in}^3$

Bearing $Pbu = P / A1 + Mz / Sx + Mx / Sz = 31.8 / 36.0 + 0.0 * 12 / 36.0 + 0.0 * 12 / 36.0 = 0.9 \text{ ksi}$

Min edge = $\text{Min}(L / 2 - X\text{-offset} - col L / 2, W / 2 - Z\text{-offset} - col W / 2)$

Min edge = $\text{Min}(3.50 * 12 / 2 - 0.0 - 6.0 / 2, 3.50 * 12 / 2 - 0.0 - 6.0 / 2) = 18.0 \text{ in}$

Area $A2 = \text{Min}[L * W, (col L + 2 * \text{Min edge}) * (col W + 2 * \text{Min edge})]$

ACI R22.8.3.2

$A2 = \text{Min}[3.50 * 12 * 3.5 * 12, (6.0 + 2 * 18.0) * (6.0 + 2 * 18.0)] = 1764.0 \text{ in}^2$

Footing $\phi Pnc = \phi * 0.85 * fc * \text{Min}[2, \sqrt{(A2 / A1)}] = 0.65 * 0.85 * 2.5 * \text{Min}[2, \sqrt{(1764.0 / 36.0)}] = 2.8 \text{ ksi}$

Footing $\phi Pns = \phi * As * Fy / A1 = 0.0 \text{ ksi}$

ACI 22.8.3.2

Footing bearing $\phi Pn = \phi Pnc + \phi Pns = 2.8 + 0.0 = 2.8 \text{ ksi} > 0.9 \text{ psi OK}$

Hooked $L_{dh} = \text{Max}(8 db, 6, 0.02 * f_y / (f_c)^{1/2} * \text{Confining} * \text{Location} * \text{Concrete} * db * \text{ratio})$

ACI 25.4.3

$$L_{dh} = \text{Max}(8 db, 6, 0.02 * 60.0 * 1000 / (2500)^{1/2} * 1.0 * 0.7 * 0.0 * 0.75 * 0.15) = 6.0 \text{ in}$$

Ld provided = Dowel length = $3.00 * 12 = 36.0 \text{ in} > 27.5 \text{ in OK}$

Ldh provided = Footing thickness - Cover = $8.00 - 3.0 = 5.0 \text{ in} < 6.0 \text{ in NG}$

PUNCHING SHEAR CALCULATIONS (Comb: 1.2D+1.6L+0.5Lr)

X-Edge = $d/2 = 4.5 / 2 = 2.3 \text{ in}$ $as_x = 20$

Z-Edge = $d/2 = 4.5 / 2 = 2.3 \text{ in}$ $as_z = 20$

$as = as_x + as_z = 20 + 20 = 40$ Col type = Interior $\beta = L / W = 6.0 / 6.0 = 1.00$

ACI 22.6.5.2

Perimeter $bo = as_z / 10 * (L + d/2 + X\text{-Edge}) + as_x / 10 * (W + d/2 + Z\text{-Edge})$

ACI 22.6.4.2

$$bo = 20 / 10 * (6.0 + 4.5 / 2 + 2.3) + 20 / 10 * (6.0 + 4.5 / 2 + 2.3) = 42.0 \text{ in}$$

Area $A_{bo} = (L + d/2 + X\text{-Edge}) * (W + d/2 + Z\text{-Edge}) = (6.0 + 4.5 / 2 + 2.3) * (6.0 + 4.5 / 2 + 2.3) = 110.3 \text{ in}^2$

$\phi V_c = \phi * \text{Min}(2 + 4 / \beta, as * d / bo + 2, 4) * \sqrt{f_c}$

ACI 22.6.5.2

$$\phi V_c = 0.75 * \text{Min}(2 + 4 / 1.00, 40 * 4.5 / 42.0 + 2, 4) * \sqrt{2500} = 150.0 \text{ psi}$$

Punching force $F = P + \text{Overburden} * A_{bo} - \text{Bearing}$

$$F = 31.8 + 0.07 * 110.3 / 144 - 2.0 = 29.9 \text{ kip}$$

$b_1 = L + d/2 + X\text{-Edge} = 6.0 + 4.5 / 2 + 2.3 = 10.5 \text{ in}$ $b_2 = W + d/2 + Z\text{-Edge} = 6.0 + 4.5 / 2 + 2.3 = 10.5 \text{ in}$

$\gamma_{vx} \text{ factor} = 1 - \frac{1}{1 + (2/3) \sqrt{b_2 / b_1}} = 1 - \frac{1}{1 + (2/3) \sqrt{10.5 / 10.5}} = 0.40$

ACI Eq. (8.4.4.2.2)

$\gamma_{vz} \text{ factor} = 1 - \frac{1}{1 + (2/3) \sqrt{b_1 / b_2}} = 1 - \frac{1}{1 + (2/3) \sqrt{10.5 / 10.5}} = 0.40$

ACI Eq. (8.4.2.3.2)

$X_{2z} = b_1 / 2 = 10.5 / 2 = 5.3 \text{ in}$ $X_{2x} = b_2 / 2 = 10.5 / 2 = 5.3 \text{ in}$

$J_{cz} = b_1 * d^3 / 6 + b_1^3 * d / 6 + b_1^2 * b_2 * d / 2$

ACI R8.4.4.2.3

$$J_{cz} = 10.5 * 4.5^3 / 6 + 10.5^3 * 4.5 / 6 + 10.5^2 * 10.5 * 4.5 / 2 = 3632 \text{ in}^4$$

$J_{cx} = b_2 * d^3 / 6 + b_2^3 * d / 6 + b_2^2 * b_1 * d / 2$

ACI R8.4.4.2.3

$$J_{cx} = 10.5 * 4.5^3 / 6 + 10.5^3 * 4.5 / 6 + 10.5^2 * 10.5 * 4.5 / 2 = 3632 \text{ in}^4$$

Stress due to P = $F / (bo * d) * 1000 = 29.9 / (42.0 * 4.5) * 1000 = 157.9 \text{ psi}$

Stress due to Mx = $\gamma_{vx} * X\text{-OTM} * X_{2x} / J_{cx} = 0.40 * 0.0 * 12 * 5.3 / 3632 * 1000 = 0.0 \text{ psi}$

Stress due to Mz = $\gamma_{vz} * Z\text{-OTM} * X_{2z} / J_{cz} = 0.40 * 0.0 * 12 * 5.3 / 3632 * 1000 = 0.0 \text{ psi}$

Punching stress = $P\text{-stress} + Mx\text{-stress} + Mz\text{-stress} = 157.9 + 0.0 + 0.0 = 157.9 \text{ psi} > 150.0 \text{ psi NG}$

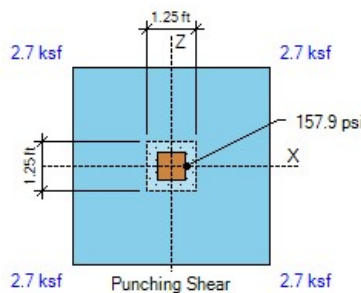

DESIGN CODES

Concrete Design ACI 318-14
Load Combinations ASCE 7-10/16

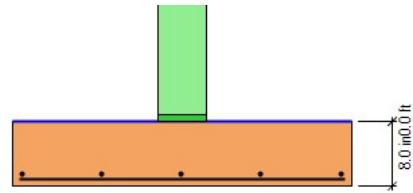

ELEVATION

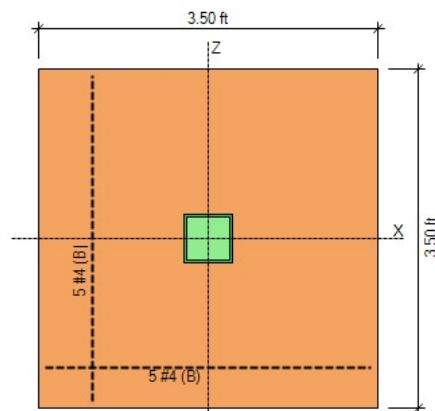

PLAN

GEOMETRY				SOIL PRESSURES (D+L)			
Footing Length (X-dir)	3.00	ft		Gross Allow. Soil Pressure	2.0	ksf	
Footing Width (Z-dir)	3.00	ft		Soil Pressure at Corner 1	1.5	ksf	
Footing Thickness	8.0	in	OK	Soil Pressure at Corner 2	1.5	ksf	
Soil Cover	0.00	ft		Soil Pressure at Corner 3	1.5	ksf	
Column Length (X-dir)	6.0	in		Soil Pressure at Corner 4	1.5	ksf	
Column Width (Z-dir)	6.0	in		Bearing Pressure Ratio	0.76	OK	
Offset (X-dir)	0.00	in	OK	Ftg. Area in Contact with Soil	100.0	%	
Offset (Z-dir)	0.00	in	OK	X-eccentricity / Ftg. Length	0.00	OK	
Base Plate (L x W)	6.0 x 6.0	in		Z-eccentricity / Ftg. Width	0.00	OK	

APPLIED LOADS

	Dead	Live	RLive	Snow	Wind	Seismic	
Axial Force P	8.0	5.2	0.0	0.0	0.0	0.0	kip
Moment about X Mx ..	0.0	0.0	0.0	0.0	0.0	0.0	k-ft
Moment about Z Mz ..	0.0	0.0	0.0	0.0	0.0	0.0	k-ft
Shear Force Vx	0.0	0.0	0.0	0.0	0.0	0.0	kip
Shear Force Vz	0.0	0.0	0.0	0.0	0.0	0.0	kip

OVERTURNING CALCULATIONS (Comb: 0.6D+0.6W)

- Overturning about X-X

- Moment Mx = 0.6 * 0.0 + 0.6 * 0.0 = 0.0 k-ft

- Shear Force Vz = 0.6 * 0.0 + 0.6 * 0.0 = 0.0 kip

Arm = 0.00 + 8.0 / 12 = 0.67 ft

Moment = 0.0 * 0.67 = 0.0 k-ft

- Passive Force = 0.0 kip

Arm = 0.27 ft

Moment = 0.0 k-ft

- Overturning moment X-X = 0.0 + 0.0 = 0.0 k-ft

- Resisting about X-X

- Footing weight = 0.6 * W * L * Thick * Density = 0.6 * 3.00 * 3.00 * 8.0 / 12 * 0.15 = 0.5 kip

Arm = W / 2 = 3.00 / 2 = 1.50 ft

Moment = 0.5 * 1.50 = 0.8 k-ft

- Pedestal weight = 0.6 * W * L * H * Density = 0.6 * 6.0 / 12 * 6.0 / 12 * 0.0 * 0.15 = 0.0 kip

Arm = W / 2 - Offset = 3.00 / 2 - 0.0 / 12 = 1.50 ft

Moment = 0.0 * 1.50 = 0.0 k-ft

- Soil cover = 0.6 * W * L * SC * Density = 0.6 * (3.00 * 3.00 - 6.0 / 12 * 6.0 / 12) * 0.0 * 110 = 0.0 kip

Arm = W / 2 = 3.00 / 2 = 1.50 ft

Moment = 0.0 * 1.50 = 0.0 k-ft

- Buoyancy = 0.6 * W * L * γ * (SC + Thick - WT) = 0.6 * 3.00 * 3.00 * 62 * (0.67) = -0.2 kip

Arm = W / 2 = 3.00 / 2 = 1.50 ft

Moment = 0.2 * 1.50 = -0.3 k-ft

- Axial force P = 0.6 * 8.0 + 0.6 * 0.0 = 4.8 kip

Arm = W / 2 - Offset = 3.00 / 2 - 0.0 / 12 = 1.50 ft

Moment = 4.8 * 1.50 = 7.2 k-ft

- Resisting moment X-X = 0.8 + 0.0 + 0.0 + 7.2 + -0.3 = 7.7 k-ft

- Overturning safety factor X-X = $\frac{\text{Resisting moment}}{\text{Overturning moment}} = \frac{7.7}{0.0} = 76.73 > 1.50$ OK

- Overturning about Z-Z

- Moment $M_z = 0.6 * 0.0 + 0.6 * 0.0 = 0.0$ k-ft

- Shear Force $V_x = 0.6 * 0.0 + 0.6 * 0.0 = 0.0$ kip

Arm = $0.00 + 8.0 / 12 = 0.67$ ft

Moment = $0.0 * 0.67 = 0.0$ k-ft

- Passive Force = 0.0 kip

Arm = 0.27 ft

Moment = 0.0 k-ft

- Overturning moment Z-Z = $0.0 + 0.0 = 0.0$ k-ft

- Resisting about Z-Z

- Footing weight = $0.6 * W * L * Thick * Density = 0.6 * 3.00 * 3.00 * 8.0 / 12 * 0.15 = 0.5$ kip

Arm = $L / 2 = 3.00 / 2 = 1.50$ ft

Moment = $0.5 * 1.50 = 0.8$ k-ft

- Pedestal weight = $0.6 * W * L * H * Density = 0.6 * 6.0 / 12 * 6.0 / 12 * 0.0 * 0.15 = 0.0$ kip

Arm = $L / 2 - Offset = 3.00 / 2 - 0.0 / 12 = 1.50$ ft

Moment = $0.0 * 1.50 = 0.0$ k-ft

- Soil cover = $0.6 * W * L * SC * Density = 0.6 * (3.00 * 3.00 - 6.0 / 12 * 6.0 / 12) * 0.0 * 110 = 0.0$ kip

Arm = $L / 2 = 3.00 / 2 = 1.50$ ft

Moment = $0.0 * 1.50 = 0.0$ k-ft

- Buoyancy = $0.6 * W * L * \gamma * (SC + Thick - WT) = 0.6 * 3.00 * 3.00 * 62 * (0.67) = -0.2$ kip

Arm = $L / 2 = 3.00 / 2 = 1.50$ ft

Moment = $0.2 * 1.50 = -0.3$ k-ft

- Axial force $P = 0.6 * 8.0 + 0.6 * 0.0 = 4.8$ kip

Arm = $L / 2 - Offset = 3.00 / 2 - 0.0 / 12 = 1.50$ ft

Moment = $4.8 * 1.50 = 7.2$ k-ft

- Resisting moment Z-Z = $0.8 + 0.0 + 0.0 + 7.2 + -0.3 = 7.7$ k-ft

- Overturning safety factor Z-Z = $\frac{Resisting\ moment}{Overturning\ moment} = \frac{7.7}{0.0} = 76.73 > 1.50$ OK

SOIL BEARING PRESSURES (Comb: D+L)

Overturning moment X-X = $0.0 + 0.0 = 0.0$ k-ft

Resisting moment X-X = $1.4 + 0.0 + 0.0 + -0.6 + 19.8 = 20.6$ k-ft

Overturning moment Z-Z = $0.0 + 0.0 = 0.0$ k-ft

Resisting moment Z-Z = $1.4 + 0.0 + 0.0 + -0.6 + 19.8 = 20.6$ k-ft

Resisting force = $Footing + Pedestal + Soil - Buoyancy + P = 0.9 + 0.0 + 0.0 - 0.4 + 13.2 = 13.7$ kip

X-coordinate of resultant from maximum bearing corner:

$$X_p = \frac{Z-Resisting\ moment - Z-Overturning\ moment}{Resisting\ force} = \frac{20.6 - 0.0}{13.7} = 1.50\text{ ft}$$

Z-coordinate of resultant from maximum bearing corner:

$$Z_p = \frac{X-Resisting\ moment - X-Overturning\ moment}{Resisting\ force} = \frac{20.6 - 0.0}{13.7} = 1.50\text{ ft}$$

X-ecc = $Length / 2 - X_p = 3.00 / 2 - 1.50 = 0.00$ ft

Z-ecc = $Width / 2 - Z_p = 3.00 / 2 - 1.50 = 0.00$ ft

Area = $Width * Length = 3.00 * 3.00 = 9.0$ ft²

S_x = $Length * Width^2 / 6 = 3.00 * 3.00^2 / 6 = 4.5$ ft³

S_z = $Width * Length^2 / 6 = 3.00 * 3.00^2 / 6 = 4.5$ ft³

- Footing is in full bearing. Soil pressures are as follows:

P₁ = $P * (1/A + Z-ecc / S_x + X-ecc / S_z) = 13.7 * (1 / 9.0 + 0.00 / 4.5 + 0.00 / 4.5) = 1.53$ ksf

P₂ = $P * (1/A - Z-ecc / S_x + X-ecc / S_z) = 13.7 * (1 / 9.0 - 0.00 / 4.5 + 0.00 / 4.5) = 1.53$ ksf

P₃ = $P * (1/A - Z-ecc / S_x - X-ecc / S_z) = 13.7 * (1 / 9.0 - 0.00 / 4.5 - 0.00 / 4.5) = 1.53$ ksf

P₄ = $P * (1/A + Z-ecc / S_x - X-ecc / S_z) = 13.7 * (1 / 9.0 + 0.00 / 4.5 - 0.00 / 4.5) = 1.53$ ksf

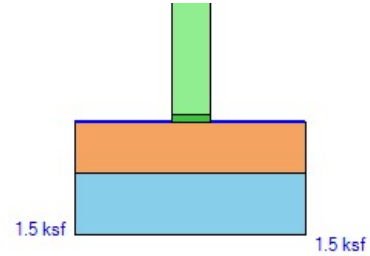
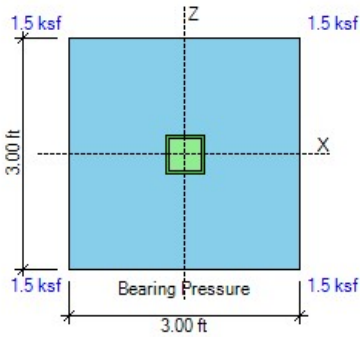

SLIDING CALCULATIONS (Comb: 0.6D+0.6W)

Internal friction angle = 28.0 deg

Passive coefficient $k_p = 4.33$ (per Coulomb)

Pressure at mid-depth = $k_p * Density * (Cover + Thick / 2) = 4.33 * 110 * (0.00 + 8.0 / 12 / 2) = 0.16$ ksf

X-Passive force = $Pressure * Thick * Width = 0.16 * 8.0 / 12 * 3.00 = 0.3$ kip

Z-Passive force = $Pressure * Thick * Length = 0.16 * 8.0 / 12 * 3.00 = 0.3$ kip

Friction force = $Resisting\ force * Friction\ coeff. = \text{Max}(0, 5.1 * 0.35) = 1.8$ kip

Use 100% of Passive + 100% of Friction for sliding resistance

$$\text{- Sliding safety factor X-X} = \frac{X\text{-Passive force} + \text{Friction}}{X\text{-Horizontal load}} = \frac{1.00 * 0.3 + 1.00 * 1.8}{0.0} = 21.08 > 1.50 \text{ OK}$$

$$\text{- Sliding safety factor Z-Z} = \frac{Z\text{-Passive force} + \text{Friction}}{Z\text{-Horizontal load}} = \frac{1.00 * 0.3 + 1.00 * 1.8}{0.0} = 21.08 > 1.50 \text{ OK}$$

UPLIFT CALCULATIONS (Comb: 0.6D+0.6W)

$$\text{- Uplift safety factor} = \frac{\text{Pedestal} + \text{Footing} + \text{Cover} - \text{Buoyancy}}{\text{Uplift load}} = \frac{0.0 + 0.5 + 0.0 - 0.2}{0.0} = 99.99 > 1.00 \text{ OK}$$

ONE-WAY SHEAR CALCULATIONS (Comb: 1.2D+1.6L+0.5Lr)

Concrete $f_c = 2.5$ ksi

Steel $f_y = 40.0$ ksi

Soil density = 110 pcf

Use Plain Concrete Shear Strength

$$\phi V_{cx} = \frac{4}{3} * \phi * \sqrt{f_c} * Width * t / 1000 = \frac{4}{3} * 0.60 * \sqrt{2500} * 3.0 * 12 * 8.0 / 1000 = 11.5 \text{ kip}$$

ACI 14.5.5.1

$$\phi V_{cz} = \frac{4}{3} * \phi * \sqrt{f_c} * Length * t / 1000 = \frac{4}{3} * 0.60 * \sqrt{2500} * 3.0 * 12 * 8.0 / 1000 = 11.5 \text{ kip}$$

- Shear forces calculated as the volume of the bearing pressures under the effective areas:

$$\text{One-way shear } V_{ux} \text{ (- Side)} = 3.5 \text{ kip} < 11.5 \text{ kip OK}$$

$$\text{One-way shear } V_{ux} \text{ (+ Side)} = 3.5 \text{ kip} < 11.5 \text{ kip OK}$$

$$\text{One-way shear } V_{uz} \text{ (- Side)} = 3.5 \text{ kip} < 11.5 \text{ kip OK}$$

$$\text{One-way shear } V_{uz} \text{ (+ Side)} = 3.5 \text{ kip} < 11.5 \text{ kip OK}$$

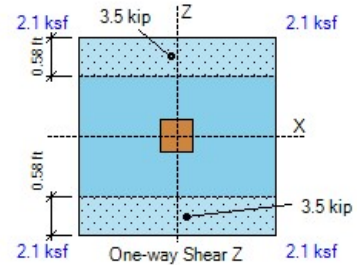
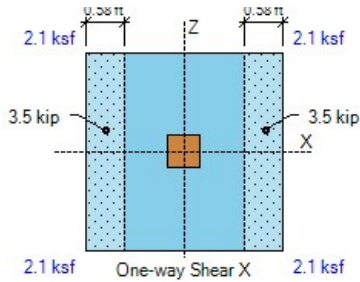

FLEXURE CALCULATIONS (Comb: 1.2D+1.6L+0.5Lr)

Plain $\phi M_{nx} = 5 * \phi * \sqrt{f_c} * L * Thick^2 / 6 = 5 * 0.60 * \sqrt{(2500)} * 3.00 * 8.0^2 / 6 / 1000 = 1.3$ k-ft

ACI Eq. (14.5.2.1a)

Plain $\phi M_{nz} = 5 * \phi * \sqrt{f_c} * W * Thick^2 / 6 = 5 * 0.60 * \sqrt{(2500)} * 3.00 * 8.0^2 / 6 / 1000 = 1.3$ k-ft

- Top Bars

No Top Reinforcement Provided at the Footing

Use Plain Concrete Flexural Strength at Top

- Top moments calculated as the overburden minus the bearing pressures times the lever arm:

Top moment -M_{ux} (- Side) = 0.0 k-ft < 4.8 k-ft OK

Top moment -M_{ux} (+ Side) = 0.0 k-ft < 4.8 k-ft OK

Top moment -M_{uz} (- Side) = 0.0 k-ft < 4.8 k-ft OK

Top moment -M_{uz} (+ Side) = 0.0 k-ft < 4.8 k-ft OK

- Bottom Bars

No Bottom Reinforcement Provided at the Footing

Use Plain Concrete Flexural Strength at Bottom

- Bottom moments calculated as the bearing pressure minus the overburden pressures times the lever arm:

Bottom moment M_{ux} (- Side) = 4.7 k-ft < 4.8 k-ft OK ratio = 0.97

Bottom moment M_{ux} (+ Side) = 4.7 k-ft < 4.8 k-ft OK ratio = 0.98

Bottom moment M_{uz} (- Side) = 4.7 k-ft < 4.8 k-ft OK ratio = 0.97

Bottom moment M_{uz} (+ Side) = 4.7 k-ft < 4.8 k-ft OK ratio = 0.98

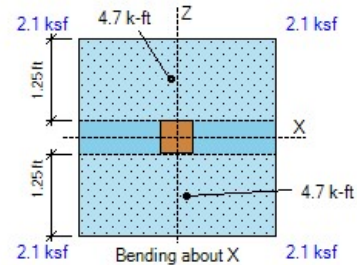
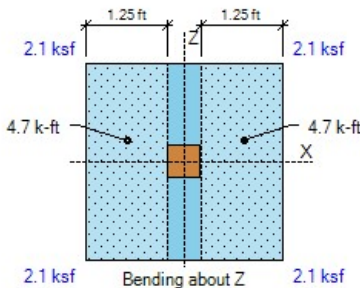

LOAD TRANSFER CALCULATIONS (Comb: 1.2D+1.6L+0.5Lr)

Area $A1 = col L * col W = 6.0 * 6.0 = 36.0 \text{ in}^2$

$Sx = col W * col L^2 / 6 = 6.0 * 6.0^2 / 6 = 36.0 \text{ in}^3$

$Sz = col L * col W^2 / 6 = 6.0 * 6.0^2 / 6 = 36.0 \text{ in}^3$

Bearing $Pbu = P / A1 + Mz / Sx + Mx / Sz = 17.9 / 36.0 + 0.0 * 12 / 36.0 + 0.0 * 12 / 36.0 = 0.5 \text{ ksi}$

Min edge = $Min (L / 2 - X\text{-offset} - col L / 2, W / 2 - Z\text{-offset} - col W / 2)$

Min edge = $Min (3.00 * 12 / 2 - 0.0 - 6.0 / 2, 3.00 * 12 / 2 - 0.0 - 6.0 / 2) = 15.0 \text{ in}$

Area $A2 = Min [L * W, (col L + 2 * Min edge) * (col W + 2 * Min edge)]$

ACI R22.8.3.2

$A2 = Min [3.00 * 12 * 3.0 * 12, (6.0 + 2 * 15.0) * (6.0 + 2 * 15.0)] = 1296.0 \text{ in}^2$

Footing $\phi Pnc = \phi * 0.85 * fc * Min [2, \sqrt{(A2 / A1)}] = 0.65 * 0.85 * 2.5 * Min [2, \sqrt{(1296.0 / 36.0)}] = 2.8 \text{ ksi}$

Footing $\phi Pns = \phi * As * Fy / A1 = 0.0 \text{ ksi}$

ACI 22.8.3.2

Footing bearing $\phi Pn = \phi Pnc + \phi Pns = 2.8 + 0.0 = 2.8 \text{ ksi} > 0.5 \text{ psi OK}$

Hooked $L_{dh} = \text{Max}(8 db, 6, 0.02 * f_y / (f_c)^{1/2} * \text{Confining} * \text{Location} * \text{Concrete} * db * \text{ratio})$

ACI 25.4.3

$$L_{dh} = \text{Max}(8 db, 6, 0.02 * 60.0 * 1000 / (2500)^{1/2} * 1.0 * 0.7 * 0.0 * 0.75 * 0.09) = 6.0 \text{ in}$$

Ld provided = Dowel length = $3.00 * 12 = 36.0 \text{ in} > 15.5 \text{ in OK}$

Ldh provided = Footing thickness - Cover = $8.00 - 3.0 = 5.0 \text{ in} < 6.0 \text{ in NG}$

PUNCHING SHEAR CALCULATIONS (Comb: 1.2D+1.6L+0.5Lr)

X-Edge = $\text{Length} / 2 - \text{Offset} - \text{Col} / 2 = 3.00 * 12 / 2 - 0.0 - 6.0 / 2 = 15.0 \text{ in}$ $asx = 10$

Z-Edge = $\text{Width} / 2 - \text{Offset} - \text{Col} / 2 = 3.00 * 12 / 2 - 0.0 - 6.0 / 2 = 15.0 \text{ in}$ $asz = 10$

$as = asx + asz = 10 + 10 = 20$ Col type = Corner $\beta = L / W = 6.0 / 6.0 = 1.00$

ACI 22.6.5.2

Perimeter $bo = asz / 10 * (L + d / 2 + X\text{-Edge}) + asx / 10 * (W + d / 2 + Z\text{-Edge})$

ACI 22.6.4.2

$$bo = 10 / 10 * (6.0 + 8.0 / 2 + 15.0) + 10 / 10 * (6.0 + 8.0 / 2 + 15.0) = 50.0 \text{ in}$$

Area $A_{bo} = (L + d / 2 + X\text{-Edge}) * (W + d / 2 + Z\text{-Edge}) = (6.0 + 8.0 / 2 + 15.0) * (6.0 + 8.0 / 2 + 15.0) = 625.0 \text{ in}^2$

Use Plain Concrete Shear Strength

$$\phi V_c = \phi * \text{Min}(1 + 2 / \beta, 2) * 4/3 * \sqrt{f_c}$$

ACI 14.5.5.1

$$\phi V_c = 0.60 * \text{Min}(1 + 2 / 1.00, 2) * 4/3 * \sqrt{2500} = 80.0 \text{ psi}$$

Punching force $F = P + \text{Overburden} * A_{bo} - \text{Bearing}$

$$F = 17.9 + 0.07 * 625.0 / 144 - 2.8 = 15.4 \text{ kip}$$

$b_1 = L + d / 2 + X\text{-Edge} = 6.0 + 8.0 / 2 + 15.0 = 25.0 \text{ in}$ $b_2 = W + d / 2 + Z\text{-Edge} = 6.0 + 8.0 / 2 + 15.0 = 25.0 \text{ in}$

$$\gamma_{vx} \text{ factor} = 1 - \frac{1}{1 + (2/3) \sqrt{b_2 / b_1}} = 1 - \frac{1}{1 + (2/3) \sqrt{25.0 / 25.0}} = 0.40$$

ACI Eq. (8.4.4.2.2)

$$\gamma_{vz} \text{ factor} = 1 - \frac{1}{1 + (2/3) \sqrt{b_1 / b_2}} = 1 - \frac{1}{1 + (2/3) \sqrt{25.0 / 25.0}} = 0.40$$

ACI Eq. (8.4.2.3.2)

$X_{2z} = b_1^2 / 2 / (b_1 + b_2) = 25.0^2 / 2 / (25.0 + 25.0) = 6.3 \text{ in}$ $X_{2x} = b_2^2 / 2 / (b_2 + b_1) = 6.3 \text{ in}$

$$J_{cz} = b_1 * d^3 / 12 + b_1^3 * d / 12 + b_1 * d * (b_1 / 2 - X_{2z})^2 + b_2 * d * X_{2z}^2$$

ACI R8.4.4.2.3

$$J_{cz} = 25.0 * 8.0^3 / 12 + 25.0^3 * 8.0 / 12 + 25.0 * 8.0 * (25.0 / 2 - 6.3)^2 + 25.0 * 8.0 * 6.3^2 = 27108 \text{ in}^4$$

$$J_{cx} = b_2 * d^3 / 12 + b_2^3 * d / 12 + b_2 * d * (b_2 / 2 - X_{2x})^2 + b_1 * d * X_{2x}^2$$

ACI R8.4.4.2.3

$$J_{cx} = 25.0 * 8.0^3 / 12 + 25.0^3 * 8.0 / 12 + 25.0 * 8.0 * (25.0 / 2 - 6.3)^2 + 25.0 * 8.0 * 6.3^2 = 27108 \text{ in}^4$$

Stress due to P = $F / (bo * d) * 1000 = 15.4 / (50.0 * 8.0) * 1000 = 38.5 \text{ psi}$

Stress due to Mx = $\gamma_{vx} * X\text{-OTM} * X_{2x} / J_{cx} = 0.40 * 0.0 * 12 * 6.3 / 27108 * 1000 = 0.0 \text{ psi}$

Stress due to Mz = $\gamma_{vz} * Z\text{-OTM} * X_{2z} / J_{cz} = 0.40 * 0.0 * 12 * 6.3 / 27108 * 1000 = 0.0 \text{ psi}$

Punching stress = $P\text{-stress} + Mx\text{-stress} + Mz\text{-stress} = 38.5 + 0.0 + 0.0 = 38.5 \text{ psi} < 80.0 \text{ psi OK}$

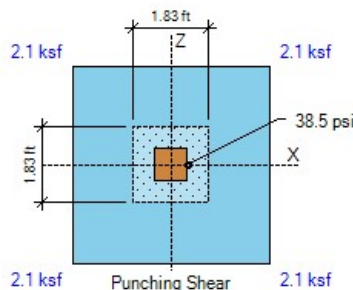

DESIGN CODES

Concrete Design ACI 318-14
Load Combinations ASCE 7-10/16

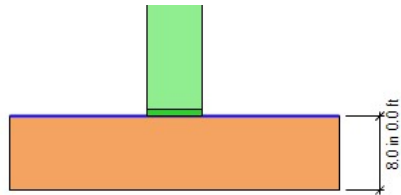

ELEVATION

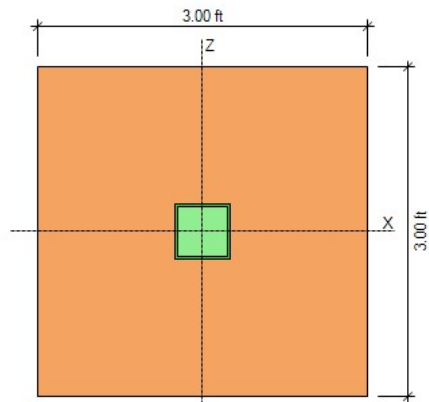

PLAN

GEOMETRY			SOIL PRESSURES (D+L)		
Footing Length (X-dir)	3.50	ft	Gross Allow. Soil Pressure	2.0	ksf
Footing Width (Z-dir)	3.50	ft	Soil Pressure at Corner 1	1.8	ksf
Footing Thickness	8.0	in OK	Soil Pressure at Corner 2	1.8	ksf
Soil Cover	0.00	ft	Soil Pressure at Corner 3	1.8	ksf
Column Length (X-dir)	6.0	in	Soil Pressure at Corner 4	1.8	ksf
Column Width (Z-dir)	6.0	in	Bearing Pressure Ratio	0.89	OK
Offset (X-dir)	0.00	in OK	Ftg. Area in Contact with Soil	100.0	%
Offset (Z-dir)	0.00	in OK	X-eccentricity / Ftg. Length	0.00	OK
Base Plate (L x W)	6.0 x 6.0	in	Z-eccentricity / Ftg. Width	0.00	OK

APPLIED LOADS

	Dead	Live	RLive	Snow	Wind	Seismic	
Axial Force P	5.2	16.0	0.0	0.0	0.0	0.0	kip
Moment about X Mx ..	0.0	0.0	0.0	0.0	0.0	0.0	k-ft
Moment about Z Mz ..	0.0	0.0	0.0	0.0	0.0	0.0	k-ft
Shear Force Vx	0.0	0.0	0.0	0.0	0.0	0.0	kip
Shear Force Vz	0.0	0.0	0.0	0.0	0.0	0.0	kip

OVERTURNING CALCULATIONS (Comb: 0.6D+0.6W)

- Overturning about X-X

- Moment Mx = 0.6 * 0.0 + 0.6 * 0.0 = 0.0 k-ft

- Shear Force Vz = 0.6 * 0.0 + 0.6 * 0.0 = 0.0 kip

Arm = 0.00 + 8.0 / 12 = 0.67 ft

Moment = 0.0 * 0.67 = 0.0 k-ft

- Passive Force = 0.0 kip

Arm = 0.27 ft

Moment = 0.0 k-ft

- Overturning moment X-X = 0.0 + 0.0 = 0.0 k-ft

- Resisting about X-X

- Footing weight = 0.6 * W * L * Thick * Density = 0.6 * 3.50 * 3.50 * 8.0 / 12 * 0.15 = 0.7 kip

Arm = W / 2 = 3.50 / 2 = 1.75 ft

Moment = 0.7 * 1.75 = 1.3 k-ft

- Pedestal weight = 0.6 * W * L * H * Density = 0.6 * 6.0 / 12 * 6.0 / 12 * 0.0 * 0.15 = 0.0 kip

Arm = W / 2 - Offset = 3.50 / 2 - 0.0 / 12 = 1.75 ft

Moment = 0.0 * 1.75 = 0.0 k-ft

- Soil cover = 0.6 * W * L * SC * Density = 0.6 * (3.50 * 3.50 - 6.0 / 12 * 6.0 / 12) * 0.0 * 110 = 0.0 kip

Arm = W / 2 = 3.50 / 2 = 1.75 ft

Moment = 0.0 * 1.75 = 0.0 k-ft

- Buoyancy = 0.6 * W * L * γ * (SC + Thick - WT) = 0.6 * 3.50 * 3.50 * 62 * (0.67) = -0.3 kip

Arm = W / 2 = 3.50 / 2 = 1.75 ft

Moment = 0.3 * 1.75 = -0.5 k-ft

- Axial force P = 0.6 * 5.2 + 0.6 * 0.0 = 3.1 kip

Arm = W / 2 - Offset = 3.50 / 2 - 0.0 / 12 = 1.75 ft

Moment = 3.1 * 1.75 = 5.5 k-ft

- Resisting moment X-X = 1.3 + 0.0 + 0.0 + 5.5 + -0.5 = 6.2 k-ft

- Overturning safety factor X-X = $\frac{\text{Resisting moment}}{\text{Overturning moment}} = \frac{6.2}{0.0} = 62.11 > 1.50$ OK

- Overturning about Z-Z

- Moment $M_z = 0.6 * 0.0 + 0.6 * 0.0 = 0.0$ k-ft

- Shear Force $V_x = 0.6 * 0.0 + 0.6 * 0.0 = 0.0$ kip

Arm = $0.00 + 8.0 / 12 = 0.67$ ft

Moment = $0.0 * 0.67 = 0.0$ k-ft

- Passive Force = 0.0 kip

Arm = 0.27 ft

Moment = 0.0 k-ft

- Overturning moment Z-Z = $0.0 + 0.0 = 0.0$ k-ft

- Resisting about Z-Z

- Footing weight = $0.6 * W * L * Thick * Density = 0.6 * 3.50 * 3.50 * 8.0 / 12 * 0.15 = 0.7$ kip

Arm = $L / 2 = 3.50 / 2 = 1.75$ ft

Moment = $0.7 * 1.75 = 1.3$ k-ft

- Pedestal weight = $0.6 * W * L * H * Density = 0.6 * 6.0 / 12 * 6.0 / 12 * 0.0 * 0.15 = 0.0$ kip

Arm = $L / 2 - Offset = 3.50 / 2 - 0.0 / 12 = 1.75$ ft

Moment = $0.0 * 1.75 = 0.0$ k-ft

- Soil cover = $0.6 * W * L * SC * Density = 0.6 * (3.50 * 3.50 - 6.0 / 12 * 6.0 / 12) * 0.0 * 110 = 0.0$ kip

Arm = $L / 2 = 3.50 / 2 = 1.75$ ft

Moment = $0.0 * 1.75 = 0.0$ k-ft

- Buoyancy = $0.6 * W * L * \gamma * (SC + Thick - WT) = 0.6 * 3.50 * 3.50 * 62 * (0.67) = -0.3$ kip

Arm = $L / 2 = 3.50 / 2 = 1.75$ ft

Moment = $0.3 * 1.75 = -0.5$ k-ft

- Axial force $P = 0.6 * 5.2 + 0.6 * 0.0 = 3.1$ kip

Arm = $L / 2 - Offset = 3.50 / 2 - 0.0 / 12 = 1.75$ ft

Moment = $3.1 * 1.75 = 5.5$ k-ft

- Resisting moment Z-Z = $1.3 + 0.0 + 0.0 + 5.5 + -0.5 = 6.2$ k-ft

- Overturning safety factor Z-Z = $\frac{Resisting\ moment}{Overturning\ moment} = \frac{6.2}{0.0} = 62.11 > 1.50$ OK

SOIL BEARING PRESSURES (Comb: D+L)

Overturning moment X-X = $0.0 + 0.0 = 0.0$ k-ft

Resisting moment X-X = $2.1 + 0.0 + 0.0 + -0.9 + 37.1 = 38.4$ k-ft

Overturning moment Z-Z = $0.0 + 0.0 = 0.0$ k-ft

Resisting moment Z-Z = $2.1 + 0.0 + 0.0 + -0.9 + 37.1 = 38.4$ k-ft

Resisting force = $Footing + Pedestal + Soil - Buoyancy + P = 1.2 + 0.0 + 0.0 - 0.5 + 21.2 = 21.9$ kip

X-coordinate of resultant from maximum bearing corner:

$$X_p = \frac{Z-Resisting\ moment - Z-Overturning\ moment}{Resisting\ force} = \frac{38.4 - 0.0}{21.9} = 1.75\text{ ft}$$

Z-coordinate of resultant from maximum bearing corner:

$$Z_p = \frac{X-Resisting\ moment - X-Overturning\ moment}{Resisting\ force} = \frac{38.4 - 0.0}{21.9} = 1.75\text{ ft}$$

X-ecc = $Length / 2 - X_p = 3.50 / 2 - 1.75 = 0.00$ ft

Z-ecc = $Width / 2 - Z_p = 3.50 / 2 - 1.75 = 0.00$ ft

Area = $Width * Length = 3.50 * 3.50 = 12.3$ ft²

S_x = $Length * Width^2 / 6 = 3.50 * 3.50^2 / 6 = 7.1$ ft³

S_z = $Width * Length^2 / 6 = 3.50 * 3.50^2 / 6 = 7.1$ ft³

- Footing is in full bearing. Soil pressures are as follows:

P₁ = $P * (1/A + Z-ecc / S_x + X-ecc / S_z) = 21.9 * (1 / 12.3 + 0.00 / 7.1 + 0.00 / 7.1) = 1.79$ ksf

P₂ = $P * (1/A - Z-ecc / S_x + X-ecc / S_z) = 21.9 * (1 / 12.3 - 0.00 / 7.1 + 0.00 / 7.1) = 1.79$ ksf

P₃ = $P * (1/A - Z-ecc / S_x - X-ecc / S_z) = 21.9 * (1 / 12.3 - 0.00 / 7.1 - 0.00 / 7.1) = 1.79$ ksf

P₄ = $P * (1/A + Z-ecc / S_x - X-ecc / S_z) = 21.9 * (1 / 12.3 + 0.00 / 7.1 - 0.00 / 7.1) = 1.79$ ksf

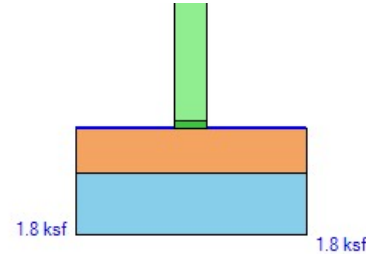
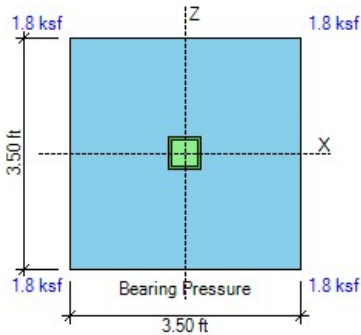

SLIDING CALCULATIONS (Comb: 0.6D+0.6W)

Internal friction angle = 28.0 deg

Passive coefficient $k_p = 4.33$ (per Coulomb)

Pressure at mid-depth = $k_p * Density * (Cover + Thick / 2) = 4.33 * 110 * (0.00 + 8.0 / 12 / 2) = 0.16$ ksf

X-Passive force = $Pressure * Thick * Width = 0.16 * 8.0 / 12 * 3.50 = 0.4$ kip

Z-Passive force = $Pressure * Thick * Length = 0.16 * 8.0 / 12 * 3.50 = 0.4$ kip

Friction force = $Resisting\ force * Friction\ coeff. = \text{Max}(0, 3.5 * 0.35) = 1.2$ kip

Use 100% of Passive + 100% of Friction for sliding resistance

$$\text{- Sliding safety factor X-X} = \frac{X\text{-Passive force} + \text{Friction}}{X\text{-Horizontal load}} = \frac{1.00 * 0.4 + 1.00 * 1.2}{0.0} = 16.12 > 1.50 \text{ OK}$$

$$\text{- Sliding safety factor Z-Z} = \frac{Z\text{-Passive force} + \text{Friction}}{Z\text{-Horizontal load}} = \frac{1.00 * 0.4 + 1.00 * 1.2}{0.0} = 16.12 > 1.50 \text{ OK}$$

UPLIFT CALCULATIONS (Comb: 0.6D+0.6W)

$$\text{- Uplift safety factor} = \frac{\text{Pedestal} + \text{Footing} + \text{Cover} - \text{Buoyancy}}{\text{Uplift load}} = \frac{0.0 + 0.7 + 0.0 - 0.3}{0.0} = 99.99 > 1.00 \text{ OK}$$

ONE-WAY SHEAR CALCULATIONS (Comb: 1.2D+1.6L+0.5Lr)

Concrete $f_c = 2.5$ ksi

Steel $f_y = 40.0$ ksi

Soil density = 110 pcf

d Top X-dir = $Thick - Cover - X\text{-diameter} / 2 = 8.0 - 2.0 - 0.8 / 2 = 5.6$ in

d Top Z-dir = $Thick - Cover - X\text{-diameter} - Z\text{-diameter} / 2 = 8.0 - 2.0 - 0.8 - 0.8 / 2 = 4.9$ in

d Bot X-dir = $Thick - Cover - X\text{-diameter} / 2 = 8.0 - 3.0 - 0.5 / 2 = 4.8$ in

d Bot Z-dir = $Thick - Cover - X\text{-diameter} - Z\text{-diameter} / 2 = 8.0 - 3.0 - 0.5 - 0.5 / 2 = 4.3$ in

$\phi V_{cx} = 2 * \phi * \sqrt{f_c} * Width * d / 1000 = 2 * 0.75 * \sqrt{2500} * 3.5 * 12 * 4.8 / 1000 = 15.0$ kip

ACI Eq. (22.5.5.1)

$\phi V_{cz} = 2 * \phi * \sqrt{f_c} * Length * d / 1000 = 2 * 0.75 * \sqrt{2500} * 3.5 * 12 * 4.3 / 1000 = 13.4$ kip

- Shear forces calculated as the volume of the bearing pressures under the effective areas:

One-way shear V_{ux} (- Side) = 10.2 kip < 15.0 kip OK

One-way shear V_{ux} (+ Side) = 10.2 kip < 15.0 kip OK

One-way shear V_{uz} (- Side) = 10.2 kip < 13.4 kip OK

One-way shear V_{uz} (+ Side) = 10.2 kip < 13.4 kip OK

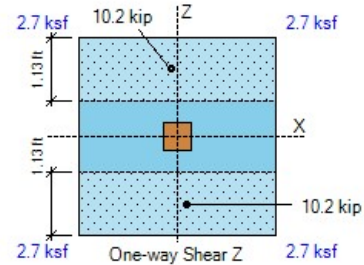
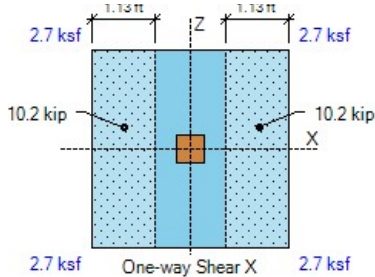

FLEXURE CALCULATIONS (Comb: 1.2D+1.6L+0.5Lr)

Plain $\phi M_{nx} = 5 * \phi * \sqrt{f_c} * L * Thick^2 / 6 = 5 * 0.60 * \sqrt{(2500)} * 3.50 * 8.0^2 / 6 / 1000 = 1.5 \text{ k-ft}$

ACI Eq. (14.5.2.1a)

Plain $\phi M_{nz} = 5 * \phi * \sqrt{f_c} * W * Thick^2 / 6 = 5 * 0.60 * \sqrt{(2500)} * 3.50 * 8.0^2 / 6 / 1000 = 1.5 \text{ k-ft}$

- Top Bars

No Top Reinforcement Provided at the Footing

Use Plain Concrete Flexural Strength at Top

- Top moments calculated as the overburden minus the bearing pressures times the lever arm:

Top moment -M_x (- Side) = 0.0 k-ft < 5.6 k-ft OK

Top moment -M_x (+ Side) = 0.0 k-ft < 5.6 k-ft OK

Top moment -M_z (- Side) = 0.0 k-ft < 5.6 k-ft OK

Top moment -M_z (+ Side) = 0.0 k-ft < 5.6 k-ft OK

- Bottom Bars

Use 5 #4 Z-Bars $\rho = A_s / b d = 1.0 / (3.50 * 12 * 4.3) = 0.0056$

$q = 0.0056 * 40 / 2.5 = 0.090$

Use 5 #4 X-Bars $\rho = A_s / b d = 1.0 / (3.50 * 12 * 4.8) = 0.0050$

$q = 0.0050 * 40 / 2.5 = 0.080$

$\beta = L / W = 3.50 / 3.50 = 1.00$ $\gamma_s = 2 * \beta / (\beta + 1) = 2 * 1.00 / (1.00 + 1) = 1.00$

ACI 13.3.3.3

Bending strength $\phi M_n = \phi * b * d^2 * f_c * q * (1 - 0.59 * q)$

ACI 22.2.2

$\phi M_{nx} = 0.90 * 3.50 * 12 * 4.3^2 * 2.5 * 0.090 * (1 - 0.59 * 0.090) = 12.1 \text{ k-ft}$

$\phi M_{nz} = 0.90 * 3.50 * 12 * 4.8^2 * 2.5 * 0.080 / 1.00 * (1 - 0.59 * 0.080 / 1.00) = 13.6 \text{ k-ft}$

- Bottom moments calculated as the bearing minus the overburden pressures times the lever arm:

Bottom moment M_x (- Side) = 10.3 k-ft < 12.1 k-ft OK ratio = 0.85

Bottom moment M_x (+ Side) = 10.3 k-ft < 12.1 k-ft OK ratio = 0.85

Bottom moment M_z (- Side) = 10.3 k-ft < 13.6 k-ft OK ratio = 0.76

Bottom moment M_z (+ Side) = 10.3 k-ft < 13.6 k-ft OK ratio = 0.76

X-As min = $0.0018 * Width * Thick = 0.0018 * 3.50 * 12 * 8.0 = 0.6 \text{ in}^2$ < 1.0 in² OK

ACI 8.6.1.1

Z-As min = $0.0018 * Length * Thick = 0.0018 * 3.50 * 12 * 8.0 = 0.6 \text{ in}^2$ < 1.0 in² OK

ACI 8.6.1.1

X-As max for 0.005 tension strain = 3.20 in² > 1.00 in² OK

ACI 21.2.2

Z-As max for 0.005 tension strain = 3.20 in² > 1.00 in² OK

ACI 21.2.2

X-Cover factor = $Min(2.5, (Cover + db / 2, Spacing / 2) / db) = Min(2.5, (3.0 + 0.50 / 2, 9.0 / 2) / 0.50) = 2.5$

Straight X-Ld = $Max(12.0, 3 / 40 * f_y / (f_c)^{1/2} * Grade * Size * Casting / Cover * db * ratio)$

ACI Eq. (25.4.2.3a)

X-Ld = $Max(12.0, 3 / 40 * 40.0 * 1000 / (2500)^{1/2} * 1.0 * 0.8 * 1.0 / 2.5 * 0.50 * 0.76) = 12.0 \text{ in}$

Hooked X-Ldh = $Max(8 db, 6, 0.02 * f_y / (f_c)^{1/2} * Confining * Location * Concrete * db * ratio) =$

ACI 25.4.3

X-Ldh = $Max(8 db, 6, 0.02 * 40.0 * 1000 / (2500)^{1/2} * 1.0 * 0.7 * 0.0 * 0.50 * 0.76) = 6.0 \text{ in}$

-X Ld provided = $(Length - Col) / 2 + Offset - Cover = 3.50 * 12 / 2 + 0.0 - 6.0 / 2 - 2.5 = 15.5 \text{ in}$ > 12.0 in OK

+X Ld provided = $(Length - Col) / 2 - Offset - Cover = 3.50 * 12 / 2 - 0.0 - 6.0 / 2 - 2.5 = 15.5 \text{ in}$ > 12.0 in OK

Z-Cover factor = $\text{Min}(2.5, (\text{Cover} + db / 2, \text{Spacing} / 2) / db) = \text{Min}(2.5, (3.0 + 0.50 / 2, 9.0 / 2) / 0.50) = 2.5$

Straight Z-Ld = $\text{Max}(12.0, 3 / 40 * fy / (fc)^{1/2} * \text{Grade} * \text{Size} * \text{Casting} / \text{Cover} * db * \text{ratio})$ ACI Eq. (25.4.2.3a)

Z-Ld = $\text{Max}(12.0, 3 / 40 * 40.0 * 1000 / (2500)^{1/2} * 1.0 * 0.8 * 1.0 / 2.5 * 0.50 * 0.76) = 12.0 \text{ in}$

Hooked Z-Ldh = $\text{Max}(8 db, 6, 0.02 * fy / (fc)^{1/2} * \text{Confining} * \text{Location} * \text{Concrete} * db * \text{ratio}) =$ ACI 25.4.3

Z-Ldh = $\text{Max}(8 db, 6, 0.02 * 40.0 * 1000 / (2500)^{1/2} * 1.0 * 0.7 * 0.0 * 0.50 * 0.85) = 6.0 \text{ in}$

-Z Ld provided = $(\text{Width} - \text{Col}) / 2 + \text{Offset} - \text{Cover} = 3.50 * 12 / 2 + 0.0 - 6.0 / 2 - 2.5 = 15.5 \text{ in} > 12.0 \text{ in OK}$

+Z Ld provided = $(\text{Width} - \text{Col}) / 2 - \text{Offset} - \text{Cover} = 3.50 * 12 / 2 - 0.0 - 6.0 / 2 - 2.5 = 15.5 \text{ in} > 12.0 \text{ in OK}$

X-bar spacing = 9.0 in < $\text{Min}(3 * t, 18.0) = 18.0 \text{ in OK}$ ACI 7.7.2.3

Z-bar spacing = 9.0 in < $\text{Min}(3 * t, 18.0) = 18.0 \text{ in OK}$

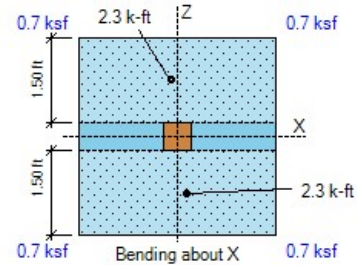
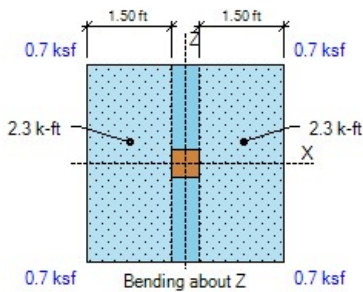

LOAD TRANSFER CALCULATIONS (Comb: 1.2D+1.6L+0.5Lr)

Area $A1 = col L * col W = 6.0 * 6.0 = 36.0 \text{ in}^2$

$Sx = col W * col L^2 / 6 = 6.0 * 6.0^2 / 6 = 36.0 \text{ in}^3$

$Sz = col L * col W^2 / 6 = 6.0 * 6.0^2 / 6 = 36.0 \text{ in}^3$

Bearing $Pbu = P / A1 + Mz / Sx + Mx / Sz = 31.8 / 36.0 + 0.0 * 12 / 36.0 + 0.0 * 12 / 36.0 = 0.9 \text{ ksi}$

Min edge = $\text{Min}(L / 2 - X\text{-offset} - col L / 2, W / 2 - Z\text{-offset} - col W / 2)$

Min edge = $\text{Min}(3.50 * 12 / 2 - 0.0 - 6.0 / 2, 3.50 * 12 / 2 - 0.0 - 6.0 / 2) = 18.0 \text{ in}$

Area $A2 = \text{Min}[L * W, (col L + 2 * \text{Min edge}) * (col W + 2 * \text{Min edge})]$

ACI R22.8.3.2

$A2 = \text{Min}[3.50 * 12 * 3.5 * 12, (6.0 + 2 * 18.0) * (6.0 + 2 * 18.0)] = 1764.0 \text{ in}^2$

Footing $\phi Pnc = \phi * 0.85 * fc * \text{Min}[2, \sqrt{(A2 / A1)}] = 0.65 * 0.85 * 2.5 * \text{Min}[2, \sqrt{(1764.0 / 36.0)}] = 2.8 \text{ ksi}$

Footing $\phi Pns = \phi * As * Fy / A1 = 0.0 \text{ ksi}$

ACI 22.8.3.2

Footing bearing $\phi Pn = \phi Pnc + \phi Pns = 2.8 + 0.0 = 2.8 \text{ ksi} > 0.9 \text{ psi OK}$

Hooked $L_{dh} = \text{Max}(8 db, 6, 0.02 * f_y / (f_c)^{1/2} * \text{Confining} * \text{Location} * \text{Concrete} * db * \text{ratio})$

ACI 25.4.3

$$L_{dh} = \text{Max}(8 db, 6, 0.02 * 60.0 * 1000 / (2500)^{1/2} * 1.0 * 0.7 * 0.0 * 0.75 * 0.15) = 6.0 \text{ in}$$

Ld provided = Dowel length = $3.00 * 12 = 36.0 \text{ in} > 27.5 \text{ in OK}$

Ldh provided = Footing thickness - Cover = $8.00 - 3.0 = 5.0 \text{ in} < 6.0 \text{ in NG}$

PUNCHING SHEAR CALCULATIONS (Comb: 1.2D+1.6L+0.5Lr)

X-Edge = $d/2 = 4.5 / 2 = 2.3 \text{ in}$ $as_x = 20$

Z-Edge = $d/2 = 4.5 / 2 = 2.3 \text{ in}$ $as_z = 20$

$as = as_x + as_z = 20 + 20 = 40$ Col type = Interior $\beta = L / W = 6.0 / 6.0 = 1.00$

ACI 22.6.5.2

Perimeter $bo = as_z / 10 * (L + d/2 + X\text{-Edge}) + as_x / 10 * (W + d/2 + Z\text{-Edge})$

ACI 22.6.4.2

$$bo = 20 / 10 * (6.0 + 4.5 / 2 + 2.3) + 20 / 10 * (6.0 + 4.5 / 2 + 2.3) = 42.0 \text{ in}$$

Area $A_{bo} = (L + d/2 + X\text{-Edge}) * (W + d/2 + Z\text{-Edge}) = (6.0 + 4.5 / 2 + 2.3) * (6.0 + 4.5 / 2 + 2.3) = 110.3 \text{ in}^2$

$\phi V_c = \phi * \text{Min}(2 + 4 / \beta, as * d / bo + 2, 4) * \sqrt{f_c}$

ACI 22.6.5.2

$$\phi V_c = 0.75 * \text{Min}(2 + 4 / 1.00, 40 * 4.5 / 42.0 + 2, 4) * \sqrt{2500} = 150.0 \text{ psi}$$

Punching force $F = P + \text{Overburden} * A_{bo} - \text{Bearing}$

$$F = 31.8 + 0.07 * 110.3 / 144 - 2.0 = 29.9 \text{ kip}$$

$b_1 = L + d/2 + X\text{-Edge} = 6.0 + 4.5 / 2 + 2.3 = 10.5 \text{ in}$ $b_2 = W + d/2 + Z\text{-Edge} = 6.0 + 4.5 / 2 + 2.3 = 10.5 \text{ in}$

$\gamma_{vx} \text{ factor} = 1 - \frac{1}{1 + (2/3) \sqrt{b_2 / b_1}} = 1 - \frac{1}{1 + (2/3) \sqrt{10.5 / 10.5}} = 0.40$

ACI Eq. (8.4.4.2.2)

$\gamma_{vz} \text{ factor} = 1 - \frac{1}{1 + (2/3) \sqrt{b_1 / b_2}} = 1 - \frac{1}{1 + (2/3) \sqrt{10.5 / 10.5}} = 0.40$

ACI Eq. (8.4.2.3.2)

$X_{2z} = b_1 / 2 = 10.5 / 2 = 5.3 \text{ in}$ $X_{2x} = b_2 / 2 = 10.5 / 2 = 5.3 \text{ in}$

$J_{cz} = b_1 * d^3 / 6 + b_1^3 * d / 6 + b_1^2 * b_2 * d / 2$

ACI R8.4.4.2.3

$$J_{cz} = 10.5 * 4.5^3 / 6 + 10.5^3 * 4.5 / 6 + 10.5^2 * 10.5 * 4.5 / 2 = 3632 \text{ in}^4$$

$J_{cx} = b_2 * d^3 / 6 + b_2^3 * d / 6 + b_2^2 * b_1 * d / 2$

ACI R8.4.4.2.3

$$J_{cx} = 10.5 * 4.5^3 / 6 + 10.5^3 * 4.5 / 6 + 10.5^2 * 10.5 * 4.5 / 2 = 3632 \text{ in}^4$$

Stress due to P = $F / (bo * d) * 1000 = 29.9 / (42.0 * 4.5) * 1000 = 157.9 \text{ psi}$

Stress due to Mx = $\gamma_{vx} * X\text{-OTM} * X_{2x} / J_{cx} = 0.40 * 0.0 * 12 * 5.3 / 3632 * 1000 = 0.0 \text{ psi}$

Stress due to Mz = $\gamma_{vz} * Z\text{-OTM} * X_{2z} / J_{cz} = 0.40 * 0.0 * 12 * 5.3 / 3632 * 1000 = 0.0 \text{ psi}$

Punching stress = $P\text{-stress} + Mx\text{-stress} + Mz\text{-stress} = 157.9 + 0.0 + 0.0 = 157.9 \text{ psi} > 150.0 \text{ psi NG}$

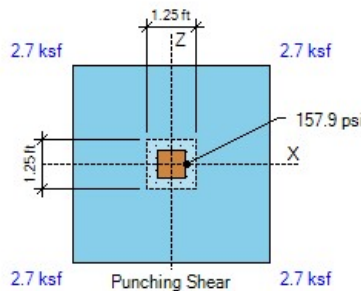

DESIGN CODES

Concrete Design ACI 318-14
Load Combinations ASCE 7-10/16

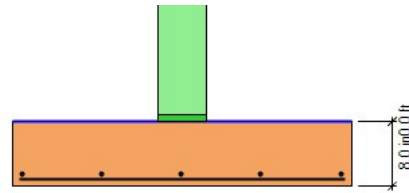

ELEVATION

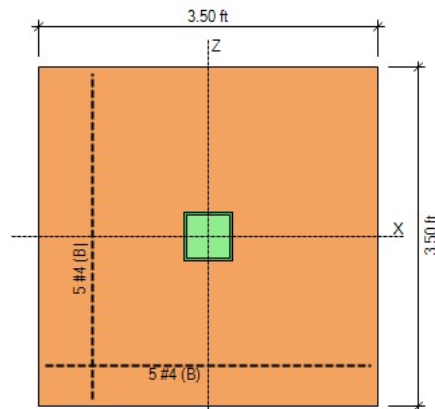

PLAN

GEOMETRY			SOIL PRESSURES (D+L)		
Footing Length (X-dir)	3.50	ft	Gross Allow. Soil Pressure	2.0	ksf
Footing Width (Z-dir)	3.50	ft	Soil Pressure at Corner 1	1.5	ksf
Footing Thickness	8.0	in OK	Soil Pressure at Corner 2	1.5	ksf
Soil Cover	0.00	ft	Soil Pressure at Corner 3	1.5	ksf
Column Length (X-dir)	6.0	in	Soil Pressure at Corner 4	1.5	ksf
Column Width (Z-dir)	6.0	in	Bearing Pressure Ratio	0.77	OK
Offset (X-dir)	0.00	in OK	Ftg. Area in Contact with Soil	100.0	%
Offset (Z-dir)	0.00	in OK	X-eccentricity / Ftg. Length	0.00	OK
Base Plate (L x W)	6.0 x 6.0	in	Z-eccentricity / Ftg. Width	0.00	OK

APPLIED LOADS

	Dead	Live	RLive	Snow	Wind	Seismic	
Axial Force P	4.4	13.7	0.0	0.0	0.0	0.0	kip
Moment about X Mx ..	0.0	0.0	0.0	0.0	0.0	0.0	k-ft
Moment about Z Mz ..	0.0	0.0	0.0	0.0	0.0	0.0	k-ft
Shear Force Vx	0.0	0.0	0.0	0.0	0.0	0.0	kip
Shear Force Vz	0.0	0.0	0.0	0.0	0.0	0.0	kip

OVERTURNING CALCULATIONS (Comb: 0.6D+0.6W)

- Overturning about X-X

- Moment Mx = 0.6 * 0.0 + 0.6 * 0.0 = 0.0 k-ft

- Shear Force Vz = 0.6 * 0.0 + 0.6 * 0.0 = 0.0 kip

Arm = 0.00 + 8.0 / 12 = 0.67 ft

Moment = 0.0 * 0.67 = 0.0 k-ft

- Passive Force = 0.0 kip

Arm = 0.27 ft

Moment = 0.0 k-ft

- Overturning moment X-X = 0.0 + 0.0 = 0.0 k-ft

- Resisting about X-X

- Footing weight = $0.6 * W * L * Thick * Density = 0.6 * 3.50 * 3.50 * 8.0 / 12 * 0.15 = 0.7$ kip

Arm = $W / 2 = 3.50 / 2 = 1.75$ ft

Moment = $0.7 * 1.75 = 1.3$ k-ft

- Pedestal weight = $0.6 * W * L * H * Density = 0.6 * 6.0 / 12 * 6.0 / 12 * 0.0 * 0.15 = 0.0$ kip

Arm = $W / 2 - Offset = 3.50 / 2 - 0.0 / 12 = 1.75$ ft

Moment = $0.0 * 1.75 = 0.0$ k-ft

- Soil cover = $0.6 * W * L * SC * Density = 0.6 * (3.50 * 3.50 - 6.0 / 12 * 6.0 / 12) * 0.0 * 110 = 0.0$ kip

Arm = $W / 2 = 3.50 / 2 = 1.75$ ft

Moment = $0.0 * 1.75 = 0.0$ k-ft

- Buoyancy = $0.6 * W * L * \gamma * (SC + Thick - WT) = 0.6 * 3.50 * 3.50 * 62 * (0.67) = -0.3$ kip

Arm = $W / 2 = 3.50 / 2 = 1.75$ ft

Moment = $0.3 * 1.75 = -0.5$ k-ft

- Axial force P = $0.6 * 4.4 + 0.6 * 0.0 = 2.6$ kip

Arm = $W / 2 - Offset = 3.50 / 2 - 0.0 / 12 = 1.75$ ft

Moment = $2.6 * 1.75 = 4.6$ k-ft

- Resisting moment X-X = $1.3 + 0.0 + 0.0 + 4.6 + -0.5 = 5.4$ k-ft

- Overturning safety factor X-X = $\frac{Resisting\ moment}{Overturning\ moment} = \frac{5.4}{0.0} = 53.71 > 1.50$ OK

- Overturning about Z-Z

- Moment $M_z = 0.6 * 0.0 + 0.6 * 0.0 = 0.0$ k-ft
- Shear Force $V_x = 0.6 * 0.0 + 0.6 * 0.0 = 0.0$ kip
 Arm = $0.00 + 8.0 / 12 = 0.67$ ft Moment = $0.0 * 0.67 = 0.0$ k-ft
- Passive Force = 0.0 kip Arm = 0.27 ft Moment = 0.0 k-ft
- Overturning moment Z-Z = $0.0 + 0.0 = 0.0$ k-ft

- Resisting about Z-Z

- Footing weight = $0.6 * W * L * Thick * Density = 0.6 * 3.50 * 3.50 * 8.0 / 12 * 0.15 = 0.7$ kip
 Arm = $L / 2 = 3.50 / 2 = 1.75$ ft Moment = $0.7 * 1.75 = 1.3$ k-ft
- Pedestal weight = $0.6 * W * L * H * Density = 0.6 * 6.0 / 12 * 6.0 / 12 * 0.0 * 0.15 = 0.0$ kip
 Arm = $L / 2 - Offset = 3.50 / 2 - 0.0 / 12 = 1.75$ ft Moment = $0.0 * 1.75 = 0.0$ k-ft
- Soil cover = $0.6 * W * L * SC * Density = 0.6 * (3.50 * 3.50 - 6.0 / 12 * 6.0 / 12) * 0.0 * 110 = 0.0$ kip
 Arm = $L / 2 = 3.50 / 2 = 1.75$ ft Moment = $0.0 * 1.75 = 0.0$ k-ft
- Buoyancy = $0.6 * W * L * \gamma * (SC + Thick - WT) = 0.6 * 3.50 * 3.50 * 62 * (0.67) = -0.3$ kip
 Arm = $L / 2 = 3.50 / 2 = 1.75$ ft Moment = $0.3 * 1.75 = -0.5$ k-ft
- Axial force $P = 0.6 * 4.4 + 0.6 * 0.0 = 2.6$ kip
 Arm = $L / 2 - Offset = 3.50 / 2 - 0.0 / 12 = 1.75$ ft Moment = $2.6 * 1.75 = 4.6$ k-ft
- Resisting moment Z-Z = $1.3 + 0.0 + 0.0 + 4.6 + -0.5 = 5.4$ k-ft
- Overturning safety factor Z-Z = $\frac{Resisting\ moment}{Overturning\ moment} = \frac{5.4}{0.0} = 53.71 > 1.50$ OK

SOIL BEARING PRESSURES (Comb: D+L)

- Overturning moment X-X = $0.0 + 0.0 = 0.0$ k-ft
- Resisting moment X-X = $2.1 + 0.0 + 0.0 + -0.9 + 31.7 = 32.9$ k-ft
- Overturning moment Z-Z = $0.0 + 0.0 = 0.0$ k-ft
- Resisting moment Z-Z = $2.1 + 0.0 + 0.0 + -0.9 + 31.7 = 32.9$ k-ft
- Resisting force = $Footing + Pedestal + Soil - Buoyancy + P = 1.2 + 0.0 + 0.0 - 0.5 + 18.1 = 18.8$ kip

X-coordinate of resultant from maximum bearing corner:

$$X_p = \frac{Z-Resisting\ moment - Z-Overturning\ moment}{Resisting\ force} = \frac{32.9 - 0.0}{18.8} = 1.75\text{ ft}$$

Z-coordinate of resultant from maximum bearing corner:

$$Z_p = \frac{X-Resisting\ moment - X-Overturning\ moment}{Resisting\ force} = \frac{32.9 - 0.0}{18.8} = 1.75\text{ ft}$$

X-ecc = $Length / 2 - X_p = 3.50 / 2 - 1.75 = 0.00$ ft

Z-ecc = $Width / 2 - Z_p = 3.50 / 2 - 1.75 = 0.00$ ft

Area = $Width * Length = 3.50 * 3.50 = 12.3$ ft²

S_x = $Length * Width^2 / 6 = 3.50 * 3.50^2 / 6 = 7.1$ ft³

S_z = $Width * Length^2 / 6 = 3.50 * 3.50^2 / 6 = 7.1$ ft³

- Footing is in full bearing. Soil pressures are as follows:

P₁ = $P * (1/A + Z-ecc / S_x + X-ecc / S_z) = 18.8 * (1 / 12.3 + 0.00 / 7.1 + 0.00 / 7.1) = 1.54$ ksf

P₂ = $P * (1/A - Z-ecc / S_x + X-ecc / S_z) = 18.8 * (1 / 12.3 - 0.00 / 7.1 + 0.00 / 7.1) = 1.54$ ksf

P₃ = $P * (1/A - Z-ecc / S_x - X-ecc / S_z) = 18.8 * (1 / 12.3 - 0.00 / 7.1 - 0.00 / 7.1) = 1.54$ ksf

P₄ = $P * (1/A + Z-ecc / S_x - X-ecc / S_z) = 18.8 * (1 / 12.3 + 0.00 / 7.1 - 0.00 / 7.1) = 1.54$ ksf

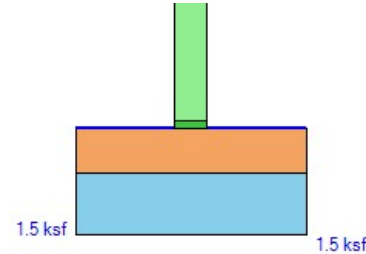
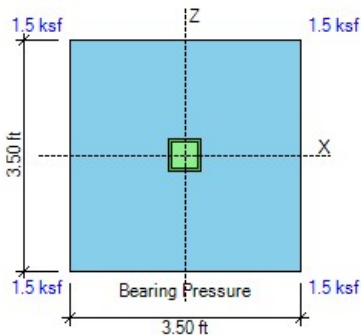

SLIDING CALCULATIONS (Comb: 0.6D+0.6W)

Internal friction angle = 28.0 deg

Passive coefficient $k_p = 4.33$ (per Coulomb)

Pressure at mid-depth = $k_p * Density * (Cover + Thick / 2) = 4.33 * 110 * (0.00 + 8.0 / 12 / 2) = 0.16$ ksf

X-Passive force = $Pressure * Thick * Width = 0.16 * 8.0 / 12 * 3.50 = 0.4$ kip

Z-Passive force = $Pressure * Thick * Length = 0.16 * 8.0 / 12 * 3.50 = 0.4$ kip

Friction force = $Resisting\ force * Friction\ coeff. = \text{Max}(0, 3.1 * 0.35) = 1.1$ kip

Use 100% of Passive + 100% of Friction for sliding resistance

$$\text{- Sliding safety factor X-X} = \frac{X\text{-Passive force} + \text{Friction}}{X\text{-Horizontal load}} = \frac{1.00 * 0.4 + 1.00 * 1.1}{0.0} = 14.44 > 1.50 \text{ OK}$$

$$\text{- Sliding safety factor Z-Z} = \frac{Z\text{-Passive force} + \text{Friction}}{Z\text{-Horizontal load}} = \frac{1.00 * 0.4 + 1.00 * 1.1}{0.0} = 14.44 > 1.50 \text{ OK}$$

UPLIFT CALCULATIONS (Comb: 0.6D+0.6W)

$$\text{- Uplift safety factor} = \frac{\text{Pedestal} + \text{Footing} + \text{Cover} - \text{Buoyancy}}{\text{Uplift load}} = \frac{0.0 + 0.7 + 0.0 - 0.3}{0.0} = 99.99 > 1.00 \text{ OK}$$

ONE-WAY SHEAR CALCULATIONS (Comb: 1.2D+1.6L+0.5Lr)

Concrete $f_c = 2.5$ ksi

Steel $f_y = 40.0$ ksi

Soil density = 110 pcf

d Top X-dir = $Thick - Cover - X\text{-diameter} / 2 = 8.0 - 2.0 - 0.8 / 2 = 5.6$ in

d Top Z-dir = $Thick - Cover - X\text{-diameter} - Z\text{-diameter} / 2 = 8.0 - 2.0 - 0.8 - 0.8 / 2 = 4.9$ in

d Bot X-dir = $Thick - Cover - X\text{-diameter} / 2 = 8.0 - 3.0 - 0.5 / 2 = 4.8$ in

d Bot Z-dir = $Thick - Cover - X\text{-diameter} - Z\text{-diameter} / 2 = 8.0 - 3.0 - 0.5 - 0.5 / 2 = 4.3$ in

$\phi V_{cx} = 2 * \phi * \sqrt{f_c} * Width * d / 1000 = 2 * 0.75 * \sqrt{2500} * 3.5 * 12 * 4.8 / 1000 = 15.0$ kip

ACI Eq. (22.5.5.1)

$\phi V_{cz} = 2 * \phi * \sqrt{f_c} * Length * d / 1000 = 2 * 0.75 * \sqrt{2500} * 3.5 * 12 * 4.3 / 1000 = 13.4$ kip

- Shear forces calculated as the volume of the bearing pressures under the effective areas:

One-way shear V_{ux} (- Side) = 8.8 kip < 15.0 kip OK

One-way shear V_{ux} (+ Side) = 8.7 kip < 15.0 kip OK

One-way shear V_{uz} (- Side) = 8.8 kip < 13.4 kip OK

One-way shear V_{uz} (+ Side) = 8.7 kip < 13.4 kip OK

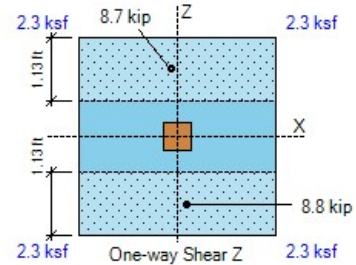
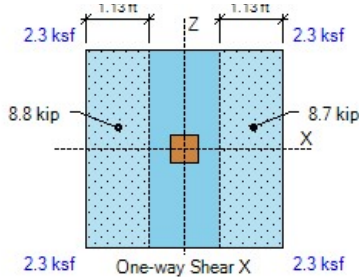

FLEXURE CALCULATIONS (Comb: 1.2D+1.6L+0.5Lr)

Plain $\phi M_{nx} = 5 * \phi * \sqrt{f_c} * L * Thick^2 / 6 = 5 * 0.60 * \sqrt{(2500)} * 3.50 * 8.0^2 / 6 / 1000 = 1.5 \text{ k-ft}$

ACI Eq. (14.5.2.1a)

Plain $\phi M_{nz} = 5 * \phi * \sqrt{f_c} * W * Thick^2 / 6 = 5 * 0.60 * \sqrt{(2500)} * 3.50 * 8.0^2 / 6 / 1000 = 1.5 \text{ k-ft}$

- Top Bars

No Top Reinforcement Provided at the Footing

Use Plain Concrete Flexural Strength at Top

- Top moments calculated as the overburden minus the bearing pressures times the lever arm:

Top moment -M_x (- Side) = 0.0 k-ft < 5.6 k-ft OK

Top moment -M_x (+ Side) = 0.0 k-ft < 5.6 k-ft OK

Top moment -M_z (- Side) = 0.0 k-ft < 5.6 k-ft OK

Top moment -M_z (+ Side) = 0.0 k-ft < 5.6 k-ft OK

- Bottom Bars

Use 5 #4 Z-Bars $\rho = A_s / b d = 1.0 / (3.50 * 12 * 4.3) = 0.0056$

$q = 0.0056 * 40 / 2.5 = 0.090$

Use 5 #4 X-Bars $\rho = A_s / b d = 1.0 / (3.50 * 12 * 4.8) = 0.0050$

$q = 0.0050 * 40 / 2.5 = 0.080$

$\beta = L / W = 3.50 / 3.50 = 1.00$ $\gamma_s = 2 * \beta / (\beta + 1) = 2 * 1.00 / (1.00 + 1) = 1.00$

ACI 13.3.3.3

Bending strength $\phi M_n = \phi * b * d^2 * f_c * q * (1 - 0.59 * q)$

ACI 22.2.2

$\phi M_{nx} = 0.90 * 3.50 * 12 * 4.3^2 * 2.5 * 0.090 * (1 - 0.59 * 0.090) = 12.1 \text{ k-ft}$

$\phi M_{nz} = 0.90 * 3.50 * 12 * 4.8^2 * 2.5 * 0.080 / 1.00 * (1 - 0.59 * 0.080 / 1.00) = 13.6 \text{ k-ft}$

- Bottom moments calculated as the bearing minus the overburden pressures times the lever arm:

Bottom moment M_x (- Side) = 8.8 k-ft < 12.1 k-ft OK ratio = 0.73

Bottom moment M_x (+ Side) = 8.8 k-ft < 12.1 k-ft OK ratio = 0.73

Bottom moment M_z (- Side) = 8.8 k-ft < 13.6 k-ft OK ratio = 0.65

Bottom moment M_z (+ Side) = 8.8 k-ft < 13.6 k-ft OK ratio = 0.65

X-As min = $0.0018 * Width * Thick = 0.0018 * 3.50 * 12 * 8.0 = 0.6 \text{ in}^2$ < 1.0 in² OK

ACI 8.6.1.1

Z-As min = $0.0018 * Length * Thick = 0.0018 * 3.50 * 12 * 8.0 = 0.6 \text{ in}^2$ < 1.0 in² OK

ACI 8.6.1.1

X-As max for 0.005 tension strain = 3.20 in² > 1.00 in² OK

ACI 21.2.2

Z-As max for 0.005 tension strain = 3.20 in² > 1.00 in² OK

ACI 21.2.2

X-Cover factor = $Min(2.5, (Cover + db / 2, Spacing / 2) / db) = Min(2.5, (3.0 + 0.50 / 2, 9.0 / 2) / 0.50) = 2.5$

Straight X-Ld = $Max(12.0, 3 / 40 * f_y / (f_c)^{1/2} * Grade * Size * Casting / Cover * db * ratio)$

ACI Eq. (25.4.2.3a)

X-Ld = $Max(12.0, 3 / 40 * 40.0 * 1000 / (2500)^{1/2} * 1.0 * 0.8 * 1.0 / 2.5 * 0.50 * 0.65) = 12.0 \text{ in}$

Hooked X-Ldh = $Max(8 db, 6, 0.02 * f_y / (f_c)^{1/2} * Confining * Location * Concrete * db * ratio) =$

ACI 25.4.3

X-Ldh = $Max(8 db, 6, 0.02 * 40.0 * 1000 / (2500)^{1/2} * 1.0 * 0.7 * 0.0 * 0.50 * 0.65) = 6.0 \text{ in}$

-X Ld provided = $(Length - Col) / 2 + Offset - Cover = 3.50 * 12 / 2 + 0.0 - 6.0 / 2 - 2.5 = 15.5 \text{ in}$ > 12.0 in OK

+X Ld provided = $(Length - Col) / 2 - Offset - Cover = 3.50 * 12 / 2 - 0.0 - 6.0 / 2 - 2.5 = 15.5 \text{ in}$ > 12.0 in OK

Z-Cover factor = $\text{Min}(2.5, (\text{Cover} + db / 2, \text{Spacing} / 2) / db) = \text{Min}(2.5, (3.0 + 0.50 / 2, 9.0 / 2) / 0.50) = 2.5$

Straight Z-Ld = $\text{Max}(12.0, 3 / 40 * fy / (fc)^{1/2} * \text{Grade} * \text{Size} * \text{Casting} / \text{Cover} * db * \text{ratio})$ ACI Eq. (25.4.2.3a)

Z-Ld = $\text{Max}(12.0, 3 / 40 * 40.0 * 1000 / (2500)^{1/2} * 1.0 * 0.8 * 1.0 / 2.5 * 0.50 * 0.65) = 12.0 \text{ in}$

Hooked Z-Ldh = $\text{Max}(8 db, 6, 0.02 * fy / (fc)^{1/2} * \text{Confining} * \text{Location} * \text{Concrete} * db * \text{ratio}) =$ ACI 25.4.3

Z-Ldh = $\text{Max}(8 db, 6, 0.02 * 40.0 * 1000 / (2500)^{1/2} * 1.0 * 0.7 * 0.0 * 0.50 * 0.73) = 6.0 \text{ in}$

-Z Ld provided = $(\text{Width} - \text{Col}) / 2 + \text{Offset} - \text{Cover} = 3.50 * 12 / 2 + 0.0 - 6.0 / 2 - 2.5 = 15.5 \text{ in} > 12.0 \text{ in OK}$

+Z Ld provided = $(\text{Width} - \text{Col}) / 2 - \text{Offset} - \text{Cover} = 3.50 * 12 / 2 - 0.0 - 6.0 / 2 - 2.5 = 15.5 \text{ in} > 12.0 \text{ in OK}$

X-bar spacing = 9.0 in < $\text{Min}(3 * t, 18.0) = 18.0 \text{ in OK}$ ACI 7.7.2.3

Z-bar spacing = 9.0 in < $\text{Min}(3 * t, 18.0) = 18.0 \text{ in OK}$

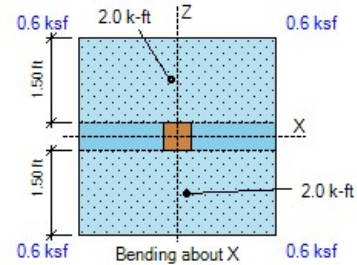
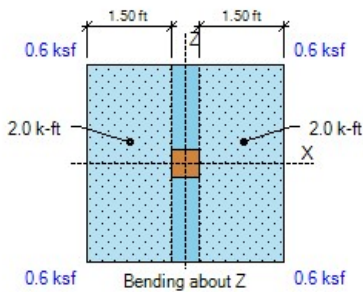

LOAD TRANSFER CALCULATIONS (Comb: 1.2D+1.6L+0.5Lr)

Area $A1 = col L * col W = 6.0 * 6.0 = 36.0 \text{ in}^2$

$Sx = col W * col L^2 / 6 = 6.0 * 6.0^2 / 6 = 36.0 \text{ in}^3$

$Sz = col L * col W^2 / 6 = 6.0 * 6.0^2 / 6 = 36.0 \text{ in}^3$

Bearing $Pbu = P / A1 + Mz / Sx + Mx / Sz = 27.2 / 36.0 + 0.0 * 12 / 36.0 + 0.0 * 12 / 36.0 = 0.8 \text{ ksi}$

Min edge = $\text{Min}(L / 2 - X\text{-offset} - col L / 2, W / 2 - Z\text{-offset} - col W / 2)$

Min edge = $\text{Min}(3.50 * 12 / 2 - 0.0 - 6.0 / 2, 3.50 * 12 / 2 - 0.0 - 6.0 / 2) = 18.0 \text{ in}$

Area $A2 = \text{Min}[L * W, (col L + 2 * \text{Min edge}) * (col W + 2 * \text{Min edge})]$ ACI R22.8.3.2

$A2 = \text{Min}[3.50 * 12 * 3.5 * 12, (6.0 + 2 * 18.0) * (6.0 + 2 * 18.0)] = 1764.0 \text{ in}^2$

Footing $\phi Pnc = \phi * 0.85 * fc * \text{Min}[2, \sqrt{(A2 / A1)}] = 0.65 * 0.85 * 2.5 * \text{Min}[2, \sqrt{(1764.0 / 36.0)}] = 2.8 \text{ ksi}$

Footing $\phi Pns = \phi * As * Fy / A1 = 0.0 \text{ ksi}$ ACI 22.8.3.2

Footing bearing $\phi Pn = \phi Pnc + \phi Pns = 2.8 + 0.0 = 2.8 \text{ ksi} > 0.8 \text{ psi OK}$

Hooked $L_{dh} = \text{Max}(8 db, 6, 0.02 * f_y / (f_c)^{1/2} * \text{Confining} * \text{Location} * \text{Concrete} * db * \text{ratio})$

ACI 25.4.3

$$L_{dh} = \text{Max}(8 db, 6, 0.02 * 60.0 * 1000 / (2500)^{1/2} * 1.0 * 0.7 * 0.0 * 0.75 * 0.13) = 6.0 \text{ in}$$

Ld provided = Dowel length = $3.00 * 12 = 36.0 \text{ in} > 23.5 \text{ in OK}$

Ldh provided = Footing thickness - Cover = $8.00 - 3.0 = 5.0 \text{ in} < 6.0 \text{ in NG}$

PUNCHING SHEAR CALCULATIONS (Comb: 1.2D+1.6L+0.5Lr)

X-Edge = $d/2 = 4.5 / 2 = 2.3 \text{ in}$ $as_x = 20$

Z-Edge = $d/2 = 4.5 / 2 = 2.3 \text{ in}$ $as_z = 20$

$as = as_x + as_z = 20 + 20 = 40$ Col type = Interior $\beta = L / W = 6.0 / 6.0 = 1.00$

ACI 22.6.5.2

Perimeter $bo = as_z / 10 * (L + d/2 + X\text{-Edge}) + as_x / 10 * (W + d/2 + Z\text{-Edge})$

ACI 22.6.4.2

$$bo = 20 / 10 * (6.0 + 4.5 / 2 + 2.3) + 20 / 10 * (6.0 + 4.5 / 2 + 2.3) = 42.0 \text{ in}$$

Area $A_{bo} = (L + d/2 + X\text{-Edge}) * (W + d/2 + Z\text{-Edge}) = (6.0 + 4.5 / 2 + 2.3) * (6.0 + 4.5 / 2 + 2.3) = 110.3 \text{ in}^2$

$\phi V_c = \phi * \text{Min}(2 + 4 / \beta, as * d / bo + 2, 4) * \sqrt{f_c}$

ACI 22.6.5.2

$$\phi V_c = 0.75 * \text{Min}(2 + 4 / 1.00, 40 * 4.5 / 42.0 + 2, 4) * \sqrt{2500} = 150.0 \text{ psi}$$

Punching force $F = P + \text{Overburden} * A_{bo} - \text{Bearing}$

$$F = 27.2 + 0.07 * 110.3 / 144 - 1.8 = 25.5 \text{ kip}$$

$b_1 = L + d/2 + X\text{-Edge} = 6.0 + 4.5 / 2 + 2.3 = 10.5 \text{ in}$ $b_2 = W + d/2 + Z\text{-Edge} = 6.0 + 4.5 / 2 + 2.3 = 10.5 \text{ in}$

$\gamma_{vx} \text{ factor} = 1 - \frac{1}{1 + (2/3) \sqrt{b_2 / b_1}} = 1 - \frac{1}{1 + (2/3) \sqrt{10.5 / 10.5}} = 0.40$

ACI Eq. (8.4.4.2.2)

$\gamma_{vz} \text{ factor} = 1 - \frac{1}{1 + (2/3) \sqrt{b_1 / b_2}} = 1 - \frac{1}{1 + (2/3) \sqrt{10.5 / 10.5}} = 0.40$

ACI Eq. (8.4.2.3.2)

$X_{2z} = b_1 / 2 = 10.5 / 2 = 5.3 \text{ in}$ $X_{2x} = b_2 / 2 = 10.5 / 2 = 5.3 \text{ in}$

$J_{cz} = b_1 * d^3 / 6 + b_1^3 * d / 6 + b_1^2 * b_2 * d / 2$

ACI R8.4.4.2.3

$$J_{cz} = 10.5 * 4.5^3 / 6 + 10.5^3 * 4.5 / 6 + 10.5^2 * 10.5 * 4.5 / 2 = 3632 \text{ in}^4$$

$J_{cx} = b_2 * d^3 / 6 + b_2^3 * d / 6 + b_2^2 * b_1 * d / 2$

ACI R8.4.4.2.3

$$J_{cx} = 10.5 * 4.5^3 / 6 + 10.5^3 * 4.5 / 6 + 10.5^2 * 10.5 * 4.5 / 2 = 3632 \text{ in}^4$$

Stress due to P = $F / (bo * d) * 1000 = 25.5 / (42.0 * 4.5) * 1000 = 134.9 \text{ psi}$

Stress due to Mx = $\gamma_{vx} * X\text{-OTM} * X_{2x} / J_{cx} = 0.40 * 0.0 * 12 * 5.3 / 3632 * 1000 = 0.0 \text{ psi}$

Stress due to Mz = $\gamma_{vz} * Z\text{-OTM} * X_{2z} / J_{cz} = 0.40 * 0.0 * 12 * 5.3 / 3632 * 1000 = 0.0 \text{ psi}$

Punching stress = $P\text{-stress} + Mx\text{-stress} + Mz\text{-stress} = 134.9 + 0.0 + 0.0 = 134.9 \text{ psi} < 150.0 \text{ psi OK}$

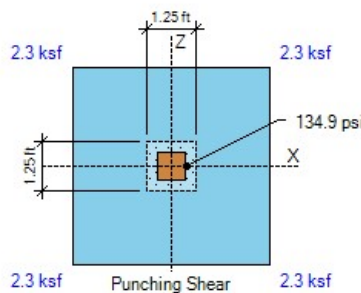

DESIGN CODES

Concrete Design ACI 318-14
Load Combinations ASCE 7-10/16

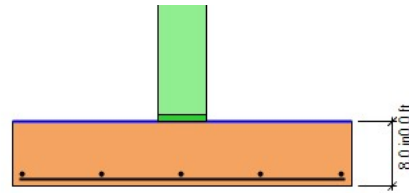

ELEVATION

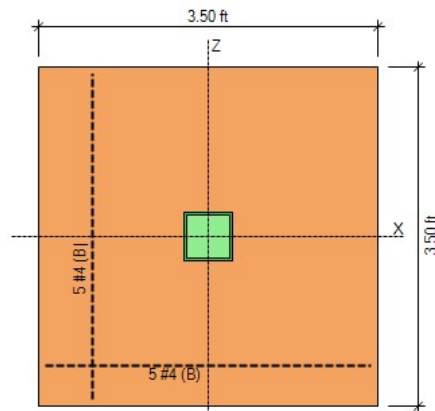

PLAN

ASDIP Foundation 4.8.2.1 **SPREAD FOOTING DESIGN** www.asdipsoft.com

GEOMETRY			SOIL PRESSURES (D+L)		
Footing Length (X-dir)	2.00	ft	Gross Allow. Soil Pressure	2.0	ksf
Footing Width (Z-dir)	2.60	ft	Soil Pressure at Corner 1	2.0	ksf
Footing Thickness	8.0	in OK	Soil Pressure at Corner 2	2.0	ksf
Soil Cover	0.00	ft	Soil Pressure at Corner 3	2.0	ksf
Column Length (X-dir)	6.0	in	Soil Pressure at Corner 4	2.0	ksf
Column Width (Z-dir)	6.0	in	Bearing Pressure Ratio	0.99	OK
Offset (X-dir)	0.00	in OK	Ftg. Area in Contact with Soil	100.0	%
Offset (Z-dir)	0.00	in OK	X-eccentricity / Ftg. Length	0.00	OK
Base Plate (L x W)	6.0 x 6.0	in	Z-eccentricity / Ftg. Width	0.00	OK

APPLIED LOADS

	Dead	Live	RLive	Snow	Wind	Seismic	
Axial Force P	4.5	5.5	0.0	0.0	0.0	0.0	kip
Moment about X Mx ..	0.0	0.0	0.0	0.0	0.0	0.0	k-ft
Moment about Z Mz ..	0.0	0.0	0.0	0.0	0.0	0.0	k-ft
Shear Force Vx	0.0	0.0	0.0	0.0	0.0	0.0	kip
Shear Force Vz	0.0	0.0	0.0	0.0	0.0	0.0	kip

OVERTURNING CALCULATIONS (Comb: 0.6D+0.6W)

- Overturning about X-X

- Moment Mx = 0.6 * 0.0 + 0.6 * 0.0 = 0.0 k-ft
- Shear Force Vz = 0.6 * 0.0 + 0.6 * 0.0 = 0.0 kip
- Arm = 0.00 + 8.0 / 12 = 0.67 ft Moment = 0.0 * 0.67 = 0.0 k-ft
- Passive Force = 0.0 kip Arm = 0.27 ft Moment = 0.0 k-ft
- Overturning moment X-X = 0.0 + 0.0 = 0.0 k-ft

- Resisting about X-X

- Footing weight = 0.6 * W * L * Thick * Density = 0.6 * 2.60 * 2.00 * 8.0 / 12 * 0.15 = 0.3 kip
- Arm = W / 2 = 2.60 / 2 = 1.30 ft Moment = 0.3 * 1.30 = 0.4 k-ft
- Pedestal weight = 0.6 * W * L * H * Density = 0.6 * 6.0 / 12 * 6.0 / 12 * 0.0 * 0.15 = 0.0 kip
- Arm = W / 2 - Offset = 2.60 / 2 - 0.0 / 12 = 1.30 ft Moment = 0.0 * 1.30 = 0.0 k-ft
- Soil cover = 0.6 * W * L * SC * Density = 0.6 * (2.60 * 2.00 - 6.0 / 12 * 6.0 / 12) * 0.0 * 110 = 0.0 kip
- Arm = W / 2 = 2.60 / 2 = 1.30 ft Moment = 0.0 * 1.30 = 0.0 k-ft
- Buoyancy = 0.6 * W * L * γ * (SC + Thick - WT) = 0.6 * 2.60 * 2.00 * 62 * (0.67) = -0.1 kip
- Arm = W / 2 = 2.60 / 2 = 1.30 ft Moment = 0.1 * 1.30 = -0.2 k-ft
- Axial force P = 0.6 * 4.5 + 0.6 * 0.0 = 2.7 kip
- Arm = W / 2 - Offset = 2.60 / 2 - 0.0 / 12 = 1.30 ft Moment = 2.7 * 1.30 = 3.5 k-ft
- Resisting moment X-X = 0.4 + 0.0 + 0.0 + 3.5 + -0.2 = 3.7 k-ft

- Overturning safety factor X-X = $\frac{\text{Resisting moment}}{\text{Overturning moment}} = \frac{3.7}{0.0} = 37.47 > 1.50$ **OK**

ASDIP Foundation 4.8.2.1 **SPREAD FOOTING DESIGN** www.asdipsoft.com

- Overturning about Z-Z

- Moment $M_z = 0.6 * 0.0 + 0.6 * 0.0 = 0.0$ k-ft
- Shear Force $V_x = 0.6 * 0.0 + 0.6 * 0.0 = 0.0$ kip
 Arm = $0.00 + 8.0 / 12 = 0.67$ ft Moment = $0.0 * 0.67 = 0.0$ k-ft
- Passive Force = 0.0 kip Arm = 0.27 ft Moment = 0.0 k-ft
- Overturning moment Z-Z = $0.0 + 0.0 = 0.0$ k-ft

- Resisting about Z-Z

- Footing weight = $0.6 * W * L * Thick * Density = 0.6 * 2.60 * 2.00 * 8.0 / 12 * 0.15 = 0.3$ kip
 Arm = $L / 2 = 2.00 / 2 = 1.00$ ft Moment = $0.3 * 1.00 = 0.3$ k-ft
- Pedestal weight = $0.6 * W * L * H * Density = 0.6 * 6.0 / 12 * 6.0 / 12 * 0.0 * 0.15 = 0.0$ kip
 Arm = $L / 2 - Offset = 2.00 / 2 - 0.0 / 12 = 1.00$ ft Moment = $0.0 * 1.00 = 0.0$ k-ft
- Soil cover = $0.6 * W * L * SC * Density = 0.6 * (2.60 * 2.00 - 6.0 / 12 * 6.0 / 12) * 0.0 * 110 = 0.0$ kip
 Arm = $L / 2 = 2.00 / 2 = 1.00$ ft Moment = $0.0 * 1.00 = 0.0$ k-ft
- Buoyancy = $0.6 * W * L * \gamma * (SC + Thick - WT) = 0.6 * 2.60 * 2.00 * 62 * (0.67) = -0.1$ kip
 Arm = $L / 2 = 2.00 / 2 = 1.00$ ft Moment = $0.1 * 1.00 = -0.1$ k-ft
- Axial force $P = 0.6 * 4.5 + 0.6 * 0.0 = 2.7$ kip
 Arm = $L / 2 - Offset = 2.00 / 2 - 0.0 / 12 = 1.00$ ft Moment = $2.7 * 1.00 = 2.7$ k-ft
- Resisting moment Z-Z = $0.3 + 0.0 + 0.0 + 2.7 + -0.1 = 2.9$ k-ft
- Overturning safety factor Z-Z = $\frac{Resisting\ moment}{Overturning\ moment} = \frac{2.9}{0.0} = 28.82 > 1.50$ OK

SOIL BEARING PRESSURES (Comb: D+L)

- Overturning moment X-X = $0.0 + 0.0 = 0.0$ k-ft
- Resisting moment X-X = $0.7 + 0.0 + 0.0 + -0.3 + 13.0 = 13.4$ k-ft
- Overturning moment Z-Z = $0.0 + 0.0 = 0.0$ k-ft
- Resisting moment Z-Z = $0.5 + 0.0 + 0.0 + -0.2 + 10.0 = 10.3$ k-ft
- Resisting force = $Footing + Pedestal + Soil - Buoyancy + P = 0.5 + 0.0 + 0.0 - 0.2 + 10.0 = 10.3$ kip

X-coordinate of resultant from maximum bearing corner:

$$X_p = \frac{Z-Resisting\ moment - Z-Overturning\ moment}{Resisting\ force} = \frac{10.3 - 0.0}{10.3} = 1.00\text{ ft}$$

Z-coordinate of resultant from maximum bearing corner:

$$Z_p = \frac{X-Resisting\ moment - X-Overturning\ moment}{Resisting\ force} = \frac{13.4 - 0.0}{10.3} = 1.30\text{ ft}$$

X-ecc = $Length / 2 - X_p = 2.00 / 2 - 1.00 = 0.00$ ft

Z-ecc = $Width / 2 - Z_p = 2.60 / 2 - 1.30 = 0.00$ ft

Area = $Width * Length = 2.60 * 2.00 = 5.2$ ft²

S_x = $Length * Width^2 / 6 = 2.00 * 2.60^2 / 6 = 2.3$ ft³

S_z = $Width * Length^2 / 6 = 2.60 * 2.00^2 / 6 = 1.7$ ft³

- Footing is in full bearing. Soil pressures are as follows:

P₁ = $P * (1/A + Z-ecc / S_x + X-ecc / S_z) = 10.3 * (1 / 5.2 + 0.00 / 2.3 + 0.00 / 1.7) = 1.98$ ksf

P₂ = $P * (1/A - Z-ecc / S_x + X-ecc / S_z) = 10.3 * (1 / 5.2 - 0.00 / 2.3 + 0.00 / 1.7) = 1.98$ ksf

P₃ = $P * (1/A - Z-ecc / S_x - X-ecc / S_z) = 10.3 * (1 / 5.2 - 0.00 / 2.3 - 0.00 / 1.7) = 1.98$ ksf

P₄ = $P * (1/A + Z-ecc / S_x - X-ecc / S_z) = 10.3 * (1 / 5.2 + 0.00 / 2.3 - 0.00 / 1.7) = 1.98$ ksf

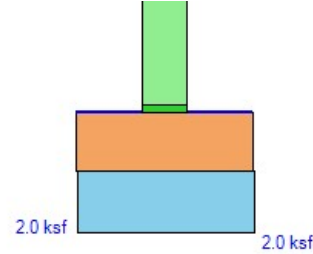
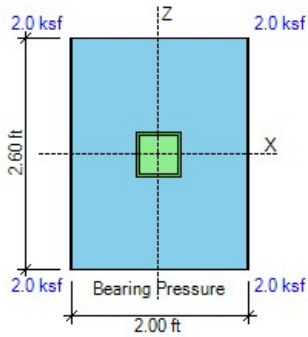

SLIDING CALCULATIONS (Comb: 0.6D+0.6W)

Internal friction angle = 28.0 deg

Passive coefficient $k_p = 4.33$ (per Coulomb)

Pressure at mid-depth = $k_p * Density * (Cover + Thick / 2) = 4.33 * 110 * (0.00 + 8.0 / 12 / 2) = 0.16$ ksf

X-Passive force = $Pressure * Thick * Width = 0.16 * 8.0 / 12 * 2.60 = 0.3$ kip

Z-Passive force = $Pressure * Thick * Length = 0.16 * 8.0 / 12 * 2.00 = 0.2$ kip

Friction force = $Resisting\ force * Friction\ coeff. = \text{Max}(0, 2.9 * 0.35) = 1.0$ kip

Use 100% of Passive + 100% of Friction for sliding resistance

$$\text{- Sliding safety factor X-X} = \frac{X\text{-Passive force} + Friction}{X\text{-Horizontal load}} = \frac{1.00 * 0.3 + 1.00 * 1.0}{0.0} = 12.84 > 1.50 \text{ OK}$$

$$\text{- Sliding safety factor Z-Z} = \frac{Z\text{-Passive force} + Friction}{Z\text{-Horizontal load}} = \frac{1.00 * 0.2 + 1.00 * 1.0}{0.0} = 12.20 > 1.50 \text{ OK}$$

UPLIFT CALCULATIONS (Comb: 0.6D+0.6W)

$$\text{- Uplift safety factor} = \frac{Pedestal + Footing + Cover - Buoyancy}{Uplift load} = \frac{0.0 + 0.3 + 0.0 - 0.1}{0.0} = 99.99 > 1.00 \text{ OK}$$

ONE-WAY SHEAR CALCULATIONS (Comb: 1.2D+1.6L+0.5Lr)

Concrete $f_c = 2.5$ ksi

Steel $f_y = 40.0$ ksi

Soil density = 110 pcf

Use Plain Concrete Shear Strength

$$\phi V_{cx} = \frac{4}{3} * \phi * \sqrt{f_c} * Width * t / 1000 = \frac{4}{3} * 0.60 * \sqrt{2500} * 2.6 * 12 * 8.0 / 1000 = 10.0 \text{ kip}$$

ACI 14.5.5.1

$$\phi V_{cz} = \frac{4}{3} * \phi * \sqrt{f_c} * Length * t / 1000 = \frac{4}{3} * 0.60 * \sqrt{2500} * 2.0 * 12 * 8.0 / 1000 = 7.7 \text{ kip}$$

- Shear forces calculated as the volume of the bearing pressures under the effective areas:

$$\text{One-way shear } V_{ux} \text{ (- Side)} = 0.6 \text{ kip} < 10.0 \text{ kip OK}$$

$$\text{One-way shear } V_{ux} \text{ (+ Side)} = 0.6 \text{ kip} < 10.0 \text{ kip OK}$$

$$\text{One-way shear } V_{uz} \text{ (- Side)} = 2.1 \text{ kip} < 7.7 \text{ kip OK}$$

$$\text{One-way shear } V_{uz} \text{ (+ Side)} = 2.1 \text{ kip} < 7.7 \text{ kip OK}$$

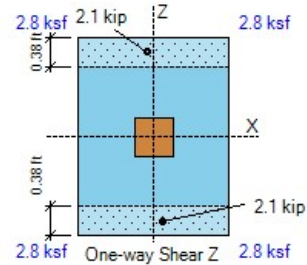
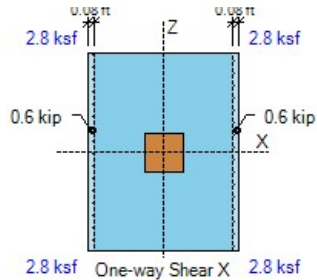

FLEXURE CALCULATIONS (Comb: 1.2D+1.6L+0.5Lr)

Plain $\phi M_{nx} = 5 * \phi * \sqrt{f_c} * L * Thick^2 / 6 = 5 * 0.60 * \sqrt{(2500)} * 2.00 * 8.0^2 / 6 / 1000 = 0.9$ k-ft ACI Eq. (14.5.2.1a)

Plain $\phi M_{nz} = 5 * \phi * \sqrt{f_c} * W * Thick^2 / 6 = 5 * 0.60 * \sqrt{(2500)} * 2.60 * 8.0^2 / 6 / 1000 = 1.1$ k-ft

- Top Bars

No Top Reinforcement Provided at the Footing

Use Plain Concrete Flexural Strength at Top

- Top moments calculated as the overburden minus the bearing pressures times the lever arm:

Top moment -M_{ux} (- Side) = 0.0 k-ft < 3.2 k-ft OK

Top moment -M_{ux} (+ Side) = 0.0 k-ft < 3.2 k-ft OK

Top moment -M_{uz} (- Side) = 0.0 k-ft < 4.2 k-ft OK

Top moment -M_{uz} (+ Side) = 0.0 k-ft < 4.2 k-ft OK

- Bottom Bars

No Bottom Reinforcement Provided at the Footing

Use Plain Concrete Flexural Strength at Bottom

- Bottom moments calculated as the bearing minus the overburden pressures times the lever arm:

Bottom moment M_{ux} (- Side) = 3.0 k-ft < 3.2 k-ft OK ratio = 0.94

Bottom moment M_{ux} (+ Side) = 3.0 k-ft < 3.2 k-ft OK ratio = 0.94

Bottom moment M_{uz} (- Side) = 2.0 k-ft < 4.2 k-ft OK ratio = 0.48

Bottom moment M_{uz} (+ Side) = 2.0 k-ft < 4.2 k-ft OK ratio = 0.48

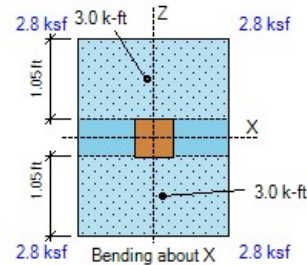
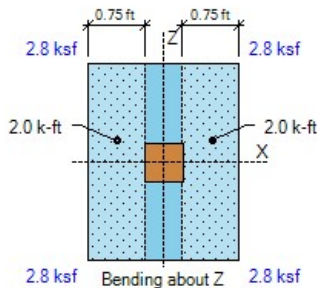

LOAD TRANSFER CALCULATIONS (Comb: 1.2D+1.6L+0.5Lr)

Area $A1 = col L * col W = 6.0 * 6.0 = 36.0 \text{ in}^2$

$Sx = col W * col L^2 / 6 = 6.0 * 6.0^2 / 6 = 36.0 \text{ in}^3$

$Sz = col L * col W^2 / 6 = 6.0 * 6.0^2 / 6 = 36.0 \text{ in}^3$

Bearing $Pbu = P / A1 + Mz / Sx + Mx / Sz = 14.2 / 36.0 + 0.0 * 12 / 36.0 + 0.0 * 12 / 36.0 = 0.4 \text{ ksi}$

Min edge = $Min (L / 2 - X\text{-offset} - col L / 2, W / 2 - Z\text{-offset} - col W / 2)$

Min edge = $Min (2.00 * 12 / 2 - 0.0 - 6.0 / 2, 2.60 * 12 / 2 - 0.0 - 6.0 / 2) = 9.0 \text{ in}$

Area $A2 = Min [L * W, (col L + 2 * Min edge) * (col W + 2 * Min edge)]$

ACI R22.8.3.2

$A2 = Min [2.00 * 12 * 2.6 * 12, (6.0 + 2 * 9.0) * (6.0 + 2 * 9.0)] = 576.0 \text{ in}^2$

Footing $\phi Pnc = \phi * 0.85 * fc * Min [2, \sqrt{(A2 / A1)}] = 0.65 * 0.85 * 2.5 * Min [2, \sqrt{(576.0 / 36.0)}] = 2.8 \text{ ksi}$

Footing $\phi Pns = \phi * As * Fy / A1 = 0.0 \text{ ksi}$

ACI 22.8.3.2

Footing bearing $\phi Pn = \phi Pnc + \phi Pns = 2.8 + 0.0 = 2.8 \text{ ksi} > 0.4 \text{ psi OK}$

ASDIP Foundation 4.8.2.1 SPREAD FOOTING DESIGN www.asdipsoft.com

Hooked $L_{dh} = \text{Max}(8 db, 6, 0.02 * f_y / (f_c)^{1/2} * \text{Confining} * \text{Location} * \text{Concrete} * db * \text{ratio})$ ACI 25.4.3
 $L_{dh} = \text{Max}(8 db, 6, 0.02 * 60.0 * 1000 / (2500)^{1/2} * 1.0 * 0.7 * 0.0 * 0.75 * 0.07) = 6.0 \text{ in}$
 $L_d \text{ provided} = \text{Dowel length} = 3.00 * 12 = 36.0 \text{ in} > 12.3 \text{ in OK}$
 $L_{dh} \text{ provided} = \text{Footing thickness} - \text{Cover} = 8.00 - 3.0 = 5.0 \text{ in} < 6.0 \text{ in NG}$

PUNCHING SHEAR CALCULATIONS (Comb: 1.2D+1.6L+0.5Lr)

X-Edge = $\text{Length} / 2 - \text{Offset} - \text{Col} / 2 = 2.00 * 12 / 2 - 0.0 - 6.0 / 2 = 9.0 \text{ in}$ $as_x = 10$
 Z-Edge = $\text{Width} / 2 - \text{Offset} - \text{Col} / 2 = 2.60 * 12 / 2 - 0.0 - 6.0 / 2 = 12.6 \text{ in}$ $as_z = 10$
 $as = as_x + as_z = 10 + 10 = 20$ Col type = Corner $\beta = L / W = 6.0 / 6.0 = 1.00$ ACI 22.6.5.2

Perimeter $bo = as_z / 10 * (L + d / 2 + X\text{-Edge}) + as_x / 10 * (W + d / 2 + Z\text{-Edge})$ ACI 22.6.4.2
 $bo = 10 / 10 * (6.0 + 8.0 / 2 + 9.0) + 10 / 10 * (6.0 + 8.0 / 2 + 12.6) = 41.6 \text{ in}$
 Area $A_{bo} = (L + d / 2 + X\text{-Edge}) * (W + d / 2 + Z\text{-Edge}) = (6.0 + 8.0 / 2 + 9.0) * (6.0 + 8.0 / 2 + 12.6) = 429.4 \text{ in}^2$

Use Plain Concrete Shear Strength
 $\phi V_c = \phi * \text{Min}(1 + 2 / \beta, 2) * 4/3 * \sqrt{f_c}$ ACI 14.5.5.1
 $\phi V_c = 0.60 * \text{Min}(1 + 2 / 1.00, 2) * 4/3 * \sqrt{2500} = 80.0 \text{ psi}$

Punching force $F = P + \text{Overburden} * A_{bo} - \text{Bearing}$
 $F = 14.2 + 0.07 * 429.4 / 144 - 3.8 = 10.6 \text{ kip}$
 $b_1 = L + d / 2 + X\text{-Edge} = 6.0 + 8.0 / 2 + 9.0 = 19.0 \text{ in}$ $b_2 = W + d / 2 + Z\text{-Edge} = 6.0 + 8.0 / 2 + 12.6 = 22.6 \text{ in}$

$\gamma_{vx} \text{ factor} = 1 - \frac{1}{1 + (2/3) \sqrt{b_2 / b_1}} = 1 - \frac{1}{1 + (2/3) \sqrt{22.6 / 19.0}} = 0.42$ ACI Eq. (8.4.4.2.2)

$\gamma_{vz} \text{ factor} = 1 - \frac{1}{1 + (2/3) \sqrt{b_1 / b_2}} = 1 - \frac{1}{1 + (2/3) \sqrt{19.0 / 22.6}} = 0.38$ ACI Eq. (8.4.2.3.2)

$X_{2z} = b_1^2 / 2 / (b_1 + b_2) = 19.0^2 / 2 / (19.0 + 22.6) = 4.3 \text{ in}$ $X_{2x} = b_2^2 / 2 / (b_2 + b_1) = 6.1 \text{ in}$

$J_{cz} = b_1 * d^3 / 12 + b_1^3 * d / 12 + b_1 * d * (b_1 / 2 - X_{2z})^2 + b_2 * d * X_{2z}^2$ ACI R8.4.4.2.3

$J_{cx} = b_2 * d^3 / 12 + b_2^3 * d / 12 + b_2 * d * (b_2 / 2 - X_{2x})^2 + b_1 * d * X_{2x}^2$ ACI R8.4.4.2.3

$J_{cz} = 19.0 * 8.0^3 / 12 + 19.0^3 * 8.0 / 12 + 19.0 * 8.0 * (19.0 / 2 * 4.3)^2 + 22.6 * 8.0 * 4.3^2 = 12836 \text{ in}^4$
 $J_{cx} = 22.6 * 8.0^3 / 12 + 22.6^3 * 8.0 / 12 + 22.6 * 8.0 * (22.6 / 2 * 6.1)^2 + 19.0 * 8.0 * 6.1^2 = 19204 \text{ in}^4$

Stress due to P = $F / (bo * d) * 1000 = 10.6 / (41.6 * 8.0) * 1000 = 31.8 \text{ psi}$
 Stress due to Mx = $\gamma_{vx} * X\text{-OTM} * X_{2x} / J_{cx} = 0.42 * 0.0 * 12 * 6.1 / 19204 * 1000 = 0.0 \text{ psi}$
 Stress due to Mz = $\gamma_{vz} * Z\text{-OTM} * X_{2z} / J_{cz} = 0.42 * 0.0 * 12 * 4.3 / 12836 * 1000 = 0.0 \text{ psi}$
 Punching stress = $P\text{-stress} + Mx\text{-stress} + Mz\text{-stress} = 31.8 + 0.0 + 0.0 = 31.8 \text{ psi} < 80.0 \text{ psi OK}$

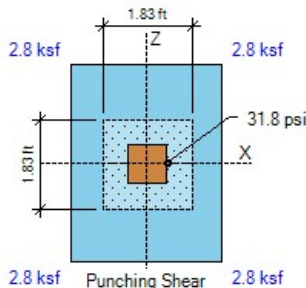

DESIGN CODES

Concrete Design ACI 318-14
Load Combinations ASCE 7-10/16

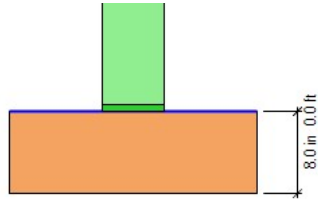

ELEVATION

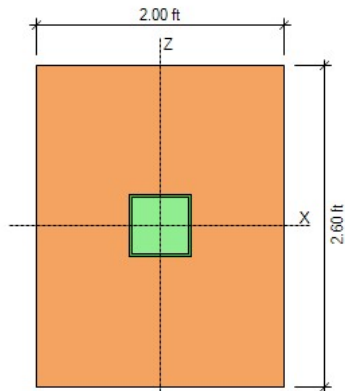

PLAN

GEOMETRY				SOIL PRESSURES (D+L)			
Footing Length (X-dir)	1.50	ft		Gross Allow. Soil Pressure	2.0	ksf	
Footing Width (Z-dir)	2.60	ft		Soil Pressure at Corner 1	2.0	ksf	
Footing Thickness	8.0	in	OK	Soil Pressure at Corner 2	2.0	ksf	
Soil Cover	0.00	ft		Soil Pressure at Corner 3	2.0	ksf	
Column Length (X-dir)	6.0	in		Soil Pressure at Corner 4	2.0	ksf	
Column Width (Z-dir)	6.0	in		Bearing Pressure Ratio	0.99	OK	
Offset (X-dir)	0.00	in	OK	Ftg. Area in Contact with Soil	100.0	%	
Offset (Z-dir)	0.00	in	OK	X-eccentricity / Ftg. Length	0.00	OK	
Base Plate (L x W)	6.0 x 6.0	in		Z-eccentricity / Ftg. Width	0.00	OK	

APPLIED LOADS							
	Dead	Live	RLive	Snow	Wind	Seismic	
Axial Force P	3.0	4.5	0.0	0.0	0.0	0.0	kip
Moment about X Mx ..	0.0	0.0	0.0	0.0	0.0	0.0	k-ft
Moment about Z Mz ..	0.0	0.0	0.0	0.0	0.0	0.0	k-ft
Shear Force Vx	0.0	0.0	0.0	0.0	0.0	0.0	kip
Shear Force Vz	0.0	0.0	0.0	0.0	0.0	0.0	kip

OVERTURNING CALCULATIONS (Comb: 0.6D+0.6W)	
- Overturning about X-X	
- Moment Mx = 0.6 * 0.0 + 0.6 * 0.0 = 0.0 k-ft	
- Shear Force Vz = 0.6 * 0.0 + 0.6 * 0.0 = 0.0 kip	
Arm = 0.00 + 8.0 / 12 = 0.67 ft	Moment = 0.0 * 0.67 = 0.0 k-ft
- Passive Force = 0.0 kip	Arm = 0.27 ft Moment = 0.0 k-ft
- Overturning moment X-X = 0.0 + 0.0 = 0.0 k-ft	
- Resisting about X-X	
- Footing weight = 0.6 * W * L * Thick * Density = 0.6 * 2.60 * 1.50 * 8.0 / 12 * 0.15 = 0.2 kip	
Arm = W / 2 = 2.60 / 2 = 1.30 ft	Moment = 0.2 * 1.30 = 0.3 k-ft
- Pedestal weight = 0.6 * W * L * H * Density = 0.6 * 6.0 / 12 * 6.0 / 12 * 0.0 * 0.15 = 0.0 kip	
Arm = W / 2 - Offset = 2.60 / 2 - 0.0 / 12 = 1.30 ft	Moment = 0.0 * 1.30 = 0.0 k-ft
- Soil cover = 0.6 * W * L * SC * Density = 0.6 * (2.60 * 1.50 - 6.0 / 12 * 6.0 / 12) * 0.0 * 110 = 0.0 kip	
Arm = W / 2 = 2.60 / 2 = 1.30 ft	Moment = 0.0 * 1.30 = 0.0 k-ft
- Buoyancy = 0.6 * W * L * γ * (SC + Thick - WT) = 0.6 * 2.60 * 1.50 * 62 * (0.67) = -0.1 kip	
Arm = W / 2 = 2.60 / 2 = 1.30 ft	Moment = 0.1 * 1.30 = -0.1 k-ft
- Axial force P = 0.6 * 3.0 + 0.6 * 0.0 = 1.8 kip	
Arm = W / 2 - Offset = 2.60 / 2 - 0.0 / 12 = 1.30 ft	Moment = 1.8 * 1.30 = 2.3 k-ft
- Resisting moment X-X = 0.3 + 0.0 + 0.0 + 2.3 + -0.1 = 2.5 k-ft	
- Overturning safety factor X-X = $\frac{\text{Resisting moment}}{\text{Overturning moment}} = \frac{2.5}{0.0} = 25.18 > 1.50$ OK	

- Overturning about Z-Z

- Moment $M_z = 0.6 * 0.0 + 0.6 * 0.0 = 0.0$ k-ft

- Shear Force $V_x = 0.6 * 0.0 + 0.6 * 0.0 = 0.0$ kip

Arm = $0.00 + 8.0 / 12 = 0.67$ ft

Moment = $0.0 * 0.67 = 0.0$ k-ft

- Passive Force = 0.0 kip

Arm = 0.27 ft

Moment = 0.0 k-ft

- Overturning moment Z-Z = $0.0 + 0.0 = 0.0$ k-ft

- Resisting about Z-Z

- Footing weight = $0.6 * W * L * Thick * Density = 0.6 * 2.60 * 1.50 * 8.0 / 12 * 0.15 = 0.2$ kip

Arm = $L / 2 = 1.50 / 2 = 0.75$ ft

Moment = $0.2 * 0.75 = 0.2$ k-ft

- Pedestal weight = $0.6 * W * L * H * Density = 0.6 * 6.0 / 12 * 6.0 / 12 * 0.0 * 0.15 = 0.0$ kip

Arm = $L / 2 - Offset = 1.50 / 2 - 0.0 / 12 = 0.75$ ft

Moment = $0.0 * 0.75 = 0.0$ k-ft

- Soil cover = $0.6 * W * L * SC * Density = 0.6 * (2.60 * 1.50 - 6.0 / 12 * 6.0 / 12) * 0.0 * 110 = 0.0$ kip

Arm = $L / 2 = 1.50 / 2 = 0.75$ ft

Moment = $0.0 * 0.75 = 0.0$ k-ft

- Buoyancy = $0.6 * W * L * \gamma * (SC + Thick - WT) = 0.6 * 2.60 * 1.50 * 62 * (0.67) = -0.1$ kip

Arm = $L / 2 = 1.50 / 2 = 0.75$ ft

Moment = $0.1 * 0.75 = -0.1$ k-ft

- Axial force $P = 0.6 * 3.0 + 0.6 * 0.0 = 1.8$ kip

Arm = $L / 2 - Offset = 1.50 / 2 - 0.0 / 12 = 0.75$ ft

Moment = $1.8 * 0.75 = 1.4$ k-ft

- Resisting moment Z-Z = $0.2 + 0.0 + 0.0 + 1.4 + -0.1 = 1.5$ k-ft

- Overturning safety factor Z-Z = $\frac{Resisting\ moment}{Overturning\ moment} = \frac{1.5}{0.0} = 14.52 > 1.50$ OK

SOIL BEARING PRESSURES (Comb: D+L)

Overturning moment X-X = $0.0 + 0.0 = 0.0$ k-ft

Resisting moment X-X = $0.5 + 0.0 + 0.0 + -0.2 + 9.8 = 10.0$ k-ft

Overturning moment Z-Z = $0.0 + 0.0 = 0.0$ k-ft

Resisting moment Z-Z = $0.3 + 0.0 + 0.0 + -0.1 + 5.6 = 5.8$ k-ft

Resisting force = $Footing + Pedestal + Soil - Buoyancy + P = 0.4 + 0.0 + 0.0 - 0.2 + 7.5 = 7.7$ kip

X-coordinate of resultant from maximum bearing corner:

$$X_p = \frac{Z-Resisting\ moment - Z-Overturning\ moment}{Resisting\ force} = \frac{5.8 - 0.0}{7.7} = 0.75$$
 ft

Z-coordinate of resultant from maximum bearing corner:

$$Z_p = \frac{X-Resisting\ moment - X-Overturning\ moment}{Resisting\ force} = \frac{10.0 - 0.0}{7.7} = 1.30$$
 ft

X-ecc = $Length / 2 - X_p = 1.50 / 2 - 0.75 = 0.00$ ft

Z-ecc = $Width / 2 - Z_p = 2.60 / 2 - 1.30 = 0.00$ ft

Area = $Width * Length = 2.60 * 1.50 = 3.9$ ft²

S_x = $Length * Width^2 / 6 = 1.50 * 2.60^2 / 6 = 1.7$ ft³

S_z = $Width * Length^2 / 6 = 2.60 * 1.50^2 / 6 = 1.0$ ft³

- Footing is in full bearing. Soil pressures are as follows:

P₁ = $P * (1/A + Z-ecc / S_x + X-ecc / S_z) = 7.7 * (1/3.9 + 0.00 / 1.7 + 0.00 / 1.0) = 1.98$ ksf

P₂ = $P * (1/A - Z-ecc / S_x + X-ecc / S_z) = 7.7 * (1/3.9 - 0.00 / 1.7 + 0.00 / 1.0) = 1.98$ ksf

P₃ = $P * (1/A - Z-ecc / S_x - X-ecc / S_z) = 7.7 * (1/3.9 - 0.00 / 1.7 - 0.00 / 1.0) = 1.98$ ksf

P₄ = $P * (1/A + Z-ecc / S_x - X-ecc / S_z) = 7.7 * (1/3.9 + 0.00 / 1.7 - 0.00 / 1.0) = 1.98$ ksf

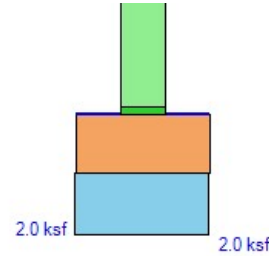
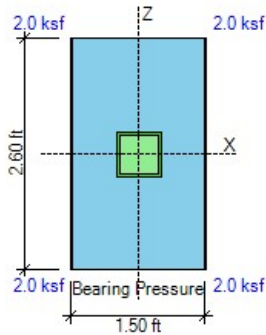

SLIDING CALCULATIONS (Comb: 0.6D+0.6W)

Internal friction angle = 28.0 deg

Passive coefficient $k_p = 4.33$ (per Coulomb)

Pressure at mid-depth = $k_p * Density * (Cover + Thick / 2) = 4.33 * 110 * (0.00 + 8.0 / 12 / 2) = 0.16$ ksf

X-Passive force = $Pressure * Thick * Width = 0.16 * 8.0 / 12 * 2.60 = 0.3$ kip

Z-Passive force = $Pressure * Thick * Length = 0.16 * 8.0 / 12 * 1.50 = 0.2$ kip

Friction force = $Resisting\ force * Friction\ coeff. = \text{Max}(0, 1.9 * 0.35) = 0.7$ kip

Use 100% of Passive + 100% of Friction for sliding resistance

$$\text{- Sliding safety factor X-X} = \frac{X\text{-Passive force} + Friction}{X\text{-Horizontal load}} = \frac{1.00 * 0.3 + 1.00 * 0.7}{0.0} = 9.53 > 1.50 \text{ OK}$$

$$\text{- Sliding safety factor Z-Z} = \frac{Z\text{-Passive force} + Friction}{Z\text{-Horizontal load}} = \frac{1.00 * 0.2 + 1.00 * 0.7}{0.0} = 8.36 > 1.50 \text{ OK}$$

UPLIFT CALCULATIONS (Comb: 0.6D+0.6W)

$$\text{- Uplift safety factor} = \frac{Pedestal + Footing + Cover - Buoyancy}{Uplift load} = \frac{0.0 + 0.2 + 0.0 - 0.1}{0.0} = 99.99 > 1.00 \text{ OK}$$

ONE-WAY SHEAR CALCULATIONS (Comb: 1.2D+1.6L+0.5Lr)

Concrete $f_c = 2.5$ ksi

Steel $f_y = 40.0$ ksi

Soil density = 110 pcf

Use Plain Concrete Shear Strength

$$\phi V_{cx} = \frac{4}{3} * \phi * \sqrt{f_c} * Width * t / 1000 = \frac{4}{3} * 0.60 * \sqrt{2500} * 2.6 * 12 * 8.0 / 1000 = 10.0 \text{ kip}$$

ACI 14.5.5.1

$$\phi V_{cz} = \frac{4}{3} * \phi * \sqrt{f_c} * Length * t / 1000 = \frac{4}{3} * 0.60 * \sqrt{2500} * 1.5 * 12 * 8.0 / 1000 = 5.8 \text{ kip}$$

- Shear forces calculated as the volume of the bearing pressures under the effective areas:

$$\text{One-way shear } V_{ux} \text{ (- Side)} = 0.0 \text{ kip} < 10.0 \text{ kip OK}$$

$$\text{One-way shear } V_{ux} \text{ (+ Side)} = 0.0 \text{ kip} < 10.0 \text{ kip OK}$$

$$\text{One-way shear } V_{uz} \text{ (- Side)} = 1.6 \text{ kip} < 5.8 \text{ kip OK}$$

$$\text{One-way shear } V_{uz} \text{ (+ Side)} = 1.6 \text{ kip} < 5.8 \text{ kip OK}$$

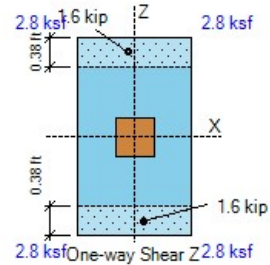
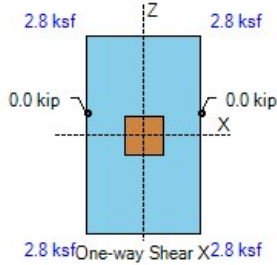

FLEXURE CALCULATIONS (Comb: 1.2D+1.6L+0.5Lr)

Plain $\phi M_{nx} = 5 * \phi * \sqrt{f_c} * L * Thick^2 / 6 = 5 * 0.60 * \sqrt{(2500)} * 1.50 * 8.0^2 / 6 / 1000 = 0.6$ k-ft **ACI Eq. (14.5.2.1a)**

Plain $\phi M_{nz} = 5 * \phi * \sqrt{f_c} * W * Thick^2 / 6 = 5 * 0.60 * \sqrt{(2500)} * 2.60 * 8.0^2 / 6 / 1000 = 1.1$ k-ft

- Top Bars

No Top Reinforcement Provided at the Footing

Use Plain Concrete Flexural Strength at Top

- Top moments calculated as the overburden minus the bearing pressures times the lever arm:

Top moment -M_{ux} (- Side) = 0.0 k-ft < 2.4 k-ft OK

Top moment -M_{ux} (+ Side) = 0.0 k-ft < 2.4 k-ft OK

Top moment -M_{uz} (- Side) = 0.0 k-ft < 4.2 k-ft OK

Top moment -M_{uz} (+ Side) = 0.0 k-ft < 4.2 k-ft OK

- Bottom Bars

No Bottom Reinforcement Provided at the Footing

Use Plain Concrete Flexural Strength at Bottom

- Bottom moments calculated as the bearing pressures minus the overburden pressures times the lever arm:

Bottom moment M_{ux} (- Side) = 2.3 k-ft < 2.4 k-ft OK ratio = 0.96

Bottom moment M_{ux} (+ Side) = 2.3 k-ft < 2.4 k-ft OK ratio = 0.96

Bottom moment M_{uz} (- Side) = 0.9 k-ft < 4.2 k-ft OK ratio = 0.22

Bottom moment M_{uz} (+ Side) = 0.9 k-ft < 4.2 k-ft OK ratio = 0.22

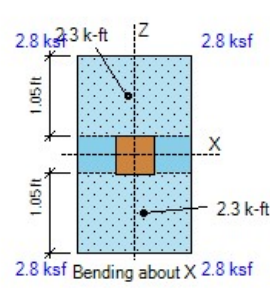
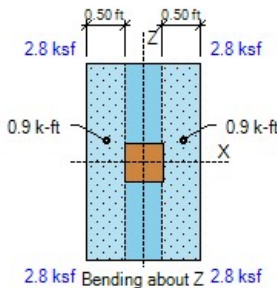

Project:

Page # ____

Engineer:

1/11/2024

Descrip: Typical Interior Footing 6,500# point load

ASDIP Foundation 4.8.2.1

SPREAD FOOTING DESIGN

www.asdipsoft.com

LOAD TRANSFER CALCULATIONS (Comb: 1.2D+1.6L+0.5Lr)

$$\text{Area } A1 = \text{col } L * \text{col } W = 6.0 * 6.0 = 36.0 \text{ in}^2$$

$$Sx = \text{col } W * \text{col } L^2 / 6 = 6.0 * 6.0^2 / 6 = 36.0 \text{ in}^3$$

$$Sz = \text{col } L * \text{col } W^2 / 6 = 6.0 * 6.0^2 / 6 = 36.0 \text{ in}^3$$

$$\text{Bearing } Pbu = P / A1 + Mz / Sx + Mx / Sz = 10.8 / 36.0 + 0.0 * 12 / 36.0 + 0.0 * 12 / 36.0 = 0.3 \text{ ksi}$$

$$\text{Min edge} = \text{Min} (L / 2 - X\text{-offset} - \text{col } L / 2, W / 2 - Z\text{-offset} - \text{col } W / 2)$$

$$\text{Min edge} = \text{Min} (1.50 * 12 / 2 - 0.0 - 6.0 / 2, 2.60 * 12 / 2 - 0.0 - 6.0 / 2) = 6.0 \text{ in}$$

$$\text{Area } A2 = \text{Min} [L * W, (\text{col } L + 2 * \text{Min edge}) * (\text{col } W + 2 * \text{Min edge})]$$

ACI R22.8.3.2

$$A2 = \text{Min} [1.50 * 12 * 2.6 * 12, (6.0 + 2 * 6.0) * (6.0 + 2 * 6.0)] = 324.0 \text{ in}^2$$

$$\text{Footing } \phi Pnc = \phi * 0.85 * fc * \text{Min} [2, \sqrt{(A2 / A1)}] = 0.65 * 0.85 * 2.5 * \text{Min} [2, \sqrt{(324.0 / 36.0)}] = 2.8 \text{ ksi}$$

$$\text{Footing } \phi Pns = \phi * As * Fy / A1 = 0.0 \text{ ksi}$$

ACI 22.8.3.2

$$\text{Footing bearing } \phi Pn = \phi Pnc + \phi Pns = 2.8 + 0.0 = 2.8 \text{ ksi} > 0.3 \text{ psi OK}$$

ASDIP Foundation 4.8.2.1 SPREAD FOOTING DESIGN www.asdipsoft.com

Hooked $L_{dh} = \text{Max}(8 db, 6, 0.02 * f_y / (f_c)^{1/2} * \text{Confining} * \text{Location} * \text{Concrete} * db * \text{ratio})$ ACI 25.4.3
 $L_{dh} = \text{Max}(8 db, 6, 0.02 * 60.0 * 1000 / (2500)^{1/2} * 1.0 * 0.7 * 0.0 * 0.75 * 0.05) = 6.0 \text{ in}$
 Ld provided = Dowel length = $3.00 * 12 = 36.0 \text{ in} > 12.0 \text{ in OK}$
 Ldh provided = Footing thickness - Cover = $8.00 - 3.0 = 5.0 \text{ in} < 6.0 \text{ in NG}$

PUNCHING SHEAR CALCULATIONS (Comb: 1.2D+1.6L+0.5Lr)

X-Edge = $\text{Length} / 2 - \text{Offset} - \text{Col} / 2 = 1.50 * 12 / 2 - 0.0 - 6.0 / 2 = 6.0 \text{ in}$ asx = 10
 Z-Edge = $\text{Width} / 2 - \text{Offset} - \text{Col} / 2 = 2.60 * 12 / 2 - 0.0 - 6.0 / 2 = 12.6 \text{ in}$ asz = 10
 as = asx + asz = 10 + 10 = 20 Col type = Corner $\beta = L / W = 6.0 / 6.0 = 1.00$ ACI 22.6.5.2

Perimeter $b_o = asz / 10 * (L + d / 2 + X\text{-Edge}) + asx / 10 * (W + d / 2 + Z\text{-Edge})$ ACI 22.6.4.2
 $b_o = 10 / 10 * (6.0 + 8.0 / 2 + 6.0) + 10 / 10 * (6.0 + 8.0 / 2 + 12.6) = 38.6 \text{ in}$
 Area $A_{bo} = (L + d / 2 + X\text{-Edge}) * (W + d / 2 + Z\text{-Edge}) = (6.0 + 8.0 / 2 + 6.0) * (6.0 + 8.0 / 2 + 12.6) = 361.6 \text{ in}^2$

Use Plain Concrete Shear Strength
 $\phi V_c = \phi * \text{Min}(1 + 2 / \beta, 2) * 4/3 * \sqrt{f_c}$ ACI 14.5.5.1
 $\phi V_c = 0.60 * \text{Min}(1 + 2 / 1.00, 2) * 4/3 * \sqrt{2500} = 80.0 \text{ psi}$

Punching force $F = P + \text{Overburden} * A_{bo} - \text{Bearing}$
 $F = 10.8 + 0.07 * 361.6 / 144 - 3.9 = 7.1 \text{ kip}$
 $b_1 = L + d / 2 + X\text{-Edge} = 6.0 + 8.0 / 2 + 6.0 = 16.0 \text{ in}$ $b_2 = W + d / 2 + Z\text{-Edge} = 6.0 + 8.0 / 2 + 12.6 = 22.6 \text{ in}$

$\gamma_{vx} \text{ factor} = 1 - \frac{1}{1 + (2/3) \sqrt{b_2 / b_1}} = 1 - \frac{1}{1 + (2/3) \sqrt{22.6 / 16.0}} = 0.44$ ACI Eq. (8.4.4.2.2)

$\gamma_{vz} \text{ factor} = 1 - \frac{1}{1 + (2/3) \sqrt{b_1 / b_2}} = 1 - \frac{1}{1 + (2/3) \sqrt{16.0 / 22.6}} = 0.36$ ACI Eq. (8.4.2.3.2)

$X_{2z} = b_1^2 / 2 / (b_1 + b_2) = 16.0^2 / 2 / (16.0 + 22.6) = 3.3 \text{ in}$ $X_{2x} = b_2^2 / 2 / (b_2 + b_1) = 6.6 \text{ in}$

$J_{cz} = b_1 * d^3 / 12 + b_1^3 * d / 12 + b_1 * d * (b_1 / 2 - X_{2z})^2 + b_2 * d * X_{2z}^2$ ACI R8.4.4.2.3

$J_{cz} = 16.0 * 8.0^3 / 12 + 16.0^3 * 8.0 / 12 + 16.0 * 8.0 * (16.0 / 2 - 3.3)^2 + 22.6 * 8.0 * 3.3^2 = 8210 \text{ in}^4$

$J_{cx} = b_2 * d^3 / 12 + b_2^3 * d / 12 + b_2 * d * (b_2 / 2 - X_{2x})^2 + b_1 * d * X_{2x}^2$ ACI R8.4.4.2.3

$J_{cx} = 22.6 * 8.0^3 / 12 + 22.6^3 * 8.0 / 12 + 22.6 * 8.0 * (22.6 / 2 - 6.6)^2 + 16.0 * 8.0 * 6.6^2 = 18229 \text{ in}^4$

Stress due to P = $F / (b_o * d) * 1000 = 7.1 / (38.6 * 8.0) * 1000 = 23.0 \text{ psi}$

Stress due to Mx = $\gamma_{vx} * X\text{-OTM} * X_{2x} / J_{cx} = 0.44 * 0.0 * 12 * 6.6 / 18229 * 1000 = 0.0 \text{ psi}$

Stress due to Mz = $\gamma_{vz} * Z\text{-OTM} * X_{2z} / J_{cz} = 0.44 * 0.0 * 12 * 3.3 / 8210 * 1000 = 0.0 \text{ psi}$

Punching stress = P-stress + Mx-stress + Mz-stress = 23.0 + 0.0 + 0.0 = 23.0 psi < 80.0 psi OK

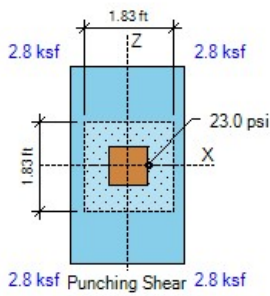

DESIGN CODES

Concrete Design ACI 318-14
Load Combinations ASCE 7-10/16

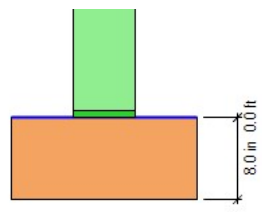

ELEVATION

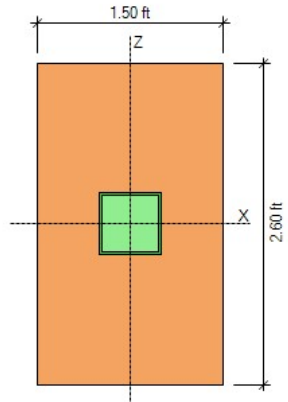

PLAN

1/10/2024

C. PIERRUCCI, PE

ETC - BUILDING B

LATERAL ANALYSIS

1

$$\text{WIND } V_{ASD} = 95 \text{ MPH } V_{ULT} = 110 \text{ MPH EXP. B } K_{zt} = 1.0 \text{ } \angle \text{LOPE} = 0^\circ - 34^\circ$$

$$h = 36' \quad \lambda = 1.06$$

$$\text{ZONE A} = 12.9 \text{ PSF} \times 1.06 = 13.7 \text{ PSF } 16.0 \text{ PSF MIN}$$

$$\text{ZONE B} = 8.8 \text{ PSF} \times 1.06 = 9.3 \text{ PSF}$$

$$\text{ZONE C} = 10.7 \text{ PSF} \times 1.06 = 10.8 \text{ PSF } 16.0 \text{ PSF MIN}$$

$$\text{ZONE D} = 7.0 \text{ PSF} \times 1.06 = 7.4 \text{ PSF } 8.0 \text{ PSF MIN}$$

$$\text{SEISMIC } S_{DS} = 0.831 \quad R = 6.5 \quad I_e = 1.0$$

$$C_s = (0.831 / (6.5 \times 1.0)) / 1.4 = 0.091$$

$$W_{\text{ROOF}} = (35 \text{ PSF} \times 11,333 \text{ SF}) = 396,655 \#$$

$$h = 9'$$

$$h_R = 29'$$

$$W_{\text{LEVEL 3}} = (40 \text{ PSF} \times 10,229 \text{ SF}) = 409,160 \#$$

$$h = 9'$$

$$h_3 = 20'$$

$$W_{\text{LEVEL 2}} = (40 \text{ PSF} \times 10,490 \text{ SF}) = 419,600 \#$$

$$h = 9'$$

$$h_2 = 10'$$

$$W_{\text{TOTAL}} = 1,225,415 \#$$

$$V_s = 1,225,415 \# \times 0.091 = 111,513 \#$$

$$23,892,305$$

$$F_{\text{ROOF}} = \left[\frac{(396,655 \# \times 29')}{(396,655 \# \times 29') + (409,160 \# \times 20') + (419,600 \# \times 10')} \right] \times 111,513 \# = 44,412 \#$$

$$F_{\text{LEVEL 3}} = \left[\frac{(409,160 \# \times 20')}{(396,655 \# \times 29') + (409,160 \# \times 20') + (419,600 \# \times 10')} \right] \times 111,513 \# = 38,210 \#$$

$$F_{\text{LEVEL 2}} = \left[\frac{(419,600 \# \times 10')}{(396,655 \# \times 29') + (409,160 \# \times 20') + (419,600 \# \times 10')} \right] \times 111,513 \# = 28,891 \#$$

GRID 1 = 13

$$F_{3W} = (16.0 \text{ PSF} \times 208 \text{ SF}) + (9.3 \text{ PSF} \times 122 \text{ SF}) + (9.0 \text{ PSF} \times 74 \text{ SF}) = 5,055 \#$$

$$F_{3E} = 44,412 \# \times (1,538 \text{ SF} / 11,333 \text{ SF}) = 6,027 \#$$

$$F_{2W} = 5,055 \# + (16.0 \text{ PSF} \times 230 \text{ SF}) = 8,863 \#$$

$$F_{2E} = 6,027 \# + 38,210 \# \times (1,372 \text{ SF} / 10,229 \text{ SF}) = 11,152 \#$$

$$F_{1W} = 8,863 \# + (16.0 \text{ PSF} \times 240 \text{ SF}) = 12,703 \#$$

$$F_{1E} = 11,152 \# + 28,891 \# \times (1,372 \text{ SF} / 10,490 \text{ SF}) = 14,931 \#$$

GRID 4/5 = 8/9

$$F_{3W} = (16.0 \text{ PSF} \times 460 \text{ SF}) + (8.0 \text{ PSF} \times 335 \text{ SF}) = 7,624 \#$$

$$F_{3E} = 44,412 \# \times (2,373 \text{ SF} / 11,333 \text{ SF}) = 9,299 \#$$

$$F_{2W} = 7,624 \# + (16.0 \text{ PSF} \times 442 \text{ SF}) = 14,696 \#$$

$$F_{2E} = 9,299 \# + 38,210 \# \times (2,048 \text{ SF} / 10,229 \text{ SF}) = 16,950 \#$$

$$F_{1W} = 14,696 \# + (16.0 \text{ PSF} \times 443 \text{ SF}) = 21,784 \#$$

$$F_{1E} = 16,950 \# + 28,891 \# \times (2,120 \text{ SF} / 10,229 \text{ SF}) = 23,101 \#$$

GRID 7

$F_{3W} = (16.00SF \times 526.SF)$	$= 8,416\#$
$F_{3E} = 44,412\# \times (2.777SF / 11,333SF)$	$= 10,993\#$
$F_{2W} = 8,416\# + (16.00SF \times 412.SF)$	$= 15,009\#$
$F_{2E} = 10,993\# + 38,210\# \times (2.650SF / 10,229SF)$	$= 20,782\#$
$F_{1W} = 15,009\# + (16.00SF \times 413.SF)$	$= 21,616\#$
$F_{1E} = 20,782\# + 29,991\# \times (2.650SF / 10,490SF)$	$= 28,080\#$

GRIDS A-C

$$F_{3W} = (16.0 \text{ psf} \times 179 \text{ sf}) + (9.3 \text{ psf} \times 111 \text{ sf}) + (8.0 \text{ psf} \times 43 \text{ sf}) = 4,240 \#$$

$$F_{3E} = 44,412 \# \times (2.611 \text{ sf} / 11,333 \text{ sf}) = 10,232 \#$$

$$F_{2W} = 4,240 \# + (16.0 \text{ psf} \times 201 \text{ sf}) = 7,456 \#$$

$$F_{2E} = 10,232 \# + 39,210 \# \times (2.321 \text{ sf} / 10,229 \text{ sf}) = 18,902 \#$$

$$F_{1W} = 7,456 \# + (16.0 \text{ psf} \times 203 \text{ sf}) = 10,704 \#$$

$$F_{1E} = 18,902 \# + 28,891 \# \times (2.321 \text{ sf} / 10,490 \text{ sf}) = 25,299 \#$$

GRID F

$$F_{3W} = (16.0 \text{ psf} \times 244 \text{ sf}) = 3,904 \#$$

$$F_{3E} = 44,412 \# \times (5.352 \text{ sf} / 11,333 \text{ sf}) = 20,974 \#$$

$$F_{2W} = 3,904 \# + (16.0 \text{ psf} \times 319 \text{ sf}) = 9,008 \#$$

$$F_{2E} = 20,974 \# + 39,210 \# \times (5.077 \text{ sf} / 10,229 \text{ sf}) = 39,938 \#$$

$$F_{1W} = 9,008 \# + (16.0 \text{ psf} \times 320 \text{ sf}) = 14,128 \#$$

$$F_{1E} = 39,938 \# + 28,891 \# \times (5.265 \text{ sf} / 10,490 \text{ sf}) = 54,439 \#$$

GRIDS J-M

$$F_{3W} = (16.0 \text{ psf} \times 226 \text{ sf}) + (9.3 \text{ psf} \times 65 \text{ sf}) = 4,221 \#$$

$$F_{3E} = 44,412 \# \times (3.370 \text{ sf} / 11,333 \text{ sf}) = 13,206 \#$$

$$F_{2W} = 4,221 \# + (16.0 \text{ psf} \times 174 \text{ sf}) = 7,005 \#$$

$$F_{2E} = 13,206 \# + 39,210 \# \times (2.831 \text{ sf} / 10,229 \text{ sf}) = 23,782 \#$$

$$F_{1W} = 7,005 \# + (16.0 \text{ psf} \times 174 \text{ sf}) = 9,789 \#$$

$$F_{1E} = 23,782 \# + 28,891 \# \times (2.904 \text{ sf} / 10,490 \text{ sf}) = 31,780 \#$$

GRID 1 (LEVEL 3) $F_E = 6,027 \#$ 5 SEGMENTS $L = 44"$ $h = 9'$
 $V_E = 6,027 \# / 28.17' = 214 \text{ PIF}$ $L = 4'8"$
 $L = 4'7"$
 $L = 4'4"$
 $L = 10'6"$
 $L_T = 28'2"$

USE $\nabla W1$ $V_{E \text{ ALLOW}} = 242 \text{ PIF} \times (1.25 - 0.125 \times 9' / 4.08') = 236 \text{ PIF}$

HOLD DOWNS

$T_E = 214 \text{ PIF} \times 9' \times 1.25 - 1/2 (15 \text{ PSF} \times 6' \times 204') - 1/2 (120 \text{ PSF} \times 4.5' \times 204') = 2,337 \#$

USE MS ST 40 W/ 2 STUDS $T_{E \text{ ALLOW}} = 3,425 \# \times 1.4 / 1.6 = 2,997 \#$

GRID 1 (LEVEL 2) $F_E = 11,152 \#$ 5 SEGMENTS $L_T = 28'2"$ $h = 9'$

$V_E = 11,152 \# / 28.17' = 396 \text{ PIF}$

USE $\nabla W2$ $V_{E \text{ ALLOW}} = 456 \text{ PIF} \times (1.25 - 0.125 \times 9' / 4.08') = 442 \text{ PIF}$

HOLD DOWNS

$T_E = 396 \text{ PIF} \times 9' \times 1.25 + 2,337 \# - 1/2 (15 \text{ PSF} \times 6' \times 204') - 1/2 (120 \text{ PSF} \times 9' \times 204') = 6,590 \#$

USE MS ST 12 W/ 2 STUDS $T_E = 9,215 \# \times 1.4 / 1.6 = 8,063 \#$

GRID 1 (LEVEL 1) $F_E = 14,931 \#$ 5 SEGMENTS $L_T = 28'2"$ $h = 9'$

$V_E = 14,931 \# / 28.17' = 530 \text{ PIF}$

USE $\nabla W4$ $V_{E \text{ ALLOW}} = 353 \text{ PIF} \times (1.25 - 0.125 \times 9' / 4.08') = 577 \text{ PIF}$

HOLD DOWNS

$T_E = 530 \text{ PIF} \times 9' \times 1.25 + 6,590 \# - 1/2 (15 \text{ PSF} \times 6' \times 204') - 1/2 (120 \text{ PSF} \times 9' \times 204') = 12,351 \#$

USE HD 14-SDS 2.5 W/ 4 DF #2 STUDS $T_{E \text{ ALLOW}} = 14,445 \# \times 1.4 / 1.6 = 12,639 \#$

1/20/2024

C. PIERUCCIONI, PE ETC-BUILDING B

SHEAR

6

CORRIDORS 4/5 = 8/9 (LEVEL 3) FE = 9,299#

2 SEGMENTS L = 25'-8" h = 9'
L = 29'-8"
L = 55'-4"

$$VE = 9,299\# / 55.33' = 168\text{ PLF}$$

USE  VE ALLOW = 242 PLFHOLD DOWNS

$$TE = 168\text{ PLF} \times 9' \times 1.25 - 1/2(15\text{PSF} \times 2' \times 12.93') - 1/2(120\text{PSF} \times 4.5' \times 12.93') = 1,382\#$$

$$\text{USE MST37 W/ 7 STUDS} \quad TE_{\text{ALLOW}} = 2,140\# \times 1.4/1.6 = 1,873\#$$

CORRIDORS 4/5 = 8/9 (LEVEL 2) FE = 16,950#

2 SEGMENTS L = 55'-4" h = 9'

$$VE = 16,950\# / 55.33' = 306\text{ PLF}$$

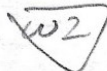
USE  VE ALLOW = 353 PLFHOLD DOWNS

$$TE = 306\text{ PLF} \times 9' \times 1.25 + 1,382\# - 1/2(15\text{PSF} \times 5.7' \times 12.93') - 1/2(120\text{PSF} \times 9' \times 12.93') = 3,587\#$$

$$\text{USE MST60 W/ 2 STUDS} \quad TE_{\text{ALLOW}} = 5,405\# \times 1.4/1.6 = 4,729\#$$

CORRIDORS 4/5 = 8/9 (LEVEL 1) FE = 23,101#

2 SEGMENTS L = 55'-4" h = 9'

$$VE = 23,101\# / 55.33' = 418\text{ PLF}$$

USE  VE ALLOW = 456 PLFHOLD DOWNS

$$TE = 418\text{ PLF} \times 9' \times 1.25 + 3,587\# - 1/2(15\text{PSF} \times 5.7' \times 12.93') - 1/2(120\text{PSF} \times 9' \times 12.93') = 7,043\#$$

$$\text{USE HDU14-SDS25 W/ 3 STUDS} \quad TE_{\text{ALLOW}} = 9,260\# \times 1.4/1.6 = 8,103\#$$

GRID 7 (LEVEL 3) $FE = 10,883^{\#}$ 2 SEGMENTS $L = 27'-4"$ $h = 9'$
 $VE = 10,883^{\#} / 57.08' = 191 \text{ PLF}$; $L = 29'-9"$
 $L_T = 57'-1"$

USE  $VE_{ALLOW} = 242 \text{ PLF}$

HOLD DOWNS

$TE = 191 \text{ PLF} \times 9' \times 1.25 - 1/2 (15 \text{ PSF} \times 1' \times 13.67') = 2,042^{\#}$

USE (2) HD04-SDS2.5 W/ 2 STUDS $TE_{ALLOW} = 3,285^{\#} \times 1.4 / 1.6 = 2,874^{\#}$

GRID 7 (LEVEL 2) $FE = 20,782^{\#}$ 2 SEGMENTS $L = 57'-1"$ $h = 9'$

$VE = 20,782^{\#} / 57.08' = 364 \text{ PLF}$

USE  $VE_{ALLOW} = 456 \text{ PLF}$

HOLD DOWNS

$TE = 364 \text{ PLF} \times 9' \times 1.25 + 2,042^{\#} - 1/2 (15 \text{ PSF} \times 6.83' \times 13.67') = 5,438^{\#}$

USE (2) HD08-SDS2.5 W/ 3 STUDS $TE_{ALLOW} = 6,580^{\#} \times 1.4 / 1.6 = 5,758^{\#}$

GRID 7 (LEVEL 1) $FE = 28,080^{\#}$ 2 SEGMENTS $L_T = 57'-1"$ $h = 9'$

$VE = 28,080^{\#} / 57.08' = 492 \text{ PLF}$

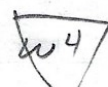
USE  $VE_{ALLOW} = 595 \text{ PLF}$

HOLD DOWNS

$TE = 492 \text{ PLF} \times 9' \times 1.25 + 5,438^{\#} - 1/2 (15 \text{ PSF} \times 6.83' \times 13.67') = 10,272^{\#}$

USE HDV14-SDS2.5 W/ 4 STUDS $TE_{ALLOW} = 12,425^{\#} \times 1.4 / 1.6 = 10,872^{\#}$

GRID B (LEVEL 3) FE = 6,027#

5 SEGMENTS

L = 4'-7" h = 9'

L = 4'-8"

L = 4'-2"

L = 4'-9"

L = 10'-6"

L = 28'-3"

$$VE = 6,027\# / 28.67' = 210\text{PIF}$$

$$\text{USE } \triangle W1 \quad VE_{ALLOW} = 242\text{PIF} \times (1.25 - 0.125 \times 9' / 4.17') = 237\text{PIF}$$

HOLD DOWNS

$$TE = 210\text{PIF} \times 9' \times 1.25 - 1/2(15\text{PSF} \times 1' \times 2.08') - 1/2(12\text{PSF} \times 4.5' \times 2.08') = 2,291\#$$

$$\text{USE } \triangle \text{MST 48 W/ 2 STUDS} \quad TE_{ALLOW} = 3,425\# \times 1.4 / 1.6 = 2,997\#$$

GRID B (LEVEL 2) FE = 11,152#

5 SEGMENTS

L = 28'-8" h = 9'

$$VE = 11,152\# / 28.67' = 389\text{PIF}$$

$$\text{USE } \triangle W3 \quad VE_{ALLOW} = 456\text{PIF} \times (1.25 - 0.125 \times 9' / 4.17') = 447\text{PIF}$$

HOLD DOWNS

$$TE = 389\text{PIF} \times 9' \times 1.25 + 2,291\# - 1/2(15\text{PSF} \times 6' \times 2.08') - 1/2(12\text{PSF} \times 9' \times 2.08') = 6,461\#$$

$$\text{USE } \triangle \text{CM ST 12 W/ 2 STUDS} \quad TE_{ALLOW} = 9,215\# \times 1.4 / 1.6 = 8,063\#$$

GRID B (LEVEL 1) FE = 14,931#

5 SEGMENTS

L = 28'-8" h = 9'

$$VE = 14,931\# / 28.67' = 521\text{PIF}$$

$$\text{USE } \triangle W4 \quad VE_{ALLOW} = 595\text{PIF} \times (1.25 - 0.125 \times 9' / 4.17') = 583\text{PIF}$$

HOLD DOWNS

$$TE = 521\text{PIF} \times 9' \times 1.25 + 6,461\# - 1/2(15\text{PSF} \times 6' \times 2.08') - 1/2(12\text{PSF} \times 9' \times 2.08') = 12,116\#$$

$$\text{USE } \triangle \text{HDU 14-SDS 2.5 W/ 4 OF #2 STUDS} \quad TE_{ALLOW} = 19,445\# \times 1.4 / 1.6 = 12,639\#$$

0956

GRIDS A-C (LEVEL 3) FE = 10,232#

13 SEGMENTS L = 3'-40" L = 5'-10" h = 9'

$$VE = 10,232\# / 75.58' = 135\text{PIF}$$

$$\text{USE } \boxed{W11} \quad VE = 242\text{PIF} \times (1.25 - 0.125 \times 9' / 3.93') = 231\text{PIF}$$

HOLD DOWNS

$$TE = 135\text{PIF} \times 9' \times 1.25 - \frac{1}{2} (25\text{PIF} \times 2' \times 1.92') - \frac{1}{2} (12\text{PIF} \times 4.5' \times 1.92') = 1,419\#$$

$$\boxed{\text{USE MST37 w/ 2 STUDS}} \quad TE_{\text{ALLOW}} = 2,140\# \times 1.4 / 1.6 = 1,873\#$$

GRIDS A-C (LEVEL 2) FE = 18,902#

13 SEGMENTS L = 7'-7" h = 9'

$$VE = 18,902\# / 75.58' = 250\text{PIF}$$

$$\text{USE } \boxed{W12} \quad VE_{\text{ALLOW}} = 353\text{PIF} \times (1.25 - 0.125 \times 9' / 3.93') = 337\text{PIF}$$

HOLD DOWNS

$$TE = 250\text{PIF} \times 9' \times 1.25 + 1,419\# - \frac{1}{2} (12\text{PIF} \times 9' \times 1.92') = 4,128\#$$

$$\boxed{\text{USE MST60 w/ 2 STUDS}} \quad TE_{\text{ALLOW}} = 5,405\# \times 1.4 / 1.6 = 4,729\#$$

GRIDS A-C (LEVEL 1) FE = 25,294#

13 SEGMENTS L = 7'-7" h = 9'

$$VE = 25,294\# / 75.58' = 335\text{PIF}$$

$$\text{USE } \boxed{W12} \quad VE_{\text{ALLOW}} = 353\text{PIF} \times (1.25 - 0.125 \times 9' / 3.93') = 337\text{PIF}$$

HOLD DOWNS

$$TE = 335\text{PIF} \times 9' \times 1.25 + 4,128\# - \frac{1}{2} (12\text{PIF} \times 9' \times 1.92') = 7,789\#$$

$$\boxed{\text{USE HDU14-SDS 7.5 w/ 3 STUDS}} \quad TE_{\text{ALLOW}} = 9,260\# \times 1.4 / 1.6 = 8,103\#$$

1/10/2024

C. P. ERUCCIONI, PE

ETC - BUILDING B

SHEAR

10

GRID F (LEVEL 3) FE = 20,974# 4 SEGMENTS L = 30'-4" h = 9'

$$VE = 20,974\# / 92' = 228\text{PIF}$$

USE  VE ALLOW = 242PIF

$$\begin{aligned} L &= 30'-4" \\ L &= 15'-8" \\ L &= 15'-8" \\ L &= 30'-4" \\ L &= 92'-0" \end{aligned}$$

HOLD DOWNS

$$TE = 228\text{PIF} \times 9' \times 1.25 - 1/2(25\text{PSF} \times 16.75' \times 7.93') - 1/2(12\text{PSF} \times 4.5' \times 7.93') = 714\#$$

USE 1 MST37 W / 2 STOPS

OR (2) HD02-SDS25 W / 2 STOPS

$$TE ALLOW = 2,140\# \times 1.4 / 1.6 = 1,873\#$$

$$TE ALLOW = 2,215\# \times 1.4 / 1.6 = 2,067\#$$

GRID F (LEVEL 2) FE = 39,939# 4 SEGMENTS L = 92'-0" h = 9'

$$VE = 39,939\# / 92' = 434\text{PIF}$$

USE  VE ALLOW = 456PIF

HOLD DOWNS

$$TE = 434\text{PIF} \times 9' \times 1.25 + 714\# = 5,598\#$$

USE 1 MST72 W / 2 STOPS

OR 1 HD08-SDS25 W / 3 STOPS

$$TE ALLOW = 6,475\# \times 1.4 / 1.6 = 5,666\#$$

$$TE ALLOW = 6,580\# \times 1.4 / 1.6 = 5,753\#$$

GRID F (LEVEL 1) FE = 54,439# 4 SEGMENTS L = 92'-0" h = 9'

$$VE = 54,439\# / 92' = 592\text{PIF}$$

USE  VE ALLOW = 595PIF

HOLD DOWNS

$$TE = 592\text{PIF} \times 9' \times 1.25 + 5,598\# = 12,255\#$$

USE HD014-SDS25 W / 4 DR#2 STOPS

$$TE ALLOW = 14,445\# \times 1.4 / 1.6 = 12,639\#$$

1/10/2024

C. PIERUCI DAL, AE

ETC-BUILDINGS B

SHEAR

U

GRIDS J-M (LEVEL 3) FE = 13,206#

14 SEGMENTS

L=7'-7"	L=6'-11"
L=9'-2"	L=3'-3"
L=4'-7"	L=2'-11"
L=4'-0"	L=3'-2"
L=3'-2"	L=3'-11"
L=2'-11"	L=4'-7"
L=3'-3"	L=9'-2"
LT = 68'-7"	

b=9'

VE = 13,206# / 68.58' = 193PIF

USE W1 VE ALLOW = 242PIF x (1.25 - 0.125 x 9'/2.92') = 209PIF

HOLD DOWNS

TE ALLOW = 193PIF x 9' x 1.25 - 1/2 (25PIF x 2' x 1.46') - 1/2 (12PIF x 4.5' x 1.46') = 2095#

USE MST 48 W/ 2 STOPS TE ALLOW = 3,425# x 1.4/1.6 = 2997#

GRIDS J-M (LEVEL 2) FE = 23,792#

14 SEGMENTS

LT = 68'-7" b=9'

VE = 23,792# / 68.58' = 347PIF

USE W3 VE ALLOW = 450PIF x (1.25 - 0.125 x 9'/2.92') = 394PIF

HOLD DOWNS

TE = 347PIF x 9' x 1.25 + 2095# - 1/2 (12PIF x 9' x 1.46') = 5920#

USE CM ST 12 W/ 2 STOPS TE ALLOW = 925# x 1.4/1.6 = 8,063#

GRIDS J-M (LEVEL 1) FE = 31,780#

14 SEGMENTS

LT = 68'-7" b=9'

VE = 31,780# / 68.58' = 463PIF

USE W4 VE ALLOW = 595PIF x (1.25 - 0.125 x 9'/2.92') = 515PIF

HOLD DOWNS

TE ALLOW = 463PIF x 9' x 1.25 + 5920# - 1/2 (12PIF x 9' x 1.46') = 11,054#

USE HDU 14 - SRS 2.5 W/ 4 DPT 2 STOPS TE ALLOW = 14,445# x 1.4/1.6 = 12,639#