



B A R G H A U S E N

Operation & Maintenance Manual

Fortress - Puyallup

PREPARED BY

Barghausen Consulting
Engineers
18215 72nd Ave. South
Kent, WA 98032

PREPARED FOR

CREF3 Puyallup, LLC

CLIENT ADDRESS

11611 San Vicente Blvd, 10th Floor
Los Angeles, CA 90049

SITE ADDRESS

240 15th Street SE
Puyallup, WA 98372

JURISDICTION

City of Puyallup

DATE

Rev. March 5, 2024
Rev. Dec. 08, 2023
July 27, 2023

PROJECT NO.

22085

1.0 STORMWATER OPERATIONS AND MAINTENANCE SUMMARY

The proposed Fortress - Puyallup project is located on a 7.84-acre site located in the City of Puyallup, Washington. The project address is 240 15th Street SE, Puyallup, WA 98372 with the parcel numbers being 0420274126, 7845000161, and 7845000170. The site is located northwest of the intersection of 15th Street SE and East Pioneer Way.

The site has a drainage system that needs periodic maintenance in order to function properly. This report describes the storm drainage system and delineates operation and maintenance responsibilities and requirements for the site.

The design of the drainage facilities discussed in this manual can be found in the Fortress – Puyallup project construction drawings and stormwater site plan on file with the City of Puyallup.

The site is approximately 7.84 acres in size. The purpose of this manual is to address maintenance of stormwater facilities installed with the Fortress - Puyallup project. These facilities are intended to detain and treat the runoff from the graded site. The developed runoff from the west portion of the site will be collected and conveyed to both water quality and detention vaults prior to discharge into the public stormwater system draining to East Main Street. The east part of the site will be collected and discharged through a water quality vault to the 15th Street SE system that drains to a wetland.

2.0 PLAN GOAL

The specific purpose of the storm water facilities is to minimize pollution that is typically associated with modern development. Stormwater runoff contains pollutants harmful to humans and aquatic life. The majority of pollution is generated by motor vehicles and lawn / landscape maintenance.

3.0 MAINTENANCE AND OPERATIONAL RESPONSIBILITIES

Owners/Tenants have the following Operations and Maintenance responsibilities, which include:

- I. Inspection and maintenance of all on-site drainage facility components (catch basins, fencing, storm manholes, pipes, vaults, and ponds) at least twice annually:
 - A. Remove accumulated sediment and debris from all pipes, structures, ponds and vaults (any debris and/or sediment collected shall be disposed of in accordance with applicable State and Federal requirements).
 - B. Inspect and repair any damage, including; cracks, unsealed joints and pipes that deviate from their design shape
 - C. Maintain access points including manhole hole lids, grates and ladders
 - D. Debris and leaves shall be removed from catch basin grates
 - E. Control structures shall be kept in good repair and ensure that the outlet orifice is unobstructed
 - F. General site surroundings:
 - 1) Maintaining good housekeeping practices on the site will reduce the amount of trash, debris, and sediment that reaches the storm system.

- 2) The owner, tenants and anyone doing landscaping on the property must be careful to avoid introducing landscape fertilizer to receiving waters or groundwater.

The operation and maintenance of all stormwater facilities shall be completed pursuant to the standards and requirements of the 2019 Stormwater Management Manual for Western Washington and any additional manufacturer's guidance. Additional information is included in the following pages for reference.

4.0 REPORTING

The above maintenance activities will be documented each year and kept in a log book. Maintenance logs shall be made available to the City of Puyallup upon request. This manual and the logs should be kept on-site, preferably in an office belonging to the person tasked with ensuring the system is function as intended. This manual shall be transferred to the new property owner if the property is sold.

5.0 RESPONSIBLE PARTY/ORGANIZATION

Fortress Investment Group, Inc.
11611 San Vicente Blvd, 10th Floor
Los Angeles, CA 90049

INSPECTION/MAINTENANCE CHECKLIST

The items in this checklist will be inspected at least twice per year and maintenance performed as necessary. Refer to the Maintenance Standards included in this manual for a detailed list of inspection tasks and descriptions of when maintenance is required to be performed.

STRUCTURE/ FACILITY	DATE OF INSPECTION MAINTENANCE			
	Maintenance Standard(s)	RESULTS/ MAINTENANCE	DATE	COMMENTS
Detention Vault	Sediment/Debris Damage Outlet Riser Access Riser	Inspection Results		
		Maintenance Done		
WQ#1 Biopod	Sediment/Debris Damage Grate	Inspection Results		
		Maintenance Done		
WQ#2 Biopod	Sediment/Debris Damage Grate	Inspection Results		
		Maintenance Done		
Catch basins and piping	Sediment/Debris Damage Grate	Inspection Results		
		Maintenance Done		
General Site	Landscaping Trash Fertilizer Use	Inspection Results		
		Maintenance Done		

I hereby certify that the above noted inspections and maintenance was performed in accordance with the approved Operations and Maintenance Manual for the Fortress - Puyallup project, Puyallup, Washington.

Signature

Date

Title

PORTION OF SE QUARTER OF SEC 27, TWN 20 N, RGE. 4 E, W.M.
CITY OF PUYALLUP, PIERCE COUNTY, WASHINGTON
GRADING AND DRAINAGE PLAN

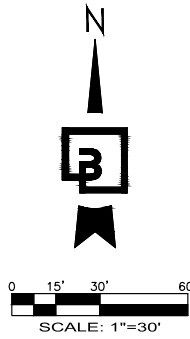

STORM DETENTION VAULT
100'x168' + 40'x204' x 8' HEIGHT
INSIDE CLEAR DIMENSIONS
MIN INSIDE TOP ELEV=56.5
MAX WS=55.5
STATIC WS=50.2
INSIDE BOTTOM=49.2±
5.3' LIVE STORAGE. SEE SHT C12
NOTE: MANHOLES/ACCESSES SHOWN APPROX. AND SHALL BE PER STRUCTURAL DESIGN FOR ACCESS REQUIREMENTS

EX. CB STD GRT
RIM=52.97'
12" ADS SE IE=51.07'
12" ADS NW IE=50.97'

WESTECH REALTY CO LLC
TAX PARCEL NO.
7845100327

"LOCK-N-LOAD" RETAINING WALL
W/PEDESTRIAN AND VEHICULAR FALL
PROTECTION. (PER SEPARATE GEOTECH
PLANS AND BUILDING PERMIT)

REMOVE EX. 8" S. CORE DRILL
AND INSTALL NEW 12" (S)
IE=49.53

ESTES DEVELOPMENT LLC
TAX PARCEL NO.
0420274115

1300 MAIN ST LLC
TAX PARCEL NO.
7845000141

6" SOLID PVC TO CONNECT THE
PERFORATED WALL DRAIN TO THE
12" STORM DRAIN
IE @ WALL=55.0
IE @ PIPE = 50.0±

SDCO#14
99 LF 15" CPEP PIPE
SD @ 0.50%

SDCO#13
85 LF 8" PVC PIPE SD
@ 1.00%

SDCO#15
63 LF 8" PVC PIPE SD
@ 0.96%

SDCO#4A
62 LF 8" PVC PIPE SD
@ 1.00%

SDCO#4
56 LF 8" PVC PIPE SD
@ 1.00%

SDCO#3
52 LF 8" PVC PIPE SD
@ 1.00%

SDCO#13
RIM=61.03
IE=58.50 (8" W)

SDCO#14
RIM=60.39
IE=57.65 (8" E)
IE=57.65 (8" S)

SDCO#15
RIM=60.75
IE=55.40 (8" N)
IE=55.40 (8" W)

WQ #1, BPU-816B
RIM=60.39
IE=50.70 (18" E)
IE=50.20 (18" W)

CATCH BASINS	
CB #1, TYPE 2-54" CONTROL STRUCTURE W/SOLID LOCKING LID RIM=60.86 IE=50.20 (12" W) IE=50.20 (12" N)	
CB #2, TYPE 1, W/STANDARD GRATE RIM=57.80 IE=53.48 (12" W) IE=53.48 (15" E)	
CB #3, TYPE 2-48" W/STANDARD GRATE RIM=59.21 IE=51.80 (12" E) IE=51.80 (15" W) IE=51.80 (18" N)	
CB #9, TYPE 2-48" W/STANDARD GRATE RIM=59.40 IE=51.18 (18" S) IE=51.18 (18" N)	
CB #10, TYPE 2-48" W/STANDARD GRATE RIM=59.79 IE=51.32 (15" E) IE=51.32 (15" SW)	
CB #17, TYPE 1, W/STANDARD GRATE RIM=57.10 IE=54.00 (12" N) IE=54.00 (12" E)	
CB #18, TYPE 1, W/STANDARD GRATE RIM=58.63 IE=54.56 (12" NW) IE=54.56 (12" S)	
CB #19, TYPE 1, W/STANDARD GRATE RIM=58.43 IE=55.00 (12" SE)	
CB #20, TYPE 2-48" W/SOLID LOCKING LID RIM=60.35 IE=50.83 (15" NE) IE=50.83 (18" S) IE=50.83 (18" W)	
SDCO#3, RIM=59.49 IE=54.80 (8" E) IE=54.80 (8" W)	
SDCO#4, RIM=59.56 IE=54.24 (8" E) IE=54.24 (8" N)	
SDCO#4A, RIM=60.77 IE=53.72 (8" S) IE=53.72 (8" W)	
SDCO#13, RIM=61.03 IE=58.50 (8" W)	
SDCO#14, RIM=60.39 IE=57.65 (8" E) IE=57.65 (8" S)	
SDCO#15, RIM=60.75 IE=55.40 (8" N) IE=55.40 (8" W)	
WQ #1, BPU-816B RIM=60.39 IE=50.70 (18" E) IE=50.20 (18" W)	

STORM CROSSING TABLE:

- UTILITY CROSSING
IE 8" SD=53.54
T/P 18" SD=53.1
SEPARATION=0.44'
- UTILITY CROSSING
IE 8" SD=55.10
T/P 18" SD=52.40
SEPARATION=3.20'

WALL NOTES:

- (WALL DESIGN PER SEPARATE PLANS AND BUILDING PERMIT).
- WALL DESIGN NEEDS TO BE SUBMITTED TO THE OWNER AND THE ENGINEER/CITY FOR REVIEW AND APPROVAL.
 - WALL DESIGNS OVER 4- FEET HIGH REQUIRE A SEPARATE BUILDING PERMIT AND ENGINEERING DESIGN.
 - WALLS OVER 30-INCHES HIGH, WHERE TOP OF WALL IS ADJACENT TO PEDESTRIAN OR VEHICULAR PATHWAY(S), NEED TO INCLUDE PEDESTRIAN AND/OR VEHICULAR FALL PROTECTION. THE FALL PROTECTION SHALL BE DESIGNED, PERMITTED, PROVIDED BY, AND INSTALLED BY CONTRACTOR.
 - THE DIMENSIONS SHOWN ON THE PLAN ARE THE BASIS OF WALL PLACEMENT. DIMENSIONS ARE SHOWN TO THE FACE OF WALL AT THE EXPOSED GRADE. CONTRACTOR SHALL USE A CURRENT CAD FILE FROM BARGHAUSEN CONSULTING ENGINEERS, INC. TO STAKE THE FACE OF WALL LOCATION.
 - THE TYPE OF WALL CHOSEN WILL DETERMINE THE WALL WIDTH, BATTER, AND IF GEOGRID IS NECESSARY.
 - THE WALL HEIGHT SHOWN ON THE PLANS IS AN ESTIMATED MAXIMUM HEIGHT. TOP OF WALL ELEVATIONS PROVIDED ARE TO THE TOP OF EXPOSED FACE OF WALL, NOT INCLUDING ANY PEDESTRIAN OR VEHICULAR BARRIER IF NECESSARY. BOTTOM OF WALL ELEVATIONS PROVIDED ARE TO THE BOTTOM OF THE EXPOSED FACE OF WALL (AND NOT TO WALL FOOTING). THE WALL ELEVATIONS PROVIDED ON THE PLANS ARE PROVIDED AT UNIFORM LOCATIONS AND DO NOT NECESSARILY REPRESENT ALL OF THE WALL ELEVATION CHANGES. WALL PROFILES ARE REQUIRED TO BE PART OF THE DESIGN/BUILD OR STRUCTURAL DESIGN PLANS. WALL PROFILES MAY RESULT IN HIGHER OVERALL WALL HEIGHTS.
 - COORDINATION BETWEEN WALL DESIGN AND THE CONSTRUCTION DRAWINGS NEEDS TO OCCUR PRIOR TO CONSTRUCTION TO CONFIRM WALL LOCATION IN PLAN VIEW, DRAINAGE REQUIREMENTS, ETC.

GRADING AND DRAINAGE PLAN
FORTRESS - PUYALLUP

CREF3 PUYALLUP OWNER LLC
11611 SAN VICENTE BLVD
10TH FLOOR
LOS ANGELES, CA 90049



Scale:	Horizontal	1"=30'	Vertical	N/A
Designed	DL		Approved	JGL
Drawn	RDC		Checked	JGL
Date		6/23/23		

Barghausen Consulting Engineers, Inc.
18215 72nd Avenue South
Kent, WA 98032
425.251.6222
barghausen.com



Job Number: **22085**
Sheet: **C7** of **34**

APPROVED

BY: _____
CITY OF PUYALLUP
DEVELOPMENT ENGINEERING

DATE: _____

NOTE: THIS APPROVAL IS VOID AFTER 180 DAYS FROM APPROVAL DATE. THE CITY WILL NOT BE RESPONSIBLE FOR ERRORS AND/OR OMISSIONS ON THESE PLANS. FIELD CONDITIONS MAY DICTATE CHANGES TO THESE PLANS AS DETERMINED BY THE DEVELOPMENT ENGINEERING MANAGER.



Know what's below.
Call before you dig.
Dial 811

PORTION OF SE QUARTER OF SEC 27, TWN 20 N, RGE. 4 E, W.M.
CITY OF PUYALLUP, PIERCE COUNTY, WASHINGTON
GRADING AND DRAINAGE PLAN

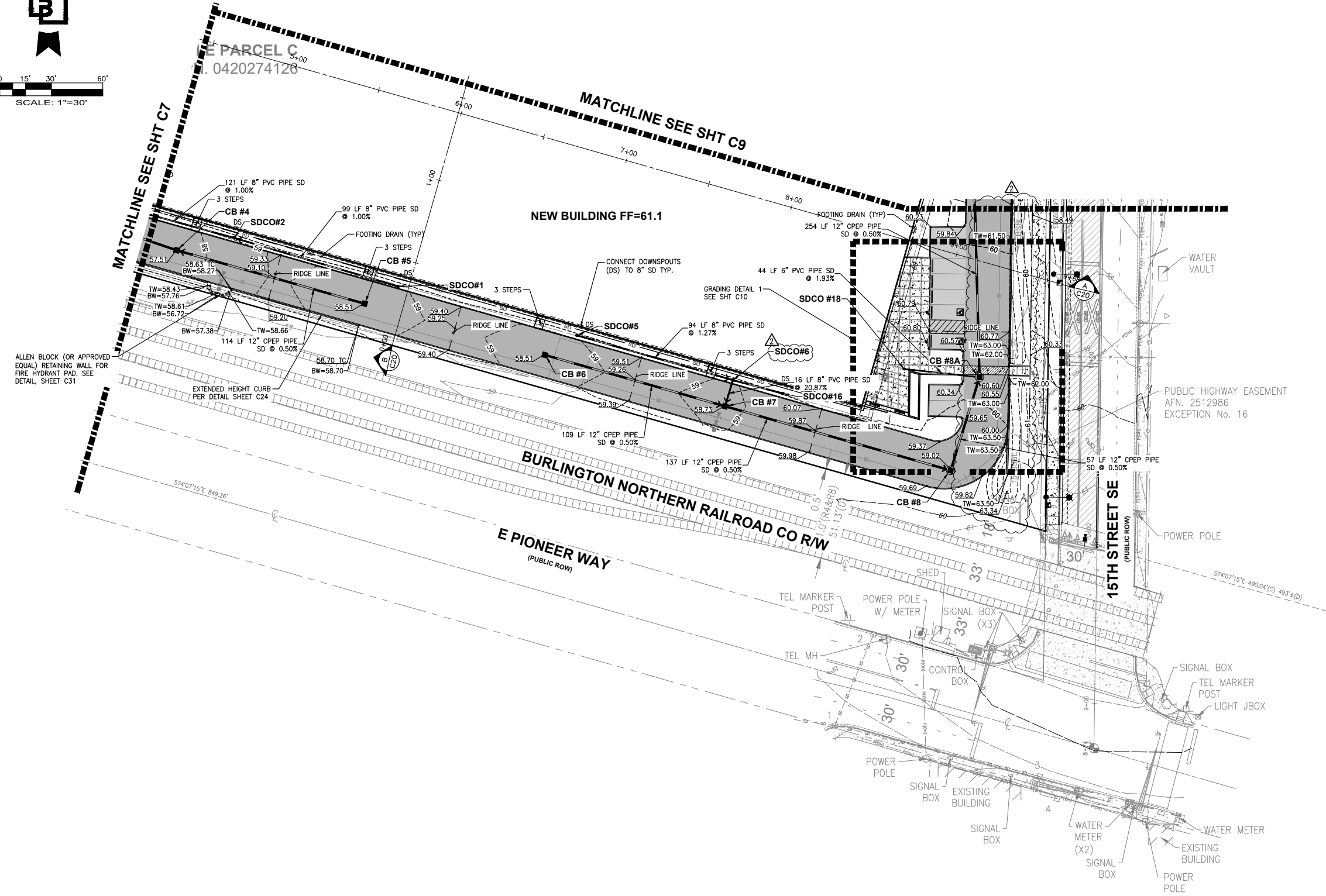
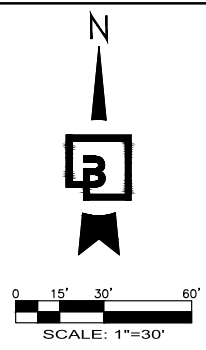

CATCH BASINS	
CB #4, TYPE 1, W/STANDARD GRATE RIM=57.50 IE=53.93 (12" E) IE=53.93 (12" W)	
CB #5, TYPE 1, W/STANDARD GRATE RIM=58.50 IE=54.50 (12" W)	
CB #6, TYPE 1, W/STANDARD GRATE RIM=58.50 IE=54.50 (12" E)	
CB #7, TYPE 1, W/STANDARD GRATE RIM=58.73 IE=53.95 (12" W) IE=54.28 (8" N) IE=53.95 (12" E)	
CB #8, TYPE 2-48" W/STANDARD GRATE RIM=59.00 IE=53.27 (12" W) IE=53.27 (12" N)	
CB #8A, TYPE 2-48" W/SOLID LOCKING LID RIM=60.45 IE=52.99 (12" S) IE=57.00 (6" W) IE=52.99 (12" N)	
SDCO #18, PLANTER DRAIN RIM=60.85 IE=57.85 (6" E)	
SDCO#1, RIM=59.34 IE=57.00 (8" W)	
SDCO#2, RIM=59.40 IE=56.01 (8" E) IE=56.01 (8" W)	
SDCO#5, RIM=59.69 IE=58.80 (8" E)	
SDCO#6, RIM=59.58 IE=57.60 (8" W) IE=57.60 (8" E) IE=57.60 (8" S)	
SDCO#16, RIM=60.10 IE=57.10 (8" W)	

2 03/05/24 DL JSG RESPONSE TO CITY COMMENTS, DATED FEBRUARY 06, 2024
02/27/24 DL JSG BID SET
1 12/06/23 DL JSG RESPONSE TO CITY COMMENTS, DATED 10-06-2023
No. Date By Ckd. Appr. Revision

Title: **GRADING AND DRAINAGE PLAN**
For: **CREF3 PUYALLUP OWNER LLC
11611 SAN VICENTE BLVD
10TH FLOOR
LOS ANGELES, CA 90049**



Scale: Horizontal 1"=30' Vertical N/A
Designed DL
Drawn BDC
Checked DL
Approved JGL
Date 8/23/23

Barghausen Consulting Engineers, Inc.
18215 72nd Avenue South
Kent, WA 98032
425.251.6222
barghausen.com

APPROVED
BY: CITY OF PUYALLUP
DEVELOPMENT ENGINEERING
DATE: _____
NOTE: THIS APPROVAL IS VOID AFTER 180 DAYS FROM APPROVAL DATE.
THE CITY WILL NOT BE RESPONSIBLE FOR ERRORS AND/OR OMISSIONS ON THESE PLANS.
FIELD CONDITIONS MAY DICTATE CHANGES TO THESE PLANS AS DETERMINED BY THE DEVELOPMENT ENGINEERING MANAGER.



Job Number: **22085**
Sheet: **C8** of **34**

PORTION OF SE QUARTER OF SEC 27, TWN 20 N, RGE. 4 E, W.M.
CITY OF PUYALLUP, PIERCE COUNTY, WASHINGTON
GRADING AND DRAINAGE PLAN

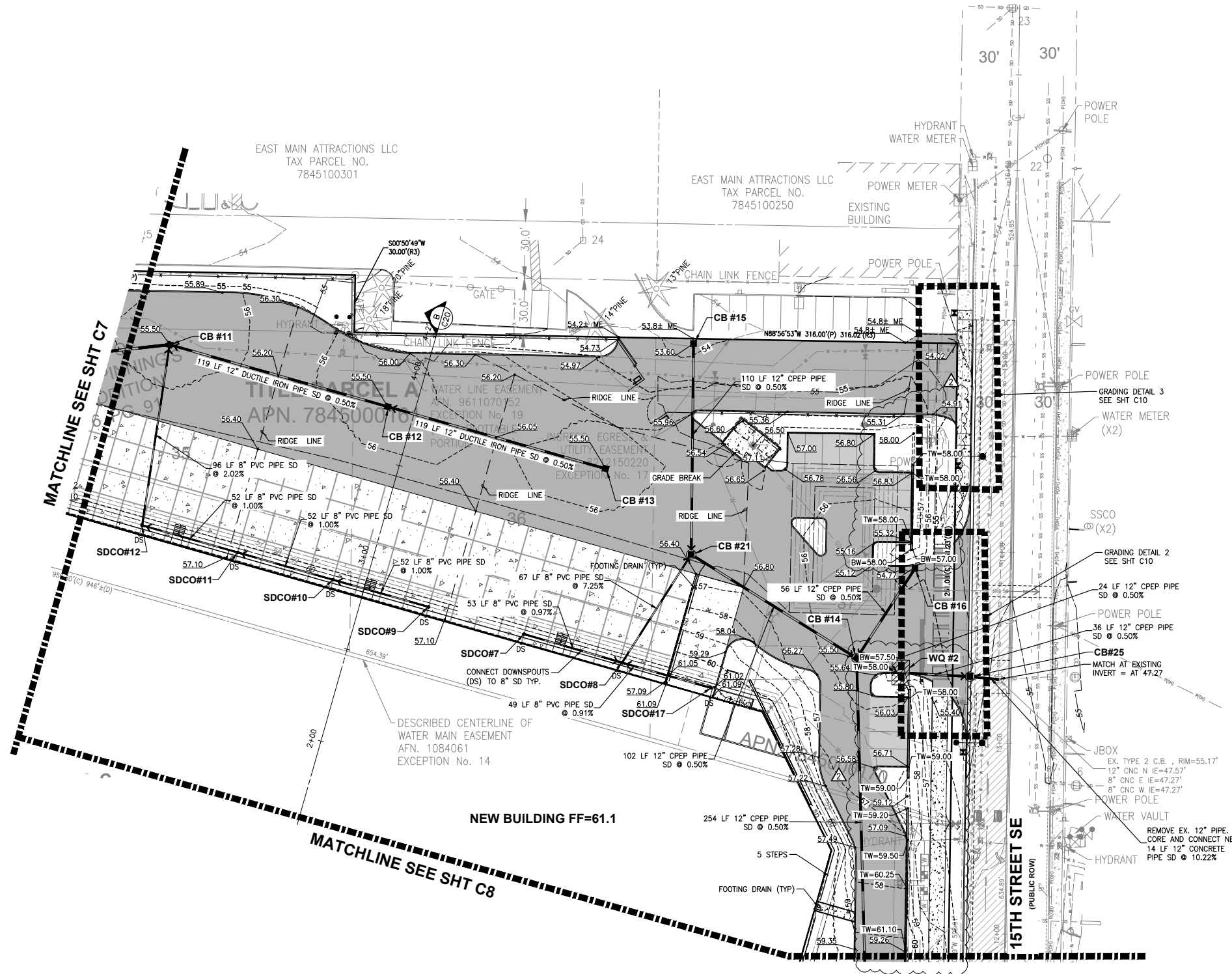
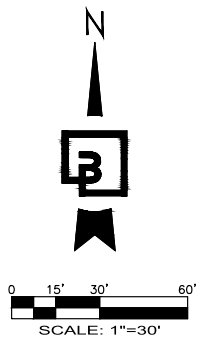

CATCH BASINS	
CB #11, TYPE 1, W/STANDARD GRATE RIM=55.50 IE=52.17 (12" E) IE=52.17 (8" S) IE=52.17 (15" W)	
CB #12, TYPE 1, W/STANDARD GRATE RIM=55.50 IE=52.76 (12" E) IE=52.76 (12" W)	
CB #13, TYPE 1, W/STANDARD GRATE RIM=55.50 IE=53.35 (12" W)	
CB #14, TYPE 2-48" W/STANDARD GRATE RIM=55.50 IE=51.73 (12" S) IE=49.54 (12" NW) IE=51.35 (12" NE) IE=49.54 (12" E)	
CB #15, TYPE 1, W/STANDARD GRATE RIM=53.60 IE=50.60 (12" S)	
CB #16, TYPE 1, W/STANDARD GRATE RIM=54.78 IE=51.63 (12" SW)	
CB #21, TYPE 2-48" W/SOLID LOCKING LID RIM=56.46 IE=50.05 (12" N) IE=50.38 (8" SW) IE=50.05 (12" SE)	
CB#25, TYPE 2-48" W/STD. GRATE RIM=54.64 IE=48.74 (12" W) IE=48.74 (12" E)	
SDCO#7, RIM=57.05 IE=55.78 (8" E)	
SDCO#8, RIM=57.05 IE=55.26 (8" W) IE=55.26 (8" E) IE=55.26 (8" NE)	
SDCO#9, RIM=57.05 IE=55.66 (8" W)	
SDCO#10, RIM=57.05 IE=55.14 (8" E) IE=55.14 (8" W)	
SDCO#11, RIM=57.05 IE=54.62 (8" E) IE=54.62 (8" W)	
SDCO#12, RIM=57.05 IE=54.10 (8" E) IE=54.10 (8" N)	
SDCO#17, RIM=61.04 IE=55.70 (8" W)	
WQ #2, 6X12IB RIM=55.43 IE=49.42 (12" W) IE=48.92 (12" E)	

No.	Date	By	Chd.	Appr.	Revision
2	03/05/24	DL	JSG	JSG	RESPONSE TO CITY COMMENTS, DATED FEBRUARY 06, 2024
1	02/27/24	DL	JSG	JSG	BID SET
1	12/06/23	DL	JSG	JSG	RESPONSE TO CITY COMMENTS, DATED 10-06-2023

Title: **GRADING AND DRAINAGE PLAN**
FORTRESS - PUYALLUP

For: **CREF3 PUYALLUP OWNER LLC**
11611 SAN VICENTE BLVD
10TH FLOOR
LOS ANGELES, CA 90049



Scale:	Horizontal	1"=30'	Vertical	N/A					
Designed	DL	Drawn	RDC	Checked	DL	Approved	JGL	Date	6/23/23

Barghausen Consulting Engineers, Inc.
18215 72nd Avenue South
Kent, WA 98032
425.251.6222
barghausen.com

APPROVED
BY: _____
CITY OF PUYALLUP
DEVELOPMENT ENGINEERING
DATE: _____
NOTE: THIS APPROVAL IS VOID AFTER 180 DAYS FROM APPROVAL DATE. THE CITY WILL NOT BE RESPONSIBLE FOR ERRORS AND/OR OMISSIONS ON THESE PLANS. FIELD CONDITIONS MAY DICTATE CHANGES TO THESE PLANS AS DETERMINED BY THE DEVELOPMENT ENGINEERING MANAGER.



Job Number: **22085**
Sheet: **C9** of **34**

VAULT DETAILS

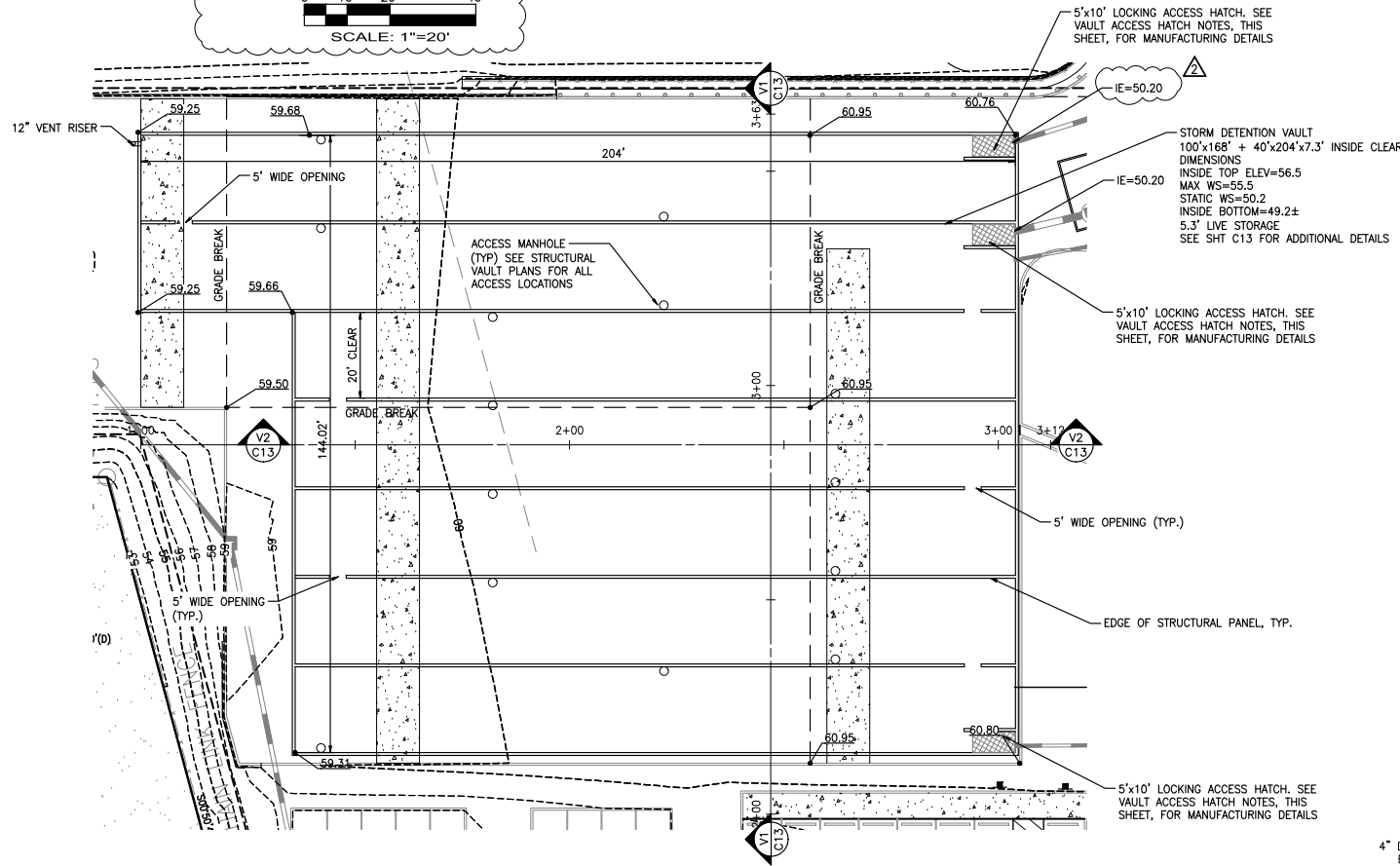
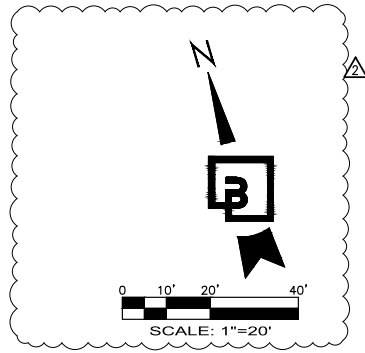

VAULT DETAIL 1

1"=20'

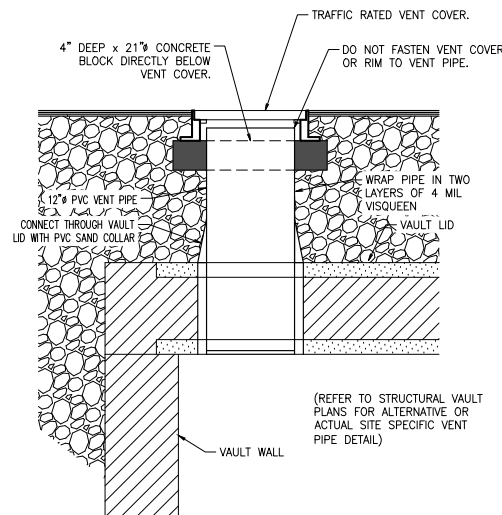

VENTILATION PIPE DETAIL

NOT TO SCALE

VAULT NOTES:

1. VENTILATION PIPES (MIN. 12" DIAMETER OR EQUIVALENT) SHALL BE PROVIDED IN ALL CORNERS OF THE VAULT TO ALLOW FOR VENTILATION PRIOR TO ENTRY OF MAINTENANCE PERSONNEL INTO VAULT. VENTILATION PIPES ENTER THROUGH THE VAULT LID. PROVIDE LOCKING LIDS FLUSH WITH FINISH GRADE USING CLEANOUT.
2. WHERE PIPES ENTER AND LEAVE THE VAULT BELOW THE DESIGNED MAX WATER SURFACE, THEY SHALL BE SEALED USING A NON-POROUS, NON-SHRINKING GROUT.
3. ACCESS LOCATIONS, VAULT DESIGN AND WALL OPENINGS ARE PER THE STRUCTURAL DRAWING AND THE LOCATIONS ARE SHOWN FOR REFERENCE ONLY.
4. INSTALL CONFINED SPACE PLACARD AT ALL ACCESS POINTS TO THE VAULT.
5. CONTRACTOR SHALL SUBMIT MATERIAL SUBMITTALS FOR REVIEW AND APPROVAL PRIOR TO CONSTRUCTION.

VAULT ACCESS HATCH NOTES:

1. PROVIDE H-20 (MIN) TRAFFIC RATED 5'x10' LOCKING, PERSONAL 2-DOOR SOLID ACCESS HATCH.
2. FRAME AND HATCH COVER SHALL BE DESIGNED FOR 150 PSF LIVE LOAD.
3. A SPRING-ASSISTED LIFT WITH HOLD-OPEN FEATURE TORSION BARS SHALL BE INSTALLED. AUTOMATIC HOLD-OPEN ARM WITH GRIP HANDLE RELEASE SHALL BE ADDED.
4. POLYPROPYLENE RUNGS OR LADDER SHALL BE INSTALLED EXTENDING FROM THE HATCH TO THE BOTTOM OF THE VAULT.
5. A LADDER-UP MECHANISM SHALL BE INSTALLED CENTERED OVER THE RUNGS OR LADDER BELOW THE HATCH.
6. ALL HARDWARE SHALL BE ZINC-COATED.

VAULT ACCESS OPENINGS NOTES:

1. IN ADDITION TO THE HATCHES SHOWN, VAULT ACCESS OPENINGS MUST BE PROVIDED SUCH THAT NO LOCATION WITHIN THE VAULT IS MORE THAN 50 FEET FROM AN ACCESS OPENING. ACCESS TO EACH "V" ON THE VAULT FLOOR MUST BE PROVIDED.
2. ACCESS OPENINGS MUST HAVE ROUND, SOLID LOCKING LIDS, OR 3 FOOT SQUARE, LOCKING DIAMOND PLATE COVERS.

DETENTION VAULT DATA:

MIN INSIDE TOP OF VAULT ELEV=	56.7
MAX W.S. ELEV=	55.5
STATIC W.S. ELEV=	50.2
SEE THIS SHEET AND C13 FOR DETAILS.	
DETENTION VAULT:	
LIVE STORAGE VOLUME REQUIRED=	143,488 C.F.
LIVE STORAGE VOLUME PROVIDED=	143,488 C.F.
AS-BUILT DETENTION VOLUME CONSTRUCTED=	_____ C.F.

No.	Date	By	Chd.	Appr.	Revision
2	03/05/24	DL	DL	JSG	RESPONSE TO CITY COMMENTS, DATED FEBRUARY 06, 2024
1	12/06/23	DL	DL	JSG	BID SET RESPONSE TO CITY COMMENTS, DATED 10-06-2023

VAULT DETAILS

FORTRESS - PUYALLUP

FOR: CREF3 PUYALLUP OWNER LLC
11611 SAN VICENTE BLVD
10TH FLOOR
LOS ANGELES, CA 90049

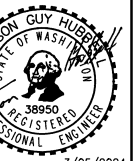

3/05/2024

Scale: Horizontal 1"=10' Vertical N/A

Designed: DL, Drawn: RDC, Checked: DL, Approved: JGL, Date: 8/23/23

Barghausen Consulting Engineers, Inc.
18215 72nd Avenue South
Kent, WA 98032
425.251.6222
barghausen.com



Job Number: 22085
Sheet: C12 of 34

APPROVED
BY: _____
CITY OF PUYALLUP
DEVELOPMENT ENGINEERING
DATE: _____
NOTE: THIS APPROVAL IS VOID AFTER 180 DAYS FROM APPROVAL DATE. THE CITY WILL NOT BE RESPONSIBLE FOR ERRORS AND/OR OMISSIONS ON THESE PLANS. FIELD CONDITIONS MAY DICTATE CHANGES TO THESE PLANS AS DETERMINED BY THE DEVELOPMENT ENGINEERING MANAGER.



Know what's below.
Call before you dig.
Dial 811

VAULT DETAILS

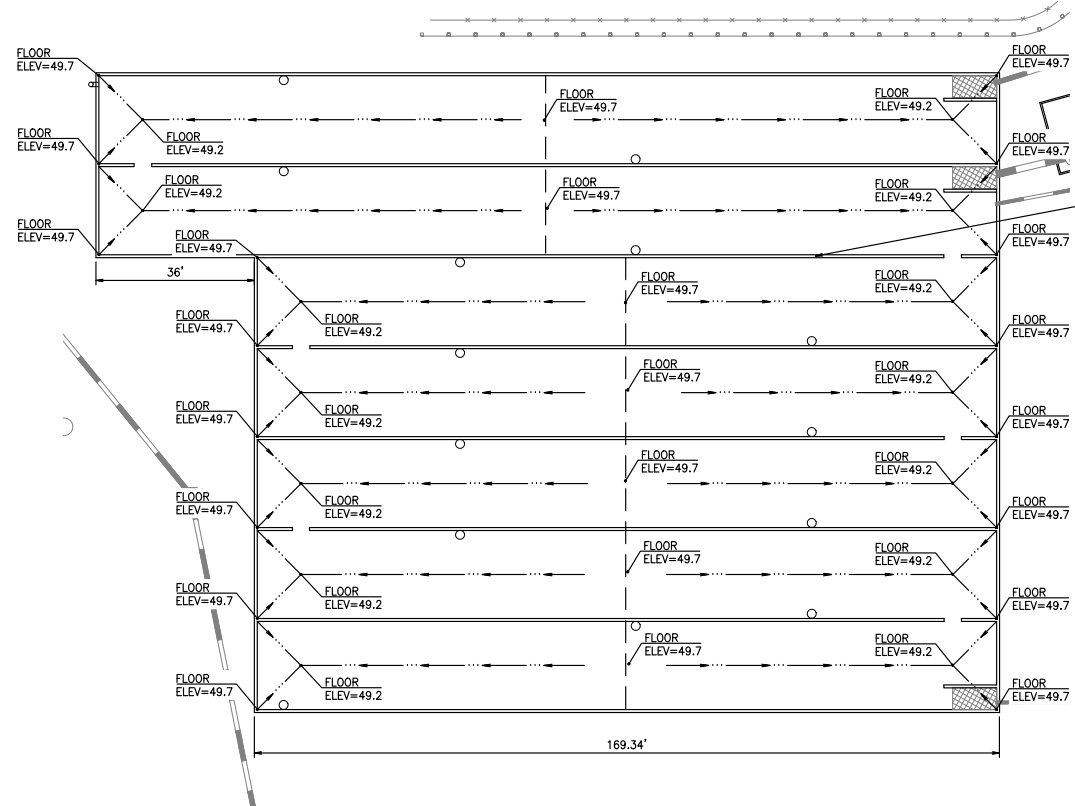
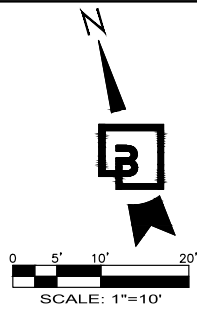

STORM VAULT FLOOR PLAN

1"=20'

STORM DETENTION VAULT
100'x168' + 40'x204'x7.5' INSIDE CLEAR DIMENSIONS
INSIDE TOP ELEV=56.7
MAX WS=55.5
STATIC WS=50.2
INSIDE BOTTOM=49.2±
5.3' LIVE STORAGE
SEE SHT C13 FOR ADDITIONAL DETAILS

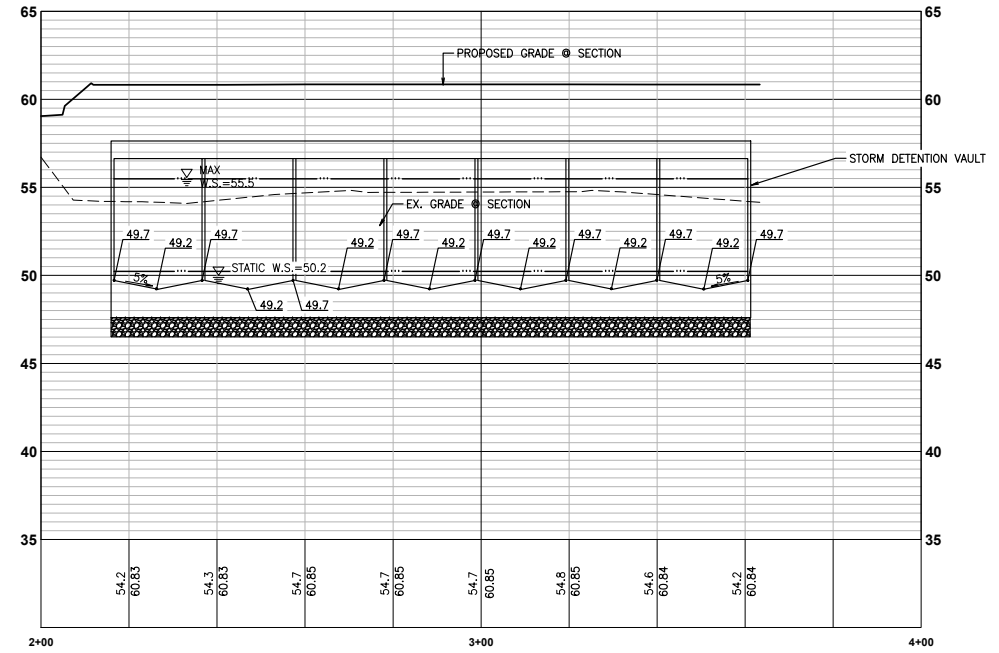

VAULT SECTION VI-VI

1"=20' HORIZ, 1"=5' VERT

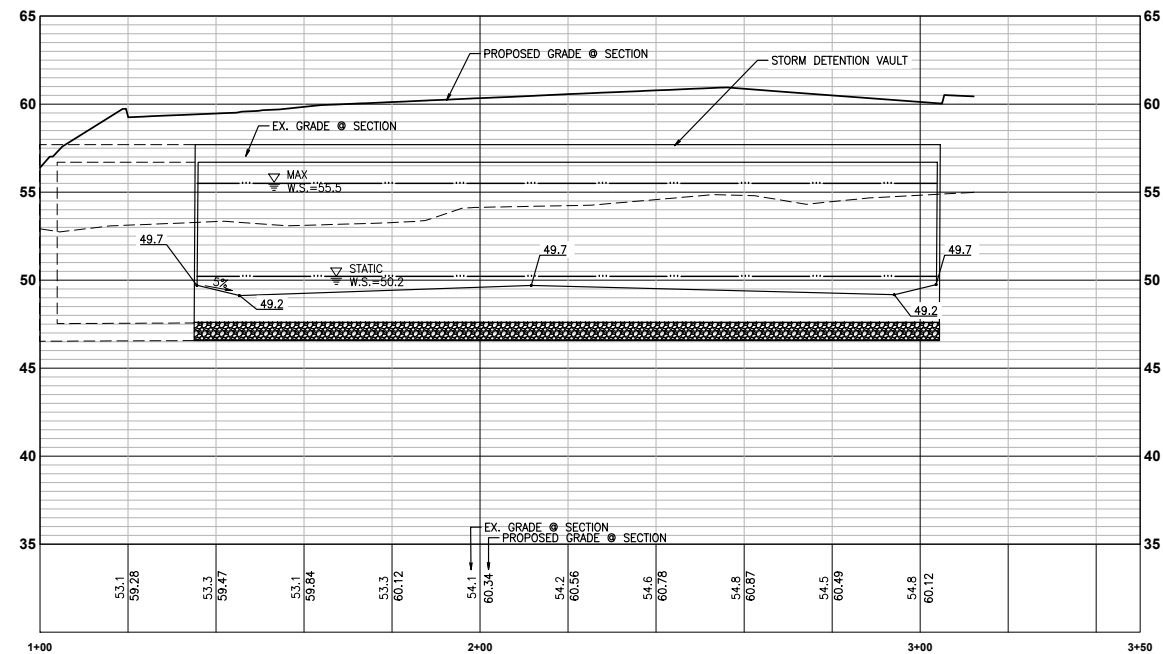

VAULT SECTION V2-V2

1"=20' HORIZ, 1"=5' VERT

No.	Date	By	Chd.	Appr.	Revision
2	03/05/24	DL	JSG	JSG	RESPONSE TO CITY COMMENTS, DATED FEBRUARY 06, 2024
1	02/27/24	DL	JSG	JSG	BID SET
1	12/06/23	DL	JSG	JSG	RESPONSE TO CITY COMMENTS, DATED 10-06-2023

Title: **VAULT DETAILS**

For: **CREF3 PUYALLUP OWNER LLC**
11611 SAN VICENTE BLVD
10TH FLOOR
LOS ANGELES, CA 90049

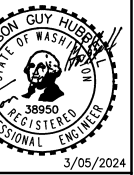

Scale: Horizontal 1"=10', Vertical N/A

Designed: DL, Drawn: RDC, Checked: DL, Approved: JGL, Date: 6/23/23

Barghausen Consulting Engineers, Inc.
18215 72nd Avenue South
Kent, WA 98032
425.251.6222 barghausen.com



APPROVED

BY: CITY OF PUYALLUP
DEVELOPMENT ENGINEERING

DATE: _____

NOTE: THIS APPROVAL IS VOID AFTER 180 DAYS FROM APPROVAL DATE.
THE CITY WILL NOT BE RESPONSIBLE FOR ERRORS AND/OR OMISSIONS ON THESE PLANS.
FIELD CONDITIONS MAY DICTATE CHANGES TO THESE PLANS AS DETERMINED BY THE DEVELOPMENT ENGINEERING MANAGER.



Know what's below.
Call before you dig.
Dial 811

Job Number: **22085**
Sheet: **C13** of **34**

PORTION OF SE QUARTER OF SEC 27, TWN 20 N, RGE. 4 E, W.M.
CITY OF PUYALLUP, PIERCE COUNTY, WASHINGTON
CONSTRUCTION NOTES AND DETAILS

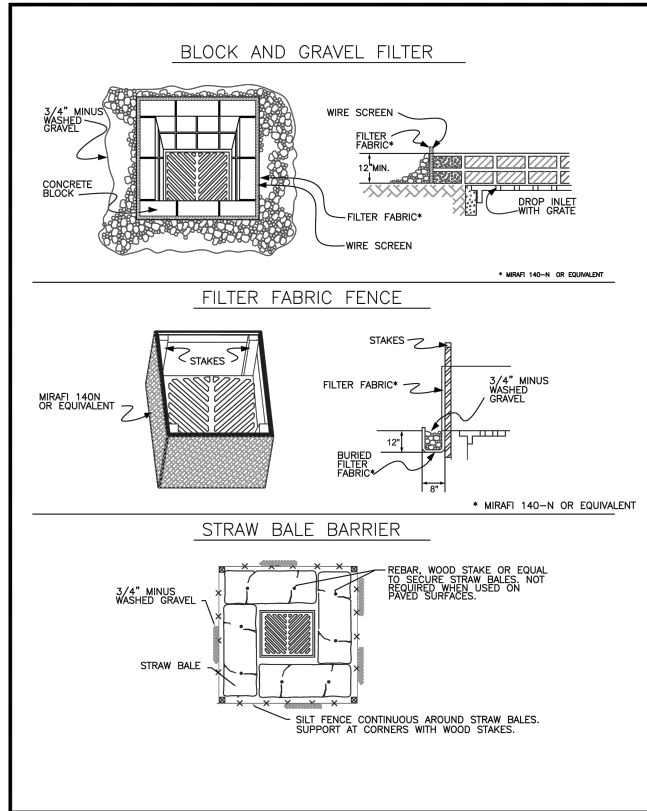

CONDITIONS WHERE PRACTICE APPLIES

- BLOCK AND GRAVEL FILTER - APPLICABLE FOR AREAS GREATER THAN 5% SLOPE.
- FILTER FABRIC FENCE - APPLICABLE WHERE THE INLET DRAINS A RELATIVELY SMALL (ONE ACRE OR LESS) AND FLAT AREA (LESS THAN 5% SLOPE).
- STRAW BALE BARRIER - APPLICABLE WHERE INLET DRAINS A RELATIVELY FLAT DISTURBED AREA (LESS THAN 5% SLOPE) IN WHICH SHEET FLOW (NOT EXCEEDING 0.5 FT/SEC) OCCURS. BARRIERS OF THIS TYPE SHOULD NOT BE PLACED AROUND INLETS RECEIVING CONCENTRATED FLOWS SUCH AS THOSE ALONG MAJOR STREETS AND HIGHWAYS.

1. BLOCK AND GRAVEL FILTER - INSTALLATION PROCEDURE

- PLACE WIRE MESH OVER THE DROP INLET SO THAT THE WIRE EXTENDS A MINIMUM OF ONE FOOT BEYOND EACH SIDE OF THE INLET STRUCTURE. USE WIRE SCREEN WITH 1/2-INCH OPENINGS. IF MORE THAN ONE STRIP OF MESH IS NECESSARY, OVERLAP THE STRIPS. PLACE FILTER FABRIC OVER WIRE MESH.
- PLACE CONCRETE BLOCKS LENGTHWISE ON THEIR SIDES IN A SINGLE ROW AROUND THE PERIMETER OF THE INLET, SO THAT THE OPEN ENDS FACE OUTWARD, NOT UPWARD. THE ENDS OF ADJACENT BLOCKS SHOULD ABUT. THE HEIGHT OF THE BARRIER CAN BE VARIED, DEPENDING ON DESIGN NEEDS. BY STACKING COMBINATIONS OF BLOCKS THAT ARE 4-INCH, 8-INCH AND 12-INCH WIDE. THE ROW OF BLOCKS SHOULD BE AT LEAST 12-INCHES BUT NO GREATER THAN 24-INCHES HIGH.
- PLACE WIRE SCREEN OVER THE OVERSIDE VERTICAL FACE (OPEN END) OF THE CONCRETE BLOCKS TO PREVENT STONES FROM BEING WASHED THROUGH THE BLOCKS. USE WIRE SCREEN WITH 1/2-INCH OPENINGS.
- PILE STONES AGAINST THE WIRE MESH TO THE TOP OF THE BLOCKS. USE 3/4" MINUS WASHED GRAVEL.

2. FILTER FABRIC FENCE - INSTALLATION PROCEDURE

- PLACE 2-INCH BY 2-INCH WOODEN STAKES AROUND THE PERIMETER OF THE INLET A MAXIMUM OF 3 FEET APART AND DRIVE THEM AT LEAST 8-INCHES INTO THE GROUND. THE STAKES MUST BE AT LEAST 3 FEET LONG.
- EXCAVATE A TRENCH APPROXIMATELY 8-INCHES WIDE AND 12-INCHES DEEP AROUND THE OUTSIDE PERIMETER OF THE STAKES.
- STAPLE THE FILTER FABRIC* TO THE WOODEN STAKES SO THAT 32-INCHES OF THE FABRIC EXTENDS AND CAN BE FORMED INTO THE TRENCH, AND USE HEAVY-DUTY WIRE STAPLES AT LEAST 1/2-INCHES LONG.
- BACKFILL THE TRENCH WITH 3/4-INCH MINUS WASHED GRAVEL ALL THE WAY AROUND.

3. STRAW BALE BARRIER - INSTALLATION PROCEDURE

- EXCAVATE A 4-INCH DEEP TRENCH AROUND THE INLET. MAKE THE TRENCH AS WIDE AS A STRAW BALE.
- ORIENT STRAW BALES WITH THE BINDINGS AROUND THE SIDES OF THE BALES RATHER THAN OVER AND UNDER THE BALES.
- PLACE BALES LENGTHWISE AROUND THE INLET AND PRESS THE ENDS OF ADJACENT BALES SECURELY IN PLACE.
- DRIVE TWO 2-INCH BY 2-INCH STAKES THROUGH EACH BALE TO ANCHOR THE BALE SECURELY IN PLACE.
- BACKFILL THE EXCAVATED SOIL AND COMPACT IT AGAINST THE BALE.
- WEDGE LOOSE STRAW BETWEEN BALES TO PREVENT WATER FROM FLOWING BETWEEN BALES.

* MIRAFI 140-N OR EQUIVALENT

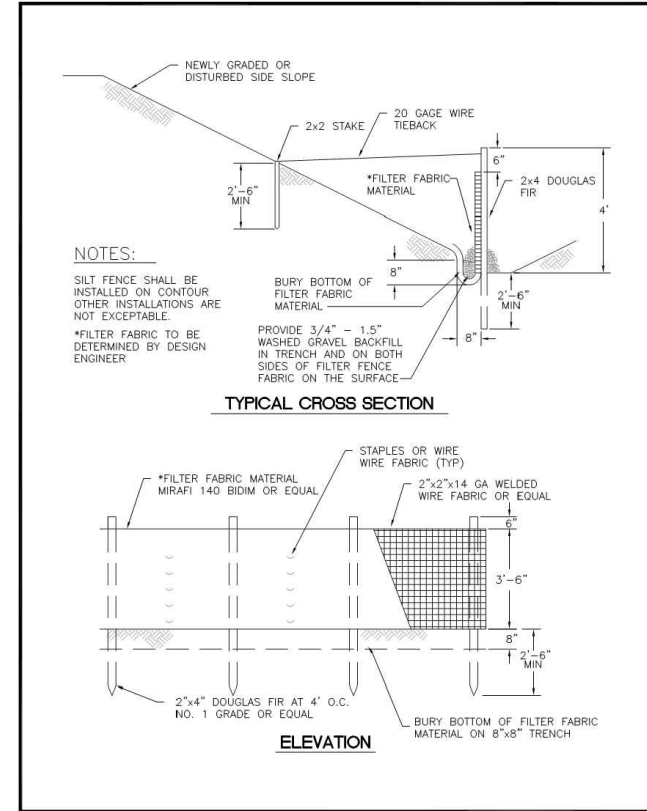
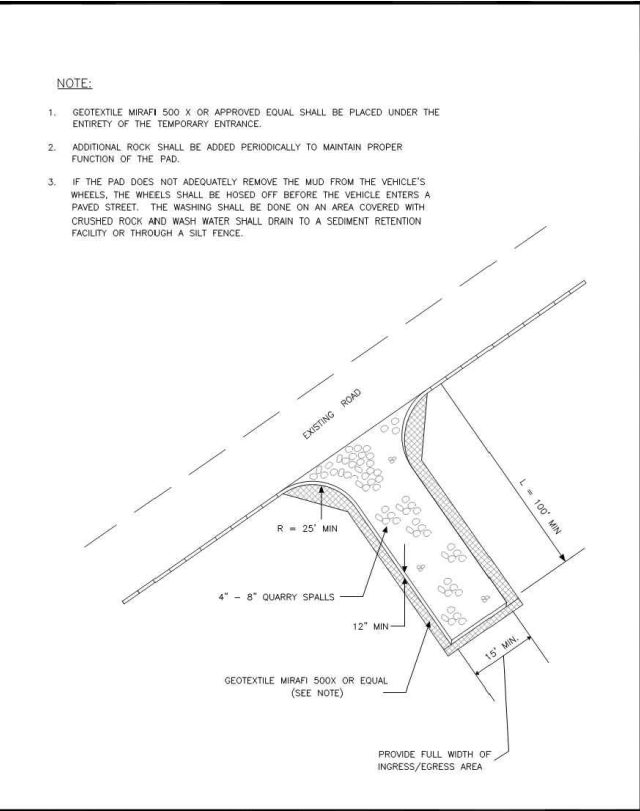

CITY OF PUYALLUP DEVELOPMENT ENGINEERING and PUBLIC WORKS DEPARTMENTS	STORM DRAIN BARRIERS		CITY STANDARD
	DESIGNED BY LINDA LANNING	CHECKED BY LINDA LANNING	

CITY OF PUYALLUP DEVELOPMENT ENGINEERING and PUBLIC WORKS DEPARTMENTS	STORM DRAIN BARRIERS NOTES		CITY STANDARD
	DESIGNED BY LINDA LANNING	CHECKED BY LINDA LANNING	

CITY OF PUYALLUP DEVELOPMENT ENGINEERING and PUBLIC WORKS DEPARTMENTS	TEMPORARY CONSTRUCTION ENTRANCE		CITY STANDARD
	DESIGNED BY LINDA LANNING	CHECKED BY LINDA LANNING	

CITY OF PUYALLUP DEVELOPMENT ENGINEERING and PUBLIC WORKS DEPARTMENTS	SILTATION FENCE		CITY STANDARD
	DESIGNED BY LINDA LANNING	CHECKED BY LINDA LANNING	

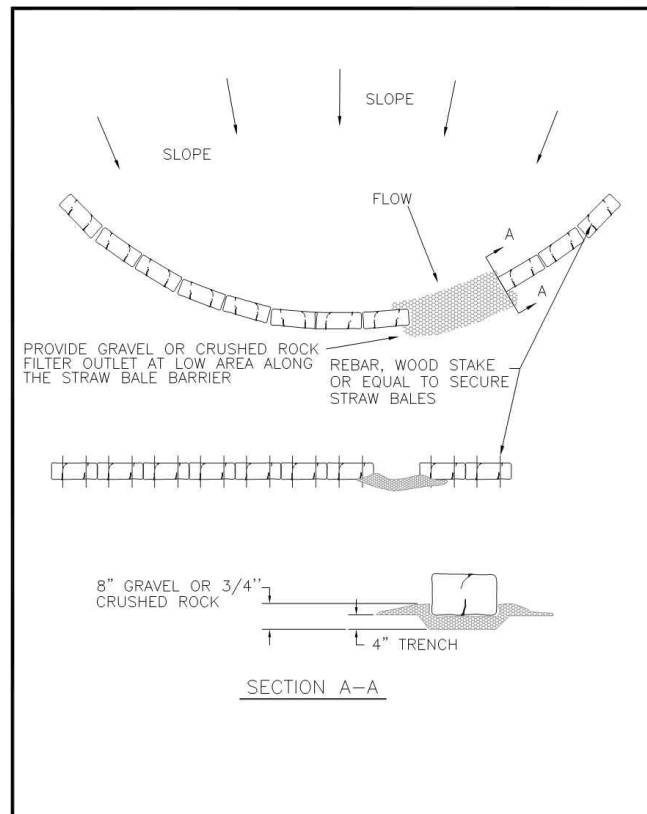

CITY OF PUYALLUP DEVELOPMENT ENGINEERING and PUBLIC WORKS DEPARTMENTS	BARRIER WITH GRAVEL OUTLET		CITY STANDARD
	DESIGNED BY LINDA LANNING	CHECKED BY LINDA LANNING	

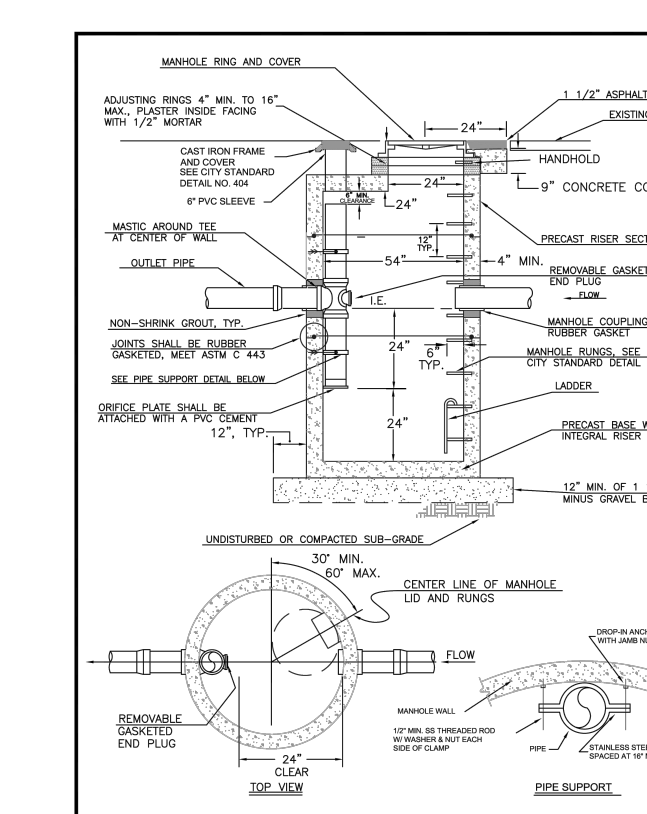

CITY OF PUYALLUP DEVELOPMENT ENGINEERING and PUBLIC WORKS DEPARTMENTS	FLOW CONTROL MANHOLE WITH FLAT TOP		CITY STANDARD
	DESIGNED BY LINDA LANNING	CHECKED BY LINDA LANNING	

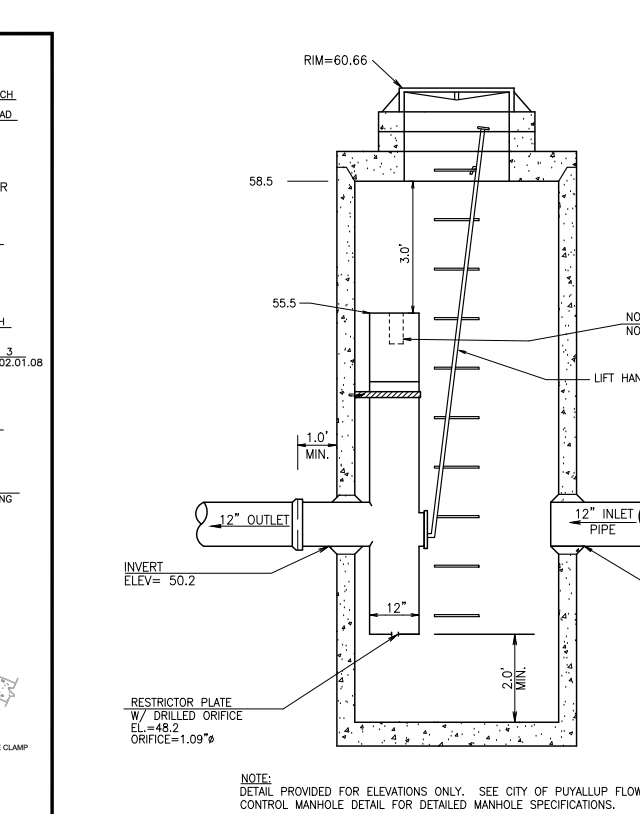

SDMH #1 CONTROL STRUCTURE TYPE 2-54'	
SCALE: 1"=2'	

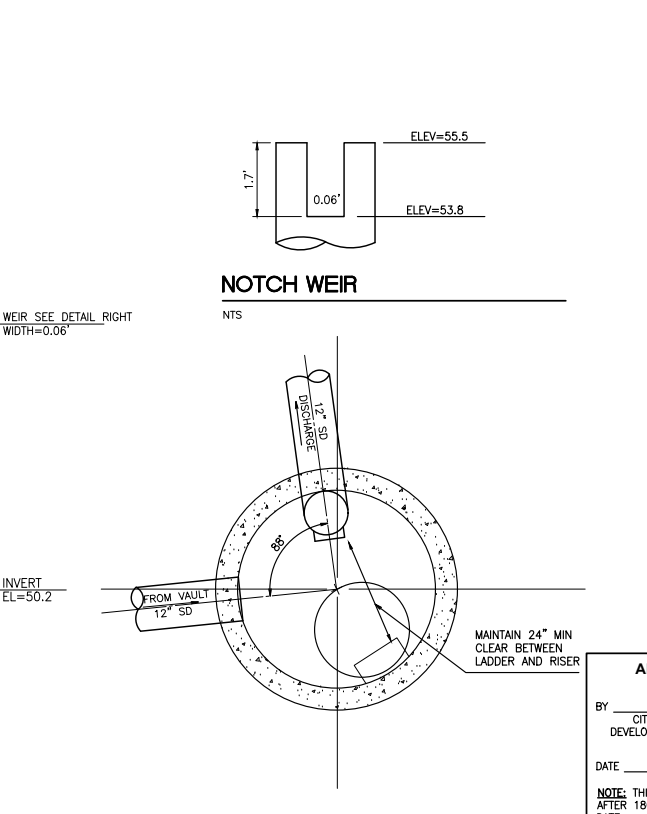

APPROVED	
BY	CITY OF PUYALLUP DEVELOPMENT ENGINEERING
DATE	
NOTE: THIS APPROVAL IS VOID AFTER 180 DAYS FROM APPROVAL DATE. THE CITY WILL NOT BE RESPONSIBLE FOR ERRORS AND/OR OMISSIONS ON THESE PLANS. FIELD CONDITIONS MAY DICTATE CHANGES TO THESE PLANS AS DETERMINED BY THE DEVELOPMENT ENGINEERING MANAGER.	

2	03/05/24	DL	JSG	RESPONSE TO CITY COMMENTS, DATED FEBRUARY 06, 2024
1	02/27/24	DL	JSG	BID SET
1	12/06/23	DL	JSG	RESPONSE TO CITY COMMENTS, DATED 10-06-2023

Revision
No. Date By Ckd. Appr.
Title:
CONSTRUCTION NOTES AND DETAILS
FORTRESS - PUYALLUP

For:
CREF3 PUYALLUP OWNER LLC
11611 SAN VICENTE BLVD
10TH FLOOR
LOS ANGELES, CA 90049

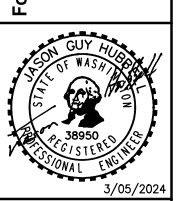

Scale:	Horizontal	Vertical
Designed	DL	
Drawn	RDC	
Checked	DL	
Approved	JGL	
Date	8/23/23	

Barghausen Consulting Engineers, Inc.
18215 72nd Avenue South
Kent, WA 98032
425.251.6222
barghausen.com

Job Number	22085
Sheet	C21 of 34

CONSTRUCTION DETAILS

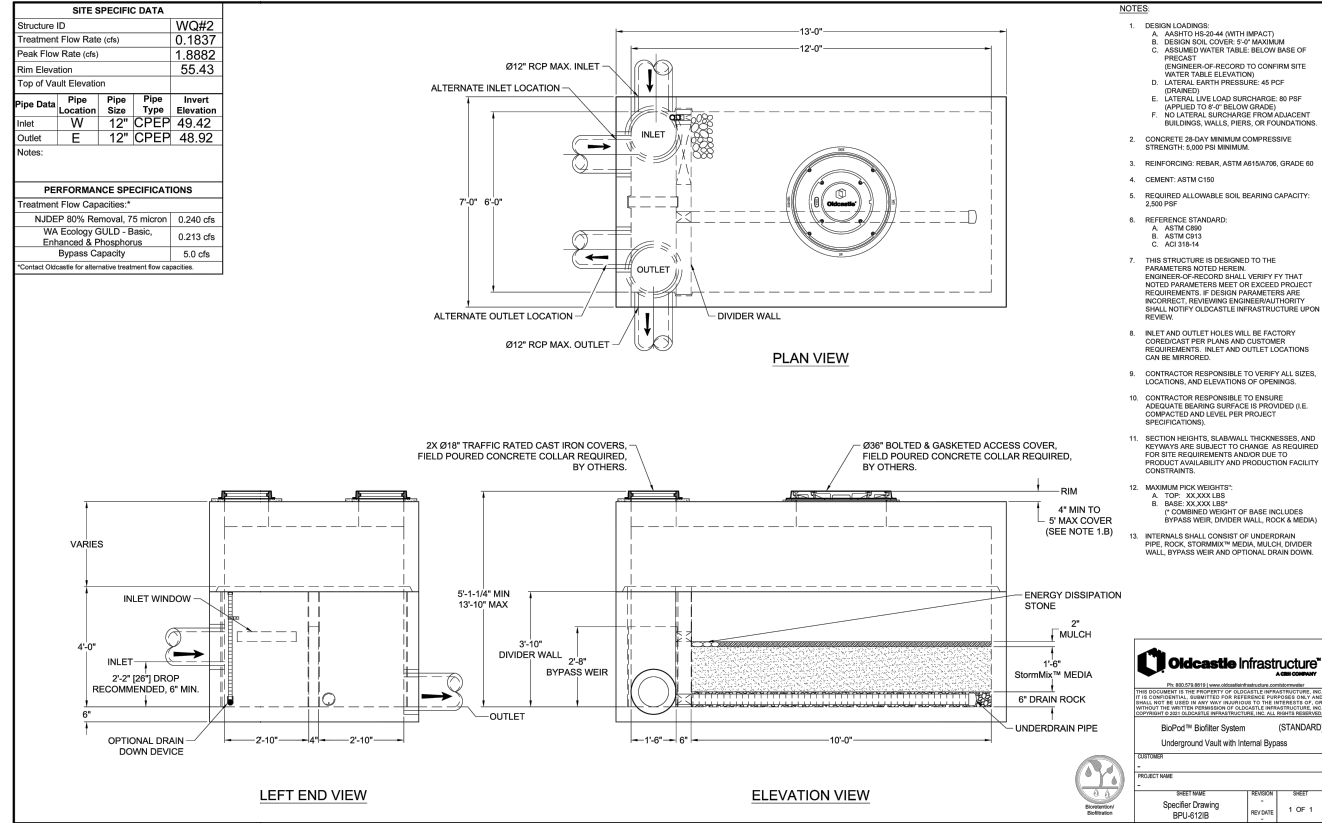
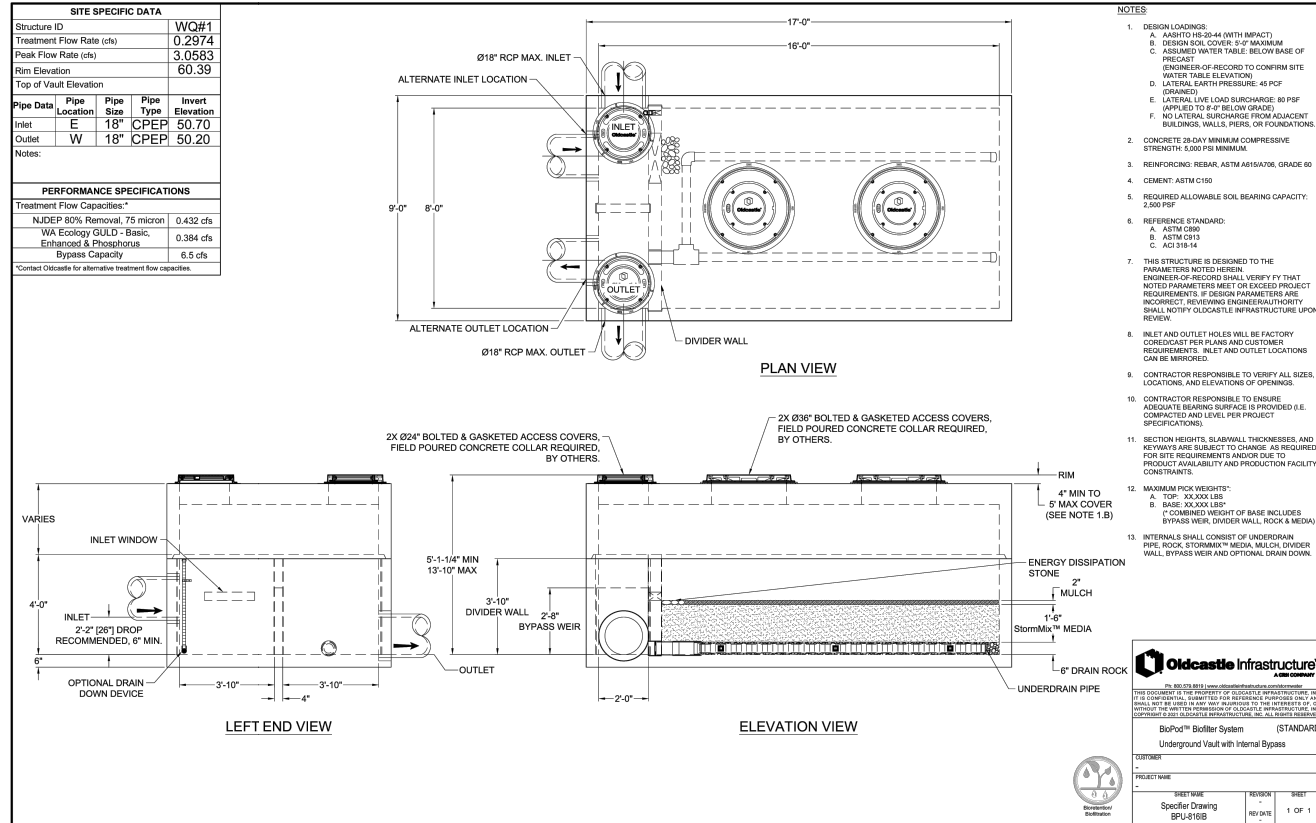

No.	Date	By	Appr.	Response to City Comments
1	12/06/23	JSG	JSG	Response to City Comments, Dated 10-06-2023
2	03/05/24	DL	JSG	Response to City Comments, Dated February 06, 2024

CONSTRUCTION DETAILS
FORTRESS - PUYALLUP

FOR:
CREF3 PUYALLUP OWNER LLC
11611 SAN VICENTE BLVD
10TH FLOOR
LOS ANGELES, CA 90049

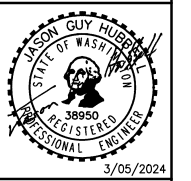

Scale:	Horizontal	NA	Vertical	N/A					
Designed	DL	Drawn	RDC	Checked	DL	Approved	JGL	Date	8/23/23

Barghausen Consulting Engineers, Inc.
18215 72nd Avenue South
Kent, WA 98032
425.251.6222
barghausen.com

APPROVED

BY: _____
CITY OF PUYALLUP
DEVELOPMENT ENGINEERING

DATE: _____

NOTE: THIS APPROVAL IS VOID AFTER 180 DAYS FROM APPROVAL DATE. THE CITY WILL NOT BE RESPONSIBLE FOR ERRORS AND/OR OMISSIONS ON THESE PLANS. FIELD CONDITIONS MAY DICTATE CHANGES TO THESE PLANS AS DETERMINED BY THE DEVELOPMENT ENGINEERING MANAGER.

Job Number: **22085**
Sheet: **34**
of **C23**

Table V-A.2: Maintenance Standards - Infiltration (continued)

Maintenance Component	Defect	Conditions When Maintenance Is Needed	Results Expected When Maintenance Is Performed
		(A percolation test pit or test of facility indicates facility is only working at 90% of its designed capabilities. Test every 2 to 5 years. If two inches or more sediment is present, remove).	
Filter Bags (if applicable)	Filled with Sediment and Debris	Sediment and debris fill bag more than 1/2 full.	Filter bag is replaced or system is redesigned.
Rock Filters	Sediment and Debris	By visual inspection, little or no water flows through filter during heavy rain storms.	Gravel in rock filter is replaced.
Side Slopes of Pond	Erosion	See Table V-A.1: Maintenance Standards - Detention Ponds	See Table V-A.1: Maintenance Standards - Detention Ponds
Emergency Overflow Spillway and Berms over 4 feet in height.	Tree Growth	See Table V-A.1: Maintenance Standards - Detention Ponds	See Table V-A.1: Maintenance Standards - Detention Ponds
	Piping	See Table V-A.1: Maintenance Standards - Detention Ponds	See Table V-A.1: Maintenance Standards - Detention Ponds
Emergency Overflow Spillway	Rock Missing	See Table V-A.1: Maintenance Standards - Detention Ponds	See Table V-A.1: Maintenance Standards - Detention Ponds
	Erosion	See Table V-A.1: Maintenance Standards - Detention Ponds	See Table V-A.1: Maintenance Standards - Detention Ponds
Pre-settling Ponds and Vaults	Facility or sump filled with Sediment and/or debris	6" or designed sediment trap depth of sediment.	Sediment is removed.

Table V-A.3: Maintenance Standards - Closed Detention Systems (Tanks/Vaults)

Maintenance Component	Defect	Conditions When Maintenance is Needed	Results Expected When Maintenance is Performed
Storage Area	Plugged Air Vents	One-half of the cross section of a vent is blocked at any point or the vent is damaged.	Vents open and functioning.
	Debris and Sediment	Accumulated sediment depth exceeds 10% of the diameter of the storage area for 1/2 length of storage vault or any point depth exceeds 15% of diameter. (Example: 72-inch storage tank would require cleaning when sediment reaches depth of 7 inches for more than 1/2 length of tank.)	All sediment and debris removed from storage area.
	Joints Between Tank/Pipe Section	Any openings or voids allowing material to be transported into facility. (Will require engineering analysis to determine structural stability).	All joint between tank/pipe sections are sealed.
	Tank Pipe Bent Out of Shape	Any part of tank/pipe is bent out of shape more than 10% of its design shape. (Review required by engineer to determine structural stability).	Tank/pipe repaired or replaced to design.
	Vault Structure Includes Cracks in Wall, Bottom, Damage to Frame and/or Top Slab	Cracks wider than 1/2-inch and any evidence of soil particles entering the structure through the cracks, or maintenance/inspection personnel determines that the vault is not structurally sound. Cracks wider than 1/2-inch at the joint of any inlet/outlet pipe or any evidence of soil particles entering the vault through the walls.	Vault replaced or repaired to design specifications and is structurally sound. No cracks more than 1/4-inch wide at the joint of the inlet/outlet pipe.

Table V-A.3: Maintenance Standards - Closed Detention Systems (Tanks/Vaults) (continued)

Maintenance Component	Defect	Conditions When Maintenance is Needed	Results Expected When Maintenance is Performed
Manhole	Cover Not in Place	Cover is missing or only partially in place. Any open manhole requires maintenance.	Manhole is closed.
	Locking Mechanism Not Working	Mechanism cannot be opened by one maintenance person with proper tools. Bolts into frame have less than 1/2 inch of thread (may not apply to self-locking lids).	Mechanism opens with proper tools.
	Cover Difficult to Remove	One maintenance person cannot remove lid after applying normal lifting pressure. Intent is to keep cover from sealing off access to maintenance.	Cover can be removed and reinstalled by one maintenance person.
	Ladder Rungs Unsafe	Ladder is unsafe due to missing rungs, misalignment, not securely attached to structure wall, rust, or cracks.	Ladder meets design standards. Allows maintenance person safe access.
Catch Basins	See Table V-A.5: Maintenance Standards - Catch Basins	See Table V-A.5: Maintenance Standards - Catch Basins	See Table V-A.5: Maintenance Standards - Catch Basins

Table V-A.4: Maintenance Standards - Control Structure/Flow Restrictor

Maintenance Component	Defect	Condition When Maintenance is Needed	Results Expected When Maintenance is Performed
General	Trash and Debris (Includes Sediment)	Material exceeds 25% of sump depth or 1 foot below orifice plate.	Control structure orifice is not blocked. All trash and debris removed.
	Structural Damage	Structure is not securely attached to manhole wall. Structure is not in upright position (allow up to 10% from plumb). Connections to outlet pipe are not watertight and show signs of rust. Any holes - other than designed holes - in the structure.	Structure securely attached to wall and outlet pipe. Structure in correct position. Connections to outlet pipe are water tight; structure repaired or replaced and works as designed. Structure has no holes other than designed holes.
Cleanout Gate	Damaged or Missing	Cleanout gate is not watertight or is missing. Gate cannot be moved up and down by one maintenance person. Chain/rod leading to gate is missing or damaged. Gate is rusted over 50% of its surface area.	Gate is watertight and works as designed. Gate moves up and down easily and is watertight. Chain is in place and works as designed. Gate is repaired or replaced to meet design standards.
Orifice Plate	Damaged or Missing	Control device is not working properly due to missing, out of place, or bent orifice plate.	Plate is in place and works as designed.
	Obstructions	Any trash, debris, sediment, or vegetation blocking the plate.	Plate is free of all obstructions and works as designed.
Overflow Pipe	Obstructions	Any trash or debris blocking (or having the potential of blocking) the overflow pipe.	Pipe is free of all obstructions and works as designed.
Manhole	See Table V-A.3: Maintenance Standards - Closed Detention Systems (Tanks/Vaults)	See Table V-A.3: Maintenance Standards - Closed Detention Systems (Tanks/Vaults)	See Table V-A.3: Maintenance Standards - Closed Detention Systems (Tanks/Vaults)
Catch Basin	See Table V-A.5: Maintenance Standards - Catch Basins	See Table V-A.5: Maintenance Standards - Catch Basins	See Table V-A.5: Maintenance Standards - Catch Basins

Table V-A.5: Maintenance Standards - Catch Basins

Maintenance Component	Defect	Conditions When Maintenance is Needed	Results Expected When Maintenance is performed
General	Trash & Debris	Trash or debris which is located immediately in front of the catch basin opening or is blocking inletting capacity of the basin by more than 10%. Trash or debris (in the basin) that exceeds 60 percent of the sump depth as measured from the bottom of basin to invert of the lowest pipe into or out of the basin, but in no case less than a minimum of six inches clearance from the debris surface to the invert of the lowest pipe. Trash or debris in any inlet or outlet pipe blocking more than 1/3 of its height. Dead animals or vegetation that could generate odors that could cause complaints or dangerous gases (e.g., methane).	No Trash or debris located immediately in front of catch basin or on grate opening. No trash or debris in the catch basin. Inlet and outlet pipes free of trash or debris. No dead animals or vegetation present within the catch basin.
	Sediment	Sediment (in the basin) that exceeds 60 percent of the sump depth as measured from the bottom of basin to invert of the lowest pipe into or out of the basin, but in no case less than a minimum of 6 inches clearance from the sediment surface to the invert of the lowest pipe.	No sediment in the catch basin
	Structure Damage to Frame and/or Top Slab	Top slab has holes larger than 2 square inches or cracks wider than 1/4 inch. (Intent is to make sure no material is running into basin). Frame not sitting flush on top slab, i.e., separation of more than 3/4 inch of the frame from the top slab. Frame not securely attached	Top slab is free of holes and cracks. Frame is sitting flush on the riser rings or top slab and firmly attached.
	Fractures or Cracks in Basin Walls/ Bottom	Maintenance person judges that structure is unsound. Grout fillet has separated or cracked wider than 1/2 inch and longer than 1 foot at the joint of any inlet/outlet pipe or any evidence of soil particles entering catch basin through cracks.	Basin replaced or repaired to design standards. Pipe is regouted and secure at basin wall.
	Settlement/ Mis-alignment	If failure of basin has created a safety, function, or design problem.	Basin replaced or repaired to design standards.
	Vegetation	Vegetation growing across and blocking more than 10% of the basin opening. Vegetation growing in inlet/outlet pipe joints that is more than six inches tall and less than six inches apart.	No vegetation blocking opening to basin. No vegetation or root growth present.
	Contamination and Pollution	See Table V-A.1: Maintenance Standards - Detention Ponds	No pollution present.
Catch Basin Cover	Cover Not in Place	Cover is missing or only partially in place. Any open catch basin requires maintenance.	Cover/grate is in place, meets design standards, and is secured
	Locking Mechanism Not Working	Mechanism cannot be opened by one maintenance person with proper tools. Bolts into frame have less than 1/2 inch of thread.	Mechanism opens with proper tools.
	Cover Difficult to Remove	One maintenance person cannot remove lid after applying normal lifting pressure. (Intent is keep cover from sealing off access to maintenance.)	Cover can be removed by one maintenance person.
Ladder	Ladder Rungs Unsafe	Ladder is unsafe due to missing rungs, not securely attached to basin wall, misalignment, rust, cracks, or sharp edges.	Ladder meets design standards and allows maintenance person safe access.
Metal Grates (If Applicable)	Grate opening Unsafe	Grate with opening wider than 7/8 inch.	Grate opening meets design standards.
	Trash and Debris	Trash and debris that is blocking more than 20% of grate surface inletting capacity.	Grate free of trash and debris.
	Damaged or Missing.	Grate missing or broken member(s) of the grate.	Grate is in place, meets the design standards, and is installed and aligned with the flow path.

BIOPOD™ SYSTEM

with StormMix™ Media

Inspection & Maintenance Guide

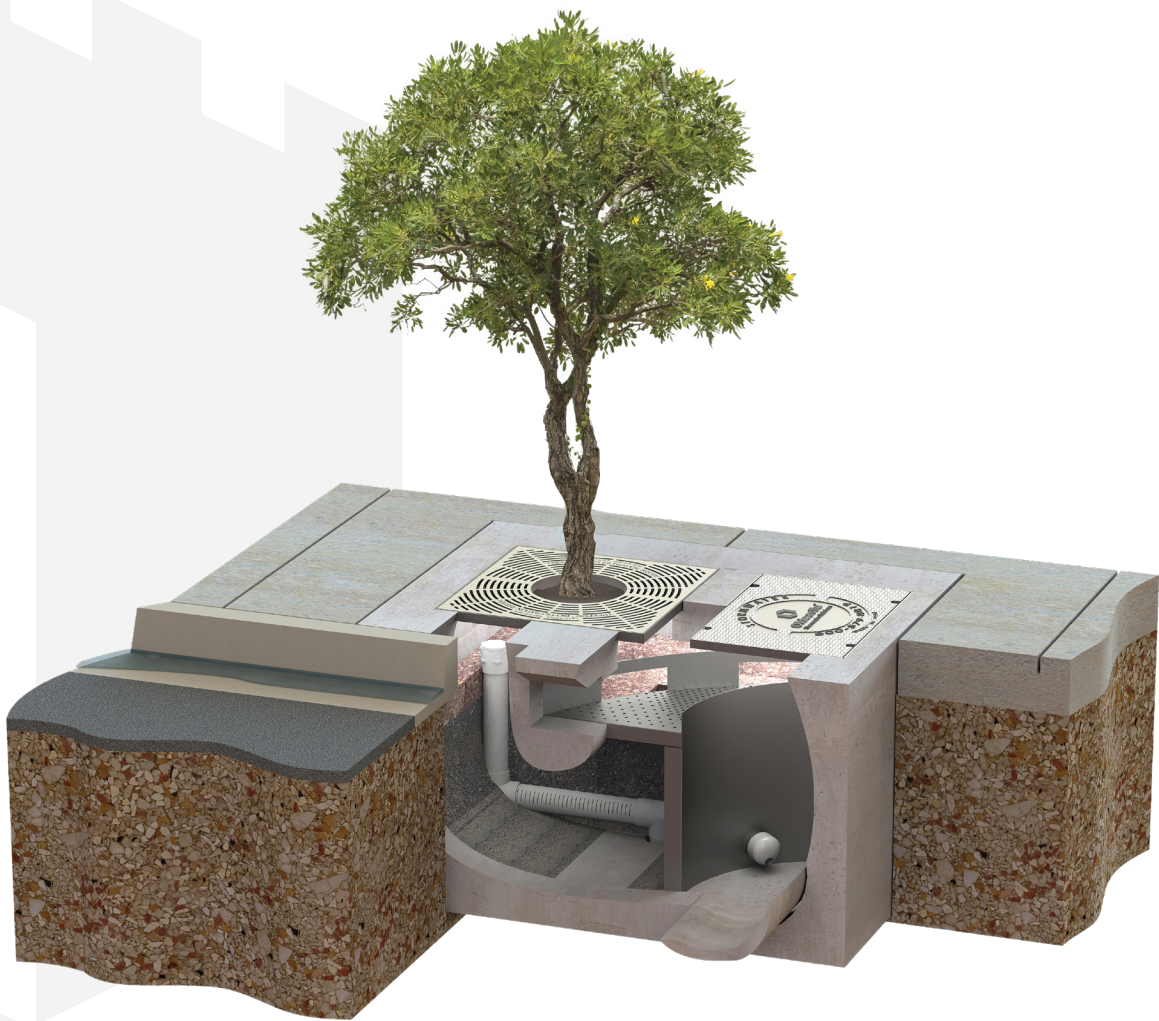

BIOPOD™ BIOFILTER WITH STORMMIX™ BIOFILTRATION MEDIA

DESCRIPTION

The BioPod™ Biofilter System (BioPod) is a storm water biofiltration treatment system used to remove pollutants from storm water runoff. Impervious surfaces and other urban and suburban landscapes generate a variety of contaminants that can enter storm water and pollute downstream receiving waters unless treatment is provided. The BioPod system uses proprietary StormMix™ biofiltration media to capture and retain pollutants including total suspended solids (TSS), metals, nutrients, gross solids, trash and debris as well as petroleum hydrocarbons.

FUNCTION

The BioPod system uses engineered, high-flow rate filter media to remove storm water pollutants, allowing for a smaller footprint than conventional bioretention systems. Contained within a compact precast concrete vault, the BioPod system consists of a biofiltration chamber and an optional integrated high-flow bypass. The biofiltration chamber is filled with horizontal layers of aggregate, biofiltration media and mulch. Storm water passes vertically down through the mulch and biofiltration media for treatment. The mulch provides pretreatment by retaining most of the solids or sediment. The biofiltration media provides further treatment by retaining finer sediment and dissolved pollutants. The aggregate allows the media bed to drain evenly for discharge through an underdrain pipe or by infiltration.

INSPECTION & MAINTENANCE OVERVIEW

State and local regulations require all storm water management systems to be inspected on a regular basis and maintained as necessary to ensure performance and protect downstream receiving waters. Without maintenance, excessive pollutant buildup can limit system performance by reducing the operating capacity of the system and increasing the potential for scouring of pollutants during periods of high flow.

Some configurations of the BioPod may require periodic irrigation to establish and maintain vegetation. Vegetation will typically become established about two years after planting. Irrigation requirements are ultimately dependent on climate, rainfall and the type of vegetation selected.

INSPECTION & MAINTENANCE FREQUENCY

Periodic inspection is essential for consistent system performance and is easily completed. Inspection is typically conducted a minimum of twice per year, but since pollutant transport and deposition varies from site to site, a site-specific maintenance frequency should be established during the first two or three years of operation.



INSPECTION EQUIPMENT

The following equipment is helpful when conducting BioPod inspections:

- | Recording device (pen and paper form, voice recorder, iPad, etc.)
- | Suitable clothing (appropriate footwear, gloves, hardhat, safety glasses, etc.)
- | PPE as required for entry
- | Traffic control equipment (cones, barricades, signage, flagging, etc.)
- | Manhole hook or pry bar
- | Flashlight
- | Tape measure
- | Socket

INSPECTION PROCEDURES

BioPod inspections are visual and are conducted without entering the unit. To complete an inspection, safety measures including traffic control should be deployed before the access covers or tree grates are removed. Once the covers have been removed, the following items should be checked and recorded (see form provided on page 6) to determine whether maintenance is required:

- | If the BioPod unit is equipped with an internal bypass, inspect the inlet rack (or inlet chamber on underground units) and outlet chamber and note whether there are any broken or missing parts. In the unlikely event that internal parts are broken or missing, contact Oldcastle Storm water at (800) 579-8819 to determine appropriate corrective action.
- | Note whether the curb inlet, inlet pipe, or inlet rack is blocked or obstructed.
- | If the unit is equipped with an internal bypass, observe, quantify and record the accumulation of trash and debris in the inlet rack or inlet chamber. The significance of accumulated trash and debris is a matter of judgment. Often, much of the trash and debris may be removed manually at the time of inspection if a separate maintenance visit is not yet warranted.
- | If it has not rained within the past 24 hours, note whether standing water is observed in the biofiltration chamber.
- | Finally, observe, quantify and record presence of invasive vegetation and the amount of trash and debris and sediment load in the biofiltration chamber. Erosion of the mulch and biofiltration media bed should also be recorded. Often, much of the invasive vegetation and trash and debris may be removed manually at the time of inspection if a separate maintenance visit is not yet warranted. Sediment load may be rated light, medium or heavy depending on the conditions. Loading characteristics may be determined as follows:
 - **Light sediment load** – sediment is difficult to distinguish among the mulch fibers at the top of the mulch layer; the mulch appears almost new.
 - **Medium sediment load** – sediment accumulation is apparent and may be concentrated in some areas; probing the mulch layer reveals lighter sediment loads under the top 1" of mulch.
 - **Heavy sediment load** – sediment is readily apparent across the entire top of the mulch layer; individual mulch fibers are difficult to distinguish; probing the mulch layer reveals heavy sediment load under the top 1" of mulch.

MAINTENANCE INDICATORS

Maintenance should be scheduled if any of the following conditions are identified during inspection:

- | The concrete structure is damaged or the tree grate or access cover is damaged or missing
- | The inlet obstructed
- | Standing water is observed in the biofiltration chamber more than 24 hours after a rainfall event (use discretion if the BioPod is located downstream of a storage system that attenuates flow)
- | Trash and debris in the inlet rack cannot be easily removed at the time of inspection
- | Trash and debris, invasive vegetation or sediment load in the biofiltration chamber is heavy or excessive erosion has occurred

MAINTENANCE EQUIPMENT

The following equipment is helpful when conducting BioPod maintenance:

- | Suitable clothing (appropriate footwear, gloves, hardhat, safety glasses, etc.)
- | PPE as required for entry
- | Traffic control equipment (cones, barricades, signage, flagging, etc.)
- | Manhole hook or pry bar
- | Flashlight
- | Tape measure
- | Rake, hoe, shovel and broom
- | Bucket
- | Pruners
- | Vacuum truck (optional)
- | Socket

MAINTENANCE PROCEDURES

Maintenance should be conducted during dry weather when no flows are entering the system. In most cases, maintenance may be conducted without entering. Entry may be required to maintain BioPod Underground units, depending on system depth. Once safety measures such as traffic control are deployed, the access covers may be removed and the following activities may be conducted to complete maintenance:

- | Remove all trash and debris from the curb inlet and inlet rack manually or by using a vacuum truck as required.
- | Remove all trash and debris and invasive vegetation from the biofiltration chamber manually or by using a vacuum truck as required.
- | If the sediment load is medium or light but erosion of the biofiltration media bed is evident, redistribute the mulch with a rake or replace missing mulch as appropriate. If erosion persists, rocks may be placed in the eroded area to help dissipate energy and prevent recurring erosion.
- | If the sediment load is heavy, remove the mulch layer using a hoe, rake, shovel and bucket, or by using a vacuum truck as required. If the sediment load is particularly heavy, inspect the surface of the biofiltration media once the mulch has been removed. If the media appears clogged with sediment, remove and replace one or two inches of biofiltration media prior to replacing the mulch* layer.
- | Prune vegetation as appropriate and replace damaged or dead plants as required.
- | Replace the tree grate and/or access covers and sweep the area around the BioPod to leave the site clean.
- | All material removed from the BioPod during maintenance must be disposed of in accordance with local environmental regulations. In most cases, the material may be handled in the same manner as disposal of material removed from sumped catch basins or manholes.



* Natural, shredded hardwood mulch should be used in the BioPod. Timely replacement of the mulch layer according to the maintenance indicators described above should protect the biofiltration media below the mulch layer from clogging due to sediment accumulation. However, whenever the mulch is replaced, the BioPod should be visited 24 hours after the next major storm event to ensure that there is no standing water in the biofiltration chamber. Standing water indicates that the biofiltration media below the mulch layer is clogged and must be replaced. Please contact Oldcastle Infrastructure at (800) 579-8819 to purchase the proprietary StormMix™ biofiltration media.



BIOPOD TREE

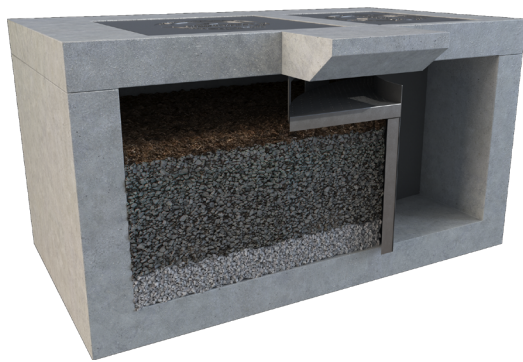

BIOPOD SURFACE



BIOPOD PLANTER

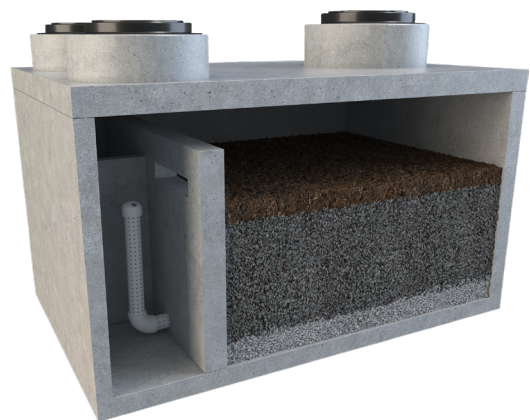

BIOPOD UNDERGROUND

BIOPOD INSPECTION & MAINTENANCE LOG

BioPod Model _____ Inspection Date _____

Location _____

Condition of Internal Components

NOTES:

GOOD **DAMAGED** **MISSING**

Curb Inlet or Inlet Rack Blocked

NOTES:

YES **NO**

Standing Water in Biofiltration Chamber

NOTES:

YES **NO**

Trash and Debris in Inlet Rack

NOTES:

YES **NO**

Trash and Debris in Biofiltration Chamber

NOTES:

YES **NO**

Invasive Vegetation in Biofiltration Chamber

NOTES:

YES **NO**

Sediment in Biofiltration Chamber

NOTES:

LIGHT **MEDIUM** **HEAVY**

Erosion in Biofiltration Chamber

NOTES:

YES **NO**

Maintenance Requirements

YES - Schedule Maintenance **NO - Schedule Re-Inspection**



Oldcastle Infrastructure[™]
A CRH COMPANY

IV-1 Source Control BMPs Applicable to All Sites

S410 BMPs for Correcting Illicit Discharges to Storm Drains

Description of Pollutant Sources: Illicit discharges are unpermitted sanitary or process wastewater discharges to a storm sewer or to surface water, rather than to a sanitary sewer, industrial process wastewater, or other appropriate treatment. They can also include swimming pool water, filter backwash, cleaning solutions/washwaters, cooling water, etc. Experience has shown that illicit discharges are common, particularly in older buildings.

Pollutant Control Approach: Identify and eliminate unpermitted discharges or obtain an NPDES permit, where necessary, particularly at industrial and commercial facilities.

Applicable Operational BMPs:

- For all real properties, responsible parties must examine their plumbing systems to identify any potential illicit discharges. Review site plans, engineering drawings, or other sources of information for the plumbing systems on the property.
- If an illicit discharge is suspected, trace the source using an appropriate method such as visual reconnaissance, smoke test, flow test, dye test with a nontoxic dye, or closed circuit television (CCTV) inspection. These tests are to be performed by qualified personnel such as a plumbing contractor. Note: Contact Ecology prior to performing a dye test which may result in a discharge to a receiving water.
- If illicit connections are found, permanently plug or disconnect the connections.
- Eliminate prohibited discharges to storm sewer, ground water, or surface water.
- Convey unpermitted discharges to a sanitary sewer if allowed by the local sewer authority, or to other approved treatment.
- Obtain all necessary permits for altering or repairing side sewers and plumbing fixtures. Restrictions on certain types of discharges, particularly industrial process waters, may require pretreatment of discharges before they enter the sanitary sewer. It is the responsibility of the property owner or business operator to obtain the necessary permits and to replace the connection.
- Obtain appropriate state and local permits for these discharges.

Recommended Additional Operational BMPs:

At commercial and industrial facilities, conduct a survey of wastewater discharge connections to storm drains and to surface water as follows:

- Conduct a field survey of buildings, particularly older buildings, and other industrial areas to locate storm drains from buildings and paved surfaces. Note where these discharge.
- During non-stormwater conditions, inspect each storm drain for non-stormwater discharges. Record the locations of all non-stormwater discharges. Include all permitted discharges.
- If useful, prepare a map of each area. Show on the map the known location of storm sewers, sanitary sewers, and permitted and unpermitted discharges. Aerial photos may be useful. Check records such as piping schematics to identify known side sewer connections and show these on the map. Consider using smoke, dye, or chemical analysis tests to detect connections between two conveyance systems (e.g., process water and stormwater). If desirable, conduct TV inspections of the storm drains and record the footage on videotape.
- Compare the observed locations of connections with the information on the map and revise the map accordingly. Note suspect connections that are inconsistent with the field survey.
- Identify all connections to storm sewers or to surface water and take the actions specified above as applicable BMPs.

S453 BMPs for Formation of a Pollution Prevention Team

The pollution prevention team should be responsible for implementing and maintaining all BMPs and treatment for the site. This team should be able to address any corrective actions needed on site to mitigate potential stormwater contamination. The team members should:

- Consist of those people who are familiar with the facility and its operations.
- Possess the knowledge and skills to assess conditions and activities that could impact stormwater quality at your facility, and who can evaluate the effectiveness of control measures.
- Assign pollution prevention team staff to be on duty on a daily basis to cover applicable permittee facilities when those facilities are in operation.
- Have the primary responsibility for developing and overseeing facility activities necessary to comply with stormwater requirements.
- Have access to all applicable permit, monitoring, SWPPP, and other records.
- Be trained in the operation, maintenance and inspections of all BMPs and reporting procedures.
- Establish responsibilities for inspections, operation, maintenance, and emergencies.
- Regularly meet to review overall facility operations and BMP effectiveness.

S454 BMPs for Preventive Maintenance / Good Housekeeping

Preventative maintenance and good housekeeping practices reduce the potential for stormwater to come into contact with pollutants and can reduce maintenance intervals for the drainage system and sewer system.

Applicable BMPs:

- Prevent the discharge of unpermitted liquid or solid wastes, process wastewater, and sewage to ground or surface water, or to storm drains that discharge to surface water, or to the ground. Conduct all oily parts cleaning, steam cleaning, or pressure washing of equipment or containers inside a building, or on an impervious contained area, such as a concrete pad. Direct contaminated stormwater from such an area to a sanitary sewer where allowed by local sewer authority, or to other approved treatment.
- Promptly contain and clean up solid and liquid pollutant leaks and spills including oils, solvents, fuels, and dust from manufacturing operations on an exposed soil, vegetation, or paved area.
- If a contaminated surface must be pressure washed, collect the resulting washwater for proper disposal (usually involves plugging storm drains, or otherwise preventing discharge and pumping or vactoring up washwater, for discharge to sanitary sewer or for vactor truck transport to a waste water treatment plant for disposal).
- Do not hose down pollutants from any area to the ground, storm drains, conveyance ditches, or receiving water. Convey pollutants before discharge to a treatment system approved by the local jurisdiction.
- Sweep all appropriate surfaces with vacuum sweepers quarterly, or more frequently as needed, for the collection and disposal of dust and debris that could contaminate stormwater. Use mechanical sweepers, and manual sweeping as necessary to access areas that a vacuum sweeper can't reach to ensure that all surface contaminants are routinely removed.
- Do not pave over contaminated soil unless it has been determined that ground water has not been and will not be contaminated by the soil. Call Ecology for assistance.
- Construct impervious areas that are compatible with the materials handled. Portland cement concrete, asphalt, or equivalent material may be considered.
- Use drip pans to collect leaks and spills from industrial/commercial equipment such as cranes at ship/boat building and repair facilities, log stackers, industrial parts, trucks and other vehicles stored outside.
- At industrial and commercial facilities, drain oil and fuel filters before disposal. Discard empty oil and fuel filters, oily rags, and other oily solid waste into appropriately closed and properly labeled containers, and in compliance with the Uniform Fire Code or International Building Code.
- For the storage of liquids use containers, such as steel and plastic drums, that are rigid and

durable, corrosion resistant to the weather and fluid content, non-absorbent, water tight, rodent-proof, and equipped with a close fitting cover.

- For the temporary storage of solid wastes contaminated with liquids or other potential polluted materials use dumpsters, garbage cans, drums, and comparable containers, which are durable, corrosion resistant, non-absorbent, non-leaking, and equipped with either a solid cover or screen cover to prevent littering. If covered with a screen, the container must be stored under a roof or other form of adequate cover.
- Where exposed to stormwater, use containers, piping, tubing, pumps, fittings, and valves that are appropriate for their intended use and for the contained liquid.
- Clean oils, debris, sludge, etc. from all stormwater facilities regularly, including catch basins, settling/detention basins, oil/water separators, boomed areas, and conveyance systems to prevent the contamination of stormwater. Refer to [Ecology Requirements for Generators of Dangerous Wastes](#) in [I-2.15 Other Requirements](#) for references to assist in handling potentially dangerous waste.
- Promptly repair or replace all substantially cracked or otherwise damaged paved secondary containment, high-intensity parking, and any other drainage areas, subjected to pollutant material leaks or spills. Promptly repair or replace all leaking connections, pipes, hoses, valves, etc., which can contaminate stormwater.
- Do not connect floor drains in potential pollutant source areas to storm drains, surface water, or to the ground.

Recommended BMPs:

- Where feasible, store potential stormwater pollutant materials inside a building or under a cover and/or containment.
- Minimize use of toxic cleaning solvents, such as chlorinated solvents, and other toxic chemicals.
- Use environmentally safe raw materials, products, additives, etc. such as substitutes for zinc used in rubber production.
- Recycle waste materials such as solvents, coolants, oils, degreasers, and batteries to the maximum extent feasible. Contact Ecology's *Hazardous Waste & Toxics Reduction Program* at <https://ecology.wa.gov/About-us/Get-to-know-us/Our-Programs/Hazardous-Waste-Toxics-Reduction> for recommendations on recycling or disposal of vehicle waste liquids and other waste materials.
- Empty drip pans immediately after a spill or leak is collected in an uncovered area.
- Stencil warning signs at stormwater catch basins and drains, e.g., “Dump no waste – Drains to waterbody”.
- Use solid absorbents, e.g., clay and peat absorbents and rags for cleanup of liquid spills/leaks, where practicable.
- Promptly repair/replace/reseal damaged paved areas at industrial facilities.

- Recycle materials, such as oils, solvents, and wood waste, to the maximum extent practicable.

Note: Evidence of stormwater contamination by oils and grease can include the presence of visible sheen, color, or turbidity in the runoff, or present or historical operational problems at the facility. Operators can use simple pH tests, for example with litmus or pH paper. These tests can screen for high or low pH levels (anything outside a 6.5-8.5 range) due to contamination in stormwater.

S455 BMPs for Spill Prevention and Cleanup

Description of Pollutant Sources: Spills and leaks can damage public infrastructure, interfere with sewage treatment, and cause a threat to human health or the environment. Spills are often preventable if appropriate chemical and waste handling techniques are practiced effectively and the spill response plan is immediately implemented. Additional spill control requirements may be required based on the specific activity occurring on site.

Applicable BMPs:

Spill Prevention

- Clearly label or mark all containers that contain potential pollutants.
- Store and transport liquid materials in appropriate containers with tight-fitting lids.
- Place drip pans underneath all containers, fittings, valves, and where materials are likely to spill or leak.
- Use tarpaulins, ground cloths, or drip pans in areas where materials are mixed, carried, and applied to capture any spilled materials.
- Train employees on the safe techniques for handling materials used on the site and to check for leaks and spills.

Spill Plan

- Develop and implement a spill plan and update it annually or whenever there is a change in activities or staff responsible for spill cleanup. Post a written summary of the plan at areas with a high potential for spills, such as loading docks, product storage areas, waste storage areas, and near a phone. The spill plan may need to be posted at multiple locations. Describe the facility, including the owner's name, address, and telephone number; the nature of the facility activity; and the general types of chemicals used at the facility.
- Designate spill response employees to be on-site during business activities. Provide a current list of the names and telephone numbers (home and office) of designated spill response employees who are responsible for implementing the spill plan.
- Provide a site plan showing the locations of storage areas for chemicals, inlets/catch basins, spill kits and other relevant infrastructure or materials information.
- Describe the emergency cleanup and disposal procedures. Note the location of all spill kits in

the spill plan.

- List the names and telephone numbers of public agencies to contact in the event of a spill.

Spill Cleanup Kits

- Store all cleanup kits near areas with a high potential for spills so that they are easily accessible in the event of a spill. The contents of the spill kit must be appropriate to the types and quantities of materials stored or otherwise used at the facility, and refilled when the materials are used. Spill kits must be located within 25 feet of all fueling/fuel transfer areas, including on-board mobile fuel trucks.

Note: Ecology recommends that the kit(s) include salvage drums or containers, such as high density polyethylene, polypropylene or polyethylene sheet-lined steel; polyethylene or equivalent disposal bags; an emergency response guidebook; safety gloves/clothes/equipment; shovels or other soil removal equipment; and oil containment booms and absorbent pads; all stored in an impervious container.

Spill Cleanup and Proper Disposal of Waste

- Stop, contain, and clean up all spills immediately upon discovery.
- Implement the spill plan immediately.
- Contact the designated spill response employees.
- Block off and seal nearby inlets/catch basins to prevent materials from entering the drainage system or combined sewer.
- Use the appropriate material to clean up the spill.
- Do not use emulsifiers or dispersants such as liquid detergents or degreasers unless disposed of properly. Emulsifiers and dispersants are not allowed to be used on surface water, or in a place where they may enter storm drains, surface waters, treatments systems, or sanitary sewers.
- Immediately notify Ecology and the local jurisdiction if a spill has reached or may reach a sanitary or storm sewer, ground water, or surface water. Notification must comply with state and federal spill reporting requirements.
- Do not wash absorbent material into interior floor drains or inlets/catch basins.
- Place used spill control materials in appropriate containers and dispose of according to regulations.

S456 BMPs for Employee Training

Train all employees that work in pollutant source areas about the following topics:

- Identifying Pollution Prevention Team Members.
- Identifying pollutant sources.

- Understanding pollutant control measures.
- Spill prevention and response.
- Emergency response procedures.
- Handling practices that are environmentally acceptable. Particularly those related to vehicle/equipment liquids such as fuels, and vehicle/equipment cleaning.

Additional specialized training may be needed for staff who will be responsible for handling hazardous materials.

S457 BMPs for Inspections

Qualified personnel shall conduct inspections monthly. Make and maintain a record of each inspection on-site. The following requirements apply to inspections:

- Be conducted by someone familiar with the facility's site, operations, and BMPs.
- Verify the accuracy of the pollutant source descriptions in the SWPPP.
- Assess all BMPs that have been implemented for effectiveness and needed maintenance and locate areas where additional BMPs are needed.
- Reflect current conditions on the site.
- Include written observations of the presence of floating materials, suspended solids, oil and grease, discoloration, turbidity and odor in the stormwater discharges; in outside vehicle maintenance/repair; and liquid handling, and storage areas. In areas where acid or alkaline materials are handled or stored use a simple litmus or pH paper to identify those types of stormwater contaminants where needed.
- Eliminate or obtain a permit for unpermitted non-stormwater discharges to storm drains or receiving waters, such as process wastewater and vehicle/equipment washwater.
- Identify actions to address inspection deficiencies.

S458 BMPs for Record Keeping

See the applicable permit for specific record-keeping requirements and retention schedules for the following reports. At a minimum, retain the following reports for five years:

- Inspection reports which should include:
 - Time and date of the inspection
 - Locations inspected
 - Statement on status of compliance with the permit
 - Summary report of any remediation activities required
 - Name, title, and signature of person conducting the inspection

- Reports on spills of oil or hazardous substances in greater than Reportable Quantities (Code of Federal Regulations Title 40 Parts 302.4 and 117). Report spills of the following: antifreeze, oil, gasoline, or diesel fuel, that cause:
 - A violation of the State of Washington's Water Quality Standards.
 - A film or sheen upon or discoloration of the waters of the State or adjoining shorelines.
 - A sludge or emulsion to be deposited beneath the surface of the water or upon adjoining shorelines.

To report a spill or to determine if a spill is a substance of a Reportable Quantity, call the Ecology regional office and ask for an oil spill operations or a dangerous waste specialist:

- Northwest Region (425)649-7000
- Southwest Region (360)407-6300
- Eastern Region (509)329-3400
- Central Region (509) 575-2490

In addition, call the Washington Emergency Management Division at 1-800-258-5990 or 1-800-OILS-911 AND the National Response Center at 1-800-424-8802.

Also, refer to *Focus on Emergency Spill Response* ([Ecology, 2009](#)).

The following is additional recommended record keeping:

Maintain records of all related pollutant control and pollutant generating activities such as training, materials purchased, material use and disposal, maintenance performed, etc.

S417 BMPs for Maintenance of Stormwater Drainage and Treatment Systems

Description of Pollutant Sources: Facilities include roadside catch basins on arterials and within residential areas, conveyance systems, detention facilities such as ponds and vaults, oil/water separators, biofilters, settling basins, infiltration systems, and all other types of stormwater treatment systems presented in [Volume V](#). Oil and grease, hydrocarbons, debris, heavy metals, sediments and contaminated water are found in catch basins, oil and water separators, settling basins, etc.

Pollutant Control Approach: Provide maintenance and cleaning of debris, sediments, and other pollutants from stormwater collection, conveyance, and treatment systems to maintain proper operation.

Applicable Operational BMPs:

Maintain stormwater treatment facilities per the operations and maintenance (O&M) procedures presented in [Appendix V-A: BMP Maintenance Tables](#) in addition to the following BMPs:

- Inspect and clean treatment BMPs, conveyance systems, and catch basins as needed, and determine necessary O&M improvements.
- Promptly repair any deterioration threatening the structural integrity of stormwater facilities. These include replacement of clean-out gates, catch basin lids, and rock in emergency spillways.
- Ensure adequacy of storm sewer capacities and prevent heavy sediment discharges to the sewer system.
- Regularly remove debris and sludge from BMPs used for peak-rate control, treatment, etc. and discharge to a sanitary sewer if approved by the sewer authority, or truck to an appropriate local or state government approved disposal site.
- Clean catch basins when the depth of deposits reaches 60 percent of the sump depth as measured from the bottom of basin to the invert of the lowest pipe into or out of the basin. However, in no case should there be less than six inches clearance from the debris surface to the invert of the lowest pipe. Some catch basins (for example, WSDOT's *Catch Basin Type 1L* ([WSDOT, 2011](#))) may have as little as 12 inches sediment storage below the invert. These catch basins need frequent inspection and cleaning to prevent scouring. Where these catch basins are part of a stormwater collection and treatment system, the system owner/operator may choose to concentrate maintenance efforts on downstream control devices as part of a systems approach.
- Properly dispose of all solids, polluted material, and stagnant water collected through system cleaning. Do not decant water back into the drainage system from eductor trucks or vacuum equipment since there may be residual contaminants in the cleaning equipment. Do not jet material downstream into the public drainage system.
- Clean woody debris in a catch basin as frequently as needed to ensure proper operation of the catch basin.
- Post warning signs; “Dump No Waste - Drains to Ground Water,” “Streams,” “Lakes,” or emboss on or adjacent to all storm drain inlets where possible.
- Disposal of sediments and liquids from the catch basins must comply with [Appendix IV-B: Management of Street Waste Solids and Liquids](#).

S421 BMPs for Parking and Storage of Vehicles and Equipment

Description of Pollutant Sources: Public and commercial parking lots such as retail store, fleet vehicle (including rent-a-car lots and car dealerships), equipment sale and rental parking lots, and

parking lot driveways, can be sources of toxic hydrocarbons and other organic compounds, including oils and greases, metals, and suspended solids.

Pollutant Control Approach: If the parking lot meets the site use thresholds to determine if the site is expected to generate high concentrations of oil, as defined in [Step 2: Determine if an Oil Control BMP is Required](#) in [III-1.2 Choosing Your Runoff Treatment BMPs](#), provide oil removal equipment for the contaminated stormwater runoff.

Applicable Operational BMPs:

- If a parking lot must be washed, discharge the washwater to a sanitary sewer, if allowed by the local sewer authority, or other approved wastewater treatment system, or collect washwater for off-site disposal.
- Do not hose down the area to a storm sewer or receiving water. Vacuum sweep parking lots, storage areas, and driveways regularly to collect dirt, waste, and debris. Mechanical or hand sweeping may be necessary for areas where a vacuum sweeper cannot reach.
- Clean up vehicle and equipment fluid drips and spills immediately.
- Place drip pans below leaking vehicles (including inoperative vehicles and equipment) in a manner that catches leaks or spills, including employee vehicles. Drip pans must be managed to prevent overfilling and the contents disposed of properly.

Recommended Operational BMPs:

- Encourage employees to repair leaking personal vehicles.
- Encourage employees to carpool or use public transit through incentives.
- Encourage customers to use public transit by rewarding valid transit pass holders with discounts.
- Install catch basin inserts to collect excess sediment and oil if necessary. Inspect and maintain catch basin inserts to ensure they are working correctly.

Applicable Treatment BMPs:

Establishments subject to high-use intensity are significant sources of oil contamination of stormwater. Examples of potential high use areas include customer parking lots at fast food stores, grocery stores, taverns, restaurants, large shopping malls, discount warehouse stores, quick-lube shops, and banks.

Refer to [Step 2: Determine if an Oil Control BMP is Required](#) in [III-1.2 Choosing Your Runoff Treatment BMPs](#) for the site use thresholds that determine if an oil control BMP is required, and for a list of oil control BMPs.

S411 BMPs for Landscaping and Lawn / Vegetation Management

Description of Pollutant Sources: Landscaping can include grading, soil transfer, vegetation planting, and vegetation removal. Examples include weed control on golf course lawns, access roads, and utility corridors and during landscaping; and residential lawn/plant care. Proper management of vegetation can minimize excess nutrients and pesticides.

Pollutant Control Approach: Maintain appropriate vegetation to control erosion and the discharge of stormwater pollutants. Prevent debris contamination of stormwater. Where practicable, grow plant species appropriate for the site, or adjust the soil properties of the site to grow desired plant species.

Applicable BMPs:

- Install engineered soil/landscape systems to improve the infiltration and regulation of stormwater in landscaped areas.
- Select the right plants for the planting location based on proposed use, available maintenance, soil conditions, sun exposure, water availability, height, sight factors, and space available.
- Ensure that plants selected for planting are not on the noxious weed list. For example, butterfly bush often gets planted as an ornamental but is actually on the noxious weed list.

The Washington State Noxious Weed List can be found at the following webpage:

<https://www.nwcb.wa.gov/printable-noxious-weed-list>

- Do not dispose of collected vegetation into waterways or storm sewer systems.
- Do not blow vegetation or other debris into the drainage system.
- Dispose of collected vegetation such as grass clippings, leaves, sticks by composting or recycling.
- Remove, bag, and dispose of class A & B noxious weeds in the garbage immediately.
- Do not compost noxious weeds as it may lead to spreading through seed or fragment if the composting process is not hot enough.
- Use manual and/or mechanical methods of vegetation removal (pincer-type weeding tools, flame weeders, or hot water weeders as appropriate) rather than applying herbicides, where practical.
- Use at least an eight-inch "topsoil" layer with at least 8 percent organic matter to provide a sufficient vegetation-growing medium.
 - Organic matter is the least water-soluble form of nutrients that can be added to the soil. Composted organic matter generally releases only between 2 and 10 percent of its total nitrogen annually, and this release corresponds closely to the plant growth cycle. Return natural plant debris and mulch to the soil, to continue recycling nutrients indefinitely.
- Select the appropriate turfgrass mixture for the climate and soil type.
 - Certain tall fescues and rye grasses resist insect attack because the symbiotic endophytic fungi found naturally in their tissues repel or kill common leaf and stem-eating lawn insects.

- The fungus causes no known adverse effects to the host plant or to humans.
 - Tall fescues and rye grasses do not repel root-feeding lawn pests such as Crane Fly larvae.
 - Tall fescues and rye grasses are toxic to ruminants such as cattle and sheep
- Endophytic grasses are commercially available; use them in areas such as parks or golf courses where grazing does not occur.
- Local agricultural or gardening resources such as Washington State University Extension office can offer advice on which types of grass are best suited to the area and soil type.
- Use the following seeding and planting BMPs, or equivalent BMPs, to obtain information on grass mixtures, temporary and permanent seeding procedures, maintenance of a recently planted area, and fertilizer application rates: [BMP C120: Temporary and Permanent Seeding](#), [BMP C121: Mulching](#), [BMP C123: Plastic Covering](#), and [BMP C124: Sodding](#).
- Adjusting the soil properties of the subject site can assist in selection of desired plant species. Consult a soil restoration specialist for site-specific conditions.

Recommended Additional BMPs:

- Conduct mulch-mowing whenever practicable.
- Use native plants in landscaping. Native plants do not require extensive fertilizer or pesticide applications. Native plants may also require less watering.
- Use mulch or other erosion control measures on soils exposed for more than one week during the dry season (May 1 to September 30) or two days during the rainy season (October 1 to April 30).
- Till a topsoil mix or composted organic material into the soil to create a well-mixed transition layer that encourages deeper root systems and drought-resistant plants.
- Apply an annual topdressing application of 3/8" compost. Amending existing landscapes and turf systems by increasing the percent organic matter and depth of topsoil can:
 - Substantially improve the permeability of the soil.
 - Increase the disease and drought resistance of the vegetation.
 - Reduces the demand for fertilizers and pesticides.
- Disinfect gardening tools after pruning diseased plants to prevent the spread of disease.
- Prune trees and shrubs in a manner appropriate for each species.
- If specific plants have a high mortality rate, assess the cause and replace with another more appropriate species.
- When working around and below mature trees, follow the most current American National Standards Institute (ANSI) ANSI A300 standards (see

http://www.tcia.org/TCIA/BUSINESS/ANSI_A300_Standards_/TCIA/BUSINESS/A300_Standards/A300_Standards.aspx?hkey=202ff566-4364-4686-b7c1-2a365af59669) and International Society of Arboriculture BMPs to the extent practicable (e.g., take care to minimize any damage to tree roots and avoid compaction of soil).

- Monitor tree support systems (stakes, guys, etc.).
 - Repair and adjust as needed to provide support and prevent tree damage.
 - Remove tree supports after one growing season or maximum of 1 year.
 - Backfill stake holes after removal.
- When continued, regular pruning (more than one time during the growing season) is required to maintain visual sight lines for safety or clearance along a walk or drive, consider relocating the plant to a more appropriate location.
- Make reasonable attempts to remove and dispose of class C noxious weeds.
- Re-seed bare turf areas until the vegetation fully covers the ground surface.
- Watch for and respond to new occurrences of especially aggressive weeds such as Himalayan blackberry, Japanese knotweed, morning glory, English ivy, and reed canary grass to avoid invasions.
- Plant and protect trees per [BMP T5.16: Tree Retention and Tree Planting](#).
- Aerate lawns regularly in areas of heavy use where the soil tends to become compacted. Conduct aeration while the grasses in the lawn are growing most vigorously. Remove layers of thatch greater than ¾-inch deep.
- Set the mowing height at the highest acceptable level and mow at times and intervals designed to minimize stress on the turf. Generally mowing only 1/3 of the grass blade height will prevent stressing the turf.
 - Mowing is a stress-creating activity for turfgrass.
 - Grass decreases its productivity when mowed too short and there is less growth of roots and rhizomes. The turf becomes less tolerant of environmental stresses, more disease prone and more reliant on outside means such as pesticides, fertilizers, and irrigation to remain healthy.

Additional BMP Information:

- King County's *Best Management Practices for Golf Course Development and Operation* ([King County, 1993](#)) has additional BMPs for Turfgrass Maintenance and Operation.
- King County, Seattle Public Utilities, and the Saving Water Partnership have created the following natural lawn and garden care resources that include guidance on building healthy soil with compost and mulch, selecting appropriate plants, watering, using alternatives to pesticides, and implementing natural lawn care techniques.

- *Natural Yard Care - Five steps to make your piece of the planet a healthier place to live* ([King County and SPU, 2008](#))
 - *The Natural Lawn & Garden Series: Smart Watering* ([Saving Water Partnership, 2006](#))
 - *Natural Lawn Care for Western Washington* ([Saving Water Partnership, 2007](#))
 - *The Natural Lawn & Garden Series: Growing Healthy Soil; Choosing the Right Plants; and Natural Pest, Weed and Disease Control* ([Saving Water Partnership, 2012](#))
- The International Society of Arboriculture (ISA) is a group that promotes the professional practice of arboriculture and fosters a greater worldwide awareness of the benefits of trees through research, technology, and education. ISA standards used for managing trees, shrubs, and other woody plants are the American National Standards Institute (ANSI) A300 standards. The ANSI A300 standards are voluntary industry consensus standards developed by the Tree Care Industry Association (TCIA) and written by the Accredited Standards Committee (ASC). The ANSI standards can be found on the ISA website: www.isa-arbor.com/education/publications/index.aspx
 - Washington State University's *Gardening in Washington State* website at <http://gardening.wsu.edu> contains Washington State specific information about vegetation management based on the type of landscape.
 - See the *Pacific Northwest Plant Disease Management Handbook* ([Pscheidt and Ocamb, 2016](#)) for information on disease recognition and for additional resources.

S435 BMPs for Pesticides and an Integrated Pest Management Program

Description of Pollutant Sources: Pesticides include herbicides, rodenticides, insecticides, fungicides, etc. Examples of pesticide uses include:

- Weed control on golf course lawns, access roads, utility corridors and landscaping.
- Sap stain and insect control on lumber and logs.
- Rooftop moss removal.
- Killing nuisance rodents.
- Fungicide application to patio decks.

It is possible to release toxic pesticides such as pentachlorophenol, carbamates, and organo-metallics to the environment by leaching and dripping from treated parts, container leaks, product misuse, and outside storage of pesticide contaminated materials and equipment. Poor management of pesticides can cause appreciable stormwater contamination and unintended impacts to non-targeted organisms.

Pollutant Control Approach: Control of pesticide applications to prevent contamination of stormwater. Develop and implement an Integrated Pest Management (IPM) Plan. Carefully apply pesticides, in accordance with label requirements.

Applicable Operational BMPs:

- Train employees on proper application of pesticides and disposal practices.
- Follow manufacturers' application guidelines and label requirements.
- Do not apply pesticides in quantities that exceed the limits on the product the Federal Insecticide, Fungicide, and Rodenticide Act (FIFRA) label. Avoid excessive application of chemical.
- Conduct spray applications during weather conditions as specified in the label requirements and applicable local and state regulations. Do not apply during rain or immediately before expected rain (unless the label directs such timing).
- Clean up any spilled pesticides immediately. Do not hose down to a storm drain, conveyance ditch, or water body.
- Remove weeds/vegetation in stormwater ditches, stormwater facilities, and drainage systems by hand or other mechanical means and only use pesticides as a last resort.
- Flag all sensitive areas including wells, creeks, and wetlands prior to spraying.
- Post notices and delineate the spray area prior to the application, as required by the local jurisdiction, or by Ecology.
- Refer to [S411 BMPs for Landscaping and Lawn / Vegetation Management](#) and use pesticides only as a last resort.
- Conduct any pest control activity at the life stage when the pest is most vulnerable. For example, if it is necessary to use a *Bacillus thuringiensis* application to control tent caterpillars, apply it to the material before the caterpillars cocoon or it will be ineffective. Any method used should be site-specific and not used wholesale over a wide area.
- Mix pesticides and clean the application equipment under cover in an area where accidental spills will not enter surface or ground waters, and will not contaminate the soil.
- The pesticide application equipment must be capable of immediate shutoff in the event of an emergency.
- Implement a pesticide-use plan and include at a minimum:
 - A list of selected pesticides and their specific uses.
 - Brands and formulations of the pesticides.
 - Application methods and quantities to be used.
 - Equipment use and maintenance procedures.
 - Safety, storage, and disposal methods.
 - Monitoring, record keeping, and public notice procedures. All procedures shall conform to the requirements of [Chapter 17.21 RCW](#) and [Chapter 16-228 WAC](#).
- Develop and implement an Integrated Pest Management (IPM) program if pests are present.

The following steps are adapted from ([Daar, 1992](#)).

- **Step One:** Correctly identify problem pests and understand their life cycle.
 - Learn more about the pest.
 - Observe it and pay attention to any damage that may be occurring.
 - Learn about the life cycle.
 - Many pests are only a problem during certain seasons, or can only be treated effectively in certain phases of the life cycle.
- **Step Two:** Establish tolerance thresholds for pests.
 - Decide on the level of infestation that must be exceeded before treatment needs to be considered. Pest populations under this threshold should be monitored but don't need treatment.
- **Step Three:** Monitor to detect and prevent pest problems.
 - Monitor regularly to anticipate and prevent major pest outbreaks.
 - Conduct a visual evaluation of the lawn or landscape's condition. Take a few minutes before mowing to walk around and look for problems.
 - Keep a notebook, record when and where a problem occurs, then monitor for it at about the same time in future years.
 - Specific monitoring techniques can be used in the appropriate season for some potential problem pests, such as European crane fly.
- **Step Four:** Modify the maintenance program to promote healthy plants and discourage pests.
 - Review your landscape maintenance practices to see if they can be modified to prevent or reduce the problem.
 - A healthy landscape is resistant to most pest problems. Lawn aeration and overseeding along with proper mowing height, fertilization, and irrigation will help the grass out-compete weeds.
 - Correcting drainage problems and letting soil dry out between waterings in the summer may reduce the number of crane-fly larvae that survive.
- **Step Five:** If pests exceed the tolerance thresholds:
 - Consider the most effective management options concurrent with reducing impacts to the environment. This may mean chemical pesticides are the best option in some circumstances.
 - Consider the use of physical, mechanical, or biological controls.
 - Study to determine what products are available and choose a product that is the least toxic and has the least non-target impact.

- **Step Six:** Evaluate and record the effectiveness of the control, and modify maintenance practices to support lawn or landscape recovery and prevent recurrence.
 - Keep records!
 - Note when, where, and what symptoms occurred, or when monitoring revealed a potential pest problem.
 - Note what controls were applied and when, and the effectiveness of the control.
 - Monitor next year for the same problems.

Recommended Additional Operational BMPs:

- Choose the least toxic pesticide available that is capable of reducing the infestation to acceptable levels. The pesticide should readily degrade in the environment and/or have properties that strongly bind it to the soil.
- Choose pesticides categorized by EPA as reduced risk. For example, the herbicide imazamox.
- When possible, apply pesticides during the dry season so that the pesticide residue is degraded prior to the next rain event.
- If possible, do not spray pesticides within 100 feet of water bodies. Spraying pesticides within 100 feet of water bodies including any drainage ditch or channel that leads to open water may have additional regulatory requirements beyond just following the pesticide product label. Additional requirements may include:
 - Obtaining a discharge permit from Ecology.
 - Obtaining a permit from the local jurisdiction.
 - Using an aquatic labeled pesticide and adjuvant.
- Use manual pest control strategies such as physically scraping moss from rooftops, high-pressure sprayers to remove moss, and rodent traps.
- Consider alternatives to the use of pesticides such as covering or harvesting weeds, substitute vegetative growth, and manual weed control/moss removal.
- Consider the use of soil amendments, such as compost, that are known to control some common diseases in plants, such as Pythium root rot, ash stem blight, and parasitic nematodes.
- Once a pesticide is applied, evaluate its effectiveness for possible improvement. Records should be kept showing the effectiveness of the pesticides applied.
- Follow the FIFRA label requirements for disposal. If the FIFRA label does not have disposal requirements the rinseate from equipment cleaning and/or triple-rinsing of pesticide containers should be used as product or recycled into product.
- Develop an and adaptive management plan and annual evaluation procedure including: (adapted from [Daar, 1992](#))

- A review of the effectiveness of pesticide applications.
- Impact on buffers and sensitive areas, including potable wells. If individual or public potable wells are located in the proximity of commercial pesticide applications, contact the regional Ecology hydrogeologist to determine if additional pesticide application control measures are necessary.
- Public concerns.
- Recent toxicological information on pesticides used/proposed for use.

Additional Information

For more information, refer to the Pesticide Information Center Online (PICOL) Databases at <http://cru66.cahe.wsu.edu/LabelTolerance.html>.

Washington pesticide law requires most businesses that commercially apply pesticides to the property of another to be licensed as a Commercial Applicator from the Washington State Department of Agriculture.

S444 BMPs for the Storage of Dry Pesticides and Fertilizers

Description of Pollutant Sources: Pesticides such as pentachlorophenol, carbamates, and organometallics can be released to the environment as a result of container leaks and outside storage of pesticide-contaminated materials and equipment. Inappropriate management of pesticides or fertilizers can result in stormwater contamination. Runoff contaminated by pesticides and fertilizers can severely degrade streams and lakes and adversely affect fish and other aquatic life.

Pollutant Control Approach: Store fertilizer and pesticide properly to prevent stormwater contamination.

Applicable Structural BMPs:

Store pesticides and fertilizers in enclosed impervious containment areas that prevent precipitation or unauthorized personnel from coming into contact with the materials..

Applicable Operational BMPs:

- Containers and bags must be covered, intact, and off the ground.
- Store all material so that it cannot come into contact with water.
- Immediately clean up any spilled fertilizer or pesticides.
- Keep pesticide and fertilizer contaminated waste materials in designated covered and contained areas, and dispose of properly.
- Store and maintain spill cleanup materials near the storage area.
- Sweep paved storage areas as needed. Collect and dispose of spilled materials. Do not hose

down the area.

- Do not discharge pesticide contaminated stormwater or spills/leaks of pesticides to storm sewers or to the sanitary sewer. Contaminated stormwater must be collected and disposed of properly. Unused or spilled/leaked pesticides must be disposed of according to the label.
- Comply with [WAC 16-228-1220](#) and [Chapter 16-229 WAC](#).

S412 BMPs for Loading and Unloading Areas for Liquid or Solid Material

Description of Pollutant Sources: Operators typically conduct loading/unloading of liquid and solid materials at industrial and commercial facilities at shipping and receiving, outside storage, fueling areas, etc. Materials transferred can include products, raw materials, intermediate products,

waste materials, fuels, scrap metals, etc. Leaks and spills of fuels, oils, powders, organics, heavy metals, salts, acids, alkalis, etc. during transfer may cause stormwater contamination. Spills from hydraulic line breaks are a common problem at loading docks.

Pollutant Control Approach: Cover and contain the loading/unloading area where necessary to prevent run-on of stormwater and runoff of contaminated stormwater.

Applicable Operational BMPs:

At All Loading/ Unloading Areas

- A significant amount of debris can accumulate at outside, uncovered loading/unloading areas. Sweep these surfaces frequently to remove loose material that could contaminate stormwater. Sweep areas temporarily covered after removal of the containers, logs, or other material covering the ground.
- Place drip pans, or other appropriate temporary containment device, at locations where leaks or spills may occur such as hose connections, hose reels and filler nozzles. Always use drip pans when making and breaking connections (see [Figure IV-6.2: Drip Pan](#)). Check loading/unloading equipment such as valves, pumps, flanges, and connections regularly for leaks and repair as needed.

Figure IV-6.2: Drip Pan

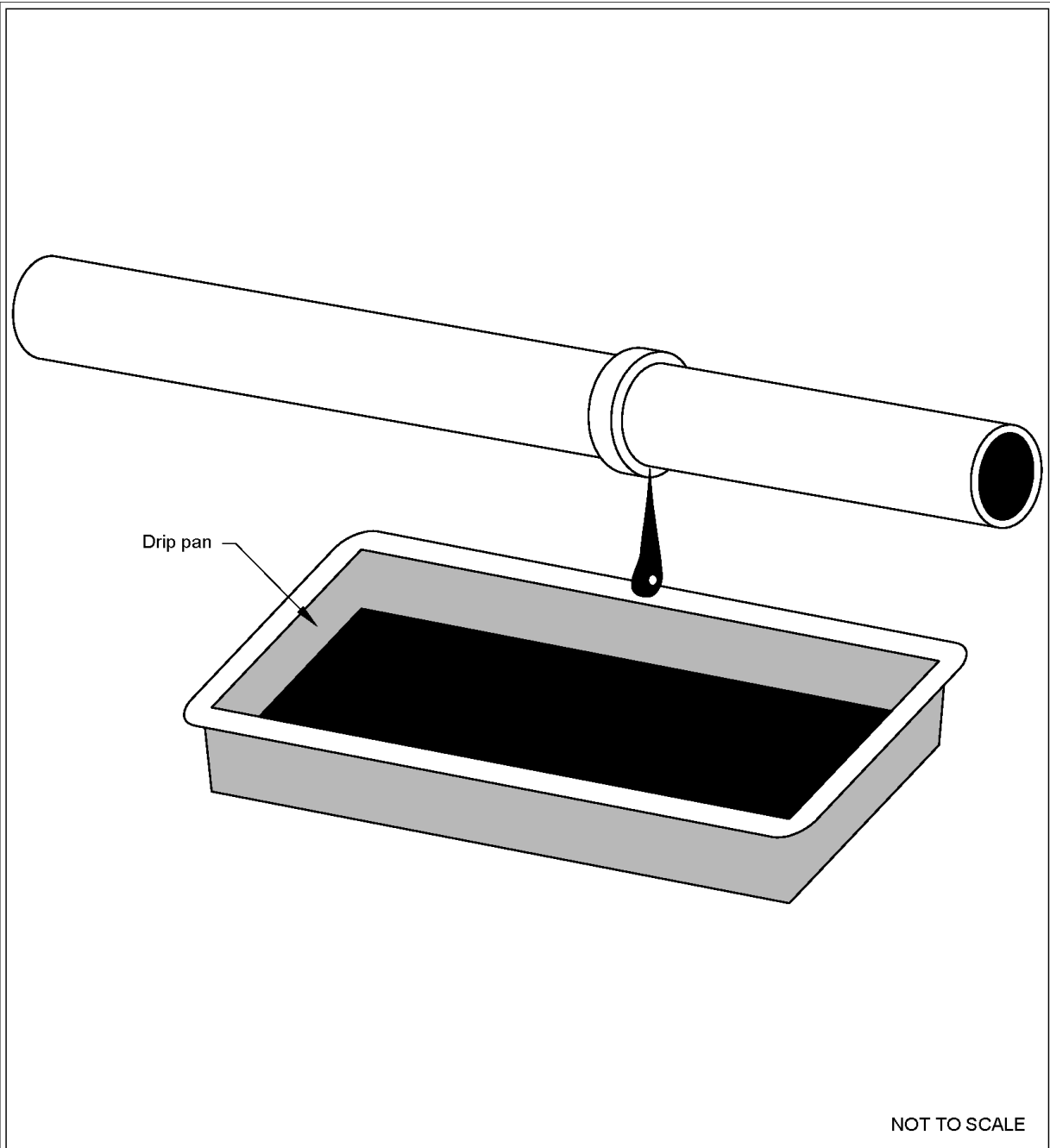

Drip Pan

Revised June 2016

Please see <http://www.ecy.wa.gov/copyright.html> for copyright notice including permissions, limitation of liability, and disclaimer.

At Tanker Truck and Rail Transfer Areas to Above/Below-ground Storage Tanks

- To minimize the risk of accidental spillage, prepare an "Operations Plan" that describes procedures for loading/unloading. Train employees in its execution and post it or otherwise have it readily available to all employees.
- Report spills of reportable quantities to Ecology.
- Prepare and implement an Emergency Spill Cleanup Plan for the facility (See [S426 BMPs for Spills of Oil and Hazardous Substances](#)) which includes the following BMPs:
 - Ensure the cleanup of liquid/solid spills in the loading/unloading area immediately, if a significant spill occurs, and, upon completion of the loading/unloading activity, or, at the end of the working day.
 - Retain and maintain an appropriate oil spill cleanup kit on-site for rapid cleanup of material spills. (See [S426 BMPs for Spills of Oil and Hazardous Substances](#)).
 - Ensure that an employee trained in spill containment and cleanup is present during loading/unloading.

At Rail Transfer Areas to Above/below-ground Storage Tanks

Install a drip pan system as illustrated (see [Figure IV-6.3: Drip Pan Within Rails](#)) within the rails to collect spills/leaks from tank cars and hose connections, hose reels, and filler nozzles.

Figure IV-6.3: Drip Pan Within Rails

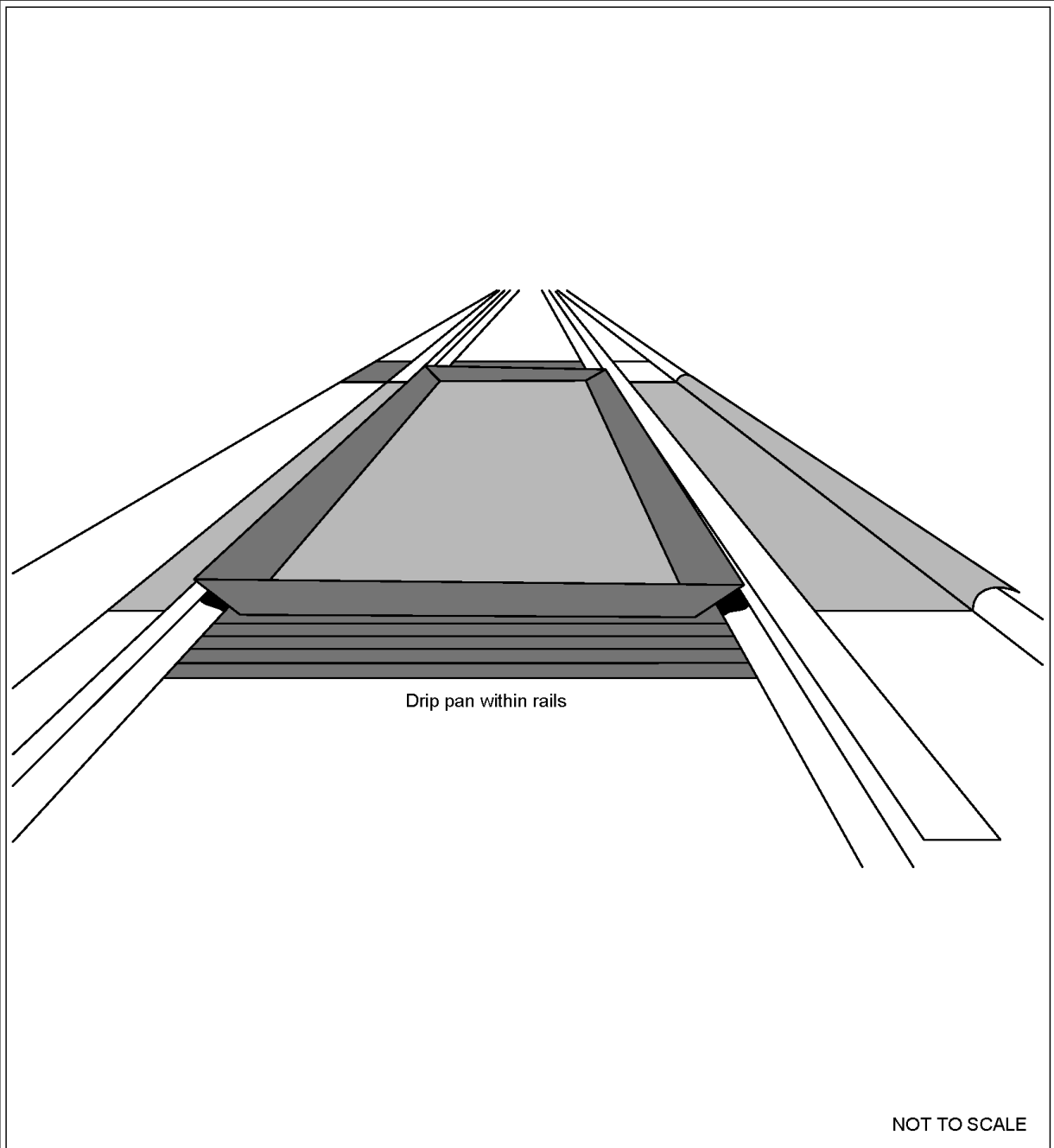

Drip Pan Within Rails

Revised June 2016

Please see <http://www.ecy.wa.gov/copyright.html> for copyright notice including permissions, limitation of liability, and disclaimer.

Loading/Unloading from/to Marine Vessels

Facilities and procedures for the loading or unloading of petroleum products must comply with Coast Guard requirements specified in [Coast Guard Requirements for Marine Transfer of Petroleum Products](#) within [I-2.15 Other Requirements](#).

Transfer of Small Quantities from Tanks and Containers

Refer to [S428 BMPs for Storage of Liquids in Permanent Aboveground Tanks](#) and [S427 BMPs for Storage of Liquid, Food Waste, or Dangerous Waste Containers](#) for requirements on the transfer of small quantities from tanks and containers, respectively.

Applicable Structural Source Control BMPs:

At All Loading/ Unloading Areas

- Consistent with Uniform Fire Code requirements (see [Uniform Fire Code Requirements](#) within [I-2.15 Other Requirements](#)) and to the extent practicable, conduct unloading or loading of solids and liquids in a manufactured building, under a roof, or lean-to, or other appropriate cover.
- Berm, dike, and/or slope the loading/unloading area to prevent run-on of stormwater and to prevent the runoff or loss of any spilled material from the area.
- Place curbs along the edge of the shoreline, or slope the edge such that the stormwater can flow to an internal storm sewer system that leads to an approved treatment BMP. Avoid draining directly to the surface water from loading areas.
- Pave and slope loading/unloading areas to prevent the pooling of water. Minimize the use of catch basins and drain lines within the interior of the paved area or place catch basins in designated “alleyways” that are not covered by material, containers, or equipment.
- Retain on-site the necessary materials for rapid cleanup of spills.

Recommended Structural Source Control BMPs:

For the transfer of pollutant liquids in areas that cannot contain a catastrophic spill, install an automatic shutoff system in case of unanticipated off-loading interruption (e.g. coupling break, hose rupture, overfill, etc.).

At Loading and Unloading Docks

- Install/maintain overhangs, or door skirts that enclose the trailer end (see [Figure IV-6.4: Loading Dock with Door Skirt](#) and [Figure IV-6.5: Loading Dock with Overhang](#)) to prevent contact with rainwater.
- Design the loading/unloading area with berms, sloping, etc., to prevent the run-on of stormwater.

Figure IV-6.4: Loading Dock with Door Skirt

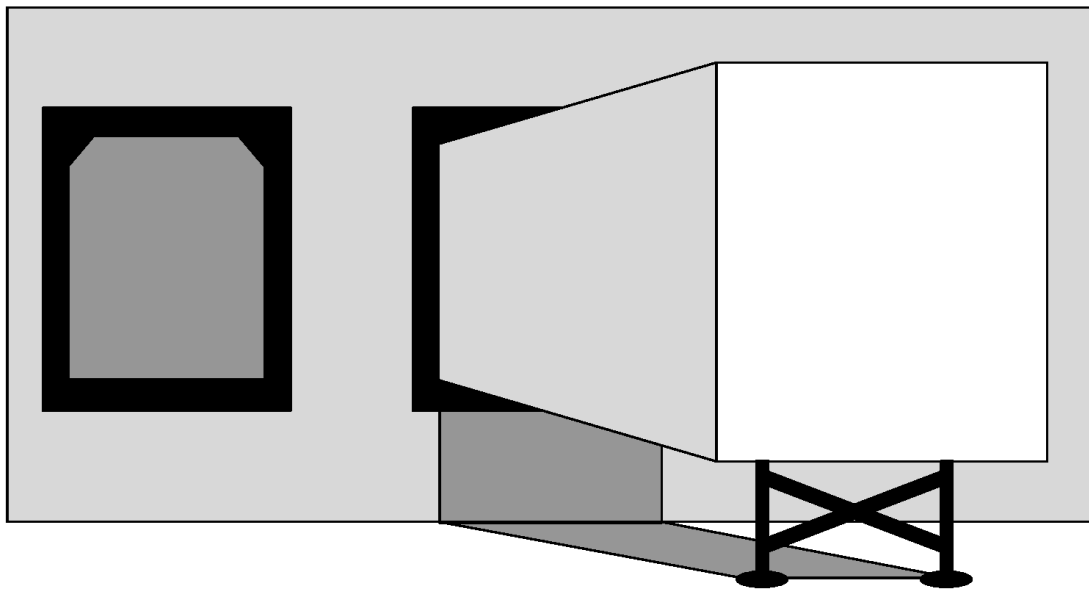

NOT TO SCALE



Loading Dock with Door Skirt

Revised June 2016

Please see <http://www.ecy.wa.gov/copyright.html> for copyright notice including permissions, limitation of liability, and disclaimer.

Figure IV-6.5: Loading Dock with Overhang

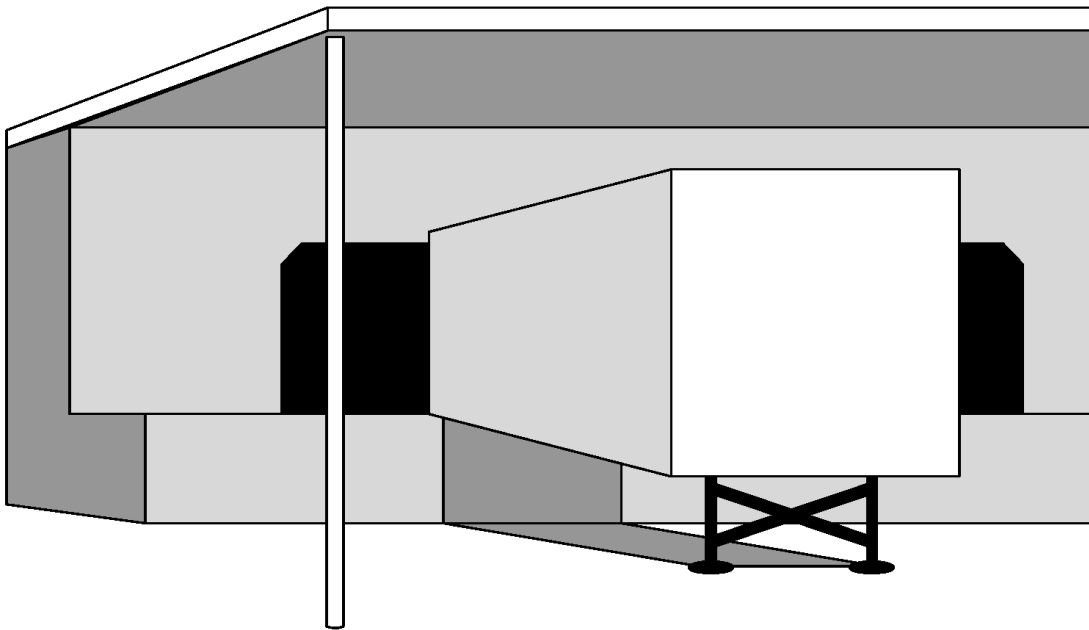

NOT TO SCALE



Loading Dock with Overhang

Revised June 2016

Please see <http://www.ecy.wa.gov/copyright.html> for copyright notice including permissions, limitation of liability, and disclaimer.

At Tanker Truck Transfer Areas to Above/Below-Ground Storage Tanks

- Pave the area on which the transfer takes place. If any transferred liquid, such as gasoline, is reactive with asphalt, pave the area with Portland cement concrete.
- Slope, berm, or dike the transfer area to a dead-end sump, spill containment sump, a spill control oil/water separator, or other spill control device. The minimum spill retention time should be 15 minutes at the greater flow rate of the highest fuel dispenser nozzle through-put rate, or the peak flow rate of the 6-month, 24-hour storm event over the surface of the containment pad, whichever is greater. The capacity of the spill containment sump should be a minimum of 50 gallons with adequate additional capacity provided for grit sedimentation.

S426 BMPs for Spills of Oil and Hazardous Substances

Description of Pollutant Sources: Washington Administrative Code requires owners or operators of facilities engaged in drilling, producing, gathering, storing, processing, transferring, distributing, refining, or consuming oil and/or oil products to have a Spill Prevention and Emergency Cleanup Plan (SPECP). The SPECP is required if the above ground storage capacity of the facility is 1,320 gallons or more of oil. Additionally, the SPECP is required if the facility, due to its location, could reasonably be expected to discharge oil in harmful quantities, as defined in 40 CFR Part 110, into or upon the navigable waters of the United States or adjoining shorelines {40 CFR 112.1 (b)}. Onshore and offshore facilities, which, due to their location, could not reasonably be expected to discharge oil into or upon the navigable waters of the United States or adjoining shorelines are exempt from these regulations {40 CFR 112.1(d)(1)(i)}. State Law requires owners of businesses that produce dangerous wastes to have a SPECP. These businesses should refer to [Washington State/Federal Emergency Spill Cleanup Requirements](#) (see [I-2.15 Other Requirements](#)). The federal definition of oil is oil of any kind or any form, including, but not limited to petroleum, fuel oil, sludge, oil refuse, and oil mixed with wastes other than dredged spoil.

Pollutant Control Approach: Maintain, update, and implement a Spill Prevention and Emergency Cleanup Plan.

Applicable Operational BMPs:

The businesses and public agencies identified in [Appendix IV-A: Urban Land Uses and Pollutant Generating Sources](#) required to prepare and implement a Spill Prevention and Emergency Cleanup Plan shall implement the following:

- Prepare a Spill Prevention and Emergency Cleanup Plan (SPECP), which includes:
 - A description of the facility including the owner's name and address.
 - The nature of the activity at the facility.
 - The general types of chemicals used or stored at the facility.
 - A site plan showing the location of storage areas for chemicals, the locations of storm drains, the areas draining to them, and the location and description of any devices to stop spills from leaving the site such as positive control valves.
 - Cleanup procedures.
 - Notification procedures used in the event of a spill, such as notifying key personnel. Agencies such as Ecology, local fire department(s), Washington State Patrol, and the local Sewer Authority, shall be notified.
 - The name of the designated person with overall spill cleanup and notification responsibility.
- Train key personnel in the implementation of the SPECP. Prepare a summary of the plan and post it at appropriate points in the building, identifying the spill cleanup coordinators, location of cleanup kits, and phone numbers of regulatory agencies to contact in the event of a spill.
- Update the SPECP regularly.
- Immediately notify Ecology, the local jurisdiction, and the local Sewer Authority if a spill may reach sanitary or storm sewers, ground water, or surface water, in accordance with federal and Ecology spill reporting requirements.
- Immediately clean up spills. Do not use emulsifiers for cleanup unless there is an appropriate disposal method for the resulting oily wastewater. Do not wash absorbent material down a floor drain or into a storm sewer.
- Locate emergency spill containment and cleanup kit(s) in high-potential spill areas. The contents of the kit shall be appropriate for the type and quantities of chemical liquids stored at the facility.

Recommended Additional Operational BMP:

Spill kits should include appropriately lined drums, absorbent pads, and granular or powdered materials for neutralizing acids or alkaline liquids where applicable. In fueling areas: Package absorbent

material in small bags for easy use and make available small drums for storage of absorbent and/or used absorbent. Deploy spill kits in a manner that allows rapid access and use by employees.

S424 BMPs for Roof / Building Drains at Manufacturing and Commercial Buildings

Description of Pollutant Sources: Stormwater runoff from roofs and sides of manufacturing and commercial buildings can be sources of pollutants caused by leaching of roofing materials, paints, caulking, building vents, and other air emission sources. Research has identified vapors and entrained liquid and solid droplets/particles as potential pollutants in roof/building runoff. Metals, solvents, acidic/alkaline pH, BOD, PCBs, and organics are some of the pollutant constituents identified.

Ecology has performed a study on zinc in industrial stormwater. The study is presented in *Suggested Practices to Reduce Zinc Concentrations in Industrial Stormwater Discharges* ([Ecology, 2008](#)). The user should refer to this document for more details on addressing zinc in stormwater.

Pollutant Control Approach: Evaluate the potential sources of stormwater pollutants and apply source control BMPs where feasible.

Applicable Operational Source Control BMPs:

- If leachates and/or emissions from buildings are suspected sources of stormwater pollutants, then sample and analyze the stormwater draining from the building.
- Sweep the area routinely to remove any residual pollutants.
- If a roof/building stormwater pollutant source is identified, implement appropriate source control measures such as air pollution control equipment, selection of materials, operational changes, material recycle, process changes, etc.

Applicable Structural Source Control BMPs:

- Paint/coat the galvanized surfaces as described in *Suggested Practices to Reduce Zinc Concentrations in Industrial Stormwater Discharges* ([Ecology, 2008](#)).

Applicable Treatment BMPs:

Treat runoff from roofs to the appropriate level. The facility may use Enhanced Treatment BMPs as described in [III-1.2 Choosing Your Runoff Treatment BMPs](#). Some facilities regulated by the Industrial Stormwater General Permit, or local jurisdiction, may have requirements that cannot be achieved with Enhanced Treatment BMPs. In these cases, additional treatment measures may be required. A treatment method for meeting stringent requirements such as Chitosan-Enhanced Sand Filtration may be appropriate.