



11409 58<sup>Th</sup> Ave E- Puyallup, WA. 98373

FIRE ALARM

SUBMITTALS

**COPPERBERRY  
CONDOS SOUTH  
BUILDING**

**4002 10TH ST CT  
PUYALLUP WA 98374**

### Features

- 50 addresses available on this analog addressable system
- Additional system capacity achieved via multi-point SLC modules
- 99 software zones
- NFPA 72 Compliant Smoke Sensitivity Test Built-In
- System Operates as Class A or Class B for SLC, P-Link and NACs
- 5 Amp Power Supply, Expandable to 310 amps
- 2 NACS, Regulated, Rated at 3 Amps each, expandable to 188
- 2 Input/Output (I/O) Circuits for system flexibility rated at 1 Amp each
- Strobe Synchronization and System Wide Sync for Gentex®, AMSECO®, Cooper Wheelock® and System Sensor® strobes
- Dedicated Alarm, Supervisory and Trouble Relays
- 4,000 Event History Buffer
- Optional two line DACT with UD-2000 that can report General, Zone or Point Information
- Built in IP Communicator
- Ethernet Port for Programming and Network Connectivity
- E-Mail System Status, Reports and Event Information
- Product includes 5 year warranty.



NYC Fire Dept.  
Certificate of Approval  
6256



7165-0328:0509 S735

### Description

The AFC-50 is an analog/addressable fire alarm system with a total system capacity of 50 addresses. Additional capacity on the system is achieved using multi-point SLC modules. The control panel utilizes the exclusive Potter protocol that includes a complete line of sensors and modules. Each SLC may be comprised of any combination of smoke sensor, heat detectors or modules and allows for a total of 50 ohms of impedance and may use any wire compliant with the National Electrical Code (NEC).

The AFC-50 has a 5 Amp power supply with two Notification Appliance Circuits (NACs) and two Input/Output (I/O) circuits. The NACs are rated at 3 Amps each and the I/Os are rated at 1 Amp each. Each output is regulated and power limited. In addition, each output is uniquely programmable and may be configured for steady signal, strobe synchronization, constant power, door holder power, or releasing. The strobe synchronization includes Gentex, AMSECO, System Sensor and Cooper/Wheelock and with the exclusive Quadrasync each output may have a unique brand and all strobes will flash together.

The NACs may be expanded using the PSN-1000 series intelligent power supplies. Each PSN-1000 adds another 10 Amps of power, 2 additional input circuits and the AFC-50 will support up to 31 power supplies. The system will synchronize the strobes system wide. In addition, the PSN-1000E has space to allow the installation of up to six expansion cards. The cards mount on a stacker bracket that allows access to all circuit connections.

### Technical Specifications

Dimensions	16"W x 17"H x 3 1/8"D
AC Mains	3.0 Amps @ 120 VAC 50/60 HZ 2.0 Amps @ 240 VAC 50/60 HZ
Enclosure	16 gauge cold rolled steel with removable locked door with Lexan viewing window
Battery	Standby Current-130 mA Alarm Current-200 mA <ul style="list-style-type: none"> <li>• 5 Amps power for NACs, I/O, and P-Link</li> <li>• 3 Amps per NAC, regulated</li> <li>• 1 Amp per I/O circuit, regulated</li> <li>• Battery Charger range 8-55 Ah</li> <li>• Battery Charger voltage 27.3 VDC</li> <li>• P-Link maximum current of 1 Amp</li> </ul>
Temperature and Humidity Range	32° to 120° (0°C to 49°C) with a maximum humidity of 93% non-condensing.
Standards	<ul style="list-style-type: none"> <li>• NFPA, 13, 15, 16, 17, 17A, 70, 72, and 750</li> <li>• ANSI/UL 864 - Local (L), Remote Station (RS), Central Station (CS), Propriety (PPU), Auxiliary (AUX), Type of Service: Automatic (A), Manual (M), Water flow (WF), Sprinkler Supervisory (SS), Type of Signaling: Digital Alarm Communicator (DAC), March Time (March), Non Coded (NC), Reverse Polarity (Rev Pol), Other Technologies (OT)</li> <li>• IBC (International Building Code)</li> </ul>

## SLC Loop Accessories

The control panel may be connected with up to 50 addressable devices or modules in any combination. The SLC is not restricted by any special wire requirements and may be wired with any wire that complies with the NEC.

## SLC Loop Devices

Device	Description
PAD Series-PD	Analog Photoelectric Smoke Detector is a smoke detector with a listed obscuration of 1.1 to 3.5%/foot. UL 268 7th Edition.
PAD Series-PHD	Combination Analog Photoelectric Smoke/Heat Detector – a smoke detector with a listed obscuration of 1.1 to 3.5 %/foot obscuration and a fixed temperature range of 135° to 185° F heat detector. Smoke detection compliant with UL 268 7th Edition.
PAD Series-PCD	Combination Photoelectric Smoke/Carbon Monoxide Detector. Smoke detection compliant with UL 268 7th Edition. Carbon Monoxide detection compliant with UL 2075.
PAD200-PCHD	Combination Photoelectric Smoke/Heat/Carbon Monoxide Detector. Smoke detection compliant with UL 268 7th Edition. Heat detection with a fixed temperature range of 135° to 185° F and UL 521 7th Edition compliant. Carbon Monoxide detection compliant with UL 2075.
PAD Series-HD	Analog Fixed Temperature (135° - 185°F) or Rate-of-Rise Heat Detector (software selectable).
PAD Series-DUCTR	Addressable Duct Smoke Detector with Form C Relay rate at 10Amps @ 250/120VAC or 8 Amps at 30VDC.
PAD Series-DUCT	Addressable Duct Smoke Detector.
PAD100-6DB	6” round base that is mountable to an electrical box and wired for connection to the PAD100/200 devices.
PAD100-4DB	4” round base that may be mounted to an electrical box and wired for connection to the PAD100/200 devices.
PAD100-IB	Isolator base that interrupts a short in a SLC and prevents the short from affecting protected devices on the loop and used for connection to the PAD100/200 devices.
PAD100-RB	Addressable Relay Base that contains one relay controlled by the SLC. Relay at rated at 2 amps at 30 VDC or 0.5A at 125VAC. For PAD100/200 devices only.
PAD100-SB	Addressable Sounder Base that contains an addressable sounder module which allows for configuration of local, group, and/or all call. For PAD100/200 devices only.
PAD Series-CD	Addressable CO gas detector.
PAD200-DD	Addressable photoelectric smoke detector for use in DUCT/DUCTR enclosure.
PAD300-DD	Addressable photoelectric smoke detector for use in DUCT/DUCTR enclosure or pendant mount applications.
PAD100-LFSB	Addressable Low Frequency Sounder Base that contains an addressable sounder module which allows for configuration of local, group, and/or all call. The LFSB complies with the Low Frequency Signal Requirements (520 Hz) and used for connection to the PAD100/200 devices.
PAD100-SPKB	Speaker base is a wall or ceiling mount speaker capable of 25 or 70.7 VRMS and is field selectable from 1/8W to 4W and used for connection with the PAD100/200 devices.
PAD300-6DB	6” round base which is mountable to an electrical box and wired for connection to the PAD300 devices.
PAD300-4DB	4” round base which is mountable to an electrical box and wired for connection to the to the PAD300 devices.
PAD300-IB	Isolator base that interrupts a short in a SLC and prevents the short from affecting protected devices on the loop. Used for connection to the PAD300 devices.
PAD300-RB	Addressable Relay Base that contains one relay controlled by the SLC. The Relay is rated 2 amps at 30 VDC or 0.5A at 125VAC and used for connection to the PAD300 devices
PAD300-SB	Addressable Sounder Base that contains an addressable sounder module which allows for configuration of local, group, and/or all call; and used for connection to the PAD300 devices.
PAD300-LFSB	Addressable Low Frequency Sounder Base that contains an addressable sounder module which allows for configuration of local, group, and/or all call. The LFSB complies with the Low Frequency Signal Requirements (520 Hz) and used for a connection to the PAD300 devices.

## Modules

Device	Description
PAD100-MIM	Micro Input Module provides a small foot print contact module for mounting inside an enclosure.
PAD100-PSSA	Single Action Addressable Pull Station.
PAD100-PSDA	Dual Action Addressable Pull Station.
PAD100-SIM	Single Input Module is a standard contact module with an LED that mounts into a 4" square electrical box.
PAD100-DIM	Dual Input Module is a device that can monitor two distinct inputs with a single device or in a Class A mode.
PAD100-TRTI	Two Relay Two Input module provides two form C relays that are individually controlled by the control panel. Each relay is rated for 2 amps at 30VDC or 0.5 amps at 125VAC. Also provides two contact inputs.
PAD100-NAC	Notification Appliance Circuit module is an addressable remote appliance circuit controlled by the panel.
PAD100-ZM	Zone Module is used to connect conventional 2-wire smoke detectors to the system.
PAD100-IM	Isolater Module interrupts a short on the SLC and prevents the short from affecting protected devices on the loop.
PAD100-RM	Relay Module that provides one form C relay controlled by the control panel. Relay is rated for 2 amps at 30VDC or 0.5 amps at 125VAC.
PAD100-LED	Module provides a single addressable LED that is controlled by the control panel.
PAD100-SM	Speaker Module provides switching for two audio channels.
PAD100-LEDK	Addressable LED and key switch that mounts in a single gang box.
PAD100-DRTS	DUCTR Remote Test Switch that mounts in a single gang box and optionally supervised. For use with the PAD100-DUCTR only.
PAD100-OROI	One Relay One Input Module provides one form C relay and one input. The relay is rated at 2 amps at 30VDC or 0.5 amps at 125VAC.

### SLC Features

The Potter protocol is a digital protocol with a proven design for reliability and noise immunity. The system does not require special cable or conductors for connection of the Signaling Line Circuit as long as the cable is compliant with NFPA 70 and NFPA 72. The system allows for Class A or Class B installations as well as “T-Taps”, with a max wiring distance of 10,000 Ft.

### Sensor Features

The sensors through the fire alarm control panel provide a real time status as to the condition of the system. The smoke detector sensitivity, heat detector temperature level and drift compensation are all programmable options. The system also allows for a day/night mode where the panel automatically adjusts the sensitivity depending on the time of day. To assist in the reduction of false alarms, the smoke detectors also have a maintenance warning that sends a trouble signal when a detector is dirty to the point that it can no longer maintain the programmed sensitivity.

### User Interface

The fire alarm control panel has a 2 x 16 LCD display to provide information to the system status. The keypad has navigation keys to allow manipulation of the Menu on board the panel. The panel is shipped standard with the following LEDs:

- AC Power - Green
- Alarm - Red
- Earth Fault - Amber
- Supervisory - Amber
- Silenced - Amber
- Trouble - Amber
- Pre-Release - Amber
- Release - Red

The common buttons include a Silence, Reset, Acknowledge, and Drill. All of the buttons are accessible once the locked door is opened.

### P-Link

The AFC-50 has a proprietary communication protocol that communicates through a RS-485 connection to field devices. Up to 32 devices may be connected to a single P-Link connection. The P-Link includes the communication terminals and regulated 24 VDC connection for the field devices. The field devices may be any of the following:

**PAD100-SLCE**-Analog/Addressable loop expansion module

**RA-6075R** – 2 x 16 LCD annunciator with a key pad in a locked metal enclosure.

**RA-6500R(F)** – 4 x 40 LCD annunciator with a key pad in a locked metal enclosure. Flush mount version available.

**LED-16(F)** – 16 LED annunciator with common indicators in a locked metal enclosure. Flush mount version available.

**PSN-1000(E)** – 10 amp, remote intelligent power supply with 6 NACs, 2 Inputs and a P-Link repeater. This panel is listed in conjunction with the AFC-50 as releasing circuits.

**CA-6075** – Class A convertor that converts the SLC, NACs and P-Link connection

**UD-2000** – UL listed, Dual line telephone alarm communicator

**DRV-50** – LED driver expander, used to connect up to 50 LEDs in a graphic display

**FCB-1000** – Fire communication bridge, provides remote mounting of the Ethernet connection

**FIB-1000** – Fiber interface module, used to extend P-Link to multi-mode fiber (2 required)

**RLY-5** – Relay module, provides 5 form C relay contacts rated at 3.0 amps 24VDC/125AC

**SPG-1000** – Serial parallel gateway, allows for the connection to a serial or parallel printer

The **FIB-1000**, **FCB-1000** and the **SPG-1000** may be installed in the stacker bracket or ordered with the optional rack mount enclosure.

**MC-1000** Multi-Connect allows up to sixty-three AFC series panels to share a single reporting technology.

**IDC-6** – Initiating device circuit provides 6 programmable inputs

**AE-2** – Two card expansion cabinet

**AE-8** – Eight card expansion cabinet

**AE-14** – Fourteen card expansion cabinet

### Ethernet/I.P. Connection

The AFC-50 is shipped standard with an Ethernet connection. This connection is the programming port and may be connected to a building Wide Area Network (WAN) or Local Area Network (LAN). Once connected to the Internet, the panel may be selectively programmed to e-mail alarm conditions, trouble conditions, supervisory conditions, test, Event History and detector status. An e-mail may be sent to the panel and the panel will e-mail the event history, detector status, configuration file or server status to an authorized E-mail account. In addition, reminders may be set to send an e-mail for service, testing or other conditions.

In addition, the Ethernet connection is UL listed as an IP communicator. The IP communicator is listed to report to the UL listed Sur-Gard III IP receiver. The IP communicator replaces the traditional less reliable alarm communicator transmitter that utilized telephone lines. The IP communicator is an active method of connection and communication to the monitoring station.

**Dimensions**

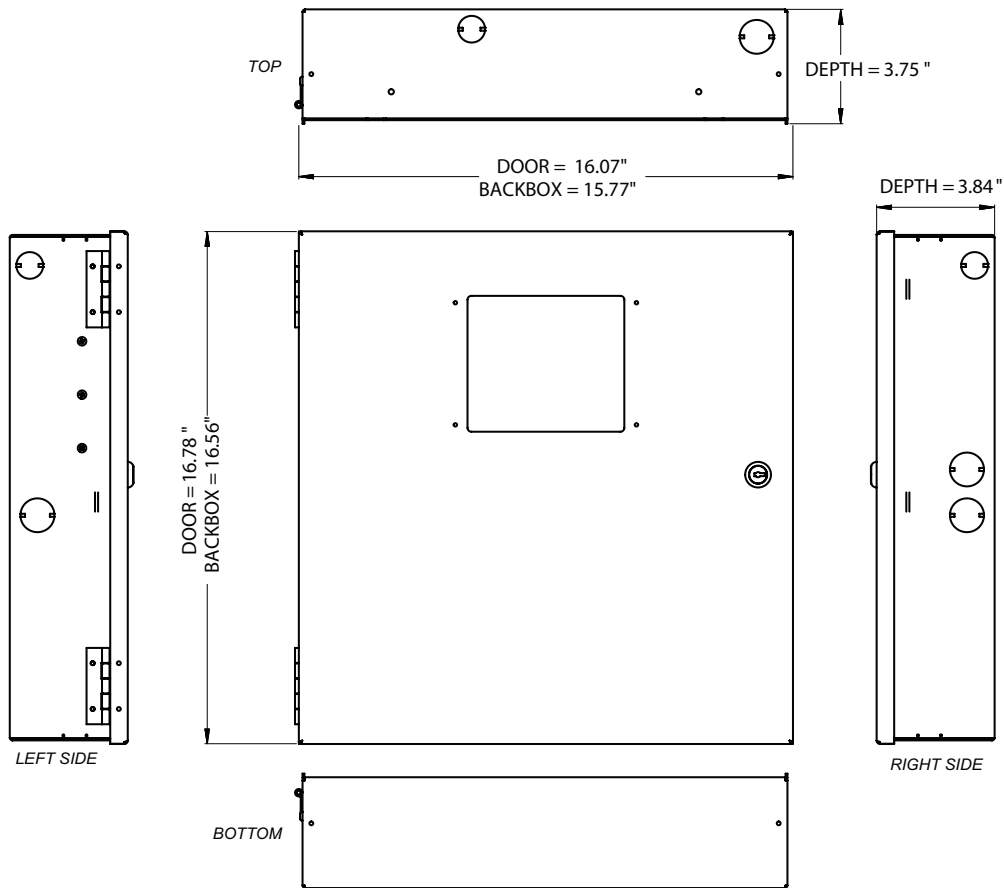

DWG #593-1

**Ordering Information**

Model	Description	Stock No.
AFC-50	Fire Alarm Control Panel	3992752
	Replacement Board AFC-50	3992756



**Features**

- PSN-64 has 6 amps regulated with 4 outputs
- PSN-106 has 10 amps regulated with 6 outputs
- May be configured as up to three class “A” Style “Z” notification circuits
- Two Trouble relays (5A at 30VDC) General System Trouble (programmable for AC delay) Low AC Trouble with optional delay settings
- Diagnostic LED’s Status LED’s for Active NAC and NAC Trouble conditions.
- Quadrasync feature synchronizes strobes from AMSECO, Gentex, Cooper-Wheelock and System Sensor.
- Configurable output circuits (DIP switch sets options for each circuit)
- Reference EOL allows 2K – 27K EOL value to be used
- Pass Thru mode allows the outputs to match the input signal from FACP



**Description**

The PSN series of notification power supplies offers reliable notification power with unprecedented versatility. The power supplies offer either 6 or 10 amps of continuous power through 4 or 6 outputs respectively. Each output is rated at 3 amps and it may be used continuously without any derating. The power supply operates on either 120 VAC or 220 VAC power input and has a regulated 24 VDC output. In addition, the power supply can charge up to 55 AH batteries and leads the industry in housing up to 18 AH batteries. The cabinet is constructed out of 18 gauge cold rolled steel and has a durable red powder coat finish. In addition, a key lock is provided for securing the door. Ample electrical knockouts are provided on the sides and the top, allowing the installer options for running wires and maintaining the correct separations.

The power supply offers an industry leading Quadrasync function that allows for multiple strobe circuits of different brands to be synchronized to flash at the same time. The power supply can have four different brands each connected to its own circuit and all the strobes flash together. Each output can independently be configured to provide one of four synchronizations or steady power. This provides unequivocal flexibility in new and retrofit installations. The power supply can be configured to synchronize AMSECO®, Gentex®, Wheelock® and System Sensor® strobe devices. Each output can be configured to the same sync protocol or set independently. In addition, the power supply has an input Pass Thru mode which allows the outputs to follow the input signal from a non-supported synchronization protocol. The power supply will recognize the type of input being supplied and pass this through to the outputs with

the same pattern. This input pass through can be selected on each output independently. The power supply contains simple dipswitch programming and LED indicators providing the installer the ability to correct any possible faults. A Trouble Memory is provided to allow an installer to review past troubles and make the necessary repairs. Each output has an LED to pinpoint the exact circuit where a trouble may have occurred. Relays are provided for monitoring the general system and AC failure. Each output can be independently configured for various applications and installations. Each output can be independently configured for Class A or Class B operation, constant power, ANSI Temporal Code 3, Single, Multiple or Combo Inputs or Door Holder Power.

**Technical Specifications**

Size (H x W x D)	16 1/8" W x 16 3/4" W x 3 1/2" D
Enclosure	Eighteen (18) gauge sheet steel with hinged, locked door
Power Input	120VAC @ 60Hz 220/240VAC @ 50Hz 5.1 Amps @ 120 VAC 2.5 Amps @ 240 VAC
Current	75mA Standby & Alarm (no external load)
Input Voltage Trigger	15mA @ 8 – 33 VDC
Terminals	18-12 AWG
Temperature	32° F to 120°F (0°C to 49°C) with a maximum humidity of 93% non-condensing
NAC Output	3 Amp max per NAC, Regulated
Battery Charging	27.3 @ 1A, can support 7 – 55Ah batteries

**PSN-106 Wiring Diagram**

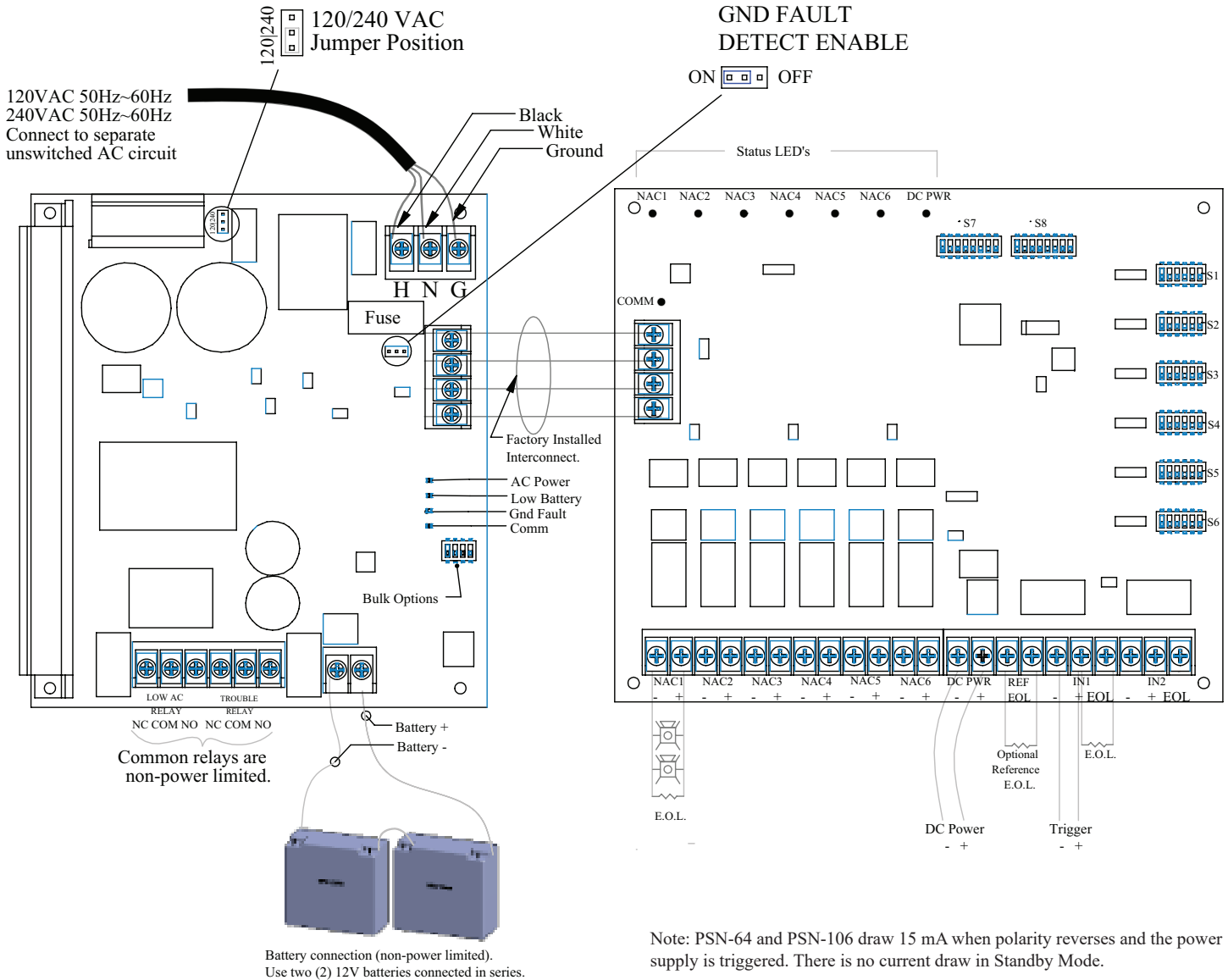

**Ordering Information**

Model	Description	Stock No.
PSN-106	10 A Power Supply, 6 NAC Circuits, Red Enclosure	3006437
PSN-106B	10 A Power Supply, 6 NAC Circuits, Black Enclosure	3006446
PSN-64	6 A Power Supply, 4 NAC Circuits, Red Enclosure	3006436



---

---

## **Engineering Specifications**

The contractor shall supply and install the Potter PSN power supply. The power supply shall operate on either 120 or 240 VAC input. The panel shall be capable of continuous load power without any degradation to the main supply or the distribution board. The cabinet shall be capable of housing up to 18AH batteries and the panel shall be capable of charging up to 55 AH batteries in an external cabinet.

The panel shall have dip switches for simplistic configuration of the system and LEDs to provide visual indication to the installer of the status of the system. The dip switches shall allow for AC power delay selection, Class A/B operation per output, Door Holder Power options, constant auxiliary power, trigger input type, ANSI Code 3 Temporal Code, Pass Thru (input tracking), AMSECO® sync, Gentex® Sync, System Sensor® Sync or Wheelock® sync. The LEDs shall provide indication of communication between the power supply and distribution circuit assemblies. The LEDs shall have distinct flash patterns to provide further indication of the troubles present. The panel shall have selectable Trouble Memory to provide the installer an indication that a past trouble existed on a circuit for diagnostic purposes.

Each output of the power supply shall be capable of 3 amps of continuous power without degradation overtime. The power supply shall provide for multiple circuits of strobe appliances. The power supply shall synchronize the flashes of any of the above listed strobe appliances on a per circuit basis. Up to four different strobe circuits may be connected and all the strobes shall flash in unison as required by UL 864. In addition to this Quadrasync feature, the panel shall allow any of the four above mentioned sync patterns as an input and pass this signal through and synchronize the outputs to match the input flash pattern.

## Features

- 5G LTE-M commercial fire alarm communicator
- Verizon or AT&T models available
- Direct connect to Potter panels with Ethernet (Contact ID)
- UD-2000 DACT not required when using Ethernet on Potter panels
- Interfaces with other panels over a single DACT connection for universal compatibility
- Meets UL 864 requirements for sole, primary, or backup path communications
- 5-minute or 60-minute supervision
- Power from fire panel 24V auxiliary power supply or plug-in transformer (included)
- Red/Locking metal enclosure
- Secure cloud-based account management tools
- Use any local and national central stations with no extra equipment or setup
- IntelliView Compatible – iOS/Android App & Browser access
- IntelliView Cloud Services and Apps included when used on Potter Panels
  - *Alert:* Detailed event status, counters, history, push notifications
  - *Backup:* Panel programming backed up to the cloud
  - *Test/Inspect:* One person walk-test tool
  - *Program:* Remotely Upload & Download panel configurations



## Description

Provides sole or dual path 5G LTE-M cellular monitoring communication for any commercial fire panel. Potter panels using the Potter IntelliCom Advanced Gateway offer the most advanced features in the industry without the need for a UD-2000 POTs dialer. Potter panels enable automatic panel program backups/retrieval, remote programming, cloud storage, and mobile walk test that creates an NFPA-72 initiation device report. If the existing panel supports Contact ID, it's a candidate for upgrading with the Potter IntelliCom Advanced Gateway.

## Technical Specifications

Cellular Service	5G LTE - Verizon or AT&T
Dimensions	7.5" H x 11.5" W x 3.5" D
Color	Red
Primary Power	12VAC or 12/24VDC (29VDC max)
Standby Current	68mA @ 24VDC (w/ Link Supervision)
Transmit Current	140mA @24VDC
Compatible Panels	Fire panels with dialer (Contact ID)
Potter Panels – See manual for specific services available. UD-2000 not required.	IPA-4000(V), IPA-100, IPA-60, AFC-1000(V), AFC-100, AFC-50, ARC-100, PFC-4064
Communication Protocols:	
Ethernet	CID over Ethernet
DACT	CID, SIA, Pulse (4x2, 3x1), Radionics (IIe/3a2,4), DMP
Agency	ANSI/UL 864 Fire Protective Signaling Systems)
Certifications	FCC

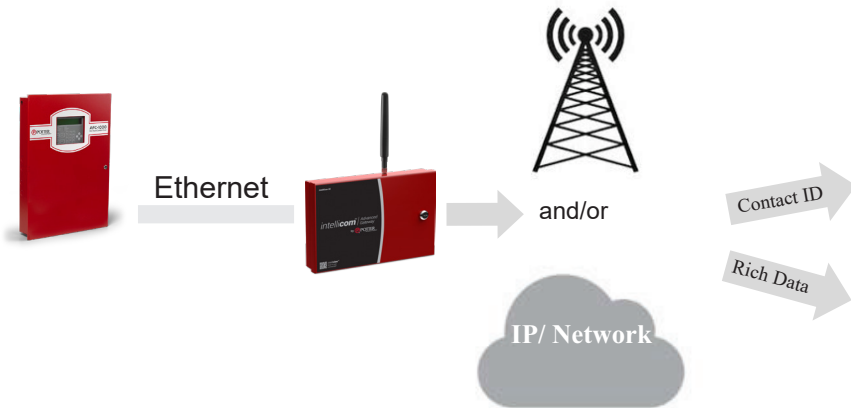

Central Station

Your Preferred Central Station  
National Central Stations  
Local Central Stations  
Sur-Gard & DMP Receivers



IntelliView  
Potter Cloud Services

Active Signal Alerts  
Panel Program Cloud Backup  
Panel Program Cloud Restoral  
Panel Remote Programming  
Walk Test  
Cloud Storage for Programs

**Potter IntelliView App & Web Services Included**

**P Alert**

Signals, Push Notifications, Status

**P Test & Inspect**

Initiation Device Report Generator



**P Program**

Remote Programming Tool

**P Backup**

Automated Cloud Backup & Restoral

---

---

## **Test & Inspect**

### Initiation Device Report Generator

Potter Test & Inspection Initiation Device Report Generator is an automated way to create the NFPA-72 Initiating Device Supplementary Record of Inspection and Testing. This tool eliminates the time-consuming manual process of creating a list of points for the required report. The tool allows a technician to import all the points, mark them as Pass/Fail, document the visual & functional test, and export the results into a file that can be included with the remainder of the user provided NFPA-72 report. This cloud-based tool is complimentary to all customers using a compatible Potter fire alarm control panel with an IntelliCom Advanced Gateway

## **Backup**

### Automated Cloud Backup & Restoral

Potter Automated Cloud Backup & Restoral is an automated way to backup Potter fire alarm control panel databases. This tool ensures that the panels program is always available and secure. Technicians can instantly recover the database from the secure server at any time. Never have to find a specific technician's computer, or thumb drive ever again. This service will save many hours whenever you have that unfortunate event that requires the system to be reprogrammed. This cloud-based tool is complimentary to all customers using a compatible Potter fire alarm control panel with an IntelliCom Advanced Gateway

## **FPP**

### Remote Programming Tool

Web based programming is a reality with the IntelliCom Advanced Gateway and Potter panels. Potter Programming Tool databases can be remotely sent to panels – from anywhere in the world. This is a great tool when commissioning systems, making updates during a T&I session, or simply making label changes. No longer does the technician with the knowledge to reprogram the panel have to be on site.\*\* This cloud-based tool is complimentary to all customers using a compatible Potter fire alarm control panel with an IntelliCom Advanced Gateway.

*\*\* NFPA-72 Requires that when changes are made to site-specific software, all functions known to be affected by the change, or identified by a means that indicates changes, must be 100 percent tested. In addition, 10 percent of initiating devices that are not directly affected, up to a maximum of 50 devices, must also be tested and proper operation verified.*

## **Alert**

### Signals, Push Notifications, Status

Panel information is right at your finger tips any time you need it. Receive alerts to any Android or iOS compatible mobile device. Push notifications to the mobile app allow for immediate signal notification. Remote Acknowledge, Silence, Reset, Enable/Disable, and Drill operations are available while a panel is in Walk Test. Prepare for a site visit by retrieving point information and panel history. This cloud-based tool is complimentary too all customers using a compatible Potter fire alarm control panel with an IntelliCom Gateway

**Ordering Information**

Model	Description	Stock No.
IntelliCom-5GV	5G LTE-M Dual path commercial fire alarm communicator (Verizon)	3994000
IntelliCom-5GA	5G LTE-M Dual path commercial fire alarm communicator (AT&T)	3994001
Accessories		
TG-TAMPER	Tamper Switch Assembly compatible with Potter metal enclosures	3994002
ACD-12	12 feet - low loss high performance antenna cable and mounting bracket	3994003
ACD-35	35 feet - low loss high performance antenna cable and mounting bracket	3994004
ACD-50	50 feet - low loss high performance antenna cable and mounting bracket	3994005
ACD-100	100 feet - low loss high performance antenna cable and mounting bracket	3994006
HGDL-0	High Gain Directional Antenna	3994007
EXDL-0	External Omni-Directional Antenna	3994008

### Features

- Selectable Rate of Rise and/or Fixed Heat Detector
- Low Profile
- Reliable Detection Technology
- LED Alarm Indicator
- Ambient Temperature Listing of 32°F to 150°F
- Simple DIP Switch Address Setting, No Programming Tool Required
- Magnetic Test Switch
- Product includes 5-year warranty
- UUKL Listed for Smoke Control

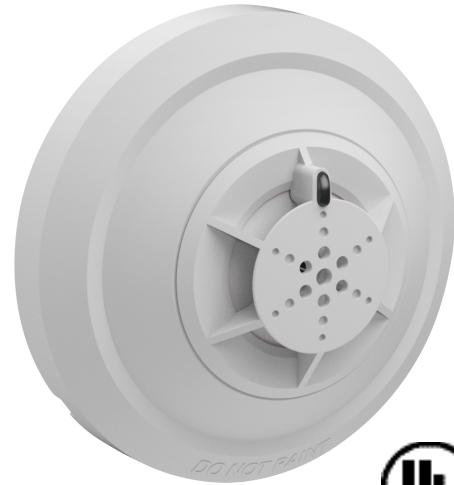

### Description

The PAD300-HD is a listed analog addressable rate of rise and/or fixed temperature heat detector compatible with any fire alarm control panel that has the Potter Addressable Device (PAD) protocol. The heat sensing portion utilizes a proven thermistor for accurate and reliable heat detection. The detector and base (not included) are made of a durable plastic in an off-white to blend in with the ceiling.

The PAD300-HD is UL listed with a selectable fixed temperature point from 135° to 185° Fahrenheit and can be used for rate of rise applications. See detector spacing limitations below. This flexibility allows the installer to cover a wide variety of applications with a single unit.

The PAD300-HD and the control panel communicate over a proven and robust digital communication path and the system analyzes the information at the particular device. The total polling speed is less than five (5) seconds, well under the UL requirements.

The detector is compatible with any of the PAD300 series detector bases and simply twists on. The PAD300-HD is addressed using DIP switches in the rear of the detector and can be easily programmed in the field without special tools.

### Setting the Address

Each addressable device on the SLC loop must have a unique address from 1 to 127 to function properly. The address is set using DIP switches.

Before connecting a device to the SLC loop, take the following precautions to prevent potential damage to SLC or device. Verify the following:

1. Power to the device is removed.
2. Field wiring is correctly installed.
3. Field wiring has no open or short circuits.

### Technical Specifications

Operating Voltage	24 VDC
Detector Current Draw	300 $\mu$ A
Alarm Indicator	1 LED
Alarm Set-point Range	135°F to 185°F (57°C to 85°C)
Rate of Rise Detection (Selectable Option)	15°F/min. (8.3°C/min.)
Installation Temperature Range	32°F to 150°F (0°C to 66°C)
Operating Relative Humidity Range	0% to 93% (Non-condensing)
Start-up Time	Max. 1 sec.
Maximum Number of Addresses Per Loop	127
Maximum Number of Lighted Indicators in Alarm Per Loop	30
Color	Eggshell White
Weight (Without Base)	68 g (2.4 oz)
Dimensions (Without Base)	Height: 1.5 in (38 mm) Diameter 3.93 in (100mm)

## Operation

The PAD300-HD is an analog addressable detector that uses one address on the Signaling Line Circuit (SLC) of a compatible fire alarm control panel. The unit communicates with the control panel as it is polled. The LED flashes every time the unit is polled and it will flash at a fast rate if the unit is in an active status. The polling LED can be turned off if desired for less conspicuous operation.

The PAD300-HD with the PAD300-4DB or PAD300-6DB has a low profile to blend into the surrounding environment. The system has a maximum of 30 LEDs that can be turned on simultaneously. If the system already has 30 LEDs on, the PAD300-HD will operate even though the LED will not illuminate.

## Spacing

The ANSI/UL listed spacing limitations of PAD300-HD smooth ceiling are dependent on alarm set point.

Alarm Set-Point	Rate of Rise Spacing	Fixed Temperature Spacing
135°F to 185°F (57°C to 85°C)	Max. 70 ft.	Max. 70 ft.

## Compatible Bases

All bases will mount on a single gang, 3-1/2" octagon, 3-1/2" square, double gang, 4" octagon, 4" square, 50mm c/c, 60mm c/c and 70mm c/c boxes.

Device	Description	Stock No.
PAD300-4DB	4" Detector Base	3992781
PAD300-6DB	6" Detector Base	3992782
PAD300-IB	6" Base with an Isolator Module Included	3992783
PAD300-RB	6" Base with One Form-C Relay Contact 2A @ 30VDC, 0.5A @ 125VAC	3992784
PAD300-SB	6" Base with sounder module included. Sound pattern is provided from external source	3992785
PAD300-LFSB	6" Base with 520Hz sounder module included. Sound pattern is provided from external source	3992786

## Ordering Information

Model	Description	Stock No.
PAD300-HD	Heat Detector	3992776



### Features

- Low profile, less than 2 inches with the base
- Wide selectable sensitivity range of 1.1 to 3.5%/foot
- Detector communicates sensitivity to control panel
- UL listed smoke calibration and sensitivity
- Optional locking tab to prevent unwanted removal
- Simple DIP switch address setting, no programming tool required
- Magnetic test switch
- LED alarm indicator
- Product includes 5-year warranty
- UUKL Listed for Smoke Control
- UL268 7th edition compliant



### Description

The Photoelectric Smoke Detector is a listed Analog Addressable smoke detector compatible with fire alarm control panels that utilize the Potter Addressable Device (PAD) protocol. The PAD300-PD is a low profile smoke detector with a wide sensitivity range. The detector and base are made of a durable plastic in an off-white color to blend in with the ceiling.

The PAD300-PD has a sensitivity range of 1.1 to 3.5 % per foot and is UL listed. The PAD300-PD features drift compensation and has built in dirty detector warning as well. The PAD300-PD and the control panel communicate over a proven and robust digital communication path and the system analyzes the information at the particular device. The total polling speed is less than five (5) seconds, well under the UL requirements.

The detector is compatible with any of the PAD300 series detector bases and simply twists on. The PAD300-PD is addressed using DIP switches in the rear of the detector and can be easily programmed in the field without special tools.

### Setting the Address

Each addressable device on the SLC loop must have a unique address from 1 to 127 to function properly. The address is set using DIP switches.

Before connecting a device to the SLC loop, take the following precautions to prevent potential damage to SLC or device. Verify the following:

1. Power to the device is removed.
2. Field wiring is correctly installed.
3. Field wiring has no open or short circuits.

### Technical Specifications

Operating Voltage	24 VDC
Detector Current Draw	300 $\mu$ A
Alarm Indicator	1 LED
Alarm Set-point Range	1.1 to 3.5%/ft (3.6 to 11%/m)
Installation Temperature Range	32 to 120 ° F (0 to 49 ° C)
Operating Relative Humidity range	0% to 93% (Non-condensing)
Start-up Time	Max. 1 sec.
Maximum Number of Addresses Per Loop	127
Maximum Number of Lighted Indicators in Alarm Per Loop	30
Color	Eggshell White
Weight (without base)	91g (3.2oz)
Dimensions (without base)	Height: 1.42 in (36mm) Diameter: 3.93 in (100 mm)

## Air Velocity Ratings

The PAD300-PD has an Open Area of Protection air velocity rating of 0 to 300 feet per minute.

The system has a maximum of 30 LEDs that can be turned on simultaneously. If the system already has 30 LEDs on, the PAD300-PD will operate even though the LED may not illuminate.

## Operation

The PAD300-PD is an analog addressable detector that uses one address on the Signaling Line Circuit (SLC) of a compatible fire alarm control panel. The unit communicates with the control panel as it is polled. The LEDs flash every time the unit is polled and they will flash at a fast rate if the unit is in an active status. The polling LED can be turned off if desired for less conspicuous operation.

The PAD300-PD with the PAD300-4DB or PAD300-6DB has a low profile of less than two (2) inches to blend into the surrounding environment. The detector includes an insect screen to prevent foreign objects from reaching the chamber and can be cleaned to restore operation of a dirty detector.

## Detector Sensitivity

The PAD300-PD and the compatible control panel work in tandem to keep the sensitivity consistent. As the detector is installed over time, the detector compensates for the dirt in the unit until it is out of range. At that time, the panel will indicate a dirty detector. The detector will then have to be cleaned or replaced.

The PAD300-PD can be programmed to provide a maintenance alert prior to reaching the dirty detector level which will allow for intervention prior to the detector going into trouble. This allows for detector replacement or cleaning prior to a nuisance trouble occurs.

**NOTE:** As required by NFPA, do not install the detectors until all construction is complete and the work area has been thoroughly cleaned. If the detectors have been installed in a construction environment, they should be cleaned or replaced before the system is placed into service.

## Spacing

The PAD300-PD is UL listed with a recommended maximum spacing of 30 feet. Refer to NFPA 72 for specific information regarding detector spacing, placement and special applications.

## Compatible Bases

All bases will mount on a single gang, 3-1/2" octagon, 3-1/2" square, double gang, 4" octagon, 4" square, 50mm c/c, 60mm c/c and 70mm c/c boxes.

Device	Description	Stock No.
PAD300-4DB	4" Detector Base	3992781
PAD300-6DB	6" Detector Base	3992782
PAD300-IB	6" base with an isolator module included	3992783
PAD300-RB	6" base with one Form-C relay contact. 2A @ 30VDC, 0.5A @ 125VAC	3992784
PAD300-SB	6" base with sounder module included. Sound pattern is provided from external source	3992785
PAD300-LFSB	6" base with 520Hz sounder module included. Sound pattern is provided from external source	3992786

## Ordering Information

Model	Description	Stock No.
PAD300-PD	Photoelectric Smoke Detector	3992775

## Features

- Single or Dual Action versions
- Durable die-cast construction
- Reset key matches the fire alarm control panels
- Compatible with IPA Series panels
- SLC Class A, Class X & Class B
- Product includes a 5 year warranty
- UUKL Listed for Smoke Control



## Description

The PAD100-PSSA (Single Action) is activated by simply pulling the white “T” bar handle down. The PAD100-PSDA (Dual Action) is activated by lifting the front cover and then pulling the white “T” bar handle down. Once activated, the “T” bar cannot be reset without opening the front cover. Opening the front cover will also activate the pull station. To reset the PAD100-PS Series, use the Potter WS-93 key to unlock and open the front cover. Once the cover is open, push the “T” bar back into the normal position and re-secure the front cover.

## Application

The PAD100-PSSA/PSDA is compatible with Potter’s IPA and AFC/ARC series addressable fire alarm control panels. It is a non-coded addressable pull station available in either a single or dual action model and installs on a single gang box or surface mounts using the P32-BB or P32-DBB (deep) back box.

## Technical Specifications

Operating Voltage	24.0 VDC
Max SLC Standby Current	200uA
Max SLC Alarm Current	200uA
Environmental Limitations	32°F - 120°F (0° - 49°C) Indoor Only
Dimensions	4.75” H x 3.25” W x 1.75” D
Relative Humidity Range	0 - 93% (non-condensing)
Mounting Options	Single gang box or Potter P32-BB/DBB
Shipping Weight	APS-SA - 1.22 lbs. APS-DA - 1.46 lbs.

## Setting the Address

The PAD100-PS Series uses one SLC address assigned to the device. The address is set using the DIP switch located on the back of the PAD100-PS device.

*Pull Station Front View*  
**Fig 1**

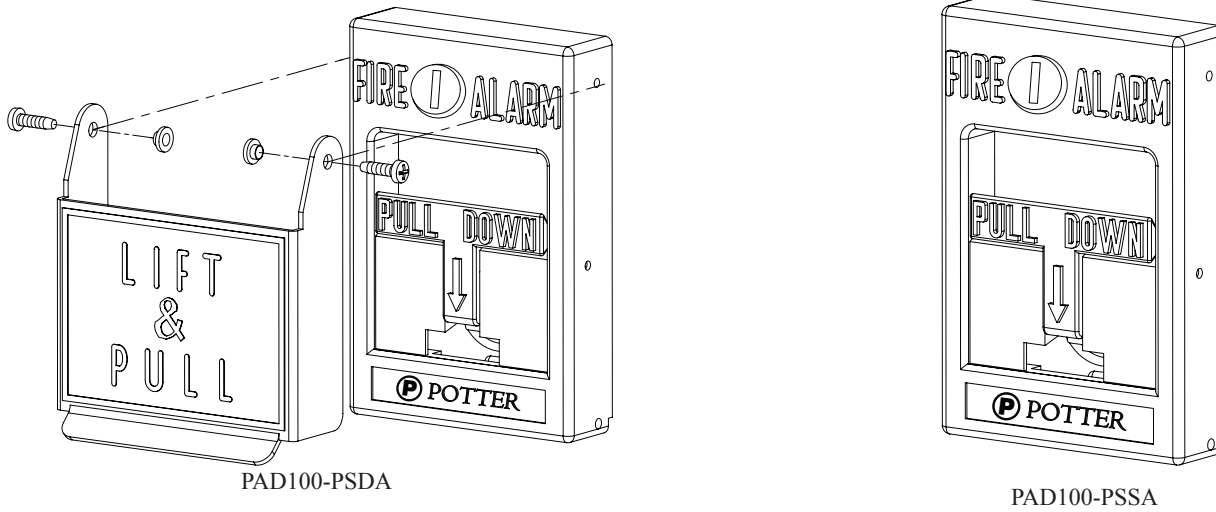

*Pull Station Back View and Wiring*  
**Fig 2**

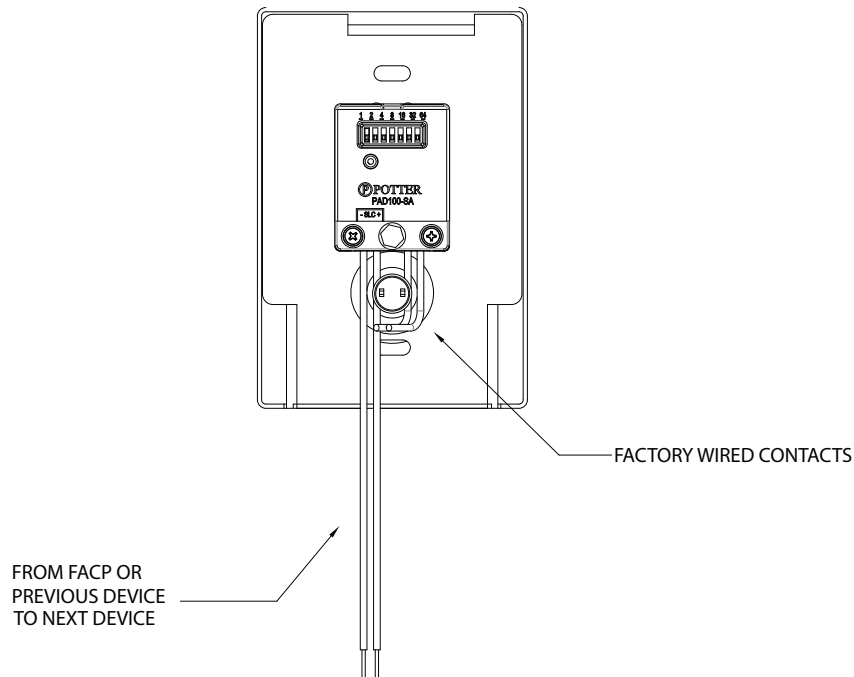

## Ordering Information

Model	Description	Stock No.
PAD100-PSSA	Addressable Pull Station, Single Action	3992721
PAD100-PSDA	Addressable Pull Station, Dual Action	3992720

### Features

- Single module with dual contact monitoring inputs
- Two (2) Class B or one (1) Class A monitoring inputs
- SLC Class A, Class X & Class B
- Mounts in a standard 4" or double gang box
- Wiring terminals accessible when mounted in box
- All wiring terminals accept 22 to 12 AWG
- Product includes a 5 year warranty
- UUKL Listed for Smoke Control

**NOTE:** This addressable module does not support 2-wire smoke detectors.



### Description

The PAD100-DIM uses one (1) SLC loop address when monitoring two (2) Class B circuits or one (1) Class A circuit. The module mounts on either a 4" square or double gang box. The module is capable of monitoring two (2) separate class B circuits making it ideal for monitoring sprinkler waterflow and valve tamper switches when they are located in the same proximity. The PAD100-DIM includes one red LED to indicate the module's status. In normal condition, the LED flashes when the device is being polled by the control panel. When an input is activated, the LED will flash at a fast rate.

### Application

The PAD100-DIM is compatible with Potter's IPA and AFC/ARC series addressable fire alarm control panels. The PAD100-DIM is an interface module used to monitor dry contact devices such as sprinkler waterflow, valve tamper switches, or conventional pull stations. The module is capable of monitoring two separate Class B or one Class A circuits.

### Setting the Address

Each addressable SLC device must be assigned an address. The address is set using the DIP switch located on the PAD100-DIM. When the PAD100-DIM is used to monitor two individual Class B circuits a single device address is assigned, each input is then identified as a sub-point of the module address. For example, if the address number is assigned as "8", the first input will be "8.1" and the second input will be "8.2".

Before connecting a device to the SLC loop, take the following precautions to prevent potential damage to the panel or device:

1. Power to the device is removed.
2. Field wiring is correctly installed.
3. Field wiring has no open or short circuits.

### Technical Specifications

Operating Voltage	24.0V
Max SLC Standby Current	240 $\mu$ A
Max SLC Alarm Current	240 $\mu$ A
Max Wiring Resistance of IDC	100 $\Omega$
Max Wiring Capacitance of IDC	1 $\mu$ F
EOL Resistor	5.1K $\Omega$
Operating Temperature Range	32 to 120°F (0 to 49°C)
Operating Humidity Range	0 to 93% (non-condensing)
Max no. of Module Per Loop	127 units
Dimensions	4.17" (106mm)L $\times$ 4.17" (106mm)W $\times$ 1.14" (29mm)D
Mounting Options	Standard 4" Square or Double Gang Box
Shipping Weight	0.6 lbs

**Installation Using Compatible Electrical Box**

Fig 1

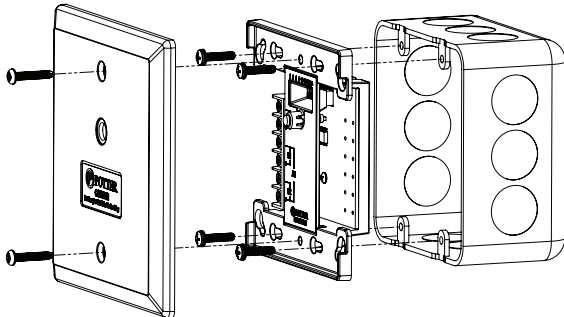

**Wiring Diagrams**

*PAD100-DIM With One Class A Circuit*

Fig 2

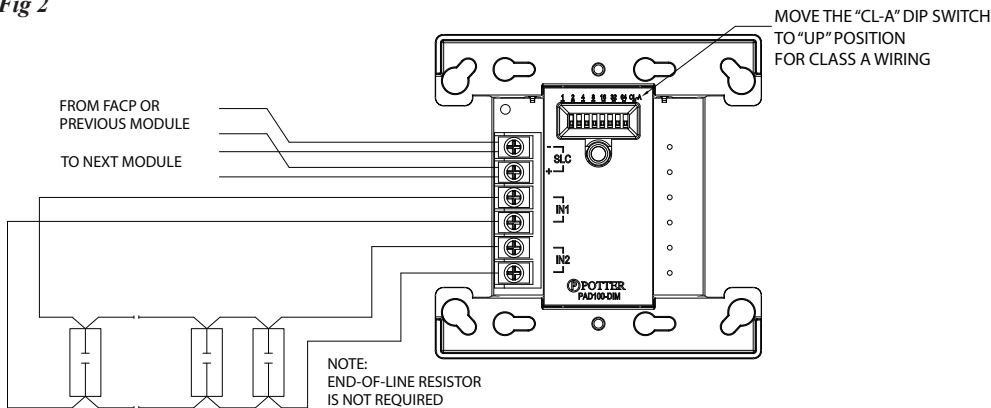

*PAD100-DIM With Two Class B Circuits*

Fig 3

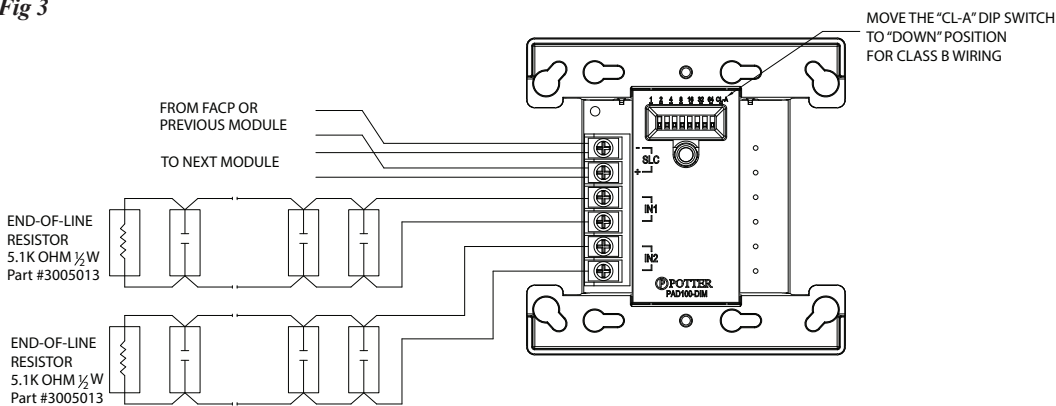

**Ordering Information**

Model	Description	Stock No.
PAD100-DIM	Dual Input Module	3992703