

## Structural Calculations for Vertical and Lateral Design of Building G

**Project & Location:**

**Structural Calculations**  
**Bradley Heights Apartments**  
 (Lat 47.1652, Long -122.2921)  
 202 27<sup>th</sup> Avenue SE, Puyallup, WA

**Client:**

Timberlane Partners  
 Attn: Dave Enslow  
[dave@timberlanepartners.com](mailto:dave@timberlanepartners.com)

**Professional Engineer:**

Solutions 4 Structures, Inc  
 11605 135<sup>th</sup> St Ct E  
 Puyallup, WA 98374  
 Attn: Tom Chase, PE  
[tom@solutions4structures.com](mailto:tom@solutions4structures.com)  
 (253) 314 - 9822



**Project Number:**

23.007

**Code / Location:**

2018 IBC

02-20-24

**Loads:**

1. Vertical Loads	Dead	Live
Roof	22 PSF	25 PSF (Snow)
Floor	26 PSF	40 PSF (Apartments)
Floor	25 PSF	60 PSF (Decks)
Exits	47 PSF	100 PSF (Stairs & Landings)

2. Lateral Loads

Wind Criteria

Basic Wind Speed = 97 MPH

Exposure B

I<sub>w</sub> = 1.0, K<sub>z</sub>t = 1.0

Seismic Criteria

Seismic Design Category "D"

Site Class C

I<sub>E</sub> = 1.0, S<sub>s</sub> = 1.263, S<sub>1</sub> = 0.435

SDS = 1.010, SD1 = 0.435

Building Response R = 5, C<sub>s</sub> = 0.111 (ASD)

3. Soils Data (per GeoResources Inc. dated 02/10/2022)

Bearing Capacity = 2,000 PSF

**FULL SIZED LEDGIBLE COLOR REPORT IS  
 REQUIRED TO BE PROVIDED BY THE PERMITTEE  
 ON SITE FOR ALL INSPECTIONS**

PRMU20240280 BLDG G

# Vertical

Building G

## ROOF LOADS:

Roof Dead Loads:	
Solar Panels	5.00 PSF
Comp Shingles	3.00 PSF
#30 Felt	0.20 PSF
APA Rated Plywood/OSB	1.70 PSF
PE Trusses @ 24" o.c.	3.50 PSF
Insulation	1.50 PSF
(2) Layer of 5/8" Gypsum Board	5.60 PSF
Mechanical & Electrical	1.00 PSF
Miscellaneous	0.50 PSF
<b>Total Roof Dead Load:</b>	<b>22.00 PSF</b>
<b>Total Live / Snow Load:</b>	<b>25.00 PSF</b>
<b>Total Roof Load:</b>	<b>47.00 PSF</b>

## FLOOR LOADS:

Floor Dead Loads:	
Finish Material	1.00 PSF
1.25" Gypcrete (105pcf)	10.90 PSF
APA Rated 3/4" T&G Plywood/OSB	2.50 PSF
11-7/8" TJI Joists @16" o.c.	2.80 PSF
Insulation	1.00 PSF
(2) Layer of 5/8" Gypsum Board	5.60 PSF
Mechanical & Electrical	1.00 PSF
Miscellaneous	1.20 PSF
<b>Total Floor Dead Load:</b>	<b>26.00 PSF</b>
<b>Total Live / Snow Load:</b>	<b>40.00 PSF</b>
<b>Total Floor Load:</b>	<b>66.00 PSF</b>

## STAIR LOADS:

Deck Dead Loads:	
3" Concrete Topping (145 pcf)	36.30 PSF
Waterproof membrane (per Arch)	0.50 PSF
PT 3/4" T&G Plywood	3.00 PSF
2 x 8 Joists @16" o.c.	2.00 PSF
(1) Layer of 5/8" Gypsum Board	2.80 PSF
Mechanical & Electrical	1.00 PSF
Miscellaneous	1.40 PSF
<b>Total Floor Dead Load:</b>	<b>47.00 PSF</b>
<b>Total Live / Live Load:</b>	<b>100.00 PSF</b>
<b>Total Floor Load:</b>	<b>147.00 PSF</b>

## DECK LOADS:

Deck Dead Loads:	
Decking/Ply & Topping TBD	20.00 PSF
Waterproof membrane (per Arch)	0.50 PSF
2 x 8 Joists @16" o.c.	2.00 PSF
Deck soffit	1.50 PSF
Miscellaneous	1.00 PSF
<b>Total Dead Load:</b>	<b>25.00 PSF</b>
<b>Total Load:</b>	<b>60.00 PSF</b>
<b>Total Deck Load:</b>	<b>85.00 PSF</b>

WALL LOADS:	
<b>Wall Dead Loads: INT. Wall Assembly</b>	
5/8" Gypsum Board	2.80 PSF
Fiberglass insulation	0.70 PSF
2x6 or 2x4 Studs @ 16" o.c.	1.70 PSF
Top & Bottom Wall Plates	0.30 PSF
5/8" Gypsum Board	2.80 PSF
Miscellaneous	0.70 PSF
<b>Total Wall Dead Load:</b>	<b>9.00 PSF</b>
<b>Total Wall Load:</b>	<b>9.00 PSF</b>

WALL LOADS:	
<b>Wall Dead Loads: EXT. Wall Assembly</b>	
Exterior siding	3.00 PSF
Moisture barrier	0.20 PSF
1/2" Plywood/OSB	1.70 PSF
2 x 6 or 2 x 4 Studs @ 16" o.c.	1.70 PSF
Top & Bottom Wall Plates	0.30 PSF
Insulation	1.00 PSF
(1) Layer of 5/8" Gypsum Board	2.80 PSF
Miscellaneous	1.30 PSF
<b>Total Wall Dead Load:</b>	<b>12.00 PSF</b>
<b>Total Wall Load:</b>	<b>12.00 PSF</b>

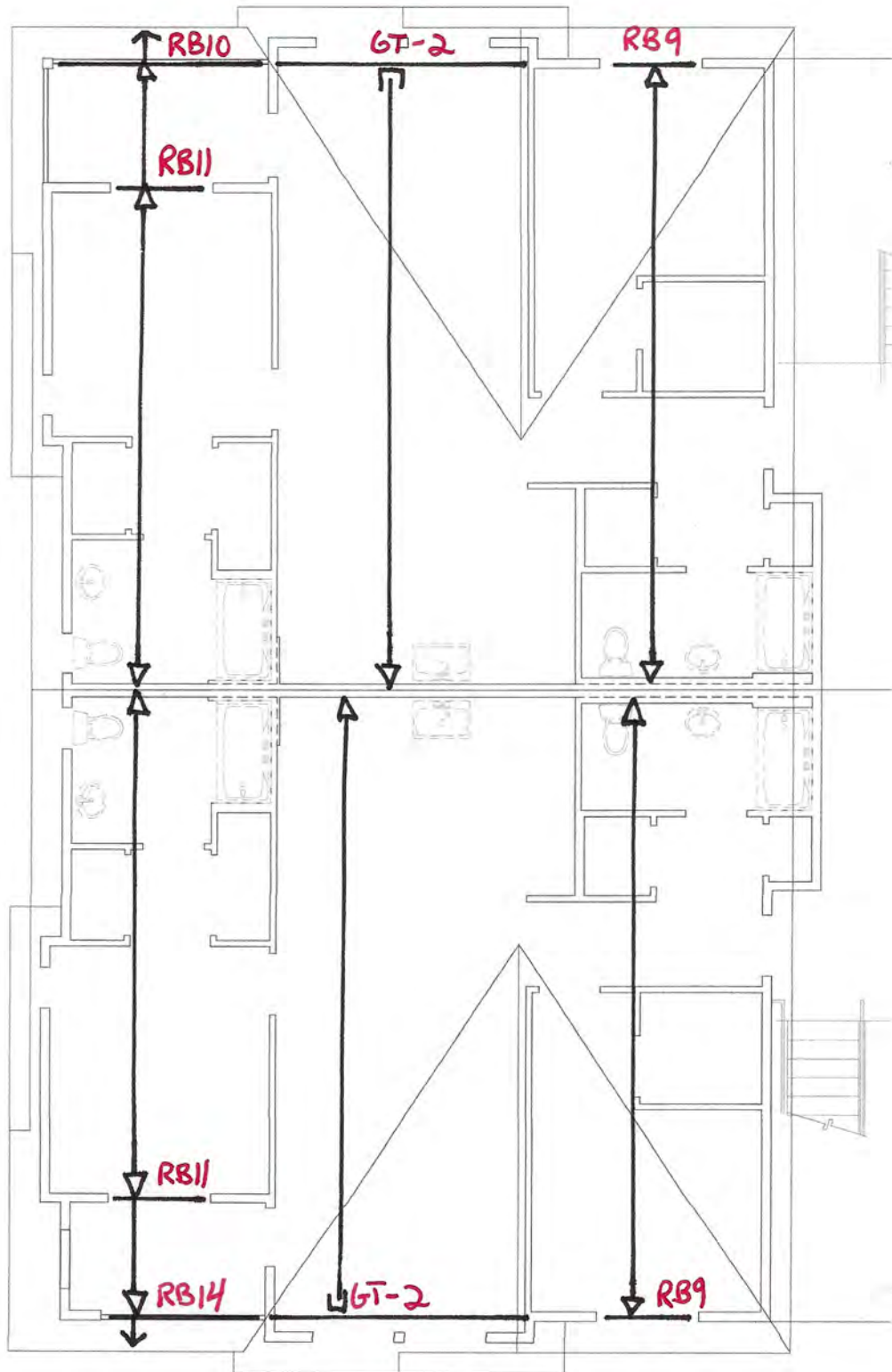

ROOF TYPE 4

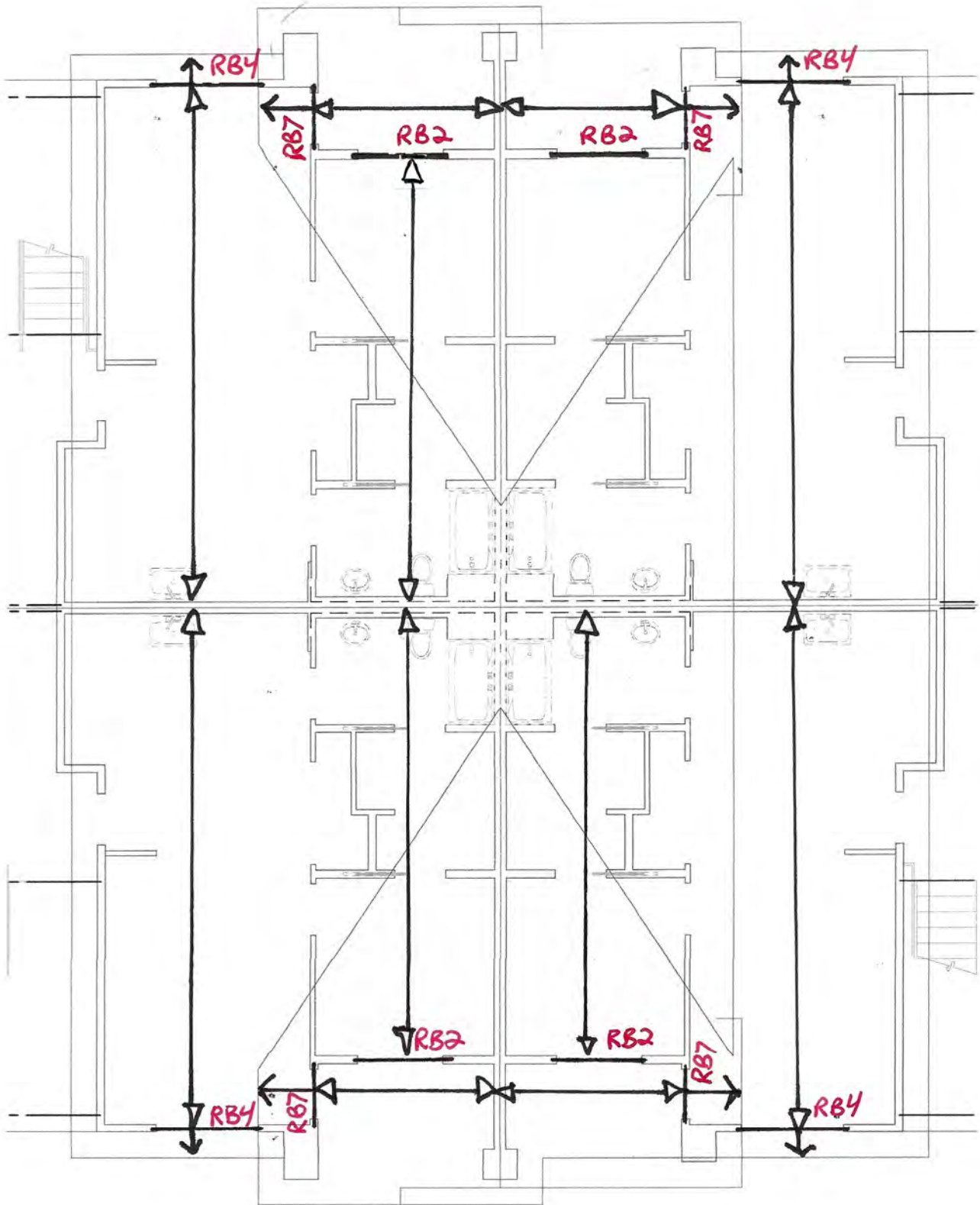

ROOF TYPE 5

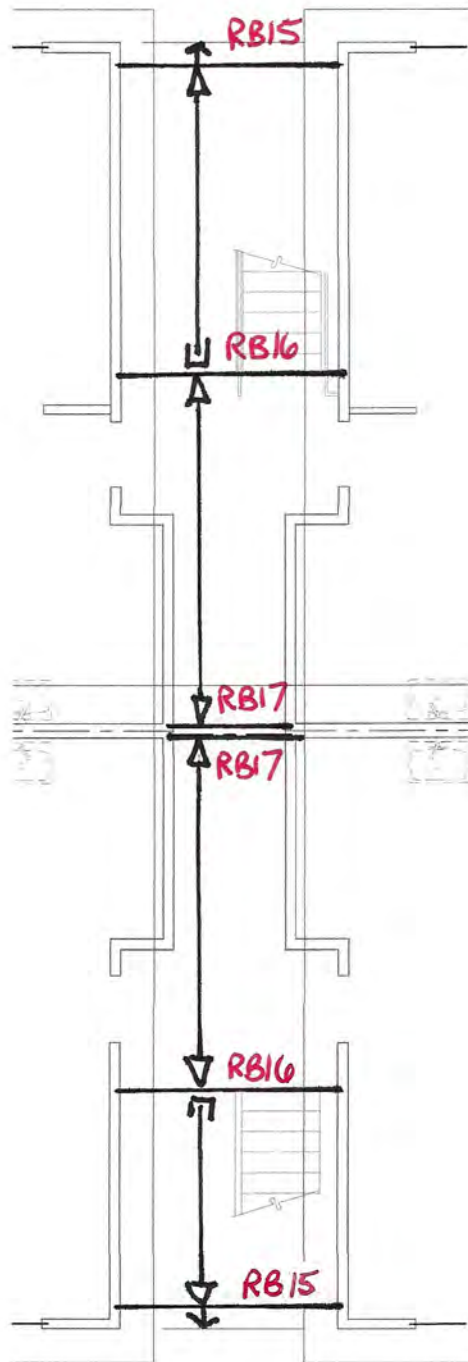

TYPICAL CORRIDOR ROOF

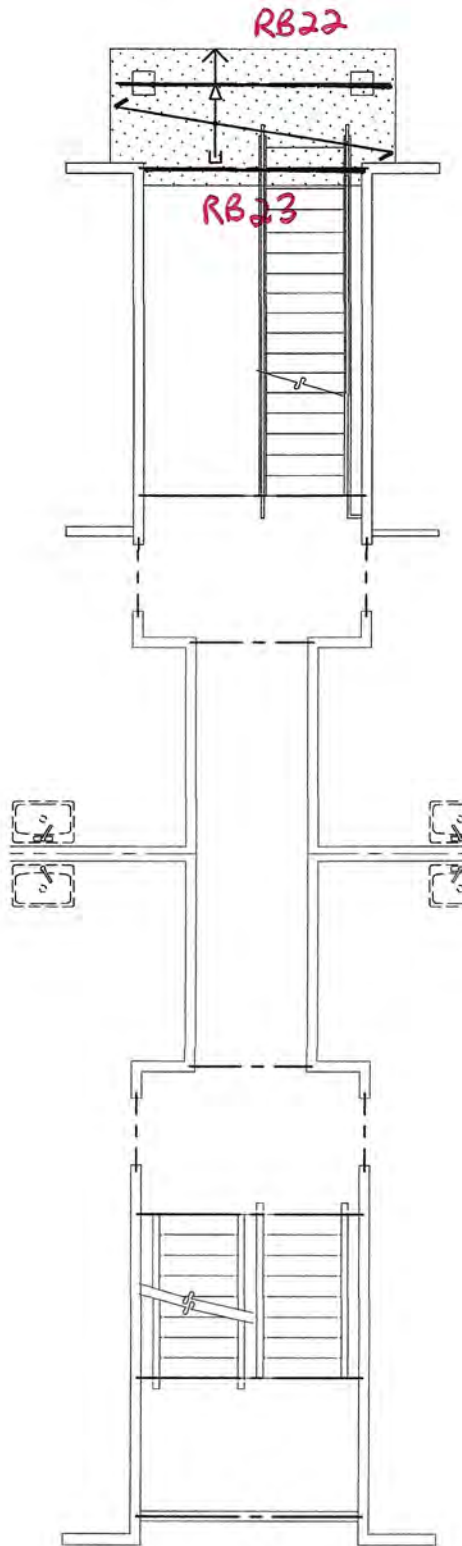

2ND FLOOR ENTRANCE ROOFS





Job #: 23.007  
 Designed: TLC  
 Date: 6/1/23

**ROOF FRAMING** 2018 NDS/2018 IBC

C <sub>r</sub> =	1.15	repetitive
C <sub>D</sub> =	<b>1.15</b>	<b>SNOW</b>
C <sub>F</sub> =	(varies)	size

2 x 6		Pressure Treated Incising		Hem Fir		#2		
2 x 6	▼	A =	8.25	in <sup>2</sup>	Snow	25.00	psf	
Hem Fir	▼	S =	7.56	in <sup>3</sup>	Dead	17.00	psf	
#2	▼	I =	20.80	in <sup>4</sup>	Other	-	psf	
Incising? Yes	▼	C <sub>F</sub> =	1.30		Total	42.00	psf	
		F <sub>b</sub> =	850.00	psi				
		F <sub>v</sub> =	150.00	psi	Allowable Span @ 12" o.c. =	11.08	ft (TL Defl.)	
		E =	1,300,000.00	psi	Allowable Span @ 16" o.c. =	10.06	ft (TL Defl.)	
		C <sub>i</sub> =	0.80	Incising (Fb)	Allowable Span @ 24" o.c. =	8.54	ft (bending)	
		C <sub>i</sub> =	0.95	Incising (E)				
		spacing (in)	12.00	16.00	24.00	Control	% over allowed	
		Lv <sub>allow</sub> = {[A*F <sub>v</sub> *C <sub>D</sub> /(1.5*w)]+d}*2	Lv (ft) =	46.55	35.14	23.73	Shear	1.00%
		Lb <sub>allow</sub> = (S*F <sub>b</sub> *C <sub>D</sub> *Cr*C <sub>F</sub> *C <sub>i</sub> *8/w) <sup>1/2</sup>	Lb (ft) =	12.08	10.46	8.54	Bending	4.00%
		Ld <sub>allow</sub> = [384*E*C <sub>i</sub> <sup>1/3</sup> /(5*LL*360)] <sup>1/3</sup>	Ld (ft) =	11.50	10.45	9.13	LL Deflection	360
		Ld <sub>allow</sub> = [384*E*C <sub>i</sub> <sup>1/3</sup> /(5*TL*240)] <sup>1/3</sup>	Ld (ft) =	11.08	10.06	8.79	TL Deflection	240
				TL Defl.	TL Defl.	bending		

2 x 8		Hem Fir		#2				
2 x 8	▼	A =	10.88	in <sup>2</sup>	Snow	25.00	psf	
Hem Fir	▼	S =	13.14	in <sup>3</sup>	Dead	17.00	psf	
#2	▼	I =	47.63	in <sup>4</sup>	Other	-	psf	
Incising? No	▼	C <sub>F</sub> =	1.20		Total	42.00	psf	
		F <sub>b</sub> =	850.00	psi				
		F <sub>v</sub> =	150.00	psi	Allowable Span @ 12" o.c. =	14.85	ft (TL Defl.)	
		E =	1,300,000.00	psi	Allowable Span @ 16" o.c. =	13.49	ft (TL Defl.)	
		C <sub>i</sub> =	1.00	Incising (Fb)	Allowable Span @ 24" o.c. =	11.79	ft (TL Defl.)	
		C <sub>i</sub> =	1.00	Incising (E)				
		spacing (in)	12.00	16.00	24.00	Control	% over allowed	
		Lv <sub>allow</sub> = {[A*F <sub>v</sub> *C <sub>D</sub> /(1.5*w)]+d}*2	Lv (ft) =	61.36	46.32	31.28	Shear	1.00%
		Lb <sub>allow</sub> = (S*F <sub>b</sub> *C <sub>D</sub> *Cr*C <sub>F</sub> *C <sub>i</sub> *8/w) <sup>1/2</sup>	Lb (ft) =	17.11	14.81	12.10	Bending	4.00%
		Ld <sub>allow</sub> = [384*E*C <sub>i</sub> <sup>1/3</sup> /(5*LL*360)] <sup>1/3</sup>	Ld (ft) =	15.42	14.01	12.24	LL Deflection	360
		Ld <sub>allow</sub> = [384*E*C <sub>i</sub> <sup>1/3</sup> /(5*TL*240)] <sup>1/3</sup>	Ld (ft) =	14.85	13.49	11.79	TL Deflection	240
				TL Defl.	TL Defl.	TL Defl.		

2 x 10		Hem Fir		#2				
2 x 10	▼	A =	13.88	in <sup>2</sup>	Snow	25.00	psf	
Hem Fir	▼	S =	21.39	in <sup>3</sup>	Dead	17.00	psf	
#2	▼	I =	98.93	in <sup>4</sup>	Other	-	psf	
Incising? No	▼	C <sub>F</sub> =	1.10		Total	42.00	psf	
		F <sub>b</sub> =	850.00	psi				
		F <sub>v</sub> =	150.00	psi	Allowable Span @ 12" o.c. =	18.95	ft (TL Defl.)	
		E =	1,300,000.00	psi	Allowable Span @ 16" o.c. =	17.22	ft (TL Defl.)	
		C <sub>i</sub> =	1.00	Incising (Fb)	Allowable Span @ 24" o.c. =	14.78	ft (bending)	
		C <sub>i</sub> =	1.00	Incising (E)				
		spacing (in)	12.00	16.00	24.00	Control	% over allowed	
		Lv <sub>allow</sub> = {[A*F <sub>v</sub> *C <sub>D</sub> /(1.5*w)]+d}*2	Lv (ft) =	78.28	59.10	39.91	Shear	1.00%
		Lb <sub>allow</sub> = (S*F <sub>b</sub> *C <sub>D</sub> *Cr*C <sub>F</sub> *C <sub>i</sub> *8/w) <sup>1/2</sup>	Lb (ft) =	20.90	18.10	14.78	Bending	4.00%
		Ld <sub>allow</sub> = [384*E*C <sub>i</sub> <sup>1/3</sup> /(5*LL*360)] <sup>1/3</sup>	Ld (ft) =	19.68	17.88	15.62	LL Deflection	360
		Ld <sub>allow</sub> = [384*E*C <sub>i</sub> <sup>1/3</sup> /(5*TL*240)] <sup>1/3</sup>	Ld (ft) =	18.95	17.22	15.04	TL Deflection	240
				TL Defl.	TL Defl.	bending		

# SOLUTIONS 4 STRUCTURES INC.

## LOADS ONLY

**RB1**      4x8

$$R_1 = \begin{matrix} \text{DL} \\ \text{SL} \end{matrix} \begin{pmatrix} 0.32 \\ 0.30 \end{pmatrix} \quad \Sigma \quad 0.62 \text{ k}$$

$$R_2 = \begin{pmatrix} 0.32 \\ 0.30 \end{pmatrix} \quad \Sigma \quad 0.62 \text{ k}$$

$$W_1 = \text{DL} \begin{pmatrix} \text{PSF Tributary} \\ \text{SL} \end{pmatrix} \begin{pmatrix} 22 \\ 25 \end{pmatrix} \begin{pmatrix} 8.0 \\ 8.0 \end{pmatrix} + \text{DL} \begin{pmatrix} 40 \\ \text{Wall} \end{pmatrix} + \text{DL} \begin{pmatrix} \text{PSF Tributary} \\ \text{SL} \end{pmatrix} \begin{pmatrix} 0 \\ 0 \end{pmatrix} \begin{pmatrix} 0.0 \\ 0.0 \end{pmatrix} = \begin{matrix} \text{DL} \\ \text{SL} \\ \Sigma \end{matrix} \begin{pmatrix} 216 \\ 200 \\ 416 \end{pmatrix} \text{ PLF}$$

**RB2**      4x8

$$R_1 = \begin{matrix} \text{DL} \\ \text{SL} \end{matrix} \begin{pmatrix} 0.80 \\ 0.91 \end{pmatrix} \quad \Sigma \quad 1.70 \text{ k}$$

$$R_2 = \begin{pmatrix} 0.80 \\ 0.91 \end{pmatrix} \quad \Sigma \quad 1.70 \text{ k}$$

$$W_1 = \text{DL} \begin{pmatrix} \text{PSF Tributary} \\ \text{SL} \end{pmatrix} \begin{pmatrix} 22 \\ 25 \end{pmatrix} \begin{pmatrix} 14.5 \\ 14.5 \end{pmatrix} + \text{DL} \begin{pmatrix} 0 \\ \text{Wall} \end{pmatrix} + \text{DL} \begin{pmatrix} \text{PSF Tributary} \\ \text{SL} \end{pmatrix} \begin{pmatrix} 0 \\ 0 \end{pmatrix} \begin{pmatrix} 0.0 \\ 0.0 \end{pmatrix} = \begin{matrix} \text{DL} \\ \text{SL} \\ \Sigma \end{matrix} \begin{pmatrix} 319 \\ 363 \\ 682 \end{pmatrix} \text{ PLF}$$

**RB3**      4x8

$$R_1 = \begin{matrix} \text{DL} \\ \text{SL} \end{matrix} \begin{pmatrix} 0.76 \\ 0.70 \end{pmatrix} \quad \Sigma \quad 1.46 \text{ k}$$

$$R_2 = \begin{pmatrix} 0.76 \\ 0.70 \end{pmatrix} \quad \Sigma \quad 1.46 \text{ k}$$

$$W_1 = \text{DL} \begin{pmatrix} \text{PSF Tributary} \\ \text{SL} \end{pmatrix} \begin{pmatrix} 22 \\ 25 \end{pmatrix} \begin{pmatrix} 8.0 \\ 8.0 \end{pmatrix} + \text{DL} \begin{pmatrix} 40 \\ \text{Wall} \end{pmatrix} + \text{DL} \begin{pmatrix} \text{PSF Tributary} \\ \text{SL} \end{pmatrix} \begin{pmatrix} 0 \\ 0 \end{pmatrix} \begin{pmatrix} 0.0 \\ 0.0 \end{pmatrix} = \begin{matrix} \text{DL} \\ \text{SL} \\ \Sigma \end{matrix} \begin{pmatrix} 216 \\ 200 \\ 416 \end{pmatrix} \text{ PLF}$$

**RB4**      4x10

$$R_1 = \begin{matrix} \text{DL} \\ \text{SL} \end{matrix} \begin{pmatrix} 1.12 \\ 1.28 \end{pmatrix} \quad \Sigma \quad 2.40 \text{ k}$$

$$R_2 = \begin{pmatrix} 1.12 \\ 1.28 \end{pmatrix} \quad \Sigma \quad 2.40 \text{ k}$$

$$W_1 = \text{DL} \begin{pmatrix} \text{PSF Tributary} \\ \text{SL} \end{pmatrix} \begin{pmatrix} 22 \\ 25 \end{pmatrix} \begin{pmatrix} 17.0 \\ 17.0 \end{pmatrix} + \text{DL} \begin{pmatrix} 0 \\ \text{Wall} \end{pmatrix} + \text{DL} \begin{pmatrix} \text{PSF Tributary} \\ \text{SL} \end{pmatrix} \begin{pmatrix} 0 \\ 0 \end{pmatrix} \begin{pmatrix} 0.0 \\ 0.0 \end{pmatrix} = \begin{matrix} \text{DL} \\ \text{SL} \\ \Sigma \end{matrix} \begin{pmatrix} 375 \\ 426 \\ 801 \end{pmatrix} \text{ PLF}$$

**RB5**      4x8

$$R_1 = \begin{matrix} \text{DL} \\ \text{SL} \end{matrix} \begin{pmatrix} 0.83 \\ 0.94 \end{pmatrix} \quad \Sigma \quad 1.77 \text{ k}$$

$$R_2 = \begin{pmatrix} 0.83 \\ 0.94 \end{pmatrix} \quad \Sigma \quad 1.77 \text{ k}$$

$$W_1 = \text{DL} \begin{pmatrix} \text{PSF Tributary} \\ \text{SL} \end{pmatrix} \begin{pmatrix} 22 \\ 25 \end{pmatrix} \begin{pmatrix} 15.0 \\ 15.0 \end{pmatrix} + \text{DL} \begin{pmatrix} 0 \\ \text{Wall} \end{pmatrix} + \text{DL} \begin{pmatrix} \text{PSF Tributary} \\ \text{SL} \end{pmatrix} \begin{pmatrix} 0 \\ 0 \end{pmatrix} \begin{pmatrix} 0.0 \\ 0.0 \end{pmatrix} = \begin{matrix} \text{DL} \\ \text{SL} \\ \Sigma \end{matrix} \begin{pmatrix} 331 \\ 376 \\ 707 \end{pmatrix} \text{ PLF}$$

**RB6**      4x10

$$R_1 = \begin{matrix} \text{DL} \\ \text{SL} \end{matrix} \begin{pmatrix} 0.99 \\ 1.13 \end{pmatrix} \quad \Sigma \quad 2.12 \text{ k}$$

$$R_2 = \begin{pmatrix} 0.99 \\ 1.13 \end{pmatrix} \quad \Sigma \quad 2.12 \text{ k}$$

$$W_1 = \text{DL} \begin{pmatrix} \text{PSF Tributary} \\ \text{SL} \end{pmatrix} \begin{pmatrix} 22 \\ 25 \end{pmatrix} \begin{pmatrix} 15.0 \\ 15.0 \end{pmatrix} + \text{DL} \begin{pmatrix} 0 \\ \text{Wall} \end{pmatrix} + \text{DL} \begin{pmatrix} \text{PSF Tributary} \\ \text{SL} \end{pmatrix} \begin{pmatrix} 0 \\ 0 \end{pmatrix} \begin{pmatrix} 0.0 \\ 0.0 \end{pmatrix} = \begin{matrix} \text{DL} \\ \text{SL} \\ \Sigma \end{matrix} \begin{pmatrix} 331 \\ 376 \\ 707 \end{pmatrix} \text{ PLF}$$

# SOLUTIONS 4 STRUCTURES INC.

## LOADS ONLY

**RB7**      4x8

$$R_1 = \begin{matrix} \text{DL} \\ \text{SL} \end{matrix} \begin{pmatrix} 0.77 \\ 0.67 \end{pmatrix} \quad \Sigma \quad 1.44 \text{ k}$$

$$R_2 = \begin{pmatrix} 0.77 \\ 0.67 \end{pmatrix} \quad \Sigma \quad 1.44 \text{ k}$$

$$W_1 = \begin{matrix} \text{Roof} \\ \text{PSF Tributary} \\ \text{SL} \end{matrix} \begin{pmatrix} 22 \\ 8.9 \\ 25 \end{pmatrix} + \begin{matrix} \text{DL} \\ \text{Wall} \end{matrix} \begin{pmatrix} 60 \end{pmatrix} + \begin{matrix} \text{Roof} \\ \text{PSF Tributary} \\ \text{SL} \end{matrix} \begin{pmatrix} 0 \\ 0.0 \\ 0 \end{pmatrix} = \begin{matrix} \text{DL} \\ \text{SL} \\ \Sigma \end{matrix} \begin{pmatrix} 256 \\ 223 \\ 479 \end{pmatrix}$$

**RB8**      4x10

$$R_1 = \begin{matrix} \text{DL} \\ \text{SL} \end{matrix} \begin{pmatrix} 0.83 \\ 0.78 \end{pmatrix} \quad \Sigma \quad 1.61 \text{ k}$$

$$R_2 = \begin{pmatrix} 0.83 \\ 0.78 \end{pmatrix} \quad \Sigma \quad 1.61 \text{ k}$$

$$W_1 = \begin{matrix} \text{Roof} \\ \text{PSF Tributary} \\ \text{SL} \end{matrix} \begin{pmatrix} 22 \\ 8.9 \\ 25 \end{pmatrix} + \begin{matrix} \text{DL} \\ \text{Wall} \end{matrix} \begin{pmatrix} 40 \end{pmatrix} + \begin{matrix} \text{Roof} \\ \text{PSF Tributary} \\ \text{SL} \end{matrix} \begin{pmatrix} 0 \\ 0.0 \\ 0 \end{pmatrix} = \begin{matrix} \text{DL} \\ \text{SL} \\ \Sigma \end{matrix} \begin{pmatrix} 236 \\ 223 \\ 459 \end{pmatrix}$$

**RB9**      4x8

$$R_1 = \begin{matrix} \text{DL} \\ \text{SL} \end{matrix} \begin{pmatrix} 0.94 \\ 1.07 \end{pmatrix} \quad \Sigma \quad 2.00 \text{ k}$$

$$R_2 = \begin{pmatrix} 0.94 \\ 1.07 \end{pmatrix} \quad \Sigma \quad 2.00 \text{ k}$$

$$W_1 = \begin{matrix} \text{Roof} \\ \text{PSF Tributary} \\ \text{SL} \end{matrix} \begin{pmatrix} 22 \\ 17.0 \\ 25 \end{pmatrix} + \begin{matrix} \text{DL} \\ \text{Wall} \end{matrix} \begin{pmatrix} 0 \end{pmatrix} + \begin{matrix} \text{Roof} \\ \text{PSF Tributary} \\ \text{SL} \end{matrix} \begin{pmatrix} 0 \\ 0.0 \\ 0 \end{pmatrix} = \begin{matrix} \text{DL} \\ \text{SL} \\ \Sigma \end{matrix} \begin{pmatrix} 375 \\ 426 \\ 801 \end{pmatrix}$$

**RB10**      PT 6x10 HF 1

$$R_1 = \begin{matrix} \text{DL} \\ \text{SL} \end{matrix} \begin{pmatrix} -0.71 \\ -0.81 \end{pmatrix} \quad \Sigma \quad -1.53 \text{ k}$$

$$R_2 = \begin{pmatrix} -0.71 \\ -0.81 \end{pmatrix} \quad \Sigma \quad -1.53 \text{ k}$$

$$W_1 = \begin{matrix} \text{Roof} \\ \text{PSF Tributary} \\ \text{SL} \end{matrix} \begin{pmatrix} 22 \\ -5.9 \\ 25 \end{pmatrix} + \begin{matrix} \text{DL} \\ \text{Wall} \end{matrix} \begin{pmatrix} 0 \end{pmatrix} + \begin{matrix} \text{Roof} \\ \text{PSF Tributary} \\ \text{SL} \end{matrix} \begin{pmatrix} 0 \\ 0.0 \\ 0 \end{pmatrix} = \begin{matrix} \text{DL} \\ \text{SL} \\ \Sigma \end{matrix} \begin{pmatrix} -130 \\ -148 \\ -277 \end{pmatrix}$$

**RB11**      4x10

$$R_1 = \begin{matrix} \text{DL} \\ \text{SL} \end{matrix} \begin{pmatrix} 1.16 \\ 1.32 \end{pmatrix} \quad \Sigma \quad 2.48 \text{ k}$$

$$R_2 = \begin{pmatrix} 1.16 \\ 1.32 \end{pmatrix} \quad \Sigma \quad 2.48 \text{ k}$$

$$W_1 = \begin{matrix} \text{Roof} \\ \text{PSF Tributary} \\ \text{SL} \end{matrix} \begin{pmatrix} 22 \\ 21.1 \\ 25 \end{pmatrix} + \begin{matrix} \text{DL} \\ \text{Wall} \end{matrix} \begin{pmatrix} 0 \end{pmatrix} + \begin{matrix} \text{Roof} \\ \text{PSF Tributary} \\ \text{SL} \end{matrix} \begin{pmatrix} 0 \\ 0.0 \\ 0 \end{pmatrix} = \begin{matrix} \text{DL} \\ \text{SL} \\ \Sigma \end{matrix} \begin{pmatrix} 465 \\ 528 \\ 993 \end{pmatrix}$$

**RB12**      4x8

$$R_1 = \begin{matrix} \text{DL} \\ \text{SL} \end{matrix} \begin{pmatrix} 0.52 \\ 0.53 \end{pmatrix} \quad \Sigma \quad 1.05 \text{ k}$$

$$R_2 = \begin{pmatrix} 0.52 \\ 0.53 \end{pmatrix} \quad \Sigma \quad 1.05 \text{ k}$$

$$W_1 = \begin{matrix} \text{Roof} \\ \text{PSF Tributary} \\ \text{SL} \end{matrix} \begin{pmatrix} 22 \\ 14.0 \\ 25 \end{pmatrix} + \begin{matrix} \text{DL} \\ \text{Wall} \end{matrix} \begin{pmatrix} 40 \end{pmatrix} + \begin{matrix} \text{Roof} \\ \text{PSF Tributary} \\ \text{SL} \end{matrix} \begin{pmatrix} 0 \\ 0.0 \\ 0 \end{pmatrix} = \begin{matrix} \text{DL} \\ \text{SL} \\ \Sigma \end{matrix} \begin{pmatrix} 348 \\ 350 \\ 698 \end{pmatrix}$$

# SOLUTIONS 4 STRUCTURES INC.

## LOADS ONLY

**RB13**      4x8

$L = 5.00 \text{ ft}$

$$R_1 = \begin{matrix} \text{DL} \\ \text{SL} \end{matrix} \begin{pmatrix} 0.77 \\ 0.88 \end{pmatrix} \quad R_2 = \begin{pmatrix} 0.77 \\ 0.88 \end{pmatrix}$$

$$\Sigma \quad \quad \quad \Sigma \quad \quad \quad \Sigma \quad \quad \quad \Sigma$$

$$\begin{matrix} 1.65 \\ \text{k} \end{matrix} \quad \quad \quad \begin{matrix} 1.65 \\ \text{k} \end{matrix}$$

$$W_1 = \begin{matrix} \text{Roof} \\ \text{PSF Tributary} \\ \text{SL} \end{matrix} \begin{pmatrix} 22 \\ 25 \end{pmatrix} \begin{pmatrix} 14.0 \\ 14.0 \end{pmatrix} + \begin{matrix} \text{DL} \\ \text{Wall} \end{matrix} \begin{pmatrix} 0 \\ 0 \end{pmatrix} + \begin{matrix} \text{Roof} \\ \text{PSF Tributary} \\ \text{SL} \end{matrix} \begin{pmatrix} 0 \\ 0 \end{pmatrix} \begin{pmatrix} 0.0 \\ 0.0 \end{pmatrix} = \begin{matrix} \text{DL} \\ \text{SL} \\ \Sigma \end{matrix} \begin{pmatrix} 309 \\ 351 \\ 660 \end{pmatrix} \text{ PLF}$$

**RB14**      PT 4x10

$L = 9.00 \text{ ft}$

$$R_1 = \begin{matrix} \text{DL} \\ \text{SL} \end{matrix} \begin{pmatrix} -0.58 \\ -0.66 \end{pmatrix} \quad R_2 = \begin{pmatrix} -0.58 \\ -0.66 \end{pmatrix}$$

$$\Sigma \quad \quad \quad \Sigma \quad \quad \quad \Sigma \quad \quad \quad \Sigma$$

$$\begin{matrix} -1.25 \\ \text{k} \end{matrix} \quad \quad \quad \begin{matrix} -1.25 \\ \text{k} \end{matrix}$$

$$W_1 = \begin{matrix} \text{Roof} \\ \text{PSF Tributary} \\ \text{SL} \end{matrix} \begin{pmatrix} 22 \\ 25 \end{pmatrix} \begin{pmatrix} -5.9 \\ -5.9 \end{pmatrix} + \begin{matrix} \text{DL} \\ \text{Wall} \end{matrix} \begin{pmatrix} 0 \\ 0 \end{pmatrix} + \begin{matrix} \text{Roof} \\ \text{PSF Tributary} \\ \text{SL} \end{matrix} \begin{pmatrix} 0 \\ 0 \end{pmatrix} \begin{pmatrix} 0.0 \\ 0.0 \end{pmatrix} = \begin{matrix} \text{DL} \\ \text{SL} \\ \Sigma \end{matrix} \begin{pmatrix} -130 \\ -148 \\ -277 \end{pmatrix} \text{ PLF}$$

**RB15**      PT 3-1/8x10.5 GLB

$L = 10.00 \text{ ft}$

$$R_1 = \begin{matrix} \text{DL} \\ \text{SL} \end{matrix} \begin{pmatrix} 0.92 \\ 1.04 \end{pmatrix} \quad R_2 = \begin{pmatrix} 0.92 \\ 1.04 \end{pmatrix}$$

$$\Sigma \quad \quad \quad \Sigma \quad \quad \quad \Sigma \quad \quad \quad \Sigma$$

$$\begin{matrix} 1.96 \\ \text{k} \end{matrix} \quad \quad \quad \begin{matrix} 1.96 \\ \text{k} \end{matrix}$$

$$W_1 = \begin{matrix} \text{Roof} \\ \text{PSF Tributary} \\ \text{SL} \end{matrix} \begin{pmatrix} 22 \\ 25 \end{pmatrix} \begin{pmatrix} 8.3 \\ 8.3 \end{pmatrix} + \begin{matrix} \text{DL} \\ \text{Wall} \end{matrix} \begin{pmatrix} 0 \\ 0 \end{pmatrix} + \begin{matrix} \text{Roof} \\ \text{PSF Tributary} \\ \text{SL} \end{matrix} \begin{pmatrix} 0 \\ 0 \end{pmatrix} \begin{pmatrix} 0.0 \\ 0.0 \end{pmatrix} = \begin{matrix} \text{DL} \\ \text{SL} \\ \Sigma \end{matrix} \begin{pmatrix} 183 \\ 208 \\ 392 \end{pmatrix} \text{ PLF}$$

**RB16**      3-1/8x10.5 GLB

$L = 10.00 \text{ ft}$

$$R_1 = \begin{matrix} \text{DL} \\ \text{SL} \end{matrix} \begin{pmatrix} 1.61 \\ 1.83 \end{pmatrix} \quad R_2 = \begin{pmatrix} 1.61 \\ 1.83 \end{pmatrix}$$

$$\Sigma \quad \quad \quad \Sigma \quad \quad \quad \Sigma \quad \quad \quad \Sigma$$

$$\begin{matrix} 3.45 \\ \text{k} \end{matrix} \quad \quad \quad \begin{matrix} 3.45 \\ \text{k} \end{matrix}$$

$$W_1 = \begin{matrix} \text{Roof} \\ \text{PSF Tributary} \\ \text{SL} \end{matrix} \begin{pmatrix} 22 \\ 25 \end{pmatrix} \begin{pmatrix} 14.7 \\ 14.7 \end{pmatrix} + \begin{matrix} \text{DL} \\ \text{Wall} \end{matrix} \begin{pmatrix} 0 \\ 0 \end{pmatrix} + \begin{matrix} \text{Roof} \\ \text{PSF Tributary} \\ \text{SL} \end{matrix} \begin{pmatrix} 0 \\ 0 \end{pmatrix} \begin{pmatrix} 0.0 \\ 0.0 \end{pmatrix} = \begin{matrix} \text{DL} \\ \text{SL} \\ \Sigma \end{matrix} \begin{pmatrix} 323 \\ 367 \\ 689 \end{pmatrix} \text{ PLF}$$

**RB17**      4x8

$L = 5.50 \text{ ft}$

$$R_1 = \begin{matrix} \text{DL} \\ \text{SL} \end{matrix} \begin{pmatrix} 0.48 \\ 0.55 \end{pmatrix} \quad R_2 = \begin{pmatrix} 0.48 \\ 0.55 \end{pmatrix}$$

$$\Sigma \quad \quad \quad \Sigma \quad \quad \quad \Sigma \quad \quad \quad \Sigma$$

$$\begin{matrix} 1.03 \\ \text{k} \end{matrix} \quad \quad \quad \begin{matrix} 1.03 \\ \text{k} \end{matrix}$$

$$W_1 = \begin{matrix} \text{Roof} \\ \text{PSF Tributary} \\ \text{SL} \end{matrix} \begin{pmatrix} 22 \\ 25 \end{pmatrix} \begin{pmatrix} 8.0 \\ 8.0 \end{pmatrix} + \begin{matrix} \text{DL} \\ \text{Wall} \end{matrix} \begin{pmatrix} 0 \\ 0 \end{pmatrix} + \begin{matrix} \text{Roof} \\ \text{PSF Tributary} \\ \text{SL} \end{matrix} \begin{pmatrix} 0 \\ 0 \end{pmatrix} \begin{pmatrix} 0.0 \\ 0.0 \end{pmatrix} = \begin{matrix} \text{DL} \\ \text{SL} \\ \Sigma \end{matrix} \begin{pmatrix} 176 \\ 200 \\ 376 \end{pmatrix} \text{ PLF}$$

# SOLUTIONS 4 STRUCTURES INC.

## LOADS ONLY

**RB18** 5-1/4 x 11-7/8 PSL

$L = 12.00$  ft

$$R_1 = \begin{matrix} \text{DL} \\ \text{SL} \end{matrix} \begin{pmatrix} 2.85 \\ 2.68 \end{pmatrix} \quad \Sigma \quad 5.53 \text{ k}$$

$$R_2 = \begin{pmatrix} 2.85 \\ 2.68 \end{pmatrix} \quad \Sigma \quad 5.53 \text{ k}$$

**Roof**

$$W_1 = \begin{matrix} \text{PSF Tributary} \\ \text{SL} \end{matrix} \begin{pmatrix} 22 \\ 25 \end{pmatrix} \begin{pmatrix} 15.0 \\ 15.0 \end{pmatrix} + \text{DL} \begin{pmatrix} 100 \\ \text{Wall} \end{pmatrix} + \begin{matrix} \text{PSF Tributary} \\ \text{SL} \end{matrix} \begin{pmatrix} 22 \\ 35 \end{pmatrix} \begin{pmatrix} 2.0 \\ 2.0 \end{pmatrix} = \begin{matrix} \text{DL} \\ \text{SL} \\ \Sigma \end{matrix} \begin{pmatrix} 475 \\ 446 \\ 921 \end{pmatrix}

**Roof**$$

**RB19** 4x8

$L = 6.00$  ft

$$R_1 = \begin{matrix} \text{DL} \\ \text{SL} \end{matrix} \begin{pmatrix} 0.26 \\ 0.42 \end{pmatrix} \quad \Sigma \quad 0.68 \text{ k}$$

$$R_2 = \begin{pmatrix} 0.26 \\ 0.42 \end{pmatrix} \quad \Sigma \quad 0.68 \text{ k}$$

**Roof**

$$W_1 = \begin{matrix} \text{PSF Tributary} \\ \text{SL} \end{matrix} \begin{pmatrix} 22 \\ 35 \end{pmatrix} \begin{pmatrix} 4.0 \\ 4.0 \end{pmatrix} + \text{DL} \begin{pmatrix} 0 \\ \text{Wall} \end{pmatrix} + \begin{matrix} \text{PSF Tributary} \\ \text{SL} \end{matrix} \begin{pmatrix} 0 \\ 0 \end{pmatrix} \begin{pmatrix} 0.0 \\ 0.0 \end{pmatrix} = \begin{matrix} \text{DL} \\ \text{SL} \\ \Sigma \end{matrix} \begin{pmatrix} 88 \\ 140 \\ 228 \end{pmatrix}

**Roof**$$

**RB20** 5-1/4 x 11-7/8 PSL

$L = 12.50$  ft

$$R_1 = \begin{matrix} \text{DL} \\ \text{SL} \end{matrix} \begin{pmatrix} 2.04 \\ 1.38 \\ 0.60 \end{pmatrix} \quad \Sigma \quad 3.52 \text{ k}$$

$$R_2 = \begin{pmatrix} 2.04 \\ 1.38 \\ 0.60 \end{pmatrix} \quad \Sigma \quad 3.52 \text{ k}$$

**Roof**

$$W_1 = \begin{matrix} \text{PSF Tributary} \\ \text{SL} \end{matrix} \begin{pmatrix} 22 \\ 25 \end{pmatrix} \begin{pmatrix} 3.8 \\ 3.8 \end{pmatrix} + \text{DL} \begin{pmatrix} 100 \\ \text{Wall} \end{pmatrix} + \begin{matrix} \text{PSF Tributary} \\ \text{LL} \end{matrix} \begin{pmatrix} 26 \\ 40 \end{pmatrix} \begin{pmatrix} 5.5 \\ 5.5 \end{pmatrix} = \begin{matrix} \text{DL} \\ \text{LL} \\ \text{SL} \\ \Sigma \end{matrix} \begin{pmatrix} 327 \\ 220 \\ 95 \\ 563 \end{pmatrix}

**Floor**$$

**RB21** 4x10

$L = 7.00$  ft

$$R_1 = \begin{matrix} \text{DL} \\ \text{SL} \end{matrix} \begin{pmatrix} 1.14 \\ 0.77 \\ 0.33 \end{pmatrix} \quad \Sigma \quad 1.97 \text{ k}$$

$$R_2 = \begin{pmatrix} 1.14 \\ 0.77 \\ 0.33 \end{pmatrix} \quad \Sigma \quad 1.97 \text{ k}$$

**Roof**

$$W_1 = \begin{matrix} \text{PSF Tributary} \\ \text{SL} \end{matrix} \begin{pmatrix} 22 \\ 25 \end{pmatrix} \begin{pmatrix} 3.8 \\ 3.8 \end{pmatrix} + \text{DL} \begin{pmatrix} 100 \\ \text{Wall} \end{pmatrix} + \begin{matrix} \text{PSF Tributary} \\ \text{LL} \end{matrix} \begin{pmatrix} 26 \\ 40 \end{pmatrix} \begin{pmatrix} 5.5 \\ 5.5 \end{pmatrix} = \begin{matrix} \text{DL} \\ \text{LL} \\ \text{SL} \\ \Sigma \end{matrix} \begin{pmatrix} 327 \\ 220 \\ 95 \\ 563 \end{pmatrix}

**Floor**$$

**RB22** 4x10

$L = 10.00$  ft

$$R_1 = \begin{matrix} \text{DL} \\ \text{SL} \end{matrix} \begin{pmatrix} 0.39 \\ 0.62 \end{pmatrix} \quad \Sigma \quad 1.02 \text{ k}$$

$$R_2 = \begin{pmatrix} 0.39 \\ 0.62 \end{pmatrix} \quad \Sigma \quad 1.02 \text{ k}$$

**Roof**

$$W_1 = \begin{matrix} \text{PSF Tributary} \\ \text{SL} \end{matrix} \begin{pmatrix} 22 \\ 35 \end{pmatrix} \begin{pmatrix} 3.6 \\ 3.6 \end{pmatrix} + \text{DL} \begin{pmatrix} 0 \\ \text{Wall} \end{pmatrix} + \begin{matrix} \text{PSF Tributary} \\ \text{SL} \end{matrix} \begin{pmatrix} 0 \\ 0 \end{pmatrix} \begin{pmatrix} 0.0 \\ 0.0 \end{pmatrix} = \begin{matrix} \text{DL} \\ \text{SL} \\ \Sigma \end{matrix} \begin{pmatrix} 79 \\ 125 \\ 203 \end{pmatrix}

**Roof**$$

# SOLUTIONS 4 STRUCTURES Inc.

## LOADS ONLY

**RB23**      4x8

$L = 10.00 \text{ ft}$

$$R_1 = \begin{matrix} \text{DL} \\ \text{SL} \end{matrix} \begin{pmatrix} 0.27 \\ 0.43 \end{pmatrix} \quad \quad \quad R_2 = \begin{pmatrix} 0.27 \\ 0.43 \end{pmatrix}$$

$$\frac{\Sigma}{\Sigma} \quad \quad \quad \frac{\Sigma}{\Sigma} \quad \quad \quad \text{k} \quad \quad \quad \text{k}$$

$W_1 = \text{DL} \begin{pmatrix} 22 \\ 35 \end{pmatrix} \begin{pmatrix} 2.4 \\ 2.4 \end{pmatrix} + \text{DL} \begin{pmatrix} 0 \\ \text{Wall} \end{pmatrix} + \text{DL} \begin{pmatrix} 0 \\ 0 \end{pmatrix} \begin{pmatrix} 0.0 \\ 0.0 \end{pmatrix} = \text{DL} \begin{pmatrix} 53 \\ 85 \end{pmatrix}$

$\Sigma \quad \quad \quad \Sigma \quad \quad \quad \text{PLF}$

**GT-1**

$L = 11.00 \text{ ft}$

$$R_1 = \begin{matrix} \text{DL} \\ \text{SL} \end{matrix} \begin{pmatrix} 1.48 \\ 1.68 \end{pmatrix} \quad \quad \quad R_2 = \begin{pmatrix} 1.48 \\ 1.68 \end{pmatrix}$$

$$\frac{\Sigma}{\Sigma} \quad \quad \quad \frac{\Sigma}{\Sigma} \quad \quad \quad \text{k} \quad \quad \quad \text{k}$$

$W_1 = \text{DL} \begin{pmatrix} 22 \\ 25 \end{pmatrix} \begin{pmatrix} 12.3 \\ 12.3 \end{pmatrix} + \text{DL} \begin{pmatrix} 0 \\ \text{Wall} \end{pmatrix} + \text{DL} \begin{pmatrix} 0 \\ 0 \end{pmatrix} \begin{pmatrix} 0.0 \\ 0.0 \end{pmatrix} = \text{DL} \begin{pmatrix} 270 \\ 306 \end{pmatrix}$

$\Sigma \quad \quad \quad \Sigma \quad \quad \quad \text{PLF}$

**GT-2**

$L = 13.00 \text{ ft}$

$$R_1 = \begin{matrix} \text{DL} \\ \text{SL} \end{matrix} \begin{pmatrix} 2.36 \\ 2.68 \end{pmatrix} \quad \quad \quad R_2 = \begin{pmatrix} 2.36 \\ 2.68 \end{pmatrix}$$

$$\frac{\Sigma}{\Sigma} \quad \quad \quad \frac{\Sigma}{\Sigma} \quad \quad \quad \text{k} \quad \quad \quad \text{k}$$

$W_1 = \text{DL} \begin{pmatrix} 22 \\ 25 \end{pmatrix} \begin{pmatrix} 16.5 \\ 16.5 \end{pmatrix} + \text{DL} \begin{pmatrix} 0 \\ \text{Wall} \end{pmatrix} + \text{DL} \begin{pmatrix} 0 \\ 0 \end{pmatrix} \begin{pmatrix} 0.0 \\ 0.0 \end{pmatrix} = \text{DL} \begin{pmatrix} 363 \\ 413 \end{pmatrix}$

$\Sigma \quad \quad \quad \Sigma \quad \quad \quad \text{PLF}$

**GT-3**

$L = 12.00 \text{ ft}$

$$R_1 = \begin{matrix} \text{DL} \\ \text{SL} \end{matrix} \begin{pmatrix} 1.78 \\ 2.03 \end{pmatrix} \quad \quad \quad R_2 = \begin{pmatrix} 1.78 \\ 2.03 \end{pmatrix}$$

$$\frac{\Sigma}{\Sigma} \quad \quad \quad \frac{\Sigma}{\Sigma} \quad \quad \quad \text{k} \quad \quad \quad \text{k}$$

$W_1 = \text{DL} \begin{pmatrix} 22 \\ 25 \end{pmatrix} \begin{pmatrix} 13.5 \\ 13.5 \end{pmatrix} + \text{DL} \begin{pmatrix} 0 \\ \text{Wall} \end{pmatrix} + \text{DL} \begin{pmatrix} 0 \\ 0 \end{pmatrix} \begin{pmatrix} 0.0 \\ 0.0 \end{pmatrix} = \text{DL} \begin{pmatrix} 297 \\ 338 \end{pmatrix}$

$\Sigma \quad \quad \quad \Sigma \quad \quad \quad \text{PLF}$

**Multiple Simple Beam**

Lic. #: KW-06013765

**Description :** Roof Beams RB1-RB12

**Wood Beam Design :** RB1

Calculations per NDS 2018, IBC 2018, CBC 2019, ASCE 7-16

BEAM Size : **4x8, Sawn, Fully Braced**

Using Allowable Stress Design with IBC 2018 Load Combinations, Major Axis Bending

Wood Species : Hem-Fir

Wood Grade : No.2

Fb - Tension	850.0 psi	Fc - Prll	1,300.0 psi	Fv	150.0 psi	Ebend- xx	1,300.0 ksi	Density	26.840 pcf
Fb - Compr	850.0 psi	Fc - Perp	405.0 psi	Ft	525.0 psi	Eminbend - xx	470.0 ksi		

Applied Loads

Beam self weight calculated and added to loads  
 Unif Load: D = 0.2160, S = 0.20 k/ft, Trib= 1.0 ft

Design Summary

Max fb/Fb Ratio =	<b>0.146</b> : 1	
fb : Actual :	185.24 psi	at 1.500 ft in Span # 1
Fb : Allowable :	1,270.75 psi	
Load Comb :	+D+S+H	
Max fv/FvRatio =	<b>0.216</b> : 1	
fv : Actual :	37.31 psi	at 0.000 ft in Span # 1
Fv : Allowable :	172.50 psi	
Load Comb :	+D+S+H	



Max Reactions (k)	D	L	Lr	S	W	E	H
Left Support	0.33			0.30			
Right Support	0.33			0.30			

Max Deflections

Transient Downward	0.003 in	Total Downward	0.005 in
Ratio	9999	Ratio	6747
	LC: S Only		LC: +D+S+H
Transient Upward	0.000 in	Total Upward	0.000 in
Ratio	9999	Ratio	9999
	LC:		LC:

**Wood Beam Design :** RB2

Calculations per NDS 2018, IBC 2018, CBC 2019, ASCE 7-16

BEAM Size : **4x8, Sawn, Fully Braced**

Using Allowable Stress Design with IBC 2018 Load Combinations, Major Axis Bending

Wood Species : Hem-Fir

Wood Grade : No.2

Fb - Tension	850.0 psi	Fc - Prll	1,300.0 psi	Fv	150.0 psi	Ebend- xx	1,300.0 ksi	Density	26.840 pcf
Fb - Compr	850.0 psi	Fc - Perp	405.0 psi	Ft	525.0 psi	Eminbend - xx	470.0 ksi		

Applied Loads

Beam self weight calculated and added to loads  
 Unif Load: D = 0.3190, S = 0.3630 k/ft, Trib= 1.0 ft

Design Summary

Max fb/Fb Ratio =	<b>0.661</b> : 1	
fb : Actual :	839.89 psi	at 2.500 ft in Span # 1
Fb : Allowable :	1,270.75 psi	
Load Comb :	+D+S+H	
Max fv/FvRatio =	<b>0.588</b> : 1	
fv : Actual :	101.49 psi	at 5.000 ft in Span # 1
Fv : Allowable :	172.50 psi	
Load Comb :	+D+S+H	

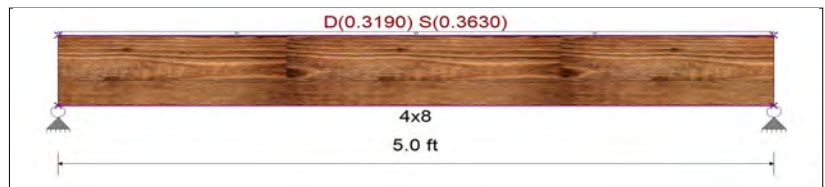

Max Reactions (k)	D	L	Lr	S	W	E	H
Left Support	0.81			0.91			
Right Support	0.81			0.91			

Max Deflections

Transient Downward	0.036 in	Total Downward	0.067 in
Ratio	1689	Ratio	892
	LC: S Only		LC: +D+S+H
Transient Upward	0.000 in	Total Upward	0.000 in
Ratio	9999	Ratio	9999
	LC:		LC:

**Multiple Simple Beam**

Lic. #: KW-06013765

**Wood Beam Design : RB3**

Calculations per NDS 2018, IBC 2018, CBC 2019, ASCE 7-16

BEAM Size : **4x8, Sawn, Fully Braced**

Using Allowable Stress Design with IBC 2018 Load Combinations, Major Axis Bending

Wood Species :	Hem-Fir		Wood Grade :	No.2		Density	26.840 pcf
Fb - Tension	850.0 psi	Fc - Prll	1,300.0 psi	Fv	150.0 psi	Ebend- xx	1,300.0 ksi
Fb - Compr	850.0 psi	Fc - Perp	405.0 psi	Ft	525.0 psi	Eminbend - xx	470.0 ksi

Applied Loads

Beam self weight calculated and added to loads  
 Unif Load: D = 0.2160, S = 0.20 k/ft, Trib= 1.0 ft

Design Summary

Max fb/Fb Ratio = **0.794** : 1  
 fb : Actual : 1,008.55 psi at 3.500 ft in Span # 1  
 Fb : Allowable : 1,270.75 psi  
 Load Comb : +D+S+H

Max fv/FvRatio = **0.505** : 1  
 fv : Actual : 87.05 psi at 0.000 ft in Span # 1  
 Fv : Allowable : 172.50 psi  
 Load Comb : +D+S+H

Max Reactions (k)	D	L	Lr	S	W	E	H
Left Support	0.77			0.70			
Right Support	0.77			0.70			



Max Deflections

Transient Downward	0.075 in	Total Downward	0.158 in
Ratio	1117	Ratio	531
LC: S Only		LC: +D+S+H	
Transient Upward	0.000 in	Total Upward	0.000 in
Ratio	9999	Ratio	9999
LC:		LC:	

**Wood Beam Design : RB4**

Calculations per NDS 2018, IBC 2018, CBC 2019, ASCE 7-16

BEAM Size : **4x10, Sawn, Fully Braced**

Using Allowable Stress Design with IBC 2018 Load Combinations, Major Axis Bending

Wood Species :	Hem-Fir		Wood Grade :	No.2		Density	26.840 pcf
Fb - Tension	850.0 psi	Fc - Prll	1,300.0 psi	Fv	150.0 psi	Ebend- xx	1,300.0 ksi
Fb - Compr	850.0 psi	Fc - Perp	405.0 psi	Ft	525.0 psi	Eminbend - xx	470.0 ksi

Applied Loads

Beam self weight calculated and added to loads  
 Unif Load: D = 0.3750, S = 0.4260 k/ft, Trib= 1.0 ft

Design Summary

Max fb/Fb Ratio = **0.744** : 1  
 fb : Actual : 873.14 psi at 3.000 ft in Span # 1  
 Fb : Allowable : 1,173.00 psi  
 Load Comb : +D+S+H

Max fv/FvRatio = **0.650** : 1  
 fv : Actual : 112.17 psi at 6.000 ft in Span # 1  
 Fv : Allowable : 172.50 psi  
 Load Comb : +D+S+H

Max Reactions (k)	D	L	Lr	S	W	E	H
Left Support	1.14			1.28			
Right Support	1.14			1.28			

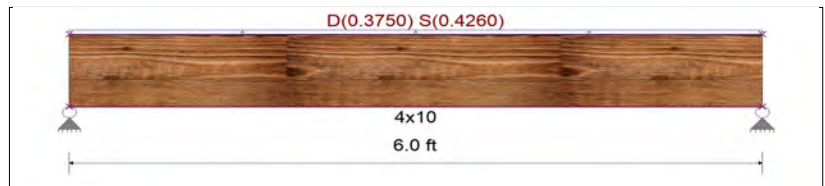

Max Deflections

Transient Downward	0.042 in	Total Downward	0.079 in
Ratio	1730	Ratio	913
LC: S Only		LC: +D+S+H	
Transient Upward	0.000 in	Total Upward	0.000 in
Ratio	9999	Ratio	9999
LC:		LC:	



**Multiple Simple Beam**

Lic. #: KW-06013765

**Wood Beam Design : RB5**

Calculations per NDS 2018, IBC 2018, CBC 2019, ASCE 7-16

BEAM Size : **4x8, Sawn, Fully Braced**

Using Allowable Stress Design with IBC 2018 Load Combinations, Major Axis Bending

Wood Species :	Hem-Fir		Wood Grade :	No.2		Density	26.840 pcf
Fb - Tension	850.0 psi	Fc - Prll	1,300.0 psi	Fv	150.0 psi	Ebend- xx	1,300.0 ksi
Fb - Compr	850.0 psi	Fc - Perp	405.0 psi	Ft	525.0 psi	Eminbend - xx	470.0 ksi

Applied Loads

Beam self weight calculated and added to loads  
 Unif Load: D = 0.3310, S = 0.3760 k/ft, Trib= 1.0 ft

Design Summary

Max fb/Fb Ratio =	<b>0.685</b> : 1
fb : Actual :	870.47 psi at 2.500 ft in Span # 1
Fb : Allowable :	1,270.75 psi
Load Comb :	+D+S+H
Max fv/FvRatio =	<b>0.610</b> : 1
fv : Actual :	105.18 psi at 5.000 ft in Span # 1
Fv : Allowable :	172.50 psi
Load Comb :	+D+S+H

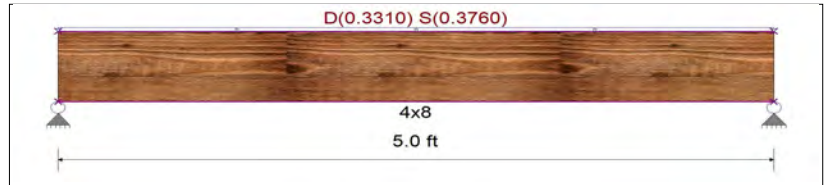

Max Reactions (k)	D	L	Lr	S	W	E	H
Left Support	0.84			0.94			
Right Support	0.84			0.94			

Max Deflections			
Transient Downward	0.037 in	Total Downward	0.070 in
Ratio	1630	Ratio	861
	LC: S Only		LC: +D+S+H
Transient Upward	0.000 in	Total Upward	0.000 in
Ratio	9999	Ratio	9999
	LC:		LC:

**Wood Beam Design : RB6**

Calculations per NDS 2018, IBC 2018, CBC 2019, ASCE 7-16

BEAM Size : **4x10, Sawn, Fully Braced**

Using Allowable Stress Design with IBC 2018 Load Combinations, Major Axis Bending

Wood Species :	Hem-Fir		Wood Grade :	No.2		Density	26.840 pcf
Fb - Tension	850.0 psi	Fc - Prll	1,300.0 psi	Fv	150.0 psi	Ebend- xx	1,300.0 ksi
Fb - Compr	850.0 psi	Fc - Perp	405.0 psi	Ft	525.0 psi	Eminbend - xx	470.0 ksi

Applied Loads

Beam self weight calculated and added to loads  
 Unif Load: D = 0.3310, S = 0.3760 k/ft, Trib= 1.0 ft

Design Summary

Max fb/Fb Ratio =	<b>0.658</b> : 1
fb : Actual :	771.44 psi at 3.000 ft in Span # 1
Fb : Allowable :	1,173.00 psi
Load Comb :	+D+S+H
Max fv/FvRatio =	<b>0.575</b> : 1
fv : Actual :	99.11 psi at 6.000 ft in Span # 1
Fv : Allowable :	172.50 psi
Load Comb :	+D+S+H

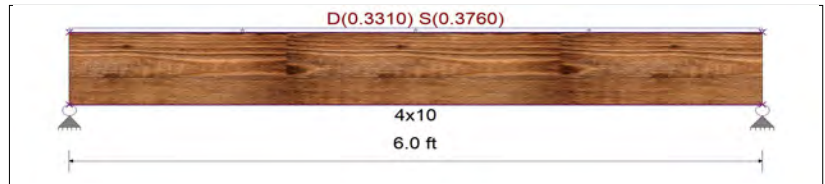

Max Reactions (k)	D	L	Lr	S	W	E	H
Left Support	1.01			1.13			
Right Support	1.01			1.13			

Max Deflections			
Transient Downward	0.037 in	Total Downward	0.070 in
Ratio	1960	Ratio	1033
	LC: S Only		LC: +D+S+H
Transient Upward	0.000 in	Total Upward	0.000 in
Ratio	9999	Ratio	9999
	LC:		LC:

**Multiple Simple Beam**

Lic. #: KW-06013765

**Wood Beam Design : RB7**

Calculations per NDS 2018, IBC 2018, CBC 2019, ASCE 7-16

BEAM Size : **4x8, Sawn, Fully Braced**

Using Allowable Stress Design with IBC 2018 Load Combinations, Major Axis Bending

Wood Species :	Hem-Fir		Wood Grade :	No.2		Density	26.840 pcf
Fb - Tension	850.0 psi	Fc - Prll	1,300.0 psi	Fv	150.0 psi	Ebend- xx	1,300.0 ksi
Fb - Compr	850.0 psi	Fc - Perp	405.0 psi	Ft	525.0 psi	Eminbend - xx	470.0 ksi

Applied Loads

Beam self weight calculated and added to loads  
 Unif Load: D = 0.2560, S = 0.2230 k/ft, Trib= 1.0 ft

Design Summary

Max fb/Fb Ratio = **0.670** : 1  
 fb : Actual : 851.93 psi at 3.000 ft in Span # 1  
 Fb : Allowable : 1,270.75 psi  
 Load Comb : +D+S+H

Max fv/FvRatio = **0.497** : 1  
 fv : Actual : 85.78 psi at 0.000 ft in Span # 1  
 Fv : Allowable : 172.50 psi  
 Load Comb : +D+S+H

Max Reactions (k)	D	L	Lr	S	W	E	H
Left Support	0.78			0.67			
Right Support	0.78			0.67			



Max Deflections

Transient Downward	0.045 in	Total Downward	0.098 in
Ratio	1591	Ratio	733
	LC: S Only		LC: +D+S+H
Transient Upward	0.000 in	Total Upward	0.000 in
Ratio	9999	Ratio	9999
	LC:		LC:

**Wood Beam Design : RB8**

Calculations per NDS 2018, IBC 2018, CBC 2019, ASCE 7-16

BEAM Size : **4x10, Sawn, Fully Braced**

Using Allowable Stress Design with IBC 2018 Load Combinations, Major Axis Bending

Wood Species :	Hem-Fir		Wood Grade :	No.2		Density	26.840 pcf
Fb - Tension	850.0 psi	Fc - Prll	1,300.0 psi	Fv	150.0 psi	Ebend- xx	1,300.0 ksi
Fb - Compr	850.0 psi	Fc - Perp	405.0 psi	Ft	525.0 psi	Eminbend - xx	470.0 ksi

Applied Loads

Beam self weight calculated and added to loads  
 Unif Load: D = 0.2360, S = 0.2230 k/ft, Trib= 1.0 ft

Design Summary

Max fb/Fb Ratio = **0.584** : 1  
 fb : Actual : 684.81 psi at 3.500 ft in Span # 1  
 Fb : Allowable : 1,173.00 psi  
 Load Comb : +D+S+H

Max fv/FvRatio = **0.437** : 1  
 fv : Actual : 75.41 psi at 0.000 ft in Span # 1  
 Fv : Allowable : 172.50 psi  
 Load Comb : +D+S+H

Max Reactions (k)	D	L	Lr	S	W	E	H
Left Support	0.85			0.78			
Right Support	0.85			0.78			



Max Deflections

Transient Downward	0.040 in	Total Downward	0.084 in
Ratio	2081	Ratio	998
	LC: S Only		LC: +D+S+H
Transient Upward	0.000 in	Total Upward	0.000 in
Ratio	9999	Ratio	9999
	LC:		LC:

**Multiple Simple Beam**

Lic. #: KW-06013765

**Wood Beam Design : RB9**

Calculations per NDS 2018, IBC 2018, CBC 2019, ASCE 7-16

BEAM Size : **4x8, Sawn, Fully Braced**

Using Allowable Stress Design with IBC 2018 Load Combinations, Major Axis Bending

Wood Species :	Hem-Fir		Wood Grade :	No.2		Density	26.840 pcf
Fb - Tension	850.0 psi	Fc - Prll	1,300.0 psi	Fv	150.0 psi	Ebend- xx	1,300.0 ksi
Fb - Compr	850.0 psi	Fc - Perp	405.0 psi	Ft	525.0 psi	Eminbend - xx	470.0 ksi

Applied Loads

Beam self weight calculated and added to loads  
 Unif Load: D = 0.3750, S = 0.4260 k/ft, Trib= 1.0 ft

Design Summary

Max fb/Fb Ratio =	<b>0.775</b> : 1
fb : Actual :	985.43 psi at 2.500 ft in Span # 1
Fb : Allowable :	1,270.75 psi
Load Comb :	+D+S+H
Max fv/FvRatio =	<b>0.690</b> : 1
fv : Actual :	119.07 psi at 0.000 ft in Span # 1
Fv : Allowable :	172.50 psi
Load Comb :	+D+S+H



Max Reactions (k)	D	L	Lr	S	W	E	H
Left Support	0.95			1.07			
Right Support	0.95			1.07			

Max Deflections			
Transient Downward	0.042 in	Total Downward	0.079 in
Ratio	1439	Ratio	761
	LC: S Only		LC: +D+S+H
Transient Upward	0.000 in	Total Upward	0.000 in
Ratio	9999	Ratio	9999
	LC:		LC:

**Wood Beam Design : RB10**

Calculations per NDS 2018, IBC 2018, CBC 2019, ASCE 7-16

BEAM Size : **6x10, Sawn, Fully Unbraced**

Using Allowable Stress Design with IBC 2018 Load Combinations, Major Axis Bending

Wood Species :	Hem-Fir		Wood Grade :	No.1		Density	26.840 pcf
Fb - Tension	1,050.0 psi	Fc - Prll	750.0 psi	Fv	140.0 psi	Ebend- xx	1,300.0 ksi
Fb - Compr	1,050.0 psi	Fc - Perp	405.0 psi	Ft	525.0 psi	Eminbend - xx	470.0 ksi

Applied Loads

Beam self weight calculated and added to loads  
 Unif Load: D = -0.130, S = -0.1480 k/ft, Trib= 1.0 ft

Design Summary

Max fb/Fb Ratio =	<b>0.614</b> : 1
fb : Actual :	588.54 psi at 5.500 ft in Span # 1
Fb : Allowable :	958.83 psi
Load Comb :	+D+S+H
Max fv/FvRatio =	<b>0.329</b> : 1
fv : Actual :	42.36 psi at 0.000 ft in Span # 1
Fv : Allowable :	128.80 psi
Load Comb :	+D+S+H

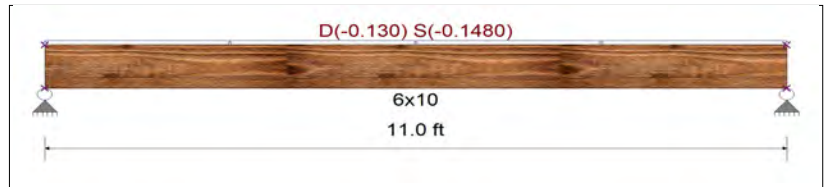

Max Reactions (k)	D	L	Lr	S	W	E	H
Left Support	-0.66			-0.81			
Right Support	-0.66			-0.81			

Max Deflections			
Transient Downward	0.000 in	Total Downward	0.000 in
Ratio	9999	Ratio	9999
	LC:		LC:
Transient Upward	-0.096 in	Total Upward	-0.174 in
Ratio	1375	Ratio	759
	LC: S Only		LC: +D+S+H

**Multiple Simple Beam**

Lic. #: KW-06013765

**Wood Beam Design : RB11**

Calculations per NDS 2018, IBC 2018, CBC 2019, ASCE 7-16

BEAM Size : **4x10, Sawn, Fully Braced**

Using Allowable Stress Design with IBC 2018 Load Combinations, Major Axis Bending

Wood Species :	Hem-Fir		Wood Grade :	No.2		Density	26.840 pcf
Fb - Tension	575.0 psi	Fc - Prll	575.0 psi	Fv	140.0 psi	Ebend- xx	1,100.0 ksi
Fb - Compr	575.0 psi	Fc - Perp	405.0 psi	Ft	375.0 psi	Eminbend - xx	400.0 ksi

Applied Loads

Beam self weight calculated and added to loads  
 Unif Load: D = 0.4650, S = 0.5280 k/ft, Trib= 1.0 ft

Design Summary

Max fb/Fb Ratio =	<b>0.946</b> : 1
fb : Actual :	750.60 psi at 2.500 ft in Span # 1
Fb : Allowable :	793.50 psi
Load Comb :	+D+S+H
Max fv/FvRatio =	<b>0.719</b> : 1
fv : Actual :	115.72 psi at 0.000 ft in Span # 1
Fv : Allowable :	161.00 psi
Load Comb :	+D+S+H



Max Reactions (k)	D	L	Lr	S	W	E	H
Left Support	1.18			1.32			
Right Support	1.18			1.32			

Max Deflections			
Transient Downward	0.029 in	Total Downward	0.056 in
Ratio	2041	Ratio	1078
	LC: S Only		LC: +D+S+H
Transient Upward	0.000 in	Total Upward	0.000 in
Ratio	9999	Ratio	9999
	LC:		LC:

**Wood Beam Design : RB12**

Calculations per NDS 2018, IBC 2018, CBC 2019, ASCE 7-16

BEAM Size : **4x8, Sawn, Fully Braced**

Using Allowable Stress Design with IBC 2018 Load Combinations, Major Axis Bending

Wood Species :	Hem-Fir		Wood Grade :	No.2		Density	26.840 pcf
Fb - Tension	575.0 psi	Fc - Prll	575.0 psi	Fv	140.0 psi	Ebend- xx	1,100.0 ksi
Fb - Compr	575.0 psi	Fc - Perp	405.0 psi	Ft	375.0 psi	Eminbend - xx	400.0 ksi

Applied Loads

Beam self weight calculated and added to loads  
 Unif Load: D = 0.3480, S = 0.350 k/ft, Trib= 1.0 ft

Design Summary

Max fb/Fb Ratio =	<b>0.360</b> : 1
fb : Actual :	309.41 psi at 1.500 ft in Span # 1
Fb : Allowable :	859.63 psi
Load Comb :	+D+S+H
Max fv/FvRatio =	<b>0.387</b> : 1
fv : Actual :	62.31 psi at 3.000 ft in Span # 1
Fv : Allowable :	161.00 psi
Load Comb :	+D+S+H



Max Reactions (k)	D	L	Lr	S	W	E	H
Left Support	0.53			0.53			
Right Support	0.53			0.53			

Max Deflections			
Transient Downward	0.005 in	Total Downward	0.011 in
Ratio	6863	Ratio	3418
	LC: S Only		LC: +D+S+H
Transient Upward	0.000 in	Total Upward	0.000 in
Ratio	9999	Ratio	9999
	LC:		LC:

**Multiple Simple Beam**

Lic. #: KW-06013765

**Description :** Roof Beams RB13-RB23

**Wood Beam Design :** RB13

Calculations per NDS 2018, IBC 2018, CBC 2019, ASCE 7-16

BEAM Size : **4x8, Sawn, Fully Braced**

Using Allowable Stress Design with IBC 2018 Load Combinations, Major Axis Bending

Wood Species :	Hem-Fir		Wood Grade :	No.2		Density	26.840 pcf
Fb - Tension	850.0 psi	Fc - Prll	1,300.0 psi	Fv	150.0 psi	Ebend- xx	1,300.0 ksi
Fb - Compr	850.0 psi	Fc - Perp	405.0 psi	Ft	525.0 psi	Eminbend - xx	470.0 ksi

Applied Loads

Beam self weight calculated and added to loads  
 Unif Load: D = 0.3090, S = 0.3510 k/ft, Trib= 1.0 ft

Design Summary

Max fb/Fb Ratio =	<b>0.640</b> : 1
fb : Actual :	812.99 psi at 2.500 ft in Span # 1
Fb : Allowable :	1,270.75 psi
Load Comb :	+D+S+H
Max fv/FvRatio =	<b>0.569</b> : 1
fv : Actual :	98.24 psi at 5.000 ft in Span # 1
Fv : Allowable :	172.50 psi
Load Comb :	+D+S+H



Max Reactions (k)	D	L	Lr	S	W	E	H
Left Support	0.78			0.88			
Right Support	0.78			0.88			

Max Deflections			
Transient Downward	0.034 in	Total Downward	0.065 in
Ratio	1747	Ratio	922
	LC: S Only		LC: +D+S+H
Transient Upward	0.000 in	Total Upward	0.000 in
Ratio	9999	Ratio	9999
	LC:		LC:

**Wood Beam Design :** RB14

Calculations per NDS 2018, IBC 2018, CBC 2019, ASCE 7-16

BEAM Size : **4x10, Sawn, Fully Unbraced**

Using Allowable Stress Design with IBC 2018 Load Combinations, Major Axis Bending

Wood Species :	Hem-Fir		Wood Grade :	No.2		Density	26.840 pcf
Fb - Tension	850.0 psi	Fc - Prll	1,300.0 psi	Fv	150.0 psi	Ebend- xx	1,300.0 ksi
Fb - Compr	850.0 psi	Fc - Perp	405.0 psi	Ft	525.0 psi	Eminbend - xx	470.0 ksi

Applied Loads

Beam self weight calculated and added to loads  
 Unif Load: D = -0.130, S = -0.1480 k/ft, Trib= 1.0 ft

Design Summary

Max fb/Fb Ratio =	<b>0.717</b> : 1
fb : Actual :	662.05 psi at 4.500 ft in Span # 1
Fb : Allowable :	922.87 psi
Load Comb :	+D+S+H
Max fv/FvRatio =	<b>0.411</b> : 1
fv : Actual :	56.70 psi at 0.000 ft in Span # 1
Fv : Allowable :	138.00 psi
Load Comb :	+D+S+H



Max Reactions (k)	D	L	Lr	S	W	E	H
Left Support	-0.56			-0.67			
Right Support	-0.56			-0.67			

Max Deflections			
Transient Downward	0.000 in	Total Downward	0.000 in
Ratio	9999	Ratio	9999
	LC:		LC:
Transient Upward	-0.073 in	Total Upward	-0.135 in
Ratio	1475	Ratio	802
	LC: S Only		LC: +D+S+H

**Multiple Simple Beam**

Lic. #: KW-06013765

**Wood Beam Design : RB15**

Calculations per NDS 2018, IBC 2018, CBC 2019, ASCE 7-16

BEAM Size : **3.125x10.5, GLB, Fully Braced**  
 Using Allowable Stress Design with IBC 2018 Load Combinations, Major Axis Bending  
 Wood Species : DF/DF Wood Grade : 24F-V4  
 Fb - Tension 2400 psi Fc - Prll 1650 psi Fv 265 psi Ebend- xx 1800 ksi Density 31.21 pcf  
 Fb - Compr 1850 psi Fc - Perp 650 psi Ft 1100 psi Eminbend - xx 950 ksi

Applied Loads

Beam self weight calculated and added to loads  
 Unif Load: D = 0.1830, S = 0.2080 k/ft, Trib= 1.0 ft

Design Summary

Max fb/Fb Ratio = **0.377** : 1  
 fb : Actual : 1,039.97 psi at 5.000 ft in Span # 1  
 Fb : Allowable : 2,760.00 psi  
 Load Comb : +D+S+H

Max fv/FvRatio = **0.299** : 1  
 fv : Actual : 91.00 psi at 0.000 ft in Span # 1  
 Fv : Allowable : 304.75 psi  
 Load Comb : +D+S+H

Max Reactions (k)	D	L	Lr	S	W	E	H
Left Support	0.95			1.04			
Right Support	0.95			1.04			



Max Deflections

Transient Downward	0.087 in	Total Downward	0.166 in
Ratio	1383	Ratio	723
	LC: S Only		LC: +D+S+H
Transient Upward	0.000 in	Total Upward	0.000 in
Ratio	9999	Ratio	9999
	LC:		LC:

**Wood Beam Design : RB16**

Calculations per NDS 2018, IBC 2018, CBC 2019, ASCE 7-16

BEAM Size : **3.125x10.5, GLB, Fully Braced**  
 Using Allowable Stress Design with IBC 2018 Load Combinations, Major Axis Bending  
 Wood Species : DF/DF Wood Grade : 24F-V4  
 Fb - Tension 2400 psi Fc - Prll 1650 psi Fv 265 psi Ebend- xx 1800 ksi Density 31.21 pcf  
 Fb - Compr 1850 psi Fc - Perp 650 psi Ft 1100 psi Eminbend - xx 950 ksi

Applied Loads

Beam self weight calculated and added to loads  
 Unif Load: D = 0.3230, S = 0.3670 k/ft, Trib= 1.0 ft

Design Summary

Max fb/Fb Ratio = **0.660** : 1  
 fb : Actual : 1,821.03 psi at 5.000 ft in Span # 1  
 Fb : Allowable : 2,760.00 psi  
 Load Comb : +D+S+H

Max fv/FvRatio = **0.523** : 1  
 fv : Actual : 159.34 psi at 10.000 ft in Span # 1  
 Fv : Allowable : 304.75 psi  
 Load Comb : +D+S+H

Max Reactions (k)	D	L	Lr	S	W	E	H
Left Support	1.65			1.84			
Right Support	1.65			1.84			

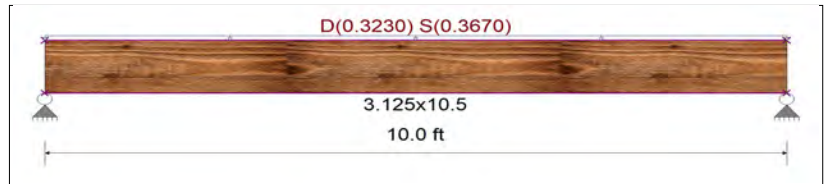

Max Deflections

Transient Downward	0.153 in	Total Downward	0.291 in
Ratio	784	Ratio	412
	LC: S Only		LC: +D+S+H
Transient Upward	0.000 in	Total Upward	0.000 in
Ratio	9999	Ratio	9999
	LC:		LC:

**Multiple Simple Beam**

Lic. #: KW-06013765

**Wood Beam Design : RB17**

Calculations per NDS 2018, IBC 2018, CBC 2019, ASCE 7-16

BEAM Size : **4x8, Sawn, Fully Braced**

Using Allowable Stress Design with IBC 2018 Load Combinations, Major Axis Bending

Wood Species : Hem-Fir Wood Grade : No.2  
 Fb - Tension 850.0 psi Fc - Prll 1,300.0 psi Fv 150.0 psi Ebend- xx 1,300.0 ksi Density 26.840 pcf  
 Fb - Compr 850.0 psi Fc - Perp 405.0 psi Ft 525.0 psi Eminbend - xx 470.0 ksi

Applied Loads

Beam self weight calculated and added to loads  
 Unif Load: D = 0.1760, S = 0.20 k/ft, Trib= 1.0 ft

Design Summary

Max fb/Fb Ratio = **0.443** : 1  
 fb : Actual : 563.43 psi at 2.750 ft in Span # 1  
 Fb : Allowable : 1,270.75 psi  
 Load Comb : +D+S+H  
 Max fv/FvRatio = **0.359** : 1  
 fv : Actual : 61.89 psi at 0.000 ft in Span # 1  
 Fv : Allowable : 172.50 psi  
 Load Comb : +D+S+H



Max Reactions (k) D L Lr S W E H  
 Left Support 0.50 0.55  
 Right Support 0.50 0.55

Max Deflections			
Transient Downward	0.029 in	Total Downward	0.055 in
Ratio	2303	Ratio	1210
LC: S Only		LC: +D+S+H	
Transient Upward	0.000 in	Total Upward	0.000 in
Ratio	9999	Ratio	9999
LC:		LC:	

**Wood Beam Design : RB18**

Calculations per NDS 2018, IBC 2018, CBC 2019, ASCE 7-16

BEAM Size : **5.25x11.875, Parallam PSL, Fully Braced**

Using Allowable Stress Design with IBC 2018 Load Combinations, Major Axis Bending

Wood Species : iLevel Truss Joist Wood Grade : Parallam PSL 2.0E  
 Fb - Tension 2900 psi Fc - Prll 2900 psi Fv 290 psi Ebend- xx 2000 ksi Density 45.07 pcf  
 Fb - Compr 2900 psi Fc - Perp 750 psi Ft 2025 psi Eminbend - xx 1016.535 ksi

Applied Loads

Beam self weight calculated and added to loads  
 Unif Load: D = 0.4480, L = 0.0270, S = 0.3960 k/ft, 0.0 ft to 3.0 ft, Trib= 1.0 ft  
 Unif Load: D = 0.0670, L = 0.0270 k/ft, 3.0 to 9.0 ft, Trib= 1.0 ft  
 Unif Load: D = 0.4480, L = 0.0270, S = 0.3960 k/ft, 9.0 to 12.0 ft, Trib= 1.0 ft  
 Point: D = 0.990, S = 1.130 k @ 3.0 ft  
 Point: D = 0.990, S = 1.130 k @ 9.0 ft

Design Summary

Max fb/Fb Ratio = **0.333** : 1  
 fb : Actual : 1,110.03 psi at 6.000 ft in Span # 1  
 Fb : Allowable : 3,335.00 psi  
 Load Comb : +D+S+H  
 Max fv/FvRatio = **0.359** : 1  
 fv : Actual : 119.58 psi at 12.000 ft in Span # 1  
 Fv : Allowable : 333.50 psi  
 Load Comb : +D+S+H



Max Reactions (k) D L Lr S W E H  
 Left Support 2.65 0.16 2.32  
 Right Support 2.65 0.16 2.32

Max Deflections			
Transient Downward	0.103 in	Total Downward	0.224 in
Ratio	1400	Ratio	643
LC: S Only		LC: +D+S+H	
Transient Upward	0.000 in	Total Upward	0.000 in
Ratio	9999	Ratio	9999
LC:		LC:	

**Multiple Simple Beam**

Lic. #: KW-06013765

**Wood Beam Design : RB19**

Calculations per NDS 2018, IBC 2018, CBC 2019, ASCE 7-16

BEAM Size : **4x8, Sawn, Fully Braced**

Using Allowable Stress Design with IBC 2018 Load Combinations, Major Axis Bending

Wood Species :	Hem-Fir		Wood Grade :	No.2		Density	26.840 pcf
Fb - Tension	850.0 psi	Fc - Prll	1,300.0 psi	Fv	150.0 psi	Ebend- xx	1,300.0 ksi
Fb - Compr	850.0 psi	Fc - Perp	405.0 psi	Ft	525.0 psi	Eminbend - xx	470.0 ksi

Applied Loads

Beam self weight calculated and added to loads  
 Unif Load: D = 0.0880, S = 0.140 k/ft, Trib= 1.0 ft

Design Summary

Max fb/Fb Ratio =	<b>0.323</b> : 1	fb : Actual :	409.88 psi	at	3.000 ft	in Span # 1
Fb : Allowable :	1,270.75 psi	Load Comb :	+D+S+H			
Max fv/FvRatio =	<b>0.239</b> : 1	fv : Actual :	41.27 psi	at	0.000 ft	in Span # 1
Fv : Allowable :	172.50 psi	Load Comb :	+D+S+H			

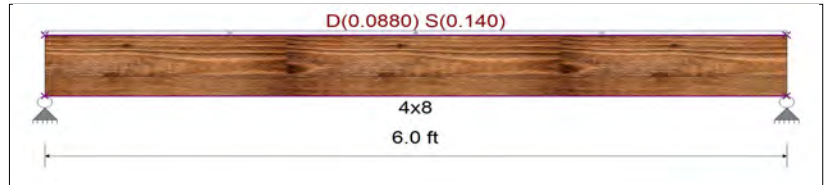

Max Reactions (k)	D	L	Lr	S	W	E	H
Left Support	0.28			0.42			
Right Support	0.28			0.42			

Max Deflections			
Transient Downward	0.028 in	Total Downward	0.047 in
Ratio	2534	Ratio	1524
LC: S Only		LC: +D+S+H	
Transient Upward	0.000 in	Total Upward	0.000 in
Ratio	9999	Ratio	9999
LC:		LC:	

**Wood Beam Design : RB20**

Calculations per NDS 2018, IBC 2018, CBC 2019, ASCE 7-16

BEAM Size : **5.125x10.5, GLB, Fully Braced**

Using Allowable Stress Design with IBC 2018 Load Combinations, Major Axis Bending

Wood Species :	DF/DF		Wood Grade :	24F-V4		Density	31.210 pcf
Fb - Tension	2,400.0 psi	Fc - Prll	1,650.0 psi	Fv	265.0 psi	Ebend- xx	1,800.0 ksi
Fb - Compr	1,850.0 psi	Fc - Perp	650.0 psi	Ft	1,100.0 psi	Eminbend - xx	950.0 ksi

Applied Loads

Unif Load: D = 0.3270, L = 0.220, S = 0.0950 k/ft, Trib= 1.0 ft

Design Summary

Max fb/Fb Ratio =	<b>0.567</b> : 1	fb : Actual :	1,361.37 psi	at	6.250 ft	in Span # 1
Fb : Allowable :	2,400.00 psi	Load Comb :	+D+L+H			
Max fv/FvRatio =	<b>0.360</b> : 1	fv : Actual :	95.30 psi	at	0.000 ft	in Span # 1
Fv : Allowable :	265.00 psi	Load Comb :	+D+L+H			

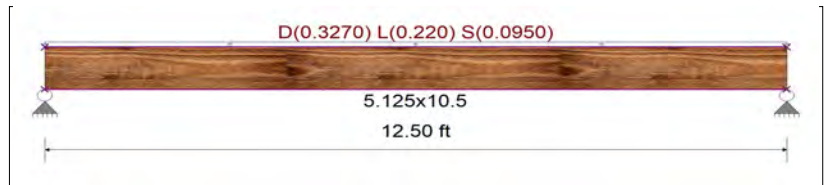

Max Reactions (k)	D	L	Lr	S	W	E	H
Left Support	2.04	1.38		0.59			
Right Support	2.04	1.38		0.59			

Max Deflections			
Transient Downward	0.137 in	Total Downward	0.350 in
Ratio	1098	Ratio	429
LC: L Only		.C: +D+0.750L+0.750S+H	
Transient Upward	0.000 in	Total Upward	0.000 in
Ratio	9999	Ratio	9999
LC:		LC:	



**Multiple Simple Beam**

Lic. #: KW-06013765

**Wood Beam Design : RB21**

Calculations per NDS 2018, IBC 2018, CBC 2019, ASCE 7-16

BEAM Size : **4x10, Sawn, Fully Braced**

Using Allowable Stress Design with IBC 2018 Load Combinations, Major Axis Bending

Wood Species : Hem-Fir

Wood Grade : No.2

Fb - Tension 850.0 psi Fc - Prll 1,300.0 psi Fv 150.0 psi Ebend- xx 1,300.0 ksi Density 26.840 pcf  
 Fb - Compr 850.0 psi Fc - Perp 405.0 psi Ft 525.0 psi Eminbend - xx 470.0 ksi

Applied Loads

Beam self weight calculated and added to loads

Unif Load: D = 0.3270, L = 0.220, S = 0.0950 k/ft, Trib= 1.0 ft

Design Summary

Max fb/Fb Ratio = **0.798** : 1  
 fb : Actual : 814.40 psi at 3.500 ft in Span # 1  
 Fb : Allowable : 1,020.00 psi  
 Load Comb : +D+L+H  
 Max fv/FvRatio = **0.598** : 1  
 fv : Actual : 89.68 psi at 0.000 ft in Span # 1  
 Fv : Allowable : 150.00 psi  
 Load Comb : +D+L+H

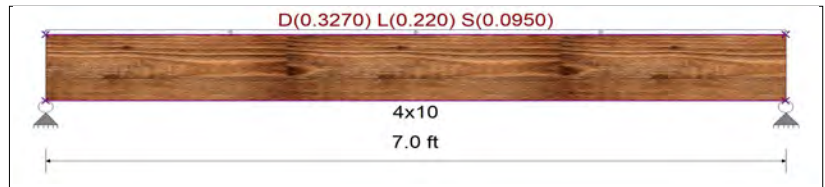

Max Reactions (k) D L Lr S W E H  
 Left Support 1.17 0.77 0.33  
 Right Support 1.17 0.77 0.33

Max Deflections

Transient Downward 0.040 in Total Downward 0.103 in  
 Ratio 2109 Ratio 815  
 LC: L Only .C: +D+0.750L+0.750S+H  
 Transient Upward 0.000 in Total Upward 0.000 in  
 Ratio 9999 Ratio 9999  
 LC: LC:

**Wood Beam Design : RB22**

Calculations per NDS 2018, IBC 2018, CBC 2019, ASCE 7-16

BEAM Size : **4x10, Sawn, Fully Braced**

Using Allowable Stress Design with IBC 2018 Load Combinations, Major Axis Bending

Wood Species : Hem-Fir

Wood Grade : No.2

Fb - Tension 850.0 psi Fc - Prll 1,300.0 psi Fv 150.0 psi Ebend- xx 1,300.0 ksi Density 26.840 pcf  
 Fb - Compr 850.0 psi Fc - Perp 405.0 psi Ft 525.0 psi Eminbend - xx 470.0 ksi

Applied Loads

Beam self weight calculated and added to loads

Unif Load: D = 0.0790, S = 0.1250 k/ft, Trib= 1.0 ft

Design Summary

Max fb/Fb Ratio = **0.538** : 1  
 fb : Actual : 631.22 psi at 5.000 ft in Span # 1  
 Fb : Allowable : 1,173.00 psi  
 Load Comb : +D+S+H  
 Max fv/FvRatio = **0.282** : 1  
 fv : Actual : 48.66 psi at 10.000 ft in Span # 1  
 Fv : Allowable : 172.50 psi  
 Load Comb : +D+S+H

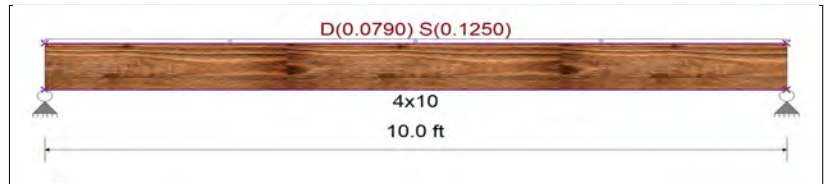

Max Reactions (k) D L Lr S W E H  
 Left Support 0.43 0.63  
 Right Support 0.43 0.63

Max Deflections

Transient Downward 0.094 in Total Downward 0.158 in  
 Ratio 1273 Ratio 757  
 LC: S Only LC: +D+S+H  
 Transient Upward 0.000 in Total Upward 0.000 in  
 Ratio 9999 Ratio 9999  
 LC: LC:

Project Title: Bradley Heights Apartments  
 Engineer: M. Oman  
 Project ID:  
 Project Descr: 3-4 Story Apartment Bldgs

Printed: 29 MAY 2023, 3:28PM

**Multiple Simple Beam**

File: Beam Designs.ec6  
 Software copyright ENERCALC, INC. 1983-2020, Build:12.20.8.24  
 Solutions 4 Structures, Inc

Lic. #: KW-06013765

**Wood Beam Design : RB23**

Calculations per NDS 2018, IBC 2018, CBC 2019, ASCE 7-16

BEAM Size : **4x8, Sawn, Fully Braced**

Using Allowable Stress Design with IBC 2018 Load Combinations, Major Axis Bending

Wood Species : Hem-Fir

Wood Grade : No.2

Fb - Tension	850.0 psi	Fc - Prll	1,300.0 psi	Fv	150.0 psi	Ebend- xx	1,300.0 ksi	Density	26.840 pcf
Fb - Compr	850.0 psi	Fc - Perp	405.0 psi	Ft	525.0 psi	Eminbend - xx	470.0 ksi		

Applied Loads

Beam self weight calculated and added to loads  
 Unif Load: D = 0.0530, S = 0.0850 k/ft, Trib= 1.0 ft

Design Summary

Max fb/Fb Ratio = **0.549** : 1  
 fb : Actual : 698.25 psi at 5.000 ft in Span # 1  
 Fb : Allowable : 1,270.75 psi  
 Load Comb : +D+S+H

Max fv/FvRatio = **0.245** : 1  
 fv : Actual : 42.19 psi at 0.000 ft in Span # 1  
 Fv : Allowable : 172.50 psi  
 Load Comb : +D+S+H

Max Reactions (k)	D	L	Lr	S	W	E	H
Left Support	0.29			0.43			
Right Support	0.29			0.43			



Max Deflections

Transient Downward	0.133 in	Total Downward	0.223 in
Ratio	901	Ratio	537
	LC: S Only		LC: +D+S+H
Transient Upward	0.000 in	Total Upward	0.000 in
Ratio	9999	Ratio	9999
	LC:		LC:

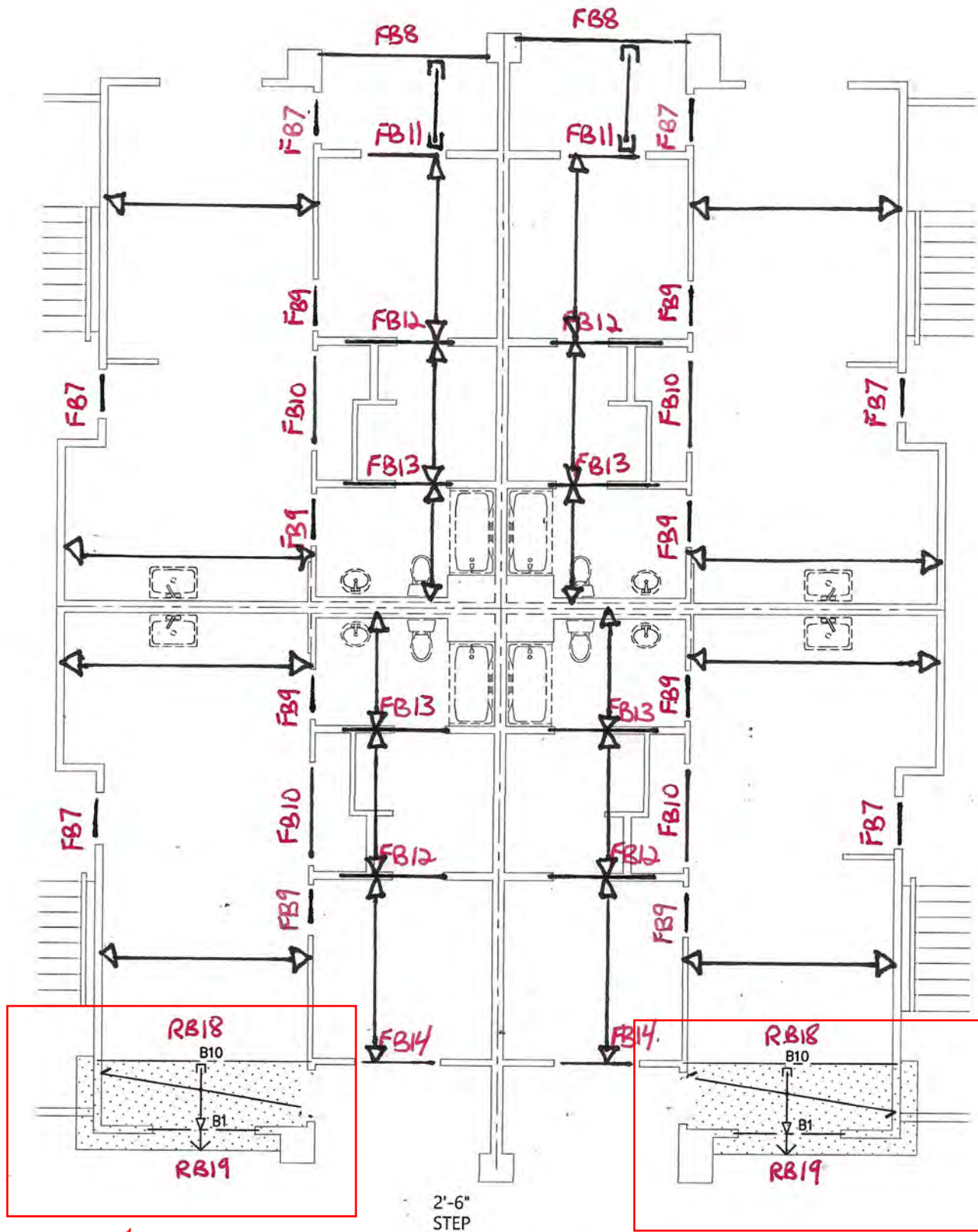

## FLOOR TYPE 2

LOW ROOF DOES NOT  
OCCUR IN BLDG G  
(TYPE 3B AT 3RD FLOOR)

PRMU20240280 BLDG G

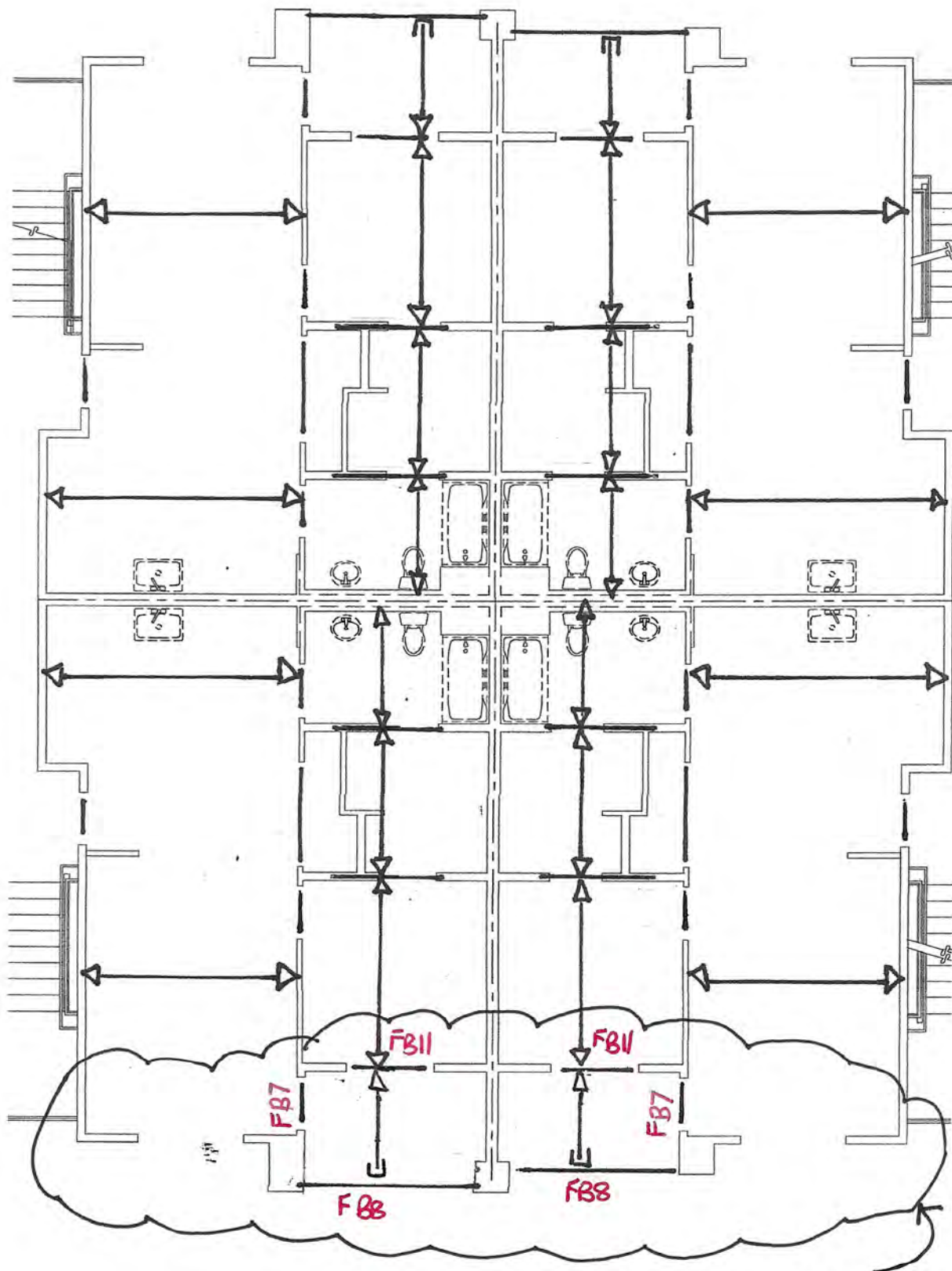

FLOOR TYPE 2 B

DIFFERENCE FROM TYPE 2

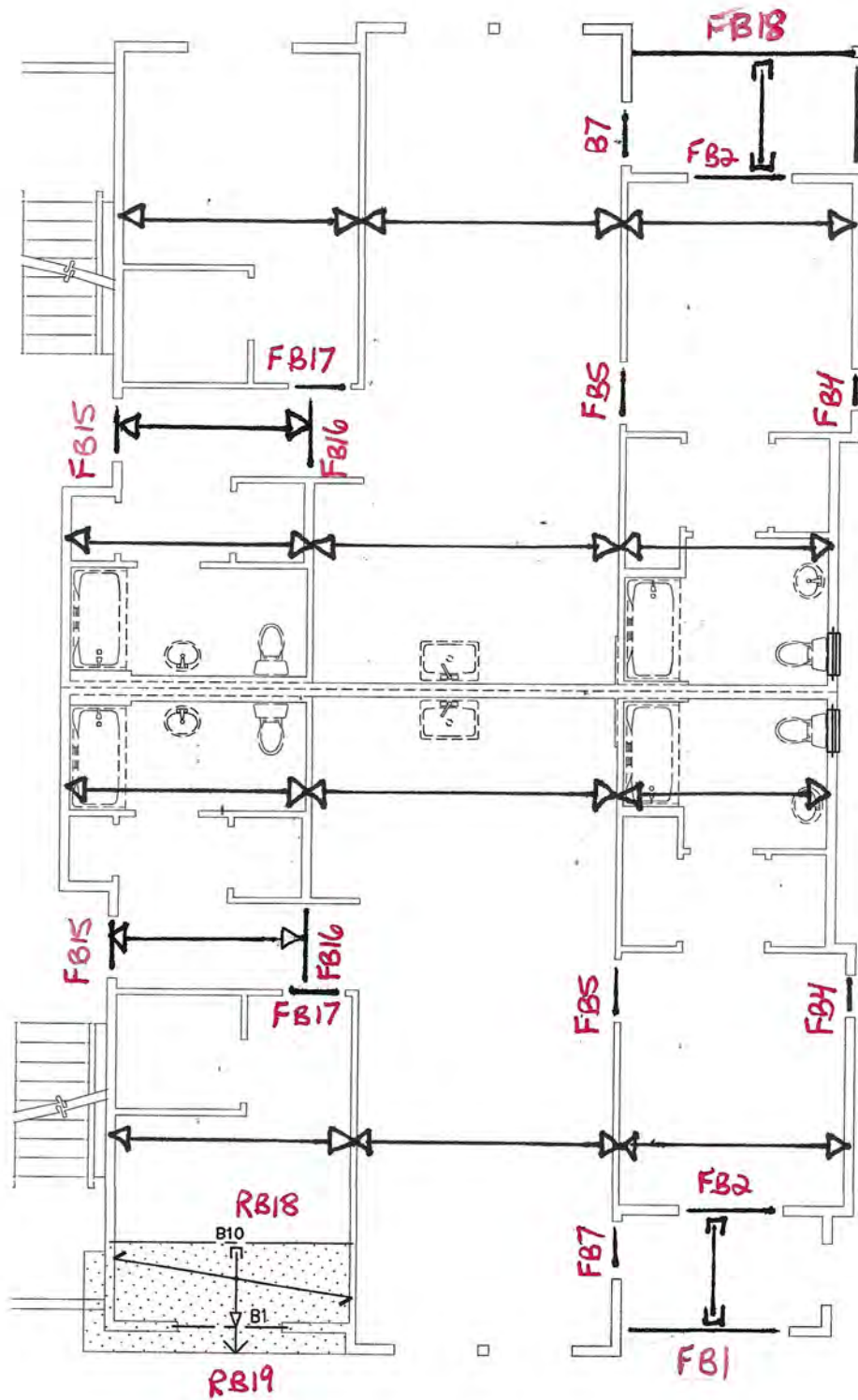

FLOOR TYPE 3

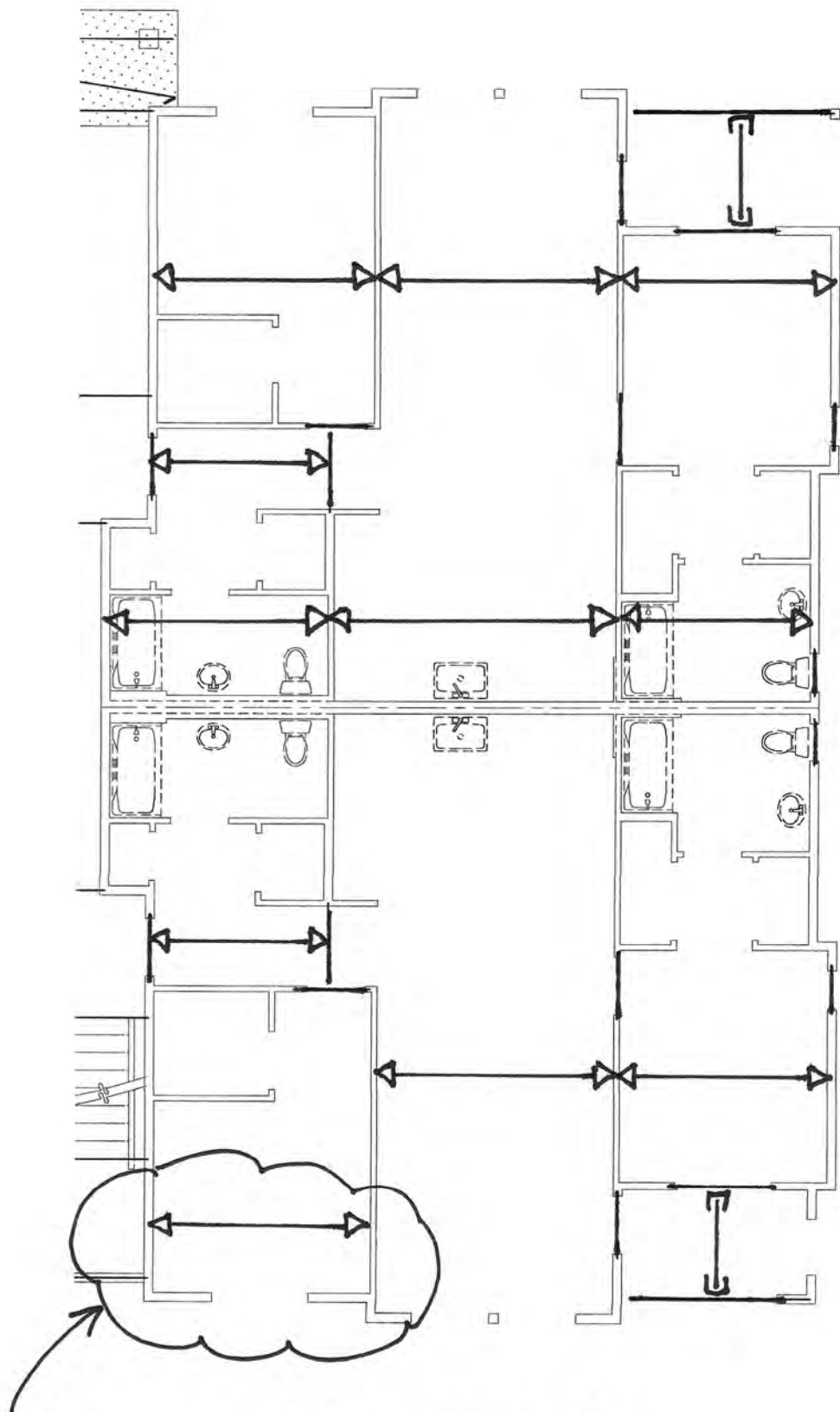

DIFFERENCE  
FROM TYPE 3

FLOOR TYPE 3B

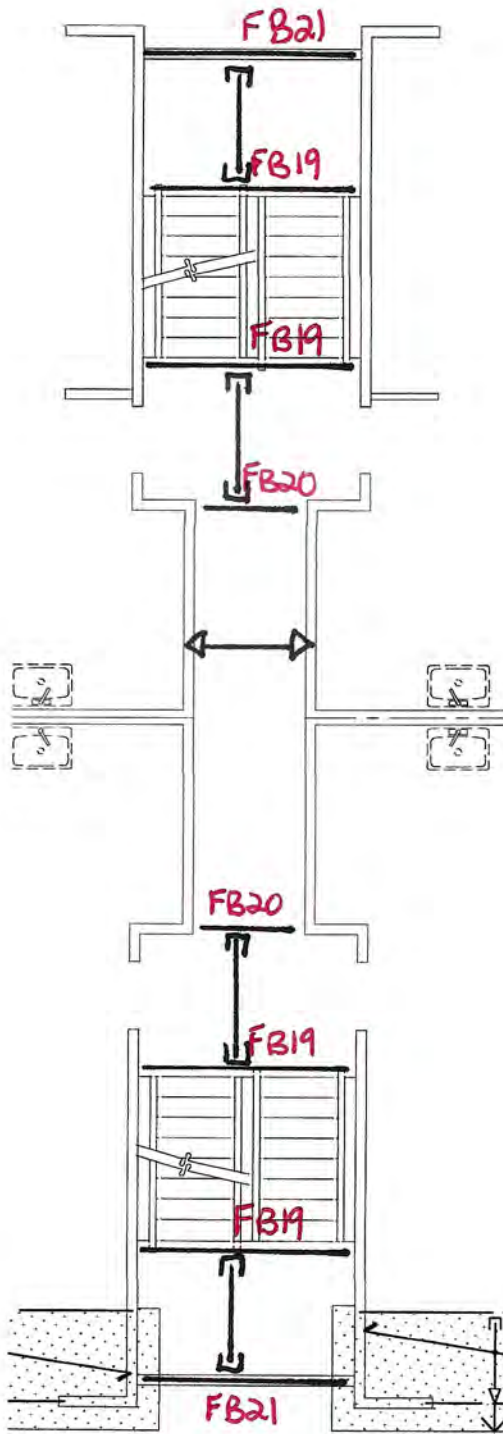

TYPICAL STAIR/CORRIDOR

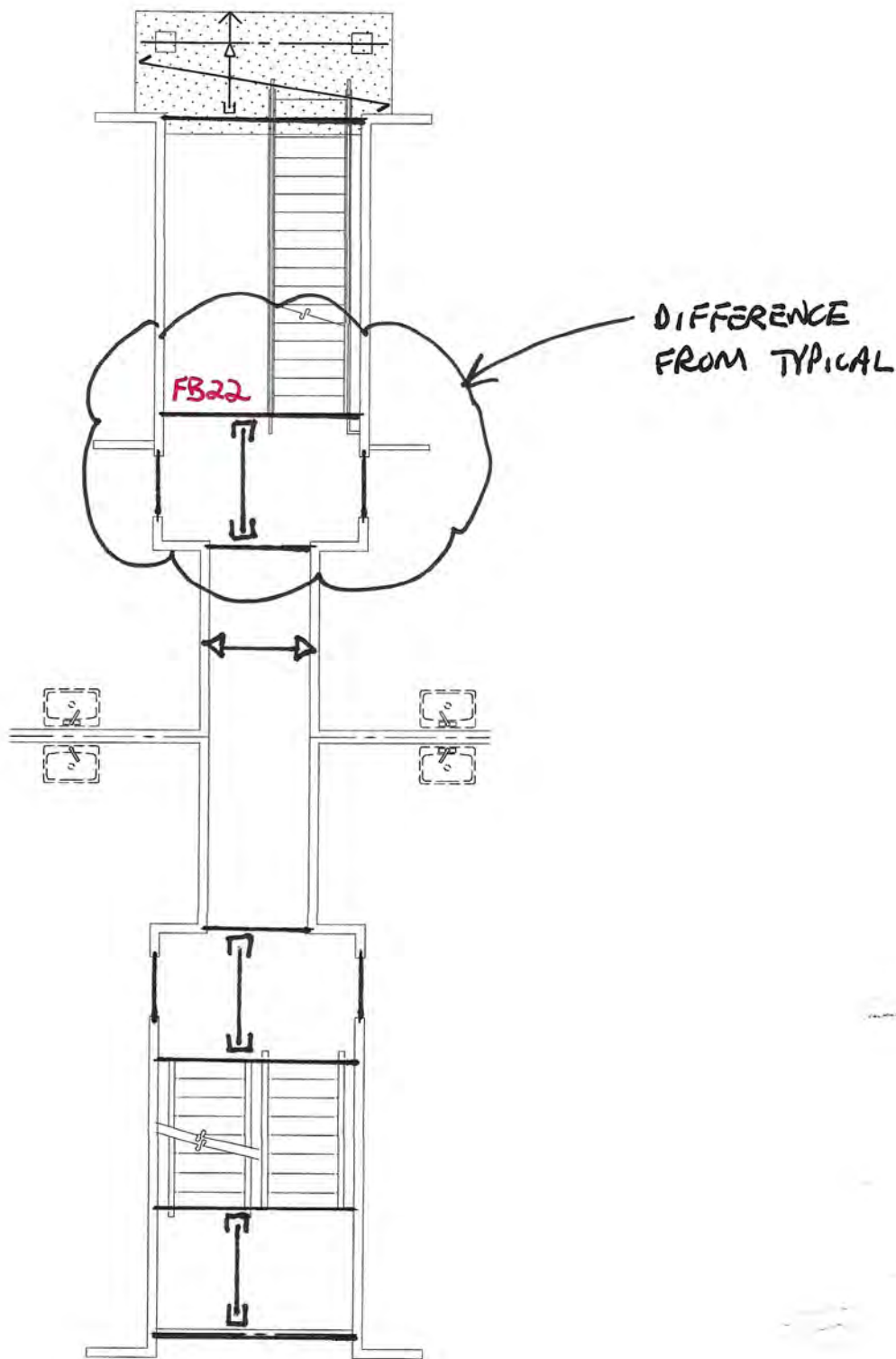

STAIR CORRIDOR (2ND FLOOR)



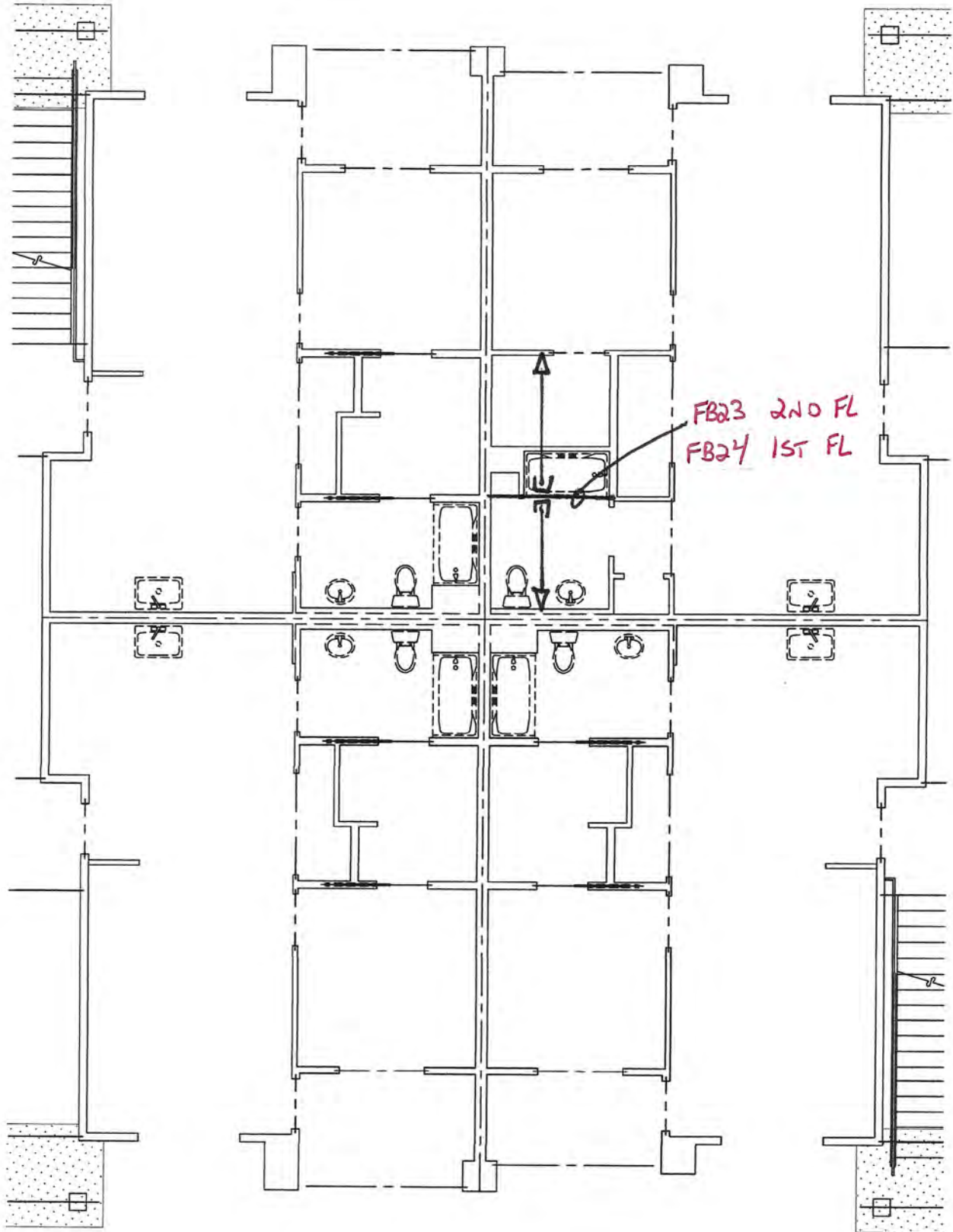

Level, J1  
1 piece(s) 11 7/8" TJI @ 110 @ 16" OC

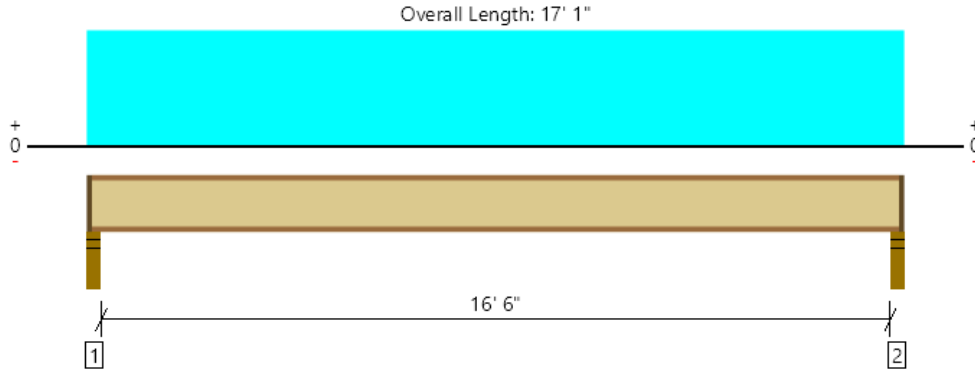

All locations are measured from the outside face of left support (or left cantilever end). All dimensions are horizontal.

Design Results	Actual @ Location	Allowed	Result	LDF	Load: Combination (Pattern)
Member Reaction (lbs)	743 @ 2 1/2"	1041 (2.25")	Passed (71%)	1.00	1.0 D + 1.0 L (All Spans)
Shear (lbs)	726 @ 3 1/2"	1560	Passed (47%)	1.00	1.0 D + 1.0 L (All Spans)
Moment (Ft-lbs)	3056 @ 8' 6 1/2"	3160	Passed (97%)	1.00	1.0 D + 1.0 L (All Spans)
Live Load Defl. (in)	0.309 @ 8' 6 1/2"	0.417	Passed (L/647)	--	1.0 D + 1.0 L (All Spans)
Total Load Defl. (in)	0.510 @ 8' 6 1/2"	0.833	Passed (L/392)	--	1.0 D + 1.0 L (All Spans)
TJ-Pro™ Rating	46	40	Passed	--	--

System : Floor  
Member Type : Joist  
Building Use : Residential  
Building Code : IBC 2018  
Design Methodology : ASD

- Deflection criteria: LL (L/480) and TL (L/240).
- Allowed moment does not reflect the adjustment for the beam stability factor.
- A structural analysis of the deck has not been performed.
- Deflection analysis is based on composite action with a single layer of 23/32" Weyerhaeuser Edge™ Panel (24" Span Rating) that is glued and nailed down.
- Additional considerations for the TJ-Pro™ Rating include: 1/2" Gypsum ceiling.

Supports	Bearing Length			Loads to Supports (lbs)			Accessories
	Total	Available	Required	Dead	Floor Live	Factored	
1 - Stud wall - SPF	3.50"	2.25"	1.75"	296	456	752	1 1/4" Rim Board
2 - Stud wall - SPF	3.50"	2.25"	1.75"	296	456	752	1 1/4" Rim Board

• Rim Board is assumed to carry all loads applied directly above it, bypassing the member being designed.

Lateral Bracing	Bracing Intervals	Comments
Top Edge (Lu)	3' 1" o/c	
Bottom Edge (Lu)	16' 11" o/c	

- TJI joists are only analyzed using Maximum Allowable bracing solutions.
- Maximum allowable bracing intervals based on applied load.

Vertical Load	Location	Spacing	Dead (0.90)	Floor Live (1.00)	Comments
1 - Uniform (PSF)	0 to 17' 1"	16"	26.0	40.0	Default Load

**Weyerhaeuser Notes**

Weyerhaeuser warrants that the sizing of its products will be in accordance with Weyerhaeuser product design criteria and published design values. Weyerhaeuser expressly disclaims any other warranties related to the software. Use of this software is not intended to circumvent the need for a design professional as determined by the authority having jurisdiction. The designer of record, builder or framer is responsible to assure that this calculation is compatible with the overall project. Accessories (Rim Board, Blocking Panels and Squash Blocks) are not designed by this software. Products manufactured at Weyerhaeuser facilities are third-party certified to sustainable forestry standards. Weyerhaeuser Engineered Lumber Products have been evaluated by ICC-ES under evaluation reports ESR-1153 and ESR-1387 and/or tested in accordance with applicable ASTM standards. For current code evaluation reports, Weyerhaeuser product literature and installation details refer to [www.weyerhaeuser.com/woodproducts/document-library](http://www.weyerhaeuser.com/woodproducts/document-library).

The product application, input design loads, dimensions and support information have been provided by ForteWEB Software Operator

ForteWEB Software Operator	Job Notes
Oleg Kondratyuk Solutions 4 Structures, Inc (253) 970-3664 oleg@solutions4structures.com	

**PRMU20240280 BLDG G**



Job #: 21.011  
 Designed: OGK  
 Date: 6/1/23

**FLOOR FRAMING**

2018 NDS/2018 IBC

C <sub>r</sub> =	1.15	repetitive
C <sub>D</sub> =	1.0	LIVE
C <sub>F</sub> =	(varies)	size

2 x 6		Pressure Treated Incising	Hem Fir	#2			
2 x 6	▼	A =	8.25	in <sup>2</sup>	Live	60.00	psf
Hem Fir	▼	S =	7.56	in <sup>3</sup>	Dead	14.00	psf
#2	▼	I =	20.80	in <sup>4</sup>	Partition	-	psf
Incising? Yes	▼	C <sub>F</sub> =	1.30		Total	74.00	psf
Wet Use? No	▼	F <sub>b</sub> =	850.00	psi			
		F <sub>v</sub> =	150.00	psi	Allowable Span @ 8" o.c. =	9.83	ft (LL Defl. )
		E =	1,300,000.00	psi	Allowable Span @ 12" o.c. =	8.49	ft (bending )
		C <sub>i</sub> =	0.80	Incising (Fb)	Allowable Span @ 16" o.c. =	7.35	ft (bending )
		C <sub>i</sub> =	0.95	Incising (E)			
Calculations:		spacing (in)	8.00	12.00	16.00	Control	% over allowed
Lv <sub>allow</sub> = {[A*F <sub>v</sub> *C <sub>D</sub> /(1.5*w)]+d}*2		Lv (ft) =	34.70	23.44	17.81	Shear	1.00%
Lb <sub>allow</sub> =(S*F <sub>b</sub> *C <sub>D</sub> *Cr*C <sub>F</sub> *C <sub>i</sub> *8/w) <sup>1/2</sup>		Lb (ft) =	10.39	8.49	7.35	Bending	4.00%
Ld <sub>allow</sub> =[384*E*C <sub>i</sub> *I/(5*LL*360)] <sup>1/3</sup>		Ld (ft) =	9.83	8.59	7.81	LL Deflection	360
Ld <sub>allow</sub> =[384*E*C <sub>i</sub> *I/(5*TL*240)] <sup>1/3</sup>		Ld (ft) =	10.50	9.17	8.33	TL Deflection	240
			LL Defl.	bending	bending		

2 x 8		Pressure Treated Incising	Hem Fir	#2			
2 x 8	▼	A =	10.88	in <sup>2</sup>	Live	60.00	psf
Hem Fir	▼	S =	13.14	in <sup>3</sup>	Dead	14.00	psf
#2	▼	I =	47.63	in <sup>4</sup>	Partition	-	psf
Incising? Yes	▼	C <sub>F</sub> =	1.20		Total	74.00	psf
Wet Use? No	▼	F <sub>b</sub> =	850.00	psi			
		F <sub>v</sub> =	150.00	psi	Allowable Span @ 8" o.c. =	12.96	ft (LL Defl. )
		E =	1,300,000.00	psi	Allowable Span @ 12" o.c. =	10.75	ft (bending )
		C <sub>i</sub> =	0.80	Incising (Fb)	Allowable Span @ 16" o.c. =	9.31	ft (bending )
		C <sub>i</sub> =	0.95	Incising (E)			
Calculations:		spacing (in)	8.00	12.00	16.00	Control	% over allowed
Lv <sub>allow</sub> = {[A*F <sub>v</sub> *C <sub>D</sub> /(1.5*w)]+d}*2		Lv (ft) =	45.74	30.89	23.47	Shear	1.00%
Lb <sub>allow</sub> =(S*F <sub>b</sub> *C <sub>D</sub> *Cr*C <sub>F</sub> *C <sub>i</sub> *8/w) <sup>1/2</sup>		Lb (ft) =	13.16	10.75	9.31	Bending	4.00%
Ld <sub>allow</sub> =[384*E*C <sub>i</sub> *I/(5*LL*360)] <sup>1/3</sup>		Ld (ft) =	12.96	11.33	10.29	LL Deflection	360
Ld <sub>allow</sub> =[384*E*C <sub>i</sub> *I/(5*TL*240)] <sup>1/3</sup>		Ld (ft) =	13.84	12.09	10.98	TL Deflection	240
			LL Defl.	bending	bending		

2 x 10		Pressure Treated Incising	Hem Fir	#2			
2 x 10	▼	A =	13.88	in <sup>2</sup>	Live	60.00	psf
Hem Fir	▼	S =	21.39	in <sup>3</sup>	Dead	14.00	psf
#2	▼	I =	98.93	in <sup>4</sup>	Partition	-	psf
Incising? Yes	▼	C <sub>F</sub> =	1.10		Total	74.00	psf
Wet Use? No	▼	F <sub>b</sub> =	850.00	psi			
		F <sub>v</sub> =	150.00	psi	Allowable Span @ 8" o.c. =	16.08	ft (bending )
		E =	1,300,000.00	psi	Allowable Span @ 12" o.c. =	13.13	ft (bending )
		C <sub>i</sub> =	0.80	Incising (Fb)	Allowable Span @ 16" o.c. =	11.37	ft (bending )
		C <sub>i</sub> =	0.95	Incising (E)			
Calculations:		spacing (in)	8.00	12.00	16.00	Control	% over allowed
Lv <sub>allow</sub> = {[A*F <sub>v</sub> *C <sub>D</sub> /(1.5*w)]+d}*2		Lv (ft) =	58.35	39.42	29.95	Shear	1.00%
Lb <sub>allow</sub> =(S*F <sub>b</sub> *C <sub>D</sub> *Cr*C <sub>F</sub> *C <sub>i</sub> *8/w) <sup>1/2</sup>		Lb (ft) =	16.08	13.13	11.37	Bending	4.00%
Ld <sub>allow</sub> =[384*E*C <sub>i</sub> *I/(5*LL*360)] <sup>1/3</sup>		Ld (ft) =	16.54	14.45	13.13	LL Deflection	360
Ld <sub>allow</sub> =[384*E*C <sub>i</sub> *I/(5*TL*240)] <sup>1/3</sup>		Ld (ft) =	17.66	15.42	14.01	TL Deflection	240
			bending	bending	bending		

# SOLUTIONS **4** STRUCTURES

Inc.

Job #: 21.011  
 Designed: OGK  
 Date: 6/1/23

## FLOOR FRAMING

2018 NDS/2018 IBC

$C_r$ =	1.15	repetitive
$C_D$ =	<b>1.0</b>	<b>LIVE</b>
$C_F$ =	(varies)	size

2 x 6		Pressure Treated Incising	Hem Fir	#2			
2 x 6	▼	A =	8.25	in <sup>2</sup>	Live	100.00	psf
Hem Fir	▼	S =	7.56	in <sup>3</sup>	Dead	47.00	psf
#2	▼	l =	20.80	in <sup>4</sup>	Partition	-	psf
Incising? Yes	▼	$C_F$ =	1.30		Total	147.00	psf
Wet Use? No	▼	$F_b$ =	850.00	psi			
		$F_v$ =	150.00	psi	Allowable Span @ 8" o.c. =	7.38	ft (bending)
		E =	1,300,000.00	psi	Allowable Span @ 12" o.c. =	6.02	ft (bending)
		$C_i$ =	0.80	Incising (Fb)	Allowable Span @ 16" o.c. =	5.21	ft (bending)
		$C_i$ =	0.95	Incising (E)			
Calculations:		spacing (in)	8.00	12.00	16.00	Control	% over allowed
$L_{v\text{allow}} = \{[A \cdot F_v \cdot C_D / (1.5 \cdot w)] + d\} \cdot 2$		Lv (ft) =	17.92	12.25	9.42	Shear	1.00%
$L_{b\text{allow}} = (S \cdot F_b \cdot C_D \cdot C_r \cdot C_f \cdot C_i \cdot 8/w)^{1/2}$		Lb (ft) =	7.38	6.02	5.21	Bending	4.00%
$L_{d\text{allow}} = [384 \cdot E \cdot C_i \cdot l / (5 \cdot LL \cdot 360)]^{1/3}$		Ld (ft) =	8.30	7.25	6.58	LL Deflection	360
$L_{d\text{allow}} = [384 \cdot E \cdot C_i \cdot l / (5 \cdot TL \cdot 240)]^{1/3}$		Ld (ft) =	8.35	7.30	6.63	TL Deflection	240
			bending	bending	bending		

2 x 8		Pressure Treated Incising	Hem Fir	#2			
2 x 8	▼	A =	10.88	in <sup>2</sup>	Live	100.00	psf
Hem Fir	▼	S =	13.14	in <sup>3</sup>	Dead	47.00	psf
#2	▼	l =	47.63	in <sup>4</sup>	Partition	-	psf
Incising? Yes	▼	$C_F$ =	1.20		Total	147.00	psf
Wet Use? No	▼	$F_b$ =	850.00	psi			
		$F_v$ =	150.00	psi	Allowable Span @ 8" o.c. =	9.34	ft (bending)
		E =	1,300,000.00	psi	Allowable Span @ 12" o.c. =	7.63	ft (bending)
		$C_i$ =	0.80	Incising (Fb)	Allowable Span @ 16" o.c. =	6.60	ft (bending)
		$C_i$ =	0.95	Incising (E)			
Calculations:		spacing (in)	8.00	12.00	16.00	Control	% over allowed
$L_{v\text{allow}} = \{[A \cdot F_v \cdot C_D / (1.5 \cdot w)] + d\} \cdot 2$		Lv (ft) =	23.62	16.15	12.42	Shear	1.00%
$L_{b\text{allow}} = (S \cdot F_b \cdot C_D \cdot C_r \cdot C_f \cdot C_i \cdot 8/w)^{1/2}$		Lb (ft) =	9.34	7.63	6.60	Bending	4.00%
$L_{d\text{allow}} = [384 \cdot E \cdot C_i \cdot l / (5 \cdot LL \cdot 360)]^{1/3}$		Ld (ft) =	10.93	9.55	8.68	LL Deflection	360
$L_{d\text{allow}} = [384 \cdot E \cdot C_i \cdot l / (5 \cdot TL \cdot 240)]^{1/3}$		Ld (ft) =	11.01	9.62	8.74	TL Deflection	240
			bending	bending	bending		

2 x 10		Pressure Treated Incising	Hem Fir	#2			
2 x 10	▼	A =	13.88	in <sup>2</sup>	Live	100.00	psf
Hem Fir	▼	S =	21.39	in <sup>3</sup>	Dead	47.00	psf
#2	▼	l =	98.93	in <sup>4</sup>	Partition	-	psf
Incising? Yes	▼	$C_F$ =	1.10		Total	147.00	psf
Wet Use? No	▼	$F_b$ =	850.00	psi			
		$F_v$ =	150.00	psi	Allowable Span @ 8" o.c. =	11.41	ft (bending)
		E =	1,300,000.00	psi	Allowable Span @ 12" o.c. =	9.32	ft (bending)
		$C_i$ =	0.80	Incising (Fb)	Allowable Span @ 16" o.c. =	8.07	ft (bending)
		$C_i$ =	0.95	Incising (E)			
Calculations:		spacing (in)	8.00	12.00	16.00	Control	% over allowed
$L_{v\text{allow}} = \{[A \cdot F_v \cdot C_D / (1.5 \cdot w)] + d\} \cdot 2$		Lv (ft) =	30.14	20.61	15.84	Shear	1.00%
$L_{b\text{allow}} = (S \cdot F_b \cdot C_D \cdot C_r \cdot C_f \cdot C_i \cdot 8/w)^{1/2}$		Lb (ft) =	11.41	9.32	8.07	Bending	4.00%
$L_{d\text{allow}} = [384 \cdot E \cdot C_i \cdot l / (5 \cdot LL \cdot 360)]^{1/3}$		Ld (ft) =	13.95	12.19	11.07	LL Deflection	360
$L_{d\text{allow}} = [384 \cdot E \cdot C_i \cdot l / (5 \cdot TL \cdot 240)]^{1/3}$		Ld (ft) =	14.04	12.27	11.15	TL Deflection	240
			bending	bending	bending		

# SOLUTIONS 4 STRUCTURES INC.

## LOADS ONLY

**FB1** PT 4 x 10

$L = 8.00 \text{ ft}$

$$R_1 = \begin{matrix} \text{DL} \\ \text{LL} \end{matrix} \begin{pmatrix} 0.32 \\ 0.76 \end{pmatrix} \quad R_2 = \begin{pmatrix} 0.32 \\ 0.76 \end{pmatrix}$$

$$\Sigma \quad \quad \quad \Sigma \quad \quad \quad \Sigma \quad \quad \quad \Sigma$$

$$\begin{matrix} 1.08 \\ \text{k} \end{matrix} \quad \quad \quad \begin{matrix} 1.08 \\ \text{k} \end{matrix}$$

$$W_1 = \begin{matrix} \text{Deck} \\ \text{PSF Tributary} \\ \text{LL} \end{matrix} \begin{pmatrix} 25 \\ 60 \end{pmatrix} \begin{pmatrix} 3.2 \\ 3.2 \end{pmatrix} + \begin{matrix} \text{DL} \\ \text{Wall} \end{matrix} \begin{pmatrix} 0 \\ \end{pmatrix} + \begin{matrix} \text{Floor} \\ \text{PSF Tributary} \\ \text{LL} \end{matrix} \begin{pmatrix} 26 \\ 40 \end{pmatrix} \begin{pmatrix} 0.0 \\ 0.0 \end{pmatrix} = \begin{matrix} \text{DL} \\ \text{LL} \\ \Sigma \end{matrix} \begin{pmatrix} 79 \\ 190 \\ 269 \end{pmatrix}$$

**FB2** 4 x 8

$L = 5.00 \text{ ft}$

$$R_1 = \begin{matrix} \text{DL} \\ \text{LL} \end{matrix} \begin{pmatrix} 0.34 \\ 0.54 \end{pmatrix} \quad R_2 = \begin{pmatrix} 0.34 \\ 0.54 \end{pmatrix}$$

$$\Sigma \quad \quad \quad \Sigma \quad \quad \quad \Sigma \quad \quad \quad \Sigma$$

$$\begin{matrix} 0.88 \\ \text{k} \end{matrix} \quad \quad \quad \begin{matrix} 0.88 \\ \text{k} \end{matrix}$$

$$W_1 = \begin{matrix} \text{Deck} \\ \text{PSF Tributary} \\ \text{LL} \end{matrix} \begin{pmatrix} 25 \\ 60 \end{pmatrix} \begin{pmatrix} 3.2 \\ 3.2 \end{pmatrix} + \begin{matrix} \text{DL} \\ \text{Wall} \end{matrix} \begin{pmatrix} 40 \\ \end{pmatrix} + \begin{matrix} \text{Floor} \\ \text{PSF Tributary} \\ \text{LL} \end{matrix} \begin{pmatrix} 26 \\ 40 \end{pmatrix} \begin{pmatrix} 0.7 \\ 0.7 \end{pmatrix} = \begin{matrix} \text{DL} \\ \text{SL} \\ \Sigma \end{matrix} \begin{pmatrix} 136 \\ 217 \\ 353 \end{pmatrix}$$

**FB3** 4 x 8

$L = 3.00 \text{ ft}$

$$R_1 = \begin{matrix} \text{DL} \\ \text{LL} \end{matrix} \begin{pmatrix} 0.33 \\ 0.43 \end{pmatrix} \quad R_2 = \begin{pmatrix} 0.33 \\ 0.43 \end{pmatrix}$$

$$\Sigma \quad \quad \quad \Sigma \quad \quad \quad \Sigma \quad \quad \quad \Sigma$$

$$\begin{matrix} 0.76 \\ \text{k} \end{matrix} \quad \quad \quad \begin{matrix} 0.76 \\ \text{k} \end{matrix}$$

$$W_1 = \begin{matrix} \text{Floor} \\ \text{PSF Tributary} \\ \text{LL} \end{matrix} \begin{pmatrix} 26 \\ 40 \end{pmatrix} \begin{pmatrix} 6.3 \\ 6.3 \end{pmatrix} + \begin{matrix} \text{DL} \\ \text{Wall} \end{matrix} \begin{pmatrix} 40 \\ \end{pmatrix} + \begin{matrix} \text{Deck} \\ \text{PSF Tributary} \\ \text{LL} \end{matrix} \begin{pmatrix} 25 \\ 60 \end{pmatrix} \begin{pmatrix} 0.7 \\ 0.7 \end{pmatrix} = \begin{matrix} \text{DL} \\ \text{LL} \\ \Sigma \end{matrix} \begin{pmatrix} 219 \\ 290 \\ 509 \end{pmatrix}$$

**FB4** 4 x 8

$L = 2.00 \text{ ft}$

$$R_1 = \begin{matrix} \text{DL} \\ \text{LL} \end{matrix} \begin{pmatrix} 0.21 \\ 0.26 \end{pmatrix} \quad R_2 = \begin{pmatrix} 0.21 \\ 0.26 \end{pmatrix}$$

$$\Sigma \quad \quad \quad \Sigma \quad \quad \quad \Sigma \quad \quad \quad \Sigma$$

$$\begin{matrix} 0.47 \\ \text{k} \end{matrix} \quad \quad \quad \begin{matrix} 0.47 \\ \text{k} \end{matrix}$$

$$W_1 = \begin{matrix} \text{Floor} \\ \text{PSF Tributary} \\ \text{LL} \end{matrix} \begin{pmatrix} 26 \\ 40 \end{pmatrix} \begin{pmatrix} 6.5 \\ 6.5 \end{pmatrix} + \begin{matrix} \text{DL} \\ \text{Wall} \end{matrix} \begin{pmatrix} 40 \\ \end{pmatrix} + \begin{matrix} \text{Floor} \\ \text{PSF Tributary} \\ \text{LL} \end{matrix} \begin{pmatrix} 26 \\ 40 \end{pmatrix} \begin{pmatrix} 0.0 \\ 0.0 \end{pmatrix} = \begin{matrix} \text{DL} \\ \text{SL} \\ \Sigma \end{matrix} \begin{pmatrix} 209 \\ 260 \\ 469 \end{pmatrix}$$

**FB5** 4 x 8

$L = 3.00 \text{ ft}$

$$R_1 = \begin{matrix} \text{DL} \\ \text{LL} \end{matrix} \begin{pmatrix} 0.51 \\ 0.78 \end{pmatrix} \quad R_2 = \begin{pmatrix} 0.51 \\ 0.78 \end{pmatrix}$$

$$\Sigma \quad \quad \quad \Sigma \quad \quad \quad \Sigma \quad \quad \quad \Sigma$$

$$\begin{matrix} 1.29 \\ \text{k} \end{matrix} \quad \quad \quad \begin{matrix} 1.29 \\ \text{k} \end{matrix}$$

$$W_1 = \begin{matrix} \text{Floor} \\ \text{PSF Tributary} \\ \text{LL} \end{matrix} \begin{pmatrix} 26 \\ 40 \end{pmatrix} \begin{pmatrix} 13.0 \\ 13.0 \end{pmatrix} + \begin{matrix} \text{DL} \\ \text{Wall} \end{matrix} \begin{pmatrix} 0 \\ \end{pmatrix} + \begin{matrix} \text{Floor} \\ \text{PSF Tributary} \\ \text{LL} \end{matrix} \begin{pmatrix} 26 \\ 40 \end{pmatrix} \begin{pmatrix} 0.0 \\ 0.0 \end{pmatrix} = \begin{matrix} \text{DL} \\ \text{LL} \\ \Sigma \end{matrix} \begin{pmatrix} 338 \\ 520 \\ 858 \end{pmatrix}$$

**FB6** 4 x 10

$L = 6.00 \text{ ft}$

$$R_1 = \begin{matrix} \text{DL} \\ \text{LL} \end{matrix} \begin{pmatrix} 1.01 \\ 1.56 \end{pmatrix} \quad R_2 = \begin{pmatrix} 1.01 \\ 1.56 \end{pmatrix}$$

$$\Sigma \quad \quad \quad \Sigma \quad \quad \quad \Sigma \quad \quad \quad \Sigma$$

$$\begin{matrix} 2.57 \\ \text{k} \end{matrix} \quad \quad \quad \begin{matrix} 2.57 \\ \text{k} \end{matrix}$$

$$W_1 = \begin{matrix} \text{Floor} \\ \text{PSF Tributary} \\ \text{LL} \end{matrix} \begin{pmatrix} 26 \\ 40 \end{pmatrix} \begin{pmatrix} 13.0 \\ 13.0 \end{pmatrix} + \begin{matrix} \text{DL} \\ \text{Wall} \end{matrix} \begin{pmatrix} 0 \\ \end{pmatrix} + \begin{matrix} \text{Floor} \\ \text{PSF Tributary} \\ \text{LL} \end{matrix} \begin{pmatrix} 26 \\ 40 \end{pmatrix} \begin{pmatrix} 0.0 \\ 0.0 \end{pmatrix} = \begin{matrix} \text{DL} \\ \text{SL} \\ \Sigma \end{matrix} \begin{pmatrix} 338 \\ 520 \\ 858 \end{pmatrix}$$

# SOLUTIONS 4 STRUCTURES INC.

## LOADS ONLY

**FB7**      4 x 8

$L = 3.00 \text{ ft}$

$$R_1 = \begin{matrix} \text{DL} \\ \text{LL} \end{matrix} \begin{pmatrix} 0.37 \\ 0.50 \end{pmatrix} \quad R_2 = \begin{pmatrix} 0.37 \\ 0.50 \end{pmatrix}$$

$$\frac{\Sigma}{\Sigma} \quad \begin{matrix} 0.88 \\ 0.88 \end{matrix} \text{ k}$$

$$W_1 = \begin{matrix} \text{Floor} \\ \text{PSF Tributary} \\ \text{LL} \end{matrix} \begin{pmatrix} 26 \\ 6.8 \\ 40 \end{pmatrix} + \begin{matrix} \text{DL} \\ \text{Wall} \end{matrix} \begin{pmatrix} 40 \end{pmatrix} + \begin{matrix} \text{Floor} \\ \text{PSF Tributary} \\ \text{LL} \end{matrix} \begin{pmatrix} 47 \\ 0.7 \\ 100 \end{pmatrix} = \begin{matrix} \text{DL} \\ \text{SL} \\ \Sigma \end{matrix} \begin{pmatrix} 247 \\ 337 \\ 583 \end{pmatrix}$$

**FB8**      PT 6 x 10 HF1

$L = 10.00 \text{ ft}$

$$R_1 = \begin{matrix} \text{DL} \\ \text{LL} \end{matrix} \begin{pmatrix} 0.44 \\ 1.05 \end{pmatrix} \quad R_2 = \begin{pmatrix} 0.44 \\ 1.05 \end{pmatrix}$$

$$\frac{\Sigma}{\Sigma} \quad \begin{matrix} 1.49 \\ 1.49 \end{matrix} \text{ k}$$

$$W_1 = \begin{matrix} \text{Deck} \\ \text{PSF Tributary} \\ \text{LL} \end{matrix} \begin{pmatrix} 25 \\ 3.5 \\ 60 \end{pmatrix} + \begin{matrix} \text{DL} \\ \text{Wall} \end{matrix} \begin{pmatrix} 0 \end{pmatrix} + \begin{matrix} \text{Floor} \\ \text{PSF Tributary} \\ \text{LL} \end{matrix} \begin{pmatrix} 0 \\ 0.0 \\ 0 \end{pmatrix} = \begin{matrix} \text{DL} \\ \text{LL} \\ \Sigma \end{matrix} \begin{pmatrix} 88 \\ 210 \\ 298 \end{pmatrix}$$

**FB9**      4 x 8

$L = 3.00 \text{ ft}$

$$R_1 = \begin{matrix} \text{DL} \\ \text{LL} \end{matrix} \begin{pmatrix} 0.34 \\ 0.53 \end{pmatrix} \quad R_2 = \begin{pmatrix} 0.34 \\ 0.53 \end{pmatrix}$$

$$\frac{\Sigma}{\Sigma} \quad \begin{matrix} 0.87 \\ 0.87 \end{matrix} \text{ k}$$

$$W_1 = \begin{matrix} \text{Floor} \\ \text{PSF Tributary} \\ \text{LL} \end{matrix} \begin{pmatrix} 26 \\ 8.2 \\ 40 \end{pmatrix} + \begin{matrix} \text{DL} \\ \text{Wall} \end{matrix} \begin{pmatrix} 0 \end{pmatrix} + \begin{matrix} \text{Floor} \\ \text{PSF Tributary} \\ \text{LL} \end{matrix} \begin{pmatrix} 26 \\ 0.7 \\ 40 \end{pmatrix} = \begin{matrix} \text{DL} \\ \text{SL} \\ \Sigma \end{matrix} \begin{pmatrix} 230 \\ 353 \\ 583 \end{pmatrix}$$

**FB10**      4 x 8

$L = 6.00 \text{ ft}$

$$R_1 = \begin{matrix} \text{DL} \\ \text{LL} \end{matrix} \begin{pmatrix} 0.59 \\ 0.91 \end{pmatrix} \quad R_2 = \begin{pmatrix} 0.59 \\ 0.91 \end{pmatrix}$$

$$\frac{\Sigma}{\Sigma} \quad \begin{matrix} 1.50 \\ 1.50 \end{matrix} \text{ k}$$

$$W_1 = \begin{matrix} \text{Floor} \\ \text{PSF Tributary} \\ \text{LL} \end{matrix} \begin{pmatrix} 26 \\ 6.9 \\ 40 \end{pmatrix} + \begin{matrix} \text{DL} \\ \text{Wall} \end{matrix} \begin{pmatrix} 0 \end{pmatrix} + \begin{matrix} \text{Floor} \\ \text{PSF Tributary} \\ \text{LL} \end{matrix} \begin{pmatrix} 26 \\ 0.7 \\ 40 \end{pmatrix} = \begin{matrix} \text{DL} \\ \text{SL} \\ \Sigma \end{matrix} \begin{pmatrix} 197 \\ 303 \\ 501 \end{pmatrix}$$

**FB11**      4 x 8

$L = 5.00 \text{ ft}$

$$R_1 = \begin{matrix} \text{DL} \\ \text{LL} \end{matrix} \begin{pmatrix} 0.58 \\ 1.08 \end{pmatrix} \quad R_2 = \begin{pmatrix} 0.58 \\ 1.08 \end{pmatrix}$$

$$\frac{\Sigma}{\Sigma} \quad \begin{matrix} 1.65 \\ 1.65 \end{matrix} \text{ k}$$

$$W_1 = \begin{matrix} \text{Deck} \\ \text{PSF Tributary} \\ \text{LL} \end{matrix} \begin{pmatrix} 25 \\ 3.5 \\ 60 \end{pmatrix} + \begin{matrix} \text{DL} \\ \text{Wall} \end{matrix} \begin{pmatrix} 0 \end{pmatrix} + \begin{matrix} \text{Floor} \\ \text{PSF Tributary} \\ \text{LL} \end{matrix} \begin{pmatrix} 26 \\ 5.5 \\ 40 \end{pmatrix} = \begin{matrix} \text{DL} \\ \text{LL} \\ \Sigma \end{matrix} \begin{pmatrix} 231 \\ 430 \\ 661 \end{pmatrix}$$

**FB12**      4 x 10

$L = 6.00 \text{ ft}$

$$R_1 = \begin{matrix} \text{DL} \\ \text{LL} \end{matrix} \begin{pmatrix} 0.76 \\ 1.17 \end{pmatrix} \quad R_2 = \begin{pmatrix} 0.76 \\ 1.17 \end{pmatrix}$$

$$\frac{\Sigma}{\Sigma} \quad \begin{matrix} 1.93 \\ 1.93 \end{matrix} \text{ k}$$

$$W_1 = \begin{matrix} \text{Floor} \\ \text{PSF Tributary} \\ \text{LL} \end{matrix} \begin{pmatrix} 26 \\ 9.8 \\ 40 \end{pmatrix} + \begin{matrix} \text{DL} \\ \text{Wall} \end{matrix} \begin{pmatrix} 0 \end{pmatrix} + \begin{matrix} \text{Floor} \\ \text{PSF Tributary} \\ \text{LL} \end{matrix} \begin{pmatrix} 26 \\ 0.0 \\ 40 \end{pmatrix} = \begin{matrix} \text{DL} \\ \text{SL} \\ \Sigma \end{matrix} \begin{pmatrix} 254 \\ 390 \\ 644 \end{pmatrix}$$

# SOLUTIONS 4 STRUCTURES INC.

## LOADS ONLY

**FB13**      4 x 10

$L = 6.00 \text{ ft}$

$$R_1 = \begin{matrix} \text{DL} \\ \text{LL} \end{matrix} \begin{pmatrix} 0.60 \\ 0.93 \end{pmatrix} \quad R_2 = \begin{pmatrix} 0.60 \\ 0.93 \end{pmatrix}$$

$$\Sigma \quad 1.53 \text{ k} \quad \Sigma \quad 1.53 \text{ k}$$

$$W_1 = \begin{matrix} \text{Floor} \\ \text{PSF Tributary} \\ \text{LL} \end{matrix} \begin{pmatrix} 26 \\ 40 \end{pmatrix} \begin{pmatrix} 7.8 \\ 7.8 \end{pmatrix} + \begin{matrix} \text{DL} \\ \text{Wall} \end{matrix} \begin{pmatrix} 0 \\ \end{pmatrix} + \begin{matrix} \text{Floor} \\ \text{PSF Tributary} \\ \text{LL} \end{matrix} \begin{pmatrix} 26 \\ 40 \end{pmatrix} \begin{pmatrix} 0.0 \\ 0.0 \end{pmatrix} = \begin{matrix} \text{DL} \\ \text{SL} \\ \Sigma \end{matrix} \begin{pmatrix} 202 \\ 310 \\ 512 \end{pmatrix}$$

**FB14**      4 x 8

$L = 5.00 \text{ ft}$

$$R_1 = \begin{matrix} \text{DL} \\ \text{LL} \end{matrix} \begin{pmatrix} 0.36 \\ 0.55 \end{pmatrix} \quad R_2 = \begin{pmatrix} 0.36 \\ 0.55 \end{pmatrix}$$

$$\Sigma \quad 0.91 \text{ k} \quad \Sigma \quad 0.91 \text{ k}$$

$$W_1 = \begin{matrix} \text{Floor} \\ \text{PSF Tributary} \\ \text{LL} \end{matrix} \begin{pmatrix} 26 \\ 40 \end{pmatrix} \begin{pmatrix} 5.5 \\ 5.5 \end{pmatrix} + \begin{matrix} \text{DL} \\ \text{Wall} \end{matrix} \begin{pmatrix} 0 \\ \end{pmatrix} + \begin{matrix} \text{Floor} \\ \text{PSF Tributary} \\ \text{LL} \end{matrix} \begin{pmatrix} 26 \\ 40 \end{pmatrix} \begin{pmatrix} 0.0 \\ 0.0 \end{pmatrix} = \begin{matrix} \text{DL} \\ \text{SL} \\ \Sigma \end{matrix} \begin{pmatrix} 143 \\ 220 \\ 363 \end{pmatrix}$$

**FB15**      4 x 8

$L = 3.00 \text{ ft}$

$$R_1 = \begin{matrix} \text{DL} \\ \text{LL} \end{matrix} \begin{pmatrix} 0.22 \\ 0.37 \end{pmatrix} \quad R_2 = \begin{pmatrix} 0.22 \\ 0.37 \end{pmatrix}$$

$$\Sigma \quad 0.59 \text{ k} \quad \Sigma \quad 0.59 \text{ k}$$

$$W_1 = \begin{matrix} \text{Floor} \\ \text{PSF Tributary} \\ \text{LL} \end{matrix} \begin{pmatrix} 26 \\ 40 \end{pmatrix} \begin{pmatrix} 4.5 \\ 4.5 \end{pmatrix} + \begin{matrix} \text{DL} \\ \text{Wall} \end{matrix} \begin{pmatrix} 0 \\ \end{pmatrix} + \begin{matrix} \text{Stair} \\ \text{PSF Tributary} \\ \text{LL} \end{matrix} \begin{pmatrix} 47 \\ 100 \end{pmatrix} \begin{pmatrix} 0.7 \\ 0.7 \end{pmatrix} = \begin{matrix} \text{DL} \\ \text{SL} \\ \Sigma \end{matrix} \begin{pmatrix} 148 \\ 247 \\ 395 \end{pmatrix}$$

**FB16**      4 x 8

$L = 4.50 \text{ ft}$

$$R_1 = \begin{matrix} \text{DL} \\ \text{LL} \end{matrix} \begin{pmatrix} 0.70 \\ 1.08 \end{pmatrix} \quad R_2 = \begin{pmatrix} 0.70 \\ 1.08 \end{pmatrix}$$

$$\Sigma \quad 1.78 \text{ k} \quad \Sigma \quad 1.78 \text{ k}$$

$$W_1 = \begin{matrix} \text{Floor} \\ \text{PSF Tributary} \\ \text{LL} \end{matrix} \begin{pmatrix} 26 \\ 40 \end{pmatrix} \begin{pmatrix} 12.0 \\ 12.0 \end{pmatrix} + \begin{matrix} \text{DL} \\ \text{Wall} \end{matrix} \begin{pmatrix} 0 \\ \end{pmatrix} + \begin{matrix} \text{Floor} \\ \text{PSF Tributary} \\ \text{LL} \end{matrix} \begin{pmatrix} 26 \\ 40 \end{pmatrix} \begin{pmatrix} 0.0 \\ 0.0 \end{pmatrix} = \begin{matrix} \text{DL} \\ \text{SL} \\ \Sigma \end{matrix} \begin{pmatrix} 312 \\ 480 \\ 792 \end{pmatrix}$$

**FB17**      See Hand Drawn Diagram

**FB18**      PT 6 x 10 HF 1

$L = 11.00 \text{ ft}$

$$R_1 = \begin{matrix} \text{DL} \\ \text{LL} \end{matrix} \begin{pmatrix} 0.44 \\ 1.04 \end{pmatrix} \quad R_2 = \begin{pmatrix} 0.44 \\ 1.04 \end{pmatrix}$$

$$\Sigma \quad 1.48 \text{ k} \quad \Sigma \quad 1.48 \text{ k}$$

$$W_1 = \begin{matrix} \text{Deck} \\ \text{PSF Tributary} \\ \text{LL} \end{matrix} \begin{pmatrix} 25 \\ 60 \end{pmatrix} \begin{pmatrix} 3.2 \\ 3.2 \end{pmatrix} + \begin{matrix} \text{DL} \\ \text{Wall} \end{matrix} \begin{pmatrix} 0 \\ \end{pmatrix} + \begin{matrix} \text{Floor} \\ \text{PSF Tributary} \\ \text{LL} \end{matrix} \begin{pmatrix} 26 \\ 40 \end{pmatrix} \begin{pmatrix} 0.0 \\ 0.0 \end{pmatrix} = \begin{matrix} \text{DL} \\ \text{SL} \\ \Sigma \end{matrix} \begin{pmatrix} 79 \\ 190 \\ 269 \end{pmatrix}$$

# SOLUTIONS 4 STRUCTURES Inc.

## LOADS ONLY

**FB19** PT 5-1/8 x 10.5 GLB

$$R_1 = \begin{matrix} \text{DL} \\ \text{LL} \end{matrix} \begin{pmatrix} 1.59 \\ 3.38 \end{pmatrix} \quad \Sigma \quad 4.96 \text{ k}$$

$$R_2 = \begin{pmatrix} 1.59 \\ 3.38 \end{pmatrix} \quad \Sigma \quad 4.96 \text{ k}$$

$$W_1 = \text{DL} \begin{pmatrix} 47 \\ 100 \end{pmatrix} \begin{matrix} \text{Stair} \\ \text{PSF Tributary} \end{matrix} \begin{pmatrix} 6.8 \\ 6.8 \end{pmatrix} + \text{DL} \begin{pmatrix} 0 \\ \text{Wall} \end{pmatrix} + \text{DL} \begin{pmatrix} 47 \\ 100 \end{pmatrix} \begin{matrix} \text{Stair} \\ \text{PSF Tributary} \end{matrix} \begin{pmatrix} 0.0 \\ 0.0 \end{pmatrix} = \begin{matrix} \text{DL} \\ \text{SL} \\ \Sigma \end{matrix} \begin{pmatrix} 317 \\ 675 \\ 992 \end{pmatrix} \text{ PLF}$$

**FB20** PT 4 x 8

$$R_1 = \begin{matrix} \text{DL} \\ \text{LL} \end{matrix} \begin{pmatrix} 0.46 \\ 0.98 \end{pmatrix} \quad \Sigma \quad 1.44 \text{ k}$$

$$R_2 = \begin{pmatrix} 0.46 \\ 0.98 \end{pmatrix} \quad \Sigma \quad 1.44 \text{ k}$$

$$W_1 = \text{DL} \begin{pmatrix} 47 \\ 100 \end{pmatrix} \begin{matrix} \text{Stair} \\ \text{PSF Tributary} \end{matrix} \begin{pmatrix} 3.9 \\ 3.9 \end{pmatrix} + \text{DL} \begin{pmatrix} 0 \\ \text{Wall} \end{pmatrix} + \text{DL} \begin{pmatrix} 47 \\ 100 \end{pmatrix} \begin{matrix} \text{Stair} \\ \text{PSF Tributary} \end{matrix} \begin{pmatrix} 0.0 \\ 0.0 \end{pmatrix} = \begin{matrix} \text{DL} \\ \text{SL} \\ \Sigma \end{matrix} \begin{pmatrix} 184 \\ 392 \\ 576 \end{pmatrix} \text{ PLF}$$

**FB21** PT 3-1/8 x 10.5 GLB

$$R_1 = \begin{matrix} \text{DL} \\ \text{LL} \end{matrix} \begin{pmatrix} 1.26 \\ 1.63 \end{pmatrix} \quad \Sigma \quad 2.89 \text{ k}$$

$$R_2 = \begin{pmatrix} 1.26 \\ 1.63 \end{pmatrix} \quad \Sigma \quad 2.89 \text{ k}$$

$$W_1 = \text{DL} \begin{pmatrix} 47 \\ 100 \end{pmatrix} \begin{matrix} \text{Stair} \\ \text{PSF Tributary} \end{matrix} \begin{pmatrix} 3.3 \\ 3.3 \end{pmatrix} + \text{DL} \begin{pmatrix} 100 \\ \text{Wall} \end{pmatrix} + \text{DL} \begin{pmatrix} 47 \\ 100 \end{pmatrix} \begin{matrix} \text{Stair} \\ \text{PSF Tributary} \end{matrix} \begin{pmatrix} 0.0 \\ 0.0 \end{pmatrix} = \begin{matrix} \text{DL} \\ \text{SL} \\ \Sigma \end{matrix} \begin{pmatrix} 253 \\ 325 \\ 578 \end{pmatrix} \text{ PLF}$$

**FB22** PT 5-1/8 x 10.5 GLB

$$R_1 = \begin{matrix} \text{DL} \\ \text{LL} \end{matrix} \begin{pmatrix} 1.47 \\ 3.13 \end{pmatrix} \quad \Sigma \quad 4.59 \text{ k}$$

$$R_2 = \begin{pmatrix} 1.47 \\ 3.13 \end{pmatrix} \quad \Sigma \quad 4.59 \text{ k}$$

$$W_1 = \text{DL} \begin{pmatrix} 47 \\ 100 \end{pmatrix} \begin{matrix} \text{Stair} \\ \text{PSF Tributary} \end{matrix} \begin{pmatrix} 6.3 \\ 6.3 \end{pmatrix} + \text{DL} \begin{pmatrix} 0 \\ \text{Wall} \end{pmatrix} + \text{DL} \begin{pmatrix} 47 \\ 100 \end{pmatrix} \begin{matrix} \text{Stair} \\ \text{PSF Tributary} \end{matrix} \begin{pmatrix} 0.0 \\ 0.0 \end{pmatrix} = \begin{matrix} \text{DL} \\ \text{SL} \\ \Sigma \end{matrix} \begin{pmatrix} 294 \\ 625 \\ 919 \end{pmatrix} \text{ PLF}$$

**FB23** See Hand Drawn Diagram

**FB24** See Hand Drawn Diagram



# SOLUTIONS **4** STRUCTURES Inc.

JOB# 23.007

DESIGNED MRO DATE 5-29-23

PROJECT: BRADLEY HEIGHTS APTS

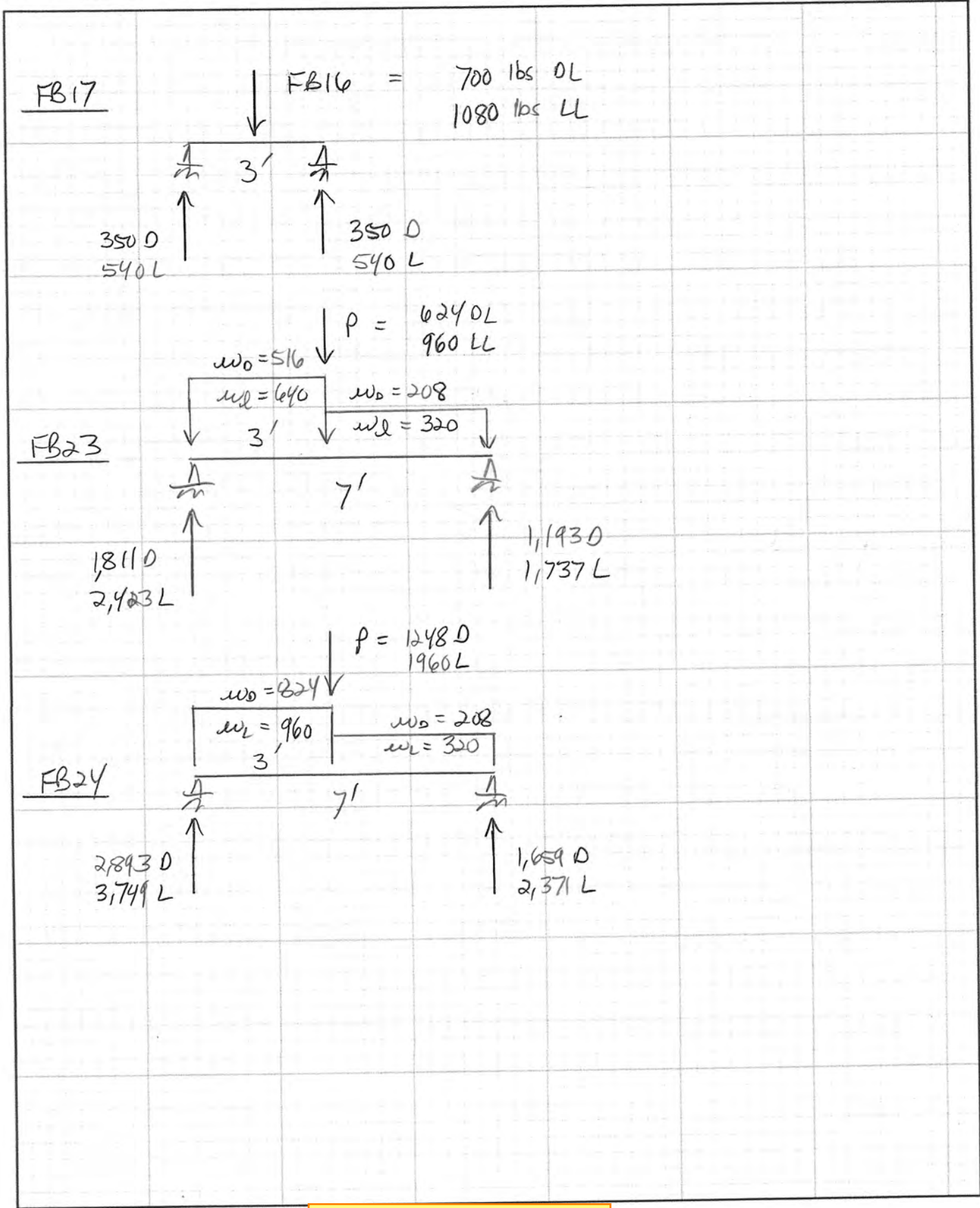

**Multiple Simple Beam**

Lic. #: KW-06013765

**Description :** Floor Beams FB1-FB12

**Wood Beam Design : FB1**

Calculations per NDS 2018, IBC 2018, CBC 2019, ASCE 7-16

BEAM Size : **4x10, Sawn, Fully Braced**

Using Allowable Stress Design with IBC 2018 Load Combinations, Major Axis Bending

Wood Species :	Hem-Fir		Wood Grade :	No.2		Density	26.840 pcf
Fb - Tension	850.0 psi	Fc - Prll	1,300.0 psi	Fv	150.0 psi	Ebend- xx	1,300.0 ksi
Fb - Compr	850.0 psi	Fc - Perp	405.0 psi	Ft	525.0 psi	Eminbend - xx	470.0 ksi

Applied Loads

Beam self weight calculated and added to loads  
 Unif Load: D = 0.0790, L = 0.190 k/ft, Trib= 1.0 ft

Design Summary

Max fb/Fb Ratio =	<b>0.648</b> : 1
fb : Actual :	529.00 psi at 4.000 ft in Span # 1
Fb : Allowable :	816.00 psi
Load Comb :	+D+L+H
Max fv/FvRatio =	<b>0.425</b> : 1
fv : Actual :	50.97 psi at 0.000 ft in Span # 1
Fv : Allowable :	120.00 psi
Load Comb :	+D+L+H

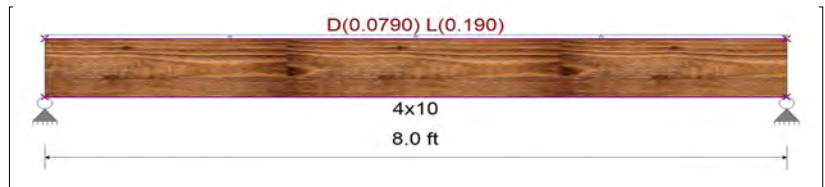

Max Reactions (k)	D	L	Lr	S	W	E	H
Left Support	0.34	0.76					
Right Support	0.34	0.76					

Max Deflections			
Transient Downward	0.059 in	Total Downward	0.085 in
Ratio	1636	Ratio	1130
	LC: L Only		LC: +D+L+H
Transient Upward	0.000 in	Total Upward	0.000 in
Ratio	9999	Ratio	9999
	LC:		LC:

**Wood Beam Design : FB2**

Calculations per NDS 2018, IBC 2018, CBC 2019, ASCE 7-16

BEAM Size : **4x8, Sawn, Fully Braced**

Using Allowable Stress Design with IBC 2018 Load Combinations, Major Axis Bending

Wood Species :	Hem-Fir		Wood Grade :	No.2		Density	26.840 pcf
Fb - Tension	850.0 psi	Fc - Prll	1,300.0 psi	Fv	150.0 psi	Ebend- xx	1,300.0 ksi
Fb - Compr	850.0 psi	Fc - Perp	405.0 psi	Ft	525.0 psi	Eminbend - xx	470.0 ksi

Applied Loads

Beam self weight calculated and added to loads  
 Unif Load: D = 0.1360, L = 0.2170 k/ft, Trib= 1.0 ft

Design Summary

Max fb/Fb Ratio =	<b>0.396</b> : 1
fb : Actual :	437.52 psi at 2.500 ft in Span # 1
Fb : Allowable :	1,105.00 psi
Load Comb :	+D+L+H
Max fv/FvRatio =	<b>0.352</b> : 1
fv : Actual :	52.87 psi at 0.000 ft in Span # 1
Fv : Allowable :	150.00 psi
Load Comb :	+D+L+H

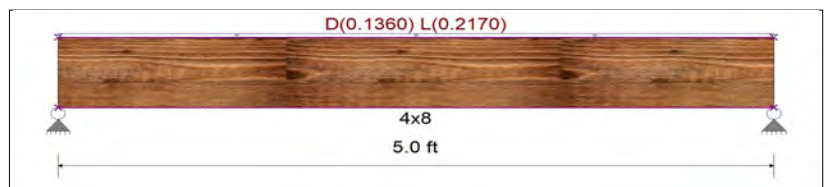

Max Reactions (k)	D	L	Lr	S	W	E	H
Left Support	0.35	0.54					
Right Support	0.35	0.54					

Max Deflections			
Transient Downward	0.021 in	Total Downward	0.035 in
Ratio	2825	Ratio	1714
	LC: L Only		LC: +D+L+H
Transient Upward	0.000 in	Total Upward	0.000 in
Ratio	9999	Ratio	9999
	LC:		LC:

**Multiple Simple Beam**

Lic. #: KW-06013765

**Wood Beam Design : FB3**

Calculations per NDS 2018, IBC 2018, CBC 2019, ASCE 7-16

BEAM Size : **4x8, Sawn, Fully Braced**

Using Allowable Stress Design with IBC 2018 Load Combinations, Major Axis Bending

Wood Species :	Hem-Fir		Wood Grade :	No.2		Density	26.840 pcf
Fb - Tension	850.0 psi	Fc - Prll	1,300.0 psi	Fv	150.0 psi	Ebend- xx	1,300.0 ksi
Fb - Compr	850.0 psi	Fc - Perp	405.0 psi	Ft	525.0 psi	Eminbend - xx	470.0 ksi

Applied Loads

Beam self weight calculated and added to loads  
 Unif Load: D = 0.2190, L = 0.290 k/ft, Trib= 1.0 ft

Design Summary

Max fb/Fb Ratio =	<b>0.205</b> : 1
fb : Actual :	226.19 psi at 1.500 ft in Span # 1
Fb : Allowable :	1,105.00 psi
Load Comb :	+D+L+H
Max fv/FvRatio =	<b>0.304</b> : 1
fv : Actual :	45.55 psi at 0.000 ft in Span # 1
Fv : Allowable :	150.00 psi
Load Comb :	+D+L+H



Max Reactions (k)	D	L	Lr	S	W	E	H
Left Support	0.34	0.44					
Right Support	0.34	0.44					

Max Deflections			
Transient Downward	0.004 in	Total Downward	0.007 in
Ratio	9789	Ratio	5526
	LC: L Only		LC: +D+L+H
Transient Upward	0.000 in	Total Upward	0.000 in
Ratio	9999	Ratio	9999
	LC:		LC:

**Wood Beam Design : FB4**

Calculations per NDS 2018, IBC 2018, CBC 2019, ASCE 7-16

BEAM Size : **4x8, Sawn, Fully Braced**

Using Allowable Stress Design with IBC 2018 Load Combinations, Major Axis Bending

Wood Species :	Hem-Fir		Wood Grade :	No.2		Density	26.840 pcf
Fb - Tension	850.0 psi	Fc - Prll	1,300.0 psi	Fv	150.0 psi	Ebend- xx	1,300.0 ksi
Fb - Compr	850.0 psi	Fc - Perp	405.0 psi	Ft	525.0 psi	Eminbend - xx	470.0 ksi

Applied Loads

Beam self weight calculated and added to loads  
 Unif Load: D = 0.2090, L = 0.260 k/ft, Trib= 1.0 ft

Design Summary

Max fb/Fb Ratio =	<b>0.084</b> : 1
fb : Actual :	92.70 psi at 1.000 ft in Span # 1
Fb : Allowable :	1,105.00 psi
Load Comb :	+D+L+H
Max fv/FvRatio =	<b>0.187</b> : 1
fv : Actual :	28.00 psi at 0.000 ft in Span # 1
Fv : Allowable :	150.00 psi
Load Comb :	+D+L+H



Max Reactions (k)	D	L	Lr	S	W	E	H
Left Support	0.21	0.26					
Right Support	0.21	0.26					

Max Deflections			
Transient Downward	0.001 in	Total Downward	0.001 in
Ratio	9999	Ratio	9999
	LC: L Only		LC: +D+L+H
Transient Upward	0.000 in	Total Upward	0.000 in
Ratio	9999	Ratio	9999
	LC:		LC:

**Multiple Simple Beam**

Lic. #: KW-06013765

**Wood Beam Design : FB5**

Calculations per NDS 2018, IBC 2018, CBC 2019, ASCE 7-16

BEAM Size : **4x8, Sawn, Fully Braced**

Using Allowable Stress Design with IBC 2018 Load Combinations, Major Axis Bending

Wood Species :	Hem-Fir		Wood Grade :	No.2		Density	26.840 pcf
Fb - Tension	850.0 psi	Fc - Prll	1,300.0 psi	Fv	150.0 psi	Ebend- xx	1,300.0 ksi
Fb - Compr	850.0 psi	Fc - Perp	405.0 psi	Ft	525.0 psi	Eminbend - xx	470.0 ksi

Applied Loads

Beam self weight calculated and added to loads  
 Unif Load: D = 0.3380, L = 0.520 k/ft, Trib= 1.0 ft

Design Summary

Max fb/Fb Ratio =	<b>0.344</b> : 1
fb : Actual :	379.85 psi at 1.500 ft in Span # 1
Fb : Allowable :	1,105.00 psi
Load Comb :	+D+L+H
Max fv/FvRatio =	<b>0.510</b> : 1
fv : Actual :	76.50 psi at 0.000 ft in Span # 1
Fv : Allowable :	150.00 psi
Load Comb :	+D+L+H



Max Reactions (k)	D	L	Lr	S	W	E	H
Left Support	0.51	0.78					
Right Support	0.51	0.78					

Max Deflections			
Transient Downward	0.007 in	Total Downward	0.011 in
Ratio	5459	Ratio	3290
	LC: L Only		LC: +D+L+H
Transient Upward	0.000 in	Total Upward	0.000 in
Ratio	9999	Ratio	9999
	LC:		LC:

**Wood Beam Design : FB6**

Calculations per NDS 2018, IBC 2018, CBC 2019, ASCE 7-16

BEAM Size : **4x10, Sawn, Fully Braced**

Using Allowable Stress Design with IBC 2018 Load Combinations, Major Axis Bending

Wood Species :	Hem-Fir		Wood Grade :	No.2		Density	26.840 pcf
Fb - Tension	850.0 psi	Fc - Prll	1,300.0 psi	Fv	150.0 psi	Ebend- xx	1,300.0 ksi
Fb - Compr	850.0 psi	Fc - Perp	405.0 psi	Ft	525.0 psi	Eminbend - xx	470.0 ksi

Applied Loads

Beam self weight calculated and added to loads  
 Unif Load: D = 0.3550, L = 0.5470 k/ft, Trib= 1.0 ft

Design Summary

Max fb/Fb Ratio =	<b>0.963</b> : 1
fb : Actual :	982.42 psi at 3.000 ft in Span # 1
Fb : Allowable :	1,020.00 psi
Load Comb :	+D+L+H
Max fv/FvRatio =	<b>0.841</b> : 1
fv : Actual :	126.21 psi at 6.000 ft in Span # 1
Fv : Allowable :	150.00 psi
Load Comb :	+D+L+H

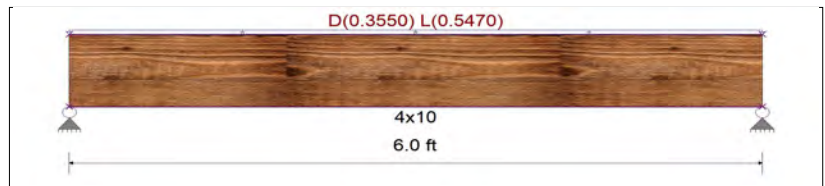

Max Reactions (k)	D	L	Lr	S	W	E	H
Left Support	1.08	1.64					
Right Support	1.08	1.64					

Max Deflections			
Transient Downward	0.053 in	Total Downward	0.089 in
Ratio	1347	Ratio	811
	LC: L Only		LC: +D+L+H
Transient Upward	0.000 in	Total Upward	0.000 in
Ratio	9999	Ratio	9999
	LC:		LC:

**Multiple Simple Beam**

Lic. #: KW-06013765

**Wood Beam Design : FB7**

Calculations per NDS 2018, IBC 2018, CBC 2019, ASCE 7-16

BEAM Size : **4x8, Sawn, Fully Braced**

Using Allowable Stress Design with IBC 2018 Load Combinations, Major Axis Bending

Wood Species :	Hem-Fir		Wood Grade :	No.2		Density	26.840 pcf
Fb - Tension	850.0 psi	Fc - Prll	1,300.0 psi	Fv	150.0 psi	Ebend- xx	1,300.0 ksi
Fb - Compr	850.0 psi	Fc - Perp	405.0 psi	Ft	525.0 psi	Eminbend - xx	470.0 ksi

Applied Loads

Beam self weight calculated and added to loads  
 Unif Load: D = 0.2470, L = 0.3370 k/ft, Trib= 1.0 ft

Design Summary

Max fb/Fb Ratio =	<b>0.235</b> : 1
fb : Actual :	259.21 psi at 1.500 ft in Span # 1
Fb : Allowable :	1,105.00 psi
Load Comb :	+D+L+H
Max fv/FvRatio =	<b>0.348</b> : 1
fv : Actual :	52.20 psi at 0.000 ft in Span # 1
Fv : Allowable :	150.00 psi
Load Comb :	+D+L+H



Max Reactions (k)	D	L	Lr	S	W	E	H
Left Support	0.38	0.51					
Right Support	0.38	0.51					

Max Deflections			
Transient Downward	0.004 in	Total Downward	0.007 in
Ratio	8424	Ratio	4822
	LC: L Only		LC: +D+L+H
Transient Upward	0.000 in	Total Upward	0.000 in
Ratio	9999	Ratio	9999
	LC:		LC:

**Wood Beam Design : FB8**

Calculations per NDS 2018, IBC 2018, CBC 2019, ASCE 7-16

BEAM Size : **6x10, Sawn, Fully Braced**

Using Allowable Stress Design with IBC 2018 Load Combinations, Major Axis Bending

Wood Species :	Hem-Fir		Wood Grade :	No.1		Density	26.84 pcf
Fb - Tension	1050 psi	Fc - Prll	750 psi	Fv	140 psi	Ebend- xx	1300 ksi
Fb - Compr	1050 psi	Fc - Perp	405 psi	Ft	525 psi	Eminbend - xx	470 ksi

Applied Loads

Beam self weight calculated and added to loads  
 Unif Load: D = 0.0880, L = 0.210 k/ft, Trib= 1.0 ft

Design Summary

Max fb/Fb Ratio =	<b>0.664</b> : 1
fb : Actual :	557.98 psi at 5.000 ft in Span # 1
Fb : Allowable :	840.00 psi
Load Comb :	+D+L+H
Max fv/FvRatio =	<b>0.394</b> : 1
fv : Actual :	44.17 psi at 10.000 ft in Span # 1
Fv : Allowable :	112.00 psi
Load Comb :	+D+L+H

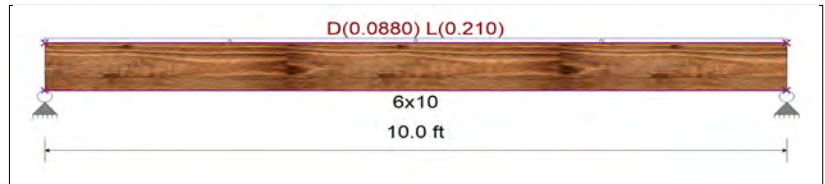

Max Reactions (k)	D	L	Lr	S	W	E	H
Left Support	0.49	1.05					
Right Support	0.49	1.05					

Max Deflections			
Transient Downward	0.093 in	Total Downward	0.136 in
Ratio	1290	Ratio	880
	LC: L Only		LC: +D+L+H
Transient Upward	0.000 in	Total Upward	0.000 in
Ratio	9999	Ratio	9999
	LC:		LC:

**Multiple Simple Beam**

Lic. #: KW-06013765

**Wood Beam Design : FB9**

Calculations per NDS 2018, IBC 2018, CBC 2019, ASCE 7-16

BEAM Size : **4x8, Sawn, Fully Braced**

Using Allowable Stress Design with IBC 2018 Load Combinations, Major Axis Bending

Wood Species :	Hem-Fir		Wood Grade :	No.2		Density	26.840 pcf
Fb - Tension	850.0 psi	Fc - Prll	1,300.0 psi	Fv	150.0 psi	Ebend- xx	1,300.0 ksi
Fb - Compr	850.0 psi	Fc - Perp	405.0 psi	Ft	525.0 psi	Eminbend - xx	470.0 ksi

Applied Loads

Beam self weight calculated and added to loads  
 Unif Load: D = 0.230, L = 0.3530 k/ft, Trib= 1.0 ft

Design Summary

Max fb/Fb Ratio =	<b>0.234</b> : 1	
fb : Actual :	258.77 psi	at 1.500 ft in Span # 1
Fb : Allowable :	1,105.00 psi	
Load Comb :	+D+L+H	
Max fv/FvRatio =	<b>0.347</b> : 1	
fv : Actual :	52.11 psi	at 0.000 ft in Span # 1
Fv : Allowable :	150.00 psi	
Load Comb :	+D+L+H	



Max Reactions (k)	D	L	Lr	S	W	E	H
Left Support	0.35	0.53					
Right Support	0.35	0.53					

Max Deflections			
Transient Downward	0.004 in	Total Downward	0.007 in
Ratio	8042	Ratio	4830
	LC: L Only		LC: +D+L+H
Transient Upward	0.000 in	Total Upward	0.000 in
Ratio	9999	Ratio	9999
	LC:		LC:

**Wood Beam Design : FB10**

Calculations per NDS 2018, IBC 2018, CBC 2019, ASCE 7-16

BEAM Size : **4x8, Sawn, Fully Braced**

Using Allowable Stress Design with IBC 2018 Load Combinations, Major Axis Bending

Wood Species :	Hem-Fir		Wood Grade :	No.2		Density	26.840 pcf
Fb - Tension	850.0 psi	Fc - Prll	1,300.0 psi	Fv	150.0 psi	Ebend- xx	1,300.0 ksi
Fb - Compr	850.0 psi	Fc - Perp	405.0 psi	Ft	525.0 psi	Eminbend - xx	470.0 ksi

Applied Loads

Beam self weight calculated and added to loads  
 Unif Load: D = 0.1970, L = 0.3030 k/ft, Trib= 1.0 ft

Design Summary

Max fb/Fb Ratio =	<b>0.804</b> : 1	
fb : Actual :	888.91 psi	at 3.000 ft in Span # 1
Fb : Allowable :	1,105.00 psi	
Load Comb :	+D+L+H	
Max fv/FvRatio =	<b>0.597</b> : 1	
fv : Actual :	89.51 psi	at 0.000 ft in Span # 1
Fv : Allowable :	150.00 psi	
Load Comb :	+D+L+H	

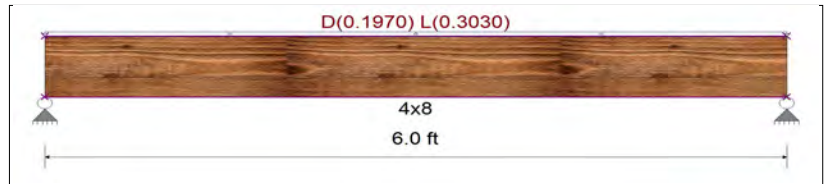

Max Reactions (k)	D	L	Lr	S	W	E	H
Left Support	0.61	0.91					
Right Support	0.61	0.91					

Max Deflections			
Transient Downward	0.061 in	Total Downward	0.102 in
Ratio	1171	Ratio	703
	LC: L Only		LC: +D+L+H
Transient Upward	0.000 in	Total Upward	0.000 in
Ratio	9999	Ratio	9999
	LC:		LC:

**Multiple Simple Beam**

Lic. #: KW-06013765

**Wood Beam Design : FB11**

Calculations per NDS 2018, IBC 2018, CBC 2019, ASCE 7-16

BEAM Size : **4x8, Sawn, Fully Braced**

Using Allowable Stress Design with IBC 2018 Load Combinations, Major Axis Bending

Wood Species :	Hem-Fir		Wood Grade :	No.2		Density	26.840 pcf
Fb - Tension	850.0 psi	Fc - Prll	1,300.0 psi	Fv	150.0 psi	Ebend- xx	1,300.0 ksi
Fb - Compr	850.0 psi	Fc - Perp	405.0 psi	Ft	525.0 psi	Eminbend - xx	470.0 ksi

Applied Loads

Beam self weight calculated and added to loads  
 Unif Load: D = 0.2310, L = 0.430 k/ft, Trib= 1.0 ft

Design Summary

Max fb/Fb Ratio = **0.737** : 1  
 fb : Actual : 814.21 psi at 2.500 ft in Span # 1  
 Fb : Allowable : 1,105.00 psi  
 Load Comb : +D+L+H

Max fv/FvRatio = **0.656** : 1  
 fv : Actual : 98.38 psi at 5.000 ft in Span # 1  
 Fv : Allowable : 150.00 psi  
 Load Comb : +D+L+H

Max Reactions (k)	D	L	Lr	S	W	E	H
Left Support	0.59	1.08					
Right Support	0.59	1.08					

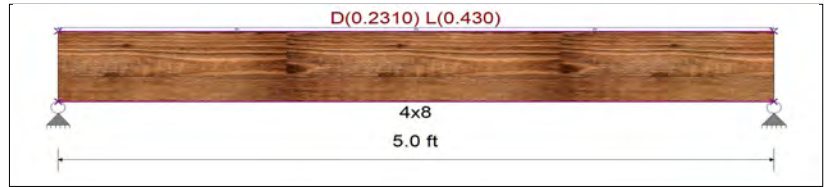

Max Deflections

Transient Downward	0.042 in	Total Downward	0.065 in
Ratio	1426	Ratio	921
	LC: L Only		LC: +D+L+H
Transient Upward	0.000 in	Total Upward	0.000 in
Ratio	9999	Ratio	9999
	LC:		LC:

**Wood Beam Design : FB12**

Calculations per NDS 2018, IBC 2018, CBC 2019, ASCE 7-16

BEAM Size : **4x10, Sawn, Fully Braced**

Using Allowable Stress Design with IBC 2018 Load Combinations, Major Axis Bending

Wood Species :	Hem-Fir		Wood Grade :	No.2		Density	26.840 pcf
Fb - Tension	850.0 psi	Fc - Prll	1,300.0 psi	Fv	150.0 psi	Ebend- xx	1,300.0 ksi
Fb - Compr	850.0 psi	Fc - Perp	405.0 psi	Ft	525.0 psi	Eminbend - xx	470.0 ksi

Applied Loads

Beam self weight calculated and added to loads  
 Unif Load: D = 0.2540, L = 0.390 k/ft, Trib= 1.0 ft

Design Summary

Max fb/Fb Ratio = **0.689** : 1  
 fb : Actual : 703.28 psi at 3.000 ft in Span # 1  
 Fb : Allowable : 1,020.00 psi  
 Load Comb : +D+L+H

Max fv/FvRatio = **0.602** : 1  
 fv : Actual : 90.35 psi at 0.000 ft in Span # 1  
 Fv : Allowable : 150.00 psi  
 Load Comb : +D+L+H

Max Reactions (k)	D	L	Lr	S	W	E	H
Left Support	0.78	1.17					
Right Support	0.78	1.17					

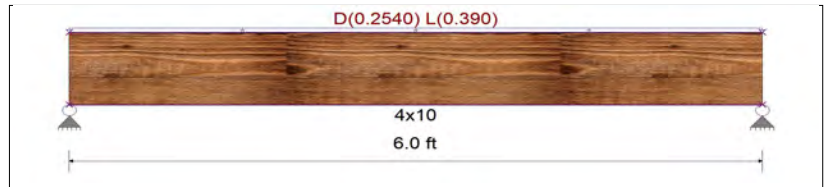

Max Deflections

Transient Downward	0.038 in	Total Downward	0.064 in
Ratio	1889	Ratio	1133
	LC: L Only		LC: +D+L+H
Transient Upward	0.000 in	Total Upward	0.000 in
Ratio	9999	Ratio	9999
	LC:		LC:

**Multiple Simple Beam**

Lic. #: KW-06013765

**Description :** Floor Beams FB13-FB24

**Wood Beam Design : FB13**

Calculations per NDS 2018, IBC 2018, CBC 2019, ASCE 7-16

BEAM Size : **4x10, Sawn, Fully Braced**

Using Allowable Stress Design with IBC 2018 Load Combinations, Major Axis Bending

Wood Species :	Hem-Fir		Wood Grade :	No.2		Density	26.840 pcf
Fb - Tension	850.0 psi	Fc - Prll	1,300.0 psi	Fv	150.0 psi	Ebend- xx	1,300.0 ksi
Fb - Compr	850.0 psi	Fc - Perp	405.0 psi	Ft	525.0 psi	Eminbend - xx	470.0 ksi

Applied Loads

Beam self weight calculated and added to loads  
 Unif Load: D = 0.2020, L = 0.310 k/ft, Trib= 1.0 ft

Design Summary

Max fb/Fb Ratio =	<b>0.549</b> : 1	
fb : Actual :	560.47 psi	at 3.000 ft in Span # 1
Fb : Allowable :	1,020.00 psi	
Load Comb :	+D+L+H	
Max fv/FvRatio =	<b>0.480</b> : 1	
fv : Actual :	72.00 psi	at 0.000 ft in Span # 1
Fv : Allowable :	150.00 psi	
Load Comb :	+D+L+H	

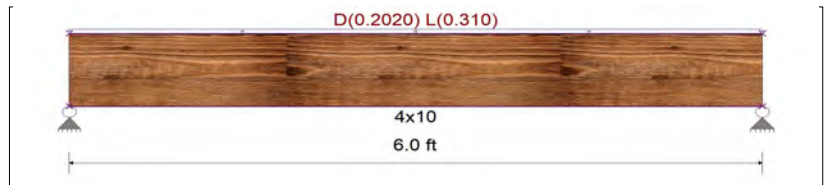

Max Reactions (k)	D	L	Lr	S	W	E	H
Left Support	0.62	0.93					
Right Support	0.62	0.93					

Max Deflections			
Transient Downward	0.030 in	Total Downward	0.051 in
Ratio	2377	Ratio	1422
	LC: L Only		LC: +D+L+H
Transient Upward	0.000 in	Total Upward	0.000 in
Ratio	9999	Ratio	9999
	LC:		LC:

**Wood Beam Design : FB14**

Calculations per NDS 2018, IBC 2018, CBC 2019, ASCE 7-16

BEAM Size : **4x8, Sawn, Fully Braced**

Using Allowable Stress Design with IBC 2018 Load Combinations, Major Axis Bending

Wood Species :	Hem-Fir		Wood Grade :	No.2		Density	26.840 pcf
Fb - Tension	850.0 psi	Fc - Prll	1,300.0 psi	Fv	150.0 psi	Ebend- xx	1,300.0 ksi
Fb - Compr	850.0 psi	Fc - Perp	405.0 psi	Ft	525.0 psi	Eminbend - xx	470.0 ksi

Applied Loads

Beam self weight calculated and added to loads  
 Unif Load: D = 0.1430, L = 0.220 k/ft, Trib= 1.0 ft

Design Summary

Max fb/Fb Ratio =	<b>0.407</b> : 1	
fb : Actual :	449.75 psi	at 2.500 ft in Span # 1
Fb : Allowable :	1,105.00 psi	
Load Comb :	+D+L+H	
Max fv/FvRatio =	<b>0.362</b> : 1	
fv : Actual :	54.34 psi	at 0.000 ft in Span # 1
Fv : Allowable :	150.00 psi	
Load Comb :	+D+L+H	



Max Reactions (k)	D	L	Lr	S	W	E	H
Left Support	0.37	0.55					
Right Support	0.37	0.55					

Max Deflections			
Transient Downward	0.022 in	Total Downward	0.036 in
Ratio	2787	Ratio	1667
	LC: L Only		LC: +D+L+H
Transient Upward	0.000 in	Total Upward	0.000 in
Ratio	9999	Ratio	9999
	LC:		LC:



**Multiple Simple Beam**

Lic. #: KW-06013765

**Wood Beam Design : FB15**

Calculations per NDS 2018, IBC 2018, CBC 2019, ASCE 7-16

BEAM Size : **4x8, Sawn, Fully Braced**

Using Allowable Stress Design with IBC 2018 Load Combinations, Major Axis Bending

Wood Species : Hem-Fir Wood Grade : No.2  
 Fb - Tension 850.0 psi Fc - Prll 1,300.0 psi Fv 150.0 psi Ebend- xx 1,300.0 ksi Density 26.840 pcf  
 Fb - Compr 850.0 psi Fc - Perp 405.0 psi Ft 525.0 psi Eminbend - xx 470.0 ksi

Applied Loads

Beam self weight calculated and added to loads  
 Unif Load: D = 0.1480, L = 0.2470 k/ft, Trib= 1.0 ft

Design Summary

Max fb/Fb Ratio = **0.159** : 1  
 fb : Actual : 176.00 psi at 1.500 ft in Span # 1  
 Fb : Allowable : 1,105.00 psi  
 Load Comb : +D+L+H  
 Max fv/FvRatio = **0.236** : 1  
 fv : Actual : 35.44 psi at 0.000 ft in Span # 1  
 Fv : Allowable : 150.00 psi  
 Load Comb : +D+L+H



Max Reactions (k) D L Lr S W E H  
 Left Support 0.23 0.37  
 Right Support 0.23 0.37

Max Deflections  
 Transient Downward 0.003 in Total Downward 0.005 in  
 Ratio 9999 Ratio 7102  
 LC: L Only LC: +D+L+H  
 Transient Upward 0.000 in Total Upward 0.000 in  
 Ratio 9999 Ratio 9999  
 LC: LC:

**Wood Beam Design : FB16**

Calculations per NDS 2018, IBC 2018, CBC 2019, ASCE 7-16

BEAM Size : **4x8, Sawn, Fully Braced**

Using Allowable Stress Design with IBC 2018 Load Combinations, Major Axis Bending

Wood Species : Hem-Fir Wood Grade : No.2  
 Fb - Tension 850.0 psi Fc - Prll 1,300.0 psi Fv 150.0 psi Ebend- xx 1,300.0 ksi Density 26.840 pcf  
 Fb - Compr 850.0 psi Fc - Perp 405.0 psi Ft 525.0 psi Eminbend - xx 470.0 ksi

Applied Loads

Beam self weight calculated and added to loads  
 Unif Load: D = 0.3120, L = 0.480 k/ft, Trib= 1.0 ft

Design Summary

Max fb/Fb Ratio = **0.714** : 1  
 fb : Actual : 789.29 psi at 2.250 ft in Span # 1  
 Fb : Allowable : 1,105.00 psi  
 Load Comb : +D+L+H  
 Max fv/FvRatio = **0.706** : 1  
 fv : Actual : 105.97 psi at 0.000 ft in Span # 1  
 Fv : Allowable : 150.00 psi  
 Load Comb : +D+L+H



Max Reactions (k) D L Lr S W E H  
 Left Support 0.71 1.08  
 Right Support 0.71 1.08

Max Deflections  
 Transient Downward 0.031 in Total Downward 0.051 in  
 Ratio 1752 Ratio 1055  
 LC: L Only LC: +D+L+H  
 Transient Upward 0.000 in Total Upward 0.000 in  
 Ratio 9999 Ratio 9999  
 LC: LC:

**Multiple Simple Beam**

Lic. #: KW-06013765

**Wood Beam Design : FB17**

Calculations per NDS 2018, IBC 2018, CBC 2019, ASCE 7-16

BEAM Size : **4x8, Sawn, Fully Braced**

Using Allowable Stress Design with IBC 2018 Load Combinations, Major Axis Bending

Wood Species :	Hem-Fir		Wood Grade :	No.2		Density	26.840 pcf
Fb - Tension	850.0 psi	Fc - Prll	1,300.0 psi	Fv	150.0 psi	Ebend- xx	1,300.0 ksi
Fb - Compr	850.0 psi	Fc - Perp	405.0 psi	Ft	525.0 psi	Eminbend - xx	470.0 ksi

Applied Loads

Beam self weight calculated and added to loads  
 Point: D = 0.70, L = 1.080 k @ 1.50 ft

Design Summary

Max fb/Fb Ratio = **0.475** : 1  
 fb : Actual : 524.56 psi at 1.500 ft in Span # 1  
 Fb : Allowable : 1,105.00 psi  
 Load Comb : +D+L+H

Max fv/FvRatio = **0.354** : 1  
 fv : Actual : 53.03 psi at 0.000 ft in Span # 1  
 Fv : Allowable : 150.00 psi  
 Load Comb : +D+L+H

Max Reactions (k)	D	L	Lr	S	W	E	H
Left Support	0.36	0.54					
Right Support	0.36	0.54					

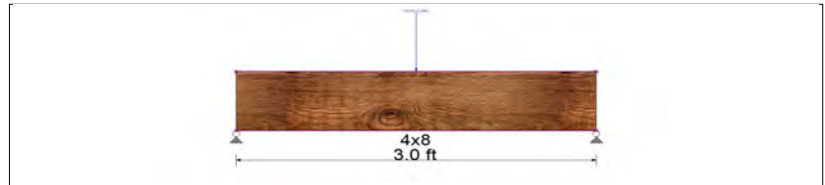

Max Deflections			
Transient Downward	0.007 in	Total Downward	0.012 in
Ratio	4930	Ratio	2976
	LC: L Only		LC: +D+L+H
Transient Upward	0.000 in	Total Upward	0.000 in
Ratio	9999	Ratio	9999
	LC:		LC:

**Wood Beam Design : FB18**

Calculations per NDS 2018, IBC 2018, CBC 2019, ASCE 7-16

BEAM Size : **6x10, Sawn, Fully Braced**

Using Allowable Stress Design with IBC 2018 Load Combinations, Major Axis Bending

Wood Species :	Hem-Fir		Wood Grade :	No.1		Density	26.84 pcf
Fb - Tension	1050 psi	Fc - Prll	750 psi	Fv	140 psi	Ebend- xx	1300 ksi
Fb - Compr	1050 psi	Fc - Perp	405 psi	Ft	525 psi	Eminbend - xx	470 ksi

Applied Loads

Beam self weight calculated and added to loads  
 Unif Load: D = 0.0790, L = 0.190 k/ft, Trib= 1.0 ft

Design Summary

Max fb/Fb Ratio = **0.728** : 1  
 fb : Actual : 611.53 psi at 5.500 ft in Span # 1  
 Fb : Allowable : 840.00 psi  
 Load Comb : +D+L+H

Max fv/FvRatio = **0.393** : 1  
 fv : Actual : 44.01 psi at 0.000 ft in Span # 1  
 Fv : Allowable : 112.00 psi  
 Load Comb : +D+L+H

Max Reactions (k)	D	L	Lr	S	W	E	H
Left Support	0.49	1.05					
Right Support	0.49	1.05					

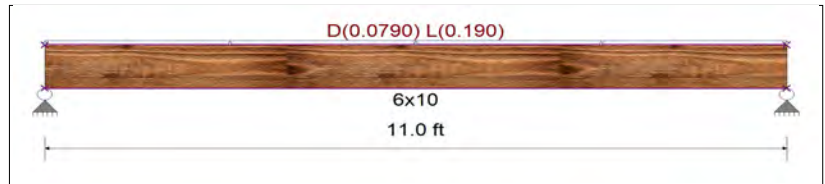

Max Deflections			
Transient Downward	0.123 in	Total Downward	0.181 in
Ratio	1071	Ratio	730
	LC: L Only		LC: +D+L+H
Transient Upward	0.000 in	Total Upward	0.000 in
Ratio	9999	Ratio	9999
	LC:		LC:

**Multiple Simple Beam**

Lic. #: KW-06013765

**Wood Beam Design : FB19**

Calculations per NDS 2018, IBC 2018, CBC 2019, ASCE 7-16

BEAM Size : **5.125x10.5, GLB, Fully Braced**

Using Allowable Stress Design with IBC 2018 Load Combinations, Major Axis Bending

Wood Species :	DF/DF	Wood Grade :	24F-V4						
Fb - Tension	2,400.0 psi	Fc - Prll	1,650.0 psi	Fv	265.0 psi	Ebend- xx	1,800.0 ksi	Density	31.210 pcf
Fb - Compr	1,850.0 psi	Fc - Perp	650.0 psi	Ft	1,100.0 psi	Eminbend - xx	950.0 ksi		

Applied Loads

Beam self weight calculated and added to loads  
 Unif Load: D = 0.3170, L = 0.6750 k/ft, Trib= 1.0 ft

Design Summary

Max fb/Fb Ratio = **0.666** : 1  
 fb : Actual : 1,598.67 psi at 5.000 ft in Span # 1  
 Fb : Allowable : 2,400.00 psi  
 Load Comb : +D+L+H

Max fv/FvRatio = **0.528** : 1  
 fv : Actual : 139.88 psi at 0.000 ft in Span # 1  
 Fv : Allowable : 265.00 psi  
 Load Comb : +D+L+H

Max Reactions (k)	D	L	Lr	S	W	E	H
Left Support	1.64	3.38					
Right Support	1.64	3.38					

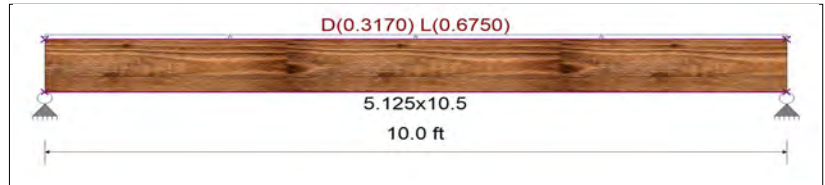

Max Deflections

Transient Downward	0.172 in	Total Downward	0.255 in
Ratio	699	Ratio	470
	LC: L Only		LC: +D+L+H
Transient Upward	0.000 in	Total Upward	0.000 in
Ratio	9999	Ratio	9999
	LC:		LC:

**Wood Beam Design : FB20**

Calculations per NDS 2018, IBC 2018, CBC 2019, ASCE 7-16

BEAM Size : **4x8, Sawn, Fully Braced**

Using Allowable Stress Design with IBC 2018 Load Combinations, Major Axis Bending

Wood Species :	Hem-Fir	Wood Grade :	No.2						
Fb - Tension	850.0 psi	Fc - Prll	1,300.0 psi	Fv	150.0 psi	Ebend- xx	1,300.0 ksi	Density	26.840 pcf
Fb - Compr	850.0 psi	Fc - Perp	405.0 psi	Ft	525.0 psi	Eminbend - xx	470.0 ksi		

Applied Loads

Beam self weight calculated and added to loads  
 Unif Load: D = 0.1840, L = 0.3920 k/ft, Trib= 1.0 ft

Design Summary

Max fb/Fb Ratio = **0.803** : 1  
 fb : Actual : 710.25 psi at 2.500 ft in Span # 1  
 Fb : Allowable : 884.00 psi  
 Load Comb : +D+L+H

Max fv/FvRatio = **0.715** : 1  
 fv : Actual : 85.82 psi at 5.000 ft in Span # 1  
 Fv : Allowable : 120.00 psi  
 Load Comb : +D+L+H

Max Reactions (k)	D	L	Lr	S	W	E	H
Left Support	0.47	0.98					
Right Support	0.47	0.98					



Max Deflections

Transient Downward	0.038 in	Total Downward	0.057 in
Ratio	1564	Ratio	1055
	LC: L Only		LC: +D+L+H
Transient Upward	0.000 in	Total Upward	0.000 in
Ratio	9999	Ratio	9999
	LC:		LC:

**Multiple Simple Beam**

Lic. #: KW-06013765

**Wood Beam Design : FB21**

Calculations per NDS 2018, IBC 2018, CBC 2019, ASCE 7-16

BEAM Size : **3.125x10.5, GLB, Fully Braced**

Using Allowable Stress Design with IBC 2018 Load Combinations, Major Axis Bending

Wood Species : DF/DF

Wood Grade : 24F-V4

Fb - Tension 2,400.0 psi Fc - Prll 1,650.0 psi Fv 265.0 psi Ebend- xx 1,800.0 ksi Density 31.210 pcf  
 Fb - Compr 1,850.0 psi Fc - Perp 650.0 psi Ft 1,100.0 psi Eminbend - xx 950.0 ksi

Applied Loads

Beam self weight calculated and added to loads  
 Unif Load: D = 0.2530, L = 0.3250 k/ft, Trib= 1.0 ft

Design Summary

Max fb/Fb Ratio = **0.637** : 1  
 fb : Actual : 1,528.45 psi at 5.000 ft in Span # 1  
 Fb : Allowable : 2,400.00 psi  
 Load Comb : +D+L+H  
 Max fv/FvRatio = **0.505** : 1  
 fv : Actual : 133.74 psi at 10.000 ft in Span # 1  
 Fv : Allowable : 265.00 psi  
 Load Comb : +D+L+H

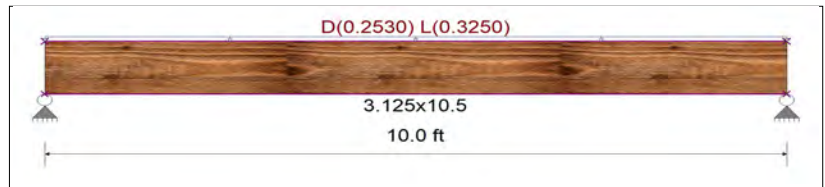

Max Reactions (k) D L Lr S W E H  
 Left Support 1.30 1.63  
 Right Support 1.30 1.63

Max Deflections

Transient Downward	0.135 in	Total Downward	0.244 in
Ratio	885	Ratio	491
LC: L Only		LC: +D+L+H	
Transient Upward	0.000 in	Total Upward	0.000 in
Ratio	9999	Ratio	9999
LC:		LC:	

**Wood Beam Design : FB22**

Calculations per NDS 2018, IBC 2018, CBC 2019, ASCE 7-16

BEAM Size : **5.125x10.5, GLB, Fully Braced**

Using Allowable Stress Design with IBC 2018 Load Combinations, Major Axis Bending

Wood Species : DF/DF

Wood Grade : 24F-V4

Fb - Tension 2,400.0 psi Fc - Prll 1,650.0 psi Fv 265.0 psi Ebend- xx 1,800.0 ksi Density 31.210 pcf  
 Fb - Compr 1,850.0 psi Fc - Perp 650.0 psi Ft 1,100.0 psi Eminbend - xx 950.0 ksi

Applied Loads

Beam self weight calculated and added to loads  
 Unif Load: D = 0.2940, L = 0.6250 k/ft, 0.0 ft to 6.0 ft, Trib= 1.0 ft  
 Unif Load: D = 0.670, L = 1.425 k/ft, 6.0 to 10.0 ft, Trib= 1.0 ft

Design Summary

Max fb/Fb Ratio = **0.893** : 1  
 fb : Actual : 2,142.39 psi at 6.000 ft in Span # 1  
 Fb : Allowable : 2,400.00 psi  
 Load Comb : +D+L+H  
 Max fv/FvRatio = **0.885** : 1  
 fv : Actual : 234.61 psi at 10.000 ft in Span # 1  
 Fv : Allowable : 265.00 psi  
 Load Comb : +D+L+H

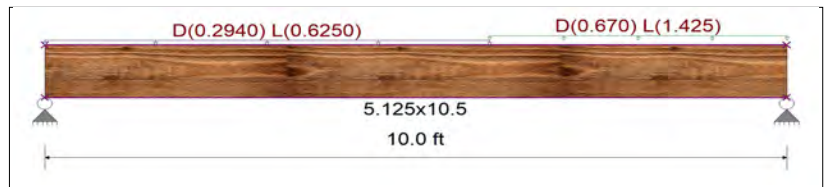

Max Reactions (k) D L Lr S W E H  
 Left Support 1.83 3.77  
 Right Support 2.73 5.69

Max Deflections

Transient Downward	0.229 in	Total Downward	0.339 in
Ratio	524	Ratio	353 <360
LC: L Only		LC: +D+L+H	
Transient Upward	0.000 in	Total Upward	0.000 in
Ratio	9999	Ratio	9999
LC:		LC:	

**Multiple Simple Beam**

Lic. #: KW-06013765

**Wood Beam Design : FB23**

Calculations per NDS 2018, IBC 2018, CBC 2019, ASCE 7-16

BEAM Size : **3.5x11.875, TimberStrand LSL, Fully Braced**  
 Using Allowable Stress Design with IBC 2018 Load Combinations, Major Axis Bending  
 Wood Species : iLevel Truss Joist Wood Grade : TimberStrand LSL 1.55E  
 Fb - Tension 2,325.0 psi Fc - Prll 2,050.0 psi Fv 310.0 psi Ebend- xx 1,550.0 ksi Density 45.010 pcf  
 Fb - Compr 2,325.0 psi Fc - Perp 800.0 psi Ft 1,070.0 psi Eminbend - xx 787.82 ksi

Applied Loads

Beam self weight calculated and added to loads  
 Unif Load: D = 0.5160, L = 0.640 k/ft, 0.0 ft to 3.0 ft, Trib= 1.0 ft  
 Unif Load: D = 0.2080, L = 0.320 k/ft, 3.0 to 7.0 ft, Trib= 1.0 ft  
 Point: D = 0.6240, L = 0.960 k @ 3.0 ft

Design Summary

Max fb/Fb Ratio = **0.475** : 1  
 fb : Actual : 1,104.04 psi at 3.010 ft in Span # 1  
 Fb : Allowable : 2,325.00 psi  
 Load Comb : +D+L+H  
 Max fv/FvRatio = **0.498** : 1  
 fv : Actual : 154.43 psi at 0.000 ft in Span # 1  
 Fv : Allowable : 310.00 psi  
 Load Comb : +D+L+H



Max Reactions (k) D L Lr S W E H  
 Left Support 1.86 2.42  
 Right Support 1.24 1.74

Max Deflections

Transient Downward	0.047 in	Total Downward	0.082 in
Ratio	1779	Ratio	1029
LC: L Only		LC: +D+L+H	
Transient Upward	0.000 in	Total Upward	0.000 in
Ratio	9999	Ratio	9999
LC:		LC:	

**Wood Beam Design : FB24**

Calculations per NDS 2018, IBC 2018, CBC 2019, ASCE 7-16

BEAM Size : **3.5x11.875, TimberStrand LSL, Fully Braced**  
 Using Allowable Stress Design with IBC 2018 Load Combinations, Major Axis Bending  
 Wood Species : iLevel Truss Joist Wood Grade : TimberStrand LSL 1.55E  
 Fb - Tension 2,325.0 psi Fc - Prll 2,050.0 psi Fv 310.0 psi Ebend- xx 1,550.0 ksi Density 45.010 pcf  
 Fb - Compr 2,325.0 psi Fc - Perp 800.0 psi Ft 1,070.0 psi Eminbend - xx 787.82 ksi

Applied Loads

Beam self weight calculated and added to loads  
 Unif Load: D = 0.8240, L = 0.960 k/ft, 0.0 ft to 3.0 ft, Trib= 1.0 ft  
 Unif Load: D = 0.2080, L = 0.320 k/ft, 3.0 to 7.0 ft, Trib= 1.0 ft  
 Point: D = 1.248, L = 1.960 k @ 3.0 ft

Design Summary

Max fb/Fb Ratio = **0.750** : 1  
 fb : Actual : 1,744.39 psi at 2.987 ft in Span # 1  
 Fb : Allowable : 2,325.00 psi  
 Load Comb : +D+L+H  
 Max fv/FvRatio = **0.779** : 1  
 fv : Actual : 241.34 psi at 0.000 ft in Span # 1  
 Fv : Allowable : 310.00 psi  
 Load Comb : +D+L+H



Max Reactions (k) D L Lr S W E H  
 Left Support 2.94 3.75  
 Right Support 1.70 2.37

Max Deflections

Transient Downward	0.072 in	Total Downward	0.125 in
Ratio	1164	Ratio	671
LC: L Only		LC: +D+L+H	
Transient Upward	0.000 in	Total Upward	0.000 in
Ratio	9999	Ratio	9999
LC:		LC:	

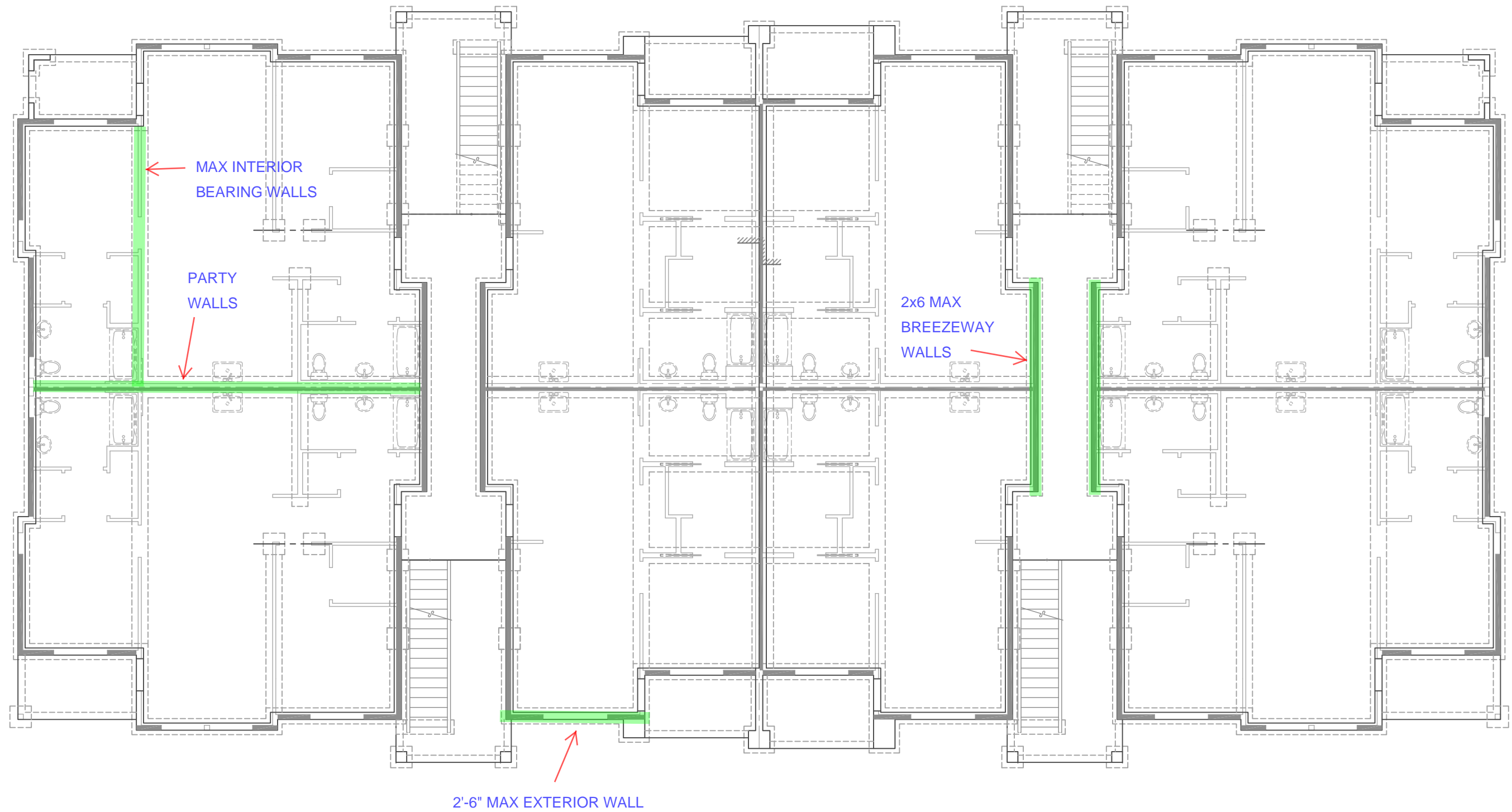

### CONTROLLING BEARING WALLS - KEY PLAN

## Bradley Heights Apt - S4S Job# 23.007

## Bearing Wall Loading

Max Loaded Exterior Wall							
DL/LL Level	Tributary Widths				Wall Loading		
	22/25 Roof	26/40 Floor	25/60 Deck	47/100 Corridor	+12 psf self Wt		
	DL	LL	S				
Roof	15.0				450	0	375
3rd		5.5	2.5		773	365	375
2nd		5.5	2.5		1,096	730	375
1st		5.5	2.5		1,419	1,095	375

Breezeway Walls							
DL/LL Level	Tributary Widths				Wall Loading		
	22/25 Roof	26/40 Floor	25/60 Deck	47/100 Corridor	+12 psf self Wt		
	DL	LL	S				
Roof	2.0				164	0	50
3rd		7.5		2.5	597	550	50
2nd		7.5		2.5	1,029	1,100	50
1st		7.5		2.5	1,462	1,650	50

2x4 and 2x6 Interior							
DL/LL Level	Tributary Widths				Wall Loading		
	22/25 Roof	26/40 Floor	25/60 Deck	47/100 Corridor	+9 psf self Wt		
	DL	LL	S				
Roof	2.0				134	0	50
3rd		13.0			562	520	50
2nd		13.0			990	1,040	50
1st		13.0			1,418	1,560	50

2x6 Party							
DL/LL Level	Tributary Widths				Wall Loading		
	22/25 Roof	26/40 Floor	25/60 Deck	47/100 Corridor	+9 psf self Wt		
	DL	LL	S				
Roof	13.5				387	0	338
3rd		4.5			594	180	338
2nd		4.5			801	360	338
1st		4.5			1,008	540	338

2x4 Party							
DL/LL Level	Tributary Widths				Wall Loading		
	22/25 Roof	26/40 Floor	25/60 Deck	47/100 Corridor	+9 psf self Wt		
	DL	LL	S				
Roof	13.5				387	0	338
3rd		0.67			494	27	338
2nd		0.67			602	54	338
1st		1.67			735	120	338



JOB #: 23.007

DESIGNED: MRO

DATE: 05/31/23

PROJECT: Bradley Hts Apartments Typical Exterior - 1st

**STUD WALL DESIGN**

2018 NDS/2018 IBC

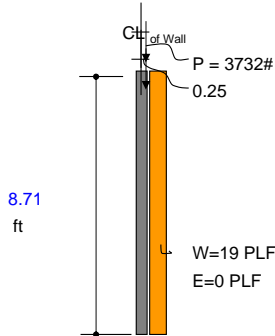

AXIAL LOADS P	
P <sub>DL</sub> (#/ft) =	1,419
P <sub>SL</sub> (#/ft) =	375
P <sub>LL</sub> (#/ft) =	1,095
P <sub>TOT</sub> (#/ft) =	2,889
e (IN) =	0.5
TRIB. (IN) =	16

LATERAL LOADS W	
W (PSF) =	15.00
E (PSF) =	0.00
TRIB. (IN) =	16

DESIGN VALUES	
F <sub>b</sub> (psi) =	675
F <sub>v</sub> (psi) =	150
F <sub>c</sub> (psi) =	800
F <sub>cL</sub> (psi) =	405
E (psi) =	1.20E+06
E <sub>min</sub> (psi) =	4.40E+05
C <sub>r</sub> =	1.15
L <sub>u</sub> (in) =	104.5
c =	0.8
K <sub>e</sub> =	1
C <sub>b</sub> =	1.00

Hem Fir	▼
Stud Grade	▼
Bending X-X axis	▼
	405
Incised, No	▼
Wet Use, No	▼
Repetitive, Yes	▼
Full Bracing, Yes	▼
(Sawn Lumber)	
(Appendix G)	
(Bearing Area Factor)	

Bearing wall Fire rated? No  
 Fire Retardant FirePRO? No  
 Header Bearing Area (in<sup>2</sup>) = 8.25

Use: (1) 2" X 6" @ 16" O.C. OK

405 = F<sub>cL</sub> (psi)

MEMBER SIZE		SECTION PROPERTIES			
QUANTITY	1	A =	8.25 in <sup>2</sup>		
b =	1.5 in	S =	7.56 in <sup>3</sup>		
d =	5.5 in	I =	20.80 in <sup>4</sup>		
	(Eq. 16-9)	(Eq. 16-10)	(Eq. 16-11)	(Eq. 16-12)	(Eq. 16-13)
<b>LOAD CASES</b>	DL + LL	DL + SL	DL+0.75(LL+SL)	DL + W	DL+0.75(LL+SL+W)
L <sub>u</sub> (ft) =	8.708	8.708	8.708	8.708	8.708
V <sub>applied</sub> (#) =	16	11	16	93	79
M <sub>applied</sub> (ft-#) =	68	48	68	237	226
P <sub>applied</sub> (#) =	3247	2317	3257	1833	3257
C <sub>D</sub> =	1	1.15	1.15	1.6	1.6
<b>BENDING STRESS CALCS</b>	F <sub>bE</sub> (psi) = 17476			C <sub>bF</sub> = 1	
F <sub>b</sub> * (psi) =	776	893	893	1242	1242
C <sub>L</sub> =	1.000	1.000	1.000	1.000	1.000
F <sub>b</sub> ' (psi) =	776	893	893	1242	1242
<b>AXIAL STRESS CALCS</b>	F <sub>cE</sub> = 1002			C <sub>cF</sub> = 1	
L <sub>e</sub> /d =	19.00	19.00	19.00	19.00	19.00
F <sub>c</sub> * (psi) =	800	920	920	1280	1280
C <sub>P</sub> =	0.7626	0.7196	0.7196	0.6013	0.6013
F <sub>c</sub> ' (psi) =	610	662	662	770	770
<b>ALLOWABLES</b>	DL + LL	DL + SL	DL+0.75(LL+SL)	DL + W	DL+0.75(LL+SL+W)
V <sub>allow</sub> (#) =	825	949	949	1321	1321
M <sub>allow</sub> (ft - #) =	489	563	563	783	783
P <sub>allow</sub> (#) =	5,035	5,465	5,465	6,353	6,353
(f <sub>v</sub> /F <sub>v</sub> ) <sup>2</sup> + f <sub>v</sub> /(F <sub>v</sub> (1-(f <sub>v</sub> /F <sub>vE</sub> ))) =	0.64	0.30	0.55	0.47	0.74
(f <sub>v</sub> /F <sub>vE</sub> ) + (f <sub>v</sub> /F <sub>vE</sub> ) <sup>2</sup> =	0.39	0.28	0.39	0.22	0.39
P <sub>c,allow</sub> on PL (#) =	3,343	3,343	3,343	3,343	3,343
P <sub>c,allow</sub> on Beam (#) =	3,341	3,341	3,341	3,341	3,341
Deflection L/	NA	NA	NA	L/1040	L/1387
240	0.00	0.00	0.00	0.10	0.08
<b>CHECKS</b>	DL + LL	DL + SL	DL+0.75(LL+SL)	DL + W	DL+0.75(LL+SL+W)
<b>SHEAR V</b>	OK	OK	OK	OK	OK
V <sub>applied</sub> /V <sub>allow</sub>	1.9%	1.2%	1.6%	7.1%	6.0%
<b>MOMENT M</b>	OK	OK	OK	OK	OK
M <sub>applied</sub> /M <sub>allow</sub>	13.8%	8.6%	12.1%	30.3%	28.9%
<b>AXIAL P</b>	OK	OK	OK	OK	OK
P <sub>applied</sub> /P <sub>allow</sub>	64.5%	42.4%	59.6%	28.9%	51.3%
(f <sub>v</sub> /F <sub>v</sub> ) <sup>2</sup> + f <sub>v</sub> /(F <sub>v</sub> (1-(f <sub>v</sub> /F <sub>vE</sub> ))) =	OK	OK	OK	OK	OK
(f <sub>v</sub> /F <sub>vE</sub> ) + (f <sub>v</sub> /F <sub>vE</sub> ) <sup>2</sup> =	64.4%	29.9%	55.4%	47.3%	73.9%
(f <sub>v</sub> /F <sub>vE</sub> ) + (f <sub>v</sub> /F <sub>vE</sub> ) <sup>2</sup> =	OK	OK	OK	OK	OK
(f <sub>v</sub> /F <sub>vE</sub> ) + (f <sub>v</sub> /F <sub>vE</sub> ) <sup>2</sup> =	39.3%	28.0%	39.4%	22.2%	39.4%
<b>AXIAL P<sub>v</sub> on PL</b>	OK	OK	OK	OK	OK
P <sub>c,applied</sub> /P <sub>c,allow</sub>	97.1%	69.3%	97.4%	54.8%	97.4%
<b>AXIAL P<sub>v</sub> on Beam</b>	OK	OK	OK	OK	OK
P <sub>c,applied</sub> /P <sub>c,allow</sub>	97.2%	69.4%	97.5%	54.9%	97.5%
<b>DEFLECTION</b>	OK	OK	OK	OK	OK
D <sub>actual</sub> /D <sub>allowed</sub>	0.0%	0.0%	0.0%	23.1%	17.3%
<b>Overall Check</b>	OK	OK	OK	OK	OK

(Table 4a Bending)

(Eq 3.7-1)

(Eq 3.7-1)

(Table 4.3.1)

(Table 4a Compression)

(3.7.1.4) <50

Le = (Ke)L

(Eq 3.7-1)

(Eq 3.7-1)

(Table 4.3.1)

V<sub>allow</sub> = A \* F<sub>v</sub> \* C<sub>D</sub> / 1.5

M<sub>allow</sub> = S \* F<sub>b</sub> \* C<sub>b</sub> \* C<sub>F</sub> \* C<sub>L</sub> \* C<sub>r</sub>

P<sub>allow</sub> = A \* F<sub>c</sub> \* C<sub>D</sub> \* C<sub>F</sub> \* C<sub>P</sub>

(Eq 3.9-3)

(Eq 3.9-4)

P<sub>c,allow</sub> = A \* F<sub>c</sub> \* C<sub>b</sub>

P<sub>c,allow</sub> = A \* F<sub>c</sub>

L / ( I \* E / 15 \* L \* M<sub>applied</sub>)

(1.0) \* W Table 1604.3(f)

Actual Δ

Axial + Ber

Bearing on

Bearing on





JOB #: 23.007

DESIGNED: MRO

DATE: 05/31/23

PROJECT: Bradley Hts Apartments

Breeqway - 2nd

**STUD WALL DESIGN**

2018 NDS/2018 IBC

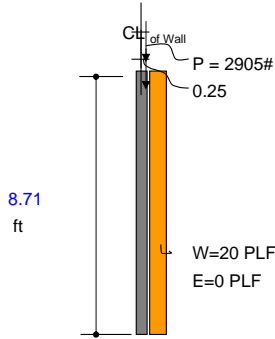

AXIAL LOADS P	
P <sub>DL</sub> (#/ft) =	1,029
P <sub>SL</sub> (#/ft) =	50
P <sub>LL</sub> (#/ft) =	1,100
P <sub>TOT</sub> (#/ft) =	2,179
e (IN) =	0.5
TRIB. (IN) =	16

LATERAL LOADS W	
W (PSF) =	15.00
E (PSF) =	0.00
TRIB. (IN) =	16

DESIGN VALUES	
F <sub>b</sub> (psi) =	675
F <sub>v</sub> (psi) =	150
F <sub>c</sub> (psi) =	800
F <sub>cL</sub> (psi) =	405
E (psi) =	1.20E+06
E <sub>min</sub> (psi) =	4.40E+05
C <sub>r</sub> =	1.15
L <sub>u</sub> (in) =	104.5
c =	0.8
K <sub>e</sub> =	1
C <sub>b</sub> =	1.00

Hem Fir	▼
Stud Grade	▼
Bending X-X axis	▼
	405
Incised, No	▼
Wet Use, No	▼
Repetitive, Yes	▼
Full Bracing, Yes	▼
(Sawn Lumber)	
(Appendix G)	
(Bearing Area Factor)	

Bearing wall Fire rated? No  
 Fire Retardant FirePRO? No  
 Header Bearing Area (in<sup>2</sup>) = 8.25

Use: (1) 2" X 6" @ 16" O.C. OK

405 = F<sub>cL</sub> (psi)

MEMBER SIZE		SECTION PROPERTIES			
QUANTITY	1	A =	8.25 in <sup>2</sup>		
b =	1.5 in	S =	7.56 in <sup>3</sup>		
d =	5.5 in	I =	20.80 in <sup>4</sup>		
	(Eq. 16-9)	(Eq. 16-10)	(Eq. 16-11)	(Eq. 16-12)	(Eq. 16-13)
LOAD CASES	DL + LL	DL + SL	DL+0.75(LL+SL)	DL + W	DL+0.75(LL+SL+W)
L <sub>u</sub> (ft) =	8.708	8.708	8.708	8.708	8.708
V <sub>applied</sub> (#) =	14	7	12	94	77
M <sub>applied</sub> (ft-#) =	59	30	53	230	211
P <sub>applied</sub> (#) =	2839	1439	2522	1372	2522
C <sub>D</sub> =	1	1.15	1.15	1.6	1.6
BENDING STRESS CALCS	F <sub>bE</sub> (psi) = 17476			C <sub>DF</sub> = 1	
F <sub>b</sub> * (psi) =	776	893	893	1242	1242
C <sub>L</sub> =	1.000	1.000	1.000	1.000	1.000
F <sub>b</sub> ' (psi) =	776	893	893	1242	1242
AXIAL STRESS CALCS	F <sub>cE</sub> = 1002			C <sub>CF</sub> = 1	
L <sub>e</sub> /d =	19.00	19.00	19.00	19.00	19.00
F <sub>c</sub> * (psi) =	800	920	920	1280	1280
C <sub>P</sub> =	0.7626	0.7196	0.7196	0.6013	0.6013
F <sub>c</sub> ' (psi) =	610	662	662	770	770
ALLOWABLES	DL + LL	DL + SL	DL+0.75(LL+SL)	DL + W	DL+0.75(LL+SL+W)
V <sub>allow</sub> (#) =	825	949	949	1320	1320
M <sub>allow</sub> (ft - #) =	489	563	563	783	783
P <sub>allow</sub> (#) =	5,033	5,462	5,462	6,350	6,350
(f <sub>v</sub> /F <sub>v</sub> ) <sup>2</sup> + f <sub>v</sub> /(F <sub>v</sub> (1-(f <sub>v</sub> /F <sub>vE</sub> ))) =	0.50	0.13	0.35	0.40	0.55
(f <sub>v</sub> /F <sub>vE</sub> ) + (f <sub>v</sub> /F <sub>vE</sub> ) <sup>2</sup> =	0.34	0.17	0.31	0.17	0.31
P <sub>c,allow</sub> on PL (#) =	3,341	3,341	3,341	3,341	3,341
P <sub>c,allow</sub> on Beam (#) =	3,341	3,341	3,341	3,341	3,341
Deflection L/	NA	NA	NA	L/1008	L/1344
240	0.00	0.00	0.00	0.10	0.08
CHECKS	DL + LL	DL + SL	DL+0.75(LL+SL)	DL + W	DL+0.75(LL+SL+W)
SHEAR V	OK	OK	OK	OK	OK
V <sub>applied</sub> /V <sub>allow</sub>	1.6%	0.7%	1.3%	7.1%	5.9%
MOMENT M	OK	OK	OK	OK	OK
M <sub>applied</sub> /M <sub>allow</sub>	12.1%	5.3%	9.3%	29.4%	27.0%
AXIAL P	OK	OK	OK	OK	OK
P <sub>applied</sub> /P <sub>allow</sub>	56.4%	26.3%	46.2%	21.6%	39.7%
(f <sub>v</sub> /F <sub>v</sub> ) <sup>2</sup> + f <sub>v</sub> /(F <sub>v</sub> (1-(f <sub>v</sub> /F <sub>vE</sub> ))) =	OK	OK	OK	OK	OK
(f <sub>v</sub> /F <sub>v</sub> ) <sup>2</sup> + f <sub>v</sub> /(F <sub>v</sub> (1-(f <sub>v</sub> /F <sub>vE</sub> ))) =	50.2%	13.4%	34.8%	39.9%	54.6%
(f <sub>v</sub> /F <sub>vE</sub> ) + (f <sub>v</sub> /F <sub>vE</sub> ) <sup>2</sup> =	OK	OK	OK	OK	OK
(f <sub>v</sub> /F <sub>vE</sub> ) + (f <sub>v</sub> /F <sub>vE</sub> ) <sup>2</sup> =	34.3%	17.4%	30.5%	16.6%	30.5%
AXIAL P <sub>c</sub> on PL	OK	OK	OK	OK	OK
P <sub>c,applied</sub> /P <sub>c,allow</sub>	85.0%	43.1%	75.5%	41.1%	75.5%
AXIAL P <sub>c</sub> on Beam	OK	OK	OK	OK	OK
P <sub>c,applied</sub> /P <sub>c,allow</sub>	85.0%	43.1%	75.5%	41.1%	75.5%
DEFLECTION	OK	OK	OK	OK	OK
D <sub>actual</sub> /D <sub>allowed</sub>	0.0%	0.0%	0.0%	23.8%	17.9%
Overall Check	OK	OK	OK	OK	OK

(Table 4a Bending)

(Eq 3.7-1)

(Eq 3.7-1)

(Table 4.3.1)

(Table 4a Compression)

(3.7.1.4) <50

Le = (Ke)L

(Eq 3.7-1)

(Eq 3.7-1)

(Table 4.3.1)

V<sub>allow</sub> = A \* F<sub>v</sub> \* C<sub>D</sub> / 1.5

M<sub>allow</sub> = S \* F<sub>b</sub> \* C<sub>D</sub> \* C<sub>F</sub> \* C<sub>L</sub> \* C<sub>r</sub>

P<sub>allow</sub> = A \* F<sub>c</sub> \* C<sub>D</sub> \* C<sub>F</sub> \* C<sub>P</sub>

(Eq 3.9-3)

(Eq 3.9-4)

P<sub>c,allow</sub> = A \* F<sub>c</sub> \* C<sub>b</sub>

P<sub>c,allow</sub> = A \* F<sub>c</sub>

L / (I \* E / 15 \* L \* M<sub>applied</sub>)

(1.0) \* W Table 1604.3(f)

Actual Δ

Axial + Ber

Bearing on

Bearing on



JOB #: 23.007

DESIGNED: MRO

DATE: 05/31/23

PROJECT: Bradley Hts Apartments Breeqway - 1st

**STUD WALL DESIGN**

2018 NDS/2018 IBC

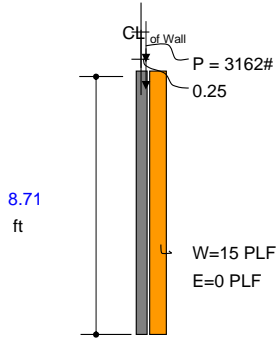

AXIAL LOADS P	
P <sub>DL</sub> (#/ft) =	1,462
P <sub>SL</sub> (#/ft) =	50
P <sub>LL</sub> (#/ft) =	1,650
P <sub>TOT</sub> (#/ft) =	3,162
e (IN) =	0.5
TRIB. (IN) =	12

LATERAL LOADS W	
W (PSF) =	15.00
E (PSF) =	0.00
TRIB. (IN) =	12

DESIGN VALUES	
F <sub>b</sub> (psi) =	675
F <sub>v</sub> (psi) =	150
F <sub>c</sub> (psi) =	800
F <sub>cL</sub> (psi) =	405
E (psi) =	1.20E+06
E <sub>min</sub> (psi) =	4.40E+05
C <sub>r</sub> =	1.15
L <sub>u</sub> (in) =	104.5
c =	0.8
K <sub>e</sub> =	1
C <sub>b</sub> =	1.00

Hem Fir	▼
Stud Grade	▼
Bending X-X axis	▼
	405
Incised, No	▼
Wet Use, No	▼
Repetitive, Yes	▼
Full Bracing, Yes	▼
(Sawn Lumber)	
(Appendix G)	
(Bearing Area Factor)	

Bearing wall Fire rated?  No  
 Fire Retardant FirePRO?  No  
 Header Bearing Area (in<sup>2</sup>) = 8.25

Use: (1) 2" X 6" @ 12" O.C. OK

405 = F<sub>cL</sub> (psi)

MEMBER SIZE		SECTION PROPERTIES				
QUANTITY	1	A =		8.25 in <sup>2</sup>		
b =	1.5 in	S =		7.56 in <sup>3</sup>		
d =	5.5 in	I =		20.80 in <sup>4</sup>		
	(Eq. 16-9)	(Eq. 16-10)	(Eq. 16-11)	(Eq. 16-12)	(Eq. 16-13)	
LOAD CASES	DL + LL	DL + SL	DL+0.75(LL+SL)	DL + W	DL+0.75(LL+SL+W)	
L <sub>u</sub> (ft) =	8.708	8.708	8.708	8.708	8.708	
V <sub>applied</sub> (#) =	15	7	13	72	62	
M <sub>applied</sub> (ft-#) =	65	32	57	182	177	
P <sub>applied</sub> (#) =	3112	1512	2737	1462	2737	
C <sub>D</sub> =	1	1.15	1.15	1.6	1.6	
BENDING STRESS CALCS		F <sub>bE</sub> (psi) = 17476			C <sub>DF</sub> = 1	
F <sub>b</sub> * (psi) =	776	893	893	1242	1242	
C <sub>L</sub> =	1.000	1.000	1.000	1.000	1.000	
F <sub>b</sub> ' (psi) =	776	893	893	1242	1242	
AXIAL STRESS CALCS		F <sub>cE</sub> = 1002			C <sub>CF</sub> = 1	
L <sub>e</sub> /d =	19.00	19.00	19.00	19.00	19.00	
F <sub>c</sub> * (psi) =	800	920	920	1280	1280	
C <sub>P</sub> =	0.7626	0.7196	0.7196	0.6013	0.6013	
F <sub>c</sub> ' (psi) =	610	662	662	770	770	
ALLOWABLES	DL + LL	DL + SL	DL+0.75(LL+SL)	DL + W	DL+0.75(LL+SL+W)	
V <sub>allow</sub> (#) =	825	949	949	1320	1320	
M <sub>allow</sub> (ft - #) =	489	563	563	783	783	
P <sub>allow</sub> (#) =	5,033	5,462	5,462	6,350	6,350	
(f <sub>v</sub> /F <sub>v</sub> ) <sup>2</sup> + f <sub>v</sub> /(F <sub>v</sub> (1-(f <sub>v</sub> /F <sub>vE</sub> ))) =	0.59	0.15	0.40	0.34	0.52	
(f <sub>v</sub> /F <sub>vE</sub> ) + (f <sub>v</sub> /F <sub>vE</sub> ) <sup>2</sup> =	0.38	0.18	0.33	0.18	0.33	
P <sub>c,allow</sub> on PL (#) =	3,341	3,341	3,341	3,341	3,341	
P <sub>c,allow</sub> on Beam (#) =	3,341	3,341	3,341	3,341	3,341	
Deflection L/	NA	NA	NA	L/1344	L/1792	
240	0.00	0.00	0.00	0.08	0.06	
CHECKS	DL + LL	DL + SL	DL+0.75(LL+SL)	DL + W	DL+0.75(LL+SL+W)	
SHEAR V	OK	OK	OK	OK	OK	
V <sub>applied</sub> /V <sub>allow</sub>	1.8%	0.8%	1.4%	5.5%	4.7%	
MOMENT M	OK	OK	OK	OK	OK	
M <sub>applied</sub> /M <sub>allow</sub>	13.3%	5.6%	10.1%	23.3%	22.6%	
AXIAL P	OK	OK	OK	OK	OK	
P <sub>applied</sub> /P <sub>allow</sub>	61.8%	27.7%	50.1%	23.0%	43.1%	
(f <sub>c</sub> /F <sub>c</sub> ) <sup>2</sup> + f <sub>c</sub> /(F <sub>c</sub> (1-(f <sub>c</sub> /F <sub>cE</sub> ))) =	OK	OK	OK	OK	OK	
(f <sub>c</sub> /F <sub>cE</sub> ) + (f <sub>c</sub> /F <sub>cE</sub> ) <sup>2</sup> =	59.5%	14.5%	40.3%	33.6%	52.4%	
(f <sub>c</sub> /F <sub>cE</sub> ) + (f <sub>v</sub> /F <sub>vE</sub> ) <sup>2</sup> =	OK	OK	OK	OK	OK	
(f <sub>c</sub> /F <sub>cE</sub> ) + (f <sub>v</sub> /F <sub>vE</sub> ) <sup>2</sup> =	37.7%	18.3%	33.1%	17.7%	33.1%	
AXIAL P <sub>c</sub> on PL	OK	OK	OK	OK	OK	
P <sub>c,applied</sub> /P <sub>c,allow</sub>	93.1%	45.3%	81.9%	43.8%	81.9%	
AXIAL P <sub>c</sub> on Beam	OK	OK	OK	OK	OK	
P <sub>c,applied</sub> /P <sub>c,allow</sub>	93.1%	45.3%	81.9%	43.8%	81.9%	
DEFLECTION	OK	OK	OK	OK	OK	
D <sub>actual</sub> /D <sub>allowed</sub>	0.0%	0.0%	0.0%	17.9%	13.4%	
Overall Check	OK	OK	OK	OK	OK	

(Table 4a Bending)

(Eq 3.7-1)

(Eq 3.7-1)

(Table 4.3.1)

(Table 4a Compression)

(3.7.1.4) <50

Le = (Ke)L

(Eq 3.7-1)

(Eq 3.7-1)

(Table 4.3.1)

V<sub>allow</sub> = A \* F<sub>v</sub> \* C<sub>D</sub> / 1.5

M<sub>allow</sub> = S \* F<sub>b</sub> \* C<sub>D</sub> \* C<sub>F</sub> \* C<sub>L</sub> \* C<sub>r</sub>

P<sub>allow</sub> = A \* F<sub>c</sub> \* C<sub>D</sub> \* C<sub>F</sub> \* C<sub>P</sub>

(Eq 3.9-3)

(Eq 3.9-4)

P<sub>c,allow</sub> = A \* F<sub>c</sub> \* C<sub>b</sub>

P<sub>c,allow</sub> = A \* F<sub>c</sub>

L / (I \* E / 15 \* L \* M<sub>applied</sub>)

(1.0) \* W Table 1604.3(f)

Actual Δ

Axial + Ber

Bearing on

Bearing on



JOB #: 23.007

DESIGNED: MRO

DATE: 05/31/23

PROJECT: Bradley Hts Apartments 2x6 Bearing- 2nd

**STUD WALL DESIGN**

2018 NDS/2018 IBC

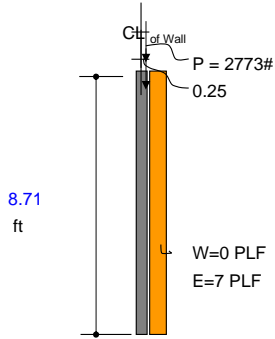

AXIAL LOADS P	
P <sub>DL</sub> (#/ft) =	990
P <sub>SL</sub> (#/ft) =	50
P <sub>LL</sub> (#/ft) =	1,040
P <sub>TOT</sub> (#/ft) =	2,080
e (IN) =	0.5
TRIB. (IN) =	16

LATERAL LOADS W	
W (PSF) =	0.00
E (PSF) =	5.00
TRIB. (IN) =	16

DESIGN VALUES	
F <sub>b</sub> (psi) =	675
F <sub>v</sub> (psi) =	150
F <sub>c</sub> (psi) =	800
F <sub>cL</sub> (psi) =	405
E (psi) =	1.20E+06
E <sub>min</sub> (psi) =	4.40E+05
C <sub>r</sub> =	1.15
L <sub>u</sub> (in) =	104.5
c =	0.8
K <sub>e</sub> =	1
C <sub>b</sub> =	1.00

Hem Fir	▼
Stud Grade	▼
Bending X-X axis	▼
	405
Incised, No	▼
Wet Use, No	▼
Repetitive, Yes	▼
Full Bracing, Yes	▼
(Sawn Lumber)	
(Appendix G)	
(Bearing Area Factor)	

Bearing wall Fire rated? No  
 Fire Retardant FirePRO? No  
 Header Bearing Area (in<sup>2</sup>) = 8.25

Use: (1) 2" X 6" @ 16" O.C. OK

405 = F<sub>cL</sub> (psi)

MEMBER SIZE		SECTION PROPERTIES			
QUANTITY	1	A =	8.25 in <sup>2</sup>		
b =	1.5 in	S =	7.56 in <sup>3</sup>		
d =	5.5 in	I =	20.80 in <sup>4</sup>		
	(Eq. 16-9)	(Eq. 16-10)	(Eq. 16-11)	(Eq. 16-12)	(Eq. 16-13)
LOAD CASES	DL + LL	DL + SL	DL+0.75(LL+SL)	DL + E	DL+0.75(LL+SL+E)
L <sub>u</sub> (ft) =	8.708	8.708	8.708	8.708	8.708
V <sub>applied</sub> (#) =	13	7	12	35	33
M <sub>applied</sub> (ft-#) =	56	29	50	94	103
P <sub>applied</sub> (#) =	2707	1387	2410	1320	2410
C <sub>D</sub> =	1	1.15	1.15	1.6	1.6
BENDING STRESS CALCS	F <sub>bE</sub> (psi) = 17476			C <sub>bF</sub> = 1	
F <sub>b</sub> * (psi) =	776	893	893	1242	1242
C <sub>L</sub> =	1.000	1.000	1.000	1.000	1.000
F <sub>b</sub> ' (psi) =	776	893	893	1242	1242
AXIAL STRESS CALCS	F <sub>cE</sub> = 1002			C <sub>cF</sub> = 1	
L <sub>e</sub> /d =	19.00	19.00	19.00	19.00	19.00
F <sub>c</sub> * (psi) =	800	920	920	1280	1280
C <sub>P</sub> =	0.7626	0.7196	0.7196	0.6013	0.6013
F <sub>c</sub> ' (psi) =	610	662	662	770	770
ALLOWABLES	DL + LL	DL + SL	DL+0.75(LL+SL)	DL + E	DL+0.75(LL+SL+E)
V <sub>allow</sub> (#) =	825	949	949	1320	1320
M <sub>allow</sub> (ft - #) =	489	563	563	783	783
P <sub>allow</sub> (#) =	5,033	5,462	5,462	6,350	6,350
(f <sub>v</sub> /F <sub>v</sub> ) <sup>2</sup> + f <sub>v</sub> /(F <sub>v</sub> (1-(f <sub>v</sub> /F <sub>vE</sub> ))) =	0.46	0.13	0.32	0.19	0.33
(f <sub>v</sub> /F <sub>vE</sub> ) <sup>2</sup> + (f <sub>v</sub> /F <sub>vE</sub> ) =	0.33	0.17	0.29	0.16	0.29
P <sub>c,allow</sub> on PL (#) =	3,341	3,341	3,341	3,341	3,341
P <sub>c,allow</sub> on Beam (#) =	3,341	3,341	3,341	3,341	3,341
Deflection L/	NA	NA	NA	L/3023	L/4031
240	0.00	0.00	0.00	0.03	0.03
CHECKS	DL + LL	DL + SL	DL+0.75(LL+SL)	DL + E	DL+0.75(LL+SL+E)
SHEAR V	OK	OK	OK	OK	OK
V <sub>applied</sub> /V <sub>allow</sub>	1.6%	0.7%	1.2%	2.7%	2.5%
MOMENT M	OK	OK	OK	OK	OK
M <sub>applied</sub> /M <sub>allow</sub>	11.5%	5.1%	8.9%	12.1%	13.1%
AXIAL P	OK	OK	OK	OK	OK
P <sub>applied</sub> /P <sub>allow</sub>	53.8%	25.4%	44.1%	20.8%	38.0%
(f <sub>v</sub> /F <sub>v</sub> ) <sup>2</sup> + f <sub>v</sub> /(F <sub>v</sub> (1-(f <sub>v</sub> /F <sub>vE</sub> ))) =	OK	OK	OK	OK	OK
(f <sub>v</sub> /F <sub>vE</sub> ) <sup>2</sup> + f <sub>v</sub> /(F <sub>v</sub> (1-(f <sub>v</sub> /F <sub>vE</sub> ))) =	46.1%	12.6%	32.1%	18.7%	32.9%
(f <sub>v</sub> /F <sub>vE</sub> ) + (f <sub>v</sub> /F <sub>vE</sub> ) <sup>2</sup>	OK	OK	OK	OK	OK
(f <sub>v</sub> /F <sub>vE</sub> ) + (f <sub>v</sub> /F <sub>vE</sub> ) <sup>2</sup>	32.7%	16.8%	29.2%	16.0%	29.2%
AXIAL P <sub>c</sub> on PL	OK	OK	OK	OK	OK
P <sub>c,applied</sub> /P <sub>c,allow</sub>	81.0%	41.5%	72.1%	39.5%	72.1%
AXIAL P <sub>c</sub> on Beam	OK	OK	OK	OK	OK
P <sub>c,applied</sub> /P <sub>c,allow</sub>	81.0%	41.5%	72.1%	39.5%	72.1%
DEFLECTION	OK	OK	OK	OK	OK
D <sub>actual</sub> /D <sub>allowed</sub>	0.0%	0.0%	0.0%	7.9%	6.0%
Overall Check	OK	OK	OK	OK	OK

(Table 4a Bending)

(Eq 3.7-1)

(Eq 3.7-1)

(Table 4.3.1)

(Table 4a Compression)

(3.7.1.4) <50

Le = (Ke)L

(Eq 3.7-1)

(Eq 3.7-1)

(Table 4.3.1)

V<sub>allow</sub> = A \* F<sub>v</sub> \* C<sub>D</sub> / 1.5

M<sub>allow</sub> = S \* F<sub>b</sub> \* C<sub>b</sub> \* C<sub>F</sub> \* C<sub>L</sub> \* C<sub>r</sub>

P<sub>allow</sub> = A \* F<sub>c</sub> \* C<sub>D</sub> \* C<sub>F</sub> \* C<sub>P</sub>

(Eq 3.9-3)

(Eq 3.9-4)

P<sub>c,allow</sub> = A \* F<sub>c</sub> \* C<sub>b</sub>

P<sub>c,allow</sub> = A \* F<sub>c</sub>

L / (I \* E / 15 \* L \* M<sub>applied</sub>)

(1.0) \* E Table 1604.3(f)

Actual Δ

Axial + Ber

Bearing on

Bearing on



JOB #: 23.007

DESIGNED: MRO

DATE: 05/31/23

PROJECT: Bradley Hts Apartments 2x6 Bearing- 1st

**STUD WALL DESIGN**

2018 NDS/2018 IBC

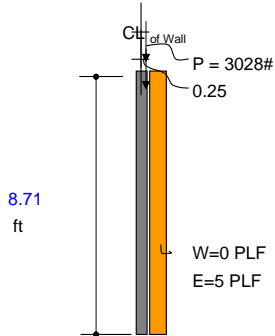

AXIAL LOADS P	
P <sub>DL</sub> (#/ft) =	1,418
P <sub>SL</sub> (#/ft) =	50
P <sub>LL</sub> (#/ft) =	1,560
P <sub>TOT</sub> (#/ft) =	3,028
e (IN) =	0.5
TRIB. (IN) =	12

LATERAL LOADS W	
W (PSF) =	0.00
E (PSF) =	5.00
TRIB. (IN) =	12

DESIGN VALUES	
F <sub>b</sub> (psi) =	675
F <sub>v</sub> (psi) =	150
F <sub>c</sub> (psi) =	800
F <sub>cL</sub> (psi) =	405
E (psi) =	1.20E+06
E <sub>min</sub> (psi) =	4.40E+05
C <sub>r</sub> =	1.15
L <sub>u</sub> (in) =	104.5
c =	0.8
K <sub>e</sub> =	1
C <sub>b</sub> =	1.00

Hem Fir	▼
Stud Grade	▼
Bending X-X axis	▼
	405
Incised, No	▼
Wet Use, No	▼
Repetitive, Yes	▼
Full Bracing, Yes	▼
(Sawn Lumber)	
(Appendix G)	
(Bearing Area Factor)	

Bearing wall Fire rated? No  
 Fire Retardant FirePRO? No  
 Header Bearing Area (in<sup>2</sup>) = 8.25

Use: (1) 2" X 6" @ 12" O.C. OK

405 = F<sub>cL</sub> (psi)

MEMBER SIZE		SECTION PROPERTIES					
QUANTITY	1	A =	8.25 in <sup>2</sup>				
b =	1.5 in	S =	7.56 in <sup>3</sup>				
d =	5.5 in	I =	20.80 in <sup>4</sup>				
	(Eq. 16-9)	(Eq. 16-10)	(Eq. 16-11)	(Eq. 16-12)	(Eq. 16-13)		
LOAD CASES	DL + LL	DL + SL	DL+0.75(LL+SL)	DL + E	DL+0.75(LL+SL+E)		
L <sub>u</sub> (ft) =	8.708	8.708	8.708	8.708	8.708		
V <sub>applied</sub> (#) =	14	7	13	29	29		
M <sub>applied</sub> (ft-#) =	62	31	55	80	94		
P <sub>applied</sub> (#) =	2978	1468	2626	1418	2626		
C <sub>D</sub> =	1	1.15	1.15	1.6	1.6		
BENDING STRESS CALCS		F <sub>bE</sub> (psi) = 17476			C <sub>bF</sub> = 1		(Table 4a Bending)
F <sub>b</sub> * (psi) =	776	893	893	1242	1242	(Eq 3.7-1)	
C <sub>L</sub> =	1.000	1.000	1.000	1.000	1.000	(Eq 3.7-1)	
F <sub>b</sub> ' (psi) =	776	893	893	1242	1242	(Table 4.3.1)	
AXIAL STRESS CALCS		F <sub>cE</sub> = 1002			C <sub>cF</sub> = 1		(Table 4a Compression)
L <sub>e</sub> /d =	19.00	19.00	19.00	19.00	19.00	(3.7.1.4) <50	
F <sub>c</sub> * (psi) =	800	920	920	1280	1280	(Eq 3.7-1)	
C <sub>P</sub> =	0.7626	0.7196	0.7196	0.6013	0.6013	(Eq 3.7-1)	
F <sub>c</sub> ' (psi) =	610	662	662	770	770	(Table 4.3.1)	
ALLOWABLES	DL + LL	DL + SL	DL+0.75(LL+SL)	DL + E	DL+0.75(LL+SL+E)		
V <sub>allow</sub> (#) =	825	949	949	1320	1320	V <sub>allow</sub> = A * F <sub>v</sub> * C <sub>D</sub> / 1.5	
M <sub>allow</sub> (ft - #) =	489	563	563	783	783	M <sub>allow</sub> = S * F <sub>b</sub> * C <sub>b</sub> * C <sub>F</sub> * C <sub>L</sub> * C <sub>r</sub>	
P <sub>allow</sub> (#) =	5,033	5,462	5,462	6,350	6,350	P <sub>allow</sub> = A * F <sub>c</sub> * C <sub>D</sub> * C <sub>F</sub> * C <sub>P</sub>	
(f <sub>v</sub> /F <sub>v</sub> ) <sup>2</sup> + f <sub>v</sub> /(F <sub>b</sub> (1-(f <sub>v</sub> /F <sub>bE</sub> ))) =	0.55	0.14	0.37	0.17	0.35	(Eq 3.9-3)	
(f <sub>v</sub> /F <sub>vE</sub> ) <sup>2</sup> + (f <sub>v</sub> /F <sub>bE</sub> ) <sup>2</sup> =	0.36	0.18	0.32	0.17	0.32	(Eq 3.9-4)	
P <sub>c,allow</sub> on PL (#) =	3,341	3,341	3,341	3,341	3,341	P <sub>c,allow</sub> = A * F <sub>c</sub> * C <sub>b</sub>	
P <sub>c,allow</sub> on Beam (#) =	3,341	3,341	3,341	3,341	3,341	P <sub>c,allow</sub> = A * F <sub>c</sub>	
Deflection L/	NA	NA	NA	L/4031	L/5375	L/(I * E / 15 * L * M <sub>applied</sub> )	
240	0.00	0.00	0.00	0.03	0.02	(1.0) * E Table 1604.3(f)	
CHECKS	DL + LL	DL + SL	DL+0.75(LL+SL)	DL + E	DL+0.75(LL+SL+E)	Actual Δ	
SHEAR V	OK	OK	OK	OK	OK		
V <sub>applied</sub> /V <sub>allow</sub>	1.7%	0.7%	1.3%	2.2%	2.2%		
MOMENT M	OK	OK	OK	OK	OK		
M <sub>applied</sub> /M <sub>allow</sub>	12.7%	5.4%	9.7%	10.2%	12.1%		
AXIAL P	OK	OK	OK	OK	OK		
P <sub>applied</sub> /P <sub>allow</sub>	59.2%	26.9%	48.1%	22.3%	41.3%		
(f <sub>v</sub> /F <sub>v</sub> ) <sup>2</sup> + f <sub>v</sub> /(F <sub>b</sub> (1-(f <sub>v</sub> /F <sub>bE</sub> ))) =	OK	OK	OK	OK	OK		
(f <sub>v</sub> /F <sub>vE</sub> ) <sup>2</sup> + f <sub>v</sub> /(F <sub>b</sub> (1-(f <sub>v</sub> /F <sub>bE</sub> ))) =	54.8%	13.8%	37.4%	17.3%	34.8%	Axial + Ber	
(f <sub>v</sub> /F <sub>bE</sub> ) + (f <sub>v</sub> /F <sub>bE</sub> ) <sup>2</sup> =	OK	OK	OK	OK	OK		
(f <sub>v</sub> /F <sub>bE</sub> ) + (f <sub>v</sub> /F <sub>bE</sub> ) <sup>2</sup> =	36.0%	17.8%	31.8%	17.2%	31.8%		
AXIAL P <sub>c</sub> on PL	OK	OK	OK	OK	OK		
P <sub>c,applied</sub> /P <sub>c,allow</sub>	89.1%	43.9%	78.6%	42.4%	78.6%	Bearing on	
AXIAL P <sub>c</sub> on Beam	OK	OK	OK	OK	OK		
P <sub>c,applied</sub> /P <sub>c,allow</sub>	89.1%	43.9%	78.6%	42.4%	78.6%	Bearing on	
DEFLECTION	OK	OK	OK	OK	OK		
D <sub>actual</sub> /D <sub>allowed</sub>	0.0%	0.0%	0.0%	6.0%	4.5%		
Overall Check	OK	OK	OK	OK	OK		

PRMU20240280 BLDG G



JOB #: 23.007

DESIGNED: MRO

DATE: 05/31/23

PROJECT: Bradley Hts Apartments 2x4 Bearing- 3rd

**STUD WALL DESIGN**

2018 NDS/2018 IBC

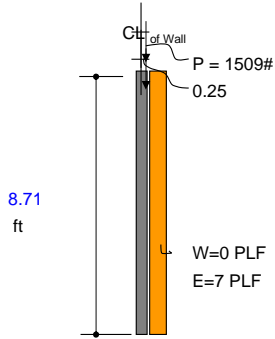

AXIAL LOADS P	
P <sub>DL</sub> (#/ft) =	562
P <sub>SL</sub> (#/ft) =	50
P <sub>LL</sub> (#/ft) =	520
P <sub>TOT</sub> (#/ft) =	1,132
e (IN) =	0.5
TRIB. (IN) =	16

LATERAL LOADS W	
W (PSF) =	0.00
E (PSF) =	5.00
TRIB. (IN) =	16

DESIGN VALUES	
F <sub>b</sub> (psi) =	850
F <sub>v</sub> (psi) =	150
F <sub>c</sub> (psi) =	1300
F <sub>cL</sub> (psi) =	405
E (psi) =	1.30E+06
E <sub>min</sub> (psi) =	4.70E+05
C <sub>r</sub> =	1.15
L <sub>u</sub> (in) =	104.5
c =	0.8
K <sub>e</sub> =	1
C <sub>b</sub> =	1.00

Hem Fir	▼
#2	▼
Bending X-X axis	▼
405	▼
Incised, No	▼
Wet Use, No	▼
Repetitive, Yes	▼
Full Bracing, Yes	▼
(Sawn Lumber)	
(Appendix G)	
(Bearing Area Factor)	

Bearing wall Fire rated? No  
 Fire Retardant FirePRO? No  
 Header Bearing Area (in<sup>2</sup>) = 5.25

Use: (1) 2" X 4" @ 16" O.C. OK

405 = F<sub>cL</sub> (psi)

MEMBER SIZE		SECTION PROPERTIES				
QUANTITY	1	A =	5.25 in <sup>2</sup>			
b =	1.5 in	S =	3.06 in <sup>3</sup>			
d =	3.5 in	I =	5.36 in <sup>4</sup>			
	(Eq. 16-9)	(Eq. 16-10)	(Eq. 16-11)	(Eq. 16-12)	(Eq. 16-13)	
LOAD CASES	DL + LL	DL + SL	DL+0.75(LL+SL)	DL + E	DL+0.75(LL+SL+E)	
L <sub>u</sub> (ft) =	8.708	8.708	8.708	8.708	8.708	
V <sub>applied</sub> (#) =	7	4	6	33	28	
M <sub>applied</sub> (ft-#) =	30	17	27	87	85	
P <sub>applied</sub> (#) =	1443	816	1319	749	1319	
C <sub>D</sub> =	1	1.15	1.15	1.6	1.6	
BENDING STRESS CALCS		F <sub>bE</sub> (psi) = 29334			C <sub>bF</sub> = 1.5	
F <sub>b</sub> <sup>*</sup> (psi) =	1466	1686	1686	2346	2346	(Table 4a Bending)
C <sub>L</sub> =	1.000	1.000	1.000	1.000	1.000	(Eq 3.7-1)
F <sub>b</sub> ' (psi) =	1466	1686	1686	2346	2346	(Table 4.3.1)
AXIAL STRESS CALCS		F <sub>cE</sub> = 433			C <sub>cF</sub> = 1.15	
L <sub>e</sub> /d =	29.86	29.86	29.86	29.86	29.86	(3.7.1.4) <50
F <sub>c</sub> <sup>*</sup> (psi) =	1495	1719	1719	2392	2392	(Eq 3.7-1)
C <sub>P</sub> =	0.2699	0.2373	0.2373	0.1739	0.1739	(Eq 3.7-1)
F <sub>c</sub> ' (psi) =	404	408	408	416	416	(Table 4.3.1)
ALLOWABLES	DL + LL	DL + SL	DL+0.75(LL+SL)	DL + E	DL+0.75(LL+SL+E)	
V <sub>allow</sub> (#) =	525	604	604	840	840	V <sub>allow</sub> = A * F <sub>v</sub> * C <sub>D</sub> / 1.5
M <sub>allow</sub> (ft - #) =	374	430	430	599	599	M <sub>allow</sub> = S * F <sub>b</sub> ' * C <sub>b</sub> * C <sub>F</sub> * C <sub>L</sub> * C <sub>r</sub>
P <sub>allow</sub> (#) =	2,119	2,142	2,142	2,183	2,183	P <sub>allow</sub> = A * F <sub>c</sub> ' * C <sub>D</sub> * C <sub>F</sub> * C <sub>P</sub>
(f <sub>t</sub> /F <sub>c</sub> ) <sup>2</sup> + f <sub>t</sub> /(F <sub>b</sub> (1-f <sub>t</sub> /F <sub>cE</sub> )) =	0.68	0.21	0.53	0.33	0.70	(Eq 3.9-3)
(f <sub>t</sub> /F <sub>cE</sub> ) <sup>2</sup> + (f <sub>t</sub> /F <sub>bE</sub> ) <sup>2</sup> =	0.63	0.36	0.58	0.33	0.58	(Eq 3.9-4)
P <sub>c,allow</sub> on PL (#) =	2,126	2,126	2,126	2,126	2,126	P <sub>c,allow</sub> = A * F <sub>c</sub> ' * C <sub>b</sub>
P <sub>c,L,allow</sub> on Beam (#) =	2,126	2,126	2,126	2,126	2,126	P <sub>c,L,allow</sub> = A * F <sub>c</sub>
Deflection L/	NA	NA	NA	L/844	L/1125	L/(1 * E / 15 * L * M <sub>applied</sub> )
240	0.00	0.00	0.00	0.12	0.09	(1.0) * E Table 1604.3(f)
CHECKS	DL + LL	DL + SL	DL+0.75(LL+SL)	DL + E	DL+0.75(LL+SL+E)	Actual △
SHEAR V	OK	OK	OK	OK	OK	
V <sub>applied</sub> /V <sub>allow</sub>	1.3%	0.6%	1.0%	3.9%	3.3%	
MOMENT M	OK	OK	OK	OK	OK	
M <sub>applied</sub> /M <sub>allow</sub>	8.0%	4.0%	6.4%	14.5%	14.2%	
AXIAL P	OK	OK	OK	OK	OK	
P <sub>applied</sub> /P <sub>allow</sub>	68.1%	38.1%	61.6%	34.3%	60.4%	
(f <sub>t</sub> /F <sub>c</sub> ) <sup>2</sup> + f <sub>t</sub> /(F <sub>b</sub> (1-f <sub>t</sub> /F <sub>cE</sub> )) =	OK	OK	OK	OK	OK	
(f <sub>t</sub> /F <sub>cE</sub> ) <sup>2</sup> + f <sub>t</sub> /(F <sub>b</sub> (1-f <sub>t</sub> /F <sub>cE</sub> )) =	68.3%	20.7%	53.1%	33.3%	70.3%	Axial + Ber
(f <sub>t</sub> /F <sub>cE</sub> ) + (f <sub>t</sub> /F <sub>bE</sub> ) <sup>2</sup> =	OK	OK	OK	OK	OK	
(f <sub>t</sub> /F <sub>cE</sub> ) + (f <sub>t</sub> /F <sub>bE</sub> ) <sup>2</sup> =	63.4%	35.9%	58.0%	32.9%	58.0%	
AXIAL P <sub>c</sub> on PL	OK	OK	OK	OK	OK	
P <sub>c,applied</sub> /P <sub>c,allow</sub>	67.9%	38.4%	62.0%	35.2%	62.0%	Bearing on
AXIAL P <sub>c</sub> on Beam	OK	OK	OK	OK	OK	
P <sub>c,applied</sub> /P <sub>c,L,allow</sub>	67.9%	38.4%	62.0%	35.2%	62.0%	Bearing on
DEFLECTION	OK	OK	OK	OK	OK	
D <sub>actual</sub> /D <sub>allowed</sub>	0.0%	0.0%	0.0%	28.4%	21.3%	
Overall Check	OK	OK	OK	OK	OK	

PRMU20240280 BLDG G



JOB #: 23.007

DESIGNED: MRO

DATE: 05/31/23

PROJECT: Bradley Hts Apartments 2x4 Bearing- 2nd

**STUD WALL DESIGN**

2018 NDS/2018 IBC

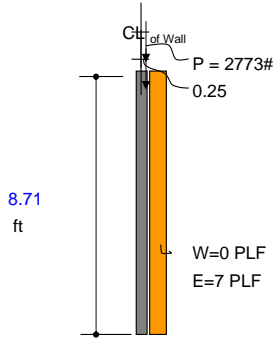

AXIAL LOADS P	
P <sub>DL</sub> (#/ft) =	990
P <sub>SL</sub> (#/ft) =	50
P <sub>LL</sub> (#/ft) =	1,040
P <sub>TOT</sub> (#/ft) =	2,080
e (IN) =	0.5
TRIB. (IN) =	16

LATERAL LOADS W	
W (PSF) =	0.00
E (PSF) =	5.00
TRIB. (IN) =	16

DESIGN VALUES	
F <sub>b</sub> (psi) =	850
F <sub>v</sub> (psi) =	150
F <sub>c</sub> (psi) =	1300
F <sub>cL</sub> (psi) =	405
E (psi) =	1.30E+06
E <sub>min</sub> (psi) =	4.70E+05
C <sub>r</sub> =	1.15
L <sub>u</sub> (in) =	104.5
c =	0.8
K <sub>e</sub> =	1
C <sub>b</sub> =	1.00

Hem Fir	▼
#2	▼
Bending X-X axis	▼
405	▼
Incised, No	▼
Wet Use, No	▼
Repetitive, Yes	▼
Full Bracing, Yes	▼
(Sawn Lumber)	
(Appendix G)	
(Bearing Area Factor)	

Bearing wall Fire rated? No  
 Fire Retardant FirePRO? No  
 Header Bearing Area (in<sup>2</sup>) = 10.5

Use: (2) 2" X 4" @ 16" O.C. OK

405 = F<sub>cL</sub> (psi)

MEMBER SIZE		SECTION PROPERTIES				
QUANTITY	2	A = 10.50 in <sup>2</sup>				
b =	1.5 in	S = 6.13 in <sup>3</sup>				
d =	3.5 in	I = 10.72 in <sup>4</sup>				
	(Eq. 16-9)	(Eq. 16-10)	(Eq. 16-11)	(Eq. 16-12)	(Eq. 16-13)	
LOAD CASES	DL + LL	DL + SL	DL+0.75(LL+SL)	DL + E	DL+0.75(LL+SL+E)	
L <sub>u</sub> (ft) =	8.708	8.708	8.708	8.708	8.708	
V <sub>applied</sub> (#) =	13	7	12	35	33	
M <sub>applied</sub> (ft-#) =	56	29	50	98	107	
P <sub>applied</sub> (#) =	2707	1387	2410	1320	2410	
C <sub>D</sub> =	1	1.15	1.15	1.6	1.6	
BENDING STRESS CALCS		F <sub>bE</sub> (psi) = 29334			C <sub>bF</sub> = 1.5	
F <sub>b</sub> <sup>*</sup> (psi) =	1466	1686	1686	2346	2346	(Table 4a Bending)
C <sub>L</sub> =	1.000	1.000	1.000	1.000	1.000	(Eq 3.7-1)
F <sub>b</sub> ' (psi) =	1466	1686	1686	2346	2346	(Eq 3.7-1)
						(Table 4.3.1)
AXIAL STRESS CALCS		F <sub>cE</sub> = 433			C <sub>cF</sub> = 1.15	
L <sub>e</sub> /d =	29.86	29.86	29.86	29.86	29.86	(Table 4a Compression)
F <sub>c</sub> <sup>*</sup> (psi) =	1495	1719	1719	2392	2392	(3.7.1.4) <50
C <sub>P</sub> =	0.2699	0.2373	0.2373	0.1739	0.1739	(Eq 3.7-1)
F <sub>c</sub> ' (psi) =	404	408	408	416	416	(Eq 3.7-1)
						(Table 4.3.1)
ALLOWABLES	DL + LL	DL + SL	DL+0.75(LL+SL)	DL + E	DL+0.75(LL+SL+E)	
V <sub>allow</sub> (#) =	1050	1208	1208	1680	1680	V <sub>allow</sub> = A * F <sub>v</sub> * C <sub>D</sub> / 1.5
M <sub>allow</sub> (ft - #) =	748	861	861	1197	1197	M <sub>allow</sub> = S * F <sub>b</sub> * C <sub>b</sub> * C <sub>F</sub> * C <sub>L</sub> * C <sub>r</sub>
P <sub>allow</sub> (#) =	4,237	4,284	4,284	4,367	4,367	P <sub>allow</sub> = A * F <sub>c</sub> * C <sub>D</sub> * C <sub>F</sub> * C <sub>P</sub>
(f <sub>t</sub> /F <sub>c</sub> ) <sup>2</sup> + f <sub>t</sub> /(F <sub>b</sub> (1-f <sub>t</sub> /F <sub>cE</sub> )) =	0.59	0.15	0.44	0.21	0.49	(Eq 3.9-3)
(f <sub>t</sub> /F <sub>cE</sub> ) + (f <sub>t</sub> /F <sub>bE</sub> ) <sup>2</sup> =	0.59	0.30	0.53	0.29	0.53	(Eq 3.9-4)
P <sub>c,allow</sub> on PL (#) =	4,253	4,253	4,253	4,253	4,253	P <sub>c,allow</sub> = A * F <sub>c</sub> * C <sub>b</sub>
P <sub>c,allow</sub> on Beam (#) =	4,253	4,253	4,253	4,253	4,253	P <sub>c,allow</sub> = A * F <sub>c</sub>
Deflection L/	NA	NA	NA	L/1688	L/2251	L/(1 * E / 15 * L * M <sub>applied</sub> )
240	0.00	0.00	0.00	0.06	0.05	(1.0) * E Table 1604.3(f)
CHECKS	DL + LL	DL + SL	DL+0.75(LL+SL)	DL + E	DL+0.75(LL+SL+E)	Actual △
SHEAR V	OK	OK	OK	OK	OK	
V <sub>applied</sub> /V <sub>allow</sub>	1.2%	0.5%	1.0%	2.1%	2.0%	
MOMENT M	OK	OK	OK	OK	OK	
M <sub>applied</sub> /M <sub>allow</sub>	7.5%	3.4%	5.8%	8.1%	8.9%	
AXIAL P	OK	OK	OK	OK	OK	
P <sub>applied</sub> /P <sub>allow</sub>	63.9%	32.4%	56.3%	30.2%	55.2%	
(f <sub>t</sub> /F <sub>c</sub> ) <sup>2</sup> + f <sub>t</sub> /(F <sub>b</sub> (1-f <sub>t</sub> /F <sub>cE</sub> )) =	OK	OK	OK	OK	OK	
(f <sub>t</sub> /F <sub>cE</sub> ) + (f <sub>t</sub> /F <sub>b</sub> (1-f <sub>t</sub> /F <sub>cE</sub> )) =	59.4%	15.3%	44.0%	20.6%	49.4%	Axial + Ber
(f <sub>t</sub> /F <sub>cE</sub> ) + (f <sub>t</sub> /F <sub>bE</sub> ) <sup>2</sup> =	OK	OK	OK	OK	OK	
(f <sub>t</sub> /F <sub>cE</sub> ) + (f <sub>t</sub> /F <sub>bE</sub> ) <sup>2</sup> =	59.5%	30.5%	53.0%	29.0%	53.0%	
AXIAL P <sub>c</sub> on PL	OK	OK	OK	OK	OK	
P <sub>c,applied</sub> /P <sub>c,allow</sub>	63.6%	32.6%	56.7%	31.0%	56.7%	Bearing on
AXIAL P <sub>c</sub> on Beam	OK	OK	OK	OK	OK	
P <sub>c,applied</sub> /P <sub>c,allow</sub>	63.6%	32.6%	56.7%	31.0%	56.7%	Bearing on
DEFLECTION	OK	OK	OK	OK	OK	
D <sub>actual</sub> /D <sub>allowed</sub>	0.0%	0.0%	0.0%	14.2%	10.7%	
Overall Check	OK	OK	OK	OK	OK	

PRMU20240280 BLDG G



JOB #: 23.007

DESIGNED: MRO

DATE: 05/31/23

PROJECT: Bradley Hts Apartments 2x4 Bearing- 1st

**STUD WALL DESIGN**

2018 NDS/2018 IBC

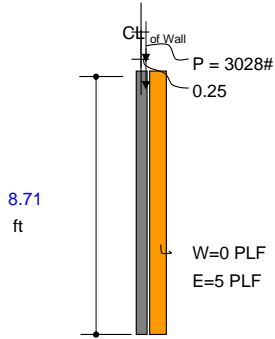

AXIAL LOADS P	
P <sub>DL</sub> (#/ft) =	1,418
P <sub>SL</sub> (#/ft) =	50
P <sub>LL</sub> (#/ft) =	1,560
P <sub>TOT</sub> (#/ft) =	3,028
e (IN) =	0.5
TRIB. (IN) =	12

LATERAL LOADS W	
W (PSF) =	0.00
E (PSF) =	5.00
TRIB. (IN) =	12

DESIGN VALUES	
F <sub>b</sub> (psi) =	850
F <sub>v</sub> (psi) =	150
F <sub>c</sub> (psi) =	1300
F <sub>cL</sub> (psi) =	405
E (psi) =	1.30E+06
E <sub>min</sub> (psi) =	4.70E+05
C <sub>r</sub> =	1.15
L <sub>u</sub> (in) =	104.5
c =	0.8
K <sub>e</sub> =	1
C <sub>b</sub> =	1.00

Hem Fir	▼
#2	▼
Bending X-X axis	▼
405	405
Incised, No	▼
Wet Use, No	▼
Repetitive, Yes	▼
Full Bracing, Yes	▼
(Sawn Lumber)	
(Appendix G)	
(Bearing Area Factor)	

Bearing wall Fire rated? No  
 Fire Retardant FirePRO? No  
 Header Bearing Area (in<sup>2</sup>) = 10.5

Use: (2) 2" X 4" @ 12" O.C. OK

405 = F<sub>cL</sub> (psi)

MEMBER SIZE		SECTION PROPERTIES				
QUANTITY	2	A =	10.50 in <sup>2</sup>			
b =	1.5 in	S =	6.13 in <sup>3</sup>			
d =	3.5 in	I =	10.72 in <sup>4</sup>			
	(Eq. 16-9)	(Eq. 16-10)	(Eq. 16-11)	(Eq. 16-12)	(Eq. 16-13)	
LOAD CASES	DL + LL	DL + SL	DL+0.75(LL+SL)	DL + E	DL+0.75(LL+SL+E)	
L <sub>u</sub> (ft) =	8.708	8.708	8.708	8.708	8.708	
V <sub>applied</sub> (#) =	14	7	13	29	29	
M <sub>applied</sub> (ft-#) =	62	31	55	82	98	
P <sub>applied</sub> (#) =	2978	1468	2626	1418	2626	
C <sub>D</sub> =	1	1.15	1.15	1.6	1.6	
BENDING STRESS CALCS		F <sub>bE</sub> (psi) = 29334			C <sub>bF</sub> = 1.5	
F <sub>b</sub> * (psi) =	1466	1686	1686	2346	2346	(Table 4a Bending)
C <sub>L</sub> =	1.000	1.000	1.000	1.000	1.000	(Eq 3.7-1)
F <sub>b</sub> ' (psi) =	1466	1686	1686	2346	2346	(Table 4.3.1)
AXIAL STRESS CALCS		F <sub>cE</sub> = 433			C <sub>cF</sub> = 1.15	
L <sub>e</sub> /d =	29.86	29.86	29.86	29.86	29.86	(3.7.1.4) <50
F <sub>c</sub> * (psi) =	1495	1719	1719	2392	2392	(Eq 3.7-1)
C <sub>P</sub> =	0.2699	0.2373	0.2373	0.1739	0.1739	(Eq 3.7-1)
F <sub>c</sub> ' (psi) =	404	408	408	416	416	(Table 4.3.1)
ALLOWABLES	DL + LL	DL + SL	DL+0.75(LL+SL)	DL + E	DL+0.75(LL+SL+E)	
V <sub>allow</sub> (#) =	1050	1208	1208	1680	1680	V <sub>allow</sub> = A * F <sub>v</sub> * C <sub>D</sub> / 1.5
M <sub>allow</sub> (ft - #) =	748	861	861	1197	1197	M <sub>allow</sub> = S * F <sub>b</sub> * C <sub>b</sub> * C <sub>F</sub> * C <sub>L</sub> * C <sub>r</sub>
P <sub>allow</sub> (#) =	4,237	4,284	4,284	4,367	4,367	P <sub>allow</sub> = A * F <sub>c</sub> * C <sub>D</sub> * C <sub>F</sub> * C <sub>P</sub>
(f <sub>t</sub> /F <sub>c</sub> ) <sup>2</sup> + f <sub>t</sub> /(F <sub>b</sub> (1-f <sub>t</sub> /F <sub>cE</sub> )) =	0.73	0.17	0.53	0.21	0.55	(Eq 3.9-3)
(f <sub>t</sub> /F <sub>cE</sub> ) <sup>2</sup> + (f <sub>t</sub> /F <sub>bE</sub> ) <sup>2</sup> =	0.65	0.32	0.58	0.31	0.58	(Eq 3.9-4)
P <sub>c,allow</sub> on PL (#) =	4,253	4,253	4,253	4,253	4,253	P <sub>c,allow</sub> = A * F <sub>c</sub> * C <sub>b</sub>
P <sub>c,allow</sub> on Beam (#) =	4,253	4,253	4,253	4,253	4,253	P <sub>c,allow</sub> = A * F <sub>c</sub>
Deflection L/	NA	NA	NA	L/2251	L/3001	L/(I * E / 15 * L * M <sub>applied</sub> )
240	0.00	0.00	0.00	0.05	0.03	(1.0) * E Table 1604.3(f)
CHECKS	DL + LL	DL + SL	DL+0.75(LL+SL)	DL + E	DL+0.75(LL+SL+E)	Actual Δ
SHEAR V	OK	OK	OK	OK	OK	
V <sub>applied</sub> /V <sub>allow</sub>	1.4%	0.6%	1.0%	1.7%	1.7%	
MOMENT M	OK	OK	OK	OK	OK	
M <sub>applied</sub> /M <sub>allow</sub>	8.3%	3.6%	6.4%	6.9%	8.2%	
AXIAL P	OK	OK	OK	OK	OK	
P <sub>applied</sub> /P <sub>allow</sub>	70.3%	34.3%	61.3%	32.5%	60.1%	
(f <sub>t</sub> /F <sub>c</sub> ) <sup>2</sup> + f <sub>t</sub> /(F <sub>b</sub> (1-f <sub>t</sub> /F <sub>cE</sub> )) =	OK	OK	OK	OK	OK	
(f <sub>t</sub> /F <sub>cE</sub> ) <sup>2</sup> + f <sub>t</sub> /(F <sub>b</sub> (1-f <sub>t</sub> /F <sub>cE</sub> )) =	73.4%	17.0%	52.6%	20.5%	55.5%	Axial + Ber
(f <sub>t</sub> /F <sub>cE</sub> ) <sup>2</sup> + (f <sub>t</sub> /F <sub>bE</sub> ) <sup>2</sup> =	OK	OK	OK	OK	OK	
(f <sub>t</sub> /F <sub>cE</sub> ) <sup>2</sup> + (f <sub>t</sub> /F <sub>bE</sub> ) <sup>2</sup> =	65.4%	32.3%	57.7%	31.2%	57.7%	
AXIAL P <sub>c</sub> on PL	OK	OK	OK	OK	OK	
P <sub>c,applied</sub> /P <sub>c,allow</sub>	70.0%	34.5%	61.7%	33.3%	61.7%	Bearing on
AXIAL P <sub>c</sub> on Beam	OK	OK	OK	OK	OK	
P <sub>c,applied</sub> /P <sub>c,allow</sub>	70.0%	34.5%	61.7%	33.3%	61.7%	Bearing on
DEFLECTION	OK	OK	OK	OK	OK	
D <sub>actual</sub> /D <sub>allowed</sub>	0.0%	0.0%	0.0%	10.7%	8.0%	
Overall Check	OK	OK	OK	OK	OK	

PRMU20240280 BLDG G



JOB #: 23.007

DESIGNED: MRO

DATE: 05/31/23

PROJECT: Bradley Hts Apartments 2x6 Party - 1st

**STUD WALL DESIGN**

2018 NDS/2018 IBC

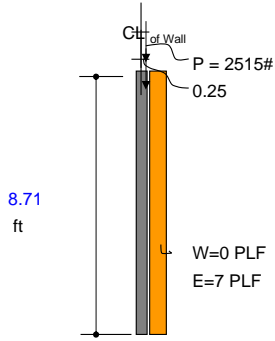

AXIAL LOADS P	
P <sub>DL</sub> (#/ft) =	1,008
P <sub>SL</sub> (#/ft) =	338
P <sub>LL</sub> (#/ft) =	540
P <sub>TOT</sub> (#/ft) =	1,886
e (IN) =	0.5
TRIB. (IN) =	16

LATERAL LOADS W	
W (PSF) =	0.00
E (PSF) =	5.00
TRIB. (IN) =	16

DESIGN VALUES	
F <sub>b</sub> (psi) =	675
F <sub>v</sub> (psi) =	150
F <sub>c</sub> (psi) =	800
F <sub>cL</sub> (psi) =	405
E (psi) =	1.20E+06
E <sub>min</sub> (psi) =	4.40E+05
C <sub>r</sub> =	1.15
L <sub>u</sub> (in) =	104.5
c =	0.8
K <sub>e</sub> =	1
C <sub>b</sub> =	1.00

Hem Fir	▼
Stud Grade	▼
Bending X-X axis	▼
	405
Inced, No	▼
Wet Use, No	▼
Repetive, Yes	▼
Full Bracing, Yes	▼
(Sawn Lumber)	
(Appendix G)	
(Bearing Area Factor)	

Bearing wall Fire rated? No  
 Fire Retardant FirePRO? No  
 Header Bearing Area (in<sup>2</sup>) = 8.25

Use: (1) 2" X 6" @ 16" O.C. OK

8.25      405 = F<sub>cL</sub> (psi)

MEMBER SIZE		SECTION PROPERTIES				
QUANTITY	1	A =	8.25 in <sup>2</sup>			
b =	1.5 in	S =	7.56 in <sup>3</sup>			
d =	5.5 in	I =	20.80 in <sup>4</sup>			
	(Eq. 16-9)	(Eq. 16-10)	(Eq. 16-11)	(Eq. 16-12)	(Eq. 16-13)	
LOAD CASES	DL + LL	DL + SL	DL+0.75(LL+SL)	DL + E	DL+0.75(LL+SL+E)	
L <sub>u</sub> (ft) =	8.708	8.708	8.708	8.708	8.708	
V <sub>applied</sub> (#) =	10	9	11	35	32	
M <sub>applied</sub> (ft-#) =	43	37	46	95	98	
P <sub>applied</sub> (#) =	2064	1795	2222	1344	2222	
C <sub>D</sub> =	1	1.15	1.15	1.6	1.6	
BENDING STRESS CALCS		F <sub>bE</sub> (psi) = 17476			C <sub>bF</sub> = 1	
F <sub>b</sub> * (psi) =	776	893	893	1242	1242	(Table 4a Bending)
C <sub>L</sub> =	1.000	1.000	1.000	1.000	1.000	(Eq 3.7-1)
F <sub>b</sub> ' (psi) =	776	893	893	1242	1242	(Eq 3.7-1)
						(Table 4.3.1)
AXIAL STRESS CALCS		F <sub>cE</sub> = 1002			C <sub>cF</sub> = 1	
L <sub>e</sub> /d =	19.00	19.00	19.00	19.00	19.00	(Table 4a Compression)
F <sub>c</sub> * (psi) =	800	920	920	1280	1280	(3.7.1.4) <50
C <sub>P</sub> =	0.7626	0.7196	0.7196	0.6013	0.6013	(Eq 3.7-1)
F <sub>c</sub> ' (psi) =	610	662	662	770	770	(Eq 3.7-1)
						(Table 4.3.1)
ALLOWABLES	DL + LL	DL + SL	DL+0.75(LL+SL)	DL + E	DL+0.75(LL+SL+E)	
V <sub>allow</sub> (#) =	825	949	949	1320	1320	V <sub>allow</sub> = A * F <sub>v</sub> * C <sub>D</sub> / 1.5
M <sub>allow</sub> (ft - #) =	489	563	563	783	783	M <sub>allow</sub> = S * F <sub>b</sub> * C <sub>b</sub> * C <sub>F</sub> * C <sub>L</sub> * C <sub>r</sub>
P <sub>allow</sub> (#) =	5,033	5,462	5,462	6,350	6,350	P <sub>allow</sub> = A * F <sub>c</sub> * C <sub>D</sub> * C <sub>F</sub> * C <sub>P</sub>
(f <sub>v</sub> /F <sub>v</sub> ) <sup>2</sup> + f <sub>v</sub> /(F <sub>b</sub> (1-f <sub>v</sub> /F <sub>vE</sub> )) =	0.29	0.19	0.28	0.19	0.29	(Eq 3.9-3)
(f <sub>v</sub> /F <sub>vE</sub> ) <sup>2</sup> + (f <sub>v</sub> /F <sub>bE</sub> ) <sup>2</sup> =	0.25	0.22	0.27	0.16	0.27	(Eq 3.9-4)
P <sub>c,allow</sub> on PL (#) =	3,341	3,341	3,341	3,341	3,341	P <sub>c,allow</sub> = A * F <sub>c</sub> * C <sub>b</sub>
P <sub>c,allow</sub> on Beam (#) =	3,341	3,341	3,341	3,341	3,341	P <sub>c,allow</sub> = A * F <sub>c</sub>
Deflection L/	NA	NA	NA	L/3023	L/4031	L/(I * E / 15 * L * M <sub>applied</sub> )
240	0.00	0.00	0.00	0.03	0.03	(1.0) * E      Table 1604.3(f)
CHECKS	DL + LL	DL + SL	DL+0.75(LL+SL)	DL + E	DL+0.75(LL+SL+E)	Actual △
SHEAR V	OK	OK	OK	OK	OK	
V <sub>applied</sub> /V <sub>allow</sub>	1.2%	0.9%	1.1%	2.7%	2.5%	
MOMENT M	OK	OK	OK	OK	OK	
M <sub>applied</sub> /M <sub>allow</sub>	8.8%	6.6%	8.2%	12.1%	12.6%	
AXIAL P	OK	OK	OK	OK	OK	
P <sub>applied</sub> /P <sub>allow</sub>	41.0%	32.9%	40.7%	21.2%	35.0%	
(f <sub>v</sub> /F <sub>v</sub> ) <sup>2</sup> + f <sub>v</sub> /(F <sub>b</sub> (1-f <sub>v</sub> /F <sub>vE</sub> )) =	OK	OK	OK	OK	OK	
(f <sub>v</sub> /F <sub>vE</sub> ) <sup>2</sup> + f <sub>v</sub> /(F <sub>b</sub> (1-f <sub>v</sub> /F <sub>vE</sub> )) =	28.5%	19.3%	27.8%	19.0%	29.5%	Axial + Ber
(f <sub>v</sub> /F <sub>vE</sub> ) <sup>2</sup> + (f <sub>v</sub> /F <sub>bE</sub> ) <sup>2</sup> =	OK	OK	OK	OK	OK	
(f <sub>v</sub> /F <sub>vE</sub> ) <sup>2</sup> + (f <sub>v</sub> /F <sub>bE</sub> ) <sup>2</sup> =	25.0%	21.7%	26.9%	16.3%	26.9%	
AXIAL P <sub>c</sub> on PL	OK	OK	OK	OK	OK	
P <sub>c,applied</sub> /P <sub>c,allow</sub>	61.8%	53.7%	66.5%	40.2%	66.5%	Bearing on
AXIAL P <sub>c</sub> on Beam	OK	OK	OK	OK	OK	
P <sub>c,applied</sub> /P <sub>c,allow</sub>	61.8%	53.7%	66.5%	40.2%	66.5%	Bearing on
DEFLECTION	OK	OK	OK	OK	OK	
D <sub>actual</sub> /D <sub>allowed</sub>	0.0%	0.0%	0.0%	7.9%	6.0%	
Overall Check	OK	OK	OK	OK	OK	





JOB #: 23.007

DESIGNED: MRO

DATE: 05/31/23

PROJECT: Bradley Hts Apartments 2x4 Party - 1st

**STUD WALL DESIGN**

2018 NDS/2018 IBC

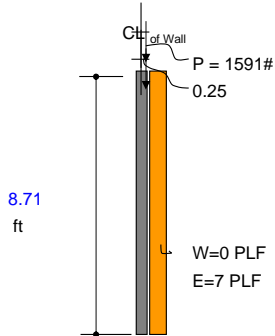

AXIAL LOADS P	
P <sub>DL</sub> (#/ft) =	735
P <sub>SL</sub> (#/ft) =	338
P <sub>LL</sub> (#/ft) =	120
P <sub>TOT</sub> (#/ft) =	1193
e (IN) =	0.5
TRIB. (IN) =	16

LATERAL LOADS W	
W (PSF) =	0.00
E (PSF) =	5.00
TRIB. (IN) =	16

DESIGN VALUES	
F <sub>b</sub> (psi) =	850
F <sub>v</sub> (psi) =	150
F <sub>c</sub> (psi) =	1300
F <sub>cL</sub> (psi) =	405
E (psi) =	1.30E+06
E <sub>min</sub> (psi) =	4.70E+05
C <sub>r</sub> =	1.15
L <sub>u</sub> (in) =	104.5
c =	0.8
K <sub>e</sub> =	1
C <sub>b</sub> =	1.00

Hem Fir	▼
#2	▼
Bending X-X axis	▼
405	▼
Incised, No	▼
Wet Use, No	▼
Repetitive, Yes	▼
Full Bracing, Yes	▼
(Sawn Lumber)	
(Appendix G)	
(Bearing Area Factor)	

Bearing wall Fire rated? No  
 Fire Retardant FirePRO? No  
 Header Bearing Area (in<sup>2</sup>) = 5.25

Use: (1) 2" X 4" @ 16" O.C. OK

405 = F<sub>cL</sub> (psi)

MEMBER SIZE		SECTION PROPERTIES			
QUANTITY	1	A =	5.25 in <sup>2</sup>		
b =	1.5 in	S =	3.06 in <sup>3</sup>		
d =	3.5 in	I =	5.36 in <sup>4</sup>		
	(Eq. 16-9)	(Eq. 16-10)	(Eq. 16-11)	(Eq. 16-12)	(Eq. 16-13)
LOAD CASES	DL + LL	DL + SL	DL+0.75(LL+SL)	DL + E	DL+0.75(LL+SL+E)
L <sub>u</sub> (ft) =	8.708	8.708	8.708	8.708	8.708
V <sub>applied</sub> (#) =	5	7	7	34	29
M <sub>applied</sub> (ft-#) =	24	30	30	94	88
P <sub>applied</sub> (#) =	1140	1431	1438	980	1438
C <sub>D</sub> =	1	1.15	1.15	1.6	1.6
BENDING STRESS CALCS	F <sub>bE</sub> (psi) = 29334			C <sub>DF</sub> = 1.5	
F <sub>b</sub> <sup>*</sup> (psi) =	1466	1686	1686	2346	2346
C <sub>L</sub> =	1.000	1.000	1.000	1.000	1.000
F <sub>b</sub> ' (psi) =	1466	1686	1686	2346	2346
AXIAL STRESS CALCS	F <sub>cE</sub> = 433			C <sub>CF</sub> = 1.15	
L <sub>e</sub> /d =	29.86	29.86	29.86	29.86	29.86
F <sub>c</sub> <sup>*</sup> (psi) =	1495	1719	1719	2392	2392
C <sub>P</sub> =	0.2699	0.2373	0.2373	0.1739	0.1739
F <sub>c</sub> ' (psi) =	404	408	408	416	416
ALLOWABLES	DL + LL	DL + SL	DL+0.75(LL+SL)	DL + E	DL+0.75(LL+SL+E)
V <sub>allow</sub> (#) =	525	604	604	840	840
M <sub>allow</sub> (ft - #) =	374	430	430	599	599
P <sub>allow</sub> (#) =	2,119	2,142	2,142	2,183	2,183
(f <sub>v</sub> /F <sub>v</sub> ) <sup>2</sup> + f <sub>v</sub> /(F <sub>v</sub> (1-(f <sub>v</sub> /F <sub>vE</sub> ))) =	0.42	0.63	0.64	0.48	0.84
(f <sub>v</sub> /F <sub>vE</sub> ) + (f <sub>v</sub> /F <sub>vE</sub> ) <sup>2</sup> =	0.50	0.63	0.63	0.43	0.63
P <sub>c,allow</sub> on PL (#) =	2,126	2,126	2,126	2,126	2,126
P <sub>c,allow</sub> on Beam (#) =	2,126	2,126	2,126	2,126	2,126
Deflection L/	NA	NA	NA	L/844	L/1125
240	0.00	0.00	0.00	0.12	0.09
CHECKS	DL + LL	DL + SL	DL+0.75(LL+SL)	DL + E	DL+0.75(LL+SL+E)
SHEAR V	OK	OK	OK	OK	OK
V <sub>applied</sub> /V <sub>allow</sub>	1.0%	1.1%	1.1%	4.0%	3.4%
MOMENT M	OK	OK	OK	OK	OK
M <sub>applied</sub> /M <sub>allow</sub>	6.3%	6.9%	7.0%	15.7%	14.8%
AXIAL P	OK	OK	OK	OK	OK
P <sub>applied</sub> /P <sub>allow</sub>	53.8%	66.8%	67.1%	44.9%	65.9%
(f <sub>c</sub> /F <sub>c</sub> ) <sup>2</sup> + f <sub>c</sub> /(F <sub>c</sub> (1-(f <sub>c</sub> /F <sub>cE</sub> ))) =	OK	OK	OK	OK	OK
(f <sub>c</sub> /F <sub>cE</sub> ) + (f <sub>c</sub> /F <sub>cE</sub> ) <sup>2</sup> =	41.7%	63.3%	64.0%	47.6%	83.5%
(f <sub>c</sub> /F <sub>cE</sub> ) + (f <sub>v</sub> /F <sub>vE</sub> ) <sup>2</sup> =	OK	OK	OK	OK	OK
(f <sub>c</sub> /F <sub>cE</sub> ) + (f <sub>v</sub> /F <sub>vE</sub> ) <sup>2</sup> =	50.1%	62.9%	63.2%	43.1%	63.2%
AXIAL P <sub>c</sub> on PL	OK	OK	OK	OK	OK
P <sub>c,applied</sub> /P <sub>c,allow</sub>	53.6%	67.3%	67.6%	46.1%	67.6%
AXIAL P <sub>c</sub> on Beam	OK	OK	OK	OK	OK
P <sub>c,applied</sub> /P <sub>c,allow</sub>	53.6%	67.3%	67.6%	46.1%	67.6%
DEFLECTION	OK	OK	OK	OK	OK
D <sub>actual</sub> /D <sub>allowed</sub>	0.0%	0.0%	0.0%	28.4%	21.3%
Overall Check	OK	OK	OK	OK	OK

(Table 4a Bending)

(Eq 3.7-1)

(Eq 3.7-1)

(Table 4.3.1)

(Table 4a Compression)

(3.7.1.4) <50

Le = (Ke)L

(Eq 3.7-1)

(Eq 3.7-1)

(Table 4.3.1)

V<sub>allow</sub> = A \* F<sub>v</sub> \* C<sub>D</sub> / 1.5

M<sub>allow</sub> = S \* F<sub>b</sub> \* C<sub>P</sub> \* C<sub>F</sub> \* C<sub>i</sub> \* C<sub>r</sub>

P<sub>allow</sub> = A \* F<sub>c</sub> \* C<sub>D</sub> \* C<sub>F</sub> \* C<sub>P</sub>

(Eq 3.9-3)

(Eq 3.9-4)

P<sub>c,allow</sub> = A \* F<sub>c</sub> \* C<sub>b</sub>

P<sub>c,allow</sub> = A \* F<sub>c</sub>

L / (I \* E / 15 \* L \* M<sub>applied</sub>)

(1.0) \* E Table 1604.3(f)

Actual Δ

Axial + Ber

Bearing on

Bearing on



JOB #: 23.007

DESIGNED: MRO

DATE: 05/31/23

PROJECT: Bradley Hts Apartments 2x Brg at 4x Header

**STUD WALL DESIGN**

2018 NDS/2018 IBC

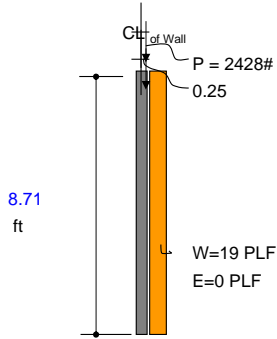

AXIAL LOADS P	
P <sub>DL</sub> (#/ft) =	921
P <sub>SL</sub> (#/ft) =	244
P <sub>LL</sub> (#/ft) =	714
P <sub>TOT</sub> (#/ft) =	1,880
e (IN) =	0.5
TRIB. (IN) =	16

LATERAL LOADS W	
W (PSF) =	15.00
E (PSF) =	0.00
TRIB. (IN) =	16

DESIGN VALUES	
F <sub>b</sub> (psi) =	675
F <sub>v</sub> (psi) =	150
F <sub>c</sub> (psi) =	800
F <sub>cL</sub> (psi) =	405
E (psi) =	1.20E+06
E <sub>min</sub> (psi) =	4.40E+05
C <sub>r</sub> =	1.15
L <sub>u</sub> (in) =	104.5
c =	0.8
K <sub>e</sub> =	1
C <sub>b</sub> =	1.00

Hem Fir	▼	0.49
Stud Grade	▼	0.13
Bending X-X axis	▼	0.38
405		
Inced, No	▼	
Wet Use, No	▼	
Repetive, Yes	▼	
Full Bracing, Yes	▼	
(Sawn Lumber)		
(Appendix G)		
(Bearing Area Factor)		

Use: (1) 2" X 6" @ 16" O.C. OK

Bearing wall Fire rated ?	No	▼
Fire Retardant FirePRO?	No	▼
Header Bearing Area (in <sup>2</sup> ) =	5.25	

405 = F<sub>cL</sub> (psi)

MEMBER SIZE		SECTION PROPERTIES				
QUANTITY	1	A =		8.25 in <sup>2</sup>		
b =	1.5 in	S =		7.56 in <sup>3</sup>		
d =	5.5 in	I =		20.80 in <sup>4</sup>		
	(Eq. 16-9)	(Eq. 16-10)	(Eq. 16-11)	(Eq. 16-12)	(Eq. 16-13)	
LOAD CASES	DL + LL	DL + SL	DL+0.75(LL+SL)	DL + W	DL+0.75(LL+SL+W)	
L <sub>u</sub> (ft) =	8.708	8.708	8.708	8.708	8.708	
V <sub>applied</sub> (#) =	10	7	10	90	73	
M <sub>applied</sub> (ft-#) =	44	31	44	218	195	
P <sub>applied</sub> (#) =	2113	1506	2119	1190	2119	
C <sub>D</sub> =	1	1.15	1.15	1.6	1.6	
BENDING STRESS CALCS		F <sub>bE</sub> (psi) = 17476			C <sub>bF</sub> = 1	
F <sub>b</sub> * (psi) =	776	893	893	1242	1242	
C <sub>L</sub> =	1.000	1.000	1.000	1.000	1.000	
F <sub>b</sub> (psi) =	776	893	893	1242	1242	
AXIAL STRESS CALCS		F <sub>cE</sub> = 1002			C <sub>cF</sub> = 1	
L <sub>e</sub> /d =	19.00	19.00	19.00	19.00	19.00	
F <sub>c</sub> * (psi) =	800	920	920	1280	1280	
C <sub>P</sub> =	0.7626	0.7196	0.7196	0.6013	0.6013	
F <sub>c</sub> (psi) =	610	662	662	770	770	
ALLOWABLES	DL + LL	DL + SL	DL+0.75(LL+SL)	DL + W	DL+0.75(LL+SL+W)	
V <sub>allow</sub> (#) =	825	949	949	1321	1321	
M <sub>allow</sub> (ft - #) =	489	563	563	783	783	
P <sub>allow</sub> (#) =	5,035	5,465	5,465	6,353	6,353	
(f <sub>v</sub> /F <sub>v</sub> ) <sup>2</sup> + f <sub>v</sub> /(F <sub>v</sub> (1-f <sub>v</sub> /F <sub>vE</sub> )) =	0.30	0.14	0.26	0.36	0.45	
(f <sub>v</sub> /F <sub>vE</sub> ) <sup>2</sup> + (f <sub>v</sub> /F <sub>vE</sub> ) =	0.26	0.18	0.26	0.14	0.26	
P <sub>c,allow</sub> on PL (#) =	3,343	3,343	3,343	3,343	3,343	
P <sub>c,allow</sub> on Beam (#) =	2,126	2,126	2,126	2,126	2,126	
Deflection L/	NA	NA	NA	L/1040	L/1387	
240	0.00	0.00	0.00	0.10	0.08	
CHECKS	DL + LL	DL + SL	DL+0.75(LL+SL)	DL + W	DL+0.75(LL+SL+W)	
SHEAR V	OK	OK	OK	OK	OK	
V <sub>applied</sub> /V <sub>allow</sub>	1.2%	0.8%	1.1%	6.8%	5.6%	
MOMENT M	OK	OK	OK	OK	OK	
M <sub>applied</sub> /M <sub>allow</sub>	9.0%	5.6%	7.8%	27.9%	24.9%	
AXIAL P	OK	OK	OK	OK	OK	
P <sub>applied</sub> /P <sub>allow</sub>	42.0%	27.6%	38.8%	18.7%	33.3%	
(f <sub>v</sub> /F <sub>v</sub> ) <sup>2</sup> + f <sub>v</sub> /(F <sub>v</sub> (1-f <sub>v</sub> /F <sub>vE</sub> )) =	OK	OK	OK	OK	OK	
(f <sub>v</sub> /F <sub>vE</sub> ) <sup>2</sup> + f <sub>v</sub> /(F <sub>vE</sub> (1-f <sub>v</sub> /F <sub>vE</sub> )) =	29.7%	14.4%	25.6%	36.1%	44.6%	
(f <sub>v</sub> /F <sub>vE</sub> ) + (f <sub>v</sub> /F <sub>vE</sub> ) <sup>2</sup>	OK	OK	OK	OK	OK	
(f <sub>v</sub> /F <sub>vE</sub> ) + (f <sub>v</sub> /F <sub>vE</sub> ) <sup>2</sup>	25.5%	18.2%	25.6%	14.4%	25.6%	
AXIAL P <sub>c</sub> on PL	OK	OK	OK	OK	OK	
P <sub>c,applied</sub> /P <sub>c,allow</sub>	63.2%	45.0%	63.4%	35.6%	63.4%	
AXIAL P <sub>c</sub> on Beam	OK	OK	OK	OK	OK	
P <sub>c,applied</sub> /P <sub>c,allow</sub>	99.4%	70.8%	99.6%	56.0%	99.6%	
DEFLECTION	OK	OK	OK	OK	OK	
D <sub>actual</sub> /D <sub>allowed</sub>	0.0%	0.0%	0.0%	23.1%	17.3%	
Overall Check	OK	OK	OK	OK	OK	

Table 4a Bending  
(Eq. 3.7-1)  
(Eq. 3.7-1)  
(Table 4.3.1)

Table 4a Compression  
(3.7.1.4) <50  
(Eq. 3.7-1)  
(Eq. 3.7-1)  
(Table 4.3.1)

V<sub>allow</sub> = A \* F<sub>v</sub> \* C<sub>D</sub> / 1.5  
M<sub>allow</sub> = S \* F<sub>v</sub> \* C<sub>D</sub> \* C<sub>F</sub> \* C<sub>P</sub>  
P<sub>allow</sub> = A \* F<sub>c</sub> \* C<sub>D</sub> \* C<sub>F</sub> \* C<sub>P</sub>  
(Eq. 3.9-3)  
(Eq. 3.9-4)  
P<sub>c,allow</sub> = A \* F<sub>c</sub> \* C<sub>b</sub>  
P<sub>c,allow</sub> = A \* F<sub>c</sub>  
L/(1 \* E / 15 \* L \* M<sub>applied</sub>)  
(1.0) \* W  
Table 1604.3(f)  
Actual Δ

Le = (Ke)L

Axial + Ber

Bearing on

Bearing on



JOB #: 23.007

DESIGNED: MRO

DATE: 05/31/23

PROJECT: Bradley Hts Apartments 2x Brg at 3-1/8 GLB Header

STUD WALL DESIGN

2018 NDS/2018 IBC

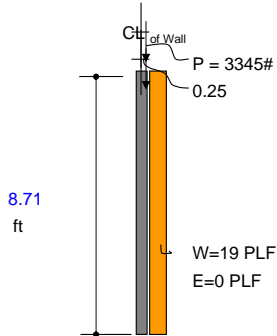

AXIAL LOADS P	
P <sub>DL</sub> (#/ft) =	1,269
P <sub>SL</sub> (#/ft) =	337
P <sub>LL</sub> (#/ft) =	984
P <sub>TOT</sub> (#/ft) =	2,590
e (IN) =	0.5
TRIB. (IN) =	16

LATERAL LOADS W	
W (PSF) =	15.00
E (PSF) =	0.00
TRIB. (IN) =	16

DESIGN VALUES	
F <sub>b</sub> (psi) =	675
F <sub>v</sub> (psi) =	150
F <sub>c</sub> (psi) =	800
F <sub>cl</sub> (psi) =	405
E (psi) =	1.20E+06
E <sub>min</sub> (psi) =	4.40E+05
C <sub>r</sub> =	1.15
L <sub>u</sub> (in) =	104.5
c =	0.8
K <sub>e</sub> =	1
C <sub>b</sub> =	1.00

Hem Fir	▼	0.49
Stud Grade	▼	0.13
Bending X-X axis	▼	0.38
405		
Incised, No	▼	
Wet Use, No	▼	
Repetitive, Yes	▼	
Full Bracing, Yes	▼	
(Sawn Lumber)		
(Appendix G)		
(Bearing Area Factor)		

Use: (1) 2" X 6" @ 16" O.C. OK

Bearing wall Fire rated? No  
 Fire Retardant FirePRO? No  
 Header Bearing Area (in<sup>2</sup>) = 4.69

625 = F<sub>cl</sub> (psi)

MEMBER SIZE		SECTION PROPERTIES				
QUANTITY	1	A =		8.25 in <sup>2</sup>		
b =	1.5 in	S =		7.56 in <sup>3</sup>		
d =	5.5 in	I =		20.80 in <sup>4</sup>		
	(Eq. 16-9)	(Eq. 16-10)	(Eq. 16-11)	(Eq. 16-12)	(Eq. 16-13)	
LOAD CASES	DL + LL	DL + SL	DL+0.75(LL+SL)	DL + W	DL+0.75(LL+SL+W)	
L <sub>u</sub> (ft) =	8.708	8.708	8.708	8.708	8.708	
V <sub>applied</sub> (#) =	14	10	14	92	77	
M <sub>applied</sub> (ft-#) =	61	43	61	232	217	
P <sub>applied</sub> (#) =	2911	2074	2919	1639	2919	
C <sub>D</sub> =	1	1.15	1.15	1.6	1.6	
BENDING STRESS CALCS		F <sub>bE</sub> (psi) = 17476			C <sub>bF</sub> = 1	
F <sub>b</sub> * (psi) =	776	893	893	1242	1242	
C <sub>L</sub> =	1.000	1.000	1.000	1.000	1.000	
F <sub>b</sub> ' (psi) =	776	893	893	1242	1242	
AXIAL STRESS CALCS		F <sub>cE</sub> = 1002			C <sub>cF</sub> = 1	
L <sub>e</sub> /d =	19.00	19.00	19.00	19.00	19.00	
F <sub>c</sub> * (psi) =	800	920	920	1280	1280	
C <sub>P</sub> =	0.7626	0.7196	0.7196	0.6013	0.6013	
F <sub>c</sub> ' (psi) =	610	662	662	770	770	
ALLOWABLES	DL + LL	DL + SL	DL+0.75(LL+SL)	DL + W	DL+0.75(LL+SL+W)	
V <sub>allow</sub> (#) =	825	949	949	1321	1321	
M <sub>allow</sub> (ft - #) =	489	563	563	783	783	
P <sub>allow</sub> (#) =	5,035	5,465	5,465	6,353	6,353	
(f <sub>v</sub> /F <sub>v</sub> ) <sup>2</sup> + f <sub>v</sub> /(F <sub>v</sub> (1-(f <sub>v</sub> /F <sub>vE</sub> ))) =	0.53	0.25	0.45	0.44	0.64	
(f <sub>v</sub> /F <sub>vE</sub> ) + (f <sub>v</sub> /F <sub>vE</sub> ) <sup>2</sup> =	0.35	0.25	0.35	0.20	0.35	
P <sub>c,allow</sub> on PL (#) =	3,343	3,343	3,343	3,343	3,343	
P <sub>c,allow</sub> on Beam (#) =	2,930	2,930	2,930	2,930	2,930	
Deflection L/	NA	NA	NA	L/1040	L/1387	
240	0.00	0.00	0.00	0.10	0.08	
CHECKS	DL + LL	DL + SL	DL+0.75(LL+SL)	DL + W	DL+0.75(LL+SL+W)	
SHEAR V	OK	OK	OK	OK	OK	
V <sub>applied</sub> /V <sub>allow</sub>	1.7%	1.0%	1.5%	7.0%	5.8%	
MOMENT M	OK	OK	OK	OK	OK	
M <sub>applied</sub> /M <sub>allow</sub>	12.4%	7.7%	10.8%	29.6%	27.7%	
AXIAL P	OK	OK	OK	OK	OK	
P <sub>applied</sub> /P <sub>allow</sub>	57.8%	38.0%	53.4%	25.8%	45.9%	
(f <sub>v</sub> /F <sub>v</sub> ) <sup>2</sup> + f <sub>v</sub> /(F <sub>v</sub> (1-(f <sub>v</sub> /F <sub>vE</sub> ))) =	OK	OK	OK	OK	OK	
(f <sub>v</sub> /F <sub>vE</sub> ) + (f <sub>v</sub> /F <sub>vE</sub> ) <sup>2</sup> =	52.5%	24.7%	45.2%	43.6%	63.9%	
(f <sub>v</sub> /F <sub>vE</sub> ) + (f <sub>v</sub> /F <sub>vE</sub> ) <sup>2</sup> =	OK	OK	OK	OK	OK	
(f <sub>v</sub> /F <sub>vE</sub> ) + (f <sub>v</sub> /F <sub>vE</sub> ) <sup>2</sup> =	35.2%	25.1%	35.3%	19.8%	35.3%	
AXIAL P <sub>c</sub> on PL	OK	OK	OK	OK	OK	
P <sub>c,applied</sub> /P <sub>c,allow</sub>	87.1%	62.0%	87.3%	49.0%	87.3%	
AXIAL P <sub>c</sub> on Beam	OK	OK	OK	OK	OK	
P <sub>c,applied</sub> /P <sub>c,allow</sub>	99.3%	70.8%	99.6%	56.0%	99.6%	
DEFLECTION	OK	OK	OK	OK	OK	
D <sub>actual</sub> /D <sub>allowed</sub>	0.0%	0.0%	0.0%	23.1%	17.3%	
Overall Check	OK	OK	OK	OK	OK	

(Table 4a Bending)

(Eq 3.7-1)

(Eq 3.7-1)

(Table 4.3.1)

(Table 4a Compression)

(3.7.1.4) <50

Le = (Ke)L

(Eq 3.7-1)

(Eq 3.7-1)

(Table 4.3.1)

V<sub>allow</sub> = A \* F<sub>v</sub> \* C<sub>D</sub> / 1.5

M<sub>allow</sub> = S \* F<sub>b</sub> \* C<sub>b</sub> \* C<sub>F</sub> \* C<sub>L</sub> \* C<sub>r</sub>

P<sub>allow</sub> = A \* F<sub>c</sub> \* C<sub>D</sub> \* C<sub>F</sub> \* C<sub>P</sub>

(Eq 3.9-3)

(Eq 3.9-4)

P<sub>c,allow</sub> = A \* F<sub>c</sub> \* C<sub>b</sub>

P<sub>c,allow</sub> = A \* F<sub>c</sub>

L/(I \* E / 15 \* L \* M<sub>applied</sub>)

(1.0) \* W Table 1604.3(f)

Actual Δ

Axial + Ber

Bearing on

Bearing on



JOB #: 23.007

DESIGNED: MRO

DATE: 05/31/23

PROJECT: Bradley Hts Apartments 2x Brg at 5-1/8 GLB Header

STUD WALL DESIGN

2018 NDS/2018 IBC

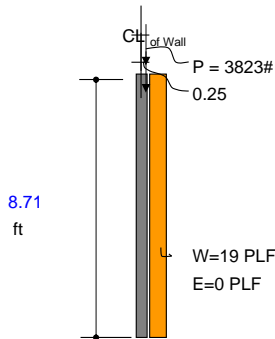

AXIAL LOADS P	
P <sub>DL</sub> (#/ft) =	1,450
P <sub>SL</sub> (#/ft) =	385
P <sub>LL</sub> (#/ft) =	1,125
P <sub>TOT</sub> (#/ft) =	2,960
e (IN) =	0.5
TRIB. (IN) =	16

LATERAL LOADS W	
W (PSF) =	15.00
E (PSF) =	0.00
TRIB. (IN) =	16

DESIGN VALUES	
F <sub>b</sub> (psi) =	675
F <sub>v</sub> (psi) =	150
F <sub>c</sub> (psi) =	800
F <sub>cl</sub> (psi) =	405
E (psi) =	1.20E+06
E <sub>min</sub> (psi) =	4.40E+05
C <sub>r</sub> =	1.15
L <sub>u</sub> (in) =	104.5
c =	0.8
K <sub>e</sub> =	1
C <sub>b</sub> =	1.00

Hem Fir	▼	0.49
Stud Grade	▼	0.13
Bending X-X axis	▼	0.38
405		
Incised, No	▼	
Wet Use, No	▼	
Repetitive, Yes	▼	
Full Bracing, Yes	▼	
(Sawn Lumber)		
(Appendix G)		
(Bearing Area Factor)		

Use: (1) 2" X 6" @ 16" O.C. OK

Bearing wall Fire rated ?	No	▼
Fire Retardant FirePRO?	No	▼
Header Bearing Area (in <sup>2</sup> ) =	7.69	

625 = F<sub>cl</sub> (psi)

MEMBER SIZE		SECTION PROPERTIES				
QUANTITY	1	A =	8.25 in <sup>2</sup>			
b =	1.5 in	S =	7.56 in <sup>3</sup>			
d =	5.5 in	I =	20.80 in <sup>4</sup>			
	(Eq. 16-9)	(Eq. 16-10)	(Eq. 16-11)	(Eq. 16-12)	(Eq. 16-13)	
LOAD CASES	DL + LL	DL + SL	DL+0.75(LL+SL)	DL + W	DL+0.75(LL+SL+W)	
L <sub>u</sub> (ft) =	8.708	8.708	8.708	8.708	8.708	
V <sub>applied</sub> (#) =	16	11	16	93	79	
M <sub>applied</sub> (ft-#) =	69	49	69	238	228	
P <sub>applied</sub> (#) =	3326	2370	3336	1873	3336	
C <sub>D</sub> =	1	1.15	1.15	1.6	1.6	
BENDING STRESS CALCS	F <sub>bE</sub> (psi) = 17476			C <sub>DF</sub> = 1		(Table 4a Bending)
F <sub>b</sub> * (psi) =	776	893	893	1242	1242	(Eq 3.7-1)
C <sub>L</sub> =	1.000	1.000	1.000	1.000	1.000	(Eq 3.7-1)
F <sub>b</sub> ' (psi) =	776	893	893	1242	1242	(Table 4.3.1)
AXIAL STRESS CALCS	F <sub>CE</sub> = 1002			C <sub>CF</sub> = 1		(Table 4a Compression)
L <sub>e</sub> /d =	19.00	19.00	19.00	19.00	19.00	(3.7.1.4) <50 Le = (Ke)L
F <sub>c</sub> * (psi) =	800	920	920	1280	1280	(Eq 3.7-1)
C <sub>P</sub> =	0.7626	0.7196	0.7196	0.6013	0.6013	(Eq 3.7-1)
F <sub>c</sub> ' (psi) =	610	662	662	770	770	(Table 4.3.1)
ALLOWABLES	DL + LL	DL + SL	DL+0.75(LL+SL)	DL + W	DL+0.75(LL+SL+W)	
V <sub>allow</sub> (#) =	825	949	949	1321	1321	V <sub>allow</sub> = A * F <sub>v</sub> * C <sub>D</sub> / 1.5
M <sub>allow</sub> (ft - #) =	489	563	563	783	783	M <sub>allow</sub> = S * F <sub>b</sub> ' * C <sub>D</sub> * C <sub>F</sub> * C <sub>L</sub> * C <sub>r</sub>
P <sub>allow</sub> (#) =	5,035	5,465	5,465	6,353	6,353	P <sub>allow</sub> = A * F <sub>c</sub> ' * C <sub>D</sub> * C <sub>F</sub> * C <sub>P</sub>
(f <sub>v</sub> /F <sub>v</sub> ) <sup>2</sup> + f <sub>v</sub> /(F <sub>v</sub> (1-(f <sub>v</sub> /F <sub>vE</sub> ))) =	0.67	0.31	0.58	0.48	0.76	(Eq 3.9-3)
(f <sub>c</sub> /F <sub>c</sub> ) <sup>2</sup> + f <sub>c</sub> /(F <sub>c</sub> (1-(f <sub>c</sub> /F <sub>cE</sub> ))) =	0.40	0.29	0.40	0.23	0.40	(Eq 3.9-4)
P <sub>c,allow</sub> on PL (#) =	3,343	3,343	3,343	3,343	3,343	P <sub>c,allow</sub> = A * F <sub>c</sub> ' * C <sub>b</sub>
P <sub>c,allow</sub> on Beam (#) =	4,805	4,805	4,805	4,805	4,805	P <sub>c,allow</sub> = A * F <sub>c</sub>
Deflection L/	NA	NA	NA	L/1040	L/1387	L/(I * E / 15 * L * M <sub>applied</sub> )
240	0.00	0.00	0.00	0.10	0.08	(1.0) * W Table 1604.3(f)
CHECKS	DL + LL	DL + SL	DL+0.75(LL+SL)	DL + W	DL+0.75(LL+SL+W)	Actual Δ
SHEAR V	OK	OK	OK	OK	OK	
V <sub>applied</sub> /V <sub>allow</sub>	1.9%	1.2%	1.7%	7.1%	6.0%	
MOMENT M	OK	OK	OK	OK	OK	
M <sub>applied</sub> /M <sub>allow</sub>	14.2%	8.8%	12.4%	30.5%	29.2%	
AXIAL P	OK	OK	OK	OK	OK	
P <sub>applied</sub> /P <sub>allow</sub>	66.1%	43.4%	61.0%	29.5%	52.5%	
(f <sub>v</sub> /F <sub>v</sub> ) <sup>2</sup> + f <sub>v</sub> /(F <sub>v</sub> (1-(f <sub>v</sub> /F <sub>vE</sub> ))) =	OK	OK	OK	OK	OK	
(f <sub>c</sub> /F <sub>c</sub> ) <sup>2</sup> + f <sub>c</sub> /(F <sub>c</sub> (1-(f <sub>c</sub> /F <sub>cE</sub> ))) =	67.3%	31.1%	58.0%	48.1%	76.4%	Axial + Ber
(f <sub>v</sub> /F <sub>vE</sub> ) + (f <sub>v</sub> /F <sub>vE</sub> ) <sup>2</sup>	OK	OK	OK	OK	OK	
(f <sub>c</sub> /F <sub>cE</sub> ) + (f <sub>c</sub> /F <sub>cE</sub> ) <sup>2</sup>	40.2%	28.7%	40.3%	22.7%	40.3%	
AXIAL P <sub>c</sub> on PL	OK	OK	OK	OK	OK	
P <sub>c,applied</sub> /P <sub>c,allow</sub>	99.5%	70.9%	99.8%	56.0%	99.8%	Bearing on
AXIAL P <sub>c</sub> on Beam	OK	OK	OK	OK	OK	
P <sub>c,applied</sub> /P <sub>c,allow</sub>	69.2%	49.3%	69.4%	39.0%	69.4%	Bearing on
DEFLECTION	OK	OK	OK	OK	OK	
D <sub>actual</sub> /D <sub>allowed</sub>	0.0%	0.0%	0.0%	23.1%	17.3%	
Overall Check	OK	OK	OK	OK	OK	

PRMU20240280 BLDG G



JOB #: 23.007

DESIGNED: MRO

DATE: 05/31/23

PROJECT: Bradley Hts Apartments Max Trib for (1) 2x6 Jamb Stud

**STUD WALL DESIGN**

2018 NDS/2018 IBC

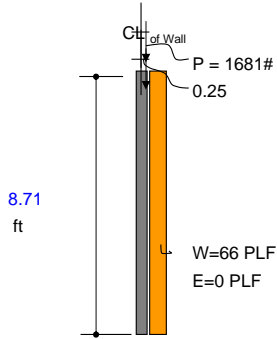

AXIAL LOADS P	
P <sub>DL</sub> (#/ft) =	1,419
P <sub>SL</sub> (#/ft) =	375
P <sub>LL</sub> (#/ft) =	1,095
P <sub>TOT</sub> (#/ft) =	2,522
e (IN) =	0.5
TRIB. (IN) =	8

LATERAL LOADS W	
W (PSF) =	15.00
E (PSF) =	0.00
TRIB. (IN) =	53

DESIGN VALUES	
F <sub>b</sub> (psi) =	675
F <sub>v</sub> (psi) =	150
F <sub>c</sub> (psi) =	800
F <sub>cL</sub> (psi) =	405
E (psi) =	1.20E+06
E <sub>min</sub> (psi) =	4.40E+05
C <sub>r</sub> =	1.15
L <sub>u</sub> (in) =	104.5
c =	0.8
K <sub>e</sub> =	1
C <sub>b</sub> =	1.00

Hem Fir	▼	0.56276
Stud Grade	▼	0.148721
Bending X-X axis	▼	0.434265
405		
Incised, No	▼	
Wet Use, No	▼	
Repetitive, Yes	▼	
Full Bracing, Yes	▼	
(Sawn Lumber)		
(Appendix G)		
(Bearing Area Factor)		

Use: (1) 2" X 6" @ 53" O.C. OK

Bearing wall Fire rated ?	No	▼
Fire Retardant FirePRO?	No	▼
Header Bearing Area (in <sup>2</sup> ) =	5.25	

405 = F<sub>cL</sub> (psi)

MEMBER SIZE		SECTION PROPERTIES				
QUANTITY	1	A =	8.25 in <sup>2</sup>			
b =	1.5 in	S =	7.56 in <sup>3</sup>			
d =	5.5 in	I =	20.80 in <sup>4</sup>			
	(Eq. 16-9)	(Eq. 16-10)	(Eq. 16-11)	(Eq. 16-12)	(Eq. 16-13)	
LOAD CASES	DL + LL	DL + SL	DL+0.75(LL+SL)	DL + W	DL+0.75(LL+SL+W)	
L <sub>u</sub> (ft) =	8.708	8.708	8.708	8.708	8.708	
V <sub>applied</sub> (#) =	8	6	8	293	224	
M <sub>applied</sub> (ft-#) =	35	25	35	675	542	
P <sub>applied</sub> (#) =	1676	1196	1681	946	1681	
C <sub>D</sub> =	1	1.15	1.15	1.6	1.6	
BENDING STRESS CALCS	F <sub>bE</sub> (psi) = 17476			C <sub>bF</sub> = 1		(Table 4a Bending)
F <sub>b</sub> * (psi) =	776	893	893	1242	1242	(Eq 3.7-1)
C <sub>L</sub> =	1.000	1.000	1.000	1.000	1.000	(Eq 3.7-1)
F <sub>b</sub> (psi) =	776	893	893	1242	1242	(Table 4.3.1)
AXIAL STRESS CALCS	F <sub>cE</sub> = 1002			C <sub>cF</sub> = 1		(Table 4a Compression)
L <sub>e</sub> /d =	19.00	19.00	19.00	19.00	19.00	(3.7.1.4) <50 Le = (Ke)L
F <sub>c</sub> * (psi) =	800	920	920	1280	1280	(Eq 3.7-1)
C <sub>P</sub> =	0.7626	0.7196	0.7196	0.6013	0.6013	(Eq 3.7-1)
F <sub>c</sub> (psi) =	610	662	662	770	770	(Table 4.3.1)
ALLOWABLES	DL + LL	DL + SL	DL+0.75(LL+SL)	DL + W	DL+0.75(LL+SL+W)	
V <sub>allow</sub> (#) =	825	949	949	1321	1321	V <sub>allow</sub> = A * F <sub>v</sub> * C <sub>D</sub> / 1.5
M <sub>allow</sub> (ft - #) =	489	563	563	783	783	M <sub>allow</sub> = S * F <sub>b</sub> * C <sub>b</sub> * C <sub>F</sub> * C <sub>L</sub> * C <sub>r</sub>
P <sub>allow</sub> (#) =	5,035	5,465	5,465	6,353	6,353	P <sub>allow</sub> = A * F <sub>c</sub> * C <sub>D</sub> * C <sub>F</sub> * C <sub>P</sub>
(f <sub>v</sub> /F <sub>v</sub> ) <sup>2</sup> + f <sub>v</sub> /(F <sub>v</sub> (1-(f <sub>v</sub> /F <sub>vE</sub> ))) =	0.20	0.10	0.17	1.00	0.94	(Eq 3.9-3)
(f <sub>c</sub> /F <sub>cE</sub> ) + (f <sub>v</sub> /F <sub>bE</sub> ) <sup>2</sup> =	0.20	0.14	0.20	0.11	0.20	(Eq 3.9-4)
P <sub>c,allow</sub> on PL (#) =	3,343	3,343	3,343	3,343	3,343	P <sub>c,allow</sub> = A * F <sub>c</sub> * C <sub>b</sub>
P <sub>c,allow</sub> on Beam (#) =	2,126	2,126	2,126	2,126	2,126	P <sub>c,allow</sub> = A * F <sub>c</sub>
Deflection L/	NA	NA	NA	L/304	L/406	L/(I * E / 15 * L * M <sub>applied</sub> )
240	0.00	0.00	0.00	0.34	0.26	(1.0) * W Table 1604.3(f)
CHECKS	DL + LL	DL + SL	DL+0.75(LL+SL)	DL + W	DL+0.75(LL+SL+W)	Actual Δ
SHEAR V	OK	OK	OK	OK	OK	
V <sub>applied</sub> /V <sub>allow</sub>	1.0%	0.6%	0.8%	22.2%	17.0%	
MOMENT M	OK	OK	OK	OK	OK	
M <sub>applied</sub> /M <sub>allow</sub>	7.1%	4.4%	6.2%	86.2%	69.3%	
AXIAL P	OK	OK	OK	OK	OK	
P <sub>applied</sub> /P <sub>allow</sub>	33.3%	21.9%	30.8%	14.9%	26.5%	
(f <sub>v</sub> /F <sub>v</sub> ) <sup>2</sup> + f <sub>v</sub> /(F <sub>v</sub> (1-(f <sub>v</sub> /F <sub>vE</sub> ))) =	OK	OK	OK	OK	OK	
(f <sub>c</sub> /F <sub>cE</sub> ) + (f <sub>v</sub> /F <sub>bE</sub> ) <sup>2</sup> =	20.0%	10.0%	17.3%	99.6%	93.9%	Axial + Ber
(f <sub>v</sub> /F <sub>vE</sub> ) + (f <sub>v</sub> /F <sub>bE</sub> ) <sup>2</sup> =	OK	OK	OK	OK	OK	
(f <sub>v</sub> /F <sub>vE</sub> ) + (f <sub>v</sub> /F <sub>bE</sub> ) <sup>2</sup> =	20.3%	14.5%	20.3%	11.4%	20.3%	
AXIAL P <sub>c</sub> on PL	OK	OK	OK	OK	OK	
P <sub>c,applied</sub> /P <sub>c,allow</sub>	50.1%	35.8%	50.3%	28.3%	50.3%	Bearing on
AXIAL P <sub>c</sub> on Beam	OK	OK	OK	OK	OK	
P <sub>c,applied</sub> /P <sub>c,allow</sub>	78.8%	56.2%	79.1%	44.5%	79.1%	Bearing on
DEFLECTION	OK	OK	OK	OK	OK	
D <sub>actual</sub> /D <sub>allowed</sub>	0.0%	0.0%	0.0%	78.9%	59.2%	
Overall Check	OK	OK	OK	OK	OK	

PRMU20240280 BLDG G



JOB #: 23.007

DESIGNED: MRO

DATE: 05/31/23

PROJECT: Bradley Hts Apartments Max Trib for (2) 2x6 Jamb Stud

**STUD WALL DESIGN**

2018 NDS/2018 IBC

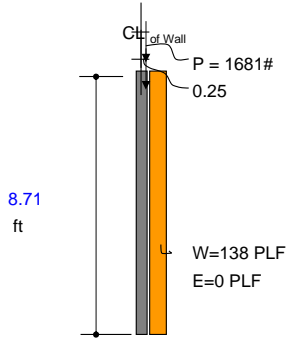

AXIAL LOADS P	
P <sub>DL</sub> (#/ft) =	1,419
P <sub>SL</sub> (#/ft) =	375
P <sub>LL</sub> (#/ft) =	1,095
P <sub>TOT</sub> (#/ft) =	2,522
e (IN) =	0.5
TRIB. (IN) =	8

LATERAL LOADS W	
W (PSF) =	15.00
E (PSF) =	0.00
TRIB. (IN) =	110

DESIGN VALUES	
F <sub>b</sub> (psi) =	675
F <sub>v</sub> (psi) =	150
F <sub>c</sub> (psi) =	800
F <sub>cl</sub> (psi) =	405
E (psi) =	1.20E+06
E <sub>min</sub> (psi) =	4.40E+05
C <sub>r</sub> =	1.15
L <sub>u</sub> (in) =	104.5
c =	0.8
K <sub>e</sub> =	1
C <sub>b</sub> =	1.00

Hem Fir	▼	0.56276
Stud Grade	▼	0.148721
Bending X-X axis	▼	0.434265
405		
Incised, No	▼	
Wet Use, No	▼	
Repetitive, Yes	▼	
Full Bracing, Yes	▼	
(Sawn Lumber)		
(Appendix G)		
(Bearing Area Factor)		

Bearing wall Fire rated? No  
 Fire Retardant FirePRO? No  
 Header Bearing Area (in<sup>2</sup>) = 5.25

Use: (2) 2" X 6" @ 110" O.C. OK

405 = F<sub>cl</sub> (psi)

MEMBER SIZE		SECTION PROPERTIES			
QUANTITY	2	A =	8.25 in <sup>2</sup>		
b =	1.5 in	S =	15.13 in <sup>3</sup>		
d =	5.5 in	I =	41.59 in <sup>4</sup>		
	(Eq. 16-9)	(Eq. 16-10)	(Eq. 16-11)	(Eq. 16-12)	(Eq. 16-13)
<b>LOAD CASES</b>	DL + LL	DL + SL	DL+0.75(LL+SL)	DL + W	DL+0.75(LL+SL+W)
L <sub>u</sub> (ft) =	8.708	8.708	8.708	8.708	8.708
V <sub>applied</sub> (#) =	8	6	8	603	457
M <sub>applied</sub> (ft-#) =	35	25	35	1351	1050
P <sub>applied</sub> (#) =	1676	1196	1681	946	1681
C <sub>D</sub> =	1	1.15	1.15	1.6	1.6
<b>BENDING STRESS CALCS</b>	F <sub>bE</sub> (psi) = 17476			C <sub>DF</sub> = 1	
F <sub>b</sub> * (psi) =	776	893	893	1242	1242
C <sub>L</sub> =	1.000	1.000	1.000	1.000	1.000
F <sub>b</sub> ' (psi) =	776	893	893	1242	1242
<b>AXIAL STRESS CALCS</b>	F <sub>CE</sub> = 1002			C <sub>CF</sub> = 1	
L <sub>e</sub> /d =	19.00	19.00	19.00	19.00	19.00
F <sub>c</sub> * (psi) =	800	920	920	1280	1280
C <sub>P</sub> =	0.7626	0.7196	0.7196	0.6013	0.6013
F <sub>c</sub> ' (psi) =	610	662	662	770	770
<b>ALLOWABLES</b>	DL + LL	DL + SL	DL+0.75(LL+SL)	DL + W	DL+0.75(LL+SL+W)
V <sub>allow</sub> (#) =	825	949	949	1321	1321
M <sub>allow</sub> (ft - #) =	978	1125	1125	1565	1565
P <sub>allow</sub> (#) =	5,035	5,465	5,465	6,353	6,353
(f <sub>v</sub> /F <sub>v</sub> ) <sup>2</sup> + f <sub>v</sub> /(F <sub>v</sub> (1-(f <sub>v</sub> /F <sub>vE</sub> ))) =	0.16	0.07	0.13	1.00	0.91
(f <sub>v</sub> /F <sub>vE</sub> ) + (f <sub>v</sub> /F <sub>vE</sub> ) <sup>2</sup> =	0.20	0.14	0.20	0.11	0.20
P <sub>c,allow</sub> on PL (#) =	3,343	3,343	3,343	3,343	3,343
P <sub>c,allow</sub> on Beam (#) =	2,126	2,126	2,126	2,126	2,126
Deflection L/	NA	NA	NA	L/293	L/391
240	0.00	0.00	0.00	0.36	0.27
<b>CHECKS</b>	DL + LL	DL + SL	DL+0.75(LL+SL)	DL + W	DL+0.75(LL+SL+W)
<b>SHEAR V</b>	OK	OK	OK	OK	OK
V <sub>applied</sub> /V <sub>allow</sub>	1.0%	0.6%	0.8%	45.7%	34.6%
<b>MOMENT M</b>	OK	OK	OK	OK	OK
M <sub>applied</sub> /M <sub>allow</sub>	3.6%	2.2%	3.1%	86.3%	67.1%
<b>AXIAL P</b>	OK	OK	OK	OK	OK
P <sub>applied</sub> /P <sub>allow</sub>	33.3%	21.9%	30.8%	14.9%	26.5%
(f <sub>c</sub> /F <sub>c</sub> ) <sup>2</sup> + f <sub>c</sub> /(F <sub>c</sub> (1-(f <sub>c</sub> /F <sub>CE</sub> ))) =	OK	OK	OK	OK	OK
(f <sub>c</sub> /F <sub>CE</sub> ) + (f <sub>c</sub> /F <sub>CE</sub> ) <sup>2</sup> =	15.6%	7.4%	13.4%	99.7%	91.2%
(f <sub>c</sub> /F <sub>CE</sub> ) + (f <sub>v</sub> /F <sub>vE</sub> ) <sup>2</sup> =	OK	OK	OK	OK	OK
(f <sub>c</sub> /F <sub>CE</sub> ) + (f <sub>v</sub> /F <sub>vE</sub> ) <sup>2</sup> =	20.3%	14.5%	20.3%	11.4%	20.3%
<b>AXIAL P<sub>c</sub> on PL</b>	OK	OK	OK	OK	OK
P <sub>c,applied</sub> /P <sub>c,allow</sub>	50.1%	35.8%	50.3%	28.3%	50.3%
<b>AXIAL P<sub>c</sub> on Beam</b>	OK	OK	OK	OK	OK
P <sub>c,applied</sub> /P <sub>c,allow</sub>	78.8%	56.2%	79.1%	44.5%	79.1%
<b>DEFLECTION</b>	OK	OK	OK	OK	OK
D <sub>actual</sub> /D <sub>allowed</sub>	0.0%	0.0%	0.0%	81.9%	61.4%
<b>Overall Check</b>	OK	OK	OK	OK	OK

(Table 4a Bending)

(Eq 3.7-1)

(Eq 3.7-1)

(Table 4.3.1)

(Table 4a Compression)

(3.7.1.4) <50

(Eq 3.7-1)

(Eq 3.7-1)

(Table 4.3.1)

V<sub>allow</sub> = A \* F<sub>v</sub> \* C<sub>D</sub> / 1.5

M<sub>allow</sub> = S \* F<sub>b</sub> \* C<sub>D</sub> \* C<sub>F</sub> \* C<sub>L</sub> \* C<sub>r</sub>

P<sub>allow</sub> = A \* F<sub>c</sub> \* C<sub>D</sub> \* C<sub>F</sub> \* C<sub>P</sub>

(Eq 3.9-3)

(Eq 3.9-4)

P<sub>c,allow</sub> = A \* F<sub>c</sub> \* C<sub>b</sub>

P<sub>c,allow</sub> = A \* F<sub>c</sub>

L / (I \* E / 15 \* L \* M<sub>applied</sub>)

(1.0) \* W Table 1604.3(f)

Actual Δ

Axial + Ber

Bearing on

Bearing on

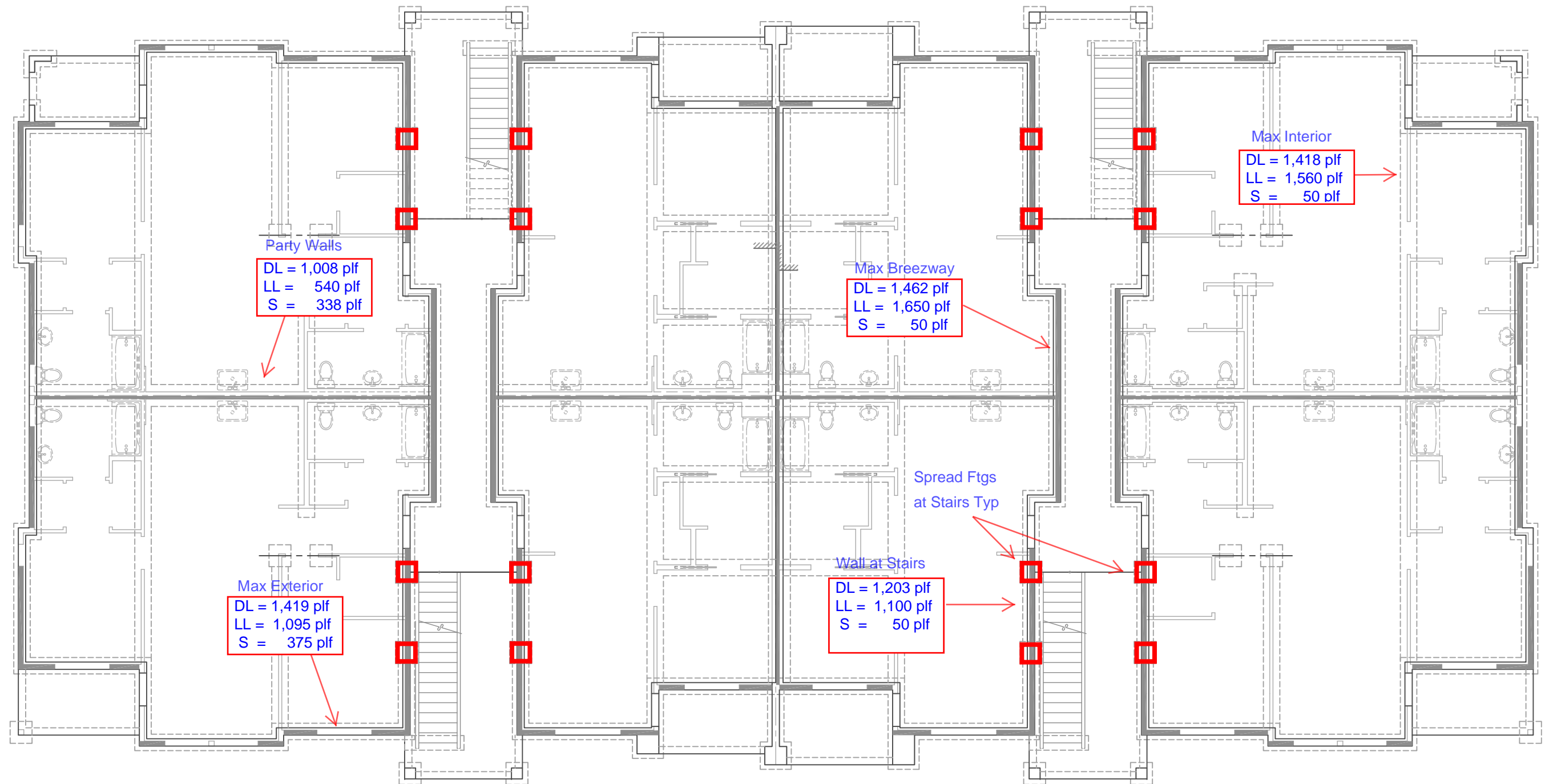

### FOUNDATIONS - KEY PLAN

Bradley Heights Apartments  
 S4S Job# 23.007  
 Foundation Load Summary

Spread Ftgs	Beams	$\Sigma$ DL	$\Sigma$ LL	$\Sigma$ S	D+L	D + 0.75(L+S)
Breezway (3 story)	(2) FB19	3.2	6.8		9.9 k	8.3 k
Breezway (3 story)	RB6 + (2) FB19	4.8	6.8	1.83	11.6 k	11.2 k
Breezway (4 story)	(3) FB19	4.8	10.1		14.9 k	12.4 k
Breezway (4 story)	RB6 + (3) FB19	6.4	10.1	1.83	16.5 k	15.4 k

Wall Footings	Building Levels	$\Sigma$ DL	$\Sigma$ LL	$\Sigma$ S	D+L	D + 0.75(L+S)
Max Exterior	3 story	1,096	730	375	1,826 plf	1,925 plf
Max Exterior	4 story	1,419	1,095	375	2,514 plf	2,522 plf
Max Breezeway	3 story	1,029	1,100	50	2,129 plf	1,892 plf
Max Breezeway	4 story	1,462	1,650	50	3,112 plf	2,737 plf
Max Interior	3 story	990	1,040	50	2,030 plf	1,808 plf
Max Interior	4 story	1,418	1,560	50	2,978 plf	2,626 plf
Party Walls	3 story	801	360	338	1,161 plf	1,325 plf
Party Walls	4 story	1,008	540	338	1,548 plf	1,667 plf



JOB# 23.007

DESIGNED MRO DATE 5-31-23

PROJECT: BRADLEY HEIGHTS - APTS

### COMBINED FOOTINGS AT STAIRS

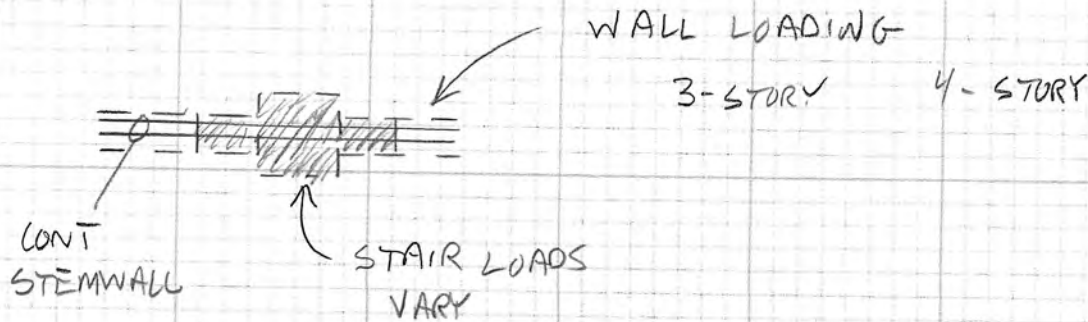

EXAMPLE (3) STORY @ RB/6

$$\text{WALL LOADING} = [2.5 + 2(2.0)] (1590) = 10,335$$

$$\text{LANDING LOAD} = 11,600$$

$$\hline 21,935 \text{ lbs}$$

$$\text{COMBINED AREA} = 2(2 \times 1.5) + (2.5 \times 2.5)$$

$$= 6.0 + 6.25$$

$$= 12.25 \text{ ft}^2$$

$$\text{SOIL PRESSURE} = 21,935 / 12.25 = 1,791 \text{ PSF} (< \text{ASBP} = 2,000)$$

	POINT LD	WALL LD	FTG	SP
3-STORY	9,900	9,540	F2.0	1,944 PSF
3-STORY @ RB/6	11,600	10,335	F2.5	1,791 PSF
4-STORY	14,900	16,121	F3.0	2,068 PSF (WITHIN 3%)
4-STORY @ RB/6	16,500	17,273	F3.5	1,851 PSF

JOB# 23,007DESIGNED MRO DATE 5-31-23PROJECT: BRADLEY HEIGHTS - APTS

## TYPICAL WALL FOOTING

$$A = 18 \times 8 = 144 \text{ in}^2$$

$$A_{s \text{ min}} = 0.0018 (144) = 0.26 \text{ in}^2$$

$$(2) \#4 \text{ PROVIDED} = 0.40 \text{ in}^2 \checkmark$$

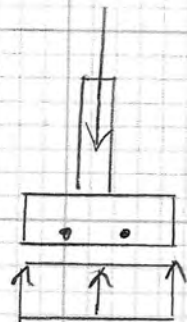

$$w_u = 1.2(1462) + 1.6(1650) = 4,394 \text{ PSF}$$

DESIGN TOE USING STRUCTURAL PLAIN CONCRETE

$$TOE = \frac{18 - 6}{2} = 6 \text{ in}$$

$$V_u = 4.394(6/12) = 2.20 \text{ K}$$

$$\phi V_c = 0.75(2) \sqrt{2500} (12)(4.75) = 4.28 \text{ K} \checkmark$$

$$M_u = 4.394(6/12)^2/2 = 0.55 \text{ Kft}$$

$$S = \frac{1}{6} (12)(8)^2 = 128 \text{ in}^3$$

$$\phi M_n = 0.75(5) \sqrt{2500} (128/12) = 2.00 \text{ Kft} \checkmark$$

PROJECT NAME: **Bradley Heights Apts**  
 PROJECT NUMBER: **23.007**  
 SOLUTIONS 4 STRUCTURES  
 STRUCTURAL ENGINEERING CONSULTANTS

SHEET OF  
 DATE: 4/15/2022  
 DESIGN BY: **MRO**

**SINGLE FOOTING DESIGN TABLE**

**2.00 ft x 2.00 ft x 10 inches thick**  
**(3)-#4 BOT EA. WAY**

**2.0'x2.0'x10 '' ..2ksf**

LOADS	D	L	Hs			FOOTING SIZE	
	<b>4 k</b>	<b>4 k</b>	<b>0 k</b>			LENGTH:	<b>2.00</b> FT
Ftg Self	0.5 k			WIDTH:	<b>2.00</b> FT		
LOAD COMBINATIONS						DEPTH:	<b>10</b> IN
	D	L	Hs	AREA:	4.00 SF		
ASD	<b>1</b>	<b>1</b>	<b>1</b>	AXIAL	Service Factored	COLUMN DATA	
ULT	<b>1.2</b>	<b>1.6</b>	<b>1</b>	<b>8 k</b>		LENGTH:	<b>4</b> IN
$\phi$ ( shear )	<b>0.75</b>			<b>11 k</b>	WIDTH:	<b>4</b> IN	
$\phi$ ( flexure )	<b>0.9</b>						
include ftg self weight	<b>no</b>			SW =	0.5 k		

**CONCRETE SPECS**

F'c: **2,500** PSI  
 Fy: **60,000** PSI  
 d: (DEPTH-3.5"):  
 Conc Density **150** PCF  
 Conc Ftg Weight **0.5** kips

**SOIL**

ALLOW. BEARING: **2.00** KSF  
 ACTUAL BEARING: 2.00 KSF  
 ULT BEARING: 2.80 KSF  
**OK**

**CONCRETE BEAM; SHEAR**

Vu2l: 2 KIPS  
 Vu2w: 2 IN  
 Vu2(max): 2 IN<sup>2</sup>  
 $\phi Vc2$ : 12 KIPS  
 $SR_2 = Vu_2(max) / Vc_2 =$  0.140  
**OK**

**CONCRETE PUNCHING SHEAR**

Vu1: 9 KIPS  
 bo: 42 IN  
 bo \* d: 273 IN<sup>2</sup>  
 $\phi Vc1$ : 41 KIPS  
 $SR_1 = Vu_1 / Vc_1 =$  0.221  
**OK**

**WIDTH****CONCRETE BEAM; BENDING**

Muw: 1.94 K-FT  
 $A_{s( req )}$ : 0.09 IN<sup>2</sup>@ d=6.50 "  
 $A_{s( req )}/FT$ : 0.04 IN<sup>2</sup>/FT  
 Mcr 12.50 K-FT  
 Ms 1.39 K-FT

**LENGTH****CONCRETE BEAM; BENDING**

Mul: 1.94 K-FT  
 $A_{s( req )}$ : 0.09 IN<sup>2</sup>@ d=6.50 "  
 $A_{s( req )}/FT$ : 0.04 IN<sup>2</sup>/FT  
 Mcr 12.50 K-FT  
 Ms 1.39 K-FT

number of bars **3**  
 bar size **4**  
 As **0.60** in<sup>2</sup>  
 d **6.5** inches  
 $\phi Mn$  17 K-FT @ d=6.50 "  
 $\phi Mn / Mu1$  8.54  
 Mcr/Ms = 9.00  
 $\phi Mn / Mcr =$  1.33

PROJECT NAME: **Bradley Heights Apts**  
 PROJECT NUMBER: **23.007**  
 SOLUTIONS 4 STRUCTURES  
 STRUCTURAL ENGINEERING CONSULTANTS

SHEET OF  
 DATE: 4/15/2022  
 DESIGN BY: **MRO**

**SINGLE FOOTING DESIGN TABLE**

**2.50 ft x 2.50 ft x 10 inches thick**  
**(3)-#4 BOT EA. WAY**

**2.5'x2.5'x10 " ..2ksf**

LOADS	D	L	Hs			FOOTING SIZE	
	<b>6 k</b>	<b>6 k</b>	<b>0 k</b>			LENGTH:	<b>2.50</b> FT
Ftg Self	0.8 k			WIDTH:	<b>2.50</b> FT		
LOAD COMBINATIONS						DEPTH:	<b>10</b> IN
	D	L	Hs	AXIAL	AREA:	6.25 SF	
ASD	<b>1</b>	<b>1</b>	<b>1</b>	<b>13 k</b> Service	COLUMN DATA		
ULT	<b>1.2</b>	<b>1.6</b>	<b>1</b>	<b>18 k</b> Factored			
$\phi$ ( shear )	<b>0.75</b>				LENGTH:	<b>4</b> IN	
$\phi$ ( flexure )	<b>0.9</b>				WIDTH:	<b>4</b> IN	
include ftg self weight	<b>no</b>			SW = 0.8 k			

**CONCRETE SPECS**

F'c: **2,500** PSI  
 Fy: **60,000** PSI  
 d: (DEPTH-3.5"):  
 Conc Density **150** PCF  
 Conc Ftg Weight **0.78125** kips

**SOIL**

ALLOW. BEARING: **2.00** KSF  
 ACTUAL BEARING: 2.00 KSF  
 ULT BEARING: 2.80 KSF  
**OK**

**CONCRETE BEAM; SHEAR**

Vu2l: 4 KIPS  
 Vu2w: 4 IN  
 Vu2(max): 4 IN<sup>2</sup>  
 $\phi Vc2$ : 15 KIPS  
 $SR_2 = Vu_2(max) / Vc_2 =$  0.259  
**OK**

**CONCRETE PUNCHING SHEAR**

Vu1: 15 KIPS  
 bo: 42 IN  
 bo \* d: 273 IN<sup>2</sup>  
 $\phi Vc1$ : 41 KIPS  
 $SR_1 = Vu_1 / Vc_1 =$  0.375  
**OK**

**WIDTH****CONCRETE BEAM; BENDING**

Muw: 4.11 K-FT  
 $A_{s( req )}$ : 0.19 IN<sup>2</sup>@ d=6.50 "  
 $A_{s( req )}/FT$ : 0.08 IN<sup>2</sup>/FT  
 Mcr 15.63 K-FT  
 Ms 2.93 K-FT

**LENGTH****CONCRETE BEAM; BENDING**

Mul: 4.11 K-FT  
 $A_{s( req )}$ : 0.19 IN<sup>2</sup>@ d=6.50 "  
 $A_{s( req )}/FT$ : 0.08 IN<sup>2</sup>/FT  
 Mcr 15.63 K-FT  
 Ms 2.93 K-FT

number of bars **3**  
 bar size **4**  
 As **0.60** in<sup>2</sup>  
 d **6.5** inches  
 $\phi Mn$  17 K-FT @ d=6.50 "  
 $\phi Mn / Mu1$  4.09  
 Mcr/Ms = 5.33  
 $\phi Mn / Mcr =$  1.07

PROJECT NAME: **Bradley Heights Apts**  
 PROJECT NUMBER: **23.007**  
 SOLUTIONS 4 STRUCTURES  
 STRUCTURAL ENGINEERING CONSULTANTS

SHEET  OF   
 DATE: 4/15/2022  
 DESIGN BY: **MRO**

**SINGLE FOOTING DESIGN TABLE**

**3.00 ft x 3.00 ft x 12 inches thick**  
**(3)-#4 BOT EA. WAY**

**3.0'x3.0'x12 " ..2ksf**

	D	L	Hs			FOOTING SIZE	
LOADS	<b>9 k</b>	<b>9 k</b>	<b>0 k</b>			LENGTH:	<b>3.00</b> FT
Ftg Self	1.4 k					WIDTH:	<b>3.00</b> FT
LOAD COMBINATIONS							
	D	L	Hs	AXIAL		DEPTH:	<b>12</b> IN
ASD	<b>1</b>	<b>1</b>	<b>1</b>	<b>18 k</b>	Service	AREA:	9.00 SF
ULT	<b>1.2</b>	<b>1.6</b>	<b>1</b>	<b>25 k</b>	Factored	COLUMN DATA	
$\phi$ ( shear )	<b>0.75</b>					LENGTH:	<b>4</b> IN
$\phi$ ( flexure )	<b>0.9</b>					WIDTH:	<b>4</b> IN
include ftg self weight	<b>no</b>			SW =	1.4 k		

**CONCRETE SPECS**

F'c: **2,500** PSI  
 Fy: **60,000** PSI  
 d: (DEPTH-3.5"):  
 Conc Density **150** PCF  
 Conc Ftg Weight **1.35** kips

**SOIL**

ALLOW. BEARING: **2.00** KSF  
 ACTUAL BEARING: 2.00 KSF  
 ULT BEARING: 2.80 KSF  
**OK**

**CONCRETE BEAM; SHEAR**

Vu2l: 5 KIPS  
 Vu2w: 5 IN  
 Vu2(max): 5 IN<sup>2</sup>  
 $\phi Vc2$ : 23 KIPS  
 $SR_2 = Vu_2(max) / Vc_2 =$  0.229  
**OK**

**CONCRETE PUNCHING SHEAR**

Vu1: 22 KIPS  
 bo: 50 IN  
 bo \* d: 425 IN<sup>2</sup>  
 $\phi Vc1$ : 64 KIPS  
 $SR_1 = Vu_1 / Vc_1 =$  0.348  
**OK**

**WIDTH****CONCRETE BEAM; BENDING**

Muw: 7.47 K-FT  
 $A_{s( req )}$ : 0.26 IN<sup>2</sup>@ d=8.50 "  
 $A_{s( req )}/FT$ : 0.09 IN<sup>2</sup>/FT  
 Mcr 27.00 K-FT  
 Ms 5.33 K-FT

**LENGTH****CONCRETE BEAM; BENDING**

Mul: 7.47 K-FT  
 $A_{s( req )}$ : 0.26 IN<sup>2</sup>@ d=8.50 "  
 $A_{s( req )}/FT$ : 0.09 IN<sup>2</sup>/FT  
 Mcr 27.00 K-FT  
 Ms 5.33 K-FT

number of bars **3**  
 bar size **4**  
 As **0.60** in<sup>2</sup>  
 d **8.5** inches  
 $\phi Mn$  22 K-FT @ d=8.50 "  
 $\phi Mn / Mu1$  2.99  
 Mcr/Ms = 5.06  
 $\phi Mn / Mcr =$  0.83

PROJECT NAME: **Bradley Heights Apts**  
 PROJECT NUMBER: **23.007**  
 SOLUTIONS 4 STRUCTURES  
 STRUCTURAL ENGINEERING CONSULTANTS

SHEET OF  
 DATE: 4/15/2022  
 DESIGN BY: **MRO**

**SINGLE FOOTING DESIGN TABLE**

**3.50 ft x 3.50 ft x 12 inches thick**  
**(4)-#4 BOT EA. WAY**

**3.5'x3.5'x12 " ..2ksf**

LOADS	D	L	Hs			FOOTING SIZE	
	<b>12 k</b>	<b>12 k</b>	<b>0 k</b>			LENGTH:	<b>3.50</b> FT
Ftg Self	1.8 k			WIDTH:	<b>3.50</b> FT		
LOAD COMBINATIONS						DEPTH:	<b>12</b> IN
	D	L	Hs	AXIAL	AREA:	12.25 SF	
ASD	<b>1</b>	<b>1</b>	<b>1</b>	<b>25 k</b> Service	COLUMN DATA		
ULT	<b>1.2</b>	<b>1.6</b>	<b>1</b>	<b>34 k</b> Factored	LENGTH:	<b>4</b> IN	
$\phi$ ( shear )	<b>0.75</b>				WIDTH:	<b>4</b> IN	
$\phi$ ( flexure )	<b>0.9</b>						
include ftg self weight	<b>no</b>			SW = 1.8 k			

**CONCRETE SPECS**

F'c: **2,500** PSI  
 Fy: **60,000** PSI  
 d: (DEPTH-3.5"):  
 Conc Density **150** PCF  
 Conc Ftg Weight **1.8375** kips

**SOIL**

ALLOW. BEARING: **2.00** KSF  
 ACTUAL BEARING: 2.00 KSF  
 ULT BEARING: 2.80 KSF  
**OK**

**CONCRETE BEAM; SHEAR**

Vu2l: 9 KIPS  
 Vu2w: 9 IN  
 Vu2(max): 9 IN<sup>2</sup>  
 $\phi Vc2$ : 27 KIPS  
 $SR_2 = Vu_2(max) / Vc_2 =$  0.320  
**OK**

**CONCRETE PUNCHING SHEAR**

Vu1: 31 KIPS  
 bo: 50 IN  
 bo \* d 425 IN<sup>2</sup>  
 $\phi Vc1$ : 64 KIPS  
 $SR_1 = Vu_1 / Vc_1 =$  0.490  
**OK**

**WIDTH****CONCRETE BEAM; BENDING**

Muw: 12.28 K-FT  
 $A_{s( req )}$ : 0.43 IN<sup>2</sup>@ d=8.50 "  
 $A_{s( req )}/FT$ : 0.12 IN<sup>2</sup>/FT  
 Mcr 31.50 K-FT  
 Ms 8.77 K-FT

**LENGTH****CONCRETE BEAM; BENDING**

Mul: 12.28 K-FT  
 $A_{s( req )}$ : 0.43 IN<sup>2</sup>@ d=8.50 "  
 $A_{s( req )}/FT$ : 0.12 IN<sup>2</sup>/FT  
 Mcr 31.50 K-FT  
 Ms 8.77 K-FT

number of bars **4**  
 bar size **4**  
 As **0.80** in<sup>2</sup>  
 d **8.5** inches  
 $\phi Mn$  30 K-FT @ d=8.50 "  
 $\phi Mn / Mu1$  2.41  
 Mcr/Ms = 3.59  
 $\phi Mn / Mcr =$  0.94

# Lateral

Building G



Job # 23.007

Sheet:

Designed: MRO

Date: 5/29/23

Checked:

Date:

**Project:** Bradley Heights Apartments**SEISMIC ANALYSIS:**

IBC 2018 / ASCE 7-16

**Site Class:**Site Class: **C**  (IBC 1613.3.2, ASCE Table 20.3-1)**Site Location:**

Latitude: 47.1652 Longitude: -122.2921

**Site Coefficients:** (USGS Open-File Report 01-437)

$S_S = 1.263$        $F_a = 1.20$   
 $S_1 = 0.435$        $F_V = 1.50$   
 $S_{MS} = F_a * S_S = 1.516$  (IBC Eq.16-37)  
 $S_{M1} = F_V * S_1 = 0.653$  (IBC Eq.16-38)

**Spectral Response Parameters:**

$S_{DS} = 2/3 * S_{MS} = 1.010$  (IBC Eq.16-39)  
 $S_{D1} = 2/3 * S_{M1} = 0.435$  (IBC Eq.16-40)

**Structure Period:**

$T_a = C_t * (h_n)^x = 0.3817$  (ASCE Eq. 12.8-7)  
 $h_n = 51$  Ft.      Structural Height Section 11.2  
 $C_t = 0.02$  (ASCE Table 12.8-2)  
 $x = 0.75$  (ASCE Table 12.8-2)   
 $C_u = 1.4$  (ASCE Table 12.8-1)  
 $T_{(MAX)} = C_u * T_a = 0.5344$  (ASCE 12.8.2)

**Seismic Use Group:**Risk Category:  I or II, III, IV (ASCE7 11.5.1)      I = 1.00 (ASCE Table 1.5-2)**Seismic Design Category:**

Seismic Design Category: D (IBC 1613.3.5, ASCE 11.6)  
 Seismic Design Category ( $S_{DS}$ ): D IBC Table 1613.3.5(1), ASCE Table 11.6-1 Short Period ( $S_{DS}$ )  
 Seismic Design Category ( $S_{D1}$ ): D IBC Table 1613.3.5(2), ASCE Table 11.6-2 1 Second Period ( $S_{D1}$ )

**Seismic Response Coefficients**

$C_S = S_{DS} / (R / I_E) = 0.155$  (ASCE Eq 12.8-2)  
 $R = 6.5$  (ASCE 7 Table 12.2-1) wood shear wall  
 $I_E = 1.00$  (ASCE Table 1.5-2)  
 $CS(Max) = 0.175$   
 $S_{D1} / ((R / I_E) * T_a) = 0.175$  (ASCE Eq 12.8-3) for  $T \leq T_L$  OK       $T_L = 4$   
 $S_{D1} * T_L / ((R / I_E) * T_a^2) = 1.837$  (ASCE Eq 12.8-4) for  $T > T_L$  OK      ASCE Section 12.8 & 11.4.6  
 $CS(Min) = 0.044$  (ASCE fig. 22-14 thru 22-17)  
 $0.044 S_{DS} I \geq 0.01 = 0.044$  (ASCE Eq 12.8-5)  
 Not Required  $S_1 \leq 0.6g$  (ASCE Eq 12.8-6)

$V = C_S * W = 0.1554 W$  (Ultimate Strength)  
 $V_a = C_S / 1.4 * W = 0.1110 W$  (Allowable Stress)



⚠ This is a beta release of the new ATC Hazards by Location website. Please [contact us](#) with feedback.

🔗 The ATC Hazards by Location website will not be updated to support ASCE 7-22. [Find out why.](#)

**ATC** Hazards by Location

**Search Information**

**Coordinates:** 47.16516801120486, -122.2920663220895  
**Elevation:** 386 ft  
**Timestamp:** 2023-05-11T15:08:01.436Z  
**Hazard Type:** Seismic  
**Reference Document:** ASCE7-16  
**Risk Category:** II  
**Site Class:** C

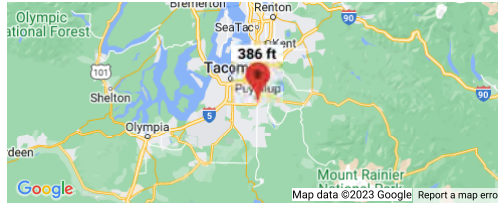

**MCER Horizontal Response Spectrum**

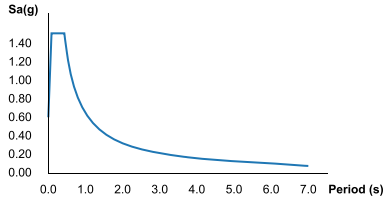

**Design Horizontal Response Spectrum**

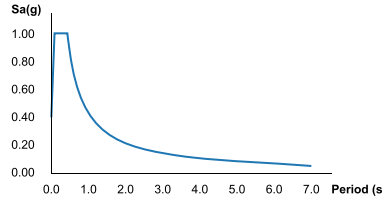

**Basic Parameters**

Name	Value	Description
S <sub>S</sub>	1.264	MCE <sub>R</sub> ground motion (period=0.2s)
S <sub>1</sub>	0.436	MCE <sub>R</sub> ground motion (period=1.0s)
S <sub>MS</sub>	1.516	Site-modified spectral acceleration value
S <sub>M1</sub>	0.654	Site-modified spectral acceleration value
S <sub>DS</sub>	1.011	Numeric seismic design value at 0.2s SA
S <sub>D1</sub>	0.436	Numeric seismic design value at 1.0s SA

**Additional Information**

Name	Value	Description
SDC	D	Seismic design category
F <sub>a</sub>	1.2	Site amplification factor at 0.2s
F <sub>v</sub>	1.5	Site amplification factor at 1.0s
CR <sub>S</sub>	0.914	Coefficient of risk (0.2s)
CR <sub>1</sub>	0.898	Coefficient of risk (1.0s)
PGA	0.5	MCE <sub>G</sub> peak ground acceleration
F <sub>PGA</sub>	1.2	Site amplification factor at PGA
PGA <sub>M</sub>	0.6	Site modified peak ground acceleration
T <sub>L</sub>	6	Long-period transition period (s)
S <sub>sRT</sub>	1.264	Probabilistic risk-targeted ground motion (0.2s)
S <sub>sUH</sub>	1.383	Factored uniform-hazard spectral acceleration (2% probability of exceedance in 50 years)
S <sub>sD</sub>	1.5	Factored deterministic acceleration value (0.2s)
S <sub>1RT</sub>	0.436	Probabilistic risk-targeted ground motion (1.0s)
S <sub>1UH</sub>	0.485	Factored uniform-hazard spectral acceleration (2% probability of exceedance in 50 years)
S <sub>1D</sub>	0.6	Factored deterministic acceleration value (1.0s)
PGA <sub>d</sub>	0.5	Factored deterministic acceleration value (PGA)

The results indicated here DO NOT reflect any state or local amendments to the values or any delineation lines made during the building code adoption process. Users should confirm any output obtained from this tool with the local Authority Having Jurisdiction before proceeding with design.

Please note that the ATC Hazards by Location website will not be updated to support ASCE 7-22. [Find out why.](#)

**Disclaimer**

Hazard loads are provided by the U.S. Geological Survey [Seismic Design Web Services](#).

While the information presented on this website is believed to be correct, ATC and its sponsors and contributors assume no responsibility or liability for its accuracy. The material presented in the report should not be used or relied upon for any specific application without competent examination and verification of its accuracy, suitability and applicability by engineers or other licensed professionals. ATC does not intend that the use of this information replace the sound judgment of such competent professionals, having experience and knowledge in the field of practice, nor to substitute for the standard of care required of such professionals in interpreting and applying the results of the report provided by this website. Users of the information from this website assume all liability arising from such use. Use of the output of this website does not imply approval by the governing building code bodies responsible for building code approval and interpretation for the building site described by latitude/longitude location in the report.

PRMU20240280 BLDG G



Job # 23.007

Sheet:

Designed: TLC

Date: 5/29/23

Checked:

Date:

Project: Bradley Heights Apartments 3 story

**WIND ANALYSIS:**

IBC 2018 / ASCE 7-16

**Risk Category**

II I, II, III or IV Figure 26.5-1B

I<sub>w</sub> = 1.00 (ASCE Table 1.5-2)

100 Typical

Basic Wind Speed, V = 97 mph Section 26.5.1

Exposure Category: B Section 26.7.2

Mean Roof Height, h = 35.32 feet

Alpha = 7

Parapet Height above roof, p = - feet

Z<sub>g</sub> = 1200

Building Width, B = 60.00 feet

Building Length, L = 158.00 feet

Enclosed Building

Ground Elevation factor: 386 Elev. (ft) Section 26.9

GC<sub>pi</sub> = +/- 0.18 Table 26.13-1

G = 0.8500 gust effect factor defined in section 26.11.1

K<sub>z</sub> = 2.01 (z/Z<sub>g</sub>)<sup>2/alpha</sup> (ASCE 7-16 Table 27.3-1) Section 26.10.1

K<sub>zt</sub> = (1 + K<sub>1</sub> K<sub>2</sub> K<sub>3</sub>)<sup>2</sup> = 1.00 (ASCE 7-16 Eq. 26.8-1) Section 26.8.2

K<sub>e</sub> = 0.99 (ASCE 7-16 Table 26.9-1) Section 26.9

K<sub>d</sub> = 0.85 (ASCE 7-16 Table 26-1) Section 26.6

I = 1.00 (ASCE 7-16 Table 1.5-2)

Windward: P = qGC<sub>p</sub> - q<sub>i</sub>(GC<sub>pi</sub>) (ASCE 7-16) (Eq. 27.3-1)

C<sub>p</sub> = 0.8 (windward) Figure 27.3-1

Table 27.3-1 Eq. 27.3-1 Eq. 27.4-1a Eq. 27.4-1b Eq. 27.4-1 Eq. 27.4-1

h feet	Sec. 27.3.1 K <sub>z</sub>	Sec. 27.3.2 q <sub>z</sub> (psf)	External q <sub>z</sub> GC <sub>p</sub>	Internal - q <sub>i</sub> (GC <sub>pi</sub> )	Total q G C <sub>p</sub> + q <sub>i</sub> (GC <sub>pi</sub> )	Total q G C <sub>p</sub> - q <sub>i</sub> (GC <sub>pi</sub> )
10	0.51	10.33	7.03	2.67	9.69	4.36
20	0.62	12.60	8.57	2.67	11.23	5.90
30	0.70	14.14	9.62	2.67	12.29	6.95
35	0.73	14.78	10.05	2.67	12.72	7.38
35.32	0.73	14.82	10.08	2.67	12.75	7.41
-	-	-	-	-	-	-
-	-	-	-	-	-	-
-	-	-	-	-	-	-
-	-	-	-	-	-	-
-	-	-	-	-	-	-
35.32	q=q <sub>h</sub> =q <sub>i</sub> =	14.82	10.08	2.67	12.75	7.41
0	q=q <sub>p</sub> =	0.00	-	-	-	Parapet

**Totals**

h feet	Windward + Leeward	
	Along B	Along L
10	10.4 (6.2)	13.3 (8.0)
20	11.9 (7.2)	14.9 (8.9)
30	13.0 (7.8)	15.9 (9.6)
35	13.4 (8.1)	16.4 (9.8)
35.32	13.5 (8.1)	16.4 (9.8)
-	-	-
-	-	-
-	-	-
-	-	-
-	-	-
35.32	13.5 (8.1)	16.4 (9.8)
Parapet	0.0 (0.0)	0.0 (0.0)

( ) values are ASD = ULT x 0.6

Leeward: P = qGC<sub>p</sub> - q<sub>i</sub>(GC<sub>pi</sub>) (ASCE 7-16) (Eq. 27.3-1)

External Internal Total Total

q <sub>h</sub> (psf)	q <sub>h</sub> GC <sub>p</sub>	- q <sub>i</sub> (GC <sub>pi</sub> )	q G C <sub>p</sub> - q <sub>i</sub> (GC <sub>pi</sub> )	q G C <sub>p</sub> + q <sub>i</sub> (GC <sub>pi</sub> )
14.82	-6.30	2.67	-3.63	-8.97
14.82	-3.38	2.67	-0.71	-6.05

Figure 27.3-1

C<sub>p</sub> = -0.5 (Leeward along L)

C<sub>p</sub> = -0.27 (Leeward along B)

Parapet: P<sub>p</sub> = q<sub>p</sub> GC<sub>pn</sub> (ASCE 7-16) (Eq. 27.3-3)

Windward Leeward

q <sub>p</sub> (psf)	q <sub>p</sub> GC <sub>pn</sub>	q <sub>p</sub> GC <sub>pn</sub>
0.00	0.00	0.00

Section 27.3.4

GC<sub>pn</sub> = 1.5 (Windward Parapet)

GC<sub>pn</sub> = -1.0 (Leeward Parapet)

Walls: P = q<sub>h</sub> [(GC<sub>p</sub>) - (GC<sub>pi</sub>)] (ASCE 7-16) (Eq. 30.3-1)

h ≤ 60 ft

Table 26.13-1

Area (ft <sup>2</sup> )	GC <sub>p</sub> (4&5)	Windward	GC <sub>p</sub> (4)	Leeward	GC <sub>p</sub> (5)	Leeward	GC <sub>pi</sub>	GC <sub>pi</sub>	q <sub>h</sub> (psf)
10	1.00	17.5 (10.5)	-1.10	-19.0 (-11.4)	-1.40	-23.4 (-14.0)	0.18	-0.18	14.82
25	0.93	16.4 (9.9)	-1.03	-17.9 (-10.8)	-1.26	-21.3 (-12.8)	0.18	-0.18	14.82
50	0.88	15.7 (9.4)	-0.98	-17.1 (-10.3)	-1.15	-19.8 (-11.9)	0.18	-0.18	14.82
200	0.77	14.1 (8.4)	-0.87	-15.6 (-9.3)	-0.94	-16.6 (-10.0)	0.18	-0.18	14.82

PRMU20240280 BLDG G



Job # 23.007

Sheet:

Designed: TLC

Date: 5/29/23

Checked:

Date:

Project: Bradley Heights Apartments 3 story

**WIND ANALYSIS:**

IBC 2018 / ASCE 7-16

**Risk Category**

II I, II, III or IV Figure 26.5-1B

I<sub>w</sub> = 1.00 (ASCE Table 1.5-2)

100 Typical

Basic Wind Speed, V = 97 mph Section 26.5.1

Exposure Category: B Section 26.7.2

Mean Roof Height, h = 44.50 feet

Alpha = 7

Parapet Height above roof, p = - feet

Z<sub>g</sub> = 1200

Building Width, B = 60.00 feet

Building Length, L = 158.00 feet

Enclosed Building

Ground Elevation factor: 386 Elev. (ft) Section 26.9

GC<sub>pi</sub> = +/- 0.18 Table 26.13-1

G = 0.8500 gust effect factor defined in section 26.11.1

K<sub>z</sub> = 2.01 (z/Z<sub>g</sub>)<sup>2/alpha</sup> (ASCE 7-16 Table 27.3-1) Section 26.10.1

K<sub>zt</sub> = (1 + K<sub>1</sub> K<sub>2</sub> K<sub>3</sub>)<sup>2</sup> = 1.00 (ASCE 7-16 Eq. 26.8-1) Section 26.8.2

K<sub>e</sub> = 0.99 (ASCE 7-16 Table 26.9-1) Section 26.9

K<sub>d</sub> = 0.85 (ASCE 7-16 Table 26-1) Section 26.6

I = 1.00 (ASCE 7-16 Table 1.5-2)

Windward: P = qGC<sub>p</sub> - q<sub>i</sub>(GC<sub>pi</sub>) (ASCE 7-16) (Eq. 27.3-1)

C<sub>p</sub> = 0.8 (windward) Figure 27.3-1

Table 27.3-1 Eq. 27.3-1 Eq. 27.4-1a Eq. 27.4-1b Eq. 27.4-1 Eq. 27.4-1

h feet	Sec. 27.3.1 K <sub>z</sub>	Sec. 27.3.2 q <sub>z</sub> (psf)	External q <sub>e</sub> GC <sub>p</sub>	Internal - q <sub>i</sub> (GC <sub>pi</sub> )	Total q <sub>e</sub> GC <sub>p</sub> + q <sub>i</sub> (GC <sub>pi</sub> )	Total q <sub>e</sub> GC <sub>p</sub> - q <sub>i</sub> (GC <sub>pi</sub> )
10	0.51	10.33	7.03	2.85	9.88	4.18
20	0.62	12.60	8.57	2.85	11.42	5.72
30	0.70	14.14	9.62	2.85	12.47	6.77
35	0.73	14.78	10.05	2.85	12.90	7.20
40	0.76	15.36	10.44	2.85	13.29	7.59
44.5	0.78	15.83	10.77	2.85	13.62	7.92
-	-	-	-	-	-	-
-	-	-	-	-	-	-
-	-	-	-	-	-	-
-	-	-	-	-	-	-
44.5	q=q <sub>h</sub> =q <sub>i</sub> =	15.83	10.77	2.85	13.62	7.92
0	q=q <sub>p</sub> =	0.00	-	-	-	Parapet

**Totals**

h feet	Windward + Leeward	
	Along B	Along L
10	10.6 (6.4)	13.8 (8.3)
20	12.2 (7.3)	15.3 (9.2)
30	13.2 (7.9)	16.3 (9.8)
35	13.7 (8.2)	16.8 (10.1)
40	14.1 (8.4)	17.2 (10.3)
44.5	14.4 (8.6)	17.5 (10.5)
-	-	-
-	-	-
-	-	-
-	-	-
44.5	14.4 (8.6)	17.5 (10.5)
Parapet	0.0 (0.0)	0.0 (0.0)

( ) values are ASD = ULT x 0.6

Leeward: P = qGC<sub>p</sub> - q<sub>i</sub>(GC<sub>pi</sub>) (ASCE 7-16) (Eq. 27.3-1)

External Internal Total Total

q <sub>h</sub> (psf)	q <sub>h</sub> GC <sub>p</sub>	- q <sub>i</sub> (GC <sub>pi</sub> )	q <sub>e</sub> GC <sub>p</sub> - q <sub>i</sub> (GC <sub>pi</sub> )	q <sub>e</sub> GC <sub>p</sub> + q <sub>i</sub> (GC <sub>pi</sub> )
15.83	-6.73	2.85	-3.88	-9.58
15.83	-3.61	2.85	-0.76	-6.46

Figure 27.3-1

C<sub>p</sub> = -0.5 (Leeward along L)

C<sub>p</sub> = -0.27 (Leeward along B)

Parapet: P<sub>p</sub> = q<sub>p</sub> GC<sub>pn</sub> (ASCE 7-16) (Eq. 27.3-3)

Windward Leeward

q <sub>p</sub> (psf)	q <sub>p</sub> GC <sub>pn</sub>	q <sub>p</sub> GC <sub>pn</sub>
0.00	0.00	0.00

Section 27.3.4

GC<sub>pn</sub> = 1.5 (Windward Parapet)

GC<sub>pn</sub> = -1.0 (Leeward Parapet)

Walls: P = q<sub>h</sub> [(GC<sub>p</sub>) - (GC<sub>pi</sub>)] (ASCE 7-16) (Eq. 30.3-1)

h ≤ 60 ft

Table 26.13-1

Area (ft <sup>2</sup> )	GC <sub>p</sub> (4&5)	Windward	GC <sub>p</sub> (4)	Leeward	GC <sub>p</sub> (5)	Leeward	GC <sub>pi</sub>	GC <sub>pi</sub>	q <sub>h</sub> (psf)
10	1.00	18.7 (11.2)	-1.10	-20.3 (-12.2)	-1.40	-25.0 (-15.0)	0.18	-0.18	15.83
25	0.93	17.6 (10.5)	-1.03	-19.2 (-11.5)	-1.26	-22.8 (-13.7)	-0.18	-0.18	15.83
50	0.88	16.7 (10.0)	-0.98	-18.3 (-11.0)	-1.15	-21.1 (-12.7)	-0.18	-0.18	15.83
200	0.77	15.0 (9.0)	-0.87	-16.6 (-10.0)	-0.94	-17.7 (-10.6)	-0.18	-0.18	15.83

PRMU20240280 BLDG G

⚠ This is a beta release of the new ATC Hazards by Location website. Please [contact us](#) with feedback.

🔗 The ATC Hazards by Location website will not be updated to support ASCE 7-22. [Find out why.](#)

### ATC Hazards by Location

#### Search Information

Coordinates: 47.16516801120486, -122.2920663220895  
 Elevation: 386 ft  
 Timestamp: 2023-05-11T15:05:14.182Z  
 Hazard Type: Wind

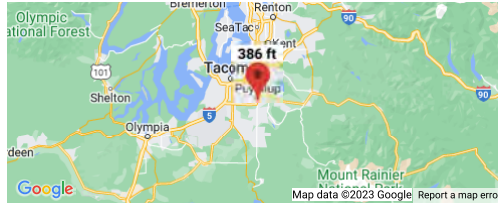

ASCE 7-16		ASCE 7-10		ASCE 7-05	
MRI 10-Year	67 mph	MRI 10-Year	72 mph	ASCE 7-05 Wind Speed	85 mph
MRI 25-Year	73 mph	MRI 25-Year	79 mph		
MRI 50-Year	78 mph	MRI 50-Year	85 mph		
MRI 100-Year	82 mph	MRI 100-Year	91 mph		
Risk Category I	92 mph	Risk Category I	100 mph		
Risk Category II	97 mph	Risk Category II	110 mph		
Risk Category III	104 mph	Risk Category III-IV	115 mph		
Risk Category IV	108 mph				

The results indicated here DO NOT reflect any state or local amendments to the values or any delineation lines made during the building code adoption process. Users should confirm any output obtained from this tool with the local Authority Having Jurisdiction before proceeding with design.  
 Please note that the ATC Hazards by Location website will not be updated to support ASCE 7-22. [Find out why.](#)

#### Disclaimer

Hazard loads are interpolated from data provided in ASCE 7 and rounded up to the nearest whole integer. Per ASCE 7, islands and coastal areas outside the last contour should use the last wind speed contour of the coastal area – in some cases, this website will extrapolate past the last wind speed contour and therefore, provide a wind speed that is slightly higher. NOTE: For queries near wind-borne debris region boundaries, the resulting determination is sensitive to rounding which may affect whether or not it is considered to be within a wind-borne debris region.

Mountainous terrain, gorges, ocean promontories, and special wind regions shall be examined for unusual wind conditions.

While the information presented on this website is believed to be correct, ATC and its sponsors and contributors assume no responsibility or liability for its accuracy. The material presented in the report should not be used or relied upon for any specific application without competent examination and verification of its accuracy, suitability and applicability by engineers or other licensed professionals. ATC does not intend that the use of this information replace the sound judgment of such competent professionals, having experience and knowledge in the field of practice, nor to substitute for the standard of care required of such professionals in interpreting and applying the results of the report provided by this website. Users of the information from this website assume all liability arising from such use. Use of the output of this website does not imply approval by the governing building code bodies responsible for building code approval and interpretation for the building site described by latitude/longitude location in the report.

PRMU20240280 BLDG G

202 27th Ave SE, Puyallup, WA 98374



Restaurants

Hotels

Things to do

Transit

Parking

Pharmacies

ATMs



### 202 27th Ave SE

Building



Directions



Save



Nearby



Send to phone



Share

202 27th Ave SE, Puyallup, WA 98374

Suggest an edit on 202 27th Ave SE

Add a missing place

Add your business

### Photos



PRMU20240280 BLDG G

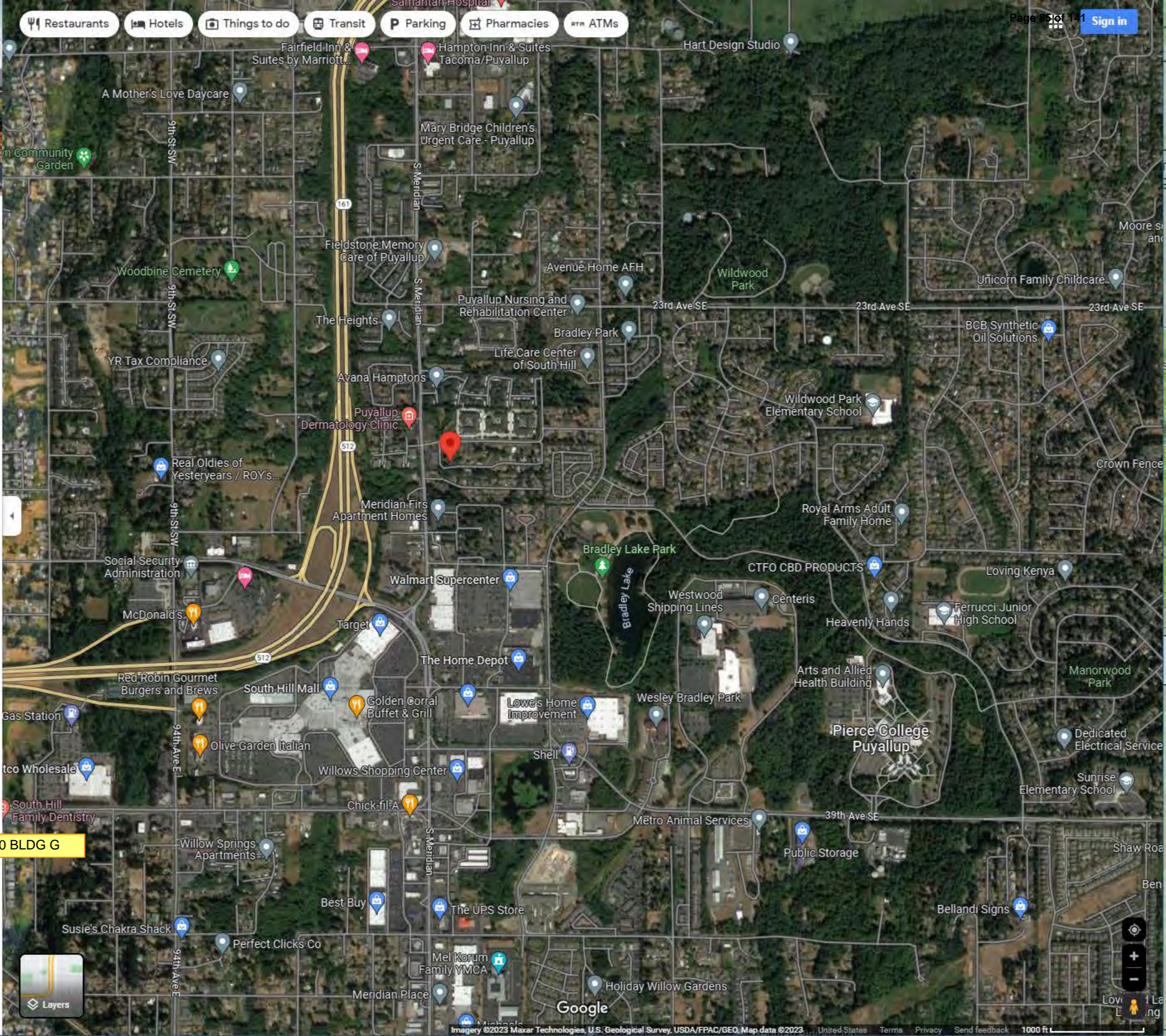

Google

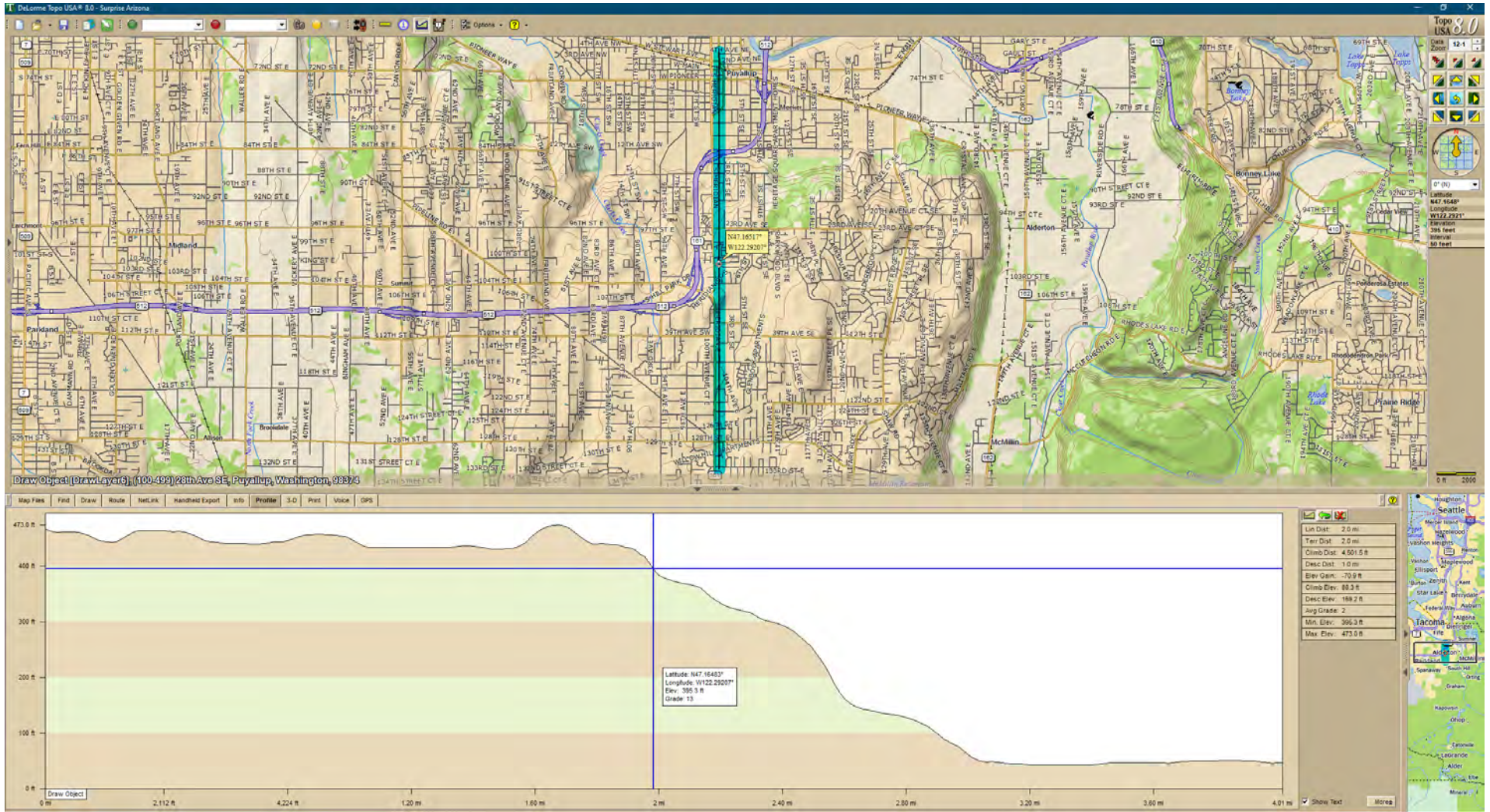

Kzt = 1.0

## 26.8 TOPOGRAPHIC EFFECTS

 $K_{ZT}$ 

1

 Exposure Category: 

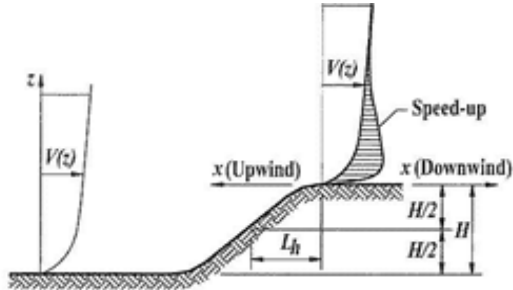
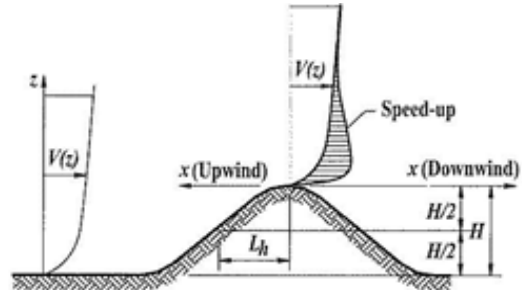
 Hill Shape: 

**ESCARPMENT**

**2-D RIDGE OR 3-D AXISYMMETRICAL HILL**

$$EL_{top} = 473 \text{ ft}$$

Elevation at crest of 2D Escarpment

$$EL_{Bot} = 142.1 \text{ ft}$$

Elevation at base of 2D Escarpment

$$H = 330.9 \text{ ft}$$

307.55

$$H/2 = 165.45 \text{ ft}$$

$$L_h = 3541 \text{ ft}$$

$$H/L_h = 0.0934$$

Kzt Calc Not Required

$$K_1 = 0.75H/L_h = 0.070086$$

$$K_1/(H/L_h) = 0.75$$

(Figure 26.8-1)

$$K_2 = \left(1 - \frac{|x|}{\mu L_h}\right) = 0.602372$$

$$x = 2112 \text{ ft}$$

5311.5 distance KZT no long affects wind speed

$$\mu = 1.5$$

(Figure 26.8-1)

$$L_h = 3541 \text{ ft}$$

$$K_3 = e^{-\gamma z/L_h} = 0.989466$$

$$z = 15 \text{ ft}$$

height above ground surface at site

$$\gamma = 2.5$$

(Figure 26.8-1)

$$L_h = 3541 \text{ ft}$$

$$K_{ZT} = (1 + K_1 K_2 K_3)^2 =$$

$$1.00 \quad (\text{Eq. 26.8-1})$$

# 26.8 TOPOGRAPHIC EFFECTS

$K_{ZT}$

2

Exposure Category: B  
 Hill Shape: 2D Escarpment

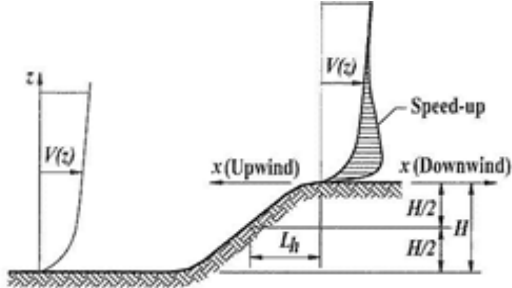

**ESCARPMENT**

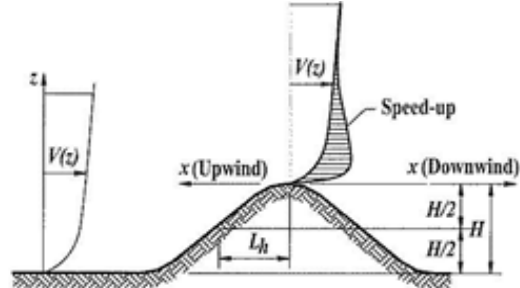

**2-D RIDGE OR 3-D AXISYMMETRICAL HILL**

EL <sub>top</sub> =	301 ft	Elevation at crest of 2D Escarpment
EL <sub>Bot</sub> =	142.1 ft	Elevation at base of 2D Escarpment
H =	158.9 ft	
H/2 =	79.45 ft	221.55
L <sub>h</sub> =	940 ft	
H/L <sub>h</sub> =	0.1690	Kzt Calc Not Required

$K_1 = 0.75H/L_h = 0.126782$   
 $K_1/(H/L_h) = 0.75$  (Figure 26.8-1)

$K_2 = (1 - \frac{|x|}{\mu L_h}) = 0.562234$   
 x = 1646 ft 3760 distance KZT no long affects wind speed

downwind  
 $\mu = 4$  (Figure 26.8-1)  
 $L_h = 940$  ft

$K_3 = e^{-\gamma z/L_h} = 0.960892$   
 $z = 15$  ft height above ground surface at site  
 $\gamma = 2.5$  (Figure 26.8-1)  
 $L_h = 940$  ft

$K_{ZT} = (1 + K_1 K_2 K_3)^2 = 1.00$  (Eq. 26.8-1)



## 26.8 TOPOGRAPHIC EFFECTS

 $K_{ZT}$ 

3

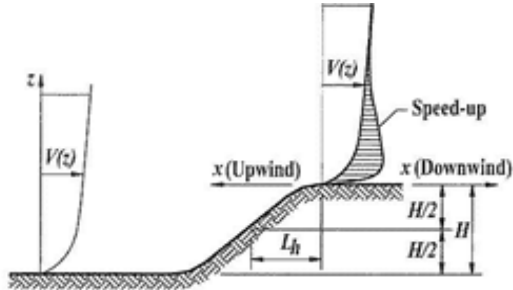
 Exposure Category: B  
 Hill Shape: 2D Escarpment

**ESCARPMENT**

$$EL_{top} = 177.4 \text{ ft}$$

$$EL_{Bot} = 0 \text{ ft}$$

$$H = 177.4 \text{ ft}$$

$$H/2 = 88.7 \text{ ft}$$

$$L_h = 1144 \text{ ft}$$

$$H/L_h = 0.1551$$

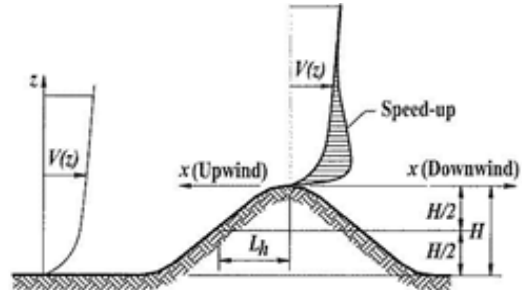
**2-D RIDGE OR 3-D AXISYMMETRICAL HILL**

Elevation at crest of 2D Escarpment

Elevation at base of 2D Escarpment

Kzt Calc Not Required

$$K_1 = 0.75H/L_h = 0.116302$$

$$K_1/(H/L_h) = 0.75$$

(Figure 26.8-1)

$$K_2 = \left(1 - \frac{|x|}{\mu L_h}\right) = 0$$

$$x = 6598 \text{ ft}$$

4576 distance KZT no long affects wind speed

downwind

$$\mu = 4$$

(Figure 26.8-1)

$$L_h = 1144 \text{ ft}$$

$$K_3 = e^{-\gamma z/L_h} = 0.967752$$

$$z = 15 \text{ ft}$$

height above ground surface at site

$$\gamma = 2.5$$

(Figure 26.8-1)

$$L_h = 1144 \text{ ft}$$

$$K_{ZT} = (1 + K_1 K_2 K_3)^2 = 1.00 \quad (\text{Eq. 26.8-1})$$

## K<sub>ZT</sub> Check

### 26.8 TOPOGRAPHIC EFFECTS

#### 26.8.1 Wind Speed-Up over Hills, Ridges, and Escarpments

Wind speed-up effects at isolated hills, ridges, and escarpments constituting abrupt changes in the general topography, located in any exposure category, shall be included in the determination of the wind loads when buildings and other site conditions and locations of structures meet all of the following conditions:

Y    N  
  

1. The hill, ridge, or escarpment is isolated and unobstructed upwind by other similar topographic features of comparable height for 100 times the height of the topographic feature ( $100H$ ) or 2 mi (3.22 km), whichever is less. This distance shall be measured horizontally from the point at which the height  $H$  of the hill, ridge, or escarpment is determined.

2. The hill, ridge, or escarpment protrudes above the height of upwind terrain features within a 2-mi (3.22-km) radius in any quadrant by a factor of two or more.

3. The structure is located as shown in Fig. 26.8-1 in the upper one-half of a hill or ridge or near the crest of an escarpment.

4.  $H/L_h \geq 0.2$ .

5.  $H$  is greater than or equal to 15 ft (4.5 m) for Exposure C and D and 60 ft (18 m) for Exposure B.

#### 26.8.2 Topographic Factor

The wind speed-up effect shall be included in the calculation of design wind loads by using the factor  $K_{zt}$ :

$$K_{zt} = (1 + K_1 K_2 K_3)^2 \quad (26.8-1)$$

where  $K_1$ ,  $K_2$ , and  $K_3$  are given in Fig. 26.8-1.

If site conditions and locations of buildings and other structures do not meet all the conditions specified in Section 26.8.1 then  $K_{zt} = 1.0$ .

K<sub>zt</sub> = 1.0

**Diagrams**

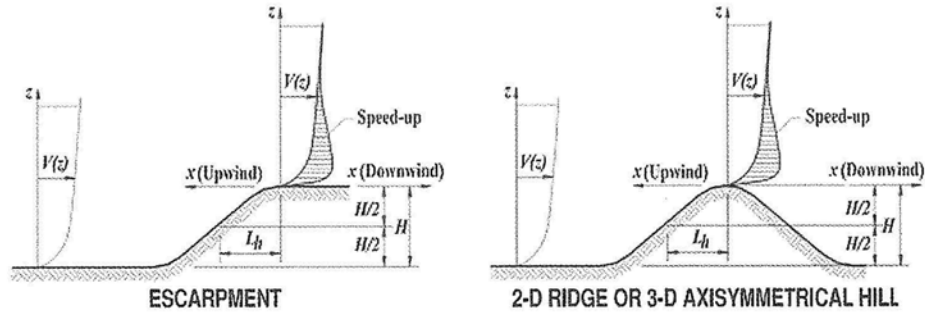

**Topographic Multipliers for Exposure C<sup>a,b,c</sup>**

$H/L_h$	$K_1$ Multiplier			$x/L_h$	$K_2$ Multiplier			$z/L_h$	$K_3$ Multiplier		
	2D Ridge	2D Escarpment	3D Axisymmetrical Hill		2D Escarpment	All Other Cases	2D Ridge		2D Escarpment	3D Axisymmetrical Hill	
0.20	0.29	0.17	0.21	0.00	1.00	1.00	0.00	1.00	1.00	1.00	
0.25	0.36	0.21	0.26	0.50	0.88	0.67	0.10	0.74	0.78	0.67	
0.30	0.43	0.26	0.32	1.00	0.75	0.33	0.20	0.55	0.61	0.45	
0.35	0.51	0.30	0.37	1.50	0.63	0.00	0.30	0.41	0.47	0.30	
0.40	0.58	0.34	0.42	2.00	0.50	0.00	0.40	0.30	0.37	0.20	
0.45	0.65	0.38	0.47	2.50	0.38	0.00	0.50	0.22	0.29	0.14	
0.50	0.72	0.43	0.53	3.00	0.25	0.00	0.60	0.17	0.22	0.09	
				3.50	0.13	0.00	0.70	0.12	0.17	0.06	
				4.00	0.00	0.00	0.80	0.09	0.14	0.04	
							0.90	0.07	0.11	0.03	
							1.00	0.05	0.08	0.02	
							0.50	0.01	0.02	0.00	
							2.00	0.00	0.00	0.00	

<sup>a</sup>For values of  $H/L_h$ ,  $x/L_h$ , and  $z/L_h$  other than those shown, linear interpolation is permitted.  
<sup>b</sup>For  $H/L_h > 0.5$ , assume that  $H/L_h = 0.5$  for evaluating  $K_1$  and substitute  $2H$  for  $L_h$  for evaluating  $K_2$  and  $K_3$ .  
<sup>c</sup>Multipliers are based on the assumption that wind approaches the hill or escarpment along the direction of maximum slope.

**Notation**

- $H$  = Height of hill or escarpment relative to the upwind terrain, in ft (m).
- $K_1$  = Factor to account for shape of topographic feature and maximum speed-up effect.
- $K_2$  = Factor to account for reduction in speed-up with distance upwind or downwind of crest.
- $K_3$  = Factor to account for reduction in speed-up with height above local terrain.
- $L_h$  = Distance upwind of crest to where the difference in ground elevation is half the height of hill or escarpment, in ft (m).
- $x$  = Distance (upwind or downwind) from the crest to the site of the building or other structure, in ft (m).
- $z$  = Height above ground surface at the site of the building or other structure, in ft (m).
- $\mu$  = Horizontal attenuation factor.
- $\gamma$  = Height attenuation factor.

**Equations**

$$K_{st} = (1 + K_1 K_2 K_3)^2$$

$K_1$  = determined from table below

$$K_2 = (1 - |x|/\mu L_h)$$

$$K_3 = e^{-\gamma z/L_h}$$

**Parameters for Speed-Up over Hills and Escarpments**

Hill Shape	$K_1/(H/L_h)$			$\gamma$	$\mu$	
	Exposure				Upwind of Crest	Downwind of Crest
	B	C	D			
2D ridges (or valleys with negative $H$ in $K_1/(H/L_h)$ )	1.30	1.45	1.55	3	1.5	1.5
2D escarpments	0.75	0.85	0.95	2.5	1.5	4
3D axisymmetrical hill	0.95	1.05	1.15	4	1.5	1.5

wind combined		wind 3 story		wind 3 story + basement		
156	152	10	10.6875	159	10.5	10.6875
		10	9.083333		10.3	9.083333
102	101	10	1.05	103	10	1.05
		10	9.083333		10	9.083333
101	101	10	1.05	101	10	1.05
		10	9.083333		10	9.083333
				101	10	1.05
					10	9.083333

L1 L2 L1

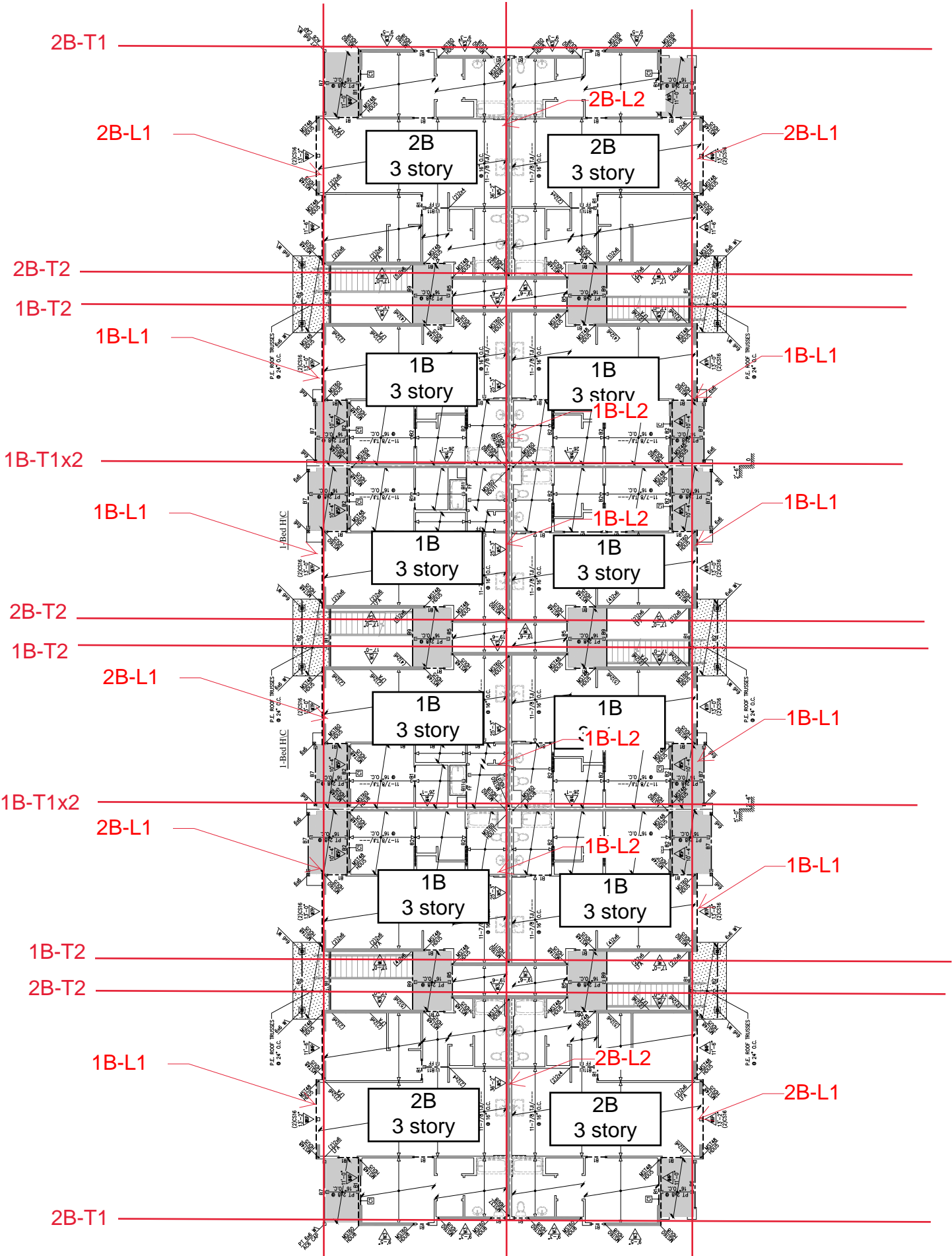

PRMU20240280 BLDG G

Job # 23.002 Sheet:

Designed: TLC Date: 5/29/23

Checked: Date:



Project: Bradley Heights - 3 Story & basement Story  
 Seismic Design: 2 Bedroom units

- Low Flat roof
- Typ Roof/Floor
- Exit 3" Concrete
- not used

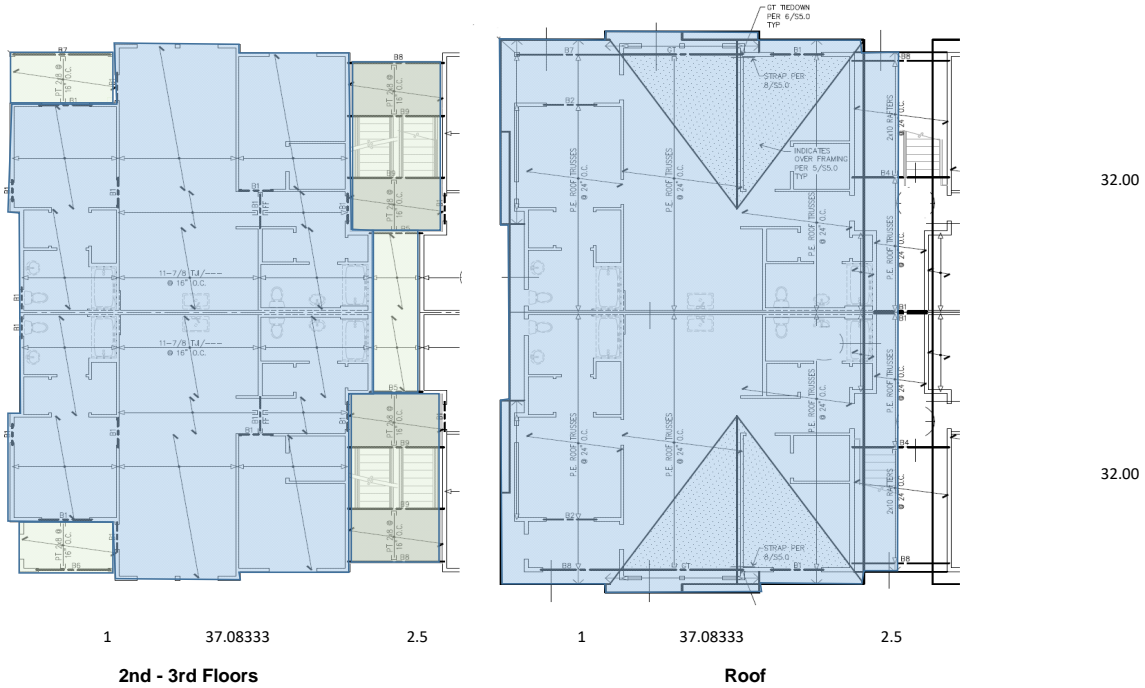

		C <sub>s</sub> /1.4 = 0.111		Typ. Roof (psf) = 22		Typ Floor (psf) = 26		Ext. wall (psf) = 10		Ext. wall (psf) = 20		Wind:	
		Low Roof (psf) = 22		Other Floor (psf) = 47		1hr		2hr					
2Bx1 3 story	Roof	L (ft)	W or h(ft)	psf	W (#)	0.1110W	With	156 plf					
	Typ Roof	1381	1	22	30382	30382	3372	0.615385	0.384615				
	Low Roof	0	1	22	0			L(ft) windward	leeward				
	Ext	64	4.5415	10	2906.56	4359.84	484	3856	6095	32.00	3080	1925	3080
	Int	32	4.5415	10	1453.28			190.4544					96
d1, d2 3rd Floor	Typ Floor	1118	1	26	29068	46834	5199	102 plf					
	Other Floor	378	1	47	17766			L(ft) windward	leeward				
	Ext	64	9.083	10	5813.12	8719.68	968	6166	6730	32.00	2012	1258	2012
	Int	32	9.083	10	2906.56			210.3066					63
	Ext	38.17	9.083	10	3466.981	6933.962	770	5968	6508	40.58	2552	1595	2552
d1, d2 2nd Floor	Typ Floor	1118	1	26	29068	46834	5199	101 plf					
	Other Floor	378	1	47	17766			L(ft) windward	leeward				
	Ext	64	9.083	10	5813.12	8719.68	968	6166	3365	32.00	1996	1247	1996
	Int	32	9.083	10	2906.56			1.83258	105.1533				62
	Ext	38.17	9.083	10	3466.981	6933.962	770	5968	3254	40.58	2531	1582	2531
								1.834264	80.17464				
								2hr				Wind:	

# 2BEDROOM

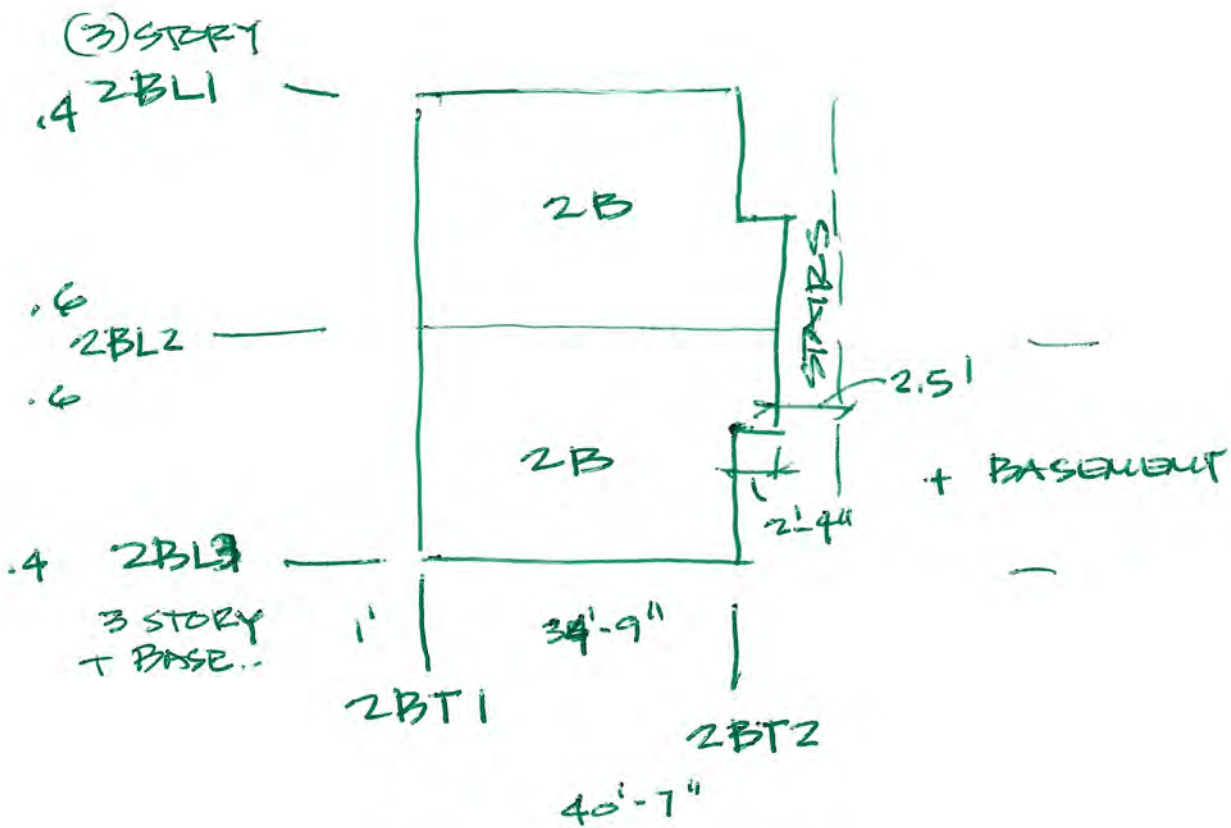

$$\frac{18.375}{40.5833} = 0.45$$

$$\frac{22.205}{40.5833} = 0.55$$

2Bx1 3 story + B	Roof	L (ft)	W or h(ft)	psf	W (#)	0.1110W	With	156 plf
	Typ Roof	1381	1	22	30382	30382	3372	Vertical Distribution
	Low Roof	0	1	22	0			L(ft) windward leeward
	Ext	64	4.5415	10	2906.56	4359.84	484	3856 6457
	Int	32	4.5415	10	1453.28			201.7684
	Ext	38.17	4.5415	10	1733.491	3466.981	385	3757 6286
	Int	38.17	4.5415	10	1733.491			154.8861
	<b>3rd Floor</b>	L (ft)	W or h(ft)	psf	W (#)	0.1110W		<b>102 plf</b>
	Typ Floor	1118	1	26	29068	46834	5199	L(ft) windward leeward
	Other Floor	378	1	47	17766			
	Ext	64	9.083	10	5813.12	8719.68	968	6166 7950
	Int	32	9.083	10	2906.56			248.4239
	Ext	38.17	9.083	10	3466.981	6933.962	770	5968 7688
	Int	38.17	9.083	10	3466.981			189.4395
	<b>2nd Floor</b>	L (ft)	W or h(ft)	psf	W (#)	0.1110W		<b>101 plf</b>
	Typ Floor	1118	1	26	29068	46834	5199	L(ft) windward leeward
	Other Floor	378	1	47	17766			
	Ext	64	9.083	10	5813.12	8719.68	968	6166 5300
	Int	32	9.083	10	2906.56			165.616
	Ext	38.17	9.083	10	3466.981	6933.962	770	5968 5125
	Int	38.17	9.083	10	3466.981			126.293
	<b>1st Floor</b>	L (ft)	W or h(ft)	psf	W (#)	0.1110W		<b>101 plf</b>
	Typ Floor	1118	1	26	29068	46834	5199	L(ft) windward leeward
	Other Floor	378	1	47	17766			
	Ext	64	9.083	10	5813.12	8719.68	968	6166 2650
	Int	32	9.083	10	2906.56			82.80798
	Ext	38.17	9.083	10	3466.981	6933.962	770	5968 2563
	Int	38.17	9.083	10	3466.981			63.14651

Unit B2 →				Unit B2 ↑			
Roof	3080	Wind	6095	Roof	2442	Roof	3906
		Seismic			5932		5932
3rd	2012	Wind	6730	3rd	1595	3rd	2552
		Seismic			6508		6508
2nd	1996	Wind	3365	2nd	1582	2nd	2531
		Seismic			3254		3254

Unit B2 + Basement				Unit B2 + Basement			
Roof	3080	Wind	6457	Roof	3906	Roof	2442
		Seismic			6286		6286
3rd	2012	Wind	7950	3rd	2552	3rd	1595
		Seismic			7688		7688
2nd	1996	Wind	5300	2nd	2531	2nd	1582
		Seismic			5125		5125
1st	1996	Wind	2650	1st	2531	2nd	1582
		Seismic			2563		2563

B2 + B2	B2 + B2	max	
6348	6348	6348	Wind
12218	12218	12218	Seismic
4147	4147	4147	Wind
14196	14196	14196	Seismic
4113	4113	4113	Wind
8379	8379	8379	Seismic
2531	1582	2531	Wind
2563	2563	2563	Seismic





Job # 23.002

Sheet:

Designed: TLC

Date: 5/29/23

Checked:

Date:

**Project:** Bradley Heights - 3 Story & basement Story

Diaphragm Design Forces 2 Bedroom units

$$F_x = C_{vx} V \quad (12.8-11)$$

$$F_{Dx} = \frac{\sum_{i=x}^n F_i}{\sum_{i=x}^n w_i} w_{px} \quad (12.10-1)$$

$F_{px}$  = the diaphragm design force at Level x

$F_i$  = the design force applied to level i

$w_i$  = the weight tributary to Level i

$w_{px}$  = the weight tributary to the diaphragm at Level x

$$I_e = 1$$

$$S_{DS} = 0.8787$$

$$\text{Minimum: } F_{px} = 0.2S_{DS}I_e w_{px}$$

$$\text{Maximum: } F_{px} = 0.4S_{DS}I_e w_{px}$$

3- story	D									
	→	$F_i$	$\sum_{i=x}^n F_i$	$w_{xp}$	$\sum_{i=x}^n w_i$	$F_{px}$	Min	Max	$F_{px}$	x factor
Roof		6095	6095	34742	34741.84	6095	6106	12211	6106	1.001803
3rd Floor		6730	12824	55554	90295.52	7890	9763	19526	9763	1.237375
2nd Floor		3365	16189	55554	145849.2	6166	9763	19526	9763	1.583243
3- story	D									use
	↑	$F_i$	$\sum_{i=x}^n F_i$	$w_i$	$\sum_{i=x}^n w_i$	$F_{px}$	Min	Max	$F_{px}$	x factor
Roof		5932	5932	33849	33848.98	5932	5949	11897	5949	1.002724
3rd Floor		6508	12440	53768	87616.94	7634	9449	18898	9449	1.237768
2nd Floor		3254	15694	53768	141384.9	5968	9449	18898	9449	1.583243
4- story	E									use
	→	$F_i$	$\sum_{i=x}^n F_i$	$w_{xp}$	$\sum_{i=x}^n w_i$	$F_{px}$	Min	Max	$F_{px}$	x factor
Roof		6457	6457	34742	34741.84	6457	6106	12211	6457	1
3rd Floor		7950	14406	55554	90295.52	8863	9763	19526	9763	1.101511
2nd Floor		5300	19706	55554	145849.2	7506	9763	19526	9763	1.300706
1st Floor		2650	22356	55554	201402.9	6166	9763	19526	9763	1.583243
4- story										use
	↑	$F_i$	$\sum_{i=x}^n F_i$	$w_i$	$\sum_{i=x}^n w_i$	$F_{px}$	Min	Max	$F_{px}$	x factor
Roof		6286	6286	33849	33848.98	6286	5949	11897	6286	1
3rd Floor		7688	13974	53768	87616.94	8575	9449	18898	9449	1.101899
2nd Floor		5125	19099	53768	141384.9	7263	9449	18898	9449	1.300939
1st Floor		2563	21662	53768	195152.9	5968	9449	18898	9449	1.583243

Unit B2	3 story + Basement	Combined	Line	Line	Line	Line	Line	Line	Line
Unit B2	Unit B2	B2+B2 combined	2B-T1	2B-T2	B2-L1	B2-L2	B2-L3		
3 story	Roof	Roof	0.45	0.55	0.4	0.6	0.4		
Unit B2	Roof	Roof	2857	3491	1232	3696	1232		
3 story	3rd Floor	3rd Floor	5498	6720	2438	7531	2583		
Unit B2	3rd Floor	3rd Floor	1866	2281	805	2415	805		
3 story	2nd Floor	2nd Floor	6388	7808	2692	8808	3180		
Unit B2	2nd Floor	2nd Floor	1851	2262	798	2395	798		
3 story	1st Floor	1st Floor	3771	4609	1346	5199	2120		
Unit B2	1st Floor	1st Floor	1139	1392	0	1198	798		
3 story	Seismic	Seismic	1153	1409	0	1590	1060		
Unit B2	Seismic	Seismic							to concrete retaining wall



Job # 23.007 Sheet:

Designer: TLC Date: 5/26

Checked: Date:

Project: Bradley Height Apartments

2B-L1

Note: forces to this line on the 3 story side can be lower we used the loads from the L3 side for consistency 0.5 (ft) holdown dist from end

Roof: W1	Wind (ASD): 1.232 kips Seismic (ASD): 2.583 kips		72 #/ft 150 #/ft		76 #/ft 160 #/ft						
	use W1P 3.333 ft	SW 2B-L3 -1 2.667 ft	0 ft	use W2P 2.333 ft	SW 2B-L3 -2 2.333 ft	0 ft	0 ft	use W1P 3 ft	SW 2B-L3 -3 3.5 ft	9.083 ft	17.17
Distribution L	3.333 ft	2.667 ft	0 ft	1.815 ft	1.815 ft	0 ft	0 ft	3 ft	3.5 ft	16.13	Actual Distrib
$h/b_s =$	1.5 W1	1.875 W1	0	2.571 W1	2.571 W1	0	0	1.667 W1	1.429 W1		
DL w (plf) =	427.2	427.2	0	178.8	178.8	0	0	429.1	429.1		
0.6M <sub>R</sub> (#-ft) =	1424	911	0	292	292	0	0	1159	1577		
PLF	W E 76 160	W E 76 160	W E 0 0	W E 59 125	W E 59 125	W E 0 0	W E 0 0	W E 76 160	W E 76 160		
M <sub>o1</sub> (#-ft) =	2313 4848	1850 3878	0 0	1259 2639	1259 2639	0 0	0 0	2082 4363	2428 5090		
F (#) =	314 1208	433 1369	0 0	528 1280	528 1280	0 0	0 0	369 1282	284 1171		
Holdown	1000 -	1000 -	1000 -	1000 -	1000 -	1000 -	1000 -	1000 -	1000 -		
	No Holdown NG (see calc next pp OK)	No Holdown NG (see calc next pp OK)	No Holdown OK	No Holdown NG (see calc next pp OK)	No Holdown NG (see calc next pp OK)	No Holdown OK	No Holdown OK	No Holdown NG (see calc next pp OK)	No Holdown NG (see calc next pp OK)		

3rd Floor: W2	Wind (ASD): 0.805 kips Seismic (ASD): 3.18 kips		119 #/ft 336 #/ft		126 #/ft 357 #/ft						
	use W3P 3.333 ft	SW 2B-L3 -1 2.667 ft	0 ft	use W4P 2.333 ft	SW 2B-L3 -2 2.333 ft	0 ft	0 ft	use W3P 3 ft	SW 2B-L3 -3 3.5 ft	9.083 ft	17.17
Distribution L	3.333 ft	2.667 ft	0 ft	1.815 ft	1.815 ft	0 ft	0 ft	3 ft	3.5 ft	16.13	Actual Distrib
$h/b_s =$	1.5 W2	1.875 W2	0	2.571 W2	2.571 W2	0	0	1.667 W2	1.429 W2		
DL w (plf) =	108.2	108.2	0	108.2	108.2	0	0	108.2	108.2		
0.6M <sub>R</sub> (#-ft) =	361	231	0	177	177	0	0	292	398		
PLF	W E 126 357	W E 126 357	W E 0 0	W E 98 278	W E 98 278	W E 0 0	W E 0 0	W E 126 357	W E 126 357		
M <sub>o1</sub> (#-ft) =	3824 10817	3059 8654	0 0	2082 5889	2082 5889	0 0	0 0	3441 9735	4015 11358		
F (#) =	1536 4899	1739 5257	0 0	1567 4396	1567 4396	0 0	0 0	1629 5059	1490 4825		
Holdown	2335 S2	2335 S2	1000 -	2335 S2	2335 S2	1000 -	1000 -	2335 S2	2335 S2		
	MST48 NG (see calc next pp OK)	MST48 NG (see calc next pp OK)	No Holdown OK	MST48 NG (see calc next pp OK)	MST48 NG (see calc next pp OK)	No Holdown OK	No Holdown OK	MST48 NG (see calc next pp OK)	MST48 NG (see calc next pp OK)		

2nd Floor W4	Wind (ASD): 0.798 kips Seismic (ASD): 2.12 kips		165 #/ft 459 #/ft		176 #/ft 489 #/ft						
	use W4P 3.333 ft	SW 2B-L3 -1 2.667 ft	0 ft	use W6P 2.333 ft	SW 2B-L3 -2 2.333 ft	0 ft	0 ft	use W4P 3 ft	SW 2B-L3 -3 3.5 ft	9.083 ft	17.17
Distribution L	3.333 ft	2.667 ft	0 ft	1.815 ft	1.815 ft	0 ft	0 ft	3 ft	3.5 ft	16.13	Actual Distrib
$h/b_s =$	1.5 W4	1.875 W4	0	2.571 W4	2.571 W4	0	0	1.667 W4	1.429 W4		
DL w (plf) =	108.2	108.2	0	108.2	108.2	0	0	108.2	108.2		
0.6M <sub>R</sub> (#-ft) =	361	231	0	177	177	0	0	292	398		
PLF	W E 176 489	W E 176 489	W E 0 0	W E 137 380	W E 137 380	W E 0 0	W E 0 0	W E 176 489	W E 176 489		
M <sub>o1</sub> (#-ft) =	5323 14796	4258 11837	0 0	2898 8056	2898 8056	0 0	0 0	4790 13317	5589 15536		
F (#) =	3287 9994	3597 10614	0 0	3051 8694	3051 8694	0 0	0 0	3428 10269	3220 9871		
Holdown	4065 H3	4065 H3	1000 -	4065 H3	4065 H3	1000 -	1000 -	4065 H3	6970 H4		
	1.05 HDU5 NG (see calc next pp OK)	HDU5 NG	No Holdown OK	HDU5 NG (see calc next pp OK)	HDU5 NG (see calc next pp OK)	No Holdown OK	No Holdown OK	HDU5 NG (see calc next pp OK)	HDU8 NG		



Job # 23.007 Sheet:

Designer: TLC Date: 5/26

Checked: Date:

Project: Bradley Height Apartments

2B-L2

0.5 (ft) holddown dist from end

Roof: W1	Wind (ASD): 3.696 kips Seismic (ASD): 7.531 kips				102 #/ft 208 #/ft				102 #/ft 208 #/ft	
					Use W2 					9.083 ft
Distribution L	0 ft	0 ft	0 ft	0 ft	36.17 ft	0 ft	0 ft	0 ft	0 ft	36.17 ft
$h/b_s =$					0.251 W1					
DL w (plf) =	0				363.1	0				
$0.6M_R$ (#-ft) =	0				142477	0				
PLF	W E	W E	W E	W E	W E	W E	W E	W E	W E	W E
$M_{ot}$ (#-ft) =	0 0	0 0	0 0	0 0	33575 68404	0 0	0 0	0 0	0 0	0 0
F (#) =	0 0	0 0	0 0	0 0	-3053 -2077	0 0	0 0	0 0	0 0	0 0
Holddown	1000 -	1000 -	1000 -	1000 -	1000 -	1000 -	1000 -	1000 -	1000 -	
	No Holddown OK	No Holddown OK	No Holddown OK	No Holddown OK	No Holddown OK	No Holddown OK	No Holddown OK	No Holddown OK	No Holddown OK	

3rd Floor: W3	Wind (ASD): 2.415 kips Seismic (ASD): 8.808 kips				169 #/ft 452 #/ft				169 #/ft 452 #/ft	
					Use W4 					9.083 ft
Distribution L	0 ft	0 ft	0 ft	0 ft	36.17 ft	0 ft	0 ft	0 ft	0 ft	36.17 ft
$h/b_s =$					0.251 W3					
DL w (plf) =	0				108.2	0				
$0.6M_R$ (#-ft) =	0				42446	0				
PLF	W E	W E	W E	W E	W E	W E	W E	W E	W E	W E
$M_{ot}$ (#-ft) =	0 0	0 0	0 0	0 0	55510 148406	0 0	0 0	0 0	0 0	0 0
F (#) =	0 0	0 0	0 0	0 0	-2687 894	0 0	0 0	0 0	0 0	0 0
Holddown	2335 S2	1000 -	1000 -	1000 -	1256 S1	1000 -	1000 -	1000 -	2335 S2	
	MST48 OK	No Holddown OK	No Holddown OK	No Holddown OK	MST37 OK	No Holddown OK	No Holddown OK	No Holddown OK	MST48 OK	

2nd Floor W4	Wind (ASD): 2.395 kips Seismic (ASD): 5.199 kips				235 #/ft 595 #/ft				235 #/ft 595 #/ft	
					Use W5 					9.083 ft
Distribution L	0 ft	0 ft	0 ft	0 ft	36.17 ft	0 ft	0 ft	0 ft	0 ft	36.17 ft
$h/b_s =$					0.251 W4					
DL w (plf) =	0				108.2	0				
$0.6M_R$ (#-ft) =	0				42446	0				
PLF	W E	W E	W E	W E	W E	W E	W E	W E	W E	W E
$M_{ot}$ (#-ft) =	0 0	0 0	0 0	0 0	77265 195628	0 0	0 0	0 0	0 0	0 0
F (#) =	0 0	0 0	0 0	0 0	-1711 5189	0 0	0 0	0 0	0 0	0 0
Holddown	4065 H3	6970 H4	1000 -	1000 -	4065 H3	1000 -	1000 -	6970 H4	9535 H5	
	1.05 HDU5 OK	HDU8 OK	No Holddown OK	No Holddown OK	HDU5 NG	No Holddown OK	No Holddown OK	HDU8 OK	HDU11 OK	



Job # 23.007 Sheet:

Designed TLC Date: 5/26

Checked: Date:

Project: Bradley Height Apartments  
2B-L3

0.5 (ft) holdown dist from end

Roof:	Wind (ASD): 1.232 kips		72 #/ft		76 #/ft		76 #/ft		
W1	Seismic (ASD): 2.583 kips		150 #/ft		160 #/ft		160 #/ft		
	use W1P 3.333 ft	SW 2B-L3 -1 2.667 ft	0 ft	use W2P 2.333 ft	SW 2B-L3 -2 2.333 ft	0 ft	0 ft	use W1P 3 ft	SW 2B-L3 -3 3.5 ft
Distribution L	3.333 ft	2.667 ft	0 ft	1.815 ft	1.815 ft	0 ft	0 ft	3 ft	3.5 ft
$h/b_s =$	1.5 W1	1.875 W1	0	2.571 W1	2.571 W1	0	0	1.667 W1	1.429 W1
DL w (plf) =	427.2	427.2	0	178.8	178.8	0	0	429.1	429.1
$0.6M_R$ (#-ft) =	1424	911	0	292	292	0	0	1159	1577
PLF	W E 76 160	W E 76 160	0 0	W E 59 125	W E 59 125	0 0	0 0	W E 76 160	W E 76 160
$M_{ot}$ (#-ft) =	2313 4848	1850 3878	0 0	1259 2639	1259 2639	0 0	0 0	2082 4363	2428 5090
F (#) =	314 1208	433 1369	0 0	528 1280	528 1280	0 0	0 0	369 1282	284 1171
Holdown	1000 -	1000 -	1000 -	1000 -	1000 -	1000 -	1000 -	1000 -	1000 -
	No Holdown NG	No Holdown NG	No Holdown OK	No Holdown NG	No Holdown NG	No Holdown OK	No Holdown OK	No Holdown NG	No Holdown NG
	(see calc next pp OK)			(see calc next pp OK)			(see calc next pp OK)		
<b>3rd Floor:</b>	Wind (ASD): 0.805 kips		119 #/ft		126 #/ft		126 #/ft		
<b>W2</b>	Seismic (ASD): 3.18 kips		336 #/ft		357 #/ft		357 #/ft		
	use W3P 3.333 ft	SW 2B-L3 -1 2.667 ft	0 ft	use W4P 2.333 ft	SW 2B-L3 -2 2.333 ft	0 ft	0 ft	use W3P 3 ft	SW 2B-L3 -3 3.5 ft
Distribution L	3.333 ft	2.667 ft	0 ft	1.815 ft	1.815 ft	0 ft	0 ft	3 ft	3.5 ft
$h/b_s =$	1.5 W2	1.875 W2	0	2.571 W2	2.571 W2	0	0	1.667 W2	1.429 W2
DL w (plf) =	108.2	108.2	0	108.2	108.2	0	0	108.2	108.2
$0.6M_R$ (#-ft) =	361	231	0	177	177	0	0	292	398
PLF	W E 126 357	W E 126 357	0 0	W E 98 278	W E 98 278	0 0	0 0	W E 126 357	W E 126 357
$M_{ot}$ (#-ft) =	3824 10817	3059 8654	0 0	2082 5889	2082 5889	0 0	0 0	3441 9735	4015 11358
F (#) =	1536 4899	1739 5257	0 0	1567 4396	1567 4396	0 0	0 0	1629 5059	1490 4825
Holdown	2335 S2	2335 S2	1000 -	2335 S2	2335 S2	1000 -	1000 -	2335 S2	2335 S2
	MST48 NG	MST48 NG	No Holdown OK	MST48 NG	MST48 NG	No Holdown OK	No Holdown OK	MST48 NG	MST48 NG
	(see calc next pp OK)			(see calc next pp OK)			(see calc next pp OK)		
<b>2nd Floor</b>	Wind (ASD): 0.798 kips		165 #/ft		176 #/ft		176 #/ft		
<b>W4</b>	Seismic (ASD): 2.12 kips		459 #/ft		489 #/ft		489 #/ft		
	use W4P 3.333 ft	SW 2B-L3 -1 2.667 ft	0 ft	use W6P 2.333 ft	SW 2B-L3 -2 2.333 ft	0 ft	0 ft	use W4P 3 ft	SW 2B-L3 -3 3.5 ft
Distribution L	3.333 ft	2.667 ft	0 ft	1.815 ft	1.815 ft	0 ft	0 ft	3 ft	3.5 ft
$h/b_s =$	1.5 W4	1.875 W4	0	2.571 W4	2.571 W4	0	0	1.667 W4	1.429 W4
DL w (plf) =	108.2	108.2	0	108.2	108.2	0	0	108.2	108.2
$0.6M_R$ (#-ft) =	361	231	0	177	177	0	0	292	398
PLF	W E 176 489	W E 176 489	0 0	W E 137 380	W E 137 380	0 0	0 0	W E 176 489	W E 176 489
$M_{ot}$ (#-ft) =	5323 14796	4258 11837	0 0	2898 8056	2898 8056	0 0	0 0	4790 13317	5589 15536
F (#) =	3287 9994	3597 10614	0 0	3051 8694	3051 8694	0 0	0 0	3428 10269	3220 9871
Holdown	4670 S4	4670 S4	1000 -	4670 S4	4670 S4	1000 -	1000 -	4670 S4	4670 S4
	(2) MST48 NG	(2) MST48 NG	No Holdown OK	(2) MST48 NG	(2) MST48 NG	No Holdown OK	No Holdown OK	(2) MST48 NG	(2) MST48 NG
	(see calc next pp OK)			(see calc next pp OK)			(see calc next pp OK)		
<b>1st Floor</b>	Wind (ASD): 0.798 kips		212 #/ft		225 #/ft		225 #/ft		
<b>W4</b>	Seismic (ASD): 1.06 kips		521 #/ft		554 #/ft		554 #/ft		
	use W5P 3.333 ft	SW 2B-L3 -1 2.667 ft	0 ft	use W6P 2.333 ft	SW 2B-L3 -2 2.333 ft	0 ft	0 ft	use W5P 3 ft	SW 2B-L3 -3 3.5 ft
Distribution L	3.333 ft	2.667 ft	0 ft	1.815 ft	1.815 ft	0 ft	0 ft	3 ft	3.5 ft
$h/b_s =$	1.5 W4	1.875 W4	0	2.571 W4	2.571 W4	0	0	1.667 W4	1.429 W4
DL w (plf) =	108.2	108.2	0	108.2	108.2	0	0	108.2	108.2
$0.6M_R$ (#-ft) =	361	231	0	177	177	0	0	292	398
PLF	W E 225 554	W E 225 554	0 0	W E 175 431	W E 175 431	0 0	0 0	W E 225 554	W E 225 554
$M_{ot}$ (#-ft) =	6821 16786	5457 13429	0 0	3714 9139	3714 9139	0 0	0 0	6139 15107	7162 17625
F (#) =	5567 15791	6009 16705	0 0	4980 13583	4980 13583	0 0	0 0	5767 16195	5475 15613
Holdown	6970 H4	6970 H4	1000 -	6970 H4	6970 H4	1000 -	1000 -	6970 H4	6970 H4
	1.05	HDU8 NG	HDU8 NG	No Holdown OK	HDU8 NG	HDU8 NG	No Holdown OK	HDU8 NG	HDU8 NG
	(see calc next pp OK)			(see calc next pp OK)			(see calc next pp OK)		

Shear Wall Line 2B-L3-1 1st

W Designation

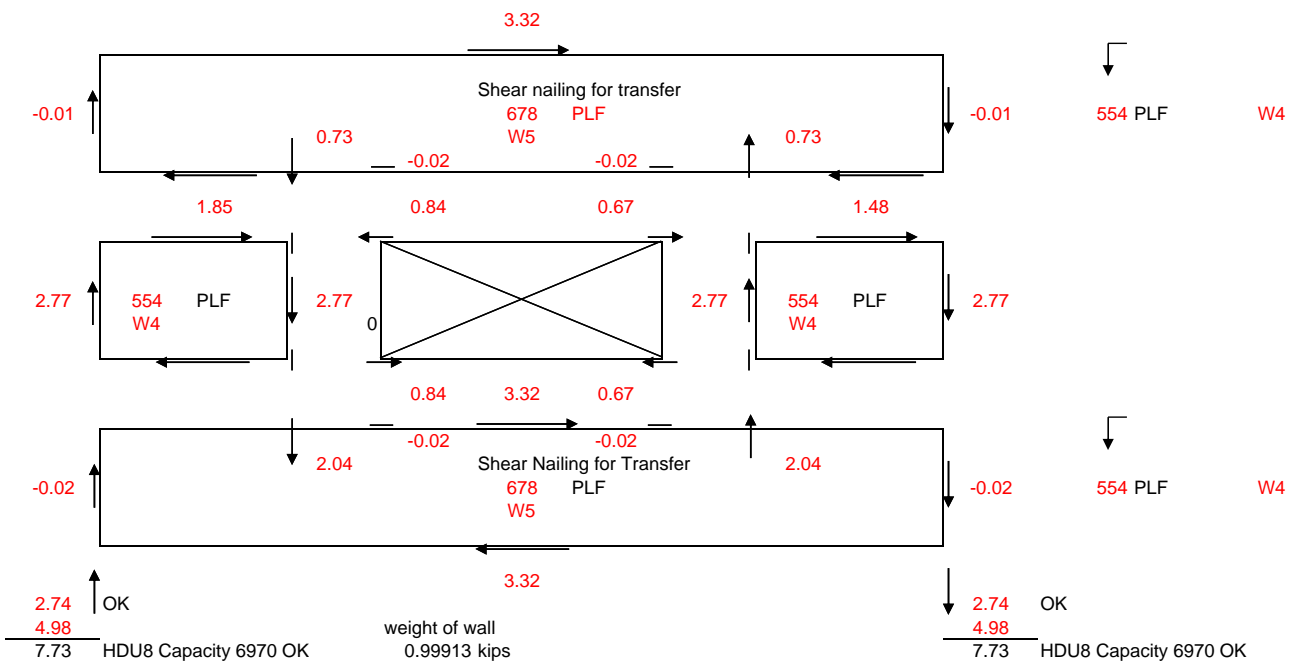
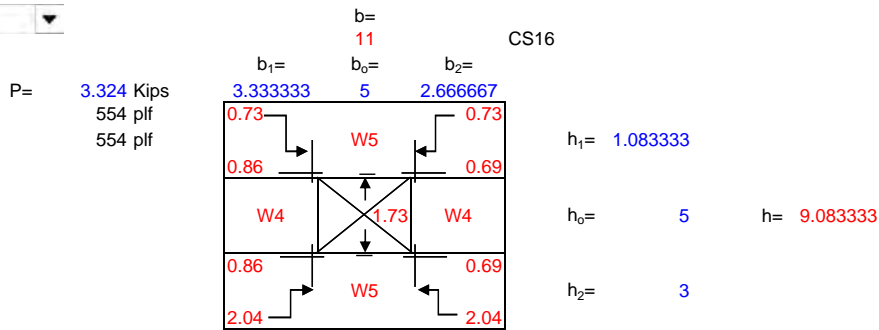

Shear Wall Line 2B-L3-1 2nd

W Designation

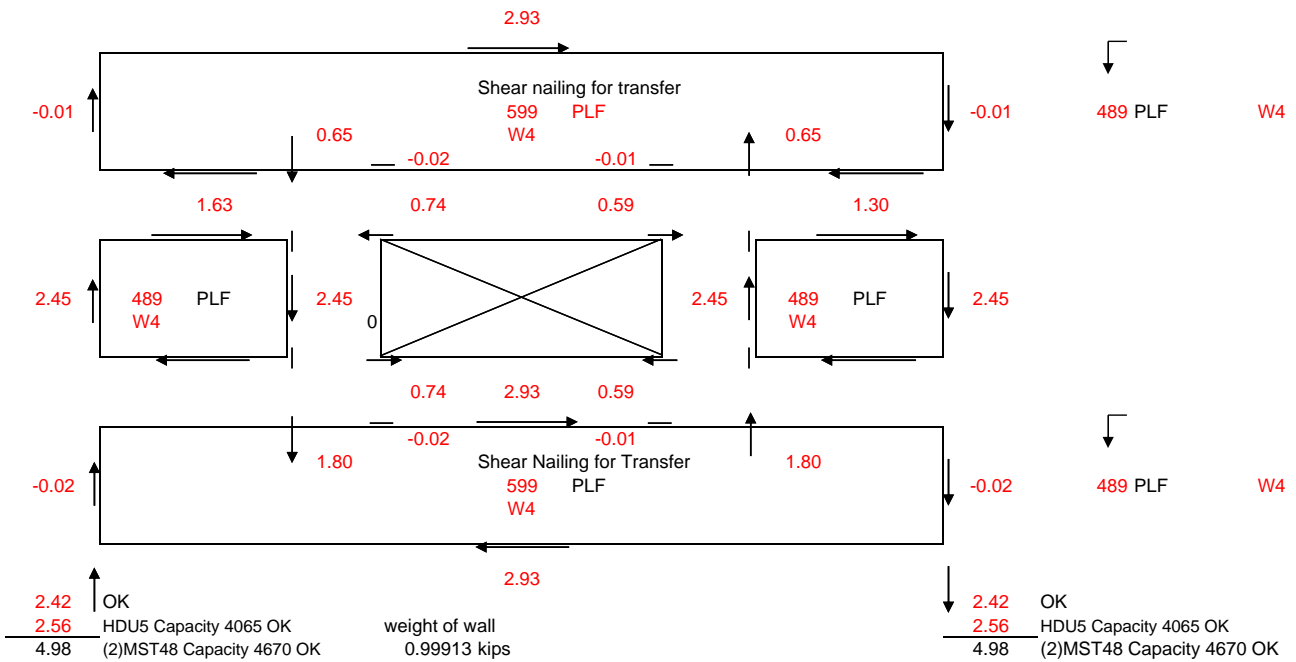
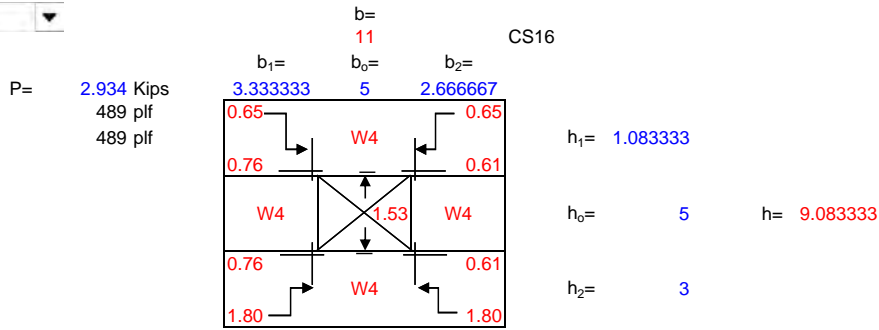

Shear Wall Line 2B-L3-1 3rd

W Designation

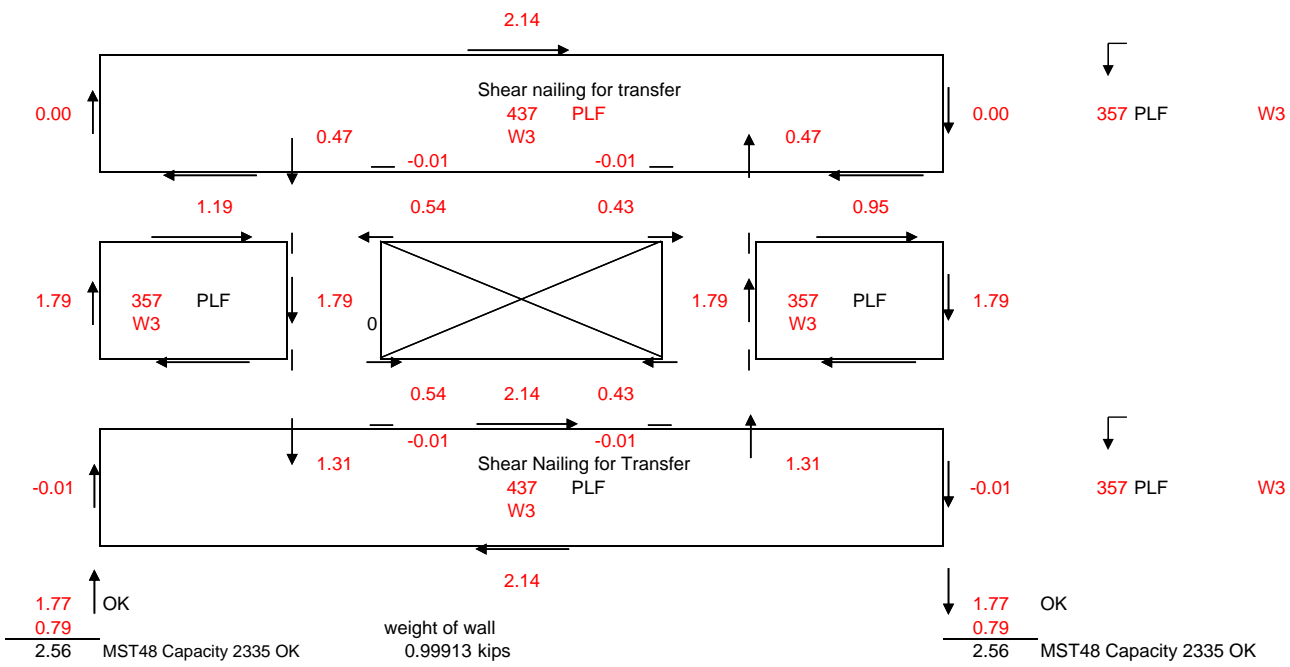
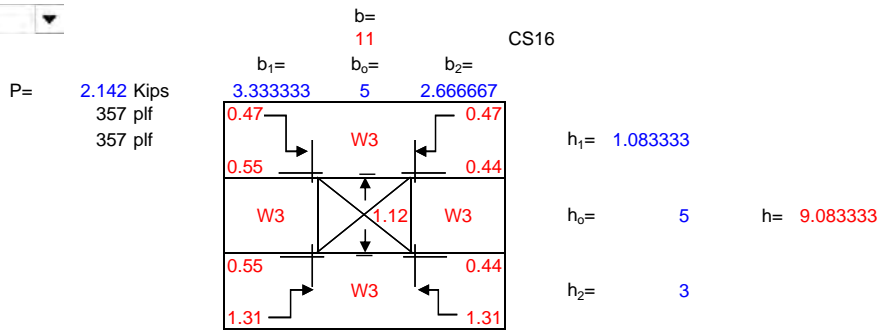



Shear Wall Line 2B-L3-1 roof

W Designation

P= 0.960 Kips  
160 plf  
160 plf

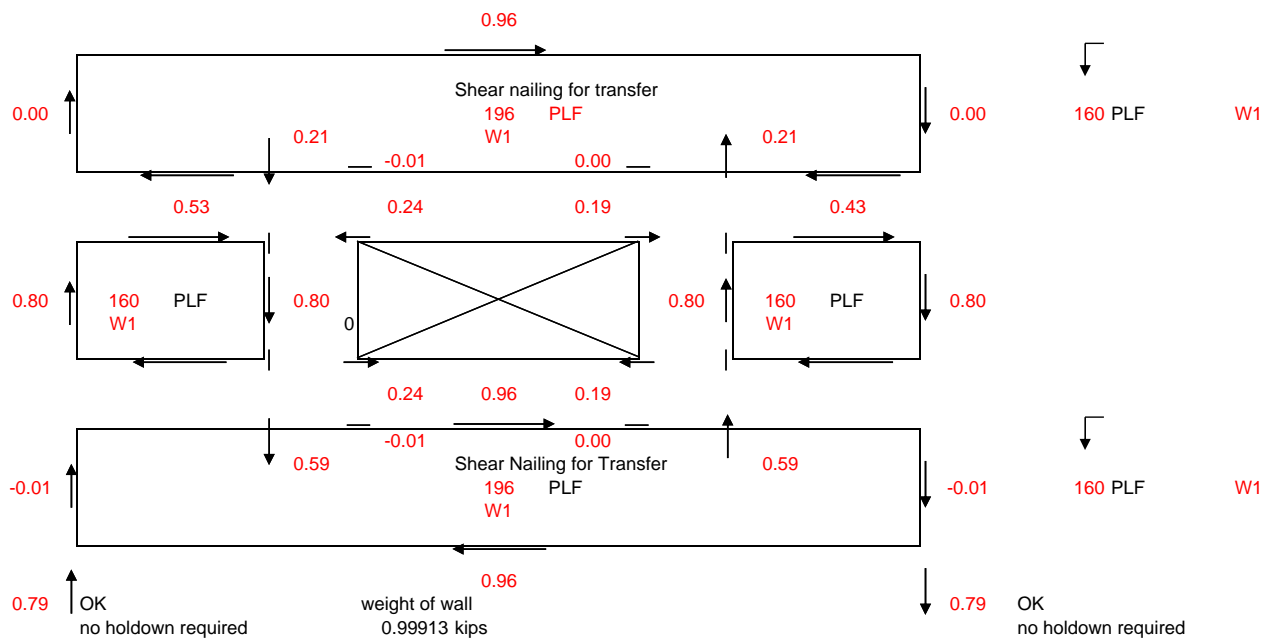
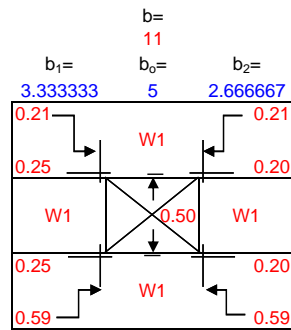

Shear Wall Line 2B-L3-2 1st

W Designation

$P = 2.011$  Kips  
 431 plf  
 431 plf

$b = 13.16667$  (2) CS16 each sheathing layer  
 $b_1 = 2.333333$     $b_o = 8.5$     $b_2 = 2.333333$   
 $h_1 = 1.083333$   
 $h_o = 6$     $h = 9.083333$   
 $h_2 = 2$

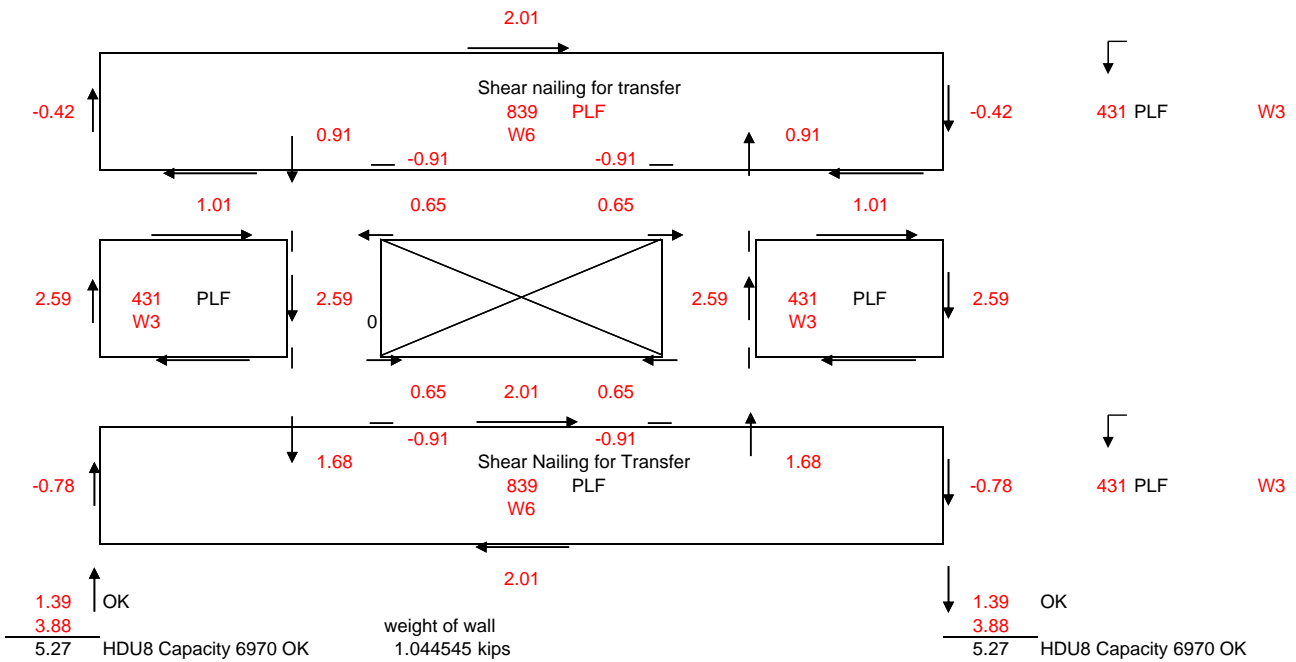
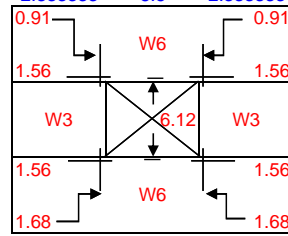

Shear Wall Line 2B-L3-2 2nd

W Designation

P= 1.773 Kips  
380 plf  
380 plf

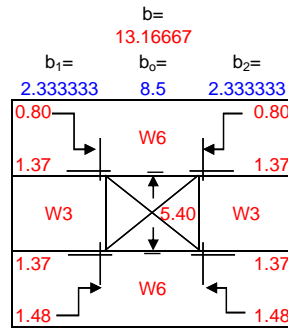

(2) CS16 each sheathing layer

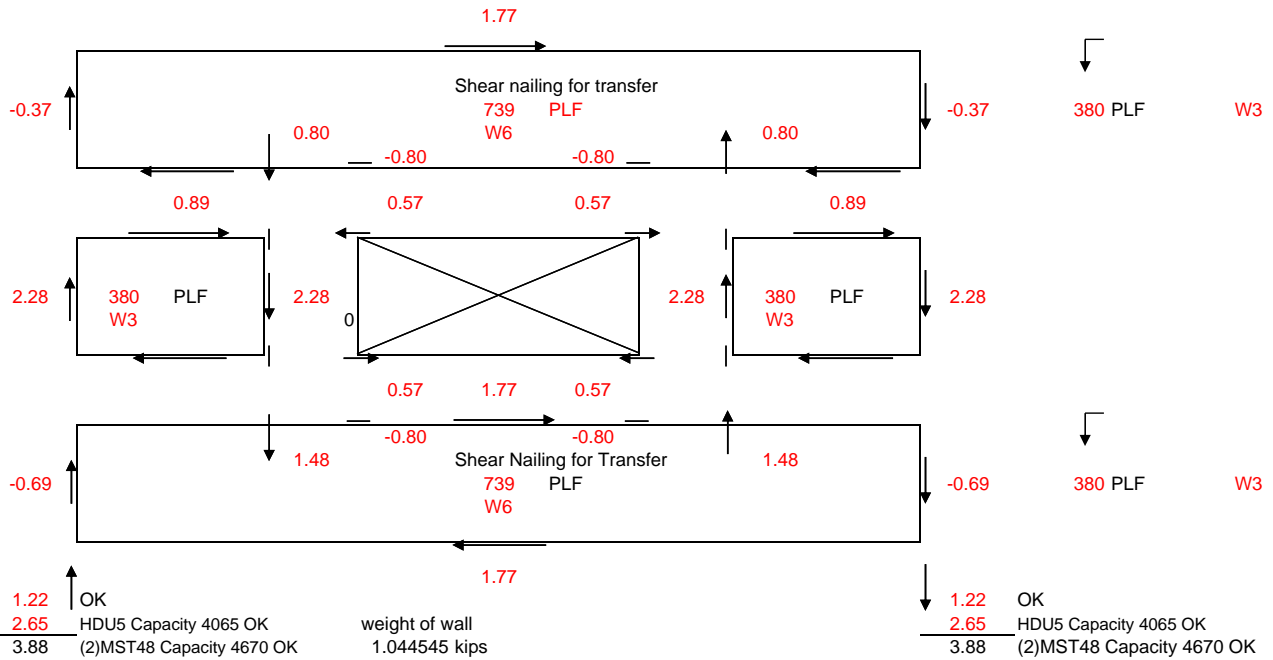

Shear Wall Line 2B-L3-2 3rd

W Designation

P= 1.297 Kips  
278 plf  
278 plf

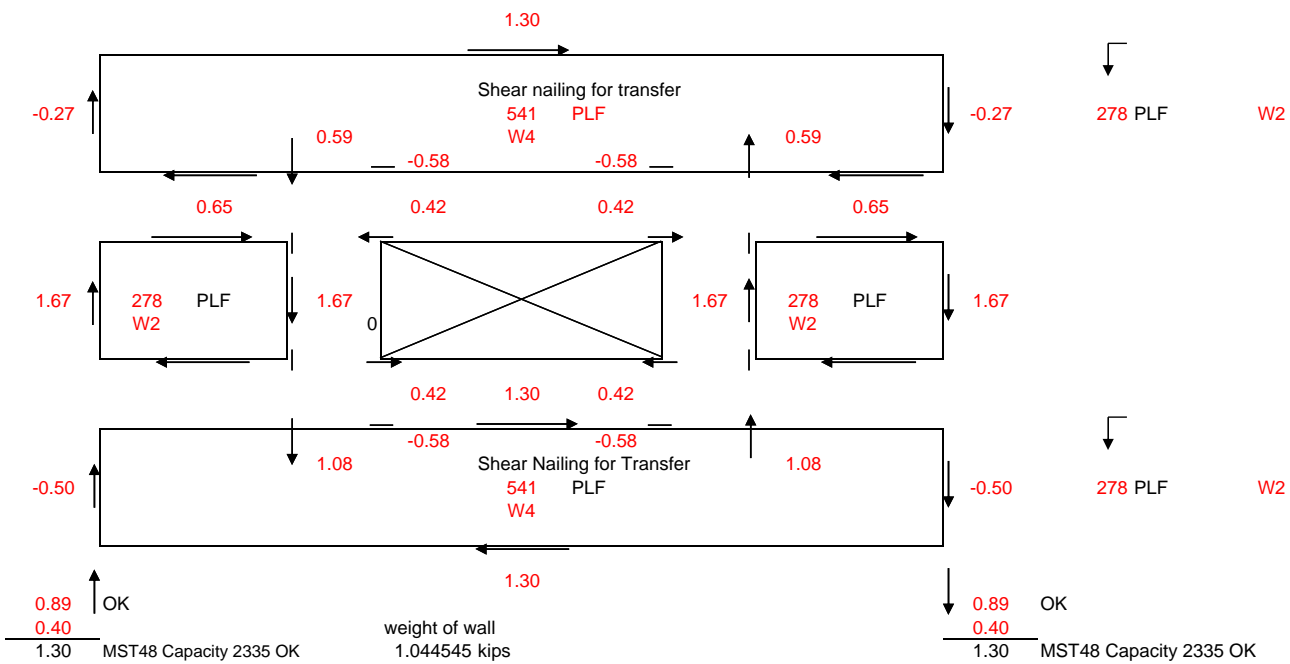
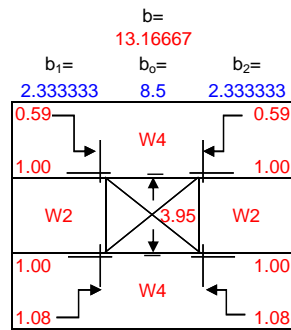

Shear Wall Line 2B-L3-2 roof

W Designation

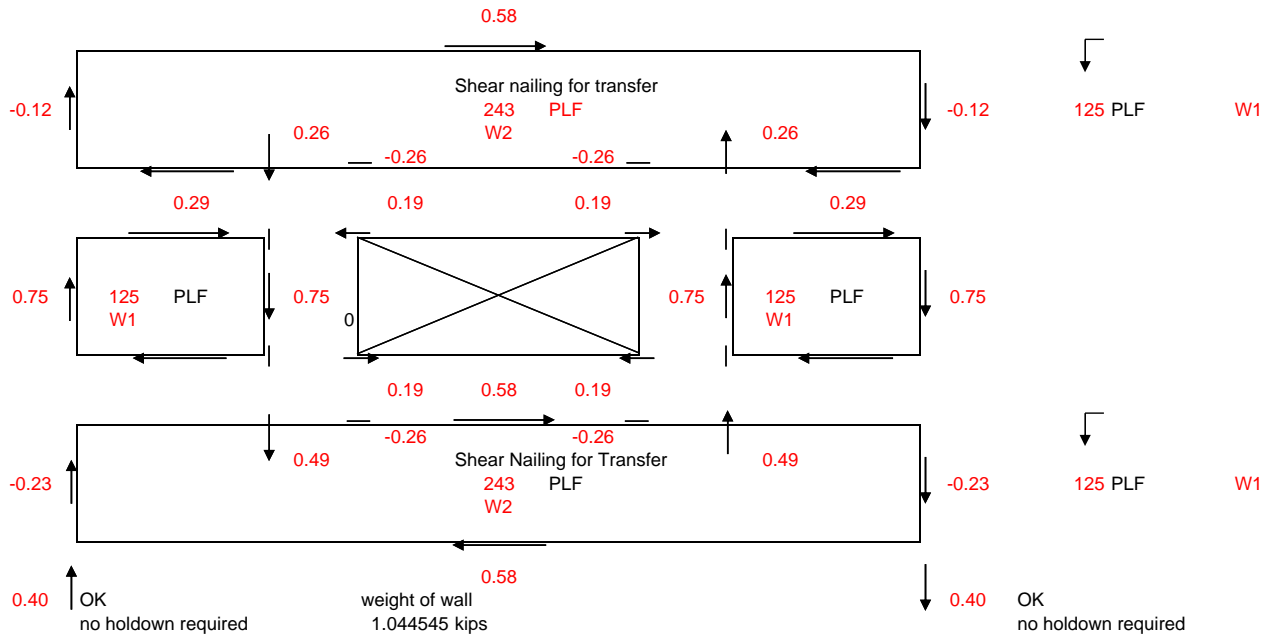
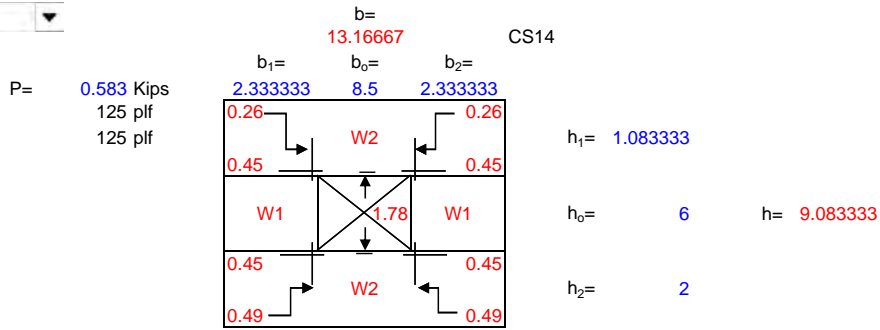

Shear Wall Line 2B-L3-3 1st

W Designation

P= 3.601 Kips  
554 plf  
554 plf

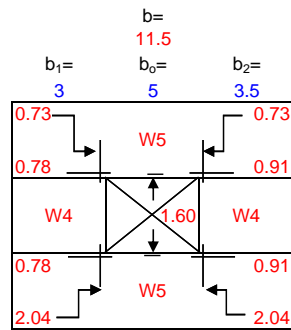

CS16

$h_1 = 1.083333$

$h_0 = 5$       $h = 9.083333$

$h_2 = 3$

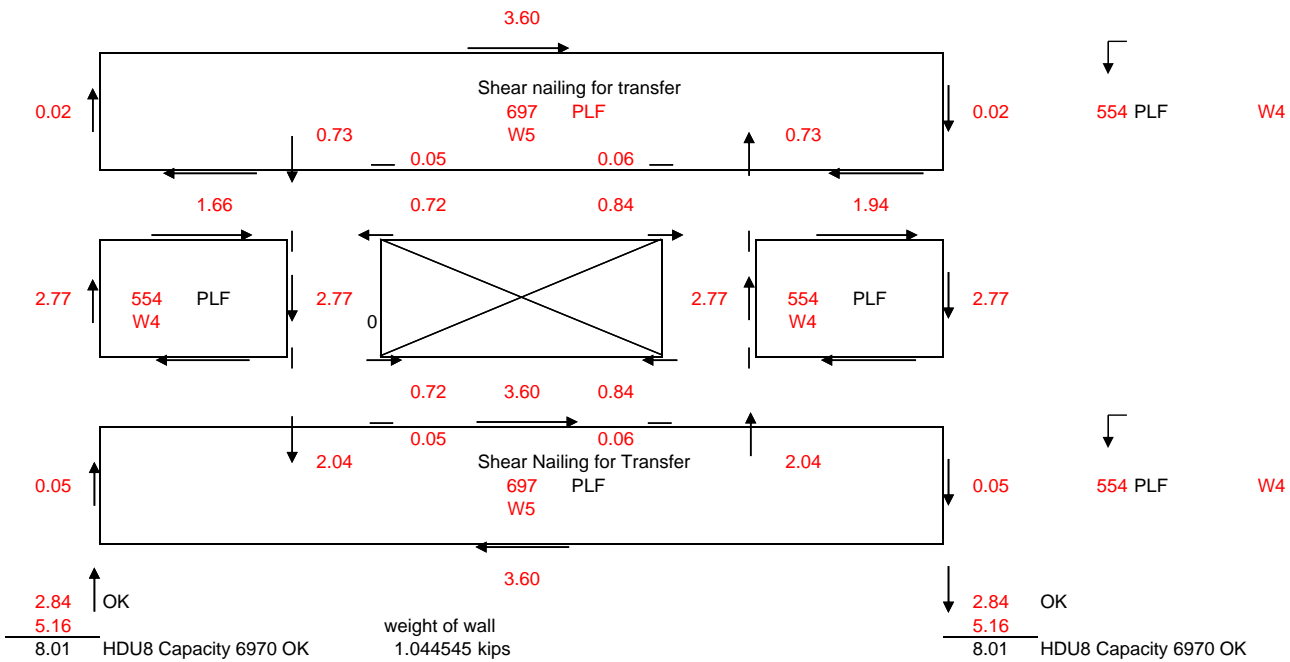

Shear Wall Line 2B-L3-3 2nd

W Designation

P= 3.179 Kips  
489 plf  
489 plf

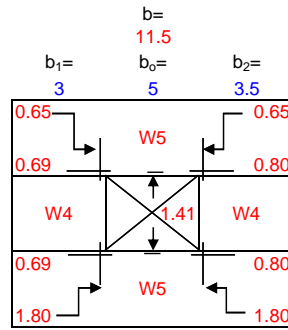

CS16

Use W4

$h_1 = 1.083333$

$h_0 = 5$       $h = 9.083333$

$h_2 = 3$

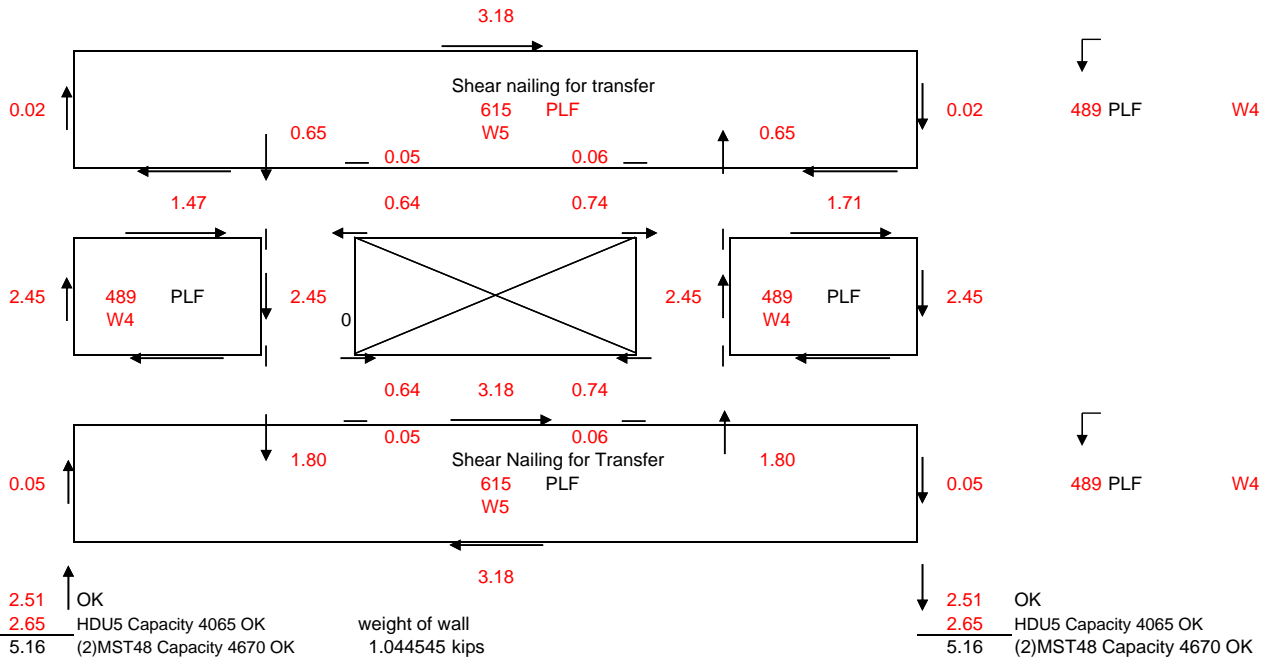

Shear Wall Line 2B-L3-3 3rd

W Designation

P= 2.321 Kips  
357 plf  
357 plf

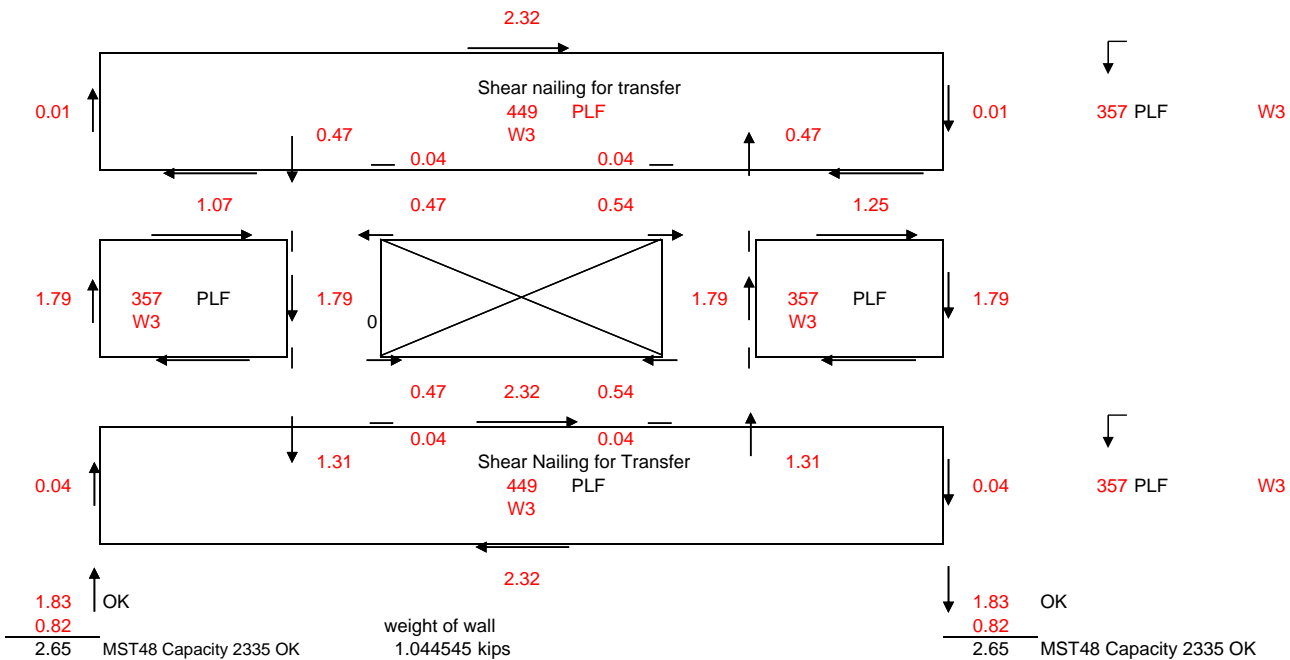
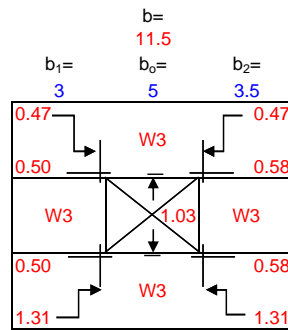



Shear Wall Line 2B-L3-3 roof

W Designation

P= 1.040 Kips  
160 plf  
160 plf

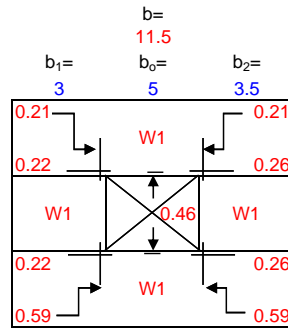

$h_1 = 1.083333$

$h_o = 5$   $h = 9.083333$

$h_2 = 3$

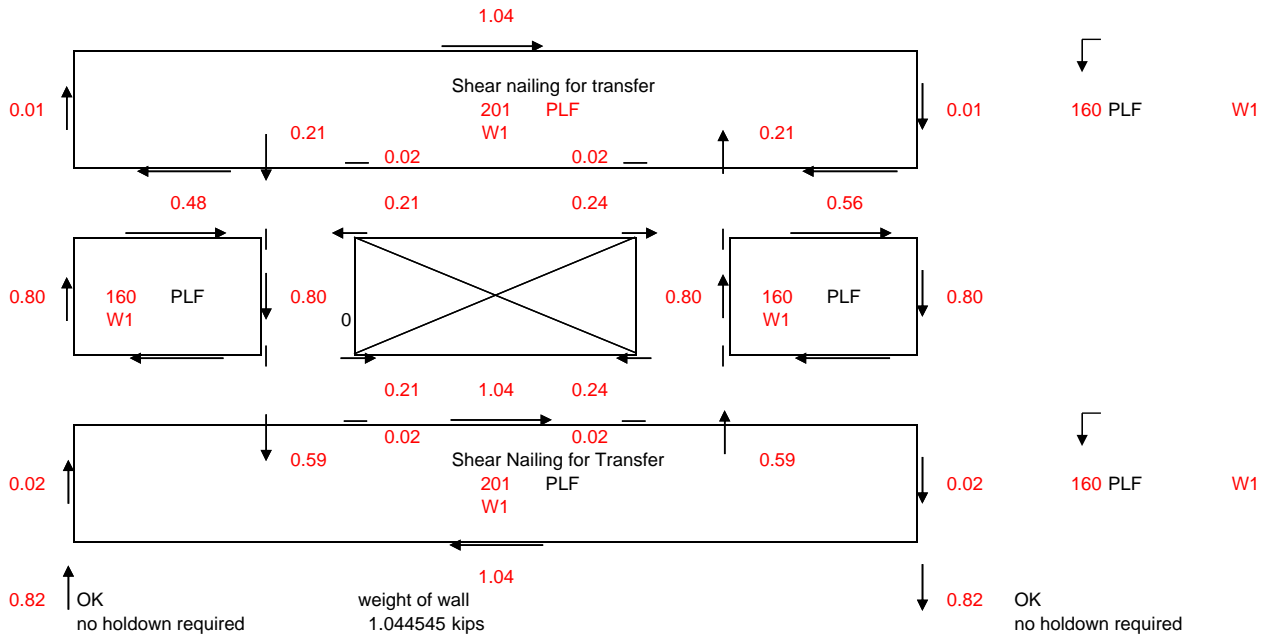



Job # 23.007 Sheet:

Designed TLC Date: 5/26

Checked: Date:

Project: Bradley Height Apartments

B-T1 end (3 story + Basement)

0.5 (ft) holdown dist from end

Roof: W1	Wind (ASD): 2.857 kips 77 #/ft Seismic (ASD): 5.498 kips 147 #/ft								77 #/ft 147 #/ft		
										9.083 ft	
	9.417 ft	9.25 ft	0 ft	0 ft	0 ft	0 ft	0 ft	0 ft	9.25 ft	9.417 ft	37.33
Distribution L	9.417 ft	9.25 ft	0 ft	0 ft	0 ft	0 ft	0 ft	0 ft	9.25 ft	9.417 ft	37.33
h/b <sub>s</sub> = DL w (plf) = 0.6M <sub>R</sub> (#-ft) =	0.965 W1 178.8 4757	0.982 W1 178.8 4590	0 0 0	0 0 0	0 0 0	0 0 0	0 0 0	0 0 0	0.982 W1 178.8 4590	0.965 W1 178.8 4757	
PLF	W E 77 147	W E 77 147	W E 0 0	W E 0 0	W E 0 0	W E 0 0	W E 0 0	W E 0 0	W E 77 147	W E 77 147	
M <sub>tot</sub> (#-ft) = F (#) =	6545 12597 200 879	6429 12374 210 890	0 0 0 0	0 0 0 0	0 0 0 0	0 0 0 0	0 0 0 0	0 0 0 0	6429 12374 210 890	6545 12597 200 879	
Holddown	1000 -	1000 -	1000 -	1000 -	1000 -	1000 -	1000 -	1000 -	1000 -	1000 -	
	No Holddown OK	No Holddown OK	No Holddown OK	No Holddown OK	No Holddown OK	No Holddown OK	No Holddown OK	No Holddown OK	No Holddown OK	No Holddown OK	

3rd Floor: W2	Wind (ASD): 1.866 kips 127 #/ft Seismic (ASD): 6.388 kips 318 #/ft								127 #/ft 318 #/ft		
										9.083 ft	
	9.417 ft	9.25 ft	0 ft	0 ft	0 ft	0 ft	0 ft	0 ft	9.25 ft	9.417 ft	37.33
Distribution L	9.417 ft	9.25 ft	0 ft	0 ft	0 ft	0 ft	0 ft	0 ft	9.25 ft	9.417 ft	37.33
h/b <sub>s</sub> = DL w (plf) = 0.6M <sub>R</sub> (#-ft) =	0.965 W2 234.9 6249	0.982 W2 221.9 5696	0 0 0	0 0 0	0 0 0	0 0 0	0 0 0	0 0 0	0.982 W2 221.9 5696	0.965 W2 234.9 6249	
PLF	W E 127 318	W E 127 318	W E 0 0	W E 0 0	W E 0 0	W E 0 0	W E 0 0	W E 0 0	W E 127 318	W E 127 318	
M <sub>tot</sub> (#-ft) = F (#) =	10821 27233 713 3233	10629 26751 774 3296	0 0 0 0	0 0 0 0	0 0 0 0	0 0 0 0	0 0 0 0	0 0 0 0	10629 26751 774 3296	10821 27233 713 3233	
Holddown	3356 S3	3356 S3	1000 -	1000 -	1000 -	1000 -	1000 -	1000 -	3356 S3	3356 S3	
	MST60 OK	MST60 OK	No Holddown OK	No Holddown OK	No Holddown OK	No Holddown OK	No Holddown OK	No Holddown OK	MST60 OK	MST60 OK	
with point load ok by inspection											

2nd Floor W3	Wind (ASD): 1.851 kips 176 #/ft Seismic (ASD): 3.771 kips 419 #/ft								176 #/ft 419 #/ft		
										9.083 ft	
	9.417 ft	9.25 ft	0 ft	0 ft	0 ft	0 ft	0 ft	0 ft	9.25 ft	9.417 ft	37.33
Distribution L	9.417 ft	9.25 ft	0 ft	0 ft	0 ft	0 ft	0 ft	0 ft	9.25 ft	9.417 ft	37.33
h/b <sub>s</sub> = DL w (plf) = 0.6M <sub>R</sub> (#-ft) =	0.965 W3 234.9 6249	0.982 W3 221.9 5696	0 0 0	0 0 0	0 0 0	0 0 0	0 0 0	0 0 0	0.982 W3 221.9 5696	0.965 W3 234.9 6249	
PLF	W E 176 419	W E 176 419	W E 0 0	W E 0 0	W E 0 0	W E 0 0	W E 0 0	W E 0 0	W E 176 419	W E 176 419	
M <sub>tot</sub> (#-ft) = F (#) =	15061 35872 1701 6555	14795 35237 1814 6672	0 0 0 0	0 0 0 0	0 0 0 0	0 0 0 0	0 0 0 0	0 0 0 0	14795 35237 1814 6672	15061 35872 1701 6555	
Holddown	6970 H4	6970 H4	1000 -	1000 -	1000 -	1000 -	1000 -	1000 -	6712 S5	6712 S5	
	HDU8 OK	HDU8 OK	No Holddown OK	No Holddown OK	No Holddown OK	No Holddown OK	No Holddown OK	No Holddown OK	(2) MST60 OK	(2) MST60 OK	
Load above to foundation											

1st Floor W4	Wind (ASD): -2.148 kips 237 #/ft Seismic (ASD): -6.675 kips 481 #/ft								237 #/ft 481 #/ft		
										9.083 ft	
	0 ft	0 ft	0 ft	0 ft	0 ft	0 ft	0 ft	0 ft	9.25 ft	9.417 ft	18.67
Distribution L	0 ft	0 ft	0 ft	0 ft	0 ft	0 ft	0 ft	0 ft	9.25 ft	9.417 ft	18.67
h/b <sub>s</sub> = DL w (plf) = 0.6M <sub>R</sub> (#-ft) =	0 0 0	0 0 0	0 0 0	0 0 0	0 0 0	0 0 0	0 0 0	0 0 0	0.982 W4 221.9 5696	0.965 W4 234.9 6249	
PLF	W E 0 0	W E 0 0	W E 0 0	W E 0 0	W E 0 0	W E 0 0	W E 0 0	W E 0 0	W E 237 481	W E 237 481	
M <sub>tot</sub> (#-ft) = F (#) =	0 0 1701 6555	0 0 1814 6672	0 0 0 0	0 0 0 0	0 0 0 0	0 0 0 0	0 0 0 0	0 0 0 0	19922 40427 3440 10641	20281 41156 3275 10469	
Holddown	1000 -	1000 -	1000 -	1000 -	1000 -	1000 -	1000 -	1000 -	9535 H5	9535 H5	
	1.05	No Holddown NG	No Holddown NG	No Holddown NG	No Holddown NG	No Holddown NG	No Holddown NG	No Holddown NG	HDU11 NG	HDU11 NG	
concrete foundation OK											
OK By Inspection OK By Inspection											

2 Bedroom Unit 3 story | 2 Bedroom Unit 3 story + Basement

PRMU20240280 BLDG G



Job # 23.007 Sheet:

Designer: TLC Date: 5/26

Checked: Date:

Project: Bradley Height Apartments  
2B-T1 end (3 story)

0.5 (ft) holddown dist from end

Roof: W1	Wind (ASD): 2.857 kips		77 #/ft		77 #/ft		77 #/ft		77 #/ft		77 #/ft	
	Seismic (ASD): 5.498 kips		147 #/ft		147 #/ft		147 #/ft		147 #/ft		147 #/ft	
											9.083 ft	
	9.417 ft	9.25 ft	0 ft	0 ft	0 ft	0 ft	0 ft	0 ft	9.25 ft	9.417 ft	37.33	Actual
Distribution L	9.417 ft	9.25 ft	0 ft	0 ft	0 ft	0 ft	0 ft	0 ft	9.25 ft	9.417 ft	37.33	Distribu
$h/b_s =$	0.965 W1	0.982 W1	0	0	0	0	0	0	0.982 W1	0.965 W1		
DL w (plf) =	178.8	178.8	0	0	0	0	0	0	178.8	178.8		
0.6M <sub>R</sub> (#-ft) =	4757	4590	0	0	0	0	0	0	4590	4757		
PLF	W E	W E	W E	W E	W E	W E	W E	W E	W E	W E		
	77 147	77 147	0 0	0 0	0 0	0 0	0 0	0 0	77 147	77 147		
M <sub>ot</sub> (#-ft) =	6545 12597	6429 12374	0 0	0 0	0 0	0 0	0 0	0 0	6429 12374	6545 12597		
F (#) =	200 879	210 890	0 0	0 0	0 0	0 0	0 0	0 0	210 890	200 879		
Holddown	1000 -	1000 -	1000 -	1000 -	1000 -	1000 -	1000 -	1000 -	1000 -	1000 -		
	No Holddown OK	No Holddown OK	No Holddown OK	No Holddown OK	No Holddown OK	No Holddown OK	No Holddown OK	No Holddown OK	No Holddown OK	No Holddown OK		

3rd Floor: W2	Wind (ASD): 1.866 kips		127 #/ft		127 #/ft		127 #/ft		127 #/ft		127 #/ft	
	Seismic (ASD): 6.388 kips		318 #/ft		318 #/ft		318 #/ft		318 #/ft		318 #/ft	
											9.083 ft	
	9.417 ft	9.25 ft	0 ft	0 ft	0 ft	0 ft	0 ft	0 ft	9.25 ft	9.417 ft	37.33	Actual
Distribution L	9.417 ft	9.25 ft	0 ft	0 ft	0 ft	0 ft	0 ft	0 ft	9.25 ft	9.417 ft	37.33	Distribu
$h/b_s =$	0.965 W2	0.982 W2	0	0	0	0	0	0	0.982 W2	0.965 W2		
DL w (plf) =	234.9	221.9	0	0	0	0	0	0	221.9	234.9		
0.6M <sub>R</sub> (#-ft) =	6249	5696	0	0	0	0	0	0	5696	6249		
PLF	W E	W E	W E	W E	W E	W E	W E	W E	W E	W E		
	127 318	127 318	0 0	0 0	0 0	0 0	0 0	0 0	127 318	127 318		
M <sub>ot</sub> (#-ft) =	10821 27233	10629 26751	0 0	0 0	0 0	0 0	0 0	0 0	10629 26751	10821 27233		
F (#) =	713 3233	774 3296	0 0	0 0	0 0	0 0	0 0	0 0	774 3296	713 3233		
Holddown	3356 S3	3356 S3	1000 -	1000 -	2335 S2	1000 -	1000 -	1000 -	3356 S3	3356 S3		
	MST60 OK	MST60 OK	No Holddown OK	No Holddown OK	MST48 OK	No Holddown OK	No Holddown OK	No Holddown OK	MST60 OK	MST60 OK		

2nd Floor W3	Wind (ASD): 1.851 kips		176 #/ft		176 #/ft		176 #/ft		176 #/ft		176 #/ft	
	Seismic (ASD): 3.771 kips		419 #/ft		419 #/ft		419 #/ft		419 #/ft		419 #/ft	
											9.083 ft	
	9.417 ft	9.25 ft	0 ft	0 ft	0 ft	0 ft	0 ft	0 ft	9.25 ft	9.417 ft	37.33	Actual
Distribution L	9.417 ft	9.25 ft	0 ft	0 ft	0 ft	0 ft	0 ft	0 ft	9.25 ft	9.417 ft	37.33	Distribu
$h/b_s =$	0.965 W3	0.982 W3	0	0	0	0	0	0	0.982 W3	0.965 W3		
DL w (plf) =	234.9	221.9	0	0	0	0	0	0	221.9	234.9		
0.6M <sub>R</sub> (#-ft) =	6249	5696	0	0	0	0	0	0	5696	6249		
PLF	W E	W E	W E	W E	W E	W E	W E	W E	W E	W E		
	176 419	176 419	0 0	0 0	0 0	0 0	0 0	0 0	176 419	176 419		
M <sub>ot</sub> (#-ft) =	15061 35872	14795 35237	0 0	0 0	0 0	0 0	0 0	0 0	14795 35237	15061 35872		
F (#) =	1701 6555	1814 6672	0 0	0 0	0 0	0 0	0 0	0 0	1814 6672	1701 6555		
Holddown	6970 H4	6970 H4	1000 -	1000 -	1000 -	1000 -	1000 -	1000 -	6970 H4	6970 H4		
	1.05 HDU8 OK	HDU8 OK	No Holddown OK	No Holddown OK	No Holddown OK	No Holddown OK	No Holddown OK	No Holddown OK	HDU8 OK	HDU8 OK		



Job # 23.007 Sheet:

Designed TLC Date: 5/26

Checked: Date:

Project: Bradley Height Apartments  
2B-T2 stairs (3 story + Base)

0.5 (ft) holdown dist from end

Roof: W1	Wind (ASD): 3.491 kips Seismic (ASD): 6.720 kips				65 #/ft 126 #/ft				65 #/ft 126 #/ft	
										9.083 ft
Distribution L	17 ft	0 ft	0 ft	0 ft	19.5 ft	0 ft	0 ft	0 ft	17 ft	53.5
h/b <sub>s</sub> = 0.534 W1 DL w (plf) = 178.8 0.6M <sub>R</sub> (#-ft) = 15505		0	0	0	0.466 W1 178.8 20400	0	0	0	0.534 W1 178.8 15505	
PLF	W E 65 126	0 0	0 0	0 0	W E 65 126	0 0	0 0	0 0	W E 65 126	
M <sub>tot</sub> (#-ft) = 10077 19396 F (#) = -329 236	0 0	0 0	0 0	0 0	11559 22248 -465 97	0 0	0 0	0 0	10077 19396 -329 236	
Holdown	1000 -	1000 -	1000 -	1000 -	1000 -	1000 -	1000 -	1000 -	1000 -	
	No Holdown OK	No Holdown OK	No Holdown OK	No Holdown OK	No Holdown OK	No Holdown OK	No Holdown OK	No Holdown OK	No Holdown OK	

3rd Floor: W2	Wind (ASD): 2.281 kips Seismic (ASD): 7.808 kips				108 #/ft 272 #/ft				108 #/ft 272 #/ft	
										9.083 ft
Distribution L	17 ft	0 ft	0 ft	0 ft	19.5 ft	0 ft	0 ft	0 ft	17 ft	53.5
h/b <sub>s</sub> = 0.534 W2 DL w (plf) = 241.4 0.6M <sub>R</sub> (#-ft) = 20931		0	0	0	0.466 W2 242.5 27668	0	0	0	0.534 W2 241.4 20931	
PLF	W E 108 272	0 0	0 0	0 0	W E 108 272	0 0	0 0	0 0	W E 108 272	
M <sub>tot</sub> (#-ft) = 16661 41931 F (#) = -588 1509	0 0	0 0	0 0	0 0	19111 48097 -916 1172	0 0	0 0	0 0	16661 41931 -588 1509	
Holdown	2335 S2	1000 -	1000 -	1000 -	2335 S2	1000 -	1000 -	1000 -	2335 S2	
	MST48 OK	No Holdown OK	No Holdown OK	No Holdown OK	MST48 OK	No Holdown OK	No Holdown OK	No Holdown OK	MST48 OK	

with point load ok by inspection

2nd Floor W2	Wind (ASD): 2.262 kips Seismic (ASD): 4.609 kips				150 #/ft 358 #/ft				150 #/ft 358 #/ft	
										9.083 ft
Distribution L	17 ft	0 ft	0 ft	0 ft	19.5 ft	0 ft	0 ft	0 ft	17 ft	53.5
h/b <sub>s</sub> = 0.534 W2 DL w (plf) = 241.4 0.6M <sub>R</sub> (#-ft) = 20931		0	0	0	0.466 W2 242.5 27668	0	0	0	0.534 W2 241.4 20931	
PLF	W E 150 358	0 0	0 0	0 0	W E 150 358	0 0	0 0	0 0	W E 150 358	
M <sub>tot</sub> (#-ft) = 23191 55233 F (#) = -451 3587	0 0	0 0	0 0	0 0	26601 63355 -972 3051	0 0	0 0	0 0	23191 55233 -451 3587	
Holdown	4065 H3	1000 -	1000 -	1000 -	4670 S4	1000 -	1000 -	1000 -	4670 S4	
	HDU5 OK	No Holdown OK	No Holdown OK	No Holdown OK	(2) MST48 OK	No Holdown OK	No Holdown OK	No Holdown OK	(2) MST48 OK	

Load above to foundation HDU5 above

1st Floor W3	Wind (ASD): -2.625 kips Seismic (ASD): -8.159 kips				202 #/ft 410 #/ft				202 #/ft 410 #/ft	
										9.083 ft
Distribution L	0 ft	0 ft	0 ft	0 ft	9.75 ft	0 ft	0 ft	0 ft	17 ft	26.75
h/b <sub>s</sub> = 0.932 W3 DL w (plf) = 242.5 0.6M <sub>R</sub> (#-ft) = 6917		0	0	0	0.534 W3 241.4 20931	0	0	0	0.534 W3 241.4 20931	
PLF	W E 202 410	0 0	0 0	0 0	W E 202 410	0 0	0 0	0 0	W E 202 410	
M <sub>tot</sub> (#-ft) = 17910 36344 F (#) = -451 3587	0 0	0 0	0 0	0 0	17910 36344 217 6232	0 0	0 0	0 0	31227 63369 173 6159	
Holdown	14445 H6	1000 -	1000 -	1000 -	6970 H4	1000 -	1000 -	1000 -	6970 H4	
	1.05 HDU14 OK	No Holdown OK	No Holdown OK	No Holdown OK	HDU8 OK	No Holdown OK	No Holdown OK	No Holdown OK	HDU8 OK	

concrete foundation

2 Bedroom Unit 3 story | 2 Bedroom Unit 3 story + Basement



Job # 23.007 Sheet:

Designer: TLC Date: 5/26

Checked: Date:

Project: Bradley Height Apartments

2B-T2 stairs (3 story)

0.5 (ft) holddown dist from end

Roof: W1	Wind (ASD): 3.491 kips		65 #/ft		65 #/ft		65 #/ft		65 #/ft		
	Seismic (ASD): 6.720 kips		126 #/ft		126 #/ft		126 #/ft		126 #/ft		
											9.083 ft
Distribution L	17 ft	0 ft	0 ft	0 ft	19.5 ft	0 ft	0 ft	0 ft	0 ft	17 ft	53.5
h/b <sub>s</sub> = 0.534 W1	DL w (plf) = 178.8		0		0.466 W1		178.8		0		0.534 W1
	0.6M <sub>R</sub> (#-ft) = 15505		0		20400		0		0		15505
PLF	W E	W E	W E	W E	W E	W E	W E	W E	W E	W E	
	65 126	0 0	0 0	0 0	65 126	0 0	0 0	0 0	0 0	65 126	
M <sub>ot</sub> (#-ft) =	10077 19396	0 0	0 0	0 0	11559 22248	0 0	0 0	0 0	0 0	10077 19396	
F (#) =	-329 236	0 0	0 0	0 0	-465 97	0 0	0 0	0 0	0 0	-329 236	
Holddown	1000 -	1000 -	1000 -	1000 -	1000 -	1000 -	1000 -	1000 -	1000 -	1000 -	
	No Holddown OK	No Holddown OK	No Holddown OK	No Holddown OK	No Holddown OK	No Holddown OK	No Holddown OK	No Holddown OK	No Holddown OK	No Holddown OK	

Actual  
Distribu

3rd Floor: W2	Wind (ASD): 2.281 kips		108 #/ft		108 #/ft		108 #/ft		108 #/ft		
	Seismic (ASD): 7.808 kips		272 #/ft		272 #/ft		272 #/ft		272 #/ft		
											9.083 ft
Distribution L	17 ft	0 ft	0 ft	0 ft	19.5 ft	0 ft	0 ft	0 ft	0 ft	17 ft	53.5
h/b <sub>s</sub> = 0.534 W2	DL w (plf) = 241.4		0		0.466 W2		242.5		0		0.534 W2
	0.6M <sub>R</sub> (#-ft) = 20931		0		27668		0		0		20931
PLF	W E	W E	W E	W E	W E	W E	W E	W E	W E	W E	
	108 272	0 0	0 0	0 0	108 272	0 0	0 0	0 0	0 0	108 272	
M <sub>ot</sub> (#-ft) =	16661 41931	0 0	0 0	0 0	19111 48097	0 0	0 0	0 0	0 0	16661 41931	
F (#) =	-588 1509	0 0	0 0	0 0	-916 1172	0 0	0 0	0 0	0 0	-588 1509	
Holddown	2335 S2	1000 -	1000 -	1000 -	2335 S2	1000 -	1000 -	1000 -	1000 -	2335 S2	
	MST48 OK	No Holddown OK	No Holddown OK	No Holddown OK	MST48 OK	No Holddown OK	No Holddown OK	No Holddown OK	No Holddown OK	MST48 OK	

Actual  
Distribu

2nd Floor W2	Wind (ASD): 2.262 kips		150 #/ft		150 #/ft		150 #/ft		150 #/ft		
	Seismic (ASD): 4.609 kips		358 #/ft		358 #/ft		358 #/ft		358 #/ft		
											9.083 ft
Distribution L	17 ft	0 ft	0 ft	0 ft	19.5 ft	0 ft	0 ft	0 ft	0 ft	17 ft	53.5
h/b <sub>s</sub> = 0.534 W2	DL w (plf) = 241.4		0		0.466 W2		242.5		0		0.534 W2
	0.6M <sub>R</sub> (#-ft) = 20931		0		27668		0		0		20931
PLF	W E	W E	W E	W E	W E	W E	W E	W E	W E	W E	
	150 358	0 0	0 0	0 0	150 358	0 0	0 0	0 0	0 0	150 358	
M <sub>ot</sub> (#-ft) =	23191 55233	0 0	0 0	0 0	26601 63355	0 0	0 0	0 0	0 0	23191 55233	
F (#) =	-451 3587	0 0	0 0	0 0	-972 3051	0 0	0 0	0 0	0 0	-451 3587	
Holddown	4065 H3	6970 H4	1000 -	1000 -	9535 H5	1000 -	1000 -	6970 H4	9535 H5		
	1.05 HDU5 OK	HDU8 OK	No Holddown OK	No Holddown OK	HDU11 OK	No Holddown OK	No Holddown OK	HDU8 OK	HDU11 OK		

Actual  
Distribu

Job # 23.002

Sheet:



Designed: TLC

Date: 5/29/23

Checked:

Date:

**Project:** Bradley Heights - 3 Story & basement Story

Vertical Distribution 2 Bedroom units

$$F_x = C_{vx} V \quad (12.8-11)$$

$$C_{vx} = \frac{w_x h_x^k}{\sum w_i h_i^k}$$

$$T_a = C_t h_n^x = 0.3240544 \quad (12.8-7)$$

$$C_t = 0.02 \quad \text{Table 12.8-2}$$

$$x = 0.75 \quad \text{Table 12.8-2}$$

$$H_n = 41 \text{ ft} \quad \text{Structural Height defined in 11.2}$$

k = 1 if period is .5s or less

k = 2 if period is 2.5s or more

k = 1-2 if between

k = 1

2Bx1	→	$w_x$	$h_x$	$w_x h_x^k$	$C_{vx}$	V	$F_x$
3-story	Roof	34742	29.35417	1019818	0.376456	3856	6095
	3rd Floor	55554	20.27083	1126119	0.415696	6166	6730
	2nd Floor	55554	10.13542	563059.7	0.207848	6166	3365
			$\Sigma$	2708997		$\Sigma$	16189

2Bx1	↑	$w_x$	$h_x$	$w_x h_x^k$	$C_{vx}$	V	$F_x$
3-story	Roof	33849	29.35417	993608.6	0.378015	3757	5932
	3rd Floor	53768	20.27083	1089921	0.414657	5968	6508
	2nd Floor	53768	10.13542	544960.7	0.207328	5968	3254
			$\Sigma$	2628491		$\Sigma$	15694

2Bx1	→	$w_x$	$h_x$	$w_x h_x^k$	$C_{vx}$	V	$F_x$
3-story	Roof	34742	39.48958	1371941	0.288811	3856	6457
+ Basement	3rd Floor	55554	30.40625	1689179	0.355594	6166	7950
	2nd Floor	55554	20.27083	1126119	0.237063	6166	5300
	1st floor	55554	10.13542	563059.7	0.118531	6166	2650
			$\Sigma$	4750299		$\Sigma$	22356

2Bx1	↑	$w_x$	$h_x$	$w_x h_x^k$	$C_{vx}$	V	$F_x$
3-story	Roof	33849	39.48958	1336682	0.290176	3757	6286
+ Basement	3rd Floor	53768	30.40625	1634882	0.354912	5968	7688
	2nd Floor	53768	20.27083	1089921	0.236608	5968	5125
	1st Floor	53768	10.13542	544960.7	0.118304	5968	2563
			$\Sigma$	4606446		$\Sigma$	21662

Job # 23.002

Sheet:



Designed: TLC

Date: 5/29/23

Checked:

Date:

Project: Bradley Heights - 3 Story & basement Story

Seismic Design: 1 Bedroom units

Low Flat roof
Typ Roof/Floor
Exit 3" Concrete
not used

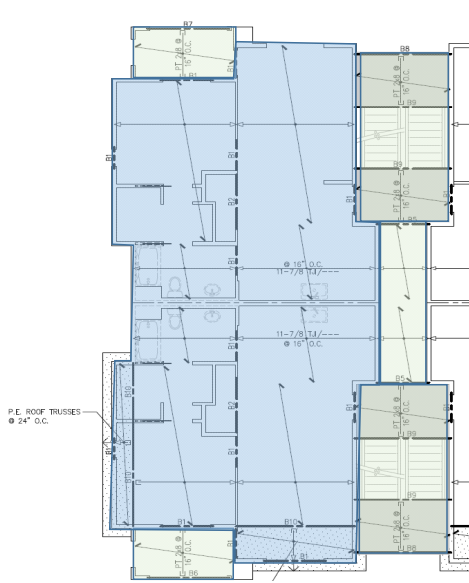

2.083 26 2.5  
**2nd - 3rd Floors**

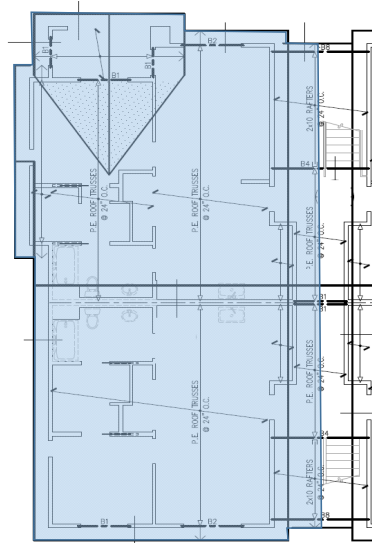

2.083 26 2.5  
**Roof**

31.00

31.00

C<sub>s</sub>/1.4 = 0.111

Typ. Roof (psf) = 22  
Low Roof (psf) = 22

Typ Floor (psf) = 26  
Other Floor (psf) = 47

Ext. wall (psf) = 10  
Int. wall (psf) = 10  
1hr

Ext. wall (psf) = 20  
Int. wall (psf) = 13  
2hr

Wind:

1Bx1 3 story	Roof	L (ft)	W or h(ft)	psf	W (#)	0.1110W		Vertical Distribution		156 plf		
						20878	20878	2317	With	0.615385	0.384615	
	Typ Roof	949	1	22	20878	20878	2317			L(ft) windward	leeward	
	Low Roof	0	1	22	0							
	Ext	64	4.5415	10	2906.56	4359.84	484	→	2801	4514	31.00	2984 1865 2984
	Int	32	4.5415	10	1453.28					145.5968		96
	Ext	38.17	4.5415	10	1733.491	3466.981	385	↑	2702	4352	30.58	2944 1840 2944
	Int	38.17	4.5415	10	1733.491					142.304		96
d1, d2	3rd Floor	L (ft)	W or h(ft)	psf	W (#)	0.1110W				102 plf		
	Typ Floor	755	1	26	19630	37866	4203				L(ft) windward	leeward
	Other Floor	388	1	47	18236							
	Ext	64	9.083	10	5813.12	8719.68	968	→	5171	5753	31.00	1950 1218 1950
	Int	32	9.083	10	2906.56					185.5897		63
	Ext	38.17	9.083	10	3466.981	6933.962	770	↑	4973	5531	30.58	1923 1202 1923
	Int	38.17	9.083	10	3466.981					180.8369		63
d1, d2	2nd Floor	L (ft)	W or h(ft)	psf	W (#)	0.1110W				101 plf		
	Typ Floor	755	1	26	19630	37866	4203					
	Other Floor	388	1	47	18236							
	Ext	64	9.083	10	5813.12	8719.68	968	→	5171	2877	31.00	1934 1208 1934
	Int	32	9.083	10	2906.56					1.797587 92.79485		62
	Ext	38.17	9.083	10	3466.981	6933.962	770	↑	4973	2765	30.58	1908 1192 1908
	Int	38.17	9.083	10	3466.981					1.798306 90.41845		62

2hr

Wind:

# 1 BEDROOM

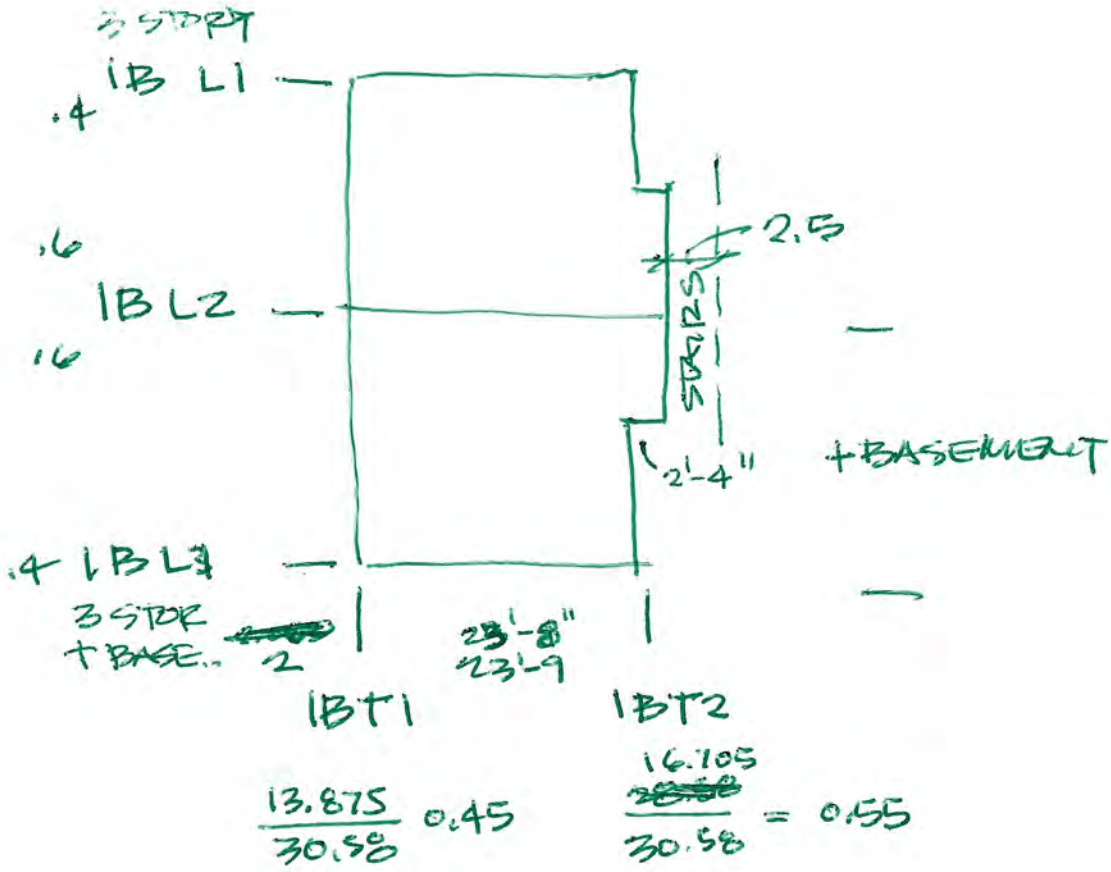



1Bx1 3 story + B1	Roof	L (ft)	W or h(ft)	psf	W (#)	0.1110W	With	156 plf
	Typ Roof	949	1	22	20878	20878	2317	Vertical Distribution
	Low Roof	0	1	22	0			L(ft) windward leeward
	Ext	64	4.5415	10	2906.56	4359.84	484	2801 4766
	Int	32	4.5415	10	1453.28			153.7483
	Ext	38.17	4.5415	10	1733.491	3466.981	385	2702 4596
	Int	38.17	4.5415	10	1733.491			150.2818
	3rd Floor	L (ft) <td>W or h(ft) <td>psf <td>W (#) <td>0.1110W <td></td> <td>102 plf</td> </td></td></td></td>	W or h(ft) <td>psf <td>W (#) <td>0.1110W <td></td> <td>102 plf</td> </td></td></td>	psf <td>W (#) <td>0.1110W <td></td> <td>102 plf</td> </td></td>	W (#) <td>0.1110W <td></td> <td>102 plf</td> </td>	0.1110W <td></td> <td>102 plf</td>		102 plf
	Typ Floor	755	1	26	19630	37866	4203	L(ft) windward leeward
	Other Floor	388	1	47	18236			
	Ext	64	9.083	10	5813.12	8719.68	968	5171 6774
	Int	32	9.083	10	2906.56			218.5199
	Ext	38.17	9.083	10	3466.981	6933.962	770	4973 6512
	Int	38.17	9.083	10	3466.981			212.9388
	2nd Floor	L (ft) <td>W or h(ft) <td>psf <td>W (#) <td>0.1110W <td></td> <td>101 plf</td> </td></td></td></td>	W or h(ft) <td>psf <td>W (#) <td>0.1110W <td></td> <td>101 plf</td> </td></td></td>	psf <td>W (#) <td>0.1110W <td></td> <td>101 plf</td> </td></td>	W (#) <td>0.1110W <td></td> <td>101 plf</td> </td>	0.1110W <td></td> <td>101 plf</td>		101 plf
	Typ Floor	755	1	26	19630	37866	4203	L(ft) windward leeward
	Other Floor	388	1	47	18236			
	Ext	64	9.083	10	5813.12	8719.68	968	5171 4516
	Int	32	9.083	10	2906.56			145.6799
	Ext	38.17	9.083	10	3466.981	6933.962	770	4973 4342
	Int	38.17	9.083	10	3466.981			141.9592
	1st Floor	L (ft) <td>W or h(ft) <td>psf <td>W (#) <td>0.1110W <td></td> <td>101 plf</td> </td></td></td></td>	W or h(ft) <td>psf <td>W (#) <td>0.1110W <td></td> <td>101 plf</td> </td></td></td>	psf <td>W (#) <td>0.1110W <td></td> <td>101 plf</td> </td></td>	W (#) <td>0.1110W <td></td> <td>101 plf</td> </td>	0.1110W <td></td> <td>101 plf</td>		101 plf
	Typ Floor	755	1	26	19630	37866	4203	L(ft) windward leeward
	Other Floor	388	1	47	18236			
	Ext	64	9.083	10	5813.12	8719.68	968	5171 2258
	Int	32	9.083	10	2906.56			72.83996
	Ext	38.17	9.083	10	3466.981	6933.962	770	4973 2171
	Int	38.17	9.083	10	3466.981			70.97959

Unit B1							
Roof	2984	Wind	Roof	1840	Roof	2944	Wind
	4514	Seismic		4352		4352	Seismic
3rd	1950	Wind	3rd	1202	3rd	1923	Wind
	5753	Seismic		5531		5531	Seismic
2nd	1934	Wind	2nd	1192	2nd	1908	Wind
	2877	Seismic		2765		2765	Seismic

Unit B1							
Roof	2984	Wind	Roof	2944	Roof	1840	Wind
	4766	Seismic		4596		4596	Seismic
3rd	1950	Wind	3rd	1923	3rd	1202	Wind
	6774	Seismic		6512		6512	Seismic
2nd	1934	Wind	2nd	1908	2nd	1192	Wind
	4516	Seismic		4342		4342	Seismic
1st	1934	Wind	2nd	1908	2nd	1192	Wind
	2258	Seismic		2171		2171	Seismic

B1 + B1	B1 + B1	max	
4784	4784	4784	Wind
8948	8948	8948	Seismic
3125	3125	3125	Wind
12043	12043	12043	Seismic
3100	3100	3100	Wind
7107	7107	7107	Seismic
1908	1192	1908	Wind
2171	2171	2171	Seismic



Job # 23.002

Sheet:

Designed: TLC

Date: 5/29/23

Checked:

Date:

**Project:** Bradley Heights - 3 Story & basement Story

Diaphragm Design Forces 1 Bedroom units

$$F_x = C_{vx} V \quad (12.8-11)$$

$$F_{Dx} = \frac{\sum_{i=x}^n F_i}{\sum_{i=x}^n w_i} w_{px} \quad (12.10-1)$$

$F_{px}$  = the diaphragm design force at Level x

$F_i$  = the design force applied to level i

$w_i$  = the weight tributary to Level i

$w_{px}$  = the weight tributary to the diaphragm at Level x

$$I_e = 1$$

$$S_{DS} = 0.8787$$

$$\text{Minimum: } F_{px} = 0.2S_{DS}I_e w_{px}$$

$$\text{Maximum: } F_{px} = 0.4S_{DS}I_e w_{px}$$

3- story	B1		$F_i$	$\sum_{i=x}^n F_i$	$w_{xp}$	$\sum_{i=x}^n w_i$	$F_{px}$	Min	Max	$F_{px}$	x factor
	→										
Roof			4514	4514	25238	25237.84	4514	4435	8871	4514	1
3rd Floor			5753	10267	46586	71823.52	6659	8187	16374	8187	1.229428
2nd Floor			2877	13143	46586	118409.2	5171	8187	16374	8187	1.583243

3- story	B1		$F_i$	$\sum_{i=x}^n F_i$	$w_i$	$\sum_{i=x}^n w_i$	$F_{px}$	Min	Max	$F_{px}$	x factor
	↑										
Roof			4352	4352	24345	24344.98	4352	4278	8557	4352	1
3rd Floor			5531	9883	44800	69144.94	6403	7873	15746	7873	1.229586
2nd Floor			2765	12648	44800	113944.9	4973	7873	15746	7873	1.583243

3- story + EB1			$F_i$	$\sum_{i=x}^n F_i$	$w_{xp}$	$\sum_{i=x}^n w_i$	$F_{px}$	Min	Max	$F_{px}$	x factor
	→										
Roof			4766	4766	25238	25237.84	4766	4435	8871	4766	1
3rd Floor			6774	11540	46586	71823.52	7485	8187	16374	8187	1.093754
2nd Floor			4516	16056	46586	118409.2	6317	8187	16374	8187	1.296009
1st Floor			2258	18314	46586	164994.9	5171	8187	16374	8187	1.583243

3- story + EB1			$F_i$	$\sum_{i=x}^n F_i$	$w_i$	$\sum_{i=x}^n w_i$	$F_{px}$	Min	Max	$F_{px}$	x factor
	↑										
Roof			4596	4596	24345	24344.98	4596	4278	8557	4596	1
3rd Floor			6512	11108	44800	69144.94	7197	7873	15746	7873	1.093907
2nd Floor			4342	15450	44800	113944.9	6074	7873	15746	7873	1.296103
1st Floor			2171	17621	44800	158744.9	4973	7873	15746	7873	1.583243

Unit B1	3 story + Basement	Combined	Line	Line	Line	Line	Line	Line
Unit B1	3 story + Basement	B1+B1 combined	1B-T1	1B-T2	B1-L1	B1-L2	B1-L3	
Unit B1	Unit B1	Roof	0.45	0.55	0.4	0.6	0.4	
Roof	Roof	Roof	2153	2631	1194	3581	1194	
3rd Floor	3rd Floor	3rd Floor	4027	4921	1805	5568	1906	
2nd Floor	2nd Floor	2nd Floor	1406	1719	780	2339	780	
1st Floor	1st Floor	1st Floor	5419	6624	2301	7516	2710	
			1395	1705	773	2320	773	
			3198	3909	1151	4436	1806	
			858	1049	0	1160	773	
			977	1194	0	1355	903	
								to concrete retaining wall



Job # 23.007 Sheet:

Designed TLC Date: 5/26

Checked: Date:

Project: Bradley Height Apartments

1B-11

0.5 (ft) holddown dist from end

Roof: W2	Wind (ASD): 1.194 kips Seismic (ASD): 1.906 kips		173 #/ft 276 #/ft		173 #/ft 276 #/ft		0.5 (ft) holddown dist from end	
use W1P SW 1B-L3 -1	5	5	use W2P SW 1B-L3 -2	6	6	not used	6	6
0 ft	0 ft	0 ft	3.417 ft	3.5 ft	0 ft	0 ft	0 ft	0 ft
9.083 ft								
Distribution L	0 ft	0 ft	0 ft	3.417 ft	3.5 ft	0 ft	0 ft	0 ft
h/b <sub>s</sub> =			1.756 W2	1.714 W2				
DL w (plf) =	427.2	427.2	382.3	382.3	0	0	429.1	429.1
0.6M <sub>R</sub> (#-ft) =	0	0	1339	1405	0	0	0	0
PLF	W E	W E	W E	W E	W E	W E	W E	W E
M <sub>tot</sub> (#-ft) =	0	0	0	0	0	0	0	0
F (#) =	0	0	0	0	0	0	0	0
Holddown	1000 -	1000 -	1000 -	1256 S1	1256 S1	1000 -	1000 -	1000 -
	No Holddown OK	No Holddown OK	No Holddown OK	MST37 NG	MST37 NG	No Holddown OK	No Holddown OK	No Holddown OK
	(see calc next pp OK)							
3rd Floor: W3	Wind (ASD): 0.780 kips Seismic (ASD): 2.71 kips		161 #/ft 377 #/ft		163 #/ft 382 #/ft		0.5 (ft) holddown dist from end	
use W3P SW 2B-L3 -1	5	5	use W4P SW 2B-L3 -2	6	6	not used	5	5
3 ft	2.333 ft	0 ft	3.417 ft	3.5 ft	0 ft	0 ft	0 ft	0 ft
9.083 ft								
Distribution L	3 ft	2.178 ft	0 ft	3.417 ft	3.5 ft	0 ft	0 ft	0 ft
h/b <sub>s</sub> =	1.667 W3	2.143 W3		1.756 W3	1.714 W3			
DL w (plf) =	108.2	108.2	0	108.2	108.2	0	0	108.2
0.6M <sub>R</sub> (#-ft) =	292	177	0	379	398	0	0	0
PLF	W E	W E	W E	W E	W E	W E	W E	W E
M <sub>tot</sub> (#-ft) =	4446	10401	3228	7550	0	0	0	0
F (#) =	1662	4043	1664	4022	0	0	0	0
Holddown	2335 S2	2335 S2	1000 -	2335 S2	2335 S2	1000 -	1000 -	1000 -
	MST48 NG	MST48 NG	No Holddown OK	MST48 NG	MST48 NG	No Holddown OK	No Holddown OK	No Holddown OK
	(see calc next pp OK)							
2nd Floor: W4	Wind (ASD): 0.773 kips Seismic (ASD): 1.806 kips		224 #/ft 524 #/ft		227 #/ft 531 #/ft		0.5 (ft) holddown dist from end	
use W4P SW 2B-L3 -1	5	5	use W6P SW 2B-L3 -2	6	6	not used	5	5
3 ft	2.333 ft	0 ft	3.417 ft	3.5 ft	0 ft	0 ft	0 ft	0 ft
9.083 ft								
Distribution L	3 ft	2.178 ft	0 ft	3.417 ft	3.5 ft	0 ft	0 ft	0 ft
h/b <sub>s</sub> =	1.667 W4	2.143 W4		1.756 W4	1.714 W4			
DL w (plf) =	108.2	108.2	0	108.2	108.2	0	0	108.2
0.6M <sub>R</sub> (#-ft) =	292	177	0	379	398	0	0	0
PLF	W E	W E	W E	W E	W E	W E	W E	W E
M <sub>tot</sub> (#-ft) =	6189	14471	4493	10505	0	0	0	0
F (#) =	4020	9715	4018	9655	0	0	0	0
Holddown	4065 H3	4065 H3	1000 -	4065 H3	4065 H3	1000 -	1000 -	1000 -
	HDU5 NG	HDU5 NG	No Holddown OK	HDU5 NG	HDU5 NG	No Holddown OK	No Holddown OK	No Holddown OK
	(see calc next pp OK)							
1st Floor: W4	Wind (ASD): 0.773 kips Seismic (ASD): 0.903 kips		287 #/ft 598 #/ft		291 #/ft 606 #/ft		0.5 (ft) holddown dist from end	
use W5P SW 2B-L3 -1	5	5	use W6P SW 2B-L3 -2	6	6	not used	5	5
3 ft	2.333 ft	0 ft	3.417 ft	3.5 ft	0 ft	0 ft	0 ft	0 ft
9.083 ft								
Distribution L	3 ft	2.178 ft	0 ft	3.417 ft	3.5 ft	0 ft	0 ft	0 ft
h/b <sub>s</sub> =	1.667 W4	2.143 W4		1.756 W4	1.714 W4			
DL w (plf) =	108.2	108.2	0	108.2	108.2	0	0	108.2
0.6M <sub>R</sub> (#-ft) =	292	177	0	379	398	0	0	0
PLF	W E	W E	W E	W E	W E	W E	W E	W E
M <sub>tot</sub> (#-ft) =	7931	16506	5758	11982	0	0	0	0
F (#) =	7076	16200	7062	16095	0	0	0	0
Holddown	6970 H4	6970 H4	1000 -	6970 H4	6970 H4	1000 -	1000 -	1000 -
	HDU8 NG	HDU8 NG	No Holddown OK	HDU8 NG	HDU8 NG	No Holddown OK	No Holddown OK	No Holddown OK
	(see calc next pp OK)							



Job # 23.007 Sheet:

Designer: TLC Date: 5/26

Checked: Date:

Project: Bradley Height Apartments

1B-L2

0.5 (ft) holddown dist from end

<b>Roof:</b> W1	Wind (ASD): 3.581 kips Seismic (ASD): 5.568 kips				142 #/ft 221 #/ft				142 #/ft 221 #/ft	
										9.083 ft
	0 ft	0 ft	0 ft	0 ft	25.17 ft	0 ft	0 ft	0 ft	0 ft	25.17 ft
Distribution L	0 ft	0 ft	0 ft	0 ft	25.17 ft	0 ft	0 ft	0 ft	0 ft	25.17 ft
$h/b_s =$					0.361 W1					
DL w (plf) =	0				384.2	0				
0.6M <sub>R</sub> (#-ft) =	0				73002	0				
PLF	W	E	W	E	W	E	W	E	W	E
	0	0	0	0	142	221	0	0	0	0
M <sub>ot</sub> (#-ft) =	0				32525	50574	0			
F (#) =	0				-1641	-909	0			
Holddown	1000	-	1000	-	1000	-	1000	-	1000	-
	No Holddown OK	No Holddown OK	No Holddown OK	No Holddown OK	No Holddown OK	No Holddown OK	No Holddown OK	No Holddown OK	No Holddown OK	No Holddown OK

<b>3rd Floor:</b> W4	Wind (ASD): 2.339 kips Seismic (ASD): 7.516 kips				235 #/ft 520 #/ft				235 #/ft 520 #/ft	
										9.083 ft
	0 ft	0 ft	0 ft	0 ft	25.17 ft	0 ft	0 ft	0 ft	0 ft	25.17 ft
Distribution L	0 ft	0 ft	0 ft	0 ft	25.17 ft	0 ft	0 ft	0 ft	0 ft	25.17 ft
$h/b_s =$					0.361 W4					
DL w (plf) =	0				108.2	184	0			
0.6M <sub>R</sub> (#-ft) =	0				23269	0	0			
PLF	W	E	W	E	W	E	W	E	W	E
	0	0	0	0	235	520	0	0	0	0
M <sub>ot</sub> (#-ft) =	0				53775	118849	0			
F (#) =	0				-404	2966	0			
Holddown	2335	S2	1000	-	1000	-	1000	-	1000	-
	MST48 OK	No Holddown OK	No Holddown OK	No Holddown OK	MST60 OK	No Holddown OK	No Holddown OK	No Holddown OK	No Holddown OK	MST48 OK

<b>2nd Floor</b> W5	Wind (ASD): 2.320 kips Seismic (ASD): 4.436 kips				327 #/ft 696 #/ft				327 #/ft 696 #/ft	
										9.083 ft
	0 ft	0 ft	0 ft	0 ft	25.17 ft	0 ft	0 ft	0 ft	0 ft	25.17 ft
Distribution L	0 ft	0 ft	0 ft	0 ft	25.17 ft	0 ft	0 ft	0 ft	0 ft	25.17 ft
$h/b_s =$					0.361 W5					
DL w (plf) =	0				108.2	0	0			
0.6M <sub>R</sub> (#-ft) =	0				23269	0	0			
PLF	W	E	W	E	W	E	W	E	W	E
	0	0	0	0	327	696	0	0	0	0
M <sub>ot</sub> (#-ft) =	0				74851	159139	0			
F (#) =	0				1687	8474	0			
Holddown	4065	H3	6970	H4	1000	-	1000	-	6970	H4
	1.05	HDU5 OK	HDU8 OK	No Holddown OK	No Holddown OK	HDU11 OK	No Holddown OK	No Holddown OK	HDU8 OK	HDU11 OK



Job # 23.007 Sheet:

Designed TLC Date: 5/26

Checked: Date:

Project: Bradley Height Apartments  
1B-13

0.5 (ft) holddown dist from end

Roof: W2	Wind (ASD): 1.194 kips Seismic (ASD): 1.906 kips		173 #/ft 276 #/ft		173 #/ft 276 #/ft		0.5 (ft) holddown dist from end	
use W1P SW 1B-L3 -1	5	5	5	6	6	6	6	9.083 ft
0 ft	0 ft	0 ft	3.417 ft	3.5 ft	0 ft	0 ft	0 ft	6.917
Distribution L	0 ft	0 ft	0 ft	3.417 ft	3.5 ft	0 ft	0 ft	6.917
h/b <sub>s</sub> =			1.756 W2	1.714 W2				
DL w (plf) =	427.2	427.2	382.3	382.3	0	0	429.1	429.1
0.6M <sub>R</sub> (#-ft) =	0	0	1339	1405	0	0	0	0
PLF	W E	W E	W E	W E	W E	W E	W E	W E
M <sub>tot</sub> (#-ft) =	0	0	5356	8554	5486	8763	0	0
F (#) =	0	0	1377	2474	1360	2453	0	0
Holddown	1000 -	1000 -	1000 -	1256 S1	1256 S1	1000 -	1000 -	1000 -
	No Holddown OK	No Holddown OK	No Holddown OK	MST37 NG	MST37 NG	No Holddown OK	No Holddown OK	No Holddown OK
	(see calc next pp OK)							
3rd Floor: W3	Wind (ASD): 0.780 kips Seismic (ASD): 2.71 kips		161 #/ft 377 #/ft		163 #/ft 382 #/ft		0.5 (ft) holddown dist from end	
use W3P SW 2B-L3 -1	5	5	6	6	6	6	9.083 ft	
3 ft	2.333 ft	0 ft	3.417 ft	3.5 ft	0 ft	0 ft	0 ft	12.25
Distribution L	3 ft	2.178 ft	0 ft	3.417 ft	3.5 ft	0 ft	0 ft	12.09
h/b <sub>s</sub> =	1.667 W3	2.143 W3	1.756 W3	1.714 W3				
DL w (plf) =	108.2	108.2	108.2	108.2	0	0	108.2	108.2
0.6M <sub>R</sub> (#-ft) =	292	177	379	398	0	0	0	0
PLF	W E	W E	W E	W E	W E	W E	W E	W E
M <sub>tot</sub> (#-ft) =	4446	10401	3228	7550	0	0	0	0
F (#) =	1662	4043	1664	4022	0	0	0	0
Holddown	2335 S2	2335 S2	1000 -	2335 S2	2335 S2	1000 -	1000 -	1000 -
	MST48 NG	MST48 NG	No Holddown OK	MST48 NG	MST48 NG	No Holddown OK	No Holddown OK	No Holddown OK
	(see calc next pp OK)							
2nd Floor: W4	Wind (ASD): 0.773 kips Seismic (ASD): 1.806 kips		224 #/ft 524 #/ft		227 #/ft 531 #/ft		0.5 (ft) holddown dist from end	
use W4P SW 2B-L3 -1	5	5	6	6	6	6	9.083 ft	
3 ft	2.333 ft	0 ft	3.417 ft	3.5 ft	0 ft	0 ft	0 ft	12.25
Distribution L	3 ft	2.178 ft	0 ft	3.417 ft	3.5 ft	0 ft	0 ft	12.09
h/b <sub>s</sub> =	1.667 W4	2.143 W4	1.756 W4	1.714 W4				
DL w (plf) =	108.2	108.2	108.2	108.2	0	0	108.2	108.2
0.6M <sub>R</sub> (#-ft) =	292	177	379	398	0	0	0	0
PLF	W E	W E	W E	W E	W E	W E	W E	W E
M <sub>tot</sub> (#-ft) =	6189	14471	4493	10505	0	0	0	0
F (#) =	4020	9715	4018	9655	0	0	0	0
Holddown	4670 S4	4670 S4	1000 -	4670 S4	4670 S4	1000 -	1000 -	1000 -
	(2) MST48 NG	(2) MST48 NG	No Holddown OK	(2) MST48 NG	(2) MST48 NG	No Holddown OK	No Holddown OK	No Holddown OK
	(see calc next pp OK)							
1st Floor: W4	Wind (ASD): 0.773 kips Seismic (ASD): 0.903 kips		287 #/ft 598 #/ft		291 #/ft 606 #/ft		0.5 (ft) holddown dist from end	
use W5P SW 2B-L3 -1	5	5	6	6	6	6	9.083 ft	
3 ft	2.333 ft	0 ft	3.417 ft	3.5 ft	0 ft	0 ft	0 ft	12.25
Distribution L	3 ft	2.178 ft	0 ft	3.417 ft	3.5 ft	0 ft	0 ft	12.09
h/b <sub>s</sub> =	1.667 W4	2.143 W4	1.756 W4	1.714 W4				
DL w (plf) =	108.2	108.2	108.2	108.2	0	0	108.2	108.2
0.6M <sub>R</sub> (#-ft) =	292	177	379	398	0	0	0	0
PLF	W E	W E	W E	W E	W E	W E	W E	W E
M <sub>tot</sub> (#-ft) =	7931	16506	5758	11982	0	0	0	0
F (#) =	7076	16200	7062	16095	0	0	0	0
Holddown	6970 H4	6970 H4	1000 -	6970 H4	6970 H4	1000 -	1000 -	1000 -
	1.05	HDU8 NG	HDU8 NG	No Holddown OK	HDU8 NG	HDU8 NG	No Holddown OK	No Holddown OK
	(see calc next pp OK)							

Shear Wall Line 2B-L3-1 1st

W Designation

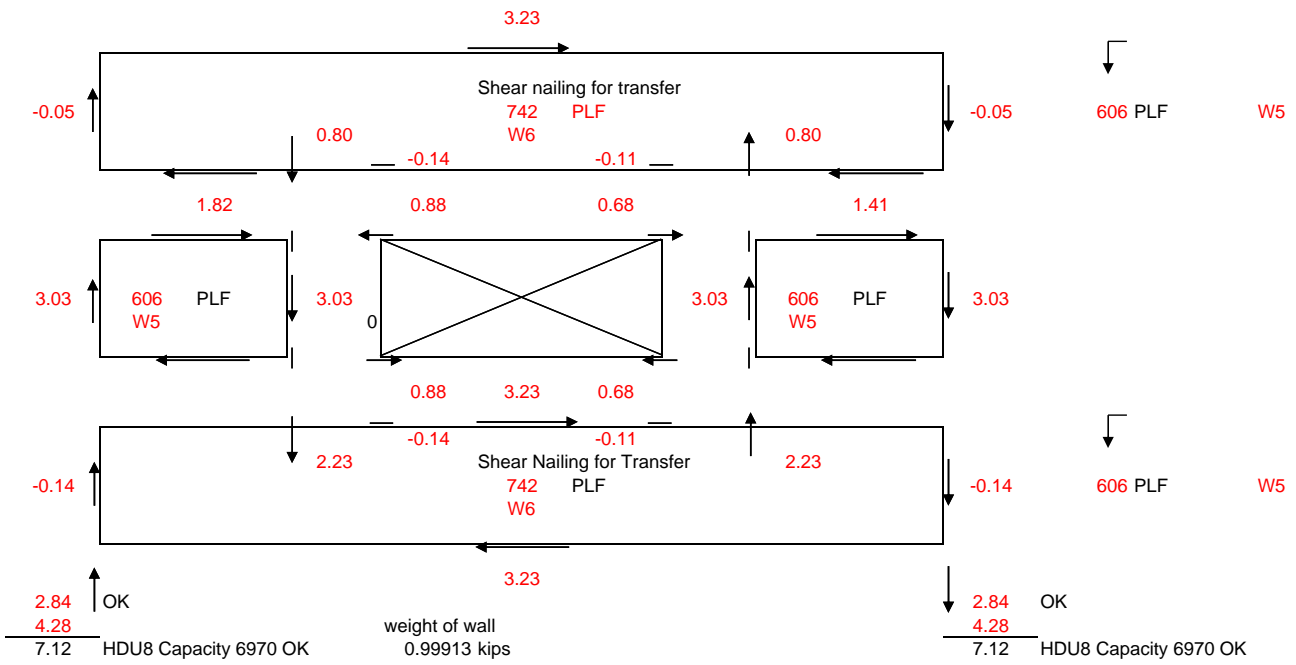
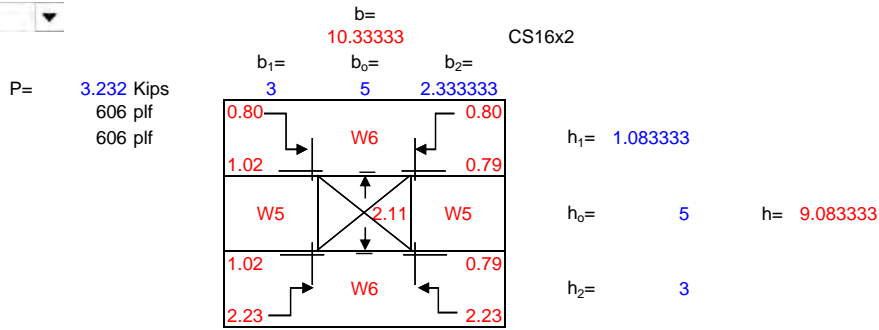

Shear Wall Line 2B-L3-1 2nd

W Designation

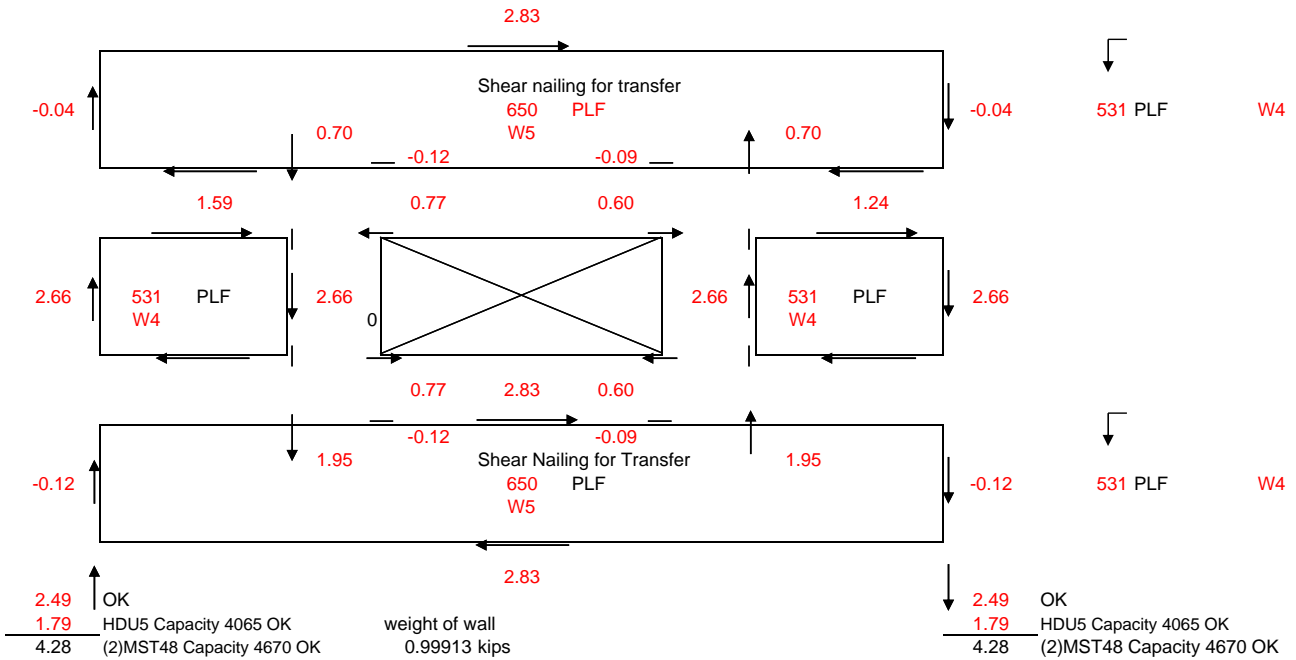
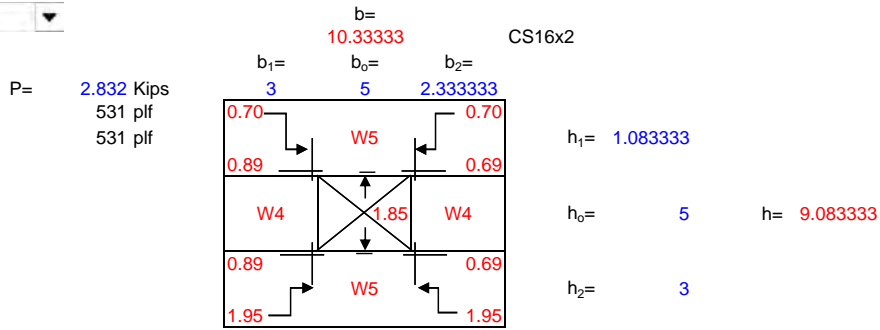



Shear Wall Line 1B-L3-1 3rd

W Designation

P= 2.037 Kips  
382 plf  
382 plf

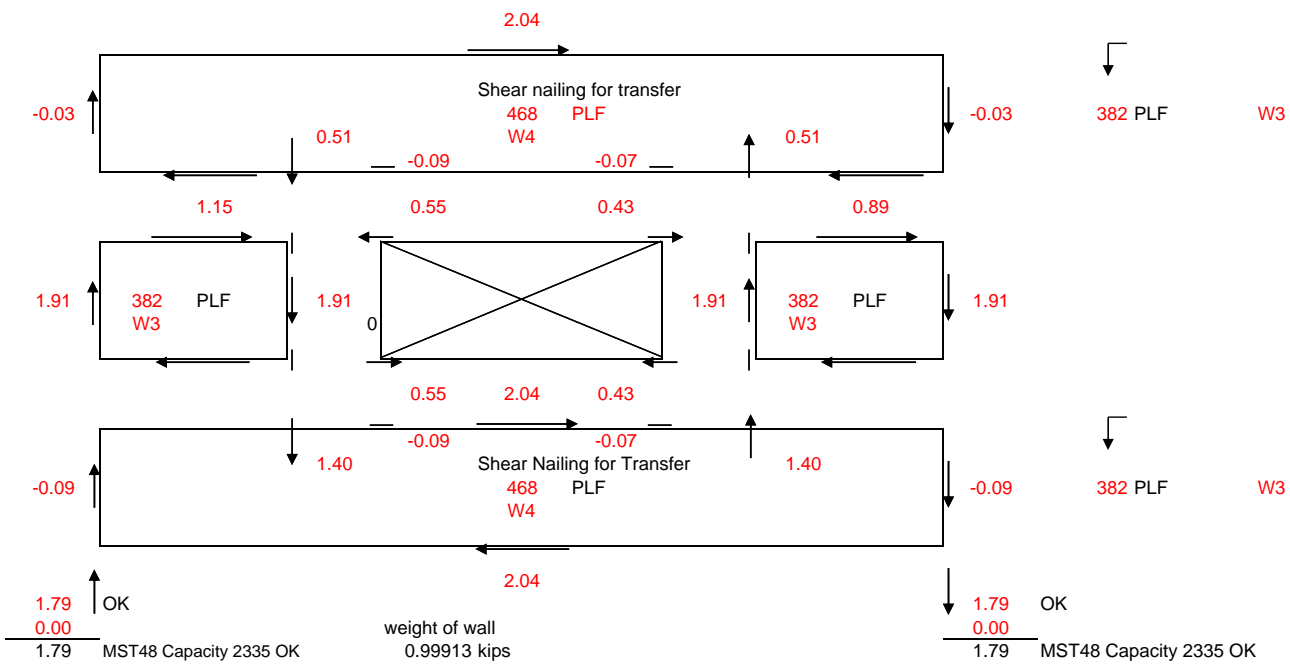
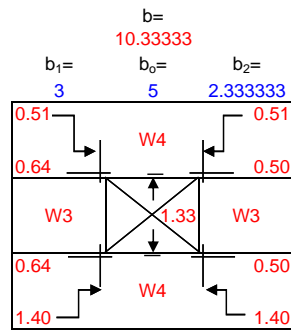

Shear Wall Line 1B-L3-1 roof not used

W Designation

P= 0.000 Kips  
0 plf  
0 plf

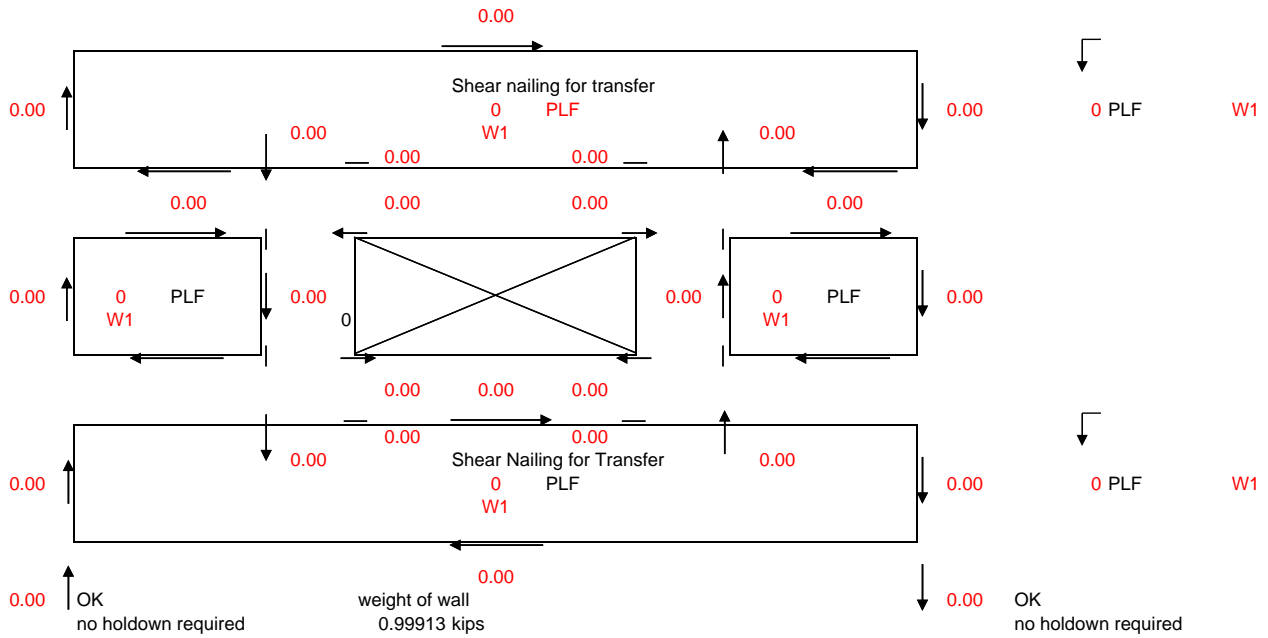
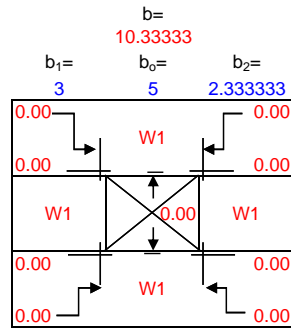

Shear Wall Line 1B-L3-2 1st

W Designation

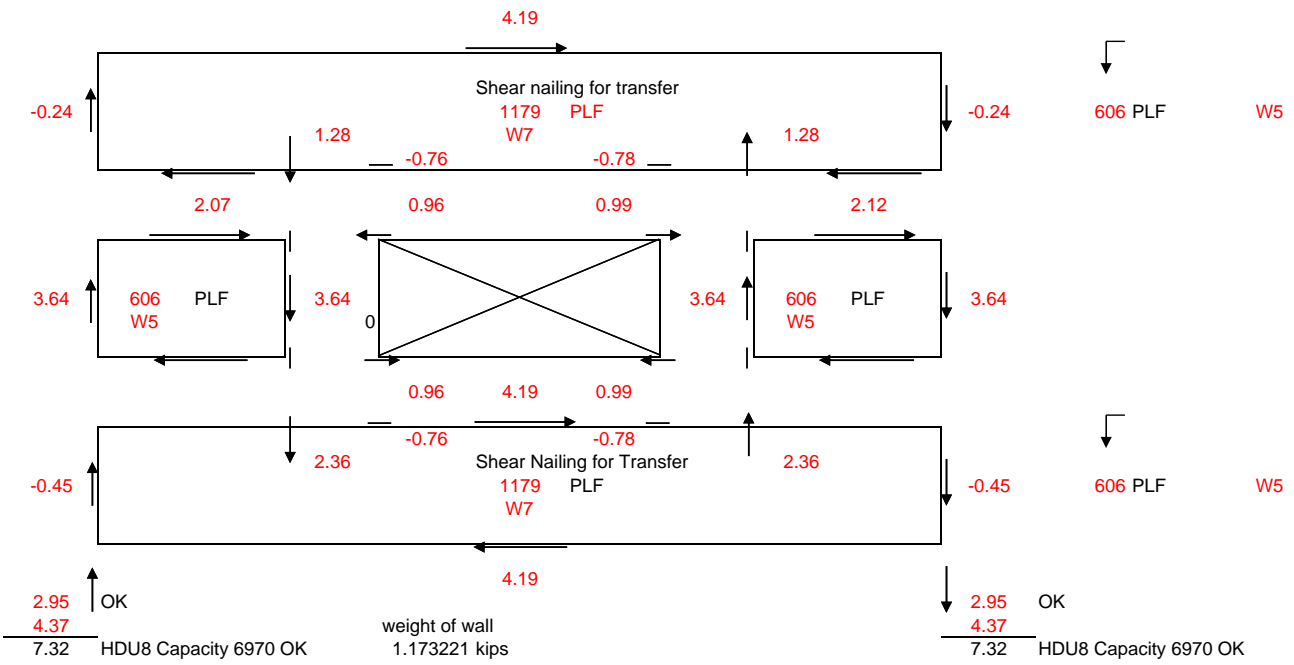
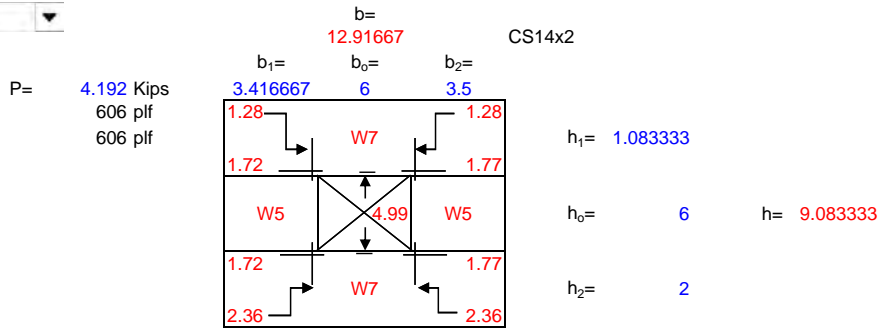

Shear Wall Line 1B-L3-2 2nd

W Designation

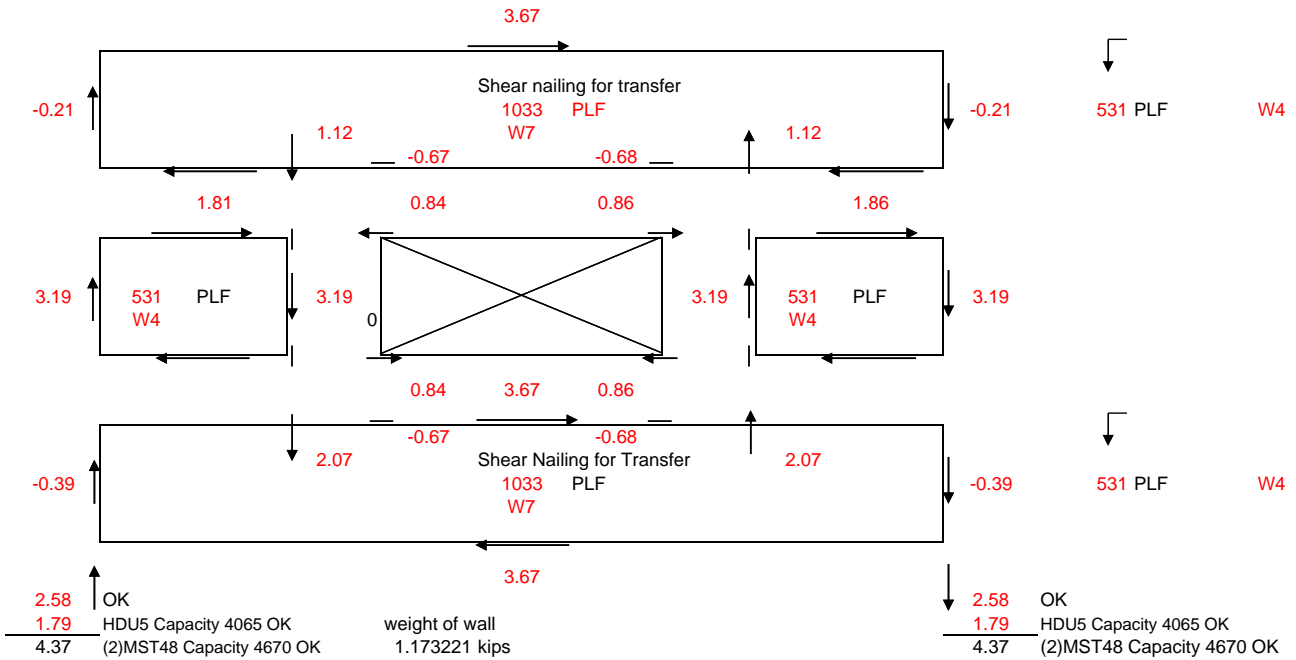
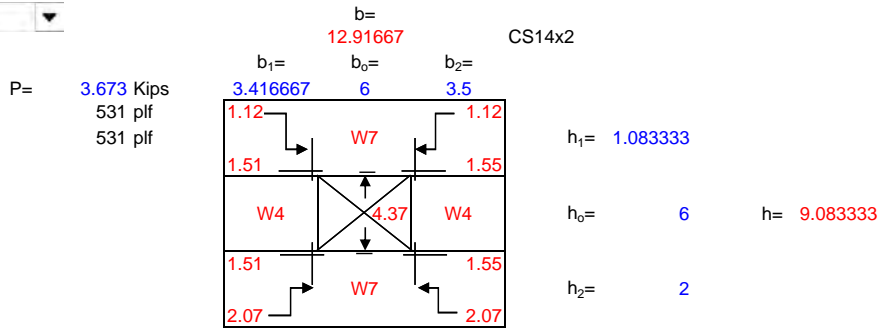

Shear Wall Line 1B-L3-2 3rd

W Designation

P= 2.642 Kips  
382 plf  
382 plf

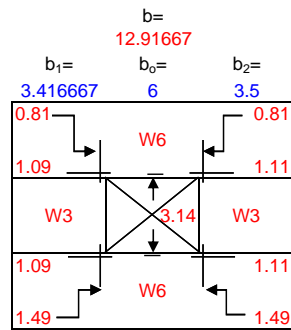

CS16x2

$h_1 = 1.083333$

$h_0 = 6$       $h = 9.083333$

$h_2 = 2$

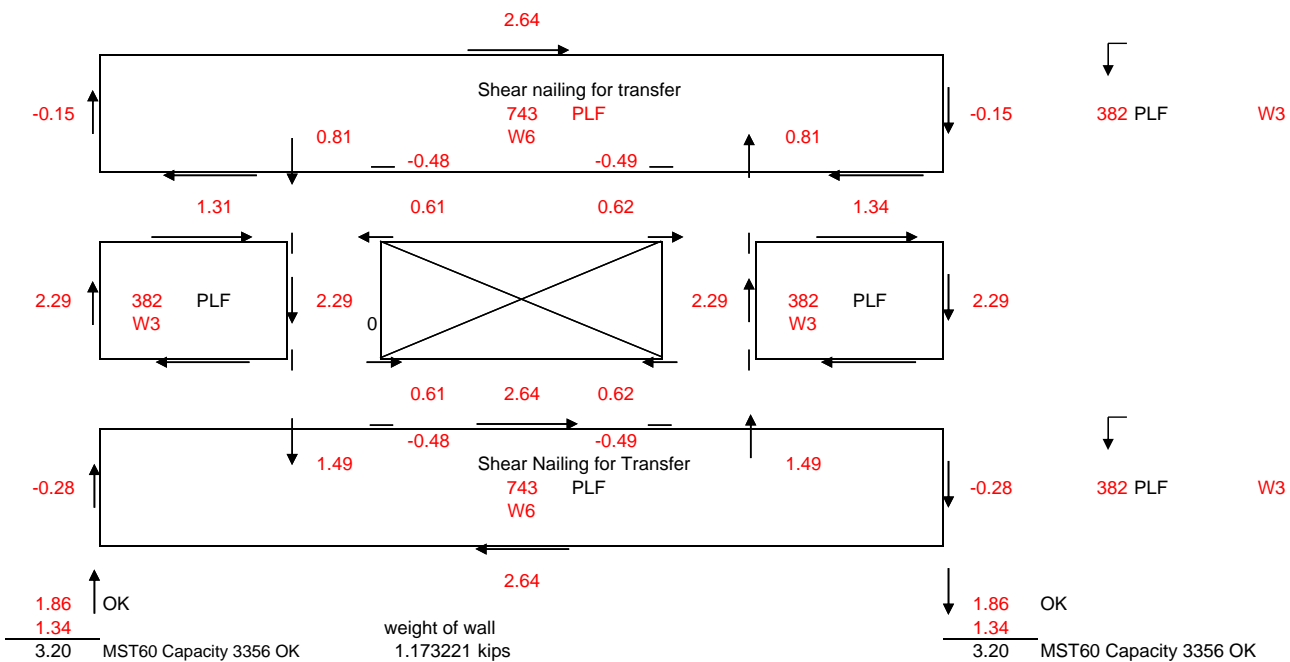

Shear Wall Line 1B-L3-2 roof

W Designation

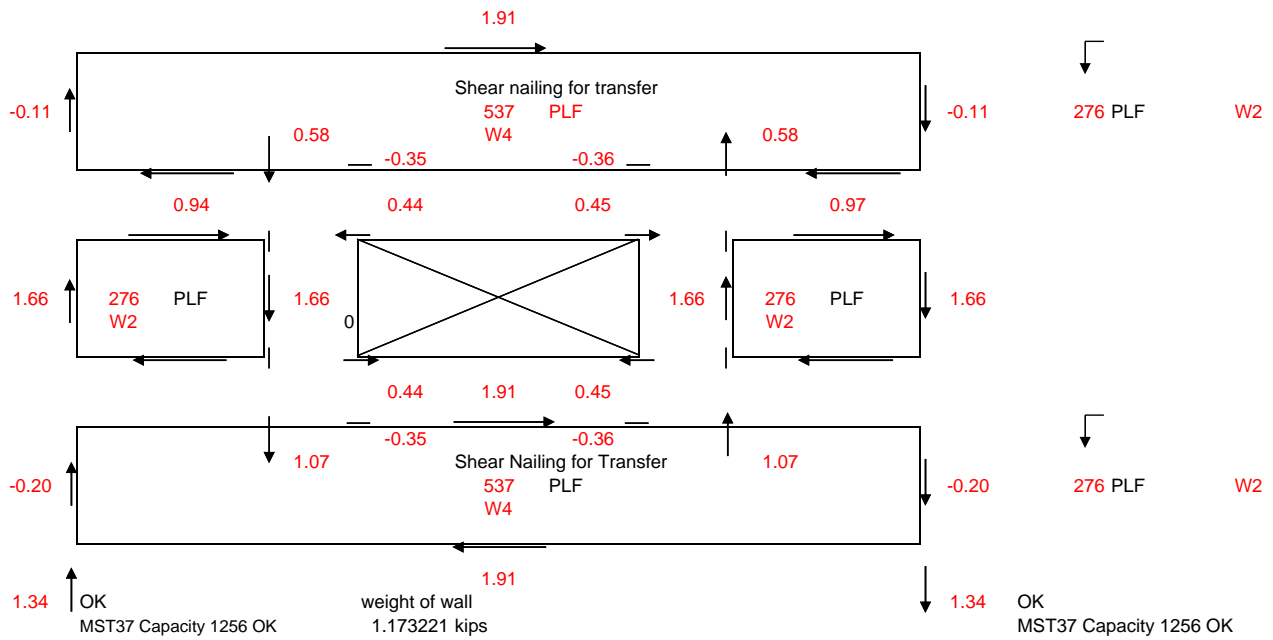
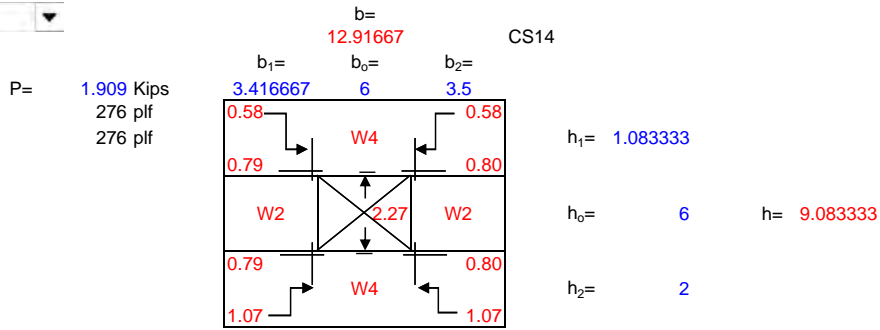



Job # 23.007 Sheet:

Designed TLC Date: 5/26

Checked: Date:

Project: Bradley Height Apartments

B-T1 end (3 story + Basement)

0.5 (ft) holdown dist from end

Roof: W1	Wind (ASD): 2.153 kips Seismic (ASD): 4.027 kips		43 #/ft 81 #/ft		43 #/ft 81 #/ft					
										9.083 ft
	8.417 ft	9.417 ft	0 ft	0 ft	13.92 ft	0 ft	0 ft	9.417 ft	8.417 ft	49.58
Distribution L	8.417 ft	9.417 ft	0 ft	0 ft	13.92 ft	0 ft	0 ft	9.417 ft	8.417 ft	49.58
$h/b_s =$ DL w (plf) = 0.6M <sub>u</sub> (#-ft) =	1.079 W1 178.8 3801	0.965 W1 178.8 4757	0 0 0	0 0 0	0.653 W1 178.8 10391	0 0 0	0 0 0	0.965 W1 178.8 4757	1.079 W1 178.8 3801	
PLF	W E 43 81	W E 43 81	W E 0 0	W E 0 0	W E 43 81	W E 0 0	W E 0 0	W E 43 81	W E 43 81	
M <sub>u</sub> (#-ft) = F (#) =	3319 6209 -61 304	3714 6946 -117 245	0 0 0 0	0 0 0 0	5488 10266 -365 -9	0 0 0 0	0 0 0 0	3714 6946 -117 245	3319 6209 -61 304	
Holddown	1000 -	1000 -	1000 -	1000 -	1000 -	1000 -	1000 -	1000 -	1000 -	
	No Holddown OK	No Holddown OK	No Holddown OK	No Holddown OK	No Holddown OK	No Holddown OK	No Holddown OK	No Holddown OK	No Holddown OK	

3rd Floor: W1	Wind (ASD): 1.406 kips Seismic (ASD): 5.419 kips		72 #/ft 191 #/ft		72 #/ft 191 #/ft					
										9.083 ft
	8.417 ft	9.417 ft	0 ft	0 ft	13.92 ft	0 ft	0 ft	9.417 ft	8.417 ft	49.58
Distribution L	8.417 ft	9.417 ft	0 ft	0 ft	13.92 ft	0 ft	0 ft	9.417 ft	8.417 ft	49.58
$h/b_s =$ DL w (plf) = 0.6M <sub>u</sub> (#-ft) =	1.079 W1 255.5 5431	0.965 W1 255.5 6798	0 0 0	0 0 0	0.653 W1 231.6 13458	0 0 0	0 0 0	0.965 W1 255.5 6798	1.079 W1 255.5 5431	
PLF	W E 72 191	W E 72 191	W E 0 0	W E 0 0	W E 72 191	W E 0 0	W E 0 0	W E 72 191	W E 72 191	
M <sub>u</sub> (#-ft) = F (#) =	5488 14564 -54 1458	6140 16295 -191 1311	0 0 0 0	0 0 0 0	9074 24082 -692 783	0 0 0 0	0 0 0 0	6140 16295 -191 1311	5488 14564 -54 1458	
Holddown	2335 S2	2335 S2	1000 -	1000 -	2335 S2	1000 -	1000 -	2335 S2	2335 S2	
	MST48 OK	MST48 OK	No Holddown OK	No Holddown OK	MST48 OK	No Holddown OK	No Holddown OK	MST48 OK	MST48 OK	

with point load ok by inspection

2nd Floor W2	Wind (ASD): 1.395 kips Seismic (ASD): 3.198 kips		100 #/ft 255 #/ft		100 #/ft 255 #/ft					
										9.083 ft
	8.417 ft	9.417 ft	0 ft	0 ft	13.92 ft	0 ft	0 ft	9.417 ft	8.417 ft	49.58
Distribution L	8.417 ft	9.417 ft	0 ft	0 ft	13.92 ft	0 ft	0 ft	9.417 ft	8.417 ft	49.58
$h/b_s =$ DL w (plf) = 0.6M <sub>u</sub> (#-ft) =	1.079 W2 255.5 5431	0.965 W2 255.5 6798	0 0 0	0 0 0	0.653 W2 231.6 13458	0 0 0	0 0 0	0.965 W2 255.5 6798	1.079 W2 255.5 5431	
PLF	W E 100 255	W E 100 255	W E 0 0	W E 0 0	W E 100 255	W E 0 0	W E 0 0	W E 100 255	W E 100 255	
M <sub>u</sub> (#-ft) = F (#) =	7638 19496 225 3234	8546 21812 5 2994	0 0 0 0	0 0 0 0	12630 32235 -754 2182	0 0 0 0	0 0 0 0	8546 21812 5 2994	7638 19496 225 3234	
Holddown	4065 H3	4065 H3	1000 -	1000 -	1000 -	1000 -	1000 -	3356 S3	3356 S3	
	HDUS OK	HDUS OK	No Holddown OK	No Holddown OK	No Holddown NG	No Holddown OK	No Holddown OK	MST60 OK	MST60 OK	

Load above to foundation

1st Floor W2	Wind (ASD): -1.619 kips Seismic (ASD): -5.345 kips		135 #/ft 294 #/ft		4.954 12.644		135 #/ft 294 #/ft			
										9.083 ft
	0 ft	0 ft	0 ft	0 ft	6.958 ft	0 ft	0 ft	9.417 ft	8.417 ft	24.79
Distribution L	0 ft	0 ft	0 ft	0 ft	6.958 ft	0 ft	0 ft	9.417 ft	8.417 ft	24.79
$h/b_s =$ DL w (plf) = 0.6M <sub>u</sub> (#-ft) =	0 0 0	0 0 0	0 0 0	0 0 0	1.305 W2 0 0	0 0 0	0 0 0	0.965 W2 221.9 5903	1.079 W2 234.9 4992	
PLF	W E 0 0	W E 0 0	W E 0 0	W E 0 0	W E 135 294	W E 0 0	W E 0 0	W E 135 294	W E 135 294	
M <sub>u</sub> (#-ft) = F (#) =	0 0 225 3234	0 0 5 2994	0 0 0 0	0 0 0 0	8503 18608 563 5063	0 0 0 0	0 0 0 0	11507 25182 634 5156	10285 22508 894 5447	
Holddown	1000 -	1000 -	1000 -	1000 -	6970 H4	1000 -	1000 -	6970 H4	6970 H4	
	1.05	No Holddown NG	No Holddown NG	No Holddown OK	No Holddown OK	HDUS OK	No Holddown OK	No Holddown OK	HDUS OK	HDUS OK

concrete foundation OK

OK By Inspection OK By Inspection

2 Bedroom Unit 3 story

2 Bedroom Unit 3 story + Basement

PRMU20240280 BLDG G



Job # 23.007 Sheet:

Designed TLC Date: 5/26

Checked: Date:

Project: Bradley Height Apartments

1B-T1 x2 backs (3 story + Base)

0.5 (ft) holdown dist from end

Roof: W1	Wind (ASD): 4.305 kips Seismic (ASD): 8.053 kips								83 #/ft 154 #/ft	83 #/ft 154 #/ft
										9.083 ft
Distribution L	26.08 ft	0 ft	0 ft	0 ft	0 ft	0 ft	0 ft	0 ft	26.08 ft	52.17
$h/b_s = 0.348$ W1 DL w (plf) = 112.8 $0.6M_R$ (#-ft) = 23030	0	0	0	0	0	0	0	0	112.8	23030
PLF	W E 83 154	0 0	0 0	0 0	0 0	0 0	0 0	0 0	83 154	
$M_{br}$ (#-ft) = 19554 36576 F (#) = -136 529	0 0	0 0	0 0	0 0	0 0	0 0	0 0	0 0	19554 36576	-136 529
Holdown	1000 -	1000 -	1000 -	1000 -	1000 -	1000 -	1000 -	1000 -	1000 -	
	No Holdown OK	No Holdown OK	No Holdown OK	No Holdown OK	No Holdown OK	No Holdown OK	No Holdown OK	No Holdown OK	No Holdown OK	

3rd Floor: W2	Wind (ASD): 2.813 kips Seismic (ASD): 10.839 kips								136 #/ft 362 #/ft	136 #/ft 362 #/ft
										9.083 ft
Distribution L	26.08 ft	0 ft	0 ft	0 ft	0 ft	0 ft	0 ft	0 ft	26.08 ft	52.17
$h/b_s = 0.348$ W2 DL w (plf) = 108.2 $0.6M_R$ (#-ft) = 22077	0	0	0	0	0	0	0	0	108.2	22077
PLF	W E 136 362	0 0	0 0	0 0	0 0	0 0	0 0	0 0	136 362	
$M_{br}$ (#-ft) = 32328 85801 F (#) = 265 3020	0 0	0 0	0 0	0 0	0 0	0 0	0 0	0 0	32328 85801	265 3020
Holdown	3356 S3	1000 -	1000 -	1000 -	1000 -	1000 -	1000 -	1000 -	3356 S3	
	MST60 OK	No Holdown OK	No Holdown OK	No Holdown OK	No Holdown OK	No Holdown OK	No Holdown OK	No Holdown OK	MST60 OK	MST60 OK

with point load ok by inspection

2nd Floor W4	Wind (ASD): 2.790 kips Seismic (ASD): 6.396 kips								190 #/ft 485 #/ft	190 #/ft 485 #/ft
										9.083 ft
Distribution L	26.08 ft	0 ft	0 ft	0 ft	0 ft	0 ft	0 ft	0 ft	26.08 ft	52.17
$h/b_s = 0.348$ W4 DL w (plf) = 108.2 $0.6M_R$ (#-ft) = 22077	0	0	0	0	0	0	0	0	108.2	22077
PLF	W E 190 485	0 0	0 0	0 0	0 0	0 0	0 0	0 0	190 485	
$M_{br}$ (#-ft) = 44999 114850 F (#) = 1161 6647	0 0	0 0	0 0	0 0	0 0	0 0	0 0	0 0	44999 114850	1161 6647
Holdown	6970 H4	6970 H4	1000 -	1000 -	1000 -	1000 -	1000 -	1000 -	6712 S5	6712 S5
	HDU8 OK	HDU8 OK	No Holdown OK	No Holdown OK	No Holdown OK	No Holdown OK	No Holdown OK	No Holdown OK	(2) MST60 OK	(2) MST60 OK

Load above to foundation above

1st Floor W4	Wind (ASD): -3.237 kips Seismic (ASD): -10.690 kips								256 #/ft 560 #/ft	256 #/ft 560 #/ft
										9.083 ft
Distribution L	0 ft	0 ft	0 ft	0 ft	0 ft	0 ft	0 ft	0 ft	26.08 ft	26.08
$h/b_s = 0.348$ W4 DL w (plf) = 108.2 $0.6M_R$ (#-ft) = 22077	0	0	0	0	0	0	0	0	108.2	22077
PLF	W E 256 560	0 0	0 0	0 0	0 0	0 0	0 0	0 0	256 560	
$M_{br}$ (#-ft) = 60593 132596 F (#) = 1161 6647	0 0	0 0	0 0	0 0	0 0	0 0	0 0	0 0	60593 132596	2666 10967
Holdown	1000 -	1000 -	1000 -	1000 -	1000 -	1000 -	1000 -	1000 -	14445 H6	
	1.05	No Holdown NG	No Holdown OK	No Holdown OK	No Holdown OK	No Holdown OK	No Holdown OK	No Holdown OK	No Holdown OK	HDU14 OK

concrete foundation OK  
OK By Inspection

2 Bedroom Unit 3 story | 2 Bedroom Unit 3 story + Basement

PRMU20240280 BLDG G





Job # 23.007 Sheet:

Designer: TLC Date: 5/26

Checked: Date:

Project: Bradley Height Apartments  
T1 x 2 backs (3 story)

0.5 (ft) holddown dist from end

Roof: W1	Wind (ASD): 4.305 kips		83 #/ft		83 #/ft		83 #/ft		83 #/ft	
	Seismic (ASD): 8.053 kips		154 #/ft		154 #/ft		154 #/ft		154 #/ft	
										9.083 ft
	26.08 ft	0 ft	0 ft	0 ft	0 ft	0 ft	0 ft	0 ft	0 ft	26.08 ft
Distribution L	26.08 ft	0 ft	0 ft	0 ft	0 ft	0 ft	0 ft	0 ft	0 ft	26.08 ft
h/b <sub>s</sub> =	0.348 W1								0.348 W1	
DL w (plf) =	112.8		0		0		0		112.8	
0.6M <sub>R</sub> (#-ft) =	23030		0		0		0		23030	
PLF	W	E	W	E	W	E	W	E	W	E
	83	154	0	0	0	0	0	0	0	0
M <sub>ot</sub> (#-ft) =	19554	36576	0	0	0	0	0	0	0	0
F (#) =	-136	529	0	0	0	0	0	0	0	0
Holddown	1000	-	1000	-	1000	-	1000	-	1000	-
	No Holddown OK	No Holddown OK	No Holddown OK	No Holddown OK	No Holddown OK	No Holddown OK	No Holddown OK	No Holddown OK	No Holddown OK	No Holddown OK

3rd Floor: W2	Wind (ASD): 2.813 kips		136 #/ft		136 #/ft		136 #/ft		136 #/ft	
	Seismic (ASD): 10.839 kips		362 #/ft		362 #/ft		362 #/ft		362 #/ft	
										9.083 ft
	26.08 ft	0 ft	0 ft	0 ft	0 ft	0 ft	0 ft	0 ft	0 ft	26.08 ft
Distribution L	26.08 ft	0 ft	0 ft	0 ft	0 ft	0 ft	0 ft	0 ft	0 ft	26.08 ft
h/b <sub>s</sub> =	0.348 W2								0.348 W2	
DL w (plf) =	108.2		0		0		0		108.2	
0.6M <sub>R</sub> (#-ft) =	22077		0		0		0		22077	
PLF	W	E	W	E	W	E	W	E	W	E
	136	362	0	0	0	0	0	0	0	0
M <sub>ot</sub> (#-ft) =	32328	85801	0	0	0	0	0	0	0	0
F (#) =	265	3020	0	0	0	0	0	0	0	0
Holddown	3356	S3	1000	-	1000	-	1000	-	1000	-
	MST60 OK	No Holddown OK	No Holddown OK	No Holddown OK	No Holddown OK	No Holddown OK	No Holddown OK	No Holddown OK	No Holddown OK	MST60 OK

2nd Floor W4	Wind (ASD): 2.790 kips		190 #/ft		190 #/ft		190 #/ft		190 #/ft	
	Seismic (ASD): 6.396 kips		485 #/ft		485 #/ft		485 #/ft		485 #/ft	
										9.083 ft
	26.08 ft	0 ft	0 ft	0 ft	0 ft	0 ft	0 ft	0 ft	0 ft	26.08 ft
Distribution L	26.08 ft	0 ft	0 ft	0 ft	0 ft	0 ft	0 ft	0 ft	0 ft	26.08 ft
h/b <sub>s</sub> =	0.348 W4								0.348 W4	
DL w (plf) =	108.2		0		0		0		108.2	
0.6M <sub>R</sub> (#-ft) =	22077		0		0		0		22077	
PLF	W	E	W	E	W	E	W	E	W	E
	190	485	0	0	0	0	0	0	0	0
M <sub>ot</sub> (#-ft) =	44999	114850	0	0	0	0	0	0	0	0
F (#) =	1161	6647	0	0	0	0	0	0	0	0
Holddown	6970	H4	1000	-	1000	-	1000	-	1000	-
	1.05 HDU8 OK	No Holddown OK	No Holddown OK	No Holddown OK	No Holddown OK	No Holddown OK	No Holddown OK	No Holddown OK	No Holddown OK	HDU8 OK



Job # 23.007 Sheet:

Design: TLC Date: 5/26

Checked: Date:

Project: Bradley Height Apartments  
1B-T2 stairs (3 story + Base)

0.5 (ft) holdown dist from end

Roof: W1	Wind (ASD): 2.631 kips Seismic (ASD): 4.921 kips								49 #/ft 92 #/ft	49 #/ft 92 #/ft
										9.083 ft
Distribution L	17 ft	0 ft	0 ft	0 ft	19.5 ft	0 ft	0 ft	0 ft	17 ft	53.5
h/b <sub>s</sub> = 0.534 W1 DL w (plf) = 178.8 0.6M <sub>R</sub> (#-ft) = 15505					0.466 W1 178.8 20400				0.534 W1 178.8 15505	
PLF	W E 49 92	W E 0 0	W E 0 0	W E 0 0	W E 49 92	W E 0 0	W E 0 0	W E 0 0	W E 49 92	
M <sub>tot</sub> (#-ft) = F (#) =	7594 14205 -479 -79	0 0 0 0	0 0 0 0	0 0 0 0	8711 16294 -615 -216	0 0 0 0	0 0 0 0	0 0 0 0	7594 14205 -479 -79	
Holdown	1000 -	1000 -	1000 -	1000 -	1000 -	1000 -	1000 -	1000 -	1000 -	
	No Holdown OK	No Holdown OK	No Holdown OK	No Holdown OK	No Holdown OK	No Holdown OK	No Holdown OK	No Holdown OK	No Holdown OK	

3rd Floor: W1	Wind (ASD): 1.719 kips Seismic (ASD): 6.624 kips								81 #/ft 216 #/ft	81 #/ft 216 #/ft
										9.083 ft
Distribution L	17 ft	0 ft	0 ft	0 ft	19.5 ft	0 ft	0 ft	0 ft	17 ft	53.5
h/b <sub>s</sub> = 0.534 W1 DL w (plf) = 252.3 0.6M <sub>R</sub> (#-ft) = 21870					0.466 W1 282.6 32236				0.534 W1 252.3 21870	
PLF	W E 81 216	W E 0 0	W E 0 0	W E 0 0	W E 81 216	W E 0 0	W E 0 0	W E 0 0	W E 81 216	
M <sub>tot</sub> (#-ft) = F (#) =	12555 33322 -1044 615	0 0 0 0	0 0 0 0	0 0 0 0	14402 38223 -1554 99	0 0 0 0	0 0 0 0	0 0 0 0	12555 33322 -1044 615	
Holdown	2335 S2	1000 -	1000 -	1000 -	2335 S2	1000 -	1000 -	1000 -	2335 S2	
	MST48 OK	No Holdown OK	No Holdown OK	No Holdown OK	MST48 OK	No Holdown OK	No Holdown OK	No Holdown OK	MST48 OK	

with point load ok by inspection

2nd Floor W2	Wind (ASD): 1.705 kips Seismic (ASD): 3.909 kips								113 #/ft 289 #/ft	113 #/ft 289 #/ft
										9.083 ft
Distribution L	17 ft	0 ft	0 ft	0 ft	19.5 ft	0 ft	0 ft	0 ft	17 ft	53.5
h/b <sub>s</sub> = 0.534 W2 DL w (plf) = 252.3 0.6M <sub>R</sub> (#-ft) = 21870					0.466 W2 282.6 32236				0.534 W2 252.3 21870	
PLF	W E 113 289	W E 0 0	W E 0 0	W E 0 0	W E 113 289	W E 0 0	W E 0 0	W E 0 0	W E 113 289	
M <sub>tot</sub> (#-ft) = F (#) =	17476 44604 -1310 1993	0 0 0 0	0 0 0 0	0 0 0 0	20046 51164 -2195 1095	0 0 0 0	0 0 0 0	0 0 0 0	17476 44604 -1310 1993	
Holdown	4065 H3	1000 -	1000 -	1000 -	4670 S4	1000 -	1000 -	1000 -	4670 S4	
	HDUS OK	No Holdown OK	No Holdown OK	No Holdown OK	(2) MST48 OK	No Holdown OK	No Holdown OK	No Holdown OK	(2) MST48 OK	

Load above to foundation

1st Floor W2	Wind (ASD): -1.978 kips Seismic (ASD): -6.533 kips								152 #/ft 333 #/ft	152 #/ft 333 #/ft
										9.083 ft
Distribution L	0 ft	0 ft	0 ft	0 ft	9.75 ft	0 ft	0 ft	0 ft	17 ft	26.75
h/b <sub>s</sub> = DL w (plf) = 0.6M <sub>R</sub> (#-ft) =					0.932 W2 282.6 8059				0.534 W2 252.3 21870	
PLF	W E 0 0	W E 0 0	W E 0 0	W E 0 0	W E 152 333	W E 0 0	W E 0 0	W E 0 0	W E 152 333	
M <sub>tot</sub> (#-ft) = F (#) =	0 0 -1310 1993	0 0 0 0	0 0 0 0	0 0 0 0	13496 29535 -1608 3417	0 0 0 0	0 0 0 0	0 0 0 0	23532 51496 -1210 3789	
Holdown	14445 H6	1000 -	1000 -	1000 -	6970 H4	1000 -	1000 -	1000 -	6970 H4	
	1.05 HDU14 OK	No Holdown OK	No Holdown OK	No Holdown OK	HDU8 OK	No Holdown OK	No Holdown OK	No Holdown OK	HDU8 OK	

concrete foundation

2 Bedroom Unit 3 story | 2 Bedroom Unit 3 story + Basement

PRMU20240280 BLDG G



Job # 23.007 Sheet:

Designer: TLC Date: 5/26

Checked: Date:

Project: Bradley Height Apartments

1B-T2 stairs (3 story)

0.5 (ft) holddown dist from end

Roof: W1	Wind (ASD): 2.631 kips 49 #/ft Seismic (ASD): 4.921 kips 92 #/ft								49 #/ft 92 #/ft		
										9.083 ft	
	17 ft	0 ft	0 ft	0 ft	19.5 ft	0 ft	0 ft	0 ft	17 ft	53.5	
Distribution L	17 ft	0 ft	0 ft	0 ft	19.5 ft	0 ft	0 ft	0 ft	17 ft	53.5	
h/b <sub>s</sub> = 0.534 W1									0.466 W1	0.534 W1	
DL w (plf) = 178.8	0								178.8	178.8	
0.6M <sub>R</sub> (#-ft) = 15505	0								20400	15505	
PLF	W E	W E	W E	W E	W E	W E	W E	W E	W E		
	49 92	0 0	0 0	0 0	49 92	0 0	0 0	0 0	49 92		
M <sub>ot</sub> (#-ft) = 7594 14205	0 0								8711 16294	7594 14205	
F (#) = -479 -79	0 0								-615 -216	-479 -79	
Holddown	1000 -	1000 -	1000 -	1000 -	1000 -	1000 -	1000 -	1000 -	1000 -		
	No Holddown OK	No Holddown OK	No Holddown OK	No Holddown OK	No Holddown OK	No Holddown OK	No Holddown OK	No Holddown OK	No Holddown OK		

Actual  
Distribu

3rd Floor: W1	Wind (ASD): 1.719 kips 81 #/ft Seismic (ASD): 6.624 kips 216 #/ft								81 #/ft 216 #/ft		
	use W2				use W2				use W2	9.083 ft	
	17 ft	0 ft	0 ft	0 ft	19.5 ft	0 ft	0 ft	0 ft	17 ft	53.5	
Distribution L	17 ft	0 ft	0 ft	0 ft	19.5 ft	0 ft	0 ft	0 ft	17 ft	53.5	
h/b <sub>s</sub> = 0.534 W1									0.466 W1	0.534 W1	
DL w (plf) = 252.3	0								282.6	252.3	
0.6M <sub>R</sub> (#-ft) = 21870	0								32236	21870	
PLF	W E	W E	W E	W E	W E	W E	W E	W E	W E		
	81 216	0 0	0 0	0 0	81 216	0 0	0 0	0 0	81 216		
M <sub>ot</sub> (#-ft) = 12555 33322	0 0								14402 38223	12555 33322	
F (#) = -1044 615	0 0								-1554 99	-1044 615	
Holddown	2335 S2	1000 -	1000 -	1000 -	2335 S2	1000 -	1000 -	1000 -	2335 S2		
	MST48 OK	No Holddown OK	No Holddown OK	No Holddown OK	MST48 OK	No Holddown OK	No Holddown OK	No Holddown OK	MST48 OK		

Actual  
Distribu

2nd Floor W2	Wind (ASD): 1.705 kips 113 #/ft Seismic (ASD): 3.909 kips 289 #/ft								113 #/ft 289 #/ft		
	use W3				use W3				use W3	9.083 ft	
	17 ft	0 ft	0 ft	0 ft	19.5 ft	0 ft	0 ft	0 ft	17 ft	53.5	
Distribution L	17 ft	0 ft	0 ft	0 ft	19.5 ft	0 ft	0 ft	0 ft	17 ft	53.5	
h/b <sub>s</sub> = 0.534 W2									0.466 W2	0.534 W2	
DL w (plf) = 252.3	0								282.6	252.3	
0.6M <sub>R</sub> (#-ft) = 21870	0								32236	21870	
PLF	W E	W E	W E	W E	W E	W E	W E	W E	W E		
	113 289	0 0	0 0	0 0	113 289	0 0	0 0	0 0	113 289		
M <sub>ot</sub> (#-ft) = 17476 44604	0 0								20046 51164	17476 44604	
F (#) = -1310 1993	0 0								-2195 1095	-1310 1993	
Holddown	4065 H3	6970 H4	1000 -	1000 -	4065 H3	1000 -	1000 -	6970 H4	4065 H3		
	1.05 HDU5 OK	HDU8 OK	No Holddown OK	No Holddown OK	HDU5 OK	No Holddown OK	No Holddown OK	HDU8 OK	HDU5 OK		

Actual  
Distribu

Job # 23.002

Sheet:



Designed: TLC

Date: 5/29/23

Checked:

Date:

**Project:** Bradley Heights - 3 Story & basement Story

Vertical Distribution 1 Bedroom units

$$F_x = C_{vx} V \quad (12.8-11)$$

$$C_{vx} = \frac{w_x h_x^k}{\sum w_i h_i^k}$$

$$T_a = C_t h_n^x = 0.3240544 \quad (12.8-7)$$

$$C_t = 0.02 \quad \text{Table 12.8-2}$$

$$x = 0.75 \quad \text{Table 12.8-2}$$

$$H_n = 41 \text{ ft} \quad \text{Structural Height defined in 11.2}$$

k = 1 if period is .5s or less

k = 2 if period is 2.5s or more

k = 1-2 if between

k = 1

1Bx1	→	$w_x$	$h_x$	$w_x h_x^k$	$C_{vx}$	V	$F_x$
3-story	Roof	25238	29.35417	740835.8	0.343404	2801	4514
	3rd Floor	46586	20.27083	944330.6	0.437731	5171	5753
	2nd Floor	46586	10.13542	472165.3	0.218865	5171	2877
			$\Sigma$	2157332		$\Sigma$	13143

1Bx1	↑	$w_x$	$h_x$	$w_x h_x^k$	$C_{vx}$	V	$F_x$
3-story	Roof	24345	29.35417	714626.6	0.344096	2702	4352
	3rd Floor	44800	20.27083	908132.6	0.43727	4973	5531
	2nd Floor	44800	10.13542	454066.3	0.218635	4973	2765
			$\Sigma$	2076825		$\Sigma$	12648

1Bx1	→	$w_x$	$h_x$	$w_x h_x^k$	$C_{vx}$	V	$F_x$
3-story	Roof	25238	39.48958	996631.8	0.260243	2801	4766
+ Basement	3rd Floor	46586	30.40625	1416496	0.369879	5171	6774
	2nd Floor	46586	20.27083	944330.6	0.246586	5171	4516
	1st floor	46586	10.13542	472165.3	0.123293	5171	2258
			$\Sigma$	3829623		$\Sigma$	18314

1Bx1	↑	$w_x$	$h_x$	$w_x h_x^k$	$C_{vx}$	V	$F_x$
3-story	Roof	24345	39.48958	961373.2	0.260834	2702	4596
+ Basement	3rd Floor	44800	30.40625	1362199	0.369583	4973	6512
	2nd Floor	44800	20.27083	908132.6	0.246389	4973	4342
	1st Floor	44800	10.13542	454066.3	0.123194	4973	2171
			$\Sigma$	3685771		$\Sigma$	17621

No Holdow	1000	-	
MST37	1256	S1	MSTC48B3
MST48	2335	S2	MSTC48B3
MST60	3356	S3	MSTC66B3
(2) MST48	4670	S4	S8
(2) MST60	6712	S5	S9
MSTC66B3	3875	S6	
2)MSTC66B	13424	S7	
NA	7750	S8	
NA	26848	S9	

No Holdow	1000	-	
HDU2	2215	H1	
HDU4	3285	H2	
HDU5	4065	H3	
HDU8	6970	H4	
HDU11	9535	H5	
HDU14	14445	H6	
(2) HDU11	19070	H7	
(2) HDU14	28890	H8	