

2nd Floor Framing			
Member Name	Results (Max UTIL %)	Current Solution	Comments
Floor Joist 16' and Under	Passed (96% M)	1 piece(s) 11 7/8" TJI® 110 @ 16" OC	
8'-5" Landing Joists	Passed (90% R)	1 piece(s) 2 x 12 HF No.2 @ 12" OC	
Short Stair Stringers	Passed (72% R)	1 piece(s) 4 x 12 HF No.2	
Long Short Stair Stringers	Passed (98% R)	1 piece(s) 3 1/2" x 12" 24F-V4 DF Glulam	
Top Landing Beam	Passed (100% R)	1 piece(s) 5 1/2" x 13 1/2" 24F-V4 DF Glulam	
8'-10" Deck Joist	Passed (55% R)	1 piece(s) 2 x 12 HF No.2 @ 16" OC	
6' Window Header	Passed (79% M)	1 piece(s) 4 x 10 DF No.2	
Grid 2 (B.6-B.8) Flush Beam	Passed (57% R)	1 piece(s) 3 1/2" x 11 7/8" 24F-V4 DF Glulam	
Grid 12 (B.6-B.8) Flush Beam	Passed (57% R)	1 piece(s) 3 1/2" x 11 7/8" 24F-V4 DF Glulam	
Grid 3.1 (B.6-B.8) Flush Beam	Passed (56% R)	1 piece(s) 3 1/2" x 11 7/8" 24F-V4 DF Glulam	
Grid 10.9 (B.6-B.8) Flush Beam	Passed (56% R)	1 piece(s) 3 1/2" x 11 7/8" 24F-V4 DF Glulam	
Grid 5.2 (B.5-B.7) Flush Beam	Passed (74% R)	1 piece(s) 3 1/2" x 11 7/8" 24F-V4 DF Glulam	
Grid 8.8 (B.5-B.7) Flush Beam	Passed (74% R)	1 piece(s) 3 1/2" x 11 7/8" 24F-V4 DF Glulam	
Grid 5.2 (B.9-C) Bathroom Door Header	Passed (83% M)	1 piece(s) 4 x 8 DF No.2	
Grid 8.8 (B.9-C) Bathroom Door Header	Passed (83% M)	1 piece(s) 4 x 8 DF No.2	
Grid 6.2 (B.4-B.5) Bedroom Door Header	Passed (74% R)	1 piece(s) 4 x 8 DF No.2	
Grid 7.8 (B.4-B.5) Bedroom Door Header	Passed (74% R)	1 piece(s) 4 x 8 DF No.2	
Grid 6.2 (B.7-C) Flush Beam	Passed (63% R)	1 piece(s) 3 1/2" x 11 7/8" 24F-V4 DF Glulam	Squash Blocks Required
Grid 7.8 (B.7-C) Flush Beam	Passed (63% R)	1 piece(s) 3 1/2" x 11 7/8" 24F-V4 DF Glulam	Squash Blocks Required
Grid 2.3 (D-D.1) Bedroom Door Header	Passed (60% R)	1 piece(s) 4 x 8 DF No.2	
Grid 11.7 (D-D.1) Bedroom Door Header	Passed (60% R)	1 piece(s) 4 x 8 DF No.2	
Grid 2.7 (D.2-D.4) Flush Beam	Passed (70% R)	1 piece(s) 3 1/2" x 11 7/8" 24F-V4 DF Glulam	
Grid 11.3 (D.2-D.4) Flush Beam	Passed (70% R)	1 piece(s) 3 1/2" x 11 7/8" 24F-V4 DF Glulam	
Grid 5.6 (D-D.3) Flush Beam	Passed (90% R)	1 piece(s) 3 1/2" x 11 7/8" 24F-V4 DF Glulam	
Grid 8.4 (D-D.3) Flush Beam	Passed (90% R)	1 piece(s) 3 1/2" x 11 7/8" 24F-V4 DF Glulam	
Grid 6 (D.5-D.6) Bedroom Door Header	Passed (83% R)	1 piece(s) 4 x 8 DF No.2	
Main Landing Post	Passed (97% B/C)	1 piece(s) 6 x 10 DF No.2	
Grid 6.2B.6 Post	Passed (80% f _{cp})	1 piece(s) 4 x 6 DF No.2	
Grid 7.8B.6 Post	Passed (80% f _{cp})	1 piece(s) 4 x 6 DF No.2	

ForteWEB Software Operator	Job Notes
Chon Pieruccioni Pieruccioni Engineering (206) 949-7866 cpieru@hotmail.com	



3rd Floor Framing			
Member Name	Results (Max UTIL %)	Current Solution	Comments
Floor Joist 16' and Under	Passed (96% M)	1 piece(s) 11 7/8" TJI® 110 @ 16" OC	
8'-5" Landing Joists	Passed (90% R)	1 piece(s) 2 x 12 HF No.2 @ 12" OC	
Short Stair Stringers	Passed (72% R)	1 piece(s) 4 x 12 HF No.2	
Top Landing Beam	Passed (84% ΔL)	1 piece(s) 5 1/2" x 12" 24F-V4 DF Glulam	
4' Mid Landing Joists	Passed (63% R)	1 piece(s) 2 x 8 HF No.2 @ 16" OC	
Mid Landing Inner Beam	Passed (72% ΔL)	1 piece(s) 5 1/2" x 12" 24F-V4 DF Glulam	
Mid Landing Outer Beam	Passed (83% ΔL)	1 piece(s) 3 1/2" x 10 1/2" 24F-V4 DF Glulam	
8'-10" Deck Joist	Passed (55% R)	1 piece(s) 2 x 12 HF No.2 @ 16" OC	
6' Window Header	Passed (79% M)	1 piece(s) 4 x 10 DF No.2	
Grid 2 (B.6-B.8) Flush Beam	Passed (28% R)	1 piece(s) 3 1/2" x 11 7/8" 24F-V4 DF Glulam	
Grid 12 (B.6-B.8) Flush Beam	Passed (28% R)	1 piece(s) 3 1/2" x 11 7/8" 24F-V4 DF Glulam	
Grid 3.1 (B.6-B.8) Flush Beam	Passed (28% R)	1 piece(s) 3 1/2" x 11 7/8" 24F-V4 DF Glulam	
Grid 10.9 (B.6-B.8) Flush Beam	Passed (28% R)	1 piece(s) 3 1/2" x 11 7/8" 24F-V4 DF Glulam	
Grid 5.2 (B.6-B.8) Flush Beam	Passed (34% R)	1 piece(s) 3 1/2" x 11 7/8" 24F-V4 DF Glulam	
Grid 8.8 (B.6-B.8) Flush Beam	Passed (34% R)	1 piece(s) 3 1/2" x 11 7/8" 24F-V4 DF Glulam	
Grid 5.2 (B.8-B.9) Bathroom Door Header	Passed (33% R)	1 piece(s) 4 x 8 DF No.2	
Grid 8.8 (B.8-B.9) Bathroom Door Header	Passed (33% R)	1 piece(s) 4 x 8 DF No.2	
Grid 6.2 (B.4-B.5) Bedroom Door Header	Passed (37% R)	1 piece(s) 4 x 8 DF No.2	
Grid 7.8 (B.4-B.5) Bedroom Door Header	Passed (37% R)	1 piece(s) 4 x 8 DF No.2	
Grid 6.2 (B.7-C) Flush Beam	Passed (63% R)	1 piece(s) 3 1/2" x 11 7/8" 24F-V4 DF Glulam	
Grid 7.8 (B.7-C) Flush Beam	Passed (63% R)	1 piece(s) 3 1/2" x 11 7/8" 24F-V4 DF Glulam	
Grid 2.3 (D-D.1) Bedroom Door Header	Passed (30% R)	1 piece(s) 4 x 8 DF No.2	
Grid 11.7 (D-D.1) Bedroom Door Header	Passed (30% R)	1 piece(s) 4 x 8 DF No.2	
Grid 2.7 (D.2-D.4) Flush Beam	Passed (35% R)	1 piece(s) 3 1/2" x 11 7/8" 24F-V4 DF Glulam	
Grid 11.3 (D.2-D.4) Flush Beam	Passed (35% R)	1 piece(s) 3 1/2" x 11 7/8" 24F-V4 DF Glulam	
Grid 5.6 (D-D.3) Flush Beam	Passed (62% R)	1 piece(s) 3 1/2" x 11 7/8" 24F-V4 DF Glulam	
Grid 8.4 (D-D.3) Flush Beam	Passed (62% R)	1 piece(s) 3 1/2" x 11 7/8" 24F-V4 DF Glulam	
Grid 6 (D.5-D.6) Bedroom Door Header	Passed (42% R)	1 piece(s) 4 x 8 DF No.2	
Grid 8 (D.5-D.6) Bedroom Door Header	Passed (42% R)	1 piece(s) 4 x 8 DF No.2	
Roof Framing			
Member Name	Results (Max UTIL %)	Current Solution	Comments
Grid D.7 Entry Roof Beam	Passed (102% R)	1 piece(s) 3 1/2" x 10 1/2" 24F-V4 DF Glulam	
Grid A 7'-3" Deck Roof Beam	Passed (77% M+)	1 piece(s) 3 1/2" x 7 1/2" 24F-V4 DF Glulam	
Grid G 9' Deck Roof Beam	Passed (91% M+)	1 piece(s) 3 1/2" x 9" 24F-V4 DF Glulam	
6' Window Header	Passed (90% R)	1 piece(s) 4 x 10 DF No.2	

ForteWEB Software Operator	Job Notes
Chon Pieruccioni Pieruccioni Engineering (206) 949-7866 cpieru@hotmail.com	



2nd Floor Framing, Floor Joist 16' and Under
1 piece(s) 11 7/8" TJI @ 110 @ 16" OC

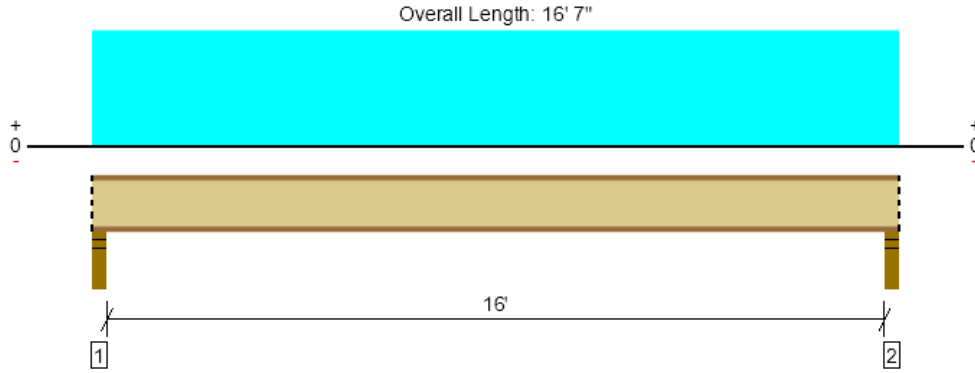

Drawing is Conceptual. All locations are measured from the outside face of left support (or left cantilever end). All dimensions are horizontal.

Design Results	Actual @ Location	Allowed	Result	LDF	Load: Combination (Pattern)
Member Reaction (lbs)	774 @ 2 1/2"	1375 (3.50")	Passed (56%)	1.00	1.0 D + 1.0 L (All Spans)
Shear (lbs)	747 @ 3 1/2"	1560	Passed (48%)	1.00	1.0 D + 1.0 L (All Spans)
Moment (Ft-lbs)	3049 @ 8' 3 1/2"	3160	Passed (96%)	1.00	1.0 D + 1.0 L (All Spans)
Live Load Defl. (in)	0.275 @ 8' 3 1/2"	0.539	Passed (L/704)	--	1.0 D + 1.0 L (All Spans)
Total Load Defl. (in)	0.482 @ 8' 3 1/2"	0.808	Passed (L/403)	--	1.0 D + 1.0 L (All Spans)
TJ-Pro™ Rating	48	40	Passed	--	--

Member Length : 16' 7"
System : Floor
Member Type : Joist
Building Use : Residential
Building Code : IBC 2018
Design Methodology : ASD

- Deflection criteria: LL (L/360) and TL (L/240).
- Allowed moment does not reflect the adjustment for the beam stability factor.
- A structural analysis of the deck has not been performed.
- Deflection analysis is based on composite action with a single layer of 23/32" Weyerhaeuser Edge™ Panel (24" Span Rating) that is glued and nailed down.
- Additional considerations for the TJ-Pro™ Rating include: 5/8" Gypsum ceiling.

Supports	Bearing Length			Loads to Supports (lbs)			Accessories
	Total	Available	Required	Dead	Floor Live	Factored	
1 - Stud wall - HF	3.50"	3.50"	1.75"	332	442	774	Blocking
2 - Stud wall - HF	3.50"	3.50"	1.75"	332	442	774	Blocking

• Blocking Panels are assumed to carry no loads applied directly above them and the full load is applied to the member being designed.

Lateral Bracing	Bracing Intervals	Comments
Top Edge (Lu)	3' 1" o/c	
Bottom Edge (Lu)	16' 7" o/c	

- TJI joists are only analyzed using Maximum Allowable bracing solutions.
- Maximum allowable bracing intervals based on applied load.

Vertical Load	Location	Spacing	Dead (0.90)	Floor Live (1.00)	Comments
1 - Uniform (PSF)	0 to 16' 7"	16"	30.0	40.0	Default Load

Weyerhaeuser Notes

Weyerhaeuser warrants that the sizing of its products will be in accordance with Weyerhaeuser product design criteria and published design values. Weyerhaeuser expressly disclaims any other warranties related to the software. Use of this software is not intended to circumvent the need for a design professional as determined by the authority having jurisdiction. The designer of record, builder or framer is responsible to assure that this calculation is compatible with the overall project. Accessories (Rim Board, Blocking Panels and Squash Blocks) are not designed by this software. Products manufactured at Weyerhaeuser facilities are third-party certified to sustainable forestry standards. Weyerhaeuser Engineered Lumber Products have been evaluated by ICC-ES under evaluation reports ESR-1153 and ESR-1387 and/or tested in accordance with applicable ASTM standards. For current code evaluation reports, Weyerhaeuser product literature and installation details refer to www.weyerhaeuser.com/woodproducts/document-library.

The product application, input design loads, dimensions and support information have been provided by ForteWEB Software Operator

ForteWEB Software Operator	Job Notes
Chon Pieruccioni Pieruccioni Engineering (206) 949-7866 cpieru@hotmail.com	



2nd Floor Framing, 8'-5" Landing Joists
1 piece(s) 2 x 12 HF No.2 @ 12" OC

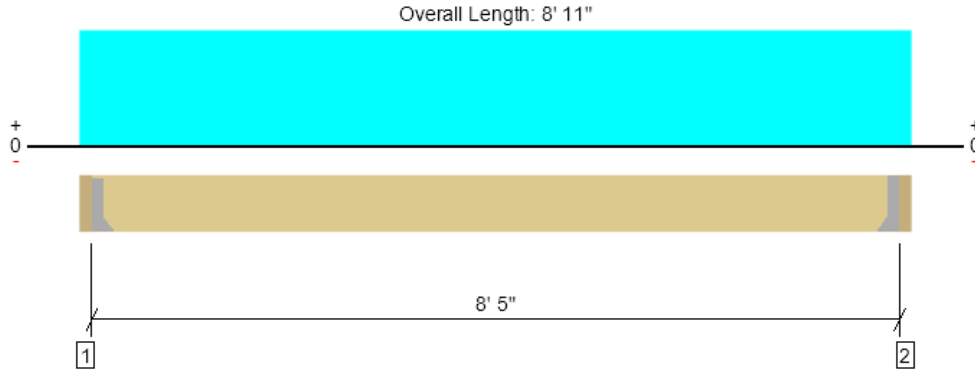

Drawing is Conceptual. All locations are measured from the outside face of left support (or left cantilever end). All dimensions are horizontal.

Design Results	Actual @ Location	Allowed	Result	LDf	Load: Combination (Pattern)
Member Reaction (lbs)	821 @ 3"	911 (1.50")	Passed (90%)	--	1.0 D + 1.0 L (All Spans)
Shear (lbs)	638 @ 1' 2 1/4"	1688	Passed (38%)	1.00	1.0 D + 1.0 L (All Spans)
Moment (Ft-lbs)	1727 @ 4' 5 1/2"	2577	Passed (67%)	1.00	1.0 D + 1.0 L (All Spans)
Live Load Defl. (in)	0.073 @ 4' 5 1/2"	0.281	Passed (L/999+)	--	1.0 D + 1.0 L (All Spans)
Total Load Defl. (in)	0.095 @ 4' 5 1/2"	0.421	Passed (L/999+)	--	1.0 D + 1.0 L (All Spans)
TJ-Pro™ Rating	N/A	N/A	N/A	--	N/A

Member Length : 8' 5"
System : Floor
Member Type : Joist
Building Use : Residential
Building Code : IBC 2018
Design Methodology : ASD

- Deflection criteria: LL (L/360) and TL (L/240).
- Allowed moment does not reflect the adjustment for the beam stability factor.
- A 15% increase in the moment capacity has been added to account for repetitive member usage.
- Applicable calculations are based on NDS.
- No composite action between deck and joist was considered in analysis.

Supports	Bearing Length			Loads to Supports (lbs)			Accessories
	Total	Available	Required	Dead	Floor Live	Factored	
1 - Hanger on 11 1/4" LSL beam	3.00"	Hanger ¹	1.50"	201	669	869	See note ¹
2 - Hanger on 11 1/4" LSL beam	3.00"	Hanger ¹	1.50"	201	669	869	See note ¹

- At hanger supports, the Total Bearing dimension is equal to the width of the material that is supporting the hanger
- ¹ See Connector grid below for additional information and/or requirements.

Lateral Bracing	Bracing Intervals	Comments
Top Edge (Lu)	6' 4" o/c	
Bottom Edge (Lu)	8' 5" o/c	

- Maximum allowable bracing intervals based on applied load.

Connector: Simpson Strong-Tie							
Support	Model	Seat Length	Top Fasteners	Face Fasteners	Member Fasteners	Accessories	
1 - Face Mount Hanger	LUS28	1.75"	N/A	6-10dx1.5	3-10d		
2 - Face Mount Hanger	LUS28	1.75"	N/A	6-10dx1.5	3-10d		

- Refer to manufacturer notes and instructions for proper installation and use of all connectors.

Vertical Load	Location (Side)	Spacing	Dead (0.90)	Floor Live (1.00)	Comments
1 - Uniform (PSF)	0 to 8' 11"	12"	45.0	150.0	Default Load

Weyerhaeuser Notes
Weyerhaeuser warrants that the sizing of its products will be in accordance with Weyerhaeuser product design criteria and published design values. Weyerhaeuser expressly disclaims any other warranties related to the software. Use of this software is not intended to circumvent the need for a design professional as determined by the authority having jurisdiction. The designer of record, builder or framer is responsible to assure that this calculation is compatible with the overall project. Accessories (Rim Board, Blocking Panels and Squash Blocks) are not designed by this software. Products manufactured at Weyerhaeuser facilities are third-party certified to sustainable forestry standards. Weyerhaeuser Engineered Lumber Products have been evaluated by ICC-ES under evaluation reports ESR-1153 and ESR-1387 and/or tested in accordance with applicable ASTM standards. For current code evaluation reports, Weyerhaeuser product literature and installation details refer to www.woyehaeuser.com/woodproducts/document-library.
The product application, input design loads, dimensions and support information have been provided by ForteWEB Software Operator

ForteWEB Software Operator	Job Notes
Chon Pieruccini Pieruccini Engineering (206) 949-7866 cpieru@hotmail.com	



2nd Floor Framing, Short Stair Stringers
1 piece(s) 4 x 12 HF No.2

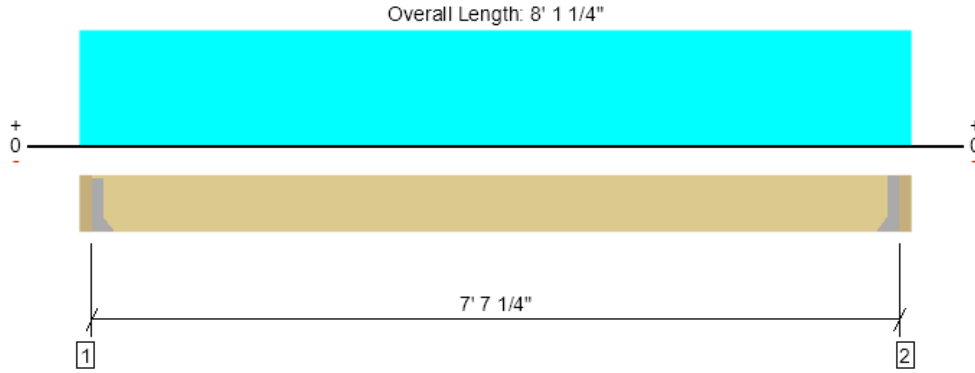

Drawing is Conceptual. All locations are measured from the outside face of left support (or left cantilever end). All dimensions are horizontal.

Design Results	Actual @ Location	Allowed	Result	LDF	Load: Combination (Pattern)
Member Reaction (lbs)	1521 @ 3"	2126 (1.50")	Passed (72%)	--	1.0 D + 1.0 L (All Spans)
Shear (lbs)	1146 @ 1' 2 1/4"	3938	Passed (29%)	1.00	1.0 D + 1.0 L (All Spans)
Moment (Ft-lbs)	2891 @ 4' 5/8"	5752	Passed (50%)	1.00	1.0 D + 1.0 L (All Spans)
Live Load Defl. (in)	0.042 @ 4' 5/8"	0.190	Passed (L/999+)	--	1.0 D + 1.0 L (All Spans)
Total Load Defl. (in)	0.056 @ 4' 5/8"	0.380	Passed (L/999+)	--	1.0 D + 1.0 L (All Spans)

Member Length : 7' 7 1/4"
System : Floor
Member Type : Flush Beam
Building Use : Residential
Building Code : IBC 2018
Design Methodology : ASD

- Deflection criteria: LL (L/480) and TL (L/240).
- Allowed moment does not reflect the adjustment for the beam stability factor.
- Applicable calculations are based on NDS.

Supports	Bearing Length			Loads to Supports (lbs)			Accessories
	Total	Available	Required	Dead	Floor Live	Factored	
1 - Hanger on 11 1/4" GLB beam	3.00"	Hanger ¹	1.50"	403	1216	1618	See note ¹
2 - Hanger on 11 1/4" GLB beam	3.00"	Hanger ¹	1.50"	403	1216	1618	See note ¹

- At hanger supports, the Total Bearing dimension is equal to the width of the material that is supporting the hanger
- ¹ See Connector grid below for additional information and/or requirements.

Lateral Bracing	Bracing Intervals	Comments
Top Edge (Lu)	7' 7" o/c	
Bottom Edge (Lu)	7' 7" o/c	

•Maximum allowable bracing intervals based on applied load.

Connector: Simpson Strong-Tie							
Support	Model	Seat Length	Top Fasteners	Face Fasteners	Member Fasteners	Accessories	
1 - Face Mount Hanger	LUS410	2.00"	N/A	8-16d	6-16d		
2 - Face Mount Hanger	LUS410	2.00"	N/A	8-16d	6-16d		

- Refer to manufacturer notes and instructions for proper installation and use of all connectors.

Vertical Loads	Location (Side)	Tributary Width	Dead (0.90)	Floor Live (1.00)	Comments
0 - Self Weight (PLF)	3" to 7' 10 1/4"	N/A	10.0	--	
1 - Uniform (PSF)	0 to 8' 1 1/4" (Front)	2'	45.0	150.0	Default Load

Weyerhaeuser Notes
Weyerhaeuser warrants that the sizing of its products will be in accordance with Weyerhaeuser product design criteria and published design values. Weyerhaeuser expressly disclaims any other warranties related to the software. Use of this software is not intended to circumvent the need for a design professional as determined by the authority having jurisdiction. The designer of record, builder or framer is responsible to assure that this calculation is compatible with the overall project. Accessories (Rim Board, Blocking Panels and Squash Blocks) are not designed by this software. Products manufactured at Weyerhaeuser facilities are third-party certified to sustainable forestry standards. Weyerhaeuser Engineered Lumber Products have been evaluated by ICC-ES under evaluation reports ESR-1153 and ESR-1387 and/or tested in accordance with applicable ASTM standards. For current code evaluation reports, Weyerhaeuser product literature and installation details refer to www.weyerhaeuser.com/woodproducts/document-library.
The product application, input design loads, dimensions and support information have been provided by ForteWEB Software Operator

ForteWEB Software Operator	Job Notes
Chon Pieruccioni Pieruccioni Engineering (206) 949-7866 cpieru@hotmail.com	



2nd Floor Framing, Long Short Stair Stringers
1 piece(s) 3 1/2" x 12" 24F-V4 DF Glulam

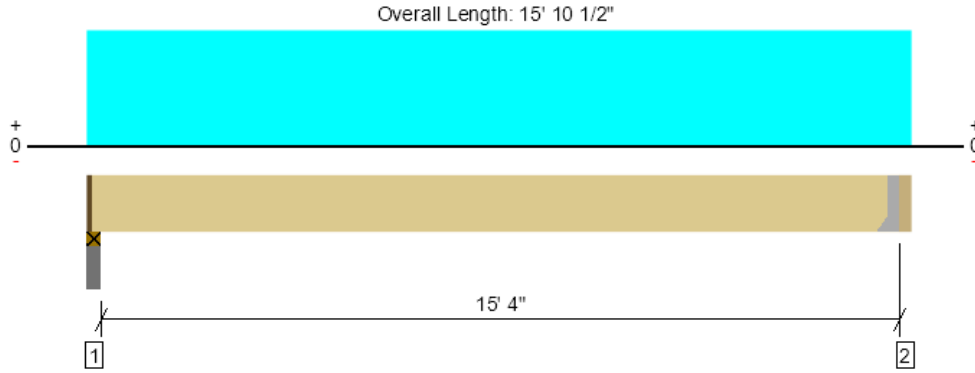

Drawing is Conceptual. All locations are measured from the outside face of left support (or left cantilever end). All dimensions are horizontal.

Design Results	Actual @ Location	Allowed	Result	LDF	Load: Combination (Pattern)
Member Reaction (lbs)	3118 @ 2"	3189 (2.25")	Passed (98%)	--	1.0 D + 1.0 L (All Spans)
Shear (lbs)	2693 @ 14' 7 1/2"	7420	Passed (36%)	1.00	1.0 D + 1.0 L (All Spans)
Pos Moment (Ft-lbs)	11954 @ 7' 10 3/4"	16800	Passed (71%)	1.00	1.0 D + 1.0 L (All Spans)
Live Load Defl. (in)	0.425 @ 7' 10 3/4"	0.515	Passed (L/437)	--	1.0 D + 1.0 L (All Spans)
Total Load Defl. (in)	0.567 @ 7' 10 3/4"	0.773	Passed (L/327)	--	1.0 D + 1.0 L (All Spans)

Member Length : 15' 6 1/4"
System : Floor
Member Type : Flush Beam
Building Use : Residential
Building Code : IBC 2018
Design Methodology : ASD

- Deflection criteria: LL (L/360) and TL (L/240).
- Allowed moment does not reflect the adjustment for the beam stability factor.
- Critical positive moment adjusted by a volume/size factor of 1.00 that was calculated using length L = 15' 5 1/2".
- The effects of positive or negative camber have not been accounted for when calculating deflection.
- The specified glulam is assumed to have its strong laminations at the bottom of the beam. Install with proper side up as indicated by the manufacturer.
- Applicable calculations are based on NDS.

Supports	Bearing Length			Loads to Supports (lbs)			Accessories
	Total	Available	Required	Dead	Floor Live	Factored	
1 - Plate on concrete - HF	3.50"	2.25"	2.20"	790	2369	3159	1 1/4" Rim Board
2 - Hanger on 12" GLB beam	3.00"	Hanger ¹	1.50"	797	2394	3191	See note ¹

- Rim Board is assumed to carry all loads applied directly above it, bypassing the member being designed.
- At hanger supports, the Total Bearing dimension is equal to the width of the material that is supporting the hanger
- ¹ See Connector grid below for additional information and/or requirements.

Lateral Bracing	Bracing Intervals	Comments
Top Edge (Lu)	15' 6" o/c	
Bottom Edge (Lu)	15' 6" o/c	

- Maximum allowable bracing intervals based on applied load.

Connector: Simpson Strong-Tie							
Support	Model	Seat Length	Top Fasteners	Face Fasteners	Member Fasteners	Accessories	
2 - Face Mount Hanger	HHUS410	3.00"	N/A	30-10d	10-10d		

- Refer to manufacturer notes and instructions for proper installation and use of all connectors.

Vertical Loads	Location (Side)	Tributary Width	Dead (0.90)	Floor Live (1.00)	Comments
0 - Self Weight (PLF)	1 1/4" to 15' 7 1/2"	N/A	10.2	--	
1 - Uniform (PSF)	0 to 15' 10 1/2" (Front)	2'	45.0	150.0	Default Load

Weyerhaeuser Notes

Weyerhaeuser warrants that the sizing of its products will be in accordance with Weyerhaeuser product design criteria and published design values. Weyerhaeuser expressly disclaims any other warranties related to the software. Use of this software is not intended to circumvent the need for a design professional as determined by the authority having jurisdiction. The designer of record, builder or framer is responsible to assure that this calculation is compatible with the overall project. Accessories (Rim Board, Blocking Panels and Squash Blocks) are not designed by this software. Products manufactured at Weyerhaeuser facilities are third-party certified to sustainable forestry standards. Weyerhaeuser Engineered Lumber Products have been evaluated by ICC-ES under evaluation reports ESR-1153 and ESR-1387 and/or tested in accordance with applicable ASTM standards. For current code evaluation reports, Weyerhaeuser product literature and installation details refer to www.weyerhaeuser.com/woodproducts/document-library.

The product application, input design loads, dimensions and support information have been provided by ForteWEB Software Operator

ForteWEB Software Operator	Job Notes
Chon Pieruccioni Pieruccioni Engineering (206) 949-7866 cpieru@hotmail.com	



2nd Floor Framing, Top Landing Beam
1 piece(s) 5 1/2" x 13 1/2" 24F-V4 DF Glulam

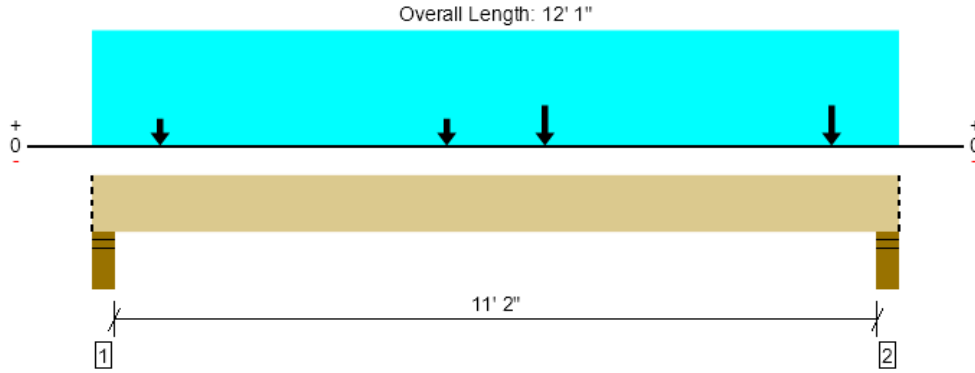

Drawing is Conceptual. All locations are measured from the outside face of left support (or left cantilever end). All dimensions are horizontal.

Design Results	Actual @ Location	Allowed	Result	LDF	Load: Combination (Pattern)
Member Reaction (lbs)	12196 @ 11' 9"	12251 (5.50")	Passed (100%)	--	1.0 D + 1.0 L (All Spans)
Shear (lbs)	8941 @ 10' 6"	13118	Passed (68%)	1.00	1.0 D + 1.0 L (All Spans)
Pos Moment (Ft-lbs)	31638 @ 6' 9"	33413	Passed (95%)	1.00	1.0 D + 1.0 L (All Spans)
Live Load Defl. (in)	0.265 @ 6' 1"	0.285	Passed (L/516)	--	1.0 D + 1.0 L (All Spans)
Total Load Defl. (in)	0.352 @ 6' 1 1/16"	0.571	Passed (L/389)	--	1.0 D + 1.0 L (All Spans)

Member Length : 12' 1"
System : Floor
Member Type : Flush Beam
Building Use : Residential
Building Code : IBC 2018
Design Methodology : ASD

- Deflection criteria: LL (L/480) and TL (L/240).
- Allowed moment does not reflect the adjustment for the beam stability factor.
- Critical positive moment adjusted by a volume/size factor of 1.00 that was calculated using length L = 11' 5".
- The effects of positive or negative camber have not been accounted for when calculating deflection.
- The specified glulam is assumed to have its strong laminations at the bottom of the beam. Install with proper side up as indicated by the manufacturer.
- Applicable calculations are based on NDS.

Supports	Bearing Length			Loads to Supports (lbs)			Accessories
	Total	Available	Required	Dead	Floor Live	Factored	
1 - Stud wall - HF	5.50"	5.50"	4.76"	2604	7997	10601	Blocking
2 - Stud wall - HF	5.50"	5.50"	5.48"	3004	9192	12196	Blocking

• Blocking Panels are assumed to carry no loads applied directly above them and the full load is applied to the member being designed.

Lateral Bracing	Bracing Intervals	Comments
Top Edge (Lu)	12' 1" o/c	
Bottom Edge (Lu)	12' 1" o/c	

•Maximum allowable bracing intervals based on applied load.

Vertical Loads	Location (Side)	Tributary Width	Dead (0.90)	Floor Live (1.00)	Comments
0 - Self Weight (PLF)	0 to 12' 1"	N/A	18.0	--	
1 - Uniform (PSF)	0 to 12' 1" (Front)	5' 6"	45.0	150.0	Default Load
2 - Point (lb)	5' 3 3/4" (Front)	N/A	403	1216	Linked from: Short Stair Stringers, Support 1
3 - Point (lb)	1' 1/4" (Front)	N/A	403	1216	Linked from: Short Stair Stringers, Support 1
4 - Point (lb)	6' 9 3/8" (Front)	N/A	797	2394	Linked from: Long Short Stair Stringers, Support 2
5 - Point (lb)	11' 7/8" (Front)	N/A	797	2394	Linked from: Long Short Stair Stringers, Support 2

ForteWEB Software Operator	Job Notes
Chon Pieruccioni Pieruccioni Engineering (206) 949-7866 cpieru@hotmail.com	



Weyerhaeuser Notes

Weyerhaeuser warrants that the sizing of its products will be in accordance with Weyerhaeuser product design criteria and published design values. Weyerhaeuser expressly disclaims any other warranties related to the software. Use of this software is not intended to circumvent the need for a design professional as determined by the authority having jurisdiction. The designer of record, builder or framer is responsible to assure that this calculation is compatible with the overall project. Accessories (Rim Board, Blocking Panels and Squash Blocks) are not designed by this software. Products manufactured at Weyerhaeuser facilities are third-party certified to sustainable forestry standards. Weyerhaeuser Engineered Lumber Products have been evaluated by ICC-ES under evaluation reports ESR-1153 and ESR-1387 and/or tested in accordance with applicable ASTM standards. For current code evaluation reports, Weyerhaeuser product literature and installation details refer to www.weyerhaeuser.com/woodproducts/document-library.

The product application, input design loads, dimensions and support information have been provided by ForteWEB Software Operator

ForteWEB Software Operator	Job Notes
Chon Pieruccioni Pieruccioni Engineering (206) 949-7866 cpieru@hotmail.com	



2nd Floor Framing, 8'-10" Deck Joist
1 piece(s) 2 x 12 HF No.2 @ 16" OC

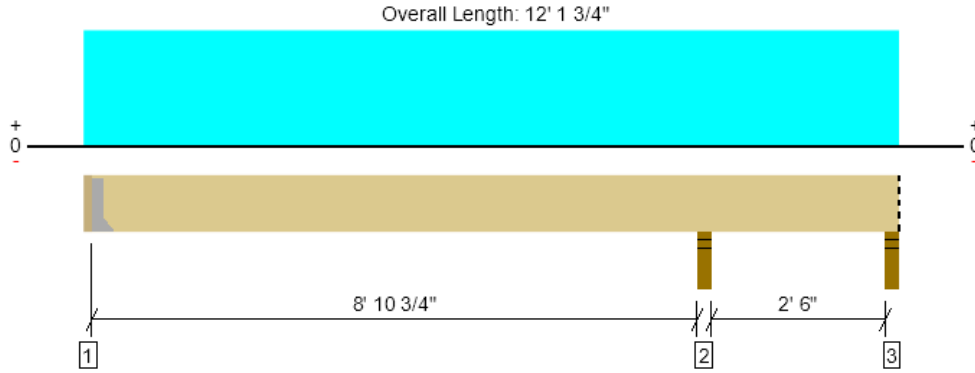

Drawing is Conceptual. All locations are measured from the outside face of left support (or left cantilever end). All dimensions are horizontal.

Design Results	Actual @ Location	Allowed	Result	LDF	Load: Combination (Pattern)
Member Reaction (lbs)	1168 @ 9' 2 1/2"	2126 (3.50")	Passed (55%)	--	1.0 D + 1.0 L (All Spans)
Shear (lbs)	520 @ 8' 1 1/2"	1688	Passed (31%)	1.00	1.0 D + 1.0 L (All Spans)
Moment (Ft-lbs)	-968 @ 9' 2 1/2"	2577	Passed (38%)	1.00	1.0 D + 1.0 L (All Spans)
Live Load Defl. (in)	0.028 @ 4' 2 7/8"	0.301	Passed (L/999+)	--	1.0 D + 1.0 L (All Spans)
Total Load Defl. (in)	0.042 @ 4' 2 3/4"	0.452	Passed (L/999+)	--	1.0 D + 1.0 L (All Spans)
TJ-Pro™ Rating	N/A	N/A	N/A	--	N/A

Member Length : 11' 11 3/4"
System : Floor
Member Type : Joist
Building Use : Residential
Building Code : IBC 2018
Design Methodology : ASD

- Deflection criteria: LL (L/360) and TL (L/240).
- Allowed moment does not reflect the adjustment for the beam stability factor.
- A 15% increase in the moment capacity has been added to account for repetitive member usage.
- -285 lbs uplift at support located at 11' 11 1/4". Strapping or other restraint may be required.
- Applicable calculations are based on NDS.
- No composite action between deck and joist was considered in analysis.

Supports	Bearing Length			Loads to Supports (lbs)			Accessories
	Total	Available	Required	Dead	Floor Live	Factored	
1 - Hanger on 11 1/4" HF beam	2.00"	Hanger ¹	1.50"	152	306	457	See note ¹
2 - Stud wall - HF	3.50"	3.50"	1.92"	389	779	1168	None
3 - Stud wall - HF	3.50"	3.50"	1.50"	-55	120/-230	64/-285	Blocking

- Blocking Panels are assumed to carry no loads applied directly above them and the full load is applied to the member being designed.
- At hanger supports, the Total Bearing dimension is equal to the width of the material that is supporting the hanger
- ¹ See Connector grid below for additional information and/or requirements.

Lateral Bracing	Bracing Intervals	Comments
Top Edge (Lu)	12' o/c	
Bottom Edge (Lu)	12' o/c	

•Maximum allowable bracing intervals based on applied load.

Connector: Simpson Strong-Tie

Support	Model	Seat Length	Top Fasteners	Face Fasteners	Member Fasteners	Accessories
1 - Face Mount Hanger	LUS28	1.75"	N/A	6-10dx1.5	3-10d	

- Refer to manufacturer notes and instructions for proper installation and use of all connectors.

Vertical Load	Location (Side)	Spacing	Dead (0.90)	Floor Live (1.00)	Comments
1 - Uniform (PSF)	0 to 12' 1 3/4"	16"	30.0	60.0	Default Load

Weyerhaeuser Notes

Weyerhaeuser warrants that the sizing of its products will be in accordance with Weyerhaeuser product design criteria and published design values. Weyerhaeuser expressly disclaims any other warranties related to the software. Use of this software is not intended to circumvent the need for a design professional as determined by the authority having jurisdiction. The designer of record, builder or framer is responsible to assure that this calculation is compatible with the overall project. Accessories (Rim Board, Blocking Panels and Squash Blocks) are not designed by this software. Products manufactured at Weyerhaeuser facilities are third-party certified to sustainable forestry standards. Weyerhaeuser Engineered Lumber Products have been evaluated by ICC-ES under evaluation reports ESR-1153 and ESR-1387 and/or tested in accordance with applicable ASTM standards. For current code evaluation reports, Weyerhaeuser product literature and installation details refer to www.woyehaeuser.com/woodproducts/document-library.

The product application, input design loads, dimensions and support information have been provided by ForteWEB Software Operator

ForteWEB Software Operator	Job Notes
Chon Pieruccioni Pieruccioni Engineering (206) 949-7866 cpieru@hotmail.com	



2nd Floor Framing, 6' Window Header
1 piece(s) 4 x 10 DF No.2

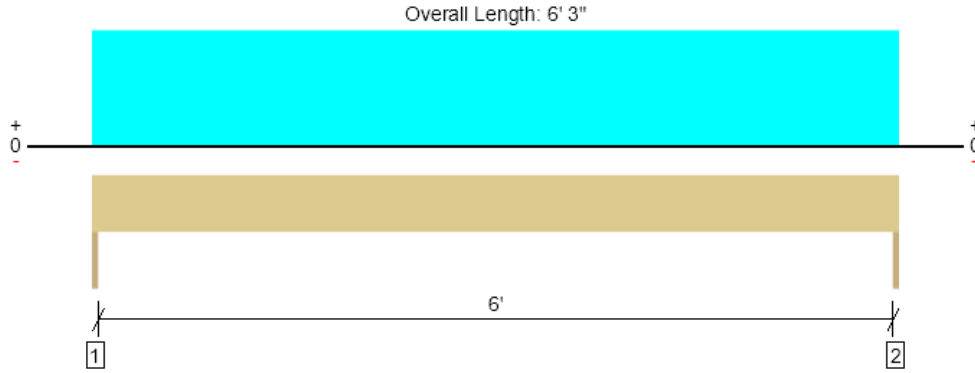

Drawing is Conceptual. All locations are measured from the outside face of left support (or left cantilever end). All dimensions are horizontal.

Design Results	Actual @ Location	Allowed	Result	LDF	Load: Combination (Pattern)
Member Reaction (lbs)	2272 @ 0	3281 (1.50")	Passed (69%)	--	1.0 D + 1.0 L (All Spans)
Shear (lbs)	1621 @ 10 3/4"	3885	Passed (42%)	1.00	1.0 D + 1.0 L (All Spans)
Moment (Ft-lbs)	3550 @ 3' 1 1/2"	4492	Passed (79%)	1.00	1.0 D + 1.0 L (All Spans)
Live Load Defl. (in)	0.031 @ 3' 1 1/2"	0.208	Passed (L/999+)	--	1.0 D + 1.0 L (All Spans)
Total Load Defl. (in)	0.068 @ 3' 1 1/2"	0.313	Passed (L/999+)	--	1.0 D + 1.0 L (All Spans)

Member Length : 6' 3"
System : Wall
Member Type : Header
Building Use : Residential
Building Code : IBC 2018
Design Methodology : ASD

- Deflection criteria: LL (L/360) and TL (L/240).
- Allowed moment does not reflect the adjustment for the beam stability factor.
- Applicable calculations are based on NDS.

Supports	Bearing Length			Loads to Supports (lbs)			Accessories
	Total	Available	Required	Dead	Floor Live	Factored	
1 - Trimmer - HF	1.50"	1.50"	1.50"	1215	1057	2272	None
2 - Trimmer - HF	1.50"	1.50"	1.50"	1215	1057	2272	None

Lateral Bracing	Bracing Intervals	Comments
Top Edge (Lu)	6' 3" o/c	
Bottom Edge (Lu)	6' 3" o/c	

•Maximum allowable bracing intervals based on applied load.

Vertical Loads	Location	Tributary Width	Dead (0.90)	Floor Live (1.00)	Comments
0 - Self Weight (PLF)	0 to 6' 3"	N/A	8.2	--	
1 - Uniform (PSF)	0 to 6' 3"	6' 7"	30.0	40.0	Floor
2 - Uniform (PLF)	0 to 6' 3"	N/A	108.0	-	Wall
3 - Uniform (PSF)	0 to 6' 3"	3'	25.0	25.0	Roof

Weyerhaeuser Notes

Weyerhaeuser warrants that the sizing of its products will be in accordance with Weyerhaeuser product design criteria and published design values. Weyerhaeuser expressly disclaims any other warranties related to the software. Use of this software is not intended to circumvent the need for a design professional as determined by the authority having jurisdiction. The designer of record, builder or framer is responsible to assure that this calculation is compatible with the overall project. Accessories (Rim Board, Blocking Panels and Squash Blocks) are not designed by this software. Products manufactured at Weyerhaeuser facilities are third-party certified to sustainable forestry standards. Weyerhaeuser Engineered Lumber Products have been evaluated by ICC-ES under evaluation reports ESR-1153 and ESR-1387 and/or tested in accordance with applicable ASTM standards. For current code evaluation reports, Weyerhaeuser product literature and installation details refer to www.weyerhaeuser.com/woodproducts/document-library.

The product application, input design loads, dimensions and support information have been provided by ForteWEB Software Operator

ForteWEB Software Operator	Job Notes
Chon Pieruccioni Pieruccioni Engineering (206) 949-7866 cpieru@hotmail.com	



2nd Floor Framing, Grid 2 (B.6-B.8) Flush Beam
1 piece(s) 3 1/2" x 11 7/8" 24F-V4 DF Glulam

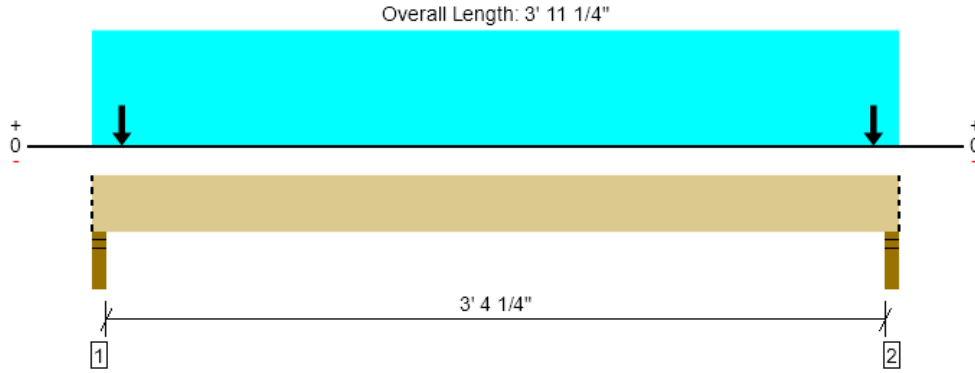

Drawing is Conceptual. All locations are measured from the outside face of left support (or left cantilever end). All dimensions are horizontal.

Design Results	Actual @ Location	Allowed	Result	LDF	Load: Combination (Pattern)
Member Reaction (lbs)	2818 @ 2"	4961 (3.50")	Passed (57%)	--	1.0 D + 1.0 L (All Spans)
Shear (lbs)	492 @ 1' 3 3/8"	7343	Passed (7%)	1.00	1.0 D + 1.0 L (All Spans)
Pos Moment (Ft-lbs)	1163 @ 1' 11 5/8"	16452	Passed (7%)	1.00	1.0 D + 1.0 L (All Spans)
Live Load Defl. (in)	0.002 @ 1' 11 5/8"	0.090	Passed (L/999+)	--	1.0 D + 1.0 L (All Spans)
Total Load Defl. (in)	0.003 @ 1' 11 5/8"	0.180	Passed (L/999+)	--	1.0 D + 1.0 L (All Spans)

Member Length : 3' 11 1/4"
System : Floor
Member Type : Flush Beam
Building Use : Residential
Building Code : IBC 2018
Design Methodology : ASD

- Deflection criteria: LL (L/480) and TL (L/240).
- Allowed moment does not reflect the adjustment for the beam stability factor.
- Critical positive moment adjusted by a volume/size factor of 1.00 that was calculated using length L = 3' 7 1/4".
- The effects of positive or negative camber have not been accounted for when calculating deflection.
- The specified glulam is assumed to have its strong laminations at the bottom of the beam. Install with proper side up as indicated by the manufacturer.
- Applicable calculations are based on NDS.

Supports	Bearing Length			Loads to Supports (lbs)			Accessories
	Total	Available	Required	Dead	Floor Live	Factored	
1 - Stud wall - HF	3.50"	3.50"	1.99"	1230	1588	2818	Blocking
2 - Stud wall - HF	3.50"	3.50"	1.99"	1230	1588	2818	Blocking

• Blocking Panels are assumed to carry no loads applied directly above them and the full load is applied to the member being designed.

Lateral Bracing	Bracing Intervals	Comments
Top Edge (Lu)	3' 11" o/c	
Bottom Edge (Lu)	3' 11" o/c	

•Maximum allowable bracing intervals based on applied load.

Vertical Loads	Location (Side)	Tributary Width	Dead (0.90)	Floor Live (1.00)	Comments
0 - Self Weight (PLF)	0 to 3' 11 1/4"	N/A	10.1	--	
1 - Uniform (PSF)	0 to 3' 11 1/4" (Front)	10' 1"	30.0	40.0	Default Load
2 - Point (lb)	1 3/4" (Top)	N/A	615	794	Linked from: Grid 2 (B.6-B.8) Flush Beam, Support 1
3 - Point (lb)	3' 9 3/4" (Top)	N/A	615	794	Linked from: Grid 2 (B.6-B.8) Flush Beam, Support 2

Weyerhaeuser Notes

Weyerhaeuser warrants that the sizing of its products will be in accordance with Weyerhaeuser product design criteria and published design values. Weyerhaeuser expressly disclaims any other warranties related to the software. Use of this software is not intended to circumvent the need for a design professional as determined by the authority having jurisdiction. The designer of record, builder or framer is responsible to assure that this calculation is compatible with the overall project. Accessories (Rim Board, Blocking Panels and Squash Blocks) are not designed by this software. Products manufactured at Weyerhaeuser facilities are third-party certified to sustainable forestry standards. Weyerhaeuser Engineered Lumber Products have been evaluated by ICC-ES under evaluation reports ESR-1153 and ESR-1387 and/or tested in accordance with applicable ASTM standards. For current code evaluation reports, Weyerhaeuser product literature and installation details refer to www.woyehaeuser.com/woodproducts/document-library.

The product application, input design loads, dimensions and support information have been provided by ForteWEB Software Operator

ForteWEB Software Operator	Job Notes
Chon Pieruccioni Pieruccioni Engineering (206) 949-7866 cpieru@hotmail.com	



2nd Floor Framing, Grid 12 (B.6-B.8) Flush Beam
1 piece(s) 3 1/2" x 11 7/8" 24F-V4 DF Glulam

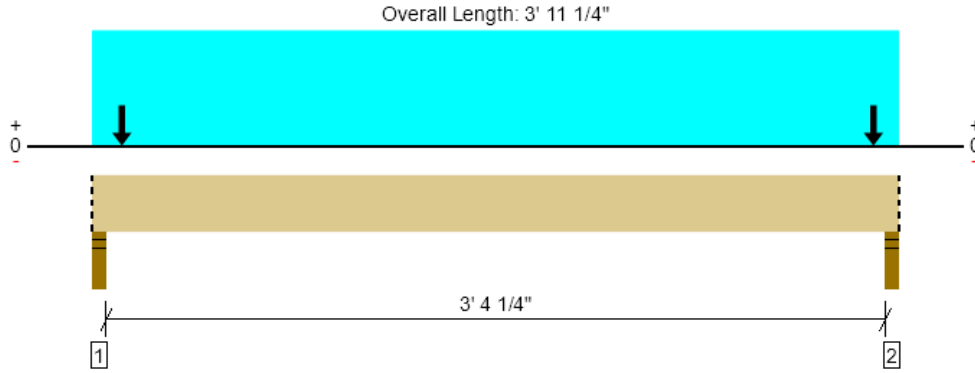

Drawing is Conceptual. All locations are measured from the outside face of left support (or left cantilever end). All dimensions are horizontal.

Design Results	Actual @ Location	Allowed	Result	LDF	Load: Combination (Pattern)
Member Reaction (lbs)	2818 @ 2"	4961 (3.50")	Passed (57%)	--	1.0 D + 1.0 L (All Spans)
Shear (lbs)	492 @ 1' 3 3/8"	7343	Passed (7%)	1.00	1.0 D + 1.0 L (All Spans)
Pos Moment (Ft-lbs)	1163 @ 1' 11 5/8"	16452	Passed (7%)	1.00	1.0 D + 1.0 L (All Spans)
Live Load Defl. (in)	0.002 @ 1' 11 5/8"	0.090	Passed (L/999+)	--	1.0 D + 1.0 L (All Spans)
Total Load Defl. (in)	0.003 @ 1' 11 5/8"	0.180	Passed (L/999+)	--	1.0 D + 1.0 L (All Spans)

Member Length : 3' 11 1/4"
System : Floor
Member Type : Flush Beam
Building Use : Residential
Building Code : IBC 2018
Design Methodology : ASD

- Deflection criteria: LL (L/480) and TL (L/240).
- Allowed moment does not reflect the adjustment for the beam stability factor.
- Critical positive moment adjusted by a volume/size factor of 1.00 that was calculated using length L = 3' 7 1/4".
- The effects of positive or negative camber have not been accounted for when calculating deflection.
- The specified glulam is assumed to have its strong laminations at the bottom of the beam. Install with proper side up as indicated by the manufacturer.
- Applicable calculations are based on NDS.

Supports	Bearing Length			Loads to Supports (lbs)			Accessories
	Total	Available	Required	Dead	Floor Live	Factored	
1 - Stud wall - HF	3.50"	3.50"	1.99"	1230	1588	2818	Blocking
2 - Stud wall - HF	3.50"	3.50"	1.99"	1230	1588	2818	Blocking

• Blocking Panels are assumed to carry no loads applied directly above them and the full load is applied to the member being designed.

Lateral Bracing	Bracing Intervals	Comments
Top Edge (Lu)	3' 11" o/c	
Bottom Edge (Lu)	3' 11" o/c	

•Maximum allowable bracing intervals based on applied load.

Vertical Loads	Location (Side)	Tributary Width	Dead (0.90)	Floor Live (1.00)	Comments
0 - Self Weight (PLF)	0 to 3' 11 1/4"	N/A	10.1	--	
1 - Uniform (PSF)	0 to 3' 11 1/4" (Front)	10' 1"	30.0	40.0	Default Load
2 - Point (lb)	1 3/4" (Top)	N/A	615	794	Linked from: Grid 2 (B.6-B.8) Flush Beam, Support 1
3 - Point (lb)	3' 9 3/4" (Top)	N/A	615	794	Linked from: Grid 2 (B.6-B.8) Flush Beam, Support 2

Weyerhaeuser Notes

Weyerhaeuser warrants that the sizing of its products will be in accordance with Weyerhaeuser product design criteria and published design values. Weyerhaeuser expressly disclaims any other warranties related to the software. Use of this software is not intended to circumvent the need for a design professional as determined by the authority having jurisdiction. The designer of record, builder or framer is responsible to assure that this calculation is compatible with the overall project. Accessories (Rim Board, Blocking Panels and Squash Blocks) are not designed by this software. Products manufactured at Weyerhaeuser facilities are third-party certified to sustainable forestry standards. Weyerhaeuser Engineered Lumber Products have been evaluated by ICC-ES under evaluation reports ESR-1153 and ESR-1387 and/or tested in accordance with applicable ASTM standards. For current code evaluation reports, Weyerhaeuser product literature and installation details refer to www.woyerhaeuser.com/woodproducts/document-library.

The product application, input design loads, dimensions and support information have been provided by ForteWEB Software Operator

ForteWEB Software Operator	Job Notes
Chon Pieruccioni Pieruccioni Engineering (206) 949-7866 cpieru@hotmail.com	



2nd Floor Framing, Grid 3.1 (B.6-B.8) Flush Beam
1 piece(s) 3 1/2" x 11 7/8" 24F-V4 DF Glulam

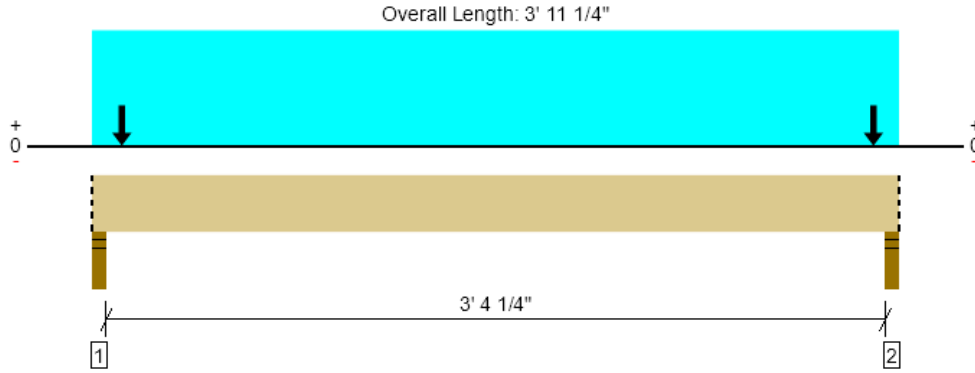

Drawing is Conceptual. All locations are measured from the outside face of left support (or left cantilever end). All dimensions are horizontal.

Design Results	Actual @ Location	Allowed	Result	LDF	Load: Combination (Pattern)
Member Reaction (lbs)	2797 @ 2"	4961 (3.50")	Passed (56%)	--	1.0 D + 1.0 L (All Spans)
Shear (lbs)	488 @ 1' 3 3/8"	7343	Passed (7%)	1.00	1.0 D + 1.0 L (All Spans)
Pos Moment (Ft-lbs)	1153 @ 1' 11 5/8"	16452	Passed (7%)	1.00	1.0 D + 1.0 L (All Spans)
Live Load Defl. (in)	0.002 @ 1' 11 5/8"	0.090	Passed (L/999+)	--	1.0 D + 1.0 L (All Spans)
Total Load Defl. (in)	0.003 @ 1' 11 5/8"	0.180	Passed (L/999+)	--	1.0 D + 1.0 L (All Spans)

Member Length : 3' 11 1/4"
System : Floor
Member Type : Flush Beam
Building Use : Residential
Building Code : IBC 2018
Design Methodology : ASD

- Deflection criteria: LL (L/480) and TL (L/240).
- Allowed moment does not reflect the adjustment for the beam stability factor.
- Critical positive moment adjusted by a volume/size factor of 1.00 that was calculated using length L = 3' 7 1/4".
- The effects of positive or negative camber have not been accounted for when calculating deflection.
- The specified glulam is assumed to have its strong laminations at the bottom of the beam. Install with proper side up as indicated by the manufacturer.
- Applicable calculations are based on NDS.

Supports	Bearing Length			Loads to Supports (lbs)			Accessories
	Total	Available	Required	Dead	Floor Live	Factored	
1 - Stud wall - HF	3.50"	3.50"	1.97"	1222	1576	2797	Blocking
2 - Stud wall - HF	3.50"	3.50"	1.97"	1222	1576	2797	Blocking

• Blocking Panels are assumed to carry no loads applied directly above them and the full load is applied to the member being designed.

Lateral Bracing	Bracing Intervals	Comments
Top Edge (Lu)	3' 11" o/c	
Bottom Edge (Lu)	3' 11" o/c	

•Maximum allowable bracing intervals based on applied load.

Vertical Loads	Location (Side)	Tributary Width	Dead (0.90)	Floor Live (1.00)	Comments
0 - Self Weight (PLF)	0 to 3' 11 1/4"	N/A	10.1	--	
1 - Uniform (PSF)	0 to 3' 11 1/4" (Front)	10'	30.0	40.0	Default Load
2 - Point (lb)	1 3/4" (Top)	N/A	611	788	Linked from: Grid 3.1 (B.6-B.8) Flush Beam, Support 1
3 - Point (lb)	3' 9 3/4" (Top)	N/A	611	788	Linked from: Grid 3.1 (B.6-B.8) Flush Beam, Support 2

Weyerhaeuser Notes

Weyerhaeuser warrants that the sizing of its products will be in accordance with Weyerhaeuser product design criteria and published design values. Weyerhaeuser expressly disclaims any other warranties related to the software. Use of this software is not intended to circumvent the need for a design professional as determined by the authority having jurisdiction. The designer of record, builder or framer is responsible to assure that this calculation is compatible with the overall project. Accessories (Rim Board, Blocking Panels and Squash Blocks) are not designed by this software. Products manufactured at Weyerhaeuser facilities are third-party certified to sustainable forestry standards. Weyerhaeuser Engineered Lumber Products have been evaluated by ICC-ES under evaluation reports ESR-1153 and ESR-1387 and/or tested in accordance with applicable ASTM standards. For current code evaluation reports, Weyerhaeuser product literature and installation details refer to www.eyerhaeuser.com/woodproducts/document-library.

The product application, input design loads, dimensions and support information have been provided by ForteWEB Software Operator

ForteWEB Software Operator	Job Notes
Chon Pieruccioni Pieruccioni Engineering (206) 949-7866 cpieru@hotmail.com	



2nd Floor Framing, Grid 10.9 (B.6-B.8) Flush Beam
1 piece(s) 3 1/2" x 11 7/8" 24F-V4 DF Glulam

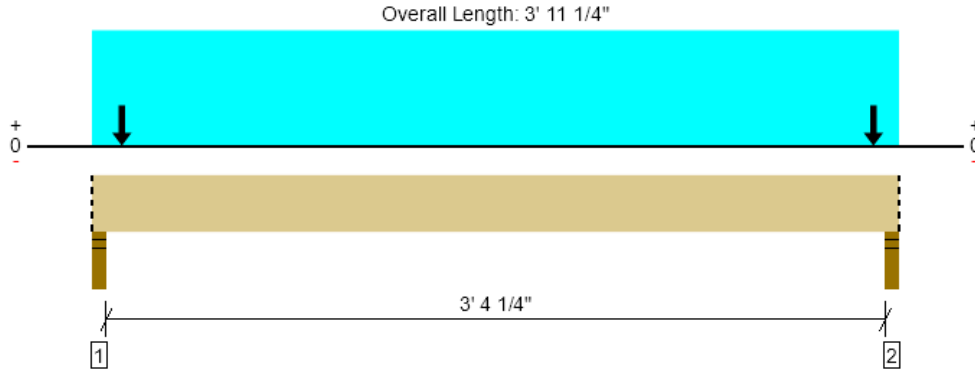

Drawing is Conceptual. All locations are measured from the outside face of left support (or left cantilever end). All dimensions are horizontal.

Design Results	Actual @ Location	Allowed	Result	LDF	Load: Combination (Pattern)
Member Reaction (lbs)	2797 @ 2"	4961 (3.50")	Passed (56%)	--	1.0 D + 1.0 L (All Spans)
Shear (lbs)	488 @ 1' 3 3/8"	7343	Passed (7%)	1.00	1.0 D + 1.0 L (All Spans)
Pos Moment (Ft-lbs)	1153 @ 1' 11 5/8"	16452	Passed (7%)	1.00	1.0 D + 1.0 L (All Spans)
Live Load Defl. (in)	0.002 @ 1' 11 5/8"	0.090	Passed (L/999+)	--	1.0 D + 1.0 L (All Spans)
Total Load Defl. (in)	0.003 @ 1' 11 5/8"	0.180	Passed (L/999+)	--	1.0 D + 1.0 L (All Spans)

Member Length : 3' 11 1/4"
System : Floor
Member Type : Flush Beam
Building Use : Residential
Building Code : IBC 2018
Design Methodology : ASD

- Deflection criteria: LL (L/480) and TL (L/240).
- Allowed moment does not reflect the adjustment for the beam stability factor.
- Critical positive moment adjusted by a volume/size factor of 1.00 that was calculated using length L = 3' 7 1/4".
- The effects of positive or negative camber have not been accounted for when calculating deflection.
- The specified glulam is assumed to have its strong laminations at the bottom of the beam. Install with proper side up as indicated by the manufacturer.
- Applicable calculations are based on NDS.

Supports	Bearing Length			Loads to Supports (lbs)			Accessories
	Total	Available	Required	Dead	Floor Live	Factored	
1 - Stud wall - HF	3.50"	3.50"	1.97"	1222	1576	2797	Blocking
2 - Stud wall - HF	3.50"	3.50"	1.97"	1222	1576	2797	Blocking

• Blocking Panels are assumed to carry no loads applied directly above them and the full load is applied to the member being designed.

Lateral Bracing	Bracing Intervals	Comments
Top Edge (Lu)	3' 11" o/c	
Bottom Edge (Lu)	3' 11" o/c	

•Maximum allowable bracing intervals based on applied load.

Vertical Loads	Location (Side)	Tributary Width	Dead (0.90)	Floor Live (1.00)	Comments
0 - Self Weight (PLF)	0 to 3' 11 1/4"	N/A	10.1	--	
1 - Uniform (PSF)	0 to 3' 11 1/4" (Front)	10'	30.0	40.0	Default Load
2 - Point (lb)	1 3/4" (Top)	N/A	611	788	Linked from: Grid 3.1 (B.6-B.8) Flush Beam, Support 1
3 - Point (lb)	3' 9 3/4" (Top)	N/A	611	788	Linked from: Grid 3.1 (B.6-B.8) Flush Beam, Support 2

Weyerhaeuser Notes

Weyerhaeuser warrants that the sizing of its products will be in accordance with Weyerhaeuser product design criteria and published design values. Weyerhaeuser expressly disclaims any other warranties related to the software. Use of this software is not intended to circumvent the need for a design professional as determined by the authority having jurisdiction. The designer of record, builder or framer is responsible to assure that this calculation is compatible with the overall project. Accessories (Rim Board, Blocking Panels and Squash Blocks) are not designed by this software. Products manufactured at Weyerhaeuser facilities are third-party certified to sustainable forestry standards. Weyerhaeuser Engineered Lumber Products have been evaluated by ICC-ES under evaluation reports ESR-1153 and ESR-1387 and/or tested in accordance with applicable ASTM standards. For current code evaluation reports, Weyerhaeuser product literature and installation details refer to www.weyerhaeuser.com/woodproducts/document-library.

The product application, input design loads, dimensions and support information have been provided by ForteWEB Software Operator

ForteWEB Software Operator	Job Notes
Chon Pieruccioni Pieruccioni Engineering (206) 949-7866 cpieru@hotmail.com	



2nd Floor Framing, Grid 5.2 (B.5-B.7) Flush Beam
 1 piece(s) 3 1/2" x 11 7/8" 24F-V4 DF Glulam

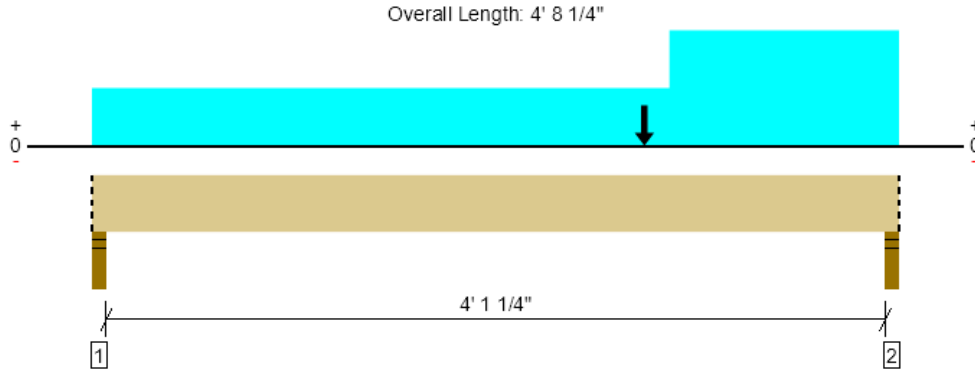

Drawing is Conceptual. All locations are measured from the outside face of left support (or left cantilever end). All dimensions are horizontal.

Design Results	Actual @ Location	Allowed	Result	LDF	Load: Combination (Pattern)
Member Reaction (lbs)	3651 @ 4' 6 1/4"	4961 (3.50")	Passed (74%)	--	1.0 D + 1.0 L (All Spans)
Shear (lbs)	1845 @ 3' 4 7/8"	7343	Passed (25%)	1.00	1.0 D + 1.0 L (All Spans)
Pos Moment (Ft-lbs)	3277 @ 3' 2 7/16"	16452	Passed (20%)	1.00	1.0 D + 1.0 L (All Spans)
Live Load Defl. (in)	0.007 @ 2' 5 1/4"	0.109	Passed (L/999+)	--	1.0 D + 1.0 L (All Spans)
Total Load Defl. (in)	0.012 @ 2' 5 1/4"	0.218	Passed (L/999+)	--	1.0 D + 1.0 L (All Spans)

Member Length : 4' 8 1/4"
 System : Floor
 Member Type : Flush Beam
 Building Use : Residential
 Building Code : IBC 2018
 Design Methodology : ASD

- Deflection criteria: LL (L/480) and TL (L/240).
- Allowed moment does not reflect the adjustment for the beam stability factor.
- Critical positive moment adjusted by a volume/size factor of 1.00 that was calculated using length L = 4' 4 1/4".
- The effects of positive or negative camber have not been accounted for when calculating deflection.
- The specified glulam is assumed to have its strong laminations at the bottom of the beam. Install with proper side up as indicated by the manufacturer.
- Applicable calculations are based on NDS.

Supports	Bearing Length			Loads to Supports (lbs)			Accessories
	Total	Available	Required	Dead	Floor Live	Factored	
1 - Stud wall - HF	3.50"	3.50"	1.61"	993	1283	2276	Blocking
2 - Stud wall - HF	3.50"	3.50"	2.58"	1588	2064	3651	Blocking

- Blocking Panels are assumed to carry no loads applied directly above them and the full load is applied to the member being designed.

Lateral Bracing	Bracing Intervals	Comments
Top Edge (Lu)	4' 8" o/c	
Bottom Edge (Lu)	4' 8" o/c	

- Maximum allowable bracing intervals based on applied load.

Vertical Loads	Location (Side)	Tributary Width	Dead (0.90)	Floor Live (1.00)	Comments
0 - Self Weight (PLF)	0 to 4' 8 1/4"	N/A	10.1	--	
1 - Uniform (PSF)	0 to 4' 8 1/4" (Front)	10'	30.0	40.0	2nd Floor
2 - Uniform (PSF)	3' 4 1/4" to 4' 8 1/4" (Front)	10'	30.0	40.0	3rd Floor
3 - Point (lb)	3' 2 1/2" (Top)	N/A	727	938	Linked from: Grid 5.2 (B.6-B.8) Flush Beam, Support 2

Weyerhaeuser Notes

Weyerhaeuser warrants that the sizing of its products will be in accordance with Weyerhaeuser product design criteria and published design values. Weyerhaeuser expressly disclaims any other warranties related to the software. Use of this software is not intended to circumvent the need for a design professional as determined by the authority having jurisdiction. The designer of record, builder or framer is responsible to assure that this calculation is compatible with the overall project. Accessories (Rim Board, Blocking Panels and Squash Blocks) are not designed by this software. Products manufactured at Weyerhaeuser facilities are third-party certified to sustainable forestry standards. Weyerhaeuser Engineered Lumber Products have been evaluated by ICC-ES under evaluation reports ESR-1153 and ESR-1387 and/or tested in accordance with applicable ASTM standards. For current code evaluation reports, Weyerhaeuser product literature and installation details refer to www.eyerhaeuser.com/woodproducts/document-library.

The product application, input design loads, dimensions and support information have been provided by ForteWEB Software Operator

ForteWEB Software Operator	Job Notes
Chon Pieruccioni Pieruccioni Engineering (206) 949-7866 cpieru@hotmail.com	



2nd Floor Framing, Grid 8.8 (B.5-B.7) Flush Beam
 1 piece(s) 3 1/2" x 11 7/8" 24F-V4 DF Glulam

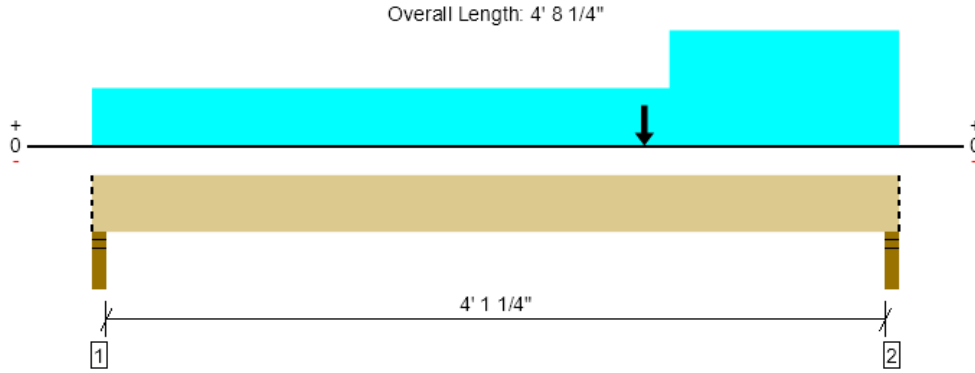

Drawing is Conceptual. All locations are measured from the outside face of left support (or left cantilever end). All dimensions are horizontal.

Design Results	Actual @ Location	Allowed	Result	LDF	Load: Combination (Pattern)
Member Reaction (lbs)	3651 @ 4' 6 1/4"	4961 (3.50")	Passed (74%)	--	1.0 D + 1.0 L (All Spans)
Shear (lbs)	1845 @ 3' 4 7/8"	7343	Passed (25%)	1.00	1.0 D + 1.0 L (All Spans)
Pos Moment (Ft-lbs)	3277 @ 3' 2 7/16"	16452	Passed (20%)	1.00	1.0 D + 1.0 L (All Spans)
Live Load Defl. (in)	0.007 @ 2' 5 1/4"	0.109	Passed (L/999+)	--	1.0 D + 1.0 L (All Spans)
Total Load Defl. (in)	0.012 @ 2' 5 1/4"	0.218	Passed (L/999+)	--	1.0 D + 1.0 L (All Spans)

Member Length : 4' 8 1/4"
 System : Floor
 Member Type : Flush Beam
 Building Use : Residential
 Building Code : IBC 2018
 Design Methodology : ASD

- Deflection criteria: LL (L/480) and TL (L/240).
- Allowed moment does not reflect the adjustment for the beam stability factor.
- Critical positive moment adjusted by a volume/size factor of 1.00 that was calculated using length L = 4' 4 1/4".
- The effects of positive or negative camber have not been accounted for when calculating deflection.
- The specified glulam is assumed to have its strong laminations at the bottom of the beam. Install with proper side up as indicated by the manufacturer.
- Applicable calculations are based on NDS.

Supports	Bearing Length			Loads to Supports (lbs)			Accessories
	Total	Available	Required	Dead	Floor Live	Factored	
1 - Stud wall - HF	3.50"	3.50"	1.61"	993	1283	2276	Blocking
2 - Stud wall - HF	3.50"	3.50"	2.58"	1588	2064	3651	Blocking

- Blocking Panels are assumed to carry no loads applied directly above them and the full load is applied to the member being designed.

Lateral Bracing	Bracing Intervals	Comments
Top Edge (Lu)	4' 8" o/c	
Bottom Edge (Lu)	4' 8" o/c	

- Maximum allowable bracing intervals based on applied load.

Vertical Loads	Location (Side)	Tributary Width	Dead (0.90)	Floor Live (1.00)	Comments
0 - Self Weight (PLF)	0 to 4' 8 1/4"	N/A	10.1	--	
1 - Uniform (PSF)	0 to 4' 8 1/4" (Front)	10'	30.0	40.0	2nd Floor
2 - Uniform (PSF)	3' 4 1/4" to 4' 8 1/4" (Front)	10'	30.0	40.0	3rd Floor
3 - Point (lb)	3' 2 1/2" (Top)	N/A	727	938	Linked from: Grid 5.2 (B.6-B.8) Flush Beam, Support 2

Weyerhaeuser Notes

Weyerhaeuser warrants that the sizing of its products will be in accordance with Weyerhaeuser product design criteria and published design values. Weyerhaeuser expressly disclaims any other warranties related to the software. Use of this software is not intended to circumvent the need for a design professional as determined by the authority having jurisdiction. The designer of record, builder or framer is responsible to assure that this calculation is compatible with the overall project. Accessories (Rim Board, Blocking Panels and Squash Blocks) are not designed by this software. Products manufactured at Weyerhaeuser facilities are third-party certified to sustainable forestry standards. Weyerhaeuser Engineered Lumber Products have been evaluated by ICC-ES under evaluation reports ESR-1153 and ESR-1387 and/or tested in accordance with applicable ASTM standards. For current code evaluation reports, Weyerhaeuser product literature and installation details refer to www.eyerhaeuser.com/woodproducts/document-library.

The product application, input design loads, dimensions and support information have been provided by ForteWEB Software Operator

ForteWEB Software Operator	Job Notes
Chon Pieruccioni Pieruccioni Engineering (206) 949-7866 cpieru@hotmail.com	



2nd Floor Framing, Grid 5.2 (B.9-C) Bathroom Door Header
1 piece(s) 4 x 8 DF No.2

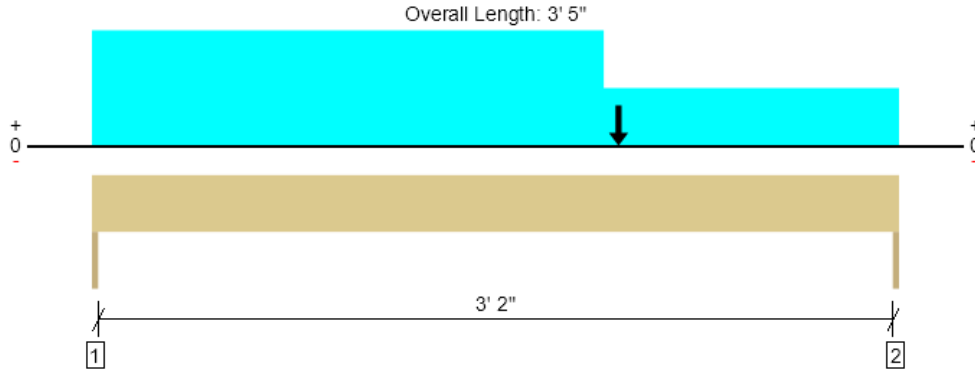

Drawing is Conceptual. All locations are measured from the outside face of left support (or left cantilever end). All dimensions are horizontal.

Design Results	Actual @ Location	Allowed	Result	LDF	Load: Combination (Pattern)
Member Reaction (lbs)	2637 @ 0	3281 (1.50")	Passed (80%)	--	1.0 D + 1.0 L (All Spans)
Shear (lbs)	1911 @ 2' 8 1/4"	3045	Passed (63%)	1.00	1.0 D + 1.0 L (All Spans)
Moment (Ft-lbs)	2472 @ 1' 10 1/2"	2989	Passed (83%)	1.00	1.0 D + 1.0 L (All Spans)
Live Load Defl. (in)	0.016 @ 1' 8 1/2"	0.114	Passed (L/999+)	--	1.0 D + 1.0 L (All Spans)
Total Load Defl. (in)	0.029 @ 1' 8 1/2"	0.171	Passed (L/999+)	--	1.0 D + 1.0 L (All Spans)

Member Length : 3' 5"
System : Wall
Member Type : Header
Building Use : Residential
Building Code : IBC 2018
Design Methodology : ASD

- Deflection criteria: LL (L/360) and TL (L/240).
- Allowed moment does not reflect the adjustment for the beam stability factor.
- Applicable calculations are based on NDS.

Supports	Bearing Length			Loads to Supports (lbs)			Accessories
	Total	Available	Required	Dead	Floor Live	Factored	
1 - Trimmer - HF	1.50"	1.50"	1.50"	1138	1499	2637	None
2 - Trimmer - HF	1.50"	1.50"	1.50"	1050	1377	2426	None

Lateral Bracing	Bracing Intervals	Comments
Top Edge (Lu)	3' 5" o/c	
Bottom Edge (Lu)	3' 5" o/c	

•Maximum allowable bracing intervals based on applied load.

Vertical Loads	Location	Tributary Width	Dead (0.90)	Floor Live (1.00)	Comments
0 - Self Weight (PLF)	0 to 3' 5"	N/A	6.4	--	
1 - Uniform (PSF)	0 to 3' 5"	10'	30.0	40.0	Default Load
2 - Uniform (PSF)	0 to 2' 2"	10'	30.0	40.0	Default Load
3 - Point (lb)	2' 2 3/4"	N/A	472	617	Linked from: Grid 5.2 (B.8-B.9) Bathroom Door Header, Support 1

Weyerhaeuser Notes

Weyerhaeuser warrants that the sizing of its products will be in accordance with Weyerhaeuser product design criteria and published design values. Weyerhaeuser expressly disclaims any other warranties related to the software. Use of this software is not intended to circumvent the need for a design professional as determined by the authority having jurisdiction. The designer of record, builder or framer is responsible to assure that this calculation is compatible with the overall project. Accessories (Rim Board, Blocking Panels and Squash Blocks) are not designed by this software. Products manufactured at Weyerhaeuser facilities are third-party certified to sustainable forestry standards. Weyerhaeuser Engineered Lumber Products have been evaluated by ICC-ES under evaluation reports ESR-1153 and ESR-1387 and/or tested in accordance with applicable ASTM standards. For current code evaluation reports, Weyerhaeuser product literature and installation details refer to www.eyerhaeuser.com/woodproducts/document-library.

The product application, input design loads, dimensions and support information have been provided by ForteWEB Software Operator

ForteWEB Software Operator	Job Notes
Chon Pieruccini Pieruccini Engineering (206) 949-7866 cpieru@hotmail.com	



2nd Floor Framing, Grid 8.8 (B.9-C) Bathroom Door Header
1 piece(s) 4 x 8 DF No.2

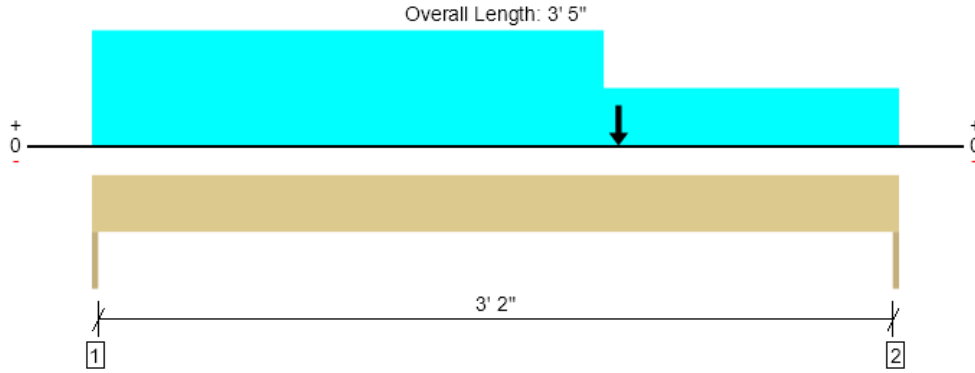

Drawing is Conceptual. All locations are measured from the outside face of left support (or left cantilever end). All dimensions are horizontal.

Design Results	Actual @ Location	Allowed	Result	LDF	Load: Combination (Pattern)
Member Reaction (lbs)	2637 @ 0	3281 (1.50")	Passed (80%)	--	1.0 D + 1.0 L (All Spans)
Shear (lbs)	1911 @ 2' 8 1/4"	3045	Passed (63%)	1.00	1.0 D + 1.0 L (All Spans)
Moment (Ft-lbs)	2472 @ 1' 10 1/2"	2989	Passed (83%)	1.00	1.0 D + 1.0 L (All Spans)
Live Load Defl. (in)	0.016 @ 1' 8 1/2"	0.114	Passed (L/999+)	--	1.0 D + 1.0 L (All Spans)
Total Load Defl. (in)	0.029 @ 1' 8 1/2"	0.171	Passed (L/999+)	--	1.0 D + 1.0 L (All Spans)

Member Length : 3' 5"
System : Wall
Member Type : Header
Building Use : Residential
Building Code : IBC 2018
Design Methodology : ASD

- Deflection criteria: LL (L/360) and TL (L/240).
- Allowed moment does not reflect the adjustment for the beam stability factor.
- Applicable calculations are based on NDS.

Supports	Bearing Length			Loads to Supports (lbs)			Accessories
	Total	Available	Required	Dead	Floor Live	Factored	
1 - Trimmer - HF	1.50"	1.50"	1.50"	1138	1499	2637	None
2 - Trimmer - HF	1.50"	1.50"	1.50"	1050	1377	2426	None

Lateral Bracing	Bracing Intervals	Comments
Top Edge (Lu)	3' 5" o/c	
Bottom Edge (Lu)	3' 5" o/c	

•Maximum allowable bracing intervals based on applied load.

Vertical Loads	Location	Tributary Width	Dead (0.90)	Floor Live (1.00)	Comments
0 - Self Weight (PLF)	0 to 3' 5"	N/A	6.4	--	
1 - Uniform (PSF)	0 to 3' 5"	10'	30.0	40.0	Default Load
2 - Uniform (PSF)	0 to 2' 2"	10'	30.0	40.0	Default Load
3 - Point (lb)	2' 2 3/4"	N/A	472	617	Linked from: Grid 5.2 (B.8-B.9) Bathroom Door Header, Support 1

Weyerhaeuser Notes

Weyerhaeuser warrants that the sizing of its products will be in accordance with Weyerhaeuser product design criteria and published design values. Weyerhaeuser expressly disclaims any other warranties related to the software. Use of this software is not intended to circumvent the need for a design professional as determined by the authority having jurisdiction. The designer of record, builder or framer is responsible to assure that this calculation is compatible with the overall project. Accessories (Rim Board, Blocking Panels and Squash Blocks) are not designed by this software. Products manufactured at Weyerhaeuser facilities are third-party certified to sustainable forestry standards. Weyerhaeuser Engineered Lumber Products have been evaluated by ICC-ES under evaluation reports ESR-1153 and ESR-1387 and/or tested in accordance with applicable ASTM standards. For current code evaluation reports, Weyerhaeuser product literature and installation details refer to www.weyerhaeuser.com/woodproducts/document-library.

The product application, input design loads, dimensions and support information have been provided by ForteWEB Software Operator

ForteWEB Software Operator	Job Notes
Chon Pieruccini Pieruccini Engineering (206) 949-7866 cpieru@hotmail.com	



2nd Floor Framing, Grid 6.2 (B.4-B.5) Bedroom Door Header
1 piece(s) 4 x 8 DF No.2

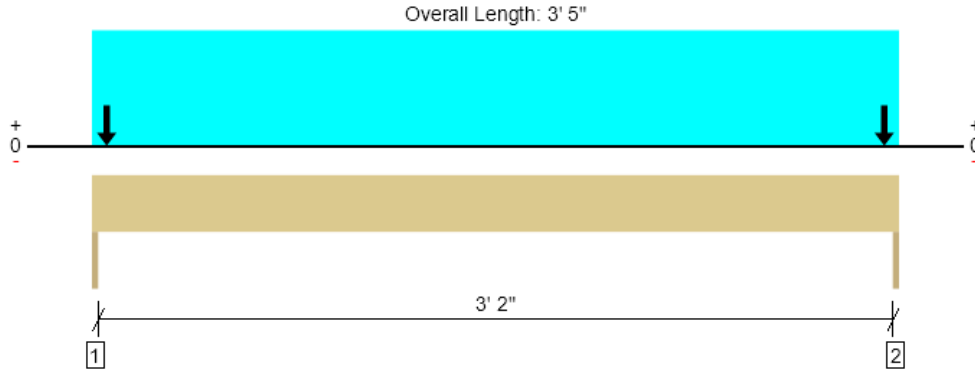

Drawing is Conceptual. All locations are measured from the outside face of left support (or left cantilever end). All dimensions are horizontal.

Design Results	Actual @ Location	Allowed	Result	LDF	Load: Combination (Pattern)
Member Reaction (lbs)	2413 @ 0	3281 (1.50")	Passed (74%)	--	1.0 D + 1.0 L (All Spans)
Shear (lbs)	692 @ 8 3/4"	3045	Passed (23%)	1.00	1.0 D + 1.0 L (All Spans)
Moment (Ft-lbs)	1031 @ 1' 8 1/2"	2989	Passed (34%)	1.00	1.0 D + 1.0 L (All Spans)
Live Load Defl. (in)	0.007 @ 1' 8 1/2"	0.114	Passed (L/999+)	--	1.0 D + 1.0 L (All Spans)
Total Load Defl. (in)	0.012 @ 1' 8 1/2"	0.171	Passed (L/999+)	--	1.0 D + 1.0 L (All Spans)

Member Length : 3' 5"
System : Wall
Member Type : Header
Building Use : Residential
Building Code : IBC 2018
Design Methodology : ASD

- Deflection criteria: LL (L/360) and TL (L/240).
- Allowed moment does not reflect the adjustment for the beam stability factor.
- Applicable calculations are based on NDS.

Supports	Bearing Length			Loads to Supports (lbs)			Accessories
	Total	Available	Required	Dead	Floor Live	Factored	
1 - Trimmer - HF	1.50"	1.50"	1.50"	1046	1366	2413	None
2 - Trimmer - HF	1.50"	1.50"	1.50"	1046	1366	2413	None

Lateral Bracing	Bracing Intervals	Comments
Top Edge (Lu)	3' 5" o/c	
Bottom Edge (Lu)	3' 5" o/c	

•Maximum allowable bracing intervals based on applied load.

Vertical Loads	Location	Tributary Width	Dead (0.90)	Floor Live (1.00)	Comments
0 - Self Weight (PLF)	0 to 3' 5"	N/A	6.4	--	
1 - Uniform (PSF)	0 to 3' 5"	10'	30.0	40.0	Default Load
2 - Point (lb)	3/4"	N/A	523	683	Linked from: Grid 6.2 (B.4-B.5) Bedroom Door Header, Support 1
3 - Point (lb)	3' 4 1/4"	N/A	523	683	Linked from: Grid 6.2 (B.4-B.5) Bedroom Door Header, Support 2

Weyerhaeuser Notes

Weyerhaeuser warrants that the sizing of its products will be in accordance with Weyerhaeuser product design criteria and published design values. Weyerhaeuser expressly disclaims any other warranties related to the software. Use of this software is not intended to circumvent the need for a design professional as determined by the authority having jurisdiction. The designer of record, builder or framer is responsible to assure that this calculation is compatible with the overall project. Accessories (Rim Board, Blocking Panels and Squash Blocks) are not designed by this software. Products manufactured at Weyerhaeuser facilities are third-party certified to sustainable forestry standards. Weyerhaeuser Engineered Lumber Products have been evaluated by ICC-ES under evaluation reports ESR-1153 and ESR-1387 and/or tested in accordance with applicable ASTM standards. For current code evaluation reports, Weyerhaeuser product literature and installation details refer to www.weyerhaeuser.com/woodproducts/document-library.

The product application, input design loads, dimensions and support information have been provided by ForteWEB Software Operator

ForteWEB Software Operator	Job Notes
Chon Pieruccioni Pieruccioni Engineering (206) 949-7866 cpieru@hotmail.com	



2nd Floor Framing, Grid 7.8 (B.4-B.5) Bedroom Door Header
1 piece(s) 4 x 8 DF No.2

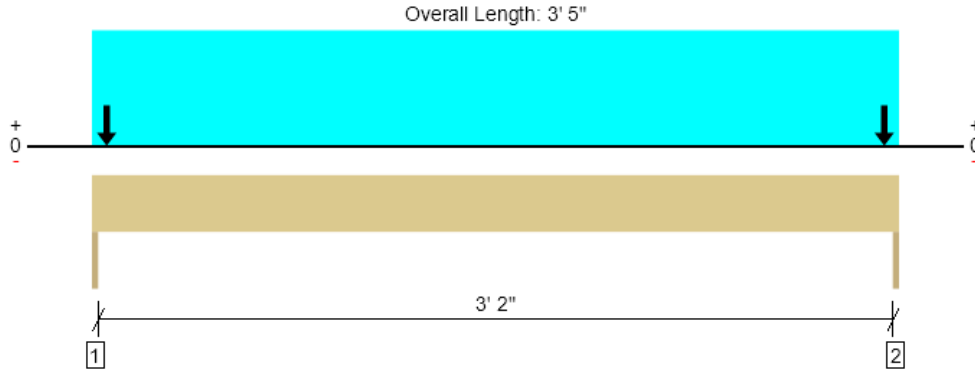

Drawing is Conceptual. All locations are measured from the outside face of left support (or left cantilever end). All dimensions are horizontal.

Design Results	Actual @ Location	Allowed	Result	LDF	Load: Combination (Pattern)
Member Reaction (lbs)	2413 @ 0	3281 (1.50")	Passed (74%)	--	1.0 D + 1.0 L (All Spans)
Shear (lbs)	692 @ 8 3/4"	3045	Passed (23%)	1.00	1.0 D + 1.0 L (All Spans)
Moment (Ft-lbs)	1031 @ 1' 8 1/2"	2989	Passed (34%)	1.00	1.0 D + 1.0 L (All Spans)
Live Load Defl. (in)	0.007 @ 1' 8 1/2"	0.114	Passed (L/999+)	--	1.0 D + 1.0 L (All Spans)
Total Load Defl. (in)	0.012 @ 1' 8 1/2"	0.171	Passed (L/999+)	--	1.0 D + 1.0 L (All Spans)

Member Length : 3' 5"
System : Wall
Member Type : Header
Building Use : Residential
Building Code : IBC 2018
Design Methodology : ASD

- Deflection criteria: LL (L/360) and TL (L/240).
- Allowed moment does not reflect the adjustment for the beam stability factor.
- Applicable calculations are based on NDS.

Supports	Bearing Length			Loads to Supports (lbs)			Accessories
	Total	Available	Required	Dead	Floor Live	Factored	
1 - Trimmer - HF	1.50"	1.50"	1.50"	1046	1366	2413	None
2 - Trimmer - HF	1.50"	1.50"	1.50"	1046	1366	2413	None

Lateral Bracing	Bracing Intervals	Comments
Top Edge (Lu)	3' 5" o/c	
Bottom Edge (Lu)	3' 5" o/c	

•Maximum allowable bracing intervals based on applied load.

Vertical Loads	Location	Tributary Width	Dead (0.90)	Floor Live (1.00)	Comments
0 - Self Weight (PLF)	0 to 3' 5"	N/A	6.4	--	
1 - Uniform (PSF)	0 to 3' 5"	10'	30.0	40.0	Default Load
2 - Point (lb)	3/4"	N/A	523	683	Linked from: Grid 6.2 (B.4-B.5) Bedroom Door Header, Support 1
3 - Point (lb)	3' 4 1/4"	N/A	523	683	Linked from: Grid 6.2 (B.4-B.5) Bedroom Door Header, Support 2

Weyerhaeuser Notes

Weyerhaeuser warrants that the sizing of its products will be in accordance with Weyerhaeuser product design criteria and published design values. Weyerhaeuser expressly disclaims any other warranties related to the software. Use of this software is not intended to circumvent the need for a design professional as determined by the authority having jurisdiction. The designer of record, builder or framer is responsible to assure that this calculation is compatible with the overall project. Accessories (Rim Board, Blocking Panels and Squash Blocks) are not designed by this software. Products manufactured at Weyerhaeuser facilities are third-party certified to sustainable forestry standards. Weyerhaeuser Engineered Lumber Products have been evaluated by ICC-ES under evaluation reports ESR-1153 and ESR-1387 and/or tested in accordance with applicable ASTM standards. For current code evaluation reports, Weyerhaeuser product literature and installation details refer to www.woyehaeuser.com/woodproducts/document-library.

The product application, input design loads, dimensions and support information have been provided by ForteWEB Software Operator

ForteWEB Software Operator	Job Notes
Chon Pieruccioni Pieruccioni Engineering (206) 949-7866 cpieru@hotmail.com	



2nd Floor Framing, Grid 6.2 (B.7-C) Flush Beam
1 piece(s) 3 1/2" x 11 7/8" 24F-V4 DF Glulam

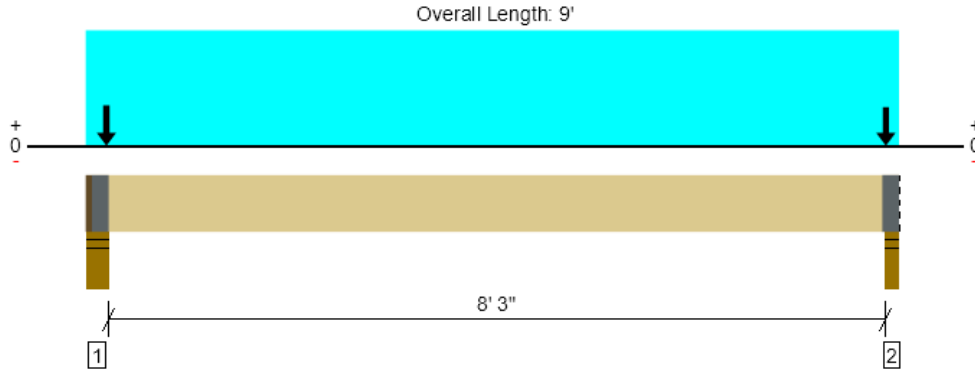

Drawing is Conceptual. All locations are measured from the outside face of left support (or left cantilever end). All dimensions are horizontal.

Design Results	Actual @ Location	Allowed	Result	LDF	Load: Combination (Pattern)
Member Reaction (lbs)	3136 @ 8' 10"	4961 (3.50")	Passed (63%)	--	1.0 D + 1.0 L (All Spans)
Shear (lbs)	2226 @ 1' 5 3/8"	7343	Passed (30%)	1.00	1.0 D + 1.0 L (All Spans)
Pos Moment (Ft-lbs)	6413 @ 4' 7"	16452	Passed (39%)	1.00	1.0 D + 1.0 L (All Spans)
Live Load Defl. (in)	0.053 @ 4' 7"	0.213	Passed (L/999+)	--	1.0 D + 1.0 L (All Spans)
Total Load Defl. (in)	0.095 @ 4' 7"	0.425	Passed (L/999+)	--	1.0 D + 1.0 L (All Spans)

Member Length : 8' 10 1/2"
System : Floor
Member Type : Flush Beam
Building Use : Residential
Building Code : IBC 2018
Design Methodology : ASD

- Deflection criteria: LL (L/480) and TL (L/240).
- Allowed moment does not reflect the adjustment for the beam stability factor.
- Critical positive moment adjusted by a volume/size factor of 1.00 that was calculated using length L = 8' 6".
- The effects of positive or negative camber have not been accounted for when calculating deflection.
- The specified glulam is assumed to have its strong laminations at the bottom of the beam. Install with proper side up as indicated by the manufacturer.
- Applicable calculations are based on NDS.

Supports	Bearing Length			Loads to Supports (lbs)			Accessories
	Total	Available	Required	Dead	Floor Live	Factored	
1 - Stud wall - HF	5.50"	4.00"	2.23"	2840	3666	6506	1 1/2" Rim Board, Squash Blocks
2 - Stud wall - HF	3.50"	3.50"	2.21"	2740	3534	6273	Blocking, Squash Blocks

- Rim Board is assumed to carry all loads applied directly above it, bypassing the member being designed.
- Squash Blocks must match bearing length and are assumed to carry all loads applied directly above them, bypassing the member being designed.
- Blocking Panels are assumed to carry no loads applied directly above them and the full load is applied to the member being designed.

Lateral Bracing	Bracing Intervals	Comments
Top Edge (Lu)	8' 11" o/c	
Bottom Edge (Lu)	8' 11" o/c	

- Maximum allowable bracing intervals based on applied load.

Vertical Loads	Location (Side)	Tributary Width	Dead (0.90)	Floor Live (1.00)	Comments
0 - Self Weight (PLF)	1 1/2" to 9'	N/A	10.1	--	
1 - Uniform (PSF)	0 to 9' (Front)	10'	30.0	40.0	Default Load
2 - Point (lb)	8' 10 1/4" (Top)	N/A	1370	1767	Linked from: Grid 6.2 (B.7-C) Flush Beam, Support 2
3 - Point (lb)	2 3/4" (Top)	N/A	1420	1833	Linked from: Grid 6.2 (B.7-C) Flush Beam, Support 1

Weyerhaeuser Notes

Weyerhaeuser warrants that the sizing of its products will be in accordance with Weyerhaeuser product design criteria and published design values. Weyerhaeuser expressly disclaims any other warranties related to the software. Use of this software is not intended to circumvent the need for a design professional as determined by the authority having jurisdiction. The designer of record, builder or framer is responsible to assure that this calculation is compatible with the overall project. Accessories (Rim Board, Blocking Panels and Squash Blocks) are not designed by this software. Products manufactured at Weyerhaeuser facilities are third-party certified to sustainable forestry standards. Weyerhaeuser Engineered Lumber Products have been evaluated by ICC-ES under evaluation reports ESR-1153 and ESR-1387 and/or tested in accordance with applicable ASTM standards. For current code evaluation reports, Weyerhaeuser product literature and installation details refer to www.weyerhaeuser.com/woodproducts/document-library.

The product application, input design loads, dimensions and support information have been provided by ForteWEB Software Operator

ForteWEB Software Operator	Job Notes
Chon Pieruccini Pieruccini Engineering (206) 949-7866 cpieru@hotmail.com	



2nd Floor Framing, Grid 7.8 (B.7-C) Flush Beam
1 piece(s) 3 1/2" x 11 7/8" 24F-V4 DF Glulam

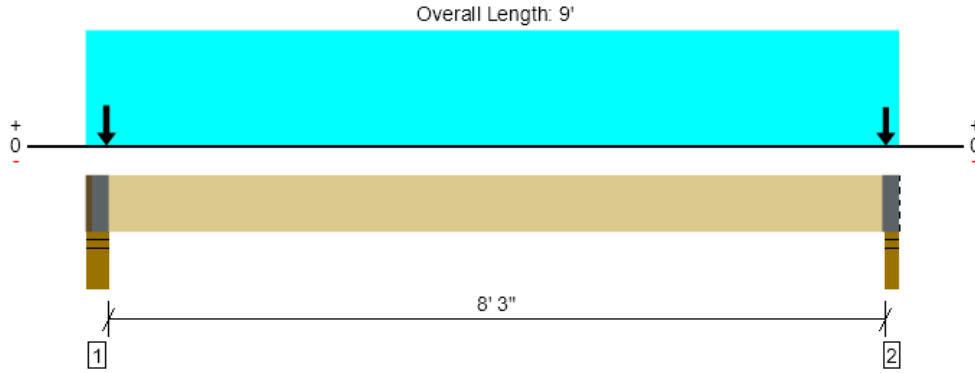

Drawing is Conceptual. All locations are measured from the outside face of left support (or left cantilever end). All dimensions are horizontal.

Design Results	Actual @ Location	Allowed	Result	LDF	Load: Combination (Pattern)
Member Reaction (lbs)	3136 @ 8' 10"	4961 (3.50")	Passed (63%)	--	1.0 D + 1.0 L (All Spans)
Shear (lbs)	2226 @ 1' 5 3/8"	7343	Passed (30%)	1.00	1.0 D + 1.0 L (All Spans)
Pos Moment (Ft-lbs)	6413 @ 4' 7"	16452	Passed (39%)	1.00	1.0 D + 1.0 L (All Spans)
Live Load Defl. (in)	0.053 @ 4' 7"	0.213	Passed (L/999+)	--	1.0 D + 1.0 L (All Spans)
Total Load Defl. (in)	0.095 @ 4' 7"	0.425	Passed (L/999+)	--	1.0 D + 1.0 L (All Spans)

Member Length : 8' 10 1/2"
System : Floor
Member Type : Flush Beam
Building Use : Residential
Building Code : IBC 2018
Design Methodology : ASD

- Deflection criteria: LL (L/480) and TL (L/240).
- Allowed moment does not reflect the adjustment for the beam stability factor.
- Critical positive moment adjusted by a volume/size factor of 1.00 that was calculated using length L = 8' 6".
- The effects of positive or negative camber have not been accounted for when calculating deflection.
- The specified glulam is assumed to have its strong laminations at the bottom of the beam. Install with proper side up as indicated by the manufacturer.
- Applicable calculations are based on NDS.

Supports	Bearing Length			Loads to Supports (lbs)			Accessories
	Total	Available	Required	Dead	Floor Live	Factored	
1 - Stud wall - HF	5.50"	4.00"	2.23"	2840	3666	6506	1 1/2" Rim Board, Squash Blocks
2 - Stud wall - HF	3.50"	3.50"	2.21"	2740	3534	6273	Blocking, Squash Blocks

- Rim Board is assumed to carry all loads applied directly above it, bypassing the member being designed.
- Squash Blocks must match bearing length and are assumed to carry all loads applied directly above them, bypassing the member being designed.
- Blocking Panels are assumed to carry no loads applied directly above them and the full load is applied to the member being designed.

Lateral Bracing	Bracing Intervals	Comments
Top Edge (Lu)	8' 11" o/c	
Bottom Edge (Lu)	8' 11" o/c	

- Maximum allowable bracing intervals based on applied load.

Vertical Loads	Location (Side)	Tributary Width	Dead (0.90)	Floor Live (1.00)	Comments
0 - Self Weight (PLF)	1 1/2" to 9'	N/A	10.1	--	
1 - Uniform (PSF)	0 to 9' (Front)	10'	30.0	40.0	Default Load
2 - Point (lb)	8' 10 1/4" (Top)	N/A	1370	1767	Linked from: Grid 6.2 (B.7-C) Flush Beam, Support 2
3 - Point (lb)	2 3/4" (Top)	N/A	1420	1833	Linked from: Grid 6.2 (B.7-C) Flush Beam, Support 1

Weyerhaeuser Notes

Weyerhaeuser warrants that the sizing of its products will be in accordance with Weyerhaeuser product design criteria and published design values. Weyerhaeuser expressly disclaims any other warranties related to the software. Use of this software is not intended to circumvent the need for a design professional as determined by the authority having jurisdiction. The designer of record, builder or framer is responsible to assure that this calculation is compatible with the overall project. Accessories (Rim Board, Blocking Panels and Squash Blocks) are not designed by this software. Products manufactured at Weyerhaeuser facilities are third-party certified to sustainable forestry standards. Weyerhaeuser Engineered Lumber Products have been evaluated by ICC-ES under evaluation reports ESR-1153 and ESR-1387 and/or tested in accordance with applicable ASTM standards. For current code evaluation reports, Weyerhaeuser product literature and installation details refer to www.weyerhaeuser.com/woodproducts/document-library.

The product application, input design loads, dimensions and support information have been provided by ForteWEB Software Operator

ForteWEB Software Operator	Job Notes
Chon Pieruccini Pieruccini Engineering (206) 949-7866 cpieru@hotmail.com	



2nd Floor Framing, Grid 2.3 (D-D.1) Bedroom Door Header
1 piece(s) 4 x 8 DF No.2

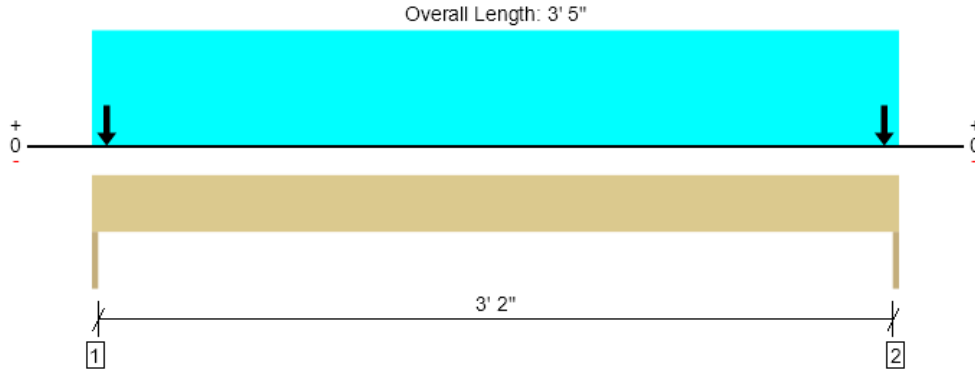

Drawing is Conceptual. All locations are measured from the outside face of left support (or left cantilever end). All dimensions are horizontal.

Design Results	Actual @ Location	Allowed	Result	LDF	Load: Combination (Pattern)
Member Reaction (lbs)	1976 @ 0	3281 (1.50")	Passed (60%)	--	1.0 D + 1.0 L (All Spans)
Shear (lbs)	566 @ 8 3/4"	3045	Passed (19%)	1.00	1.0 D + 1.0 L (All Spans)
Moment (Ft-lbs)	844 @ 1' 8 1/2"	2989	Passed (28%)	1.00	1.0 D + 1.0 L (All Spans)
Live Load Defl. (in)	0.006 @ 1' 8 1/2"	0.114	Passed (L/999+)	--	1.0 D + 1.0 L (All Spans)
Total Load Defl. (in)	0.010 @ 1' 8 1/2"	0.171	Passed (L/999+)	--	1.0 D + 1.0 L (All Spans)

Member Length : 3' 5"
System : Wall
Member Type : Header
Building Use : Residential
Building Code : IBC 2018
Design Methodology : ASD

- Deflection criteria: LL (L/360) and TL (L/240).
- Allowed moment does not reflect the adjustment for the beam stability factor.
- Applicable calculations are based on NDS.

Supports	Bearing Length			Loads to Supports (lbs)			Accessories
	Total	Available	Required	Dead	Floor Live	Factored	
1 - Trimmer - HF	1.50"	1.50"	1.50"	860	1116	1976	None
2 - Trimmer - HF	1.50"	1.50"	1.50"	860	1116	1976	None

Lateral Bracing	Bracing Intervals	Comments
Top Edge (Lu)	3' 5" o/c	
Bottom Edge (Lu)	3' 5" o/c	

•Maximum allowable bracing intervals based on applied load.

Vertical Loads	Location	Tributary Width	Dead (0.90)	Floor Live (1.00)	Comments
0 - Self Weight (PLF)	0 to 3' 5"	N/A	6.4	--	
1 - Uniform (PSF)	0 to 3' 5"	8' 2"	30.0	40.0	Default Load
2 - Point (lb)	3/4"	N/A	430	558	Linked from: Grid 2.3 (D-D.1) Bedroom Door Header, Support 1
3 - Point (lb)	3' 4 1/4"	N/A	430	558	Linked from: Grid 2.3 (D-D.1) Bedroom Door Header, Support 2

Weyerhaeuser Notes

Weyerhaeuser warrants that the sizing of its products will be in accordance with Weyerhaeuser product design criteria and published design values. Weyerhaeuser expressly disclaims any other warranties related to the software. Use of this software is not intended to circumvent the need for a design professional as determined by the authority having jurisdiction. The designer of record, builder or framer is responsible to assure that this calculation is compatible with the overall project. Accessories (Rim Board, Blocking Panels and Squash Blocks) are not designed by this software. Products manufactured at Weyerhaeuser facilities are third-party certified to sustainable forestry standards. Weyerhaeuser Engineered Lumber Products have been evaluated by ICC-ES under evaluation reports ESR-1153 and ESR-1387 and/or tested in accordance with applicable ASTM standards. For current code evaluation reports, Weyerhaeuser product literature and installation details refer to www.weyerhaeuser.com/woodproducts/document-library.

The product application, input design loads, dimensions and support information have been provided by ForteWEB Software Operator

ForteWEB Software Operator	Job Notes
Chon Pieruccioni Pieruccioni Engineering (206) 949-7866 cpieru@hotmail.com	



2nd Floor Framing, Grid 11.7 (D-D.1) Bedroom Door Header
1 piece(s) 4 x 8 DF No.2

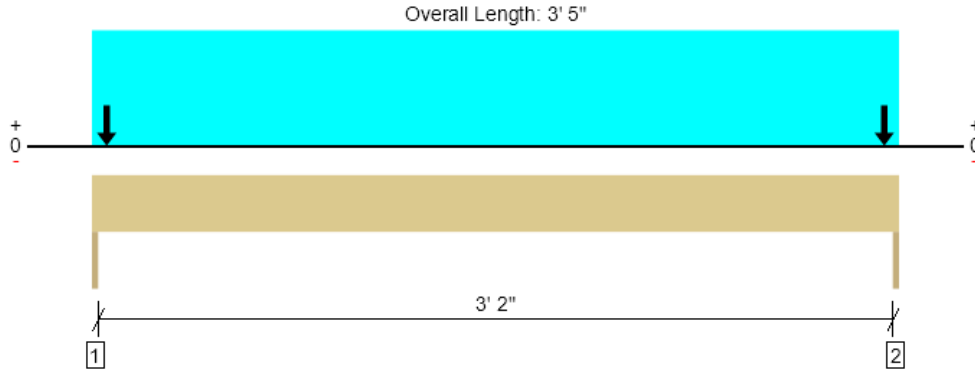

Drawing is Conceptual. All locations are measured from the outside face of left support (or left cantilever end). All dimensions are horizontal.

Design Results	Actual @ Location	Allowed	Result	LDF	Load: Combination (Pattern)
Member Reaction (lbs)	1976 @ 0	3281 (1.50")	Passed (60%)	--	1.0 D + 1.0 L (All Spans)
Shear (lbs)	566 @ 8 3/4"	3045	Passed (19%)	1.00	1.0 D + 1.0 L (All Spans)
Moment (Ft-lbs)	844 @ 1' 8 1/2"	2989	Passed (28%)	1.00	1.0 D + 1.0 L (All Spans)
Live Load Defl. (in)	0.006 @ 1' 8 1/2"	0.114	Passed (L/999+)	--	1.0 D + 1.0 L (All Spans)
Total Load Defl. (in)	0.010 @ 1' 8 1/2"	0.171	Passed (L/999+)	--	1.0 D + 1.0 L (All Spans)

Member Length : 3' 5"
System : Wall
Member Type : Header
Building Use : Residential
Building Code : IBC 2018
Design Methodology : ASD

- Deflection criteria: LL (L/360) and TL (L/240).
- Allowed moment does not reflect the adjustment for the beam stability factor.
- Applicable calculations are based on NDS.

Supports	Bearing Length			Loads to Supports (lbs)			Accessories
	Total	Available	Required	Dead	Floor Live	Factored	
1 - Trimmer - HF	1.50"	1.50"	1.50"	860	1116	1976	None
2 - Trimmer - HF	1.50"	1.50"	1.50"	860	1116	1976	None

Lateral Bracing	Bracing Intervals	Comments
Top Edge (Lu)	3' 5" o/c	
Bottom Edge (Lu)	3' 5" o/c	

•Maximum allowable bracing intervals based on applied load.

Vertical Loads	Location	Tributary Width	Dead (0.90)	Floor Live (1.00)	Comments
0 - Self Weight (PLF)	0 to 3' 5"	N/A	6.4	--	
1 - Uniform (PSF)	0 to 3' 5"	8' 2"	30.0	40.0	Default Load
2 - Point (lb)	3/4"	N/A	430	558	Linked from: Grid 2.3 (D-D.1) Bedroom Door Header, Support 1
3 - Point (lb)	3' 4 1/4"	N/A	430	558	Linked from: Grid 2.3 (D-D.1) Bedroom Door Header, Support 2

Weyerhaeuser Notes

Weyerhaeuser warrants that the sizing of its products will be in accordance with Weyerhaeuser product design criteria and published design values. Weyerhaeuser expressly disclaims any other warranties related to the software. Use of this software is not intended to circumvent the need for a design professional as determined by the authority having jurisdiction. The designer of record, builder or framer is responsible to assure that this calculation is compatible with the overall project. Accessories (Rim Board, Blocking Panels and Squash Blocks) are not designed by this software. Products manufactured at Weyerhaeuser facilities are third-party certified to sustainable forestry standards. Weyerhaeuser Engineered Lumber Products have been evaluated by ICC-ES under evaluation reports ESR-1153 and ESR-1387 and/or tested in accordance with applicable ASTM standards. For current code evaluation reports, Weyerhaeuser product literature and installation details refer to www.weyerhaeuser.com/woodproducts/document-library.

The product application, input design loads, dimensions and support information have been provided by ForteWEB Software Operator

ForteWEB Software Operator	Job Notes
Chon Pieruccioni Pieruccioni Engineering (206) 949-7866 cpieru@hotmail.com	



2nd Floor Framing, Grid 2.7 (D.2-D.4) Flush Beam
1 piece(s) 3 1/2" x 11 7/8" 24F-V4 DF Glulam

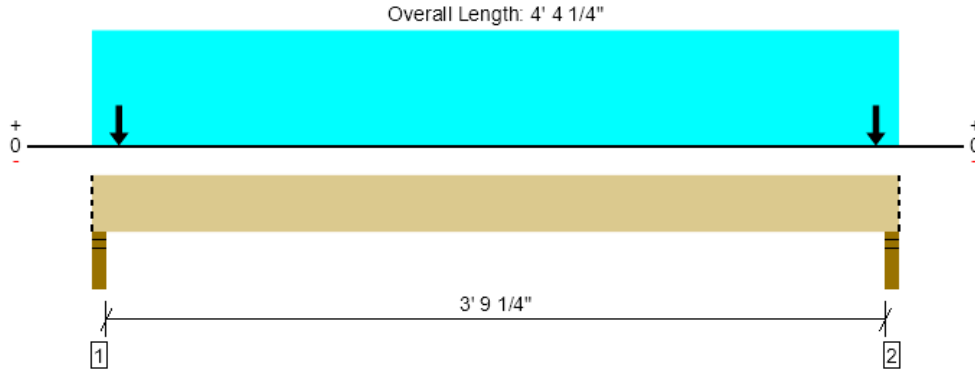

Drawing is Conceptual. All locations are measured from the outside face of left support (or left cantilever end). All dimensions are horizontal.

Design Results	Actual @ Location	Allowed	Result	LDF	Load: Combination (Pattern)
Member Reaction (lbs)	3473 @ 2"	4961 (3.50")	Passed (70%)	--	1.0 D + 1.0 L (All Spans)
Shear (lbs)	715 @ 1' 3 3/8"	7343	Passed (10%)	1.00	1.0 D + 1.0 L (All Spans)
Pos Moment (Ft-lbs)	1612 @ 2' 2 1/8"	16452	Passed (10%)	1.00	1.0 D + 1.0 L (All Spans)
Live Load Defl. (in)	0.003 @ 2' 2 1/8"	0.101	Passed (L/999+)	--	1.0 D + 1.0 L (All Spans)
Total Load Defl. (in)	0.005 @ 2' 2 1/8"	0.201	Passed (L/999+)	--	1.0 D + 1.0 L (All Spans)

Member Length : 4' 4 1/4"
System : Floor
Member Type : Flush Beam
Building Use : Residential
Building Code : IBC 2018
Design Methodology : ASD

- Deflection criteria: LL (L/480) and TL (L/240).
- Allowed moment does not reflect the adjustment for the beam stability factor.
- Critical positive moment adjusted by a volume/size factor of 1.00 that was calculated using length L = 4' 1/4".
- The effects of positive or negative camber have not been accounted for when calculating deflection.
- The specified glulam is assumed to have its strong laminations at the bottom of the beam. Install with proper side up as indicated by the manufacturer.
- Applicable calculations are based on NDS.

Supports	Bearing Length			Loads to Supports (lbs)			Accessories
	Total	Available	Required	Dead	Floor Live	Factored	
1 - Stud wall - HF	3.50"	3.50"	2.45"	1514	1960	3473	Blocking
2 - Stud wall - HF	3.50"	3.50"	2.45"	1514	1960	3473	Blocking

• Blocking Panels are assumed to carry no loads applied directly above them and the full load is applied to the member being designed.

Lateral Bracing	Bracing Intervals	Comments
Top Edge (Lu)	4' 4" o/c	
Bottom Edge (Lu)	4' 4" o/c	

•Maximum allowable bracing intervals based on applied load.

Vertical Loads	Location (Side)	Tributary Width	Dead (0.90)	Floor Live (1.00)	Comments
0 - Self Weight (PLF)	0 to 4' 4 1/4"	N/A	10.1	--	
1 - Uniform (PSF)	0 to 4' 4 1/4" (Front)	11' 3"	30.0	40.0	Default Load
2 - Point (lb)	1 3/4" (Top)	N/A	757	980	Linked from: Grid 2.7 (D.2-D.4) Flush Beam, Support 1
3 - Point (lb)	4' 2 3/4" (Top)	N/A	757	980	Linked from: Grid 2.7 (D.2-D.4) Flush Beam, Support 2

Weyerhaeuser Notes

Weyerhaeuser warrants that the sizing of its products will be in accordance with Weyerhaeuser product design criteria and published design values. Weyerhaeuser expressly disclaims any other warranties related to the software. Use of this software is not intended to circumvent the need for a design professional as determined by the authority having jurisdiction. The designer of record, builder or framer is responsible to assure that this calculation is compatible with the overall project. Accessories (Rim Board, Blocking Panels and Squash Blocks) are not designed by this software. Products manufactured at Weyerhaeuser facilities are third-party certified to sustainable forestry standards. Weyerhaeuser Engineered Lumber Products have been evaluated by ICC-ES under evaluation reports ESR-1153 and ESR-1387 and/or tested in accordance with applicable ASTM standards. For current code evaluation reports, Weyerhaeuser product literature and installation details refer to www.eyerhaeuser.com/woodproducts/document-library.

The product application, input design loads, dimensions and support information have been provided by ForteWEB Software Operator

ForteWEB Software Operator	Job Notes
Chon Pieruccini Pieruccini Engineering (206) 949-7866 cpieru@hotmail.com	



2nd Floor Framing, Grid 11.3 (D.2-D.4) Flush Beam
1 piece(s) 3 1/2" x 11 7/8" 24F-V4 DF Glulam

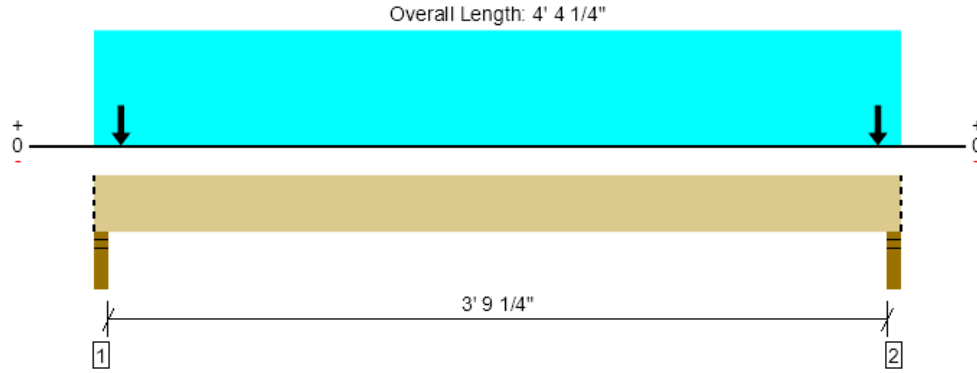

Drawing is Conceptual. All locations are measured from the outside face of left support (or left cantilever end). All dimensions are horizontal.

Design Results	Actual @ Location	Allowed	Result	LDF	Load: Combination (Pattern)
Member Reaction (lbs)	3473 @ 2"	4961 (3.50")	Passed (70%)	--	1.0 D + 1.0 L (All Spans)
Shear (lbs)	715 @ 1' 3 3/8"	7343	Passed (10%)	1.00	1.0 D + 1.0 L (All Spans)
Pos Moment (Ft-lbs)	1612 @ 2' 2 1/8"	16452	Passed (10%)	1.00	1.0 D + 1.0 L (All Spans)
Live Load Defl. (in)	0.003 @ 2' 2 1/8"	0.101	Passed (L/999+)	--	1.0 D + 1.0 L (All Spans)
Total Load Defl. (in)	0.005 @ 2' 2 1/8"	0.201	Passed (L/999+)	--	1.0 D + 1.0 L (All Spans)

Member Length : 4' 4 1/4"
System : Floor
Member Type : Flush Beam
Building Use : Residential
Building Code : IBC 2018
Design Methodology : ASD

- Deflection criteria: LL (L/480) and TL (L/240).
- Allowed moment does not reflect the adjustment for the beam stability factor.
- Critical positive moment adjusted by a volume/size factor of 1.00 that was calculated using length L = 4' 1/4".
- The effects of positive or negative camber have not been accounted for when calculating deflection.
- The specified glulam is assumed to have its strong laminations at the bottom of the beam. Install with proper side up as indicated by the manufacturer.
- Applicable calculations are based on NDS.

Supports	Bearing Length			Loads to Supports (lbs)			Accessories
	Total	Available	Required	Dead	Floor Live	Factored	
1 - Stud wall - HF	3.50"	3.50"	2.45"	1514	1960	3473	Blocking
2 - Stud wall - HF	3.50"	3.50"	2.45"	1514	1960	3473	Blocking

• Blocking Panels are assumed to carry no loads applied directly above them and the full load is applied to the member being designed.

Lateral Bracing	Bracing Intervals	Comments
Top Edge (Lu)	4' 4" o/c	
Bottom Edge (Lu)	4' 4" o/c	

•Maximum allowable bracing intervals based on applied load.

Vertical Loads	Location (Side)	Tributary Width	Dead (0.90)	Floor Live (1.00)	Comments
0 - Self Weight (PLF)	0 to 4' 4 1/4"	N/A	10.1	--	
1 - Uniform (PSF)	0 to 4' 4 1/4" (Front)	11' 3"	30.0	40.0	Default Load
2 - Point (lb)	1 3/4" (Top)	N/A	757	980	Linked from: Grid 2.7 (D.2-D.4) Flush Beam, Support 1
3 - Point (lb)	4' 2 3/4" (Top)	N/A	757	980	Linked from: Grid 2.7 (D.2-D.4) Flush Beam, Support 2

Weyerhaeuser Notes

Weyerhaeuser warrants that the sizing of its products will be in accordance with Weyerhaeuser product design criteria and published design values. Weyerhaeuser expressly disclaims any other warranties related to the software. Use of this software is not intended to circumvent the need for a design professional as determined by the authority having jurisdiction. The designer of record, builder or framer is responsible to assure that this calculation is compatible with the overall project. Accessories (Rim Board, Blocking Panels and Squash Blocks) are not designed by this software. Products manufactured at Weyerhaeuser facilities are third-party certified to sustainable forestry standards. Weyerhaeuser Engineered Lumber Products have been evaluated by ICC-ES under evaluation reports ESR-1153 and ESR-1387 and/or tested in accordance with applicable ASTM standards. For current code evaluation reports, Weyerhaeuser product literature and installation details refer to www.eyerhaeuser.com/woodproducts/document-library.

The product application, input design loads, dimensions and support information have been provided by ForteWEB Software Operator

ForteWEB Software Operator	Job Notes
Chon Pieruccini Pieruccini Engineering (206) 949-7866 cpieru@hotmail.com	



2nd Floor Framing, Grid 5.6 (D-D.3) Flush Beam
1 piece(s) 3 1/2" x 11 7/8" 24F-V4 DF Glulam

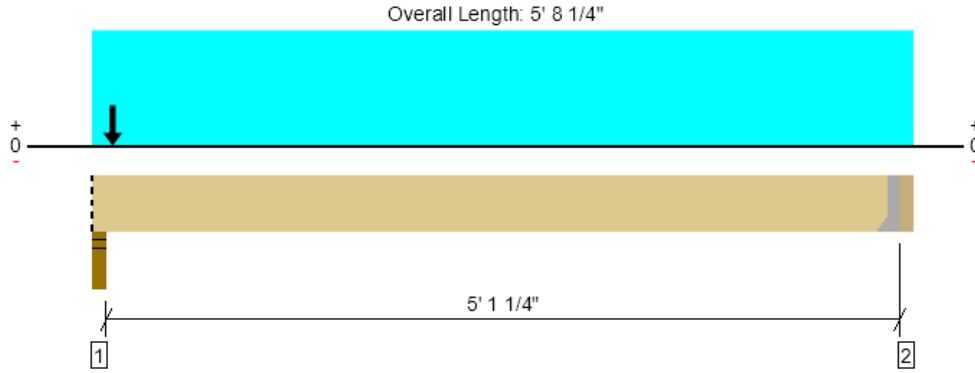

Drawing is Conceptual. All locations are measured from the outside face of left support (or left cantilever end). All dimensions are horizontal.

Design Results	Actual @ Location	Allowed	Result	LDF	Load: Combination (Pattern)
Member Reaction (lbs)	4470 @ 2"	4961 (3.50")	Passed (90%)	--	1.0 D + 1.0 L (All Spans)
Shear (lbs)	1306 @ 4' 4 7/8"	7343	Passed (18%)	1.00	1.0 D + 1.0 L (All Spans)
Pos Moment (Ft-lbs)	2746 @ 2' 9 3/8"	16452	Passed (17%)	1.00	1.0 D + 1.0 L (All Spans)
Live Load Defl. (in)	0.009 @ 2' 9 3/8"	0.131	Passed (L/999+)	--	1.0 D + 1.0 L (All Spans)
Total Load Defl. (in)	0.015 @ 2' 9 3/8"	0.261	Passed (L/999+)	--	1.0 D + 1.0 L (All Spans)

Member Length : 5' 4 3/4"
System : Floor
Member Type : Flush Beam
Building Use : Residential
Building Code : IBC 2018
Design Methodology : ASD

- Deflection criteria: LL (L/480) and TL (L/240).
- Allowed moment does not reflect the adjustment for the beam stability factor.
- Critical positive moment adjusted by a volume/size factor of 1.00 that was calculated using length L = 5' 2 3/4".
- The effects of positive or negative camber have not been accounted for when calculating deflection.
- The specified glulam is assumed to have its strong laminations at the bottom of the beam. Install with proper side up as indicated by the manufacturer.
- Applicable calculations are based on NDS.

Supports	Bearing Length			Loads to Supports (lbs)			Accessories
	Total	Available	Required	Dead	Floor Live	Factored	
1 - Stud wall - HF	3.50"	3.50"	3.15"	1948	2522	4470	Blocking
2 - Hanger on 11 7/8" LSL beam	3.50"	Hanger ¹	1.50"	1015	1318	2332	See note ¹

- Blocking Panels are assumed to carry no loads applied directly above them and the full load is applied to the member being designed.
- At hanger supports, the Total Bearing dimension is equal to the width of the material that is supporting the hanger
- ¹ See Connector grid below for additional information and/or requirements.

Lateral Bracing	Bracing Intervals	Comments
Top Edge (Lu)	5' 5" o/c	
Bottom Edge (Lu)	5' 5" o/c	

•Maximum allowable bracing intervals based on applied load.

Connector: Simpson Strong-Tie							
Support	Model	Seat Length	Top Fasteners	Face Fasteners	Member Fasteners	Accessories	
2 - Face Mount Hanger	LUS414	2.00"	N/A	10-16d	6-16d		

- Refer to manufacturer notes and instructions for proper installation and use of all connectors.

Vertical Loads	Location (Side)	Tributary Width	Dead (0.90)	Floor Live (1.00)	Comments
0 - Self Weight (PLF)	0 to 5' 4 3/4"	N/A	10.1	--	
1 - Uniform (PSF)	0 to 5' 8 1/4" (Front)	11' 4"	30.0	40.0	Default Load
2 - Point (lb)	1 3/4" (Top)	N/A	974	1261	Linked from: Grid 5.6 (D-D.3) Flush Beam, Support 1

ForteWEB Software Operator	Job Notes
Chon Pieruccioni Pieruccioni Engineering (206) 949-7866 cpieru@hotmail.com	



Weyerhaeuser Notes

Weyerhaeuser warrants that the sizing of its products will be in accordance with Weyerhaeuser product design criteria and published design values. Weyerhaeuser expressly disclaims any other warranties related to the software. Use of this software is not intended to circumvent the need for a design professional as determined by the authority having jurisdiction. The designer of record, builder or framer is responsible to assure that this calculation is compatible with the overall project. Accessories (Rim Board, Blocking Panels and Squash Blocks) are not designed by this software. Products manufactured at Weyerhaeuser facilities are third-party certified to sustainable forestry standards. Weyerhaeuser Engineered Lumber Products have been evaluated by ICC-ES under evaluation reports ESR-1153 and ESR-1387 and/or tested in accordance with applicable ASTM standards. For current code evaluation reports, Weyerhaeuser product literature and installation details refer to www.weyerhaeuser.com/woodproducts/document-library.

The product application, input design loads, dimensions and support information have been provided by ForteWEB Software Operator

ForteWEB Software Operator	Job Notes
Chon Pieruccioni Pieruccioni Engineering (206) 949-7866 cpieru@hotmail.com	



2nd Floor Framing, Grid 8.4 (D-D.3) Flush Beam
 1 piece(s) 3 1/2" x 11 7/8" 24F-V4 DF Glulam

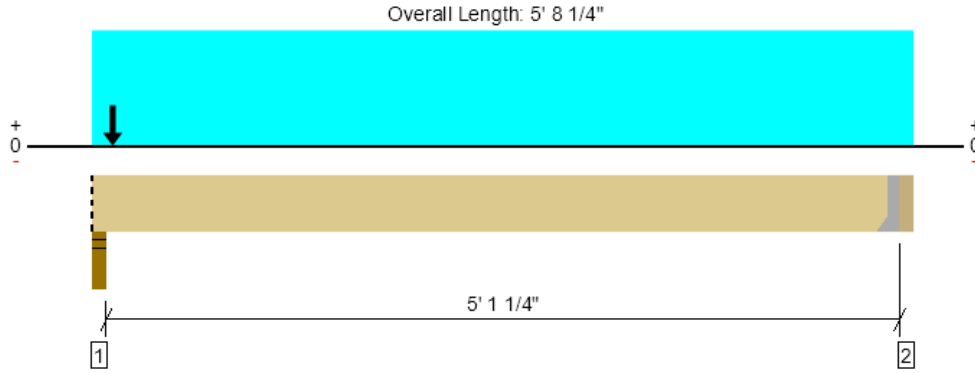

Drawing is Conceptual. All locations are measured from the outside face of left support (or left cantilever end). All dimensions are horizontal.

Design Results	Actual @ Location	Allowed	Result	LDF	Load: Combination (Pattern)
Member Reaction (lbs)	4470 @ 2"	4961 (3.50")	Passed (90%)	--	1.0 D + 1.0 L (All Spans)
Shear (lbs)	1306 @ 4' 4 7/8"	7343	Passed (18%)	1.00	1.0 D + 1.0 L (All Spans)
Pos Moment (Ft-lbs)	2746 @ 2' 9 3/8"	16452	Passed (17%)	1.00	1.0 D + 1.0 L (All Spans)
Live Load Defl. (in)	0.009 @ 2' 9 3/8"	0.131	Passed (L/999+)	--	1.0 D + 1.0 L (All Spans)
Total Load Defl. (in)	0.015 @ 2' 9 3/8"	0.261	Passed (L/999+)	--	1.0 D + 1.0 L (All Spans)

Member Length : 5' 4 3/4"
 System : Floor
 Member Type : Flush Beam
 Building Use : Residential
 Building Code : IBC 2018
 Design Methodology : ASD

- Deflection criteria: LL (L/480) and TL (L/240).
- Allowed moment does not reflect the adjustment for the beam stability factor.
- Critical positive moment adjusted by a volume/size factor of 1.00 that was calculated using length L = 5' 2 3/4".
- The effects of positive or negative camber have not been accounted for when calculating deflection.
- The specified glulam is assumed to have its strong laminations at the bottom of the beam. Install with proper side up as indicated by the manufacturer.
- Applicable calculations are based on NDS.

Supports	Bearing Length			Loads to Supports (lbs)			Accessories
	Total	Available	Required	Dead	Floor Live	Factored	
1 - Stud wall - HF	3.50"	3.50"	3.15"	1948	2522	4470	Blocking
2 - Hanger on 11 7/8" LSL beam	3.50"	Hanger ¹	1.50"	1015	1318	2332	See note ¹

- Blocking Panels are assumed to carry no loads applied directly above them and the full load is applied to the member being designed.
- At hanger supports, the Total Bearing dimension is equal to the width of the material that is supporting the hanger
- ¹ See Connector grid below for additional information and/or requirements.

Lateral Bracing	Bracing Intervals	Comments
Top Edge (Lu)	5' 5" o/c	
Bottom Edge (Lu)	5' 5" o/c	

•Maximum allowable bracing intervals based on applied load.

Connector: Simpson Strong-Tie						
Support	Model	Seat Length	Top Fasteners	Face Fasteners	Member Fasteners	Accessories
2 - Face Mount Hanger	LUS414	2.00"	N/A	10-16d	6-16d	

- Refer to manufacturer notes and instructions for proper installation and use of all connectors.

Vertical Loads	Location (Side)	Tributary Width	Dead (0.90)	Floor Live (1.00)	Comments
0 - Self Weight (PLF)	0 to 5' 4 3/4"	N/A	10.1	--	
1 - Uniform (PSF)	0 to 5' 8 1/4" (Front)	11' 4"	30.0	40.0	Default Load
2 - Point (lb)	1 3/4" (Top)	N/A	974	1261	Linked from: Grid 5.6 (D-D.3) Flush Beam, Support 1

ForteWEB Software Operator	Job Notes
Chon Pieruccioni Pieruccioni Engineering (206) 949-7866 cpieru@hotmail.com	



Weyerhaeuser Notes

Weyerhaeuser warrants that the sizing of its products will be in accordance with Weyerhaeuser product design criteria and published design values. Weyerhaeuser expressly disclaims any other warranties related to the software. Use of this software is not intended to circumvent the need for a design professional as determined by the authority having jurisdiction. The designer of record, builder or framer is responsible to assure that this calculation is compatible with the overall project. Accessories (Rim Board, Blocking Panels and Squash Blocks) are not designed by this software. Products manufactured at Weyerhaeuser facilities are third-party certified to sustainable forestry standards. Weyerhaeuser Engineered Lumber Products have been evaluated by ICC-ES under evaluation reports ESR-1153 and ESR-1387 and/or tested in accordance with applicable ASTM standards. For current code evaluation reports, Weyerhaeuser product literature and installation details refer to www.weyerhaeuser.com/woodproducts/document-library.

The product application, input design loads, dimensions and support information have been provided by ForteWEB Software Operator

ForteWEB Software Operator	Job Notes
Chon Pieruccioni Pieruccioni Engineering (206) 949-7866 cpieru@hotmail.com	



2nd Floor Framing, Grid 6 (D.5-D.6) Bedroom Door Header
1 piece(s) 4 x 8 DF No.2

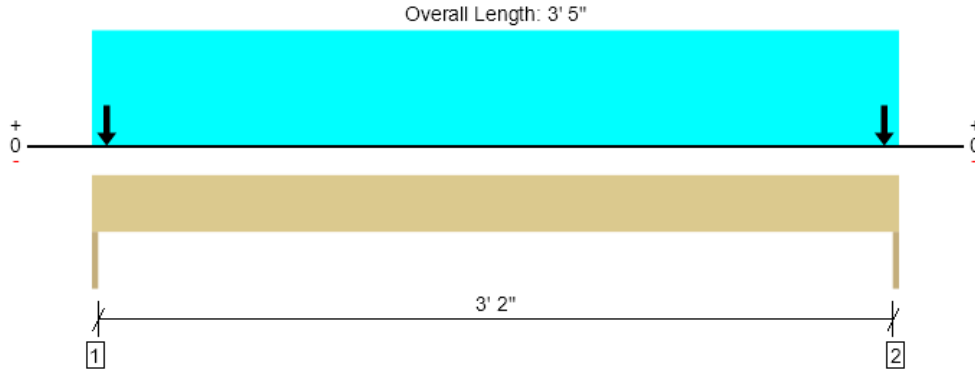

Drawing is Conceptual. All locations are measured from the outside face of left support (or left cantilever end). All dimensions are horizontal.

Design Results	Actual @ Location	Allowed	Result	LDF	Load: Combination (Pattern)
Member Reaction (lbs)	2732 @ 0	3281 (1.50")	Passed (83%)	--	1.0 D + 1.0 L (All Spans)
Shear (lbs)	783 @ 8 3/4"	3045	Passed (26%)	1.00	1.0 D + 1.0 L (All Spans)
Moment (Ft-lbs)	1167 @ 1' 8 1/2"	2989	Passed (39%)	1.00	1.0 D + 1.0 L (All Spans)
Live Load Defl. (in)	0.008 @ 1' 8 1/2"	0.114	Passed (L/999+)	--	1.0 D + 1.0 L (All Spans)
Total Load Defl. (in)	0.014 @ 1' 8 1/2"	0.171	Passed (L/999+)	--	1.0 D + 1.0 L (All Spans)

Member Length : 3' 5"
System : Wall
Member Type : Header
Building Use : Residential
Building Code : IBC 2018
Design Methodology : ASD

- Deflection criteria: LL (L/360) and TL (L/240).
- Allowed moment does not reflect the adjustment for the beam stability factor.
- Applicable calculations are based on NDS.

Supports	Bearing Length			Loads to Supports (lbs)			Accessories
	Total	Available	Required	Dead	Floor Live	Factored	
1 - Trimmer - HF	1.50"	1.50"	1.50"	1184	1548	2732	None
2 - Trimmer - HF	1.50"	1.50"	1.50"	1184	1548	2732	None

Lateral Bracing	Bracing Intervals	Comments
Top Edge (Lu)	3' 5" o/c	
Bottom Edge (Lu)	3' 5" o/c	

•Maximum allowable bracing intervals based on applied load.

Vertical Loads	Location	Tributary Width	Dead (0.90)	Floor Live (1.00)	Comments
0 - Self Weight (PLF)	0 to 3' 5"	N/A	6.4	--	
1 - Uniform (PSF)	0 to 3' 5"	11' 4"	30.0	40.0	Default Load
2 - Point (lb)	3/4"	N/A	592	774	Linked from: Grid 6 (D.5-D.6) Bedroom Door Header, Support 1
3 - Point (lb)	3' 4 1/4"	N/A	592	774	Linked from: Grid 6 (D.5-D.6) Bedroom Door Header, Support 2

Weyerhaeuser Notes

Weyerhaeuser warrants that the sizing of its products will be in accordance with Weyerhaeuser product design criteria and published design values. Weyerhaeuser expressly disclaims any other warranties related to the software. Use of this software is not intended to circumvent the need for a design professional as determined by the authority having jurisdiction. The designer of record, builder or framer is responsible to assure that this calculation is compatible with the overall project. Accessories (Rim Board, Blocking Panels and Squash Blocks) are not designed by this software. Products manufactured at Weyerhaeuser facilities are third-party certified to sustainable forestry standards. Weyerhaeuser Engineered Lumber Products have been evaluated by ICC-ES under evaluation reports ESR-1153 and ESR-1387 and/or tested in accordance with applicable ASTM standards. For current code evaluation reports, Weyerhaeuser product literature and installation details refer to www.weyerhaeuser.com/woodproducts/document-library.

The product application, input design loads, dimensions and support information have been provided by ForteWEB Software Operator

ForteWEB Software Operator	Job Notes
Chon Pieruccioni Pieruccioni Engineering (206) 949-7866 cpieru@hotmail.com	



2nd Floor Framing, Main Landing Post
1 piece(s) 6 x 10 DF No.2

Wall Height: 9'

Member Height: 8' 7 1/2"

Tributary Width: 1' 4"

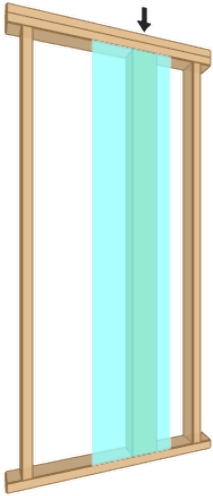

Drawing is Conceptual

Design Results	Actual	Allowed	Result	LDF	Load: Combination
Slenderness	11	50	Passed (22%)	--	--
Compression (lbs)	20238	30059	Passed (67%)	1.00	1.0 D + 1.0 L
Plate Bearing (lbs)	20238	21161	Passed (96%)	--	1.0 D + 1.0 L
Lateral Reaction (lbs)	79	--	--	1.60	1.0 D + 0.6 W
Lateral Shear (lbs)	65	9475	Passed (1%)	1.60	1.0 D + 0.6 W
Lateral Moment (ft-lbs)	171 @ mid-span	9642	Passed (2%)	1.60	1.0 D + 0.6 W
Total Deflection (in)	0.04 @ mid-span	0.86	Passed (L/2401)	--	1.0 D + 1.0 L
Bending/Compression	0.97	1	Passed (97%)	1.00	1.0 D + 1.0 L

- Lateral deflection criteria: Wind (L/120)
- Input axial load eccentricity for this design is 16.67% of applicable member side dimension.
- Applicable calculations are based on NDS.
- Bearing shall be on a metal plate or strap, or on other equivalently durable, rigid, homogeneous material with sufficient stiffness to distribute applied load.
- Special detailing and installation procedures are necessary for large wall construction.
- Lumber grading provisions must be extended over the length of the member per NDS 4.2.5.5.

Supports	Type	Material
Top	Dbl 2X	Hem Fir
Base	2X	Hem Fir

System : Wall
Member Type : Column
Building Code : IBC 2018
Design Methodology : ASD

Max Unbraced Length	Comments
1'	

Lateral Connections				
Supports	Connector	Type/Model	Quantity	Connector Nailing
Top	Nails	8d (0.113" x 2 1/2") (Toe)	2	N/A
Base	Nails	8d (0.113" x 2 1/2") (Toe)	2	N/A

- Nailed connection at the top of the member is assumed to be nailed through the bottom 2x plate prior to placement of the top 2x of the double top plate assembly.

Vertical Loads	Tributary Width	Dead (0.90)	Floor Live (1.00)	Comments
1 - Point (lb)	N/A	3004	9192	Linked from: Top Landing Beam, Support 2
2 - Point (lb)	N/A	1975	6067	Linked from: Top Landing Beam, Support 1

Lateral Load	Location	Tributary Width	Wind (1.60)	Comments
1 - Uniform (PSF)	Full Length	1' 4"	22.9	

- ASCE/SEI 7 Sec. 30.4: Exposure Category (B), Mean Roof Height (33'), Topographic Factor (1.0), Wind Directionality Factor (0.85), Basic Wind Speed (110), Risk Category(II), Effective Wind Area determined using full member span and trib. width.
- IBC Table 1604.3, footnote f: Deflection checks are performed using 42% of this lateral wind load.

Weyerhaeuser Notes

Weyerhaeuser warrants that the sizing of its products will be in accordance with Weyerhaeuser product design criteria and published design values. Weyerhaeuser expressly disclaims any other warranties related to the software. Use of this software is not intended to circumvent the need for a design professional as determined by the authority having jurisdiction. The designer of record, builder or framer is responsible to assure that this calculation is compatible with the overall project. Accessories (Rim Board, Blocking Panels and Squash Blocks) are not designed by this software. Products manufactured at Weyerhaeuser facilities are third-party certified to sustainable forestry standards. Weyerhaeuser Engineered Lumber Products have been evaluated by ICC-ES under evaluation reports ESR-1153 and ESR-1387 and/or tested in accordance with applicable ASTM standards. For current code evaluation reports, Weyerhaeuser product literature and installation details refer to www.weyerhaeuser.com/woodproducts/document-library.

The product application, input design loads, dimensions and support information have been provided by ForteWEB Software Operator

ForteWEB Software Operator	Job Notes
Chon Pieruccioni Pieruccioni Engineering (206) 949-7866 cpieru@hotmail.com	



2nd Floor Framing, Grid 6.2B.6 Post
1 piece(s) 4 x 6 DF No.2

Wall Height: 9'

Member Height: 8' 7 1/2"

Tributary Width: 0

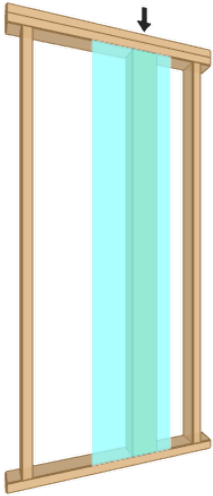

Drawing is Conceptual

Design Results	Actual	Allowed	Result	LDF	Load: Combination
Slenderness	19	50	Passed (38%)	--	--
Compression (lbs)	6274	18757	Passed (33%)	1.00	1.0 D + 1.0 L
Plate Bearing (lbs)	6274	7796	Passed (80%)	--	1.0 D + 1.0 L
Lateral Reaction (lbs)	0	--	--	--	N/A
Lateral Shear (lbs)	0	N/A	Passed (N/A)	--	N/A
Lateral Moment (ft-lbs)	0 @ mid-span	N/A	Passed (N/A)	--	N/A
Total Deflection (in)	0.00 @ mid-span	N/A	Passed (N/A)	--	N/A
Bending/Compression	N/A	1	Passed (N/A)	--	N/A

- Lateral deflection criteria: Wind (L/180)
- Input axial load eccentricity for the design is zero
- Applicable calculations are based on NDS.
- Bearing shall be on a metal plate or strap, or on other equivalently durable, rigid, homogeneous material with sufficient stiffness to distribute applied load.

Supports	Type	Material
Top	Dbl 2X	Hem Fir
Base	2X	Hem Fir

System : Wall
Member Type : Column
Building Code : IBC 2018
Design Methodology : ASD

Max Unbraced Length	Comments
1'	

Lateral Connections				
Supports	Connector	Type/Model	Quantity	Connector Nailing
Top	Nails	8d (0.113" x 2 1/2") (Toe)	2	N/A
Base	Nails	8d (0.113" x 2 1/2") (Toe)	2	N/A

- Nailed connection at the top of the member is assumed to be nailed through the bottom 2x plate prior to placement of the top 2x of the double top plate assembly.

Vertical Load	Tributary Width	Dead (0.90)	Floor Live (1.00)	Comments
1 - Point (lb)	N/A	2740	3534	Linked from: Grid 6.2 (B.7-C) Flush Beam, Support 2

Lateral Load	Location	Tributary Width	Wind (1.60)	Comments
1 - Uniform (PSF)	Full Length	N/A	22.9	

- ASCE/SEI 7 Sec. 30.4: Exposure Category (B), Mean Roof Height (33'), Topographic Factor (1.0), Wind Directionality Factor (0.85), Basic Wind Speed (110), Risk Category(II), Effective Wind Area determined using full member span and trib. width.
- IBC Table 1604.3, footnote f: Deflection checks are performed using 42% of this lateral wind load.

Weyerhaeuser Notes

Weyerhaeuser warrants that the sizing of its products will be in accordance with Weyerhaeuser product design criteria and published design values. Weyerhaeuser expressly disclaims any other warranties related to the software. Use of this software is not intended to circumvent the need for a design professional as determined by the authority having jurisdiction. The designer of record, builder or framer is responsible to assure that this calculation is compatible with the overall project. Accessories (Rim Board, Blocking Panels and Squash Blocks) are not designed by this software. Products manufactured at Weyerhaeuser facilities are third-party certified to sustainable forestry standards. Weyerhaeuser Engineered Lumber Products have been evaluated by ICC-ES under evaluation reports ESR-1153 and ESR-1387 and/or tested in accordance with applicable ASTM standards. For current code evaluation reports, Weyerhaeuser product literature and installation details refer to www.weyerhaeuser.com/woodproducts/document-library.

The product application, input design loads, dimensions and support information have been provided by ForteWEB Software Operator

ForteWEB Software Operator	Job Notes
Chon Pieruccioni Pieruccioni Engineering (206) 949-7866 cpieru@hotmail.com	



2nd Floor Framing, Grid 7.8B.6 Post
1 piece(s) 4 x 6 DF No.2

Wall Height: 9'

Member Height: 8' 7 1/2"

Tributary Width: 0

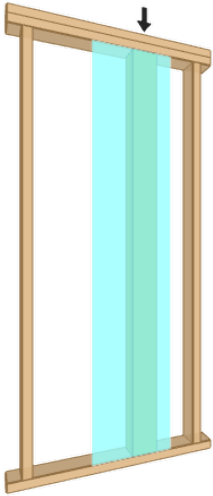

Drawing is Conceptual

Design Results	Actual	Allowed	Result	LDF	Load: Combination
Slenderness	19	50	Passed (38%)	--	--
Compression (lbs)	6274	18757	Passed (33%)	1.00	1.0 D + 1.0 L
Plate Bearing (lbs)	6274	7796	Passed (80%)	--	1.0 D + 1.0 L
Lateral Reaction (lbs)	0	--	--	--	N/A
Lateral Shear (lbs)	0	N/A	Passed (N/A)	--	N/A
Lateral Moment (ft-lbs)	0 @ mid-span	N/A	Passed (N/A)	--	N/A
Total Deflection (in)	0.00 @ mid-span	N/A	Passed (N/A)	--	N/A
Bending/Compression	N/A	1	Passed (N/A)	--	N/A

- Lateral deflection criteria: Wind (L/180)
- Input axial load eccentricity for the design is zero
- Applicable calculations are based on NDS.
- Bearing shall be on a metal plate or strap, or on other equivalently durable, rigid, homogeneous material with sufficient stiffness to distribute applied load.

Supports	Type	Material
Top	Dbl 2X	Hem Fir
Base	2X	Hem Fir

System : Wall
Member Type : Column
Building Code : IBC 2018
Design Methodology : ASD

Max Unbraced Length	Comments
1'	

Lateral Connections				
Supports	Connector	Type/Model	Quantity	Connector Nailing
Top	Nails	8d (0.113" x 2 1/2") (Toe)	2	N/A
Base	Nails	8d (0.113" x 2 1/2") (Toe)	2	N/A

- Nailed connection at the top of the member is assumed to be nailed through the bottom 2x plate prior to placement of the top 2x of the double top plate assembly.

Vertical Load	Tributary Width	Dead (0.90)	Floor Live (1.00)	Comments
1 - Point (lb)	N/A	2740	3534	Linked from: Grid 6.2 (B.7-C) Flush Beam, Support 2

Lateral Load	Location	Tributary Width	Wind (1.60)	Comments
1 - Uniform (PSF)	Full Length	N/A	22.9	

- ASCE/SEI 7 Sec. 30.4: Exposure Category (B), Mean Roof Height (33'), Topographic Factor (1.0), Wind Directionality Factor (0.85), Basic Wind Speed (110), Risk Category(II), Effective Wind Area determined using full member span and trib. width.
- IBC Table 1604.3, footnote f: Deflection checks are performed using 42% of this lateral wind load.

Weyerhaeuser Notes

Weyerhaeuser warrants that the sizing of its products will be in accordance with Weyerhaeuser product design criteria and published design values. Weyerhaeuser expressly disclaims any other warranties related to the software. Use of this software is not intended to circumvent the need for a design professional as determined by the authority having jurisdiction. The designer of record, builder or framer is responsible to assure that this calculation is compatible with the overall project. Accessories (Rim Board, Blocking Panels and Squash Blocks) are not designed by this software. Products manufactured at Weyerhaeuser facilities are third-party certified to sustainable forestry standards. Weyerhaeuser Engineered Lumber Products have been evaluated by ICC-ES under evaluation reports ESR-1153 and ESR-1387 and/or tested in accordance with applicable ASTM standards. For current code evaluation reports, Weyerhaeuser product literature and installation details refer to www.weyerhaeuser.com/woodproducts/document-library.

The product application, input design loads, dimensions and support information have been provided by ForteWEB Software Operator

ForteWEB Software Operator	Job Notes
Chon Pieruccioni Pieruccioni Engineering (206) 949-7866 cpieru@hotmail.com	



3rd Floor Framing, Floor Joist 16' and Under
1 piece(s) 11 7/8" TJI ® 110 @ 16" OC

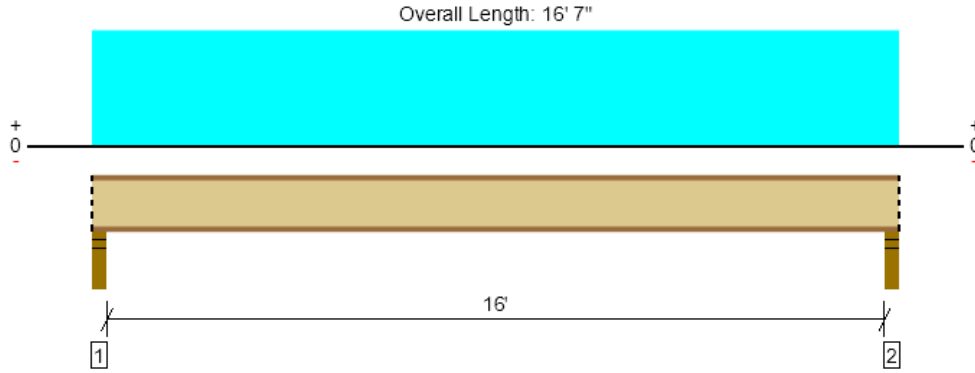

Drawing is Conceptual. All locations are measured from the outside face of left support (or left cantilever end). All dimensions are horizontal.

Design Results	Actual @ Location	Allowed	Result	LDF	Load: Combination (Pattern)
Member Reaction (lbs)	774 @ 2 1/2"	1375 (3.50")	Passed (56%)	1.00	1.0 D + 1.0 L (All Spans)
Shear (lbs)	747 @ 3 1/2"	1560	Passed (48%)	1.00	1.0 D + 1.0 L (All Spans)
Moment (Ft-lbs)	3049 @ 8' 3 1/2"	3160	Passed (96%)	1.00	1.0 D + 1.0 L (All Spans)
Live Load Defl. (in)	0.275 @ 8' 3 1/2"	0.539	Passed (L/704)	--	1.0 D + 1.0 L (All Spans)
Total Load Defl. (in)	0.482 @ 8' 3 1/2"	0.808	Passed (L/403)	--	1.0 D + 1.0 L (All Spans)
TJ-Pro™ Rating	48	40	Passed	--	--

Member Length : 16' 7"
System : Floor
Member Type : Joist
Building Use : Residential
Building Code : IBC 2018
Design Methodology : ASD

- Deflection criteria: LL (L/360) and TL (L/240).
- Allowed moment does not reflect the adjustment for the beam stability factor.
- A structural analysis of the deck has not been performed.
- Deflection analysis is based on composite action with a single layer of 23/32" Weyerhaeuser Edge™ Panel (24" Span Rating) that is glued and nailed down.
- Additional considerations for the TJ-Pro™ Rating include: 5/8" Gypsum ceiling.

Supports	Bearing Length			Loads to Supports (lbs)			Accessories
	Total	Available	Required	Dead	Floor Live	Factored	
1 - Stud wall - HF	3.50"	3.50"	1.75"	332	442	774	Blocking
2 - Stud wall - HF	3.50"	3.50"	1.75"	332	442	774	Blocking

• Blocking Panels are assumed to carry no loads applied directly above them and the full load is applied to the member being designed.

Lateral Bracing	Bracing Intervals	Comments
Top Edge (Lu)	3' 1" o/c	
Bottom Edge (Lu)	16' 7" o/c	

- TJI joists are only analyzed using Maximum Allowable bracing solutions.
- Maximum allowable bracing intervals based on applied load.

Vertical Load	Location	Spacing	Dead (0.90)	Floor Live (1.00)	Comments
1 - Uniform (PSF)	0 to 16' 7"	16"	30.0	40.0	Default Load

Weyerhaeuser Notes

Weyerhaeuser warrants that the sizing of its products will be in accordance with Weyerhaeuser product design criteria and published design values. Weyerhaeuser expressly disclaims any other warranties related to the software. Use of this software is not intended to circumvent the need for a design professional as determined by the authority having jurisdiction. The designer of record, builder or framer is responsible to assure that this calculation is compatible with the overall project. Accessories (Rim Board, Blocking Panels and Squash Blocks) are not designed by this software. Products manufactured at Weyerhaeuser facilities are third-party certified to sustainable forestry standards. Weyerhaeuser Engineered Lumber Products have been evaluated by ICC-ES under evaluation reports ESR-1153 and ESR-1387 and/or tested in accordance with applicable ASTM standards. For current code evaluation reports, Weyerhaeuser product literature and installation details refer to www.weyerhaeuser.com/woodproducts/document-library.

The product application, input design loads, dimensions and support information have been provided by ForteWEB Software Operator

ForteWEB Software Operator	Job Notes
Chon Pieruccioni Pieruccioni Engineering (206) 949-7866 cpieru@hotmail.com	



3rd Floor Framing, 8'-5" Landing Joists
1 piece(s) 2 x 12 HF No.2 @ 12" OC

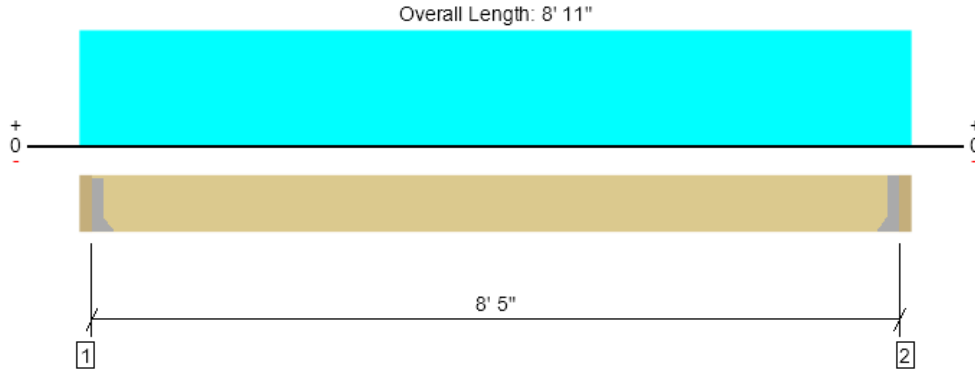

Drawing is Conceptual. All locations are measured from the outside face of left support (or left cantilever end). All dimensions are horizontal.

Design Results	Actual @ Location	Allowed	Result	LDf	Load: Combination (Pattern)
Member Reaction (lbs)	821 @ 3"	911 (1.50")	Passed (90%)	--	1.0 D + 1.0 L (All Spans)
Shear (lbs)	638 @ 1' 2 1/4"	1688	Passed (38%)	1.00	1.0 D + 1.0 L (All Spans)
Moment (Ft-lbs)	1727 @ 4' 5 1/2"	2577	Passed (67%)	1.00	1.0 D + 1.0 L (All Spans)
Live Load Defl. (in)	0.073 @ 4' 5 1/2"	0.281	Passed (L/999+)	--	1.0 D + 1.0 L (All Spans)
Total Load Defl. (in)	0.095 @ 4' 5 1/2"	0.421	Passed (L/999+)	--	1.0 D + 1.0 L (All Spans)
TJ-Pro™ Rating	N/A	N/A	N/A	--	N/A

Member Length : 8' 5"
System : Floor
Member Type : Joist
Building Use : Residential
Building Code : IBC 2018
Design Methodology : ASD

- Deflection criteria: LL (L/360) and TL (L/240).
- Allowed moment does not reflect the adjustment for the beam stability factor.
- A 15% increase in the moment capacity has been added to account for repetitive member usage.
- Applicable calculations are based on NDS.
- No composite action between deck and joist was considered in analysis.

Supports	Bearing Length			Loads to Supports (lbs)			Accessories
	Total	Available	Required	Dead	Floor Live	Factored	
1 - Hanger on 11 1/4" LSL beam	3.00"	Hanger ¹	1.50"	201	669	869	See note ¹
2 - Hanger on 11 1/4" LSL beam	3.00"	Hanger ¹	1.50"	201	669	869	See note ¹

- At hanger supports, the Total Bearing dimension is equal to the width of the material that is supporting the hanger
- ¹ See Connector grid below for additional information and/or requirements.

Lateral Bracing	Bracing Intervals	Comments
Top Edge (Lu)	6' 4" o/c	
Bottom Edge (Lu)	8' 5" o/c	

- Maximum allowable bracing intervals based on applied load.

Connector: Simpson Strong-Tie							
Support	Model	Seat Length	Top Fasteners	Face Fasteners	Member Fasteners	Accessories	
1 - Face Mount Hanger	LUS28	1.75"	N/A	6-10dx1.5	3-10d		
2 - Face Mount Hanger	LUS28	1.75"	N/A	6-10dx1.5	3-10d		

- Refer to manufacturer notes and instructions for proper installation and use of all connectors.

Vertical Load	Location (Side)	Spacing	Dead (0.90)	Floor Live (1.00)	Comments
1 - Uniform (PSF)	0 to 8' 11"	12"	45.0	150.0	Default Load

Weyerhaeuser Notes
Weyerhaeuser warrants that the sizing of its products will be in accordance with Weyerhaeuser product design criteria and published design values. Weyerhaeuser expressly disclaims any other warranties related to the software. Use of this software is not intended to circumvent the need for a design professional as determined by the authority having jurisdiction. The designer of record, builder or framer is responsible to assure that this calculation is compatible with the overall project. Accessories (Rim Board, Blocking Panels and Squash Blocks) are not designed by this software. Products manufactured at Weyerhaeuser facilities are third-party certified to sustainable forestry standards. Weyerhaeuser Engineered Lumber Products have been evaluated by ICC-ES under evaluation reports ESR-1153 and ESR-1387 and/or tested in accordance with applicable ASTM standards. For current code evaluation reports, Weyerhaeuser product literature and installation details refer to www.woyehaeuser.com/woodproducts/document-library.
The product application, input design loads, dimensions and support information have been provided by ForteWEB Software Operator

ForteWEB Software Operator	Job Notes
Chon Pieruccioni Pieruccioni Engineering (206) 949-7866 cpieru@hotmail.com	



3rd Floor Framing, Short Stair Stringers
1 piece(s) 4 x 12 HF No.2

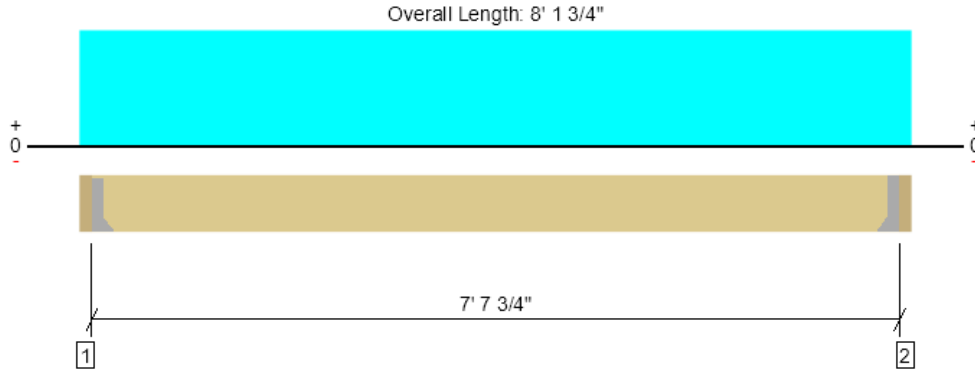

Drawing is Conceptual. All locations are measured from the outside face of left support (or left cantilever end). All dimensions are horizontal.

Design Results	Actual @ Location	Allowed	Result	LDF	Load: Combination (Pattern)
Member Reaction (lbs)	1529 @ 3"	2126 (1.50")	Passed (72%)	--	1.0 D + 1.0 L (All Spans)
Shear (lbs)	1154 @ 1' 2 1/4"	3938	Passed (29%)	1.00	1.0 D + 1.0 L (All Spans)
Moment (Ft-lbs)	2923 @ 4' 7/8"	5752	Passed (51%)	1.00	1.0 D + 1.0 L (All Spans)
Live Load Defl. (in)	0.043 @ 4' 7/8"	0.191	Passed (L/999+)	--	1.0 D + 1.0 L (All Spans)
Total Load Defl. (in)	0.057 @ 4' 7/8"	0.382	Passed (L/999+)	--	1.0 D + 1.0 L (All Spans)

Member Length : 7' 7 3/4"
System : Floor
Member Type : Flush Beam
Building Use : Residential
Building Code : IBC 2018
Design Methodology : ASD

- Deflection criteria: LL (L/480) and TL (L/240).
- Allowed moment does not reflect the adjustment for the beam stability factor.
- Applicable calculations are based on NDS.

Supports	Bearing Length			Loads to Supports (lbs)			Accessories
	Total	Available	Required	Dead	Floor Live	Factored	
1 - Hanger on 11 1/4" GLB beam	3.00"	Hanger ¹	1.50"	405	1222	1627	See note ¹
2 - Hanger on 11 1/4" GLB beam	3.00"	Hanger ¹	1.50"	405	1222	1627	See note ¹

- At hanger supports, the Total Bearing dimension is equal to the width of the material that is supporting the hanger
- ¹ See Connector grid below for additional information and/or requirements.

Lateral Bracing	Bracing Intervals	Comments
Top Edge (Lu)	7' 8" o/c	
Bottom Edge (Lu)	7' 8" o/c	

•Maximum allowable bracing intervals based on applied load.

Connector: Simpson Strong-Tie							
Support	Model	Seat Length	Top Fasteners	Face Fasteners	Member Fasteners	Accessories	
1 - Face Mount Hanger	LUS410	2.00"	N/A	8-16d	6-16d		
2 - Face Mount Hanger	LUS410	2.00"	N/A	8-16d	6-16d		

• Refer to manufacturer notes and instructions for proper installation and use of all connectors.

Vertical Loads	Location (Side)	Tributary Width	Dead (0.90)	Floor Live (1.00)	Comments
0 - Self Weight (PLF)	3" to 7' 10 3/4"	N/A	10.0	--	
1 - Uniform (PSF)	0 to 8' 1 3/4" (Front)	2'	45.0	150.0	Default Load

Weyerhaeuser Notes

Weyerhaeuser warrants that the sizing of its products will be in accordance with Weyerhaeuser product design criteria and published design values. Weyerhaeuser expressly disclaims any other warranties related to the software. Use of this software is not intended to circumvent the need for a design professional as determined by the authority having jurisdiction. The designer of record, builder or framer is responsible to assure that this calculation is compatible with the overall project. Accessories (Rim Board, Blocking Panels and Squash Blocks) are not designed by this software. Products manufactured at Weyerhaeuser facilities are third-party certified to sustainable forestry standards. Weyerhaeuser Engineered Lumber Products have been evaluated by ICC-ES under evaluation reports ESR-1153 and ESR-1387 and/or tested in accordance with applicable ASTM standards. For current code evaluation reports, Weyerhaeuser product literature and installation details refer to www.weyerhaeuser.com/woodproducts/document-library.

The product application, input design loads, dimensions and support information have been provided by ForteWEB Software Operator

ForteWEB Software Operator	Job Notes
Chon Pieruccioni Pieruccioni Engineering (206) 949-7866 cpieru@hotmail.com	



3rd Floor Framing, Top Landing Beam
1 piece(s) 5 1/2" x 12" 24F-V4 DF Glulam

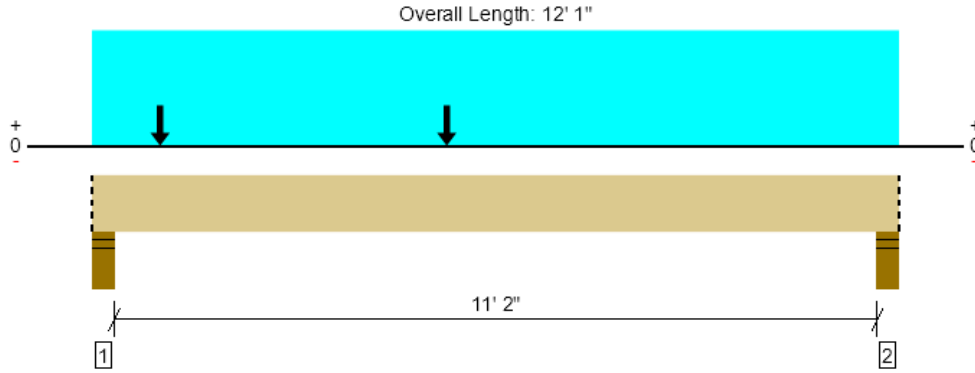

Drawing is Conceptual. All locations are measured from the outside face of left support (or left cantilever end). All dimensions are horizontal.

Design Results	Actual @ Location	Allowed	Result	LDF	Load: Combination (Pattern)
Member Reaction (lbs)	8041 @ 4"	12251 (5.50")	Passed (66%)	--	1.0 D + 1.0 L (All Spans)
Shear (lbs)	6022 @ 5' 5 1/2"	11660	Passed (52%)	1.00	1.0 D + 1.0 L (All Spans)
Pos Moment (Ft-lbs)	20040 @ 5' 3 3/4"	26400	Passed (76%)	1.00	1.0 D + 1.0 L (All Spans)
Live Load Defl. (in)	0.241 @ 5' 11 13/16"	0.285	Passed (L/569)	--	1.0 D + 1.0 L (All Spans)
Total Load Defl. (in)	0.319 @ 5' 11 3/4"	0.571	Passed (L/429)	--	1.0 D + 1.0 L (All Spans)

Member Length : 12' 1"
System : Floor
Member Type : Flush Beam
Building Use : Residential
Building Code : IBC 2018
Design Methodology : ASD

- Deflection criteria: LL (L/480) and TL (L/240).
- Allowed moment does not reflect the adjustment for the beam stability factor.
- Critical positive moment adjusted by a volume/size factor of 1.00 that was calculated using length L = 11' 5".
- The effects of positive or negative camber have not been accounted for when calculating deflection.
- The specified glulam is assumed to have its strong laminations at the bottom of the beam. Install with proper side up as indicated by the manufacturer.
- Applicable calculations are based on NDS.

Supports	Bearing Length			Loads to Supports (lbs)			Accessories
	Total	Available	Required	Dead	Floor Live	Factored	
1 - Stud wall - HF	5.50"	5.50"	3.61"	1975	6067	8041	Blocking
2 - Stud wall - HF	5.50"	5.50"	2.87"	1567	4836	6402	Blocking

• Blocking Panels are assumed to carry no loads applied directly above them and the full load is applied to the member being designed.

Lateral Bracing	Bracing Intervals	Comments
Top Edge (Lu)	12' 1" o/c	
Bottom Edge (Lu)	12' 1" o/c	

•Maximum allowable bracing intervals based on applied load.

Vertical Loads	Location (Side)	Tributary Width	Dead (0.90)	Floor Live (1.00)	Comments
0 - Self Weight (PLF)	0 to 12' 1"	N/A	16.0	--	
1 - Uniform (PSF)	0 to 12' 1" (Front)	4' 8"	45.0	150.0	Default Load
2 - Point (lb)	1' 1/4" (Front)	N/A	405	1222	Linked from: Short Stair Stringers, Support 1
3 - Point (lb)	5' 3 3/4" (Front)	N/A	405	1222	Linked from: Short Stair Stringers, Support 1

Weyerhaeuser Notes

Weyerhaeuser warrants that the sizing of its products will be in accordance with Weyerhaeuser product design criteria and published design values. Weyerhaeuser expressly disclaims any other warranties related to the software. Use of this software is not intended to circumvent the need for a design professional as determined by the authority having jurisdiction. The designer of record, builder or framer is responsible to assure that this calculation is compatible with the overall project. Accessories (Rim Board, Blocking Panels and Squash Blocks) are not designed by this software. Products manufactured at Weyerhaeuser facilities are third-party certified to sustainable forestry standards. Weyerhaeuser Engineered Lumber Products have been evaluated by ICC-ES under evaluation reports ESR-1153 and ESR-1387 and/or tested in accordance with applicable ASTM standards. For current code evaluation reports, Weyerhaeuser product literature and installation details refer to www.eyerhaeuser.com/woodproducts/document-library.

The product application, input design loads, dimensions and support information have been provided by ForteWEB Software Operator

ForteWEB Software Operator	Job Notes
Chon Pieruccioni Pieruccioni Engineering (206) 949-7866 cpieru@hotmail.com	



3rd Floor Framing, 4' Mid Landing Joists
1 piece(s) 2 x 8 HF No.2 @ 16" OC

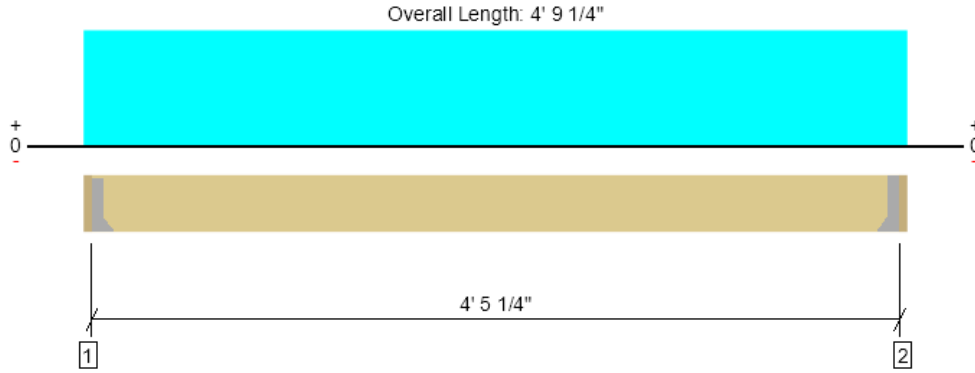

Drawing is Conceptual. All locations are measured from the outside face of left support (or left cantilever end). All dimensions are horizontal.

Design Results	Actual @ Location	Allowed	Result	LDF	Load: Combination (Pattern)
Member Reaction (lbs)	577 @ 2"	911 (1.50")	Passed (63%)	--	1.0 D + 1.0 L (All Spans)
Shear (lbs)	420 @ 9 1/4"	1088	Passed (39%)	1.00	1.0 D + 1.0 L (All Spans)
Moment (Ft-lbs)	640 @ 2' 4 5/8"	1284	Passed (50%)	1.00	1.0 D + 1.0 L (All Spans)
Live Load Defl. (in)	0.028 @ 2' 4 5/8"	0.148	Passed (L/999+)	--	1.0 D + 1.0 L (All Spans)
Total Load Defl. (in)	0.037 @ 2' 4 5/8"	0.222	Passed (L/999+)	--	1.0 D + 1.0 L (All Spans)
TJ-Pro™ Rating	N/A	N/A	N/A	--	N/A

Member Length : 4' 5 1/4"
System : Floor
Member Type : Joist
Building Use : Residential
Building Code : IBC 2018
Design Methodology : ASD

- Deflection criteria: LL (L/360) and TL (L/240).
- Allowed moment does not reflect the adjustment for the beam stability factor.
- A 15% increase in the moment capacity has been added to account for repetitive member usage.
- Applicable calculations are based on NDS.
- No composite action between deck and joist was considered in analysis.

Supports	Bearing Length			Loads to Supports (lbs)			Accessories
	Total	Available	Required	Dead	Floor Live	Factored	
1 - Hanger on 7 1/4" LSL beam	2.00"	Hanger ¹	1.50"	143	477	620	See note ¹
2 - Hanger on 7 1/4" LSL beam	2.00"	Hanger ¹	1.50"	143	477	620	See note ¹

- At hanger supports, the Total Bearing dimension is equal to the width of the material that is supporting the hanger
- ¹ See Connector grid below for additional information and/or requirements.

Lateral Bracing	Bracing Intervals	Comments
Top Edge (Lu)	4' 5" o/c	
Bottom Edge (Lu)	4' 5" o/c	

- Maximum allowable bracing intervals based on applied load.

Connector: Simpson Strong-Tie							
Support	Model	Seat Length	Top Fasteners	Face Fasteners	Member Fasteners	Accessories	
1 - Face Mount Hanger	LU26	1.50"	N/A	6-10d	4-10dx1.5		
2 - Face Mount Hanger	LU26	1.50"	N/A	6-10d	4-10dx1.5		

- Refer to manufacturer notes and instructions for proper installation and use of all connectors.

Vertical Load	Location (Side)	Spacing	Dead (0.90)	Floor Live (1.00)	Comments
1 - Uniform (PSF)	0 to 4' 9 1/4"	16"	45.0	150.0	Default Load

Weyerhaeuser Notes

Weyerhaeuser warrants that the sizing of its products will be in accordance with Weyerhaeuser product design criteria and published design values. Weyerhaeuser expressly disclaims any other warranties related to the software. Use of this software is not intended to circumvent the need for a design professional as determined by the authority having jurisdiction. The designer of record, builder or framer is responsible to assure that this calculation is compatible with the overall project. Accessories (Rim Board, Blocking Panels and Squash Blocks) are not designed by this software. Products manufactured at Weyerhaeuser facilities are third-party certified to sustainable forestry standards. Weyerhaeuser Engineered Lumber Products have been evaluated by ICC-ES under evaluation reports ESR-1153 and ESR-1387 and/or tested in accordance with applicable ASTM standards. For current code evaluation reports, Weyerhaeuser product literature and installation details refer to www.woyehaeuser.com/woodproducts/document-library.

The product application, input design loads, dimensions and support information have been provided by ForteWEB Software Operator

ForteWEB Software Operator	Job Notes
Chon Pieruccioni Pieruccioni Engineering (206) 949-7866 cpieru@hotmail.com	



3rd Floor Framing, Mid Landing Inner Beam
1 piece(s) 5 1/2" x 12" 24F-V4 DF Glulam

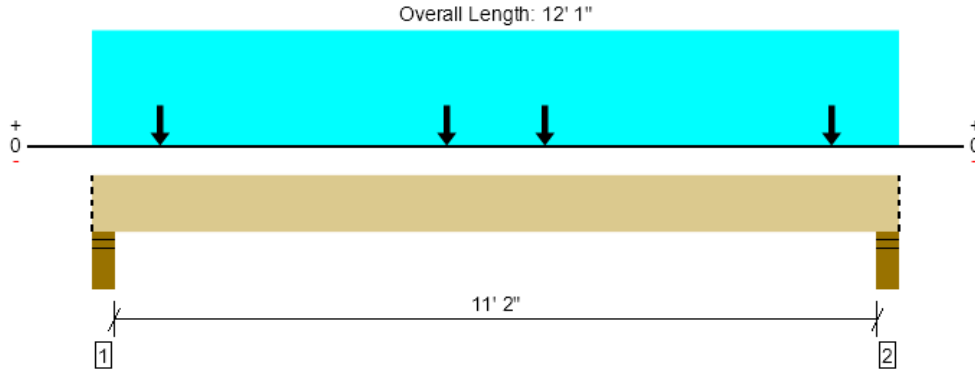

Drawing is Conceptual. All locations are measured from the outside face of left support (or left cantilever end). All dimensions are horizontal.

Design Results	Actual @ Location	Allowed	Result	LDF	Load: Combination (Pattern)
Member Reaction (lbs)	6299 @ 11' 9"	12251 (5.50")	Passed (51%)	--	1.0 D + 1.0 L (All Spans)
Shear (lbs)	4890 @ 1' 5 1/2"	11660	Passed (42%)	1.00	1.0 D + 1.0 L (All Spans)
Pos Moment (Ft-lbs)	17407 @ 6' 7/16"	26400	Passed (66%)	1.00	1.0 D + 1.0 L (All Spans)
Live Load Defl. (in)	0.207 @ 6' 1/2"	0.285	Passed (L/663)	--	1.0 D + 1.0 L (All Spans)
Total Load Defl. (in)	0.276 @ 6' 1/2"	0.571	Passed (L/496)	--	1.0 D + 1.0 L (All Spans)

Member Length : 12' 1"
System : Floor
Member Type : Flush Beam
Building Use : Residential
Building Code : IBC 2018
Design Methodology : ASD

- Deflection criteria: LL (L/480) and TL (L/240).
- Allowed moment does not reflect the adjustment for the beam stability factor.
- Critical positive moment adjusted by a volume/size factor of 1.00 that was calculated using length L = 11' 5".
- The effects of positive or negative camber have not been accounted for when calculating deflection.
- The specified glulam is assumed to have its strong laminations at the bottom of the beam. Install with proper side up as indicated by the manufacturer.
- Applicable calculations are based on NDS.

Supports	Bearing Length			Loads to Supports (lbs)			Accessories
	Total	Available	Required	Dead	Floor Live	Factored	
1 - Stud wall - HF	5.50"	5.50"	2.83"	1586	4707	6293	Blocking
2 - Stud wall - HF	5.50"	5.50"	2.83"	1587	4712	6299	Blocking

• Blocking Panels are assumed to carry no loads applied directly above them and the full load is applied to the member being designed.

Lateral Bracing	Bracing Intervals	Comments
Top Edge (Lu)	12' 1" o/c	
Bottom Edge (Lu)	12' 1" o/c	

•Maximum allowable bracing intervals based on applied load.

Vertical Loads	Location (Side)	Tributary Width	Dead (0.90)	Floor Live (1.00)	Comments
0 - Self Weight (PLF)	0 to 12' 1"	N/A	16.0	--	
1 - Uniform (PSF)	0 to 12' 1" (Front)	2' 6"	45.0	150.0	Default Load
2 - Point (lb)	1' 1/4" (Front)	N/A	405	1222	Linked from: Short Stair Stringers, Support 1
3 - Point (lb)	5' 3 3/4" (Front)	N/A	405	1222	Linked from: Short Stair Stringers, Support 1
4 - Point (lb)	6' 9 3/8" (Front)	N/A	405	1222	Linked from: Short Stair Stringers, Support 1
5 - Point (lb)	11' 7/8" (Front)	N/A	405	1222	Linked from: Short Stair Stringers, Support 1

ForteWEB Software Operator	Job Notes
Chon Pieruccioni Pieruccioni Engineering (206) 949-7866 cpieru@hotmail.com	



Weyerhaeuser Notes

Weyerhaeuser warrants that the sizing of its products will be in accordance with Weyerhaeuser product design criteria and published design values. Weyerhaeuser expressly disclaims any other warranties related to the software. Use of this software is not intended to circumvent the need for a design professional as determined by the authority having jurisdiction. The designer of record, builder or framer is responsible to assure that this calculation is compatible with the overall project. Accessories (Rim Board, Blocking Panels and Squash Blocks) are not designed by this software. Products manufactured at Weyerhaeuser facilities are third-party certified to sustainable forestry standards. Weyerhaeuser Engineered Lumber Products have been evaluated by ICC-ES under evaluation reports ESR-1153 and ESR-1387 and/or tested in accordance with applicable ASTM standards. For current code evaluation reports, Weyerhaeuser product literature and installation details refer to www.weyerhaeuser.com/woodproducts/document-library.

The product application, input design loads, dimensions and support information have been provided by ForteWEB Software Operator

ForteWEB Software Operator	Job Notes
Chon Pieruccioni Pieruccioni Engineering (206) 949-7866 cpieru@hotmail.com	



3rd Floor Framing, Mid Landing Outer Beam
1 piece(s) 3 1/2" x 10 1/2" 24F-V4 DF Glulam

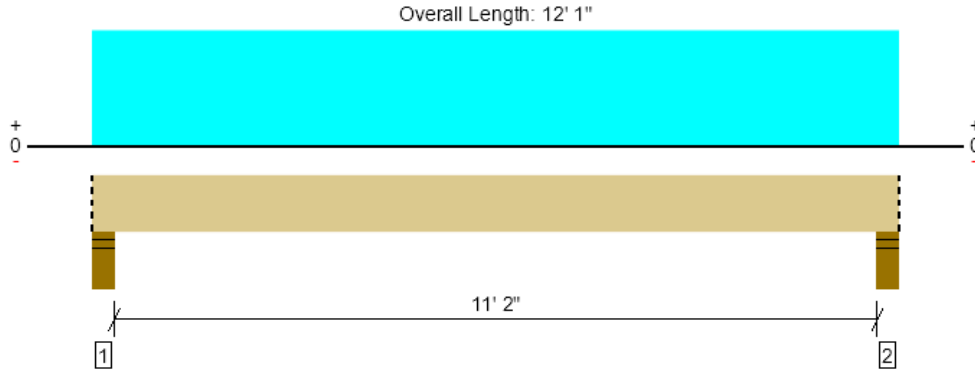

Drawing is Conceptual. All locations are measured from the outside face of left support (or left cantilever end). All dimensions are horizontal.

Design Results	Actual @ Location	Allowed	Result	LDF	Load: Combination (Pattern)
Member Reaction (lbs)	2999 @ 4"	7796 (5.50")	Passed (38%)	--	1.0 D + 1.0 L (All Spans)
Shear (lbs)	2337 @ 1' 4"	6493	Passed (36%)	1.00	1.0 D + 1.0 L (All Spans)
Pos Moment (Ft-lbs)	8088 @ 6' 1/2"	12863	Passed (63%)	1.00	1.0 D + 1.0 L (All Spans)
Live Load Defl. (in)	0.236 @ 6' 1/2"	0.285	Passed (L/581)	--	1.0 D + 1.0 L (All Spans)
Total Load Defl. (in)	0.312 @ 6' 1/2"	0.571	Passed (L/439)	--	1.0 D + 1.0 L (All Spans)

Member Length : 12' 1"
System : Floor
Member Type : Flush Beam
Building Use : Residential
Building Code : IBC 2018
Design Methodology : ASD

- Deflection criteria: LL (L/480) and TL (L/240).
- Allowed moment does not reflect the adjustment for the beam stability factor.
- Critical positive moment adjusted by a volume/size factor of 1.00 that was calculated using length L = 11' 5".
- The effects of positive or negative camber have not been accounted for when calculating deflection.
- The specified glulam is assumed to have its strong laminations at the bottom of the beam. Install with proper side up as indicated by the manufacturer.
- Applicable calculations are based on NDS.

Supports	Bearing Length			Loads to Supports (lbs)			Accessories
	Total	Available	Required	Dead	Floor Live	Factored	
1 - Stud wall - HF	5.50"	5.50"	2.12"	734	2266	2999	Blocking
2 - Stud wall - HF	5.50"	5.50"	2.12"	734	2266	2999	Blocking

- Blocking Panels are assumed to carry no loads applied directly above them and the full load is applied to the member being designed.

Lateral Bracing	Bracing Intervals	Comments
Top Edge (Lu)	12' 1" o/c	
Bottom Edge (Lu)	12' 1" o/c	

- Maximum allowable bracing intervals based on applied load.

Vertical Loads	Location (Side)	Tributary Width	Dead (0.90)	Floor Live (1.00)	Comments
0 - Self Weight (PLF)	0 to 12' 1"	N/A	8.9	--	
1 - Uniform (PSF)	0 to 12' 1" (Front)	2' 6"	45.0	150.0	Default Load

Weyerhaeuser Notes

Weyerhaeuser warrants that the sizing of its products will be in accordance with Weyerhaeuser product design criteria and published design values. Weyerhaeuser expressly disclaims any other warranties related to the software. Use of this software is not intended to circumvent the need for a design professional as determined by the authority having jurisdiction. The designer of record, builder or framer is responsible to assure that this calculation is compatible with the overall project. Accessories (Rim Board, Blocking Panels and Squash Blocks) are not designed by this software. Products manufactured at Weyerhaeuser facilities are third-party certified to sustainable forestry standards. Weyerhaeuser Engineered Lumber Products have been evaluated by ICC-ES under evaluation reports ESR-1153 and ESR-1387 and/or tested in accordance with applicable ASTM standards. For current code evaluation reports, Weyerhaeuser product literature and installation details refer to www.eyerhaeuser.com/woodproducts/document-library.

The product application, input design loads, dimensions and support information have been provided by ForteWEB Software Operator

ForteWEB Software Operator	Job Notes
Chon Pieruccioni Pieruccioni Engineering (206) 949-7866 cpieru@hotmail.com	



3rd Floor Framing, 8'-10" Deck Joist
1 piece(s) 2 x 12 HF No.2 @ 16" OC

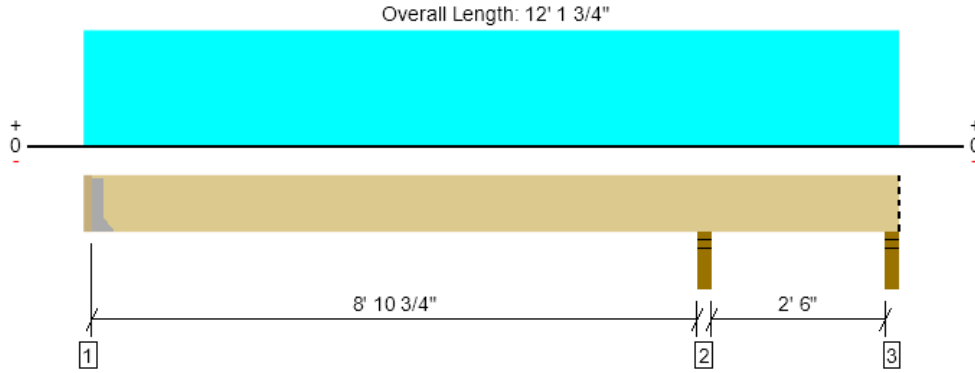

Drawing is Conceptual. All locations are measured from the outside face of left support (or left cantilever end). All dimensions are horizontal.

Design Results	Actual @ Location	Allowed	Result	LDF	Load: Combination (Pattern)
Member Reaction (lbs)	1168 @ 9' 2 1/2"	2126 (3.50")	Passed (55%)	--	1.0 D + 1.0 L (All Spans)
Shear (lbs)	520 @ 8' 1 1/2"	1688	Passed (31%)	1.00	1.0 D + 1.0 L (All Spans)
Moment (Ft-lbs)	-968 @ 9' 2 1/2"	2577	Passed (38%)	1.00	1.0 D + 1.0 L (All Spans)
Live Load Defl. (in)	0.028 @ 4' 2 7/8"	0.301	Passed (L/999+)	--	1.0 D + 1.0 L (All Spans)
Total Load Defl. (in)	0.042 @ 4' 2 3/4"	0.452	Passed (L/999+)	--	1.0 D + 1.0 L (All Spans)
TJ-Pro™ Rating	N/A	N/A	N/A	--	N/A

Member Length : 11' 11 3/4"
System : Floor
Member Type : Joist
Building Use : Residential
Building Code : IBC 2018
Design Methodology : ASD

- Deflection criteria: LL (L/360) and TL (L/240).
- Allowed moment does not reflect the adjustment for the beam stability factor.
- A 15% increase in the moment capacity has been added to account for repetitive member usage.
- -285 lbs uplift at support located at 11' 11 1/4". Strapping or other restraint may be required.
- Applicable calculations are based on NDS.
- No composite action between deck and joist was considered in analysis.

Supports	Bearing Length			Loads to Supports (lbs)			Accessories
	Total	Available	Required	Dead	Floor Live	Factored	
1 - Hanger on 11 1/4" HF beam	2.00"	Hanger ¹	1.50"	152	306	457	See note ¹
2 - Stud wall - HF	3.50"	3.50"	1.92"	389	779	1168	None
3 - Stud wall - HF	3.50"	3.50"	1.50"	-55	120/-230	64/-285	Blocking

- Blocking Panels are assumed to carry no loads applied directly above them and the full load is applied to the member being designed.
- At hanger supports, the Total Bearing dimension is equal to the width of the material that is supporting the hanger
- ¹ See Connector grid below for additional information and/or requirements.

Lateral Bracing	Bracing Intervals	Comments
Top Edge (Lu)	12' o/c	
Bottom Edge (Lu)	12' o/c	

- Maximum allowable bracing intervals based on applied load.

Connector: Simpson Strong-Tie

Support	Model	Seat Length	Top Fasteners	Face Fasteners	Member Fasteners	Accessories
1 - Face Mount Hanger	LUS28	1.75"	N/A	6-10dx1.5	3-10d	

- Refer to manufacturer notes and instructions for proper installation and use of all connectors.

Vertical Load	Location (Side)	Spacing	Dead (0.90)	Floor Live (1.00)	Comments
1 - Uniform (PSF)	0 to 12' 1 3/4"	16"	30.0	60.0	Default Load

Weyerhaeuser Notes

Weyerhaeuser warrants that the sizing of its products will be in accordance with Weyerhaeuser product design criteria and published design values. Weyerhaeuser expressly disclaims any other warranties related to the software. Use of this software is not intended to circumvent the need for a design professional as determined by the authority having jurisdiction. The designer of record, builder or framer is responsible to assure that this calculation is compatible with the overall project. Accessories (Rim Board, Blocking Panels and Squash Blocks) are not designed by this software. Products manufactured at Weyerhaeuser facilities are third-party certified to sustainable forestry standards. Weyerhaeuser Engineered Lumber Products have been evaluated by ICC-ES under evaluation reports ESR-1153 and ESR-1387 and/or tested in accordance with applicable ASTM standards. For current code evaluation reports, Weyerhaeuser product literature and installation details refer to www.woyehaeuser.com/woodproducts/document-library.

The product application, input design loads, dimensions and support information have been provided by ForteWEB Software Operator

ForteWEB Software Operator	Job Notes
Chon Pieruccioni Pieruccioni Engineering (206) 949-7866 cpieru@hotmail.com	



3rd Floor Framing, 6' Window Header
1 piece(s) 4 x 10 DF No.2

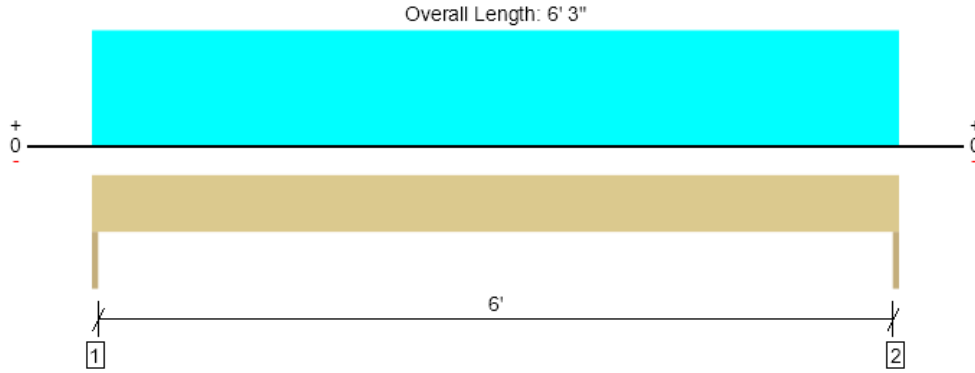

Drawing is Conceptual. All locations are measured from the outside face of left support (or left cantilever end). All dimensions are horizontal.

Design Results	Actual @ Location	Allowed	Result	LDF	Load: Combination (Pattern)
Member Reaction (lbs)	2272 @ 0	3281 (1.50")	Passed (69%)	--	1.0 D + 1.0 L (All Spans)
Shear (lbs)	1621 @ 10 3/4"	3885	Passed (42%)	1.00	1.0 D + 1.0 L (All Spans)
Moment (Ft-lbs)	3550 @ 3' 1 1/2"	4492	Passed (79%)	1.00	1.0 D + 1.0 L (All Spans)
Live Load Defl. (in)	0.031 @ 3' 1 1/2"	0.208	Passed (L/999+)	--	1.0 D + 1.0 L (All Spans)
Total Load Defl. (in)	0.068 @ 3' 1 1/2"	0.313	Passed (L/999+)	--	1.0 D + 1.0 L (All Spans)

Member Length : 6' 3"
System : Wall
Member Type : Header
Building Use : Residential
Building Code : IBC 2018
Design Methodology : ASD

- Deflection criteria: LL (L/360) and TL (L/240).
- Allowed moment does not reflect the adjustment for the beam stability factor.
- Applicable calculations are based on NDS.

Supports	Bearing Length			Loads to Supports (lbs)			Accessories
	Total	Available	Required	Dead	Floor Live	Factored	
1 - Trimmer - HF	1.50"	1.50"	1.50"	1215	1057	2272	None
2 - Trimmer - HF	1.50"	1.50"	1.50"	1215	1057	2272	None

Lateral Bracing	Bracing Intervals	Comments
Top Edge (Lu)	6' 3" o/c	
Bottom Edge (Lu)	6' 3" o/c	

•Maximum allowable bracing intervals based on applied load.

Vertical Loads	Location	Tributary Width	Dead (0.90)	Floor Live (1.00)	Comments
0 - Self Weight (PLF)	0 to 6' 3"	N/A	8.2	--	
1 - Uniform (PSF)	0 to 6' 3"	6' 7"	30.0	40.0	Floor
2 - Uniform (PLF)	0 to 6' 3"	N/A	108.0	-	Wall
3 - Uniform (PSF)	0 to 6' 3"	3'	25.0	25.0	Roof

Weyerhaeuser Notes

Weyerhaeuser warrants that the sizing of its products will be in accordance with Weyerhaeuser product design criteria and published design values. Weyerhaeuser expressly disclaims any other warranties related to the software. Use of this software is not intended to circumvent the need for a design professional as determined by the authority having jurisdiction. The designer of record, builder or framer is responsible to assure that this calculation is compatible with the overall project. Accessories (Rim Board, Blocking Panels and Squash Blocks) are not designed by this software. Products manufactured at Weyerhaeuser facilities are third-party certified to sustainable forestry standards. Weyerhaeuser Engineered Lumber Products have been evaluated by ICC-ES under evaluation reports ESR-1153 and ESR-1387 and/or tested in accordance with applicable ASTM standards. For current code evaluation reports, Weyerhaeuser product literature and installation details refer to www.weyerhaeuser.com/woodproducts/document-library.

The product application, input design loads, dimensions and support information have been provided by ForteWEB Software Operator

ForteWEB Software Operator	Job Notes
Chon Pieruccioni Pieruccioni Engineering (206) 949-7866 cpieru@hotmail.com	



3rd Floor Framing, Grid 2 (B.6-B.8) Flush Beam
 1 piece(s) 3 1/2" x 11 7/8" 24F-V4 DF Glulam

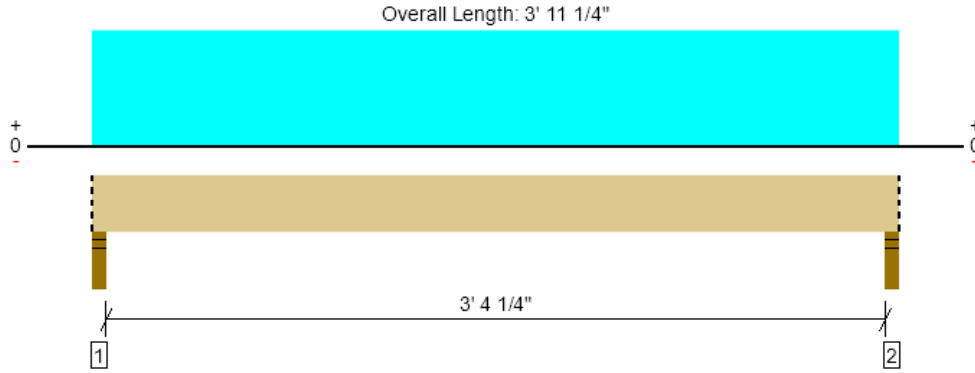

Drawing is Conceptual. All locations are measured from the outside face of left support (or left cantilever end). All dimensions are horizontal.

Design Results	Actual @ Location	Allowed	Result	LDF	Load: Combination (Pattern)
Member Reaction (lbs)	1409 @ 2"	4961 (3.50")	Passed (28%)	--	1.0 D + 1.0 L (All Spans)
Shear (lbs)	492 @ 1' 3 3/8"	7343	Passed (7%)	1.00	1.0 D + 1.0 L (All Spans)
Pos Moment (Ft-lbs)	1163 @ 1' 11 5/8"	16452	Passed (7%)	1.00	1.0 D + 1.0 L (All Spans)
Live Load Defl. (in)	0.002 @ 1' 11 5/8"	0.090	Passed (L/999+)	--	1.0 D + 1.0 L (All Spans)
Total Load Defl. (in)	0.003 @ 1' 11 5/8"	0.180	Passed (L/999+)	--	1.0 D + 1.0 L (All Spans)

Member Length : 3' 11 1/4"
 System : Floor
 Member Type : Flush Beam
 Building Use : Residential
 Building Code : IBC 2018
 Design Methodology : ASD

- Deflection criteria: LL (L/480) and TL (L/240).
- Allowed moment does not reflect the adjustment for the beam stability factor.
- Critical positive moment adjusted by a volume/size factor of 1.00 that was calculated using length L = 3' 7 1/4".
- The effects of positive or negative camber have not been accounted for when calculating deflection.
- The specified glulam is assumed to have its strong laminations at the bottom of the beam. Install with proper side up as indicated by the manufacturer.
- Applicable calculations are based on NDS.

Supports	Bearing Length			Loads to Supports (lbs)			Accessories
	Total	Available	Required	Dead	Floor Live	Factored	
1 - Stud wall - HF	3.50"	3.50"	1.50"	615	794	1409	Blocking
2 - Stud wall - HF	3.50"	3.50"	1.50"	615	794	1409	Blocking

• Blocking Panels are assumed to carry no loads applied directly above them and the full load is applied to the member being designed.

Lateral Bracing	Bracing Intervals	Comments
Top Edge (Lu)	3' 11" o/c	
Bottom Edge (Lu)	3' 11" o/c	

•Maximum allowable bracing intervals based on applied load.

Vertical Loads	Location (Side)	Tributary Width	Dead (0.90)	Floor Live (1.00)	Comments
0 - Self Weight (PLF)	0 to 3' 11 1/4"	N/A	10.1	--	
1 - Uniform (PSF)	0 to 3' 11 1/4" (Front)	10' 1"	30.0	40.0	Default Load

Weyerhaeuser Notes

Weyerhaeuser warrants that the sizing of its products will be in accordance with Weyerhaeuser product design criteria and published design values. Weyerhaeuser expressly disclaims any other warranties related to the software. Use of this software is not intended to circumvent the need for a design professional as determined by the authority having jurisdiction. The designer of record, builder or framer is responsible to assure that this calculation is compatible with the overall project. Accessories (Rim Board, Blocking Panels and Squash Blocks) are not designed by this software. Products manufactured at Weyerhaeuser facilities are third-party certified to sustainable forestry standards. Weyerhaeuser Engineered Lumber Products have been evaluated by ICC-ES under evaluation reports ESR-1153 and ESR-1387 and/or tested in accordance with applicable ASTM standards. For current code evaluation reports, Weyerhaeuser product literature and installation details refer to www.weyerhaeuser.com/woodproducts/document-library.

The product application, input design loads, dimensions and support information have been provided by ForteWEB Software Operator

ForteWEB Software Operator	Job Notes
Chon Pieruccioni Pieruccioni Engineering (206) 949-7866 cpieru@hotmail.com	



3rd Floor Framing, Grid 12 (B.6-B.8) Flush Beam
1 piece(s) 3 1/2" x 11 7/8" 24F-V4 DF Glulam

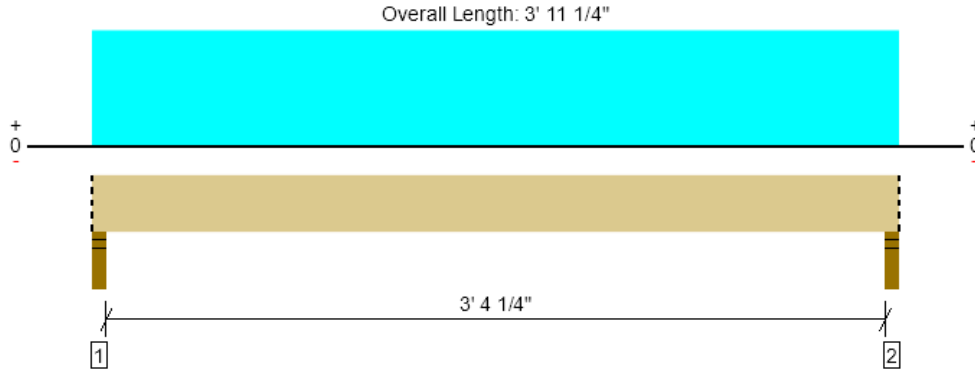

Drawing is Conceptual. All locations are measured from the outside face of left support (or left cantilever end). All dimensions are horizontal.

Design Results	Actual @ Location	Allowed	Result	LDF	Load: Combination (Pattern)
Member Reaction (lbs)	1409 @ 2"	4961 (3.50")	Passed (28%)	--	1.0 D + 1.0 L (All Spans)
Shear (lbs)	492 @ 1' 3 3/8"	7343	Passed (7%)	1.00	1.0 D + 1.0 L (All Spans)
Pos Moment (Ft-lbs)	1163 @ 1' 11 5/8"	16452	Passed (7%)	1.00	1.0 D + 1.0 L (All Spans)
Live Load Defl. (in)	0.002 @ 1' 11 5/8"	0.090	Passed (L/999+)	--	1.0 D + 1.0 L (All Spans)
Total Load Defl. (in)	0.003 @ 1' 11 5/8"	0.180	Passed (L/999+)	--	1.0 D + 1.0 L (All Spans)

Member Length : 3' 11 1/4"
System : Floor
Member Type : Flush Beam
Building Use : Residential
Building Code : IBC 2018
Design Methodology : ASD

- Deflection criteria: LL (L/480) and TL (L/240).
- Allowed moment does not reflect the adjustment for the beam stability factor.
- Critical positive moment adjusted by a volume/size factor of 1.00 that was calculated using length L = 3' 7 1/4".
- The effects of positive or negative camber have not been accounted for when calculating deflection.
- The specified glulam is assumed to have its strong laminations at the bottom of the beam. Install with proper side up as indicated by the manufacturer.
- Applicable calculations are based on NDS.

Supports	Bearing Length			Loads to Supports (lbs)			Accessories
	Total	Available	Required	Dead	Floor Live	Factored	
1 - Stud wall - HF	3.50"	3.50"	1.50"	615	794	1409	Blocking
2 - Stud wall - HF	3.50"	3.50"	1.50"	615	794	1409	Blocking

- Blocking Panels are assumed to carry no loads applied directly above them and the full load is applied to the member being designed.

Lateral Bracing	Bracing Intervals	Comments
Top Edge (Lu)	3' 11" o/c	
Bottom Edge (Lu)	3' 11" o/c	

- Maximum allowable bracing intervals based on applied load.

Vertical Loads	Location (Side)	Tributary Width	Dead (0.90)	Floor Live (1.00)	Comments
0 - Self Weight (PLF)	0 to 3' 11 1/4"	N/A	10.1	--	
1 - Uniform (PSF)	0 to 3' 11 1/4" (Front)	10' 1"	30.0	40.0	Default Load

Weyerhaeuser Notes

Weyerhaeuser warrants that the sizing of its products will be in accordance with Weyerhaeuser product design criteria and published design values. Weyerhaeuser expressly disclaims any other warranties related to the software. Use of this software is not intended to circumvent the need for a design professional as determined by the authority having jurisdiction. The designer of record, builder or framer is responsible to assure that this calculation is compatible with the overall project. Accessories (Rim Board, Blocking Panels and Squash Blocks) are not designed by this software. Products manufactured at Weyerhaeuser facilities are third-party certified to sustainable forestry standards. Weyerhaeuser Engineered Lumber Products have been evaluated by ICC-ES under evaluation reports ESR-1153 and ESR-1387 and/or tested in accordance with applicable ASTM standards. For current code evaluation reports, Weyerhaeuser product literature and installation details refer to www.weyerhaeuser.com/woodproducts/document-library.

The product application, input design loads, dimensions and support information have been provided by ForteWEB Software Operator

ForteWEB Software Operator	Job Notes
Chon Pieruccioni Pieruccioni Engineering (206) 949-7866 cpieru@hotmail.com	



3rd Floor Framing, Grid 3.1 (B.6-B.8) Flush Beam
1 piece(s) 3 1/2" x 11 7/8" 24F-V4 DF Glulam

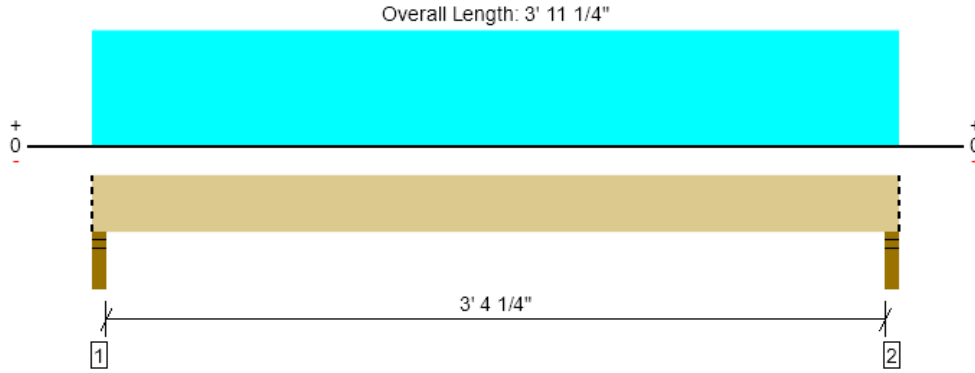

Drawing is Conceptual. All locations are measured from the outside face of left support (or left cantilever end). All dimensions are horizontal.

Design Results	Actual @ Location	Allowed	Result	LDF	Load: Combination (Pattern)
Member Reaction (lbs)	1398 @ 2"	4961 (3.50")	Passed (28%)	--	1.0 D + 1.0 L (All Spans)
Shear (lbs)	488 @ 1' 3 3/8"	7343	Passed (7%)	1.00	1.0 D + 1.0 L (All Spans)
Pos Moment (Ft-lbs)	1153 @ 1' 11 5/8"	16452	Passed (7%)	1.00	1.0 D + 1.0 L (All Spans)
Live Load Defl. (in)	0.002 @ 1' 11 5/8"	0.090	Passed (L/999+)	--	1.0 D + 1.0 L (All Spans)
Total Load Defl. (in)	0.003 @ 1' 11 5/8"	0.180	Passed (L/999+)	--	1.0 D + 1.0 L (All Spans)

Member Length : 3' 11 1/4"
System : Floor
Member Type : Flush Beam
Building Use : Residential
Building Code : IBC 2018
Design Methodology : ASD

- Deflection criteria: LL (L/480) and TL (L/240).
- Allowed moment does not reflect the adjustment for the beam stability factor.
- Critical positive moment adjusted by a volume/size factor of 1.00 that was calculated using length L = 3' 7 1/4".
- The effects of positive or negative camber have not been accounted for when calculating deflection.
- The specified glulam is assumed to have its strong laminations at the bottom of the beam. Install with proper side up as indicated by the manufacturer.
- Applicable calculations are based on NDS.

Supports	Bearing Length			Loads to Supports (lbs)			Accessories
	Total	Available	Required	Dead	Floor Live	Factored	
1 - Stud wall - HF	3.50"	3.50"	1.50"	611	788	1398	Blocking
2 - Stud wall - HF	3.50"	3.50"	1.50"	611	788	1398	Blocking

- Blocking Panels are assumed to carry no loads applied directly above them and the full load is applied to the member being designed.

Lateral Bracing	Bracing Intervals	Comments
Top Edge (Lu)	3' 11" o/c	
Bottom Edge (Lu)	3' 11" o/c	

- Maximum allowable bracing intervals based on applied load.

Vertical Loads	Location (Side)	Tributary Width	Dead (0.90)	Floor Live (1.00)	Comments
0 - Self Weight (PLF)	0 to 3' 11 1/4"	N/A	10.1	--	
1 - Uniform (PSF)	0 to 3' 11 1/4" (Front)	10'	30.0	40.0	Default Load

Weyerhaeuser Notes

Weyerhaeuser warrants that the sizing of its products will be in accordance with Weyerhaeuser product design criteria and published design values. Weyerhaeuser expressly disclaims any other warranties related to the software. Use of this software is not intended to circumvent the need for a design professional as determined by the authority having jurisdiction. The designer of record, builder or framer is responsible to assure that this calculation is compatible with the overall project. Accessories (Rim Board, Blocking Panels and Squash Blocks) are not designed by this software. Products manufactured at Weyerhaeuser facilities are third-party certified to sustainable forestry standards. Weyerhaeuser Engineered Lumber Products have been evaluated by ICC-ES under evaluation reports ESR-1153 and ESR-1387 and/or tested in accordance with applicable ASTM standards. For current code evaluation reports, Weyerhaeuser product literature and installation details refer to www.woyehaeuser.com/woodproducts/document-library.

The product application, input design loads, dimensions and support information have been provided by ForteWEB Software Operator

ForteWEB Software Operator	Job Notes
Chon Pieruccioni Pieruccioni Engineering (206) 949-7866 cpieru@hotmail.com	



3rd Floor Framing, Grid 10.9 (B.6-B.8) Flush Beam
 1 piece(s) 3 1/2" x 11 7/8" 24F-V4 DF Glulam

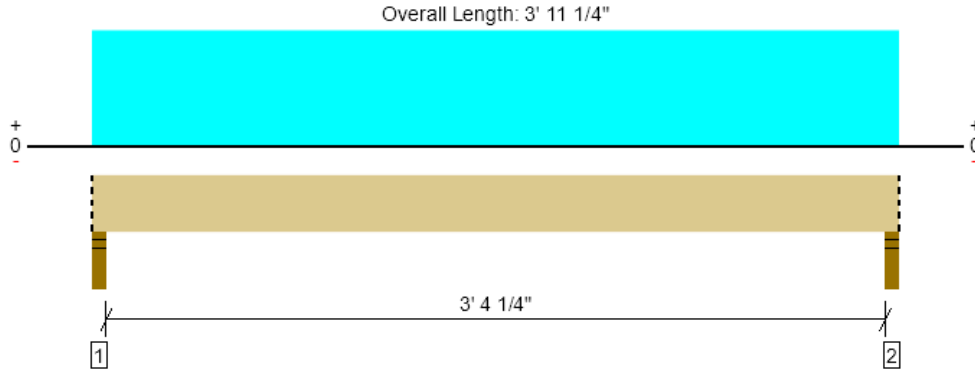

Drawing is Conceptual. All locations are measured from the outside face of left support (or left cantilever end). All dimensions are horizontal.

Design Results	Actual @ Location	Allowed	Result	LDF	Load: Combination (Pattern)
Member Reaction (lbs)	1398 @ 2"	4961 (3.50")	Passed (28%)	--	1.0 D + 1.0 L (All Spans)
Shear (lbs)	488 @ 1' 3 3/8"	7343	Passed (7%)	1.00	1.0 D + 1.0 L (All Spans)
Pos Moment (Ft-lbs)	1153 @ 1' 11 5/8"	16452	Passed (7%)	1.00	1.0 D + 1.0 L (All Spans)
Live Load Defl. (in)	0.002 @ 1' 11 5/8"	0.090	Passed (L/999+)	--	1.0 D + 1.0 L (All Spans)
Total Load Defl. (in)	0.003 @ 1' 11 5/8"	0.180	Passed (L/999+)	--	1.0 D + 1.0 L (All Spans)

Member Length : 3' 11 1/4"
 System : Floor
 Member Type : Flush Beam
 Building Use : Residential
 Building Code : IBC 2018
 Design Methodology : ASD

- Deflection criteria: LL (L/480) and TL (L/240).
- Allowed moment does not reflect the adjustment for the beam stability factor.
- Critical positive moment adjusted by a volume/size factor of 1.00 that was calculated using length L = 3' 7 1/4".
- The effects of positive or negative camber have not been accounted for when calculating deflection.
- The specified glulam is assumed to have its strong laminations at the bottom of the beam. Install with proper side up as indicated by the manufacturer.
- Applicable calculations are based on NDS.

Supports	Bearing Length			Loads to Supports (lbs)			Accessories
	Total	Available	Required	Dead	Floor Live	Factored	
1 - Stud wall - HF	3.50"	3.50"	1.50"	611	788	1398	Blocking
2 - Stud wall - HF	3.50"	3.50"	1.50"	611	788	1398	Blocking

- Blocking Panels are assumed to carry no loads applied directly above them and the full load is applied to the member being designed.

Lateral Bracing	Bracing Intervals	Comments
Top Edge (Lu)	3' 11" o/c	
Bottom Edge (Lu)	3' 11" o/c	

- Maximum allowable bracing intervals based on applied load.

Vertical Loads	Location (Side)	Tributary Width	Dead (0.90)	Floor Live (1.00)	Comments
0 - Self Weight (PLF)	0 to 3' 11 1/4"	N/A	10.1	--	
1 - Uniform (PSF)	0 to 3' 11 1/4" (Front)	10'	30.0	40.0	Default Load

Weyerhaeuser Notes

Weyerhaeuser warrants that the sizing of its products will be in accordance with Weyerhaeuser product design criteria and published design values. Weyerhaeuser expressly disclaims any other warranties related to the software. Use of this software is not intended to circumvent the need for a design professional as determined by the authority having jurisdiction. The designer of record, builder or framer is responsible to assure that this calculation is compatible with the overall project. Accessories (Rim Board, Blocking Panels and Squash Blocks) are not designed by this software. Products manufactured at Weyerhaeuser facilities are third-party certified to sustainable forestry standards. Weyerhaeuser Engineered Lumber Products have been evaluated by ICC-ES under evaluation reports ESR-1153 and ESR-1387 and/or tested in accordance with applicable ASTM standards. For current code evaluation reports, Weyerhaeuser product literature and installation details refer to www.weyerhaeuser.com/woodproducts/document-library.

The product application, input design loads, dimensions and support information have been provided by ForteWEB Software Operator

ForteWEB Software Operator	Job Notes
Chon Pieruccioni Pieruccioni Engineering (206) 949-7866 cpieru@hotmail.com	



3rd Floor Framing, Grid 5.2 (B.6-B.8) Flush Beam
1 piece(s) 3 1/2" x 11 7/8" 24F-V4 DF Glulam

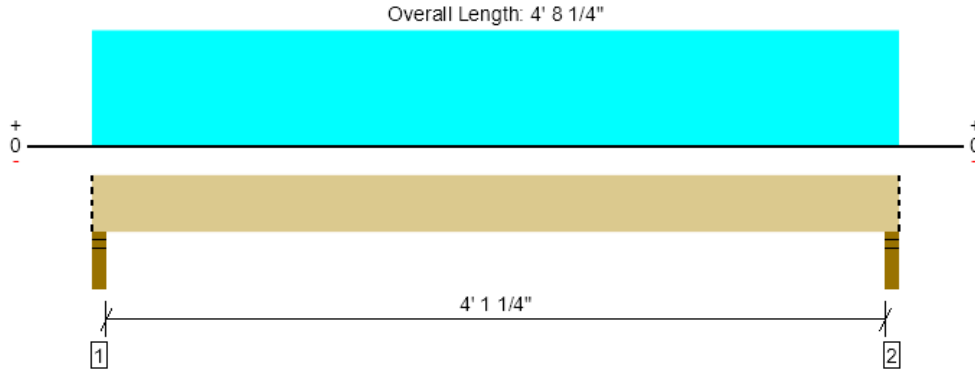

Drawing is Conceptual. All locations are measured from the outside face of left support (or left cantilever end). All dimensions are horizontal.

Design Results	Actual @ Location	Allowed	Result	LDF	Load: Combination (Pattern)
Member Reaction (lbs)	1664 @ 2"	4961 (3.50")	Passed (34%)	--	1.0 D + 1.0 L (All Spans)
Shear (lbs)	754 @ 1' 3 3/8"	7343	Passed (10%)	1.00	1.0 D + 1.0 L (All Spans)
Pos Moment (Ft-lbs)	1683 @ 2' 4 1/8"	16452	Passed (10%)	1.00	1.0 D + 1.0 L (All Spans)
Live Load Defl. (in)	0.004 @ 2' 4 1/8"	0.109	Passed (L/999+)	--	1.0 D + 1.0 L (All Spans)
Total Load Defl. (in)	0.007 @ 2' 4 1/8"	0.218	Passed (L/999+)	--	1.0 D + 1.0 L (All Spans)

Member Length : 4' 8 1/4"
System : Floor
Member Type : Flush Beam
Building Use : Residential
Building Code : IBC 2018
Design Methodology : ASD

- Deflection criteria: LL (L/480) and TL (L/240).
- Allowed moment does not reflect the adjustment for the beam stability factor.
- Critical positive moment adjusted by a volume/size factor of 1.00 that was calculated using length L = 4' 4 1/4".
- The effects of positive or negative camber have not been accounted for when calculating deflection.
- The specified glulam is assumed to have its strong laminations at the bottom of the beam. Install with proper side up as indicated by the manufacturer.
- Applicable calculations are based on NDS.

Supports	Bearing Length			Loads to Supports (lbs)			Accessories
	Total	Available	Required	Dead	Floor Live	Factored	
1 - Stud wall - HF	3.50"	3.50"	1.50"	727	938	1664	Blocking
2 - Stud wall - HF	3.50"	3.50"	1.50"	727	938	1664	Blocking

- Blocking Panels are assumed to carry no loads applied directly above them and the full load is applied to the member being designed.

Lateral Bracing	Bracing Intervals	Comments
Top Edge (Lu)	4' 8" o/c	
Bottom Edge (Lu)	4' 8" o/c	

- Maximum allowable bracing intervals based on applied load.

Vertical Loads	Location (Side)	Tributary Width	Dead (0.90)	Floor Live (1.00)	Comments
0 - Self Weight (PLF)	0 to 4' 8 1/4"	N/A	10.1	--	
1 - Uniform (PSF)	0 to 4' 8 1/4" (Front)	10'	30.0	40.0	Default Load

Weyerhaeuser Notes

Weyerhaeuser warrants that the sizing of its products will be in accordance with Weyerhaeuser product design criteria and published design values. Weyerhaeuser expressly disclaims any other warranties related to the software. Use of this software is not intended to circumvent the need for a design professional as determined by the authority having jurisdiction. The designer of record, builder or framer is responsible to assure that this calculation is compatible with the overall project. Accessories (Rim Board, Blocking Panels and Squash Blocks) are not designed by this software. Products manufactured at Weyerhaeuser facilities are third-party certified to sustainable forestry standards. Weyerhaeuser Engineered Lumber Products have been evaluated by ICC-ES under evaluation reports ESR-1153 and ESR-1387 and/or tested in accordance with applicable ASTM standards. For current code evaluation reports, Weyerhaeuser product literature and installation details refer to www.weyerhaeuser.com/woodproducts/document-library.

The product application, input design loads, dimensions and support information have been provided by ForteWEB Software Operator

ForteWEB Software Operator	Job Notes
Chon Pieruccioni Pieruccioni Engineering (206) 949-7866 cpieru@hotmail.com	



3rd Floor Framing, Grid 8.8 (B.6-B.8) Flush Beam
1 piece(s) 3 1/2" x 11 7/8" 24F-V4 DF Glulam

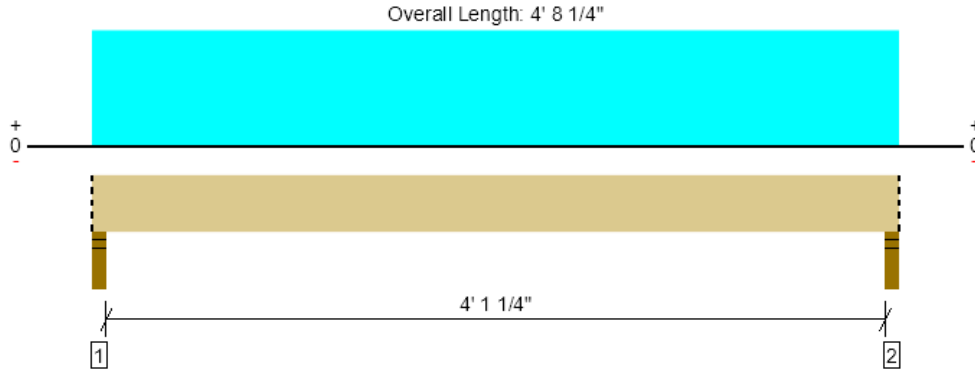

Drawing is Conceptual. All locations are measured from the outside face of left support (or left cantilever end). All dimensions are horizontal.

Design Results	Actual @ Location	Allowed	Result	LDF	Load: Combination (Pattern)
Member Reaction (lbs)	1664 @ 2"	4961 (3.50")	Passed (34%)	--	1.0 D + 1.0 L (All Spans)
Shear (lbs)	754 @ 1' 3 3/8"	7343	Passed (10%)	1.00	1.0 D + 1.0 L (All Spans)
Pos Moment (Ft-lbs)	1683 @ 2' 4 1/8"	16452	Passed (10%)	1.00	1.0 D + 1.0 L (All Spans)
Live Load Defl. (in)	0.004 @ 2' 4 1/8"	0.109	Passed (L/999+)	--	1.0 D + 1.0 L (All Spans)
Total Load Defl. (in)	0.007 @ 2' 4 1/8"	0.218	Passed (L/999+)	--	1.0 D + 1.0 L (All Spans)

Member Length : 4' 8 1/4"
System : Floor
Member Type : Flush Beam
Building Use : Residential
Building Code : IBC 2018
Design Methodology : ASD

- Deflection criteria: LL (L/480) and TL (L/240).
- Allowed moment does not reflect the adjustment for the beam stability factor.
- Critical positive moment adjusted by a volume/size factor of 1.00 that was calculated using length L = 4' 4 1/4".
- The effects of positive or negative camber have not been accounted for when calculating deflection.
- The specified glulam is assumed to have its strong laminations at the bottom of the beam. Install with proper side up as indicated by the manufacturer.
- Applicable calculations are based on NDS.

Supports	Bearing Length			Loads to Supports (lbs)			Accessories
	Total	Available	Required	Dead	Floor Live	Factored	
1 - Stud wall - HF	3.50"	3.50"	1.50"	727	938	1664	Blocking
2 - Stud wall - HF	3.50"	3.50"	1.50"	727	938	1664	Blocking

- Blocking Panels are assumed to carry no loads applied directly above them and the full load is applied to the member being designed.

Lateral Bracing	Bracing Intervals	Comments
Top Edge (Lu)	4' 8" o/c	
Bottom Edge (Lu)	4' 8" o/c	

- Maximum allowable bracing intervals based on applied load.

Vertical Loads	Location (Side)	Tributary Width	Dead (0.90)	Floor Live (1.00)	Comments
0 - Self Weight (PLF)	0 to 4' 8 1/4"	N/A	10.1	--	
1 - Uniform (PSF)	0 to 4' 8 1/4" (Front)	10'	30.0	40.0	Default Load

Weyerhaeuser Notes

Weyerhaeuser warrants that the sizing of its products will be in accordance with Weyerhaeuser product design criteria and published design values. Weyerhaeuser expressly disclaims any other warranties related to the software. Use of this software is not intended to circumvent the need for a design professional as determined by the authority having jurisdiction. The designer of record, builder or framer is responsible to assure that this calculation is compatible with the overall project. Accessories (Rim Board, Blocking Panels and Squash Blocks) are not designed by this software. Products manufactured at Weyerhaeuser facilities are third-party certified to sustainable forestry standards. Weyerhaeuser Engineered Lumber Products have been evaluated by ICC-ES under evaluation reports ESR-1153 and ESR-1387 and/or tested in accordance with applicable ASTM standards. For current code evaluation reports, Weyerhaeuser product literature and installation details refer to www.weyerhaeuser.com/woodproducts/document-library.

The product application, input design loads, dimensions and support information have been provided by ForteWEB Software Operator

ForteWEB Software Operator	Job Notes
Chon Pieruccioni Pieruccioni Engineering (206) 949-7866 cpieru@hotmail.com	



3rd Floor Framing, Grid 5.2 (B.8-B.9) Bathroom Door Header
1 piece(s) 4 x 8 DF No.2

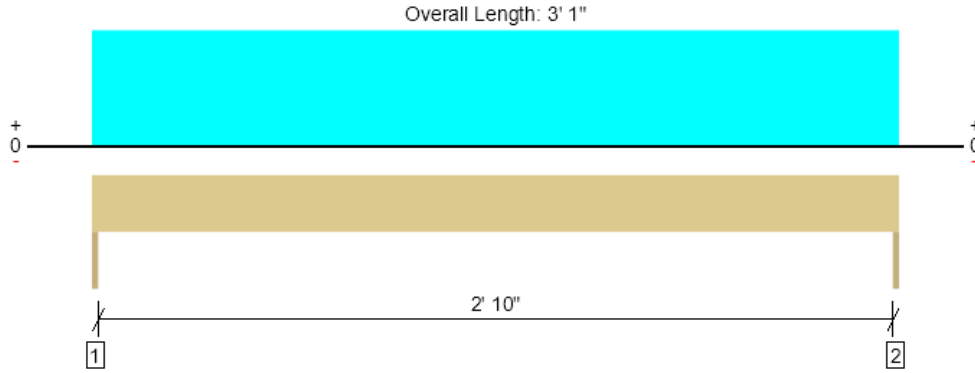

Drawing is Conceptual. All locations are measured from the outside face of left support (or left cantilever end). All dimensions are horizontal.

Design Results	Actual @ Location	Allowed	Result	LDF	Load: Combination (Pattern)
Member Reaction (lbs)	1089 @ 0	3281 (1.50")	Passed (33%)	--	1.0 D + 1.0 L (All Spans)
Shear (lbs)	574 @ 8 3/4"	3045	Passed (19%)	1.00	1.0 D + 1.0 L (All Spans)
Moment (Ft-lbs)	839 @ 1' 6 1/2"	2989	Passed (28%)	1.00	1.0 D + 1.0 L (All Spans)
Live Load Defl. (in)	0.005 @ 1' 6 1/2"	0.103	Passed (L/999+)	--	1.0 D + 1.0 L (All Spans)
Total Load Defl. (in)	0.008 @ 1' 6 1/2"	0.154	Passed (L/999+)	--	1.0 D + 1.0 L (All Spans)

Member Length : 3' 1"
System : Wall
Member Type : Header
Building Use : Residential
Building Code : IBC 2018
Design Methodology : ASD

- Deflection criteria: LL (L/360) and TL (L/240).
- Allowed moment does not reflect the adjustment for the beam stability factor.
- Applicable calculations are based on NDS.

Supports	Bearing Length			Loads to Supports (lbs)			Accessories
	Total	Available	Required	Dead	Floor Live	Factored	
1 - Trimmer - HF	1.50"	1.50"	1.50"	472	617	1089	None
2 - Trimmer - HF	1.50"	1.50"	1.50"	472	617	1089	None

Lateral Bracing	Bracing Intervals	Comments
Top Edge (Lu)	3' 1" o/c	
Bottom Edge (Lu)	3' 1" o/c	

•Maximum allowable bracing intervals based on applied load.

Vertical Loads	Location	Tributary Width	Dead (0.90)	Floor Live (1.00)	Comments
0 - Self Weight (PLF)	0 to 3' 1"	N/A	6.4	--	
1 - Uniform (PSF)	0 to 3' 1"	10'	30.0	40.0	Default Load

Weyerhaeuser Notes

Weyerhaeuser warrants that the sizing of its products will be in accordance with Weyerhaeuser product design criteria and published design values. Weyerhaeuser expressly disclaims any other warranties related to the software. Use of this software is not intended to circumvent the need for a design professional as determined by the authority having jurisdiction. The designer of record, builder or framer is responsible to assure that this calculation is compatible with the overall project. Accessories (Rim Board, Blocking Panels and Squash Blocks) are not designed by this software. Products manufactured at Weyerhaeuser facilities are third-party certified to sustainable forestry standards. Weyerhaeuser Engineered Lumber Products have been evaluated by ICC-ES under evaluation reports ESR-1153 and ESR-1387 and/or tested in accordance with applicable ASTM standards. For current code evaluation reports, Weyerhaeuser product literature and installation details refer to www.weyerhaeuser.com/woodproducts/document-library.

The product application, input design loads, dimensions and support information have been provided by ForteWEB Software Operator

ForteWEB Software Operator	Job Notes
Chon Pieruccini Pieruccini Engineering (206) 949-7866 cpieru@hotmail.com	



3rd Floor Framing, Grid 8.8 (B.8-B.9) Bathroom Door Header
1 piece(s) 4 x 8 DF No.2

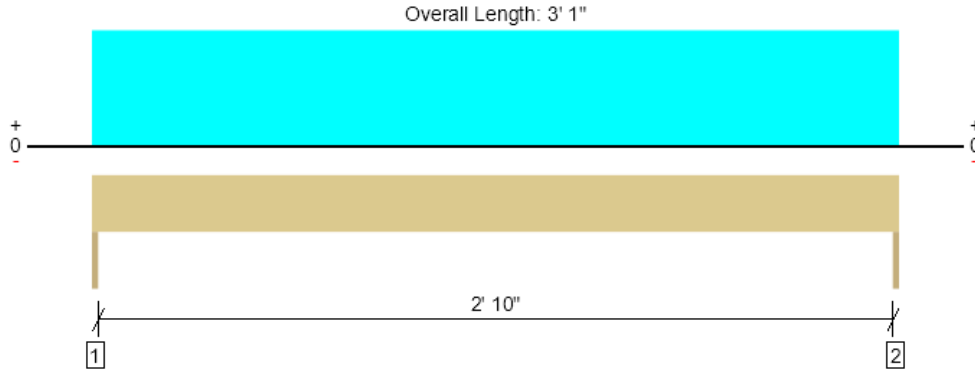

Drawing is Conceptual. All locations are measured from the outside face of left support (or left cantilever end). All dimensions are horizontal.

Design Results	Actual @ Location	Allowed	Result	LDF	Load: Combination (Pattern)
Member Reaction (lbs)	1089 @ 0	3281 (1.50")	Passed (33%)	--	1.0 D + 1.0 L (All Spans)
Shear (lbs)	574 @ 8 3/4"	3045	Passed (19%)	1.00	1.0 D + 1.0 L (All Spans)
Moment (Ft-lbs)	839 @ 1' 6 1/2"	2989	Passed (28%)	1.00	1.0 D + 1.0 L (All Spans)
Live Load Defl. (in)	0.005 @ 1' 6 1/2"	0.103	Passed (L/999+)	--	1.0 D + 1.0 L (All Spans)
Total Load Defl. (in)	0.008 @ 1' 6 1/2"	0.154	Passed (L/999+)	--	1.0 D + 1.0 L (All Spans)

Member Length : 3' 1"
System : Wall
Member Type : Header
Building Use : Residential
Building Code : IBC 2018
Design Methodology : ASD

- Deflection criteria: LL (L/360) and TL (L/240).
- Allowed moment does not reflect the adjustment for the beam stability factor.
- Applicable calculations are based on NDS.

Supports	Bearing Length			Loads to Supports (lbs)			Accessories
	Total	Available	Required	Dead	Floor Live	Factored	
1 - Trimmer - HF	1.50"	1.50"	1.50"	472	617	1089	None
2 - Trimmer - HF	1.50"	1.50"	1.50"	472	617	1089	None

Lateral Bracing	Bracing Intervals	Comments
Top Edge (Lu)	3' 1" o/c	
Bottom Edge (Lu)	3' 1" o/c	

•Maximum allowable bracing intervals based on applied load.

Vertical Loads	Location	Tributary Width	Dead (0.90)	Floor Live (1.00)	Comments
0 - Self Weight (PLF)	0 to 3' 1"	N/A	6.4	--	
1 - Uniform (PSF)	0 to 3' 1"	10'	30.0	40.0	Default Load

Weyerhaeuser Notes

Weyerhaeuser warrants that the sizing of its products will be in accordance with Weyerhaeuser product design criteria and published design values. Weyerhaeuser expressly disclaims any other warranties related to the software. Use of this software is not intended to circumvent the need for a design professional as determined by the authority having jurisdiction. The designer of record, builder or framer is responsible to assure that this calculation is compatible with the overall project. Accessories (Rim Board, Blocking Panels and Squash Blocks) are not designed by this software. Products manufactured at Weyerhaeuser facilities are third-party certified to sustainable forestry standards. Weyerhaeuser Engineered Lumber Products have been evaluated by ICC-ES under evaluation reports ESR-1153 and ESR-1387 and/or tested in accordance with applicable ASTM standards. For current code evaluation reports, Weyerhaeuser product literature and installation details refer to www.weyerhaeuser.com/woodproducts/document-library.

The product application, input design loads, dimensions and support information have been provided by ForteWEB Software Operator

ForteWEB Software Operator	Job Notes
Chon Pieruccioni Pieruccioni Engineering (206) 949-7866 cpieru@hotmail.com	



3rd Floor Framing, Grid 6.2 (B.4-B.5) Bedroom Door Header
1 piece(s) 4 x 8 DF No.2

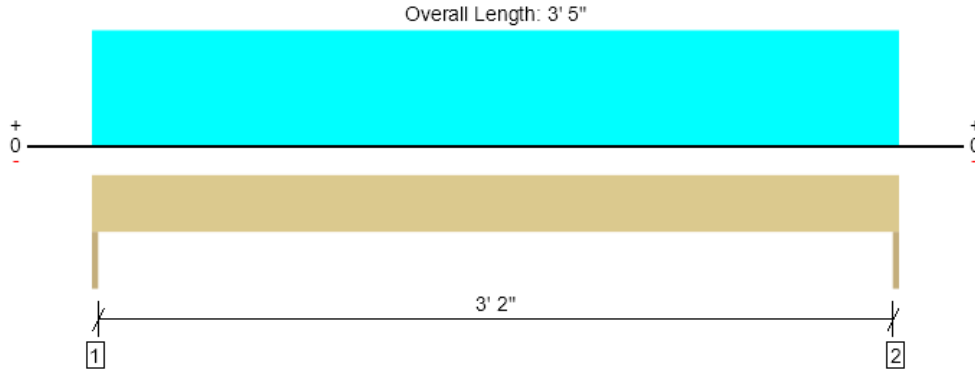

Drawing is Conceptual. All locations are measured from the outside face of left support (or left cantilever end). All dimensions are horizontal.

Design Results	Actual @ Location	Allowed	Result	LDF	Load: Combination (Pattern)
Member Reaction (lbs)	1207 @ 0	3281 (1.50")	Passed (37%)	--	1.0 D + 1.0 L (All Spans)
Shear (lbs)	692 @ 8 3/4"	3045	Passed (23%)	1.00	1.0 D + 1.0 L (All Spans)
Moment (Ft-lbs)	1031 @ 1' 8 1/2"	2989	Passed (34%)	1.00	1.0 D + 1.0 L (All Spans)
Live Load Defl. (in)	0.007 @ 1' 8 1/2"	0.114	Passed (L/999+)	--	1.0 D + 1.0 L (All Spans)
Total Load Defl. (in)	0.012 @ 1' 8 1/2"	0.171	Passed (L/999+)	--	1.0 D + 1.0 L (All Spans)

Member Length : 3' 5"
System : Wall
Member Type : Header
Building Use : Residential
Building Code : IBC 2018
Design Methodology : ASD

- Deflection criteria: LL (L/360) and TL (L/240).
- Allowed moment does not reflect the adjustment for the beam stability factor.
- Applicable calculations are based on NDS.

Supports	Bearing Length			Loads to Supports (lbs)			Accessories
	Total	Available	Required	Dead	Floor Live	Factored	
1 - Trimmer - HF	1.50"	1.50"	1.50"	523	683	1207	None
2 - Trimmer - HF	1.50"	1.50"	1.50"	523	683	1207	None

Lateral Bracing	Bracing Intervals	Comments
Top Edge (Lu)	3' 5" o/c	
Bottom Edge (Lu)	3' 5" o/c	

•Maximum allowable bracing intervals based on applied load.

Vertical Loads	Location	Tributary Width	Dead (0.90)	Floor Live (1.00)	Comments
0 - Self Weight (PLF)	0 to 3' 5"	N/A	6.4	--	
1 - Uniform (PSF)	0 to 3' 5"	10'	30.0	40.0	Default Load

Weyerhaeuser Notes

Weyerhaeuser warrants that the sizing of its products will be in accordance with Weyerhaeuser product design criteria and published design values. Weyerhaeuser expressly disclaims any other warranties related to the software. Use of this software is not intended to circumvent the need for a design professional as determined by the authority having jurisdiction. The designer of record, builder or framer is responsible to assure that this calculation is compatible with the overall project. Accessories (Rim Board, Blocking Panels and Squash Blocks) are not designed by this software. Products manufactured at Weyerhaeuser facilities are third-party certified to sustainable forestry standards. Weyerhaeuser Engineered Lumber Products have been evaluated by ICC-ES under evaluation reports ESR-1153 and ESR-1387 and/or tested in accordance with applicable ASTM standards. For current code evaluation reports, Weyerhaeuser product literature and installation details refer to www.weyerhaeuser.com/woodproducts/document-library.

The product application, input design loads, dimensions and support information have been provided by ForteWEB Software Operator

ForteWEB Software Operator	Job Notes
Chon Pieruccioni Pieruccioni Engineering (206) 949-7866 cpieru@hotmail.com	



3rd Floor Framing, Grid 7.8 (B.4-B.5) Bedroom Door Header
1 piece(s) 4 x 8 DF No.2

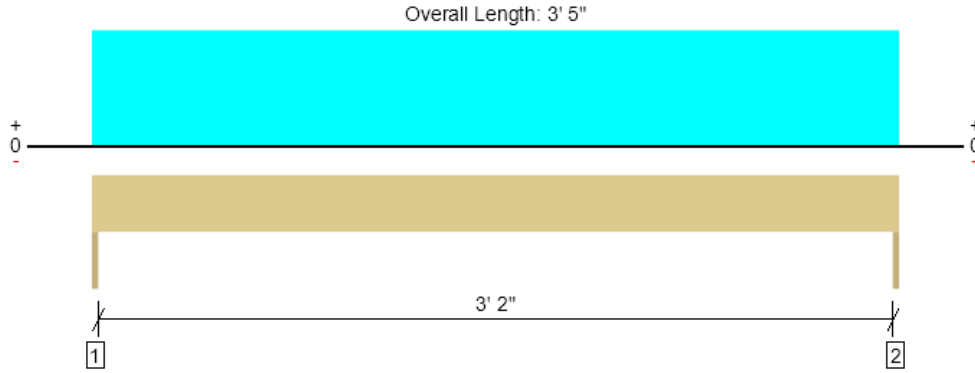

Drawing is Conceptual. All locations are measured from the outside face of left support (or left cantilever end). All dimensions are horizontal.

Design Results	Actual @ Location	Allowed	Result	LDF	Load: Combination (Pattern)
Member Reaction (lbs)	1207 @ 0	3281 (1.50")	Passed (37%)	--	1.0 D + 1.0 L (All Spans)
Shear (lbs)	692 @ 8 3/4"	3045	Passed (23%)	1.00	1.0 D + 1.0 L (All Spans)
Moment (Ft-lbs)	1031 @ 1' 8 1/2"	2989	Passed (34%)	1.00	1.0 D + 1.0 L (All Spans)
Live Load Defl. (in)	0.007 @ 1' 8 1/2"	0.114	Passed (L/999+)	--	1.0 D + 1.0 L (All Spans)
Total Load Defl. (in)	0.012 @ 1' 8 1/2"	0.171	Passed (L/999+)	--	1.0 D + 1.0 L (All Spans)

Member Length : 3' 5"
System : Wall
Member Type : Header
Building Use : Residential
Building Code : IBC 2018
Design Methodology : ASD

- Deflection criteria: LL (L/360) and TL (L/240).
- Allowed moment does not reflect the adjustment for the beam stability factor.
- Applicable calculations are based on NDS.

Supports	Bearing Length			Loads to Supports (lbs)			Accessories
	Total	Available	Required	Dead	Floor Live	Factored	
1 - Trimmer - HF	1.50"	1.50"	1.50"	523	683	1207	None
2 - Trimmer - HF	1.50"	1.50"	1.50"	523	683	1207	None

Lateral Bracing	Bracing Intervals	Comments
Top Edge (Lu)	3' 5" o/c	
Bottom Edge (Lu)	3' 5" o/c	

•Maximum allowable bracing intervals based on applied load.

Vertical Loads	Location	Tributary Width	Dead (0.90)	Floor Live (1.00)	Comments
0 - Self Weight (PLF)	0 to 3' 5"	N/A	6.4	--	
1 - Uniform (PSF)	0 to 3' 5"	10'	30.0	40.0	Default Load

Weyerhaeuser Notes

Weyerhaeuser warrants that the sizing of its products will be in accordance with Weyerhaeuser product design criteria and published design values. Weyerhaeuser expressly disclaims any other warranties related to the software. Use of this software is not intended to circumvent the need for a design professional as determined by the authority having jurisdiction. The designer of record, builder or framer is responsible to assure that this calculation is compatible with the overall project. Accessories (Rim Board, Blocking Panels and Squash Blocks) are not designed by this software. Products manufactured at Weyerhaeuser facilities are third-party certified to sustainable forestry standards. Weyerhaeuser Engineered Lumber Products have been evaluated by ICC-ES under evaluation reports ESR-1153 and ESR-1387 and/or tested in accordance with applicable ASTM standards. For current code evaluation reports, Weyerhaeuser product literature and installation details refer to www.weyerhaeuser.com/woodproducts/document-library.

The product application, input design loads, dimensions and support information have been provided by ForteWEB Software Operator

ForteWEB Software Operator	Job Notes
Chon Pieruccioni Pieruccioni Engineering (206) 949-7866 cpieru@hotmail.com	



3rd Floor Framing, Grid 6.2 (B.7-C) Flush Beam
1 piece(s) 3 1/2" x 11 7/8" 24F-V4 DF Glulam

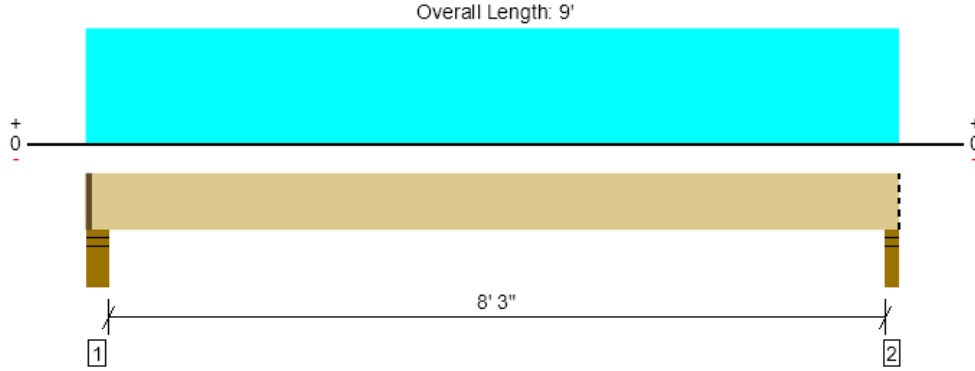

Drawing is Conceptual. All locations are measured from the outside face of left support (or left cantilever end). All dimensions are horizontal.

Design Results	Actual @ Location	Allowed	Result	LDF	Load: Combination (Pattern)
Member Reaction (lbs)	3136 @ 8' 10"	4961 (3.50")	Passed (63%)	--	1.0 D + 1.0 L (All Spans)
Shear (lbs)	2226 @ 1' 5 3/8"	7343	Passed (30%)	1.00	1.0 D + 1.0 L (All Spans)
Pos Moment (Ft-lbs)	6413 @ 4' 7"	16452	Passed (39%)	1.00	1.0 D + 1.0 L (All Spans)
Live Load Defl. (in)	0.053 @ 4' 7"	0.213	Passed (L/999+)	--	1.0 D + 1.0 L (All Spans)
Total Load Defl. (in)	0.095 @ 4' 7"	0.425	Passed (L/999+)	--	1.0 D + 1.0 L (All Spans)

Member Length : 8' 10 1/2"
System : Floor
Member Type : Flush Beam
Building Use : Residential
Building Code : IBC 2018
Design Methodology : ASD

- Deflection criteria: LL (L/480) and TL (L/240).
- Allowed moment does not reflect the adjustment for the beam stability factor.
- Critical positive moment adjusted by a volume/size factor of 1.00 that was calculated using length L = 8' 6".
- The effects of positive or negative camber have not been accounted for when calculating deflection.
- The specified glulam is assumed to have its strong laminations at the bottom of the beam. Install with proper side up as indicated by the manufacturer.
- Applicable calculations are based on NDS.

Supports	Bearing Length			Loads to Supports (lbs)			Accessories
	Total	Available	Required	Dead	Floor Live	Factored	
1 - Stud wall - HF	5.50"	4.00"	2.23"	1420	1833	3253	1 1/2" Rim Board
2 - Stud wall - HF	3.50"	3.50"	2.21"	1370	1767	3136	Blocking

- Rim Board is assumed to carry all loads applied directly above it, bypassing the member being designed.
- Blocking Panels are assumed to carry no loads applied directly above them and the full load is applied to the member being designed.

Lateral Bracing	Bracing Intervals	Comments
Top Edge (Lu)	8' 11" o/c	
Bottom Edge (Lu)	8' 11" o/c	

- Maximum allowable bracing intervals based on applied load.

Vertical Loads	Location (Side)	Tributary Width	Dead (0.90)	Floor Live (1.00)	Comments
0 - Self Weight (PLF)	1 1/2" to 9'	N/A	10.1	--	
1 - Uniform (PSF)	0 to 9' (Front)	10'	30.0	40.0	Default Load

Weyerhaeuser Notes

Weyerhaeuser warrants that the sizing of its products will be in accordance with Weyerhaeuser product design criteria and published design values. Weyerhaeuser expressly disclaims any other warranties related to the software. Use of this software is not intended to circumvent the need for a design professional as determined by the authority having jurisdiction. The designer of record, builder or framer is responsible to assure that this calculation is compatible with the overall project. Accessories (Rim Board, Blocking Panels and Squash Blocks) are not designed by this software. Products manufactured at Weyerhaeuser facilities are third-party certified to sustainable forestry standards. Weyerhaeuser Engineered Lumber Products have been evaluated by ICC-ES under evaluation reports ESR-1153 and ESR-1387 and/or tested in accordance with applicable ASTM standards. For current code evaluation reports, Weyerhaeuser product literature and installation details refer to www.eyerhaeuser.com/woodproducts/document-library.

The product application, input design loads, dimensions and support information have been provided by ForteWEB Software Operator

ForteWEB Software Operator	Job Notes
Chon Pieruccini Pieruccini Engineering (206) 949-7866 cpieru@hotmail.com	



3rd Floor Framing, Grid 7.8 (B.7-C) Flush Beam
1 piece(s) 3 1/2" x 11 7/8" 24F-V4 DF Glulam

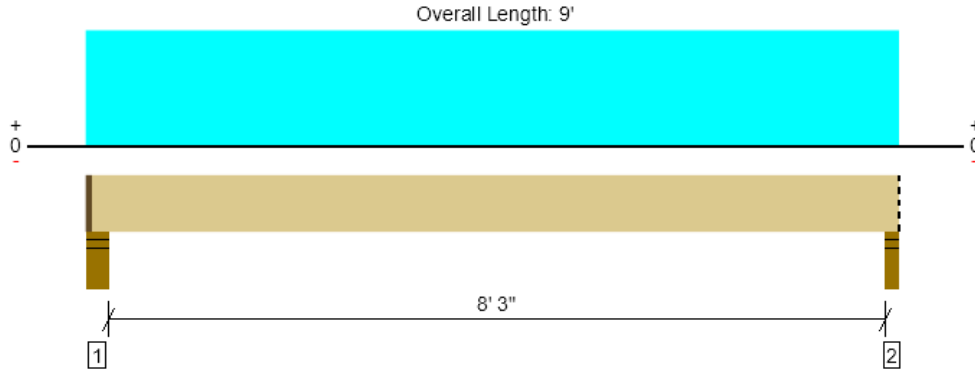

Drawing is Conceptual. All locations are measured from the outside face of left support (or left cantilever end). All dimensions are horizontal.

Design Results	Actual @ Location	Allowed	Result	LDF	Load: Combination (Pattern)
Member Reaction (lbs)	3136 @ 8' 10"	4961 (3.50")	Passed (63%)	--	1.0 D + 1.0 L (All Spans)
Shear (lbs)	2226 @ 1' 5 3/8"	7343	Passed (30%)	1.00	1.0 D + 1.0 L (All Spans)
Pos Moment (Ft-lbs)	6413 @ 4' 7"	16452	Passed (39%)	1.00	1.0 D + 1.0 L (All Spans)
Live Load Defl. (in)	0.053 @ 4' 7"	0.213	Passed (L/999+)	--	1.0 D + 1.0 L (All Spans)
Total Load Defl. (in)	0.095 @ 4' 7"	0.425	Passed (L/999+)	--	1.0 D + 1.0 L (All Spans)

Member Length : 8' 10 1/2"
System : Floor
Member Type : Flush Beam
Building Use : Residential
Building Code : IBC 2018
Design Methodology : ASD

- Deflection criteria: LL (L/480) and TL (L/240).
- Allowed moment does not reflect the adjustment for the beam stability factor.
- Critical positive moment adjusted by a volume/size factor of 1.00 that was calculated using length L = 8' 6".
- The effects of positive or negative camber have not been accounted for when calculating deflection.
- The specified glulam is assumed to have its strong laminations at the bottom of the beam. Install with proper side up as indicated by the manufacturer.
- Applicable calculations are based on NDS.

Supports	Bearing Length			Loads to Supports (lbs)			Accessories
	Total	Available	Required	Dead	Floor Live	Factored	
1 - Stud wall - HF	5.50"	4.00"	2.23"	1420	1833	3253	1 1/2" Rim Board
2 - Stud wall - HF	3.50"	3.50"	2.21"	1370	1767	3136	Blocking

- Rim Board is assumed to carry all loads applied directly above it, bypassing the member being designed.
- Blocking Panels are assumed to carry no loads applied directly above them and the full load is applied to the member being designed.

Lateral Bracing	Bracing Intervals	Comments
Top Edge (Lu)	8' 11" o/c	
Bottom Edge (Lu)	8' 11" o/c	

- Maximum allowable bracing intervals based on applied load.

Vertical Loads	Location (Side)	Tributary Width	Dead (0.90)	Floor Live (1.00)	Comments
0 - Self Weight (PLF)	1 1/2" to 9'	N/A	10.1	--	
1 - Uniform (PSF)	0 to 9' (Front)	10'	30.0	40.0	Default Load

Weyerhaeuser Notes

Weyerhaeuser warrants that the sizing of its products will be in accordance with Weyerhaeuser product design criteria and published design values. Weyerhaeuser expressly disclaims any other warranties related to the software. Use of this software is not intended to circumvent the need for a design professional as determined by the authority having jurisdiction. The designer of record, builder or framer is responsible to assure that this calculation is compatible with the overall project. Accessories (Rim Board, Blocking Panels and Squash Blocks) are not designed by this software. Products manufactured at Weyerhaeuser facilities are third-party certified to sustainable forestry standards. Weyerhaeuser Engineered Lumber Products have been evaluated by ICC-ES under evaluation reports ESR-1153 and ESR-1387 and/or tested in accordance with applicable ASTM standards. For current code evaluation reports, Weyerhaeuser product literature and installation details refer to www.eyerhaeuser.com/woodproducts/document-library.

The product application, input design loads, dimensions and support information have been provided by ForteWEB Software Operator

ForteWEB Software Operator	Job Notes
Chon Pieruccioni Pieruccioni Engineering (206) 949-7866 cpieru@hotmail.com	



3rd Floor Framing, Grid 2.3 (D-D.1) Bedroom Door Header
1 piece(s) 4 x 8 DF No.2

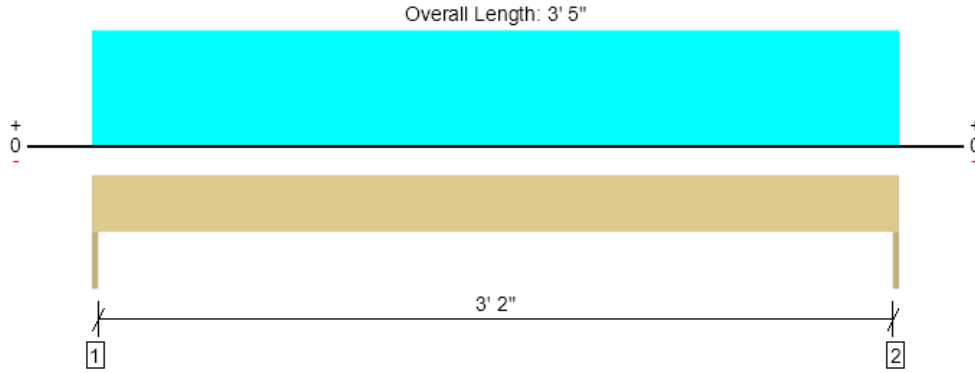

Drawing is Conceptual. All locations are measured from the outside face of left support (or left cantilever end). All dimensions are horizontal.

Design Results	Actual @ Location	Allowed	Result	LDF	Load: Combination (Pattern)
Member Reaction (lbs)	988 @ 0	3281 (1.50")	Passed (30%)	--	1.0 D + 1.0 L (All Spans)
Shear (lbs)	566 @ 8 3/4"	3045	Passed (19%)	1.00	1.0 D + 1.0 L (All Spans)
Moment (Ft-lbs)	844 @ 1' 8 1/2"	2989	Passed (28%)	1.00	1.0 D + 1.0 L (All Spans)
Live Load Defl. (in)	0.006 @ 1' 8 1/2"	0.114	Passed (L/999+)	--	1.0 D + 1.0 L (All Spans)
Total Load Defl. (in)	0.010 @ 1' 8 1/2"	0.171	Passed (L/999+)	--	1.0 D + 1.0 L (All Spans)

Member Length : 3' 5"
System : Wall
Member Type : Header
Building Use : Residential
Building Code : IBC 2018
Design Methodology : ASD

- Deflection criteria: LL (L/360) and TL (L/240).
- Allowed moment does not reflect the adjustment for the beam stability factor.
- Applicable calculations are based on NDS.

Supports	Bearing Length			Loads to Supports (lbs)			Accessories
	Total	Available	Required	Dead	Floor Live	Factored	
1 - Trimmer - HF	1.50"	1.50"	1.50"	430	558	988	None
2 - Trimmer - HF	1.50"	1.50"	1.50"	430	558	988	None

Lateral Bracing	Bracing Intervals	Comments
Top Edge (Lu)	3' 5" o/c	
Bottom Edge (Lu)	3' 5" o/c	

•Maximum allowable bracing intervals based on applied load.

Vertical Loads	Location	Tributary Width	Dead (0.90)	Floor Live (1.00)	Comments
0 - Self Weight (PLF)	0 to 3' 5"	N/A	6.4	--	
1 - Uniform (PSF)	0 to 3' 5"	8' 2"	30.0	40.0	Default Load

Weyerhaeuser Notes

Weyerhaeuser warrants that the sizing of its products will be in accordance with Weyerhaeuser product design criteria and published design values. Weyerhaeuser expressly disclaims any other warranties related to the software. Use of this software is not intended to circumvent the need for a design professional as determined by the authority having jurisdiction. The designer of record, builder or framer is responsible to assure that this calculation is compatible with the overall project. Accessories (Rim Board, Blocking Panels and Squash Blocks) are not designed by this software. Products manufactured at Weyerhaeuser facilities are third-party certified to sustainable forestry standards. Weyerhaeuser Engineered Lumber Products have been evaluated by ICC-ES under evaluation reports ESR-1153 and ESR-1387 and/or tested in accordance with applicable ASTM standards. For current code evaluation reports, Weyerhaeuser product literature and installation details refer to www.weyerhaeuser.com/woodproducts/document-library.

The product application, input design loads, dimensions and support information have been provided by ForteWEB Software Operator

ForteWEB Software Operator	Job Notes
Chon Pieruccini Pieruccini Engineering (206) 949-7866 cpieru@hotmail.com	



3rd Floor Framing, Grid 11.7 (D-D.1) Bedroom Door Header
1 piece(s) 4 x 8 DF No.2

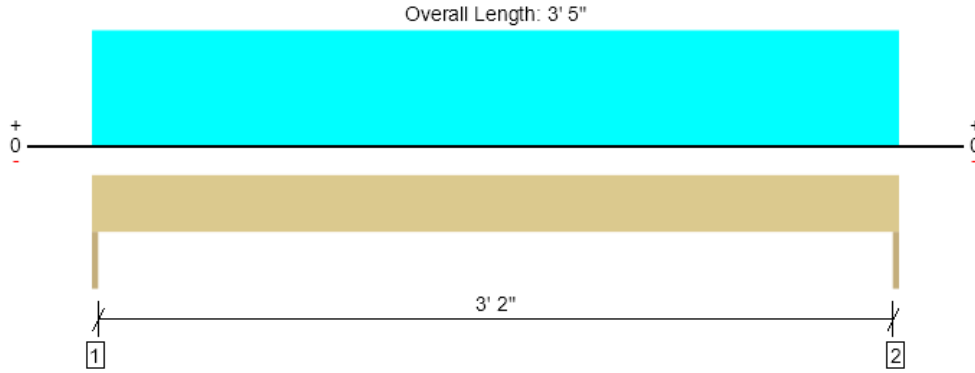

Drawing is Conceptual. All locations are measured from the outside face of left support (or left cantilever end). All dimensions are horizontal.

Design Results	Actual @ Location	Allowed	Result	LDF	Load: Combination (Pattern)
Member Reaction (lbs)	988 @ 0	3281 (1.50")	Passed (30%)	--	1.0 D + 1.0 L (All Spans)
Shear (lbs)	566 @ 8 3/4"	3045	Passed (19%)	1.00	1.0 D + 1.0 L (All Spans)
Moment (Ft-lbs)	844 @ 1' 8 1/2"	2989	Passed (28%)	1.00	1.0 D + 1.0 L (All Spans)
Live Load Defl. (in)	0.006 @ 1' 8 1/2"	0.114	Passed (L/999+)	--	1.0 D + 1.0 L (All Spans)
Total Load Defl. (in)	0.010 @ 1' 8 1/2"	0.171	Passed (L/999+)	--	1.0 D + 1.0 L (All Spans)

Member Length : 3' 5"
System : Wall
Member Type : Header
Building Use : Residential
Building Code : IBC 2018
Design Methodology : ASD

- Deflection criteria: LL (L/360) and TL (L/240).
- Allowed moment does not reflect the adjustment for the beam stability factor.
- Applicable calculations are based on NDS.

Supports	Bearing Length			Loads to Supports (lbs)			Accessories
	Total	Available	Required	Dead	Floor Live	Factored	
1 - Trimmer - HF	1.50"	1.50"	1.50"	430	558	988	None
2 - Trimmer - HF	1.50"	1.50"	1.50"	430	558	988	None

Lateral Bracing	Bracing Intervals	Comments
Top Edge (Lu)	3' 5" o/c	
Bottom Edge (Lu)	3' 5" o/c	

•Maximum allowable bracing intervals based on applied load.

Vertical Loads	Location	Tributary Width	Dead (0.90)	Floor Live (1.00)	Comments
0 - Self Weight (PLF)	0 to 3' 5"	N/A	6.4	--	
1 - Uniform (PSF)	0 to 3' 5"	8' 2"	30.0	40.0	Default Load

Weyerhaeuser Notes

Weyerhaeuser warrants that the sizing of its products will be in accordance with Weyerhaeuser product design criteria and published design values. Weyerhaeuser expressly disclaims any other warranties related to the software. Use of this software is not intended to circumvent the need for a design professional as determined by the authority having jurisdiction. The designer of record, builder or framer is responsible to assure that this calculation is compatible with the overall project. Accessories (Rim Board, Blocking Panels and Squash Blocks) are not designed by this software. Products manufactured at Weyerhaeuser facilities are third-party certified to sustainable forestry standards. Weyerhaeuser Engineered Lumber Products have been evaluated by ICC-ES under evaluation reports ESR-1153 and ESR-1387 and/or tested in accordance with applicable ASTM standards. For current code evaluation reports, Weyerhaeuser product literature and installation details refer to www.weyerhaeuser.com/woodproducts/document-library.

The product application, input design loads, dimensions and support information have been provided by ForteWEB Software Operator

ForteWEB Software Operator	Job Notes
Chon Pieruccioni Pieruccioni Engineering (206) 949-7866 cpieru@hotmail.com	



3rd Floor Framing, Grid 2.7 (D.2-D.4) Flush Beam
 1 piece(s) 3 1/2" x 11 7/8" 24F-V4 DF Glulam

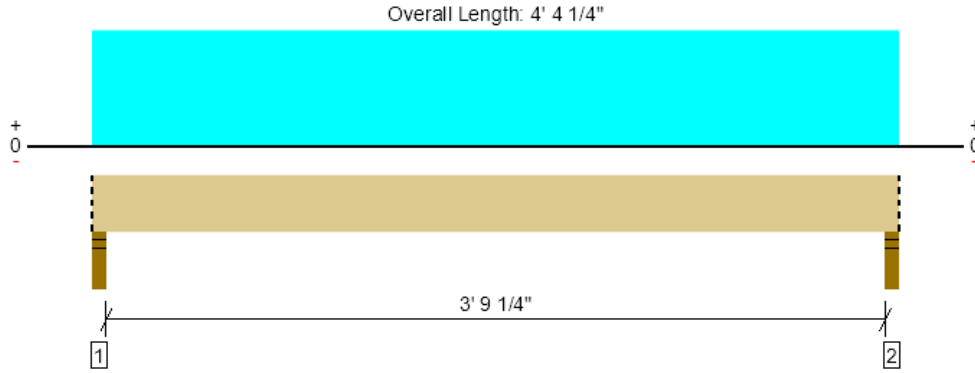

Drawing is Conceptual. All locations are measured from the outside face of left support (or left cantilever end). All dimensions are horizontal.

Design Results	Actual @ Location	Allowed	Result	LDF	Load: Combination (Pattern)
Member Reaction (lbs)	1736 @ 2"	4961 (3.50")	Passed (35%)	--	1.0 D + 1.0 L (All Spans)
Shear (lbs)	715 @ 1' 3 3/8"	7343	Passed (10%)	1.00	1.0 D + 1.0 L (All Spans)
Pos Moment (Ft-lbs)	1612 @ 2' 2 1/8"	16452	Passed (10%)	1.00	1.0 D + 1.0 L (All Spans)
Live Load Defl. (in)	0.003 @ 2' 2 1/8"	0.101	Passed (L/999+)	--	1.0 D + 1.0 L (All Spans)
Total Load Defl. (in)	0.005 @ 2' 2 1/8"	0.201	Passed (L/999+)	--	1.0 D + 1.0 L (All Spans)

Member Length : 4' 4 1/4"
 System : Floor
 Member Type : Flush Beam
 Building Use : Residential
 Building Code : IBC 2018
 Design Methodology : ASD

- Deflection criteria: LL (L/480) and TL (L/240).
- Allowed moment does not reflect the adjustment for the beam stability factor.
- Critical positive moment adjusted by a volume/size factor of 1.00 that was calculated using length L = 4' 1/4".
- The effects of positive or negative camber have not been accounted for when calculating deflection.
- The specified glulam is assumed to have its strong laminations at the bottom of the beam. Install with proper side up as indicated by the manufacturer.
- Applicable calculations are based on NDS.

Supports	Bearing Length			Loads to Supports (lbs)			Accessories
	Total	Available	Required	Dead	Floor Live	Factored	
1 - Stud wall - HF	3.50"	3.50"	1.50"	757	980	1736	Blocking
2 - Stud wall - HF	3.50"	3.50"	1.50"	757	980	1736	Blocking

- Blocking Panels are assumed to carry no loads applied directly above them and the full load is applied to the member being designed.

Lateral Bracing	Bracing Intervals	Comments
Top Edge (Lu)	4' 4" o/c	
Bottom Edge (Lu)	4' 4" o/c	

- Maximum allowable bracing intervals based on applied load.

Vertical Loads	Location (Side)	Tributary Width	Dead (0.90)	Floor Live (1.00)	Comments
0 - Self Weight (PLF)	0 to 4' 4 1/4"	N/A	10.1	--	
1 - Uniform (PSF)	0 to 4' 4 1/4" (Front)	11' 3"	30.0	40.0	Default Load

Weyerhaeuser Notes

Weyerhaeuser warrants that the sizing of its products will be in accordance with Weyerhaeuser product design criteria and published design values. Weyerhaeuser expressly disclaims any other warranties related to the software. Use of this software is not intended to circumvent the need for a design professional as determined by the authority having jurisdiction. The designer of record, builder or framer is responsible to assure that this calculation is compatible with the overall project. Accessories (Rim Board, Blocking Panels and Squash Blocks) are not designed by this software. Products manufactured at Weyerhaeuser facilities are third-party certified to sustainable forestry standards. Weyerhaeuser Engineered Lumber Products have been evaluated by ICC-ES under evaluation reports ESR-1153 and ESR-1387 and/or tested in accordance with applicable ASTM standards. For current code evaluation reports, Weyerhaeuser product literature and installation details refer to www.weyerhaeuser.com/woodproducts/document-library.

The product application, input design loads, dimensions and support information have been provided by ForteWEB Software Operator

ForteWEB Software Operator	Job Notes
Chon Pieruccioni Pieruccioni Engineering (206) 949-7866 cpieru@hotmail.com	



3rd Floor Framing, Grid 11.3 (D.2-D.4) Flush Beam
 1 piece(s) 3 1/2" x 11 7/8" 24F-V4 DF Glulam

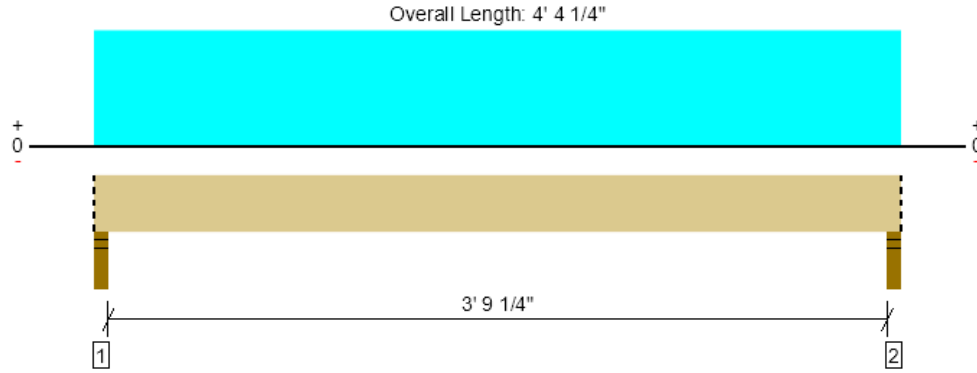

Drawing is Conceptual. All locations are measured from the outside face of left support (or left cantilever end). All dimensions are horizontal.

Design Results	Actual @ Location	Allowed	Result	LDF	Load: Combination (Pattern)
Member Reaction (lbs)	1736 @ 2"	4961 (3.50")	Passed (35%)	--	1.0 D + 1.0 L (All Spans)
Shear (lbs)	715 @ 1' 3 3/8"	7343	Passed (10%)	1.00	1.0 D + 1.0 L (All Spans)
Pos Moment (Ft-lbs)	1612 @ 2' 2 1/8"	16452	Passed (10%)	1.00	1.0 D + 1.0 L (All Spans)
Live Load Defl. (in)	0.003 @ 2' 2 1/8"	0.101	Passed (L/999+)	--	1.0 D + 1.0 L (All Spans)
Total Load Defl. (in)	0.005 @ 2' 2 1/8"	0.201	Passed (L/999+)	--	1.0 D + 1.0 L (All Spans)

Member Length : 4' 4 1/4"
 System : Floor
 Member Type : Flush Beam
 Building Use : Residential
 Building Code : IBC 2018
 Design Methodology : ASD

- Deflection criteria: LL (L/480) and TL (L/240).
- Allowed moment does not reflect the adjustment for the beam stability factor.
- Critical positive moment adjusted by a volume/size factor of 1.00 that was calculated using length L = 4' 1/4".
- The effects of positive or negative camber have not been accounted for when calculating deflection.
- The specified glulam is assumed to have its strong laminations at the bottom of the beam. Install with proper side up as indicated by the manufacturer.
- Applicable calculations are based on NDS.

Supports	Bearing Length			Loads to Supports (lbs)			Accessories
	Total	Available	Required	Dead	Floor Live	Factored	
1 - Stud wall - HF	3.50"	3.50"	1.50"	757	980	1736	Blocking
2 - Stud wall - HF	3.50"	3.50"	1.50"	757	980	1736	Blocking

- Blocking Panels are assumed to carry no loads applied directly above them and the full load is applied to the member being designed.

Lateral Bracing	Bracing Intervals	Comments
Top Edge (Lu)	4' 4" o/c	
Bottom Edge (Lu)	4' 4" o/c	

- Maximum allowable bracing intervals based on applied load.

Vertical Loads	Location (Side)	Tributary Width	Dead (0.90)	Floor Live (1.00)	Comments
0 - Self Weight (PLF)	0 to 4' 4 1/4"	N/A	10.1	--	
1 - Uniform (PSF)	0 to 4' 4 1/4" (Front)	11' 3"	30.0	40.0	Default Load

Weyerhaeuser Notes

Weyerhaeuser warrants that the sizing of its products will be in accordance with Weyerhaeuser product design criteria and published design values. Weyerhaeuser expressly disclaims any other warranties related to the software. Use of this software is not intended to circumvent the need for a design professional as determined by the authority having jurisdiction. The designer of record, builder or framer is responsible to assure that this calculation is compatible with the overall project. Accessories (Rim Board, Blocking Panels and Squash Blocks) are not designed by this software. Products manufactured at Weyerhaeuser facilities are third-party certified to sustainable forestry standards. Weyerhaeuser Engineered Lumber Products have been evaluated by ICC-ES under evaluation reports ESR-1153 and ESR-1387 and/or tested in accordance with applicable ASTM standards. For current code evaluation reports, Weyerhaeuser product literature and installation details refer to www.weyerhaeuser.com/woodproducts/document-library.

The product application, input design loads, dimensions and support information have been provided by ForteWEB Software Operator

ForteWEB Software Operator	Job Notes
Chon Pieruccioni Pieruccioni Engineering (206) 949-7866 cpieru@hotmail.com	



3rd Floor Framing, Grid 5.6 (D-D.3) Flush Beam
 1 piece(s) 3 1/2" x 11 7/8" 24F-V4 DF Glulam

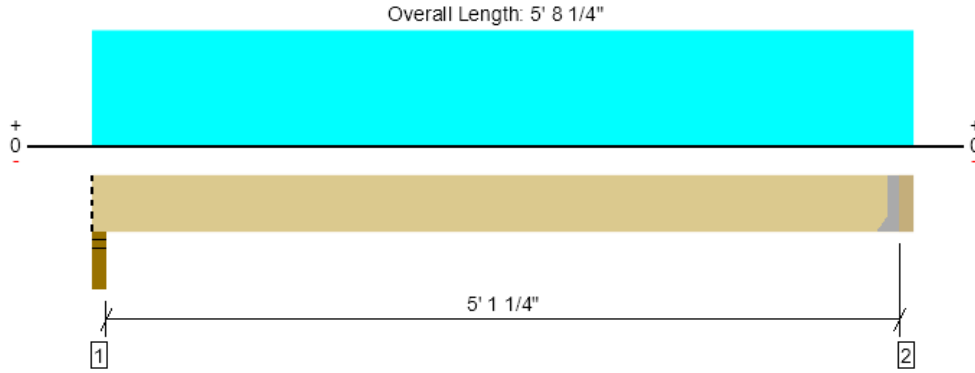

Drawing is Conceptual. All locations are measured from the outside face of left support (or left cantilever end). All dimensions are horizontal.

Design Results	Actual @ Location	Allowed	Result	LDF	Load: Combination (Pattern)
Member Reaction (lbs)	2101 @ 5' 4 3/4"	3413 (1.50")	Passed (62%)	--	1.0 D + 1.0 L (All Spans)
Shear (lbs)	1306 @ 4' 4 7/8"	7343	Passed (18%)	1.00	1.0 D + 1.0 L (All Spans)
Pos Moment (Ft-lbs)	2746 @ 2' 9 3/8"	16452	Passed (17%)	1.00	1.0 D + 1.0 L (All Spans)
Live Load Defl. (in)	0.009 @ 2' 9 3/8"	0.131	Passed (L/999+)	--	1.0 D + 1.0 L (All Spans)
Total Load Defl. (in)	0.015 @ 2' 9 3/8"	0.261	Passed (L/999+)	--	1.0 D + 1.0 L (All Spans)

Member Length : 5' 4 3/4"
 System : Floor
 Member Type : Flush Beam
 Building Use : Residential
 Building Code : IBC 2018
 Design Methodology : ASD

- Deflection criteria: LL (L/480) and TL (L/240).
- Allowed moment does not reflect the adjustment for the beam stability factor.
- Critical positive moment adjusted by a volume/size factor of 1.00 that was calculated using length L = 5' 2 3/4".
- The effects of positive or negative camber have not been accounted for when calculating deflection.
- The specified glulam is assumed to have its strong laminations at the bottom of the beam. Install with proper side up as indicated by the manufacturer.
- Applicable calculations are based on NDS.

Supports	Bearing Length			Loads to Supports (lbs)			Accessories
	Total	Available	Required	Dead	Floor Live	Factored	
1 - Stud wall - HF	3.50"	3.50"	1.58"	974	1261	2235	Blocking
2 - Hanger on 11 7/8" LSL beam	3.50"	Hanger ¹	1.50"	1015	1318	2332	See note ¹

- Blocking Panels are assumed to carry no loads applied directly above them and the full load is applied to the member being designed.
- At hanger supports, the Total Bearing dimension is equal to the width of the material that is supporting the hanger
- ¹ See Connector grid below for additional information and/or requirements.

Lateral Bracing	Bracing Intervals	Comments
Top Edge (Lu)	5' 5" o/c	
Bottom Edge (Lu)	5' 5" o/c	

- Maximum allowable bracing intervals based on applied load.

Connector: Simpson Strong-Tie							
Support	Model	Seat Length	Top Fasteners	Face Fasteners	Member Fasteners	Accessories	
2 - Face Mount Hanger	LUS414	2.00"	N/A	10-16d	6-16d		

- Refer to manufacturer notes and instructions for proper installation and use of all connectors.

Vertical Loads	Location (Side)	Tributary Width	Dead (0.90)	Floor Live (1.00)	Comments
0 - Self Weight (PLF)	0 to 5' 4 3/4"	N/A	10.1	--	
1 - Uniform (PSF)	0 to 5' 8 1/4" (Front)	11' 4"	30.0	40.0	Default Load

Weyerhaeuser Notes
 Weyerhaeuser warrants that the sizing of its products will be in accordance with Weyerhaeuser product design criteria and published design values. Weyerhaeuser expressly disclaims any other warranties related to the software. Use of this software is not intended to circumvent the need for a design professional as determined by the authority having jurisdiction. The designer of record, builder or framer is responsible to assure that this calculation is compatible with the overall project. Accessories (Rim Board, Blocking Panels and Squash Blocks) are not designed by this software. Products manufactured at Weyerhaeuser facilities are third-party certified to sustainable forestry standards. Weyerhaeuser Engineered Lumber Products have been evaluated by ICC-ES under evaluation reports ESR-1153 and ESR-1387 and/or tested in accordance with applicable ASTM standards. For current code evaluation reports, Weyerhaeuser product literature and installation details refer to www.weyerhaeuser.com/woodproducts/document-library.
 The product application, input design loads, dimensions and support information have been provided by ForteWEB Software Operator

ForteWEB Software Operator	Job Notes
Chon Pieruccioni Pieruccioni Engineering (206) 949-7866 cpieru@hotmail.com	



3rd Floor Framing, Grid 8.4 (D-D.3) Flush Beam
1 piece(s) 3 1/2" x 11 7/8" 24F-V4 DF Glulam

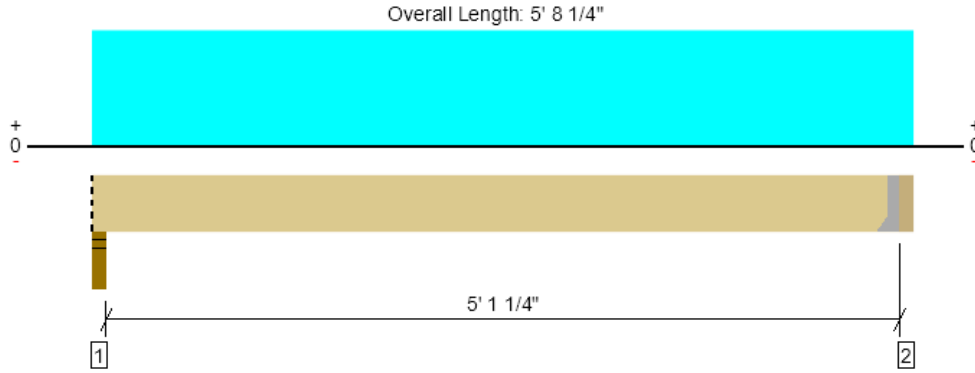

Drawing is Conceptual. All locations are measured from the outside face of left support (or left cantilever end). All dimensions are horizontal.

Design Results	Actual @ Location	Allowed	Result	LDF	Load: Combination (Pattern)
Member Reaction (lbs)	2101 @ 5' 4 3/4"	3413 (1.50")	Passed (62%)	--	1.0 D + 1.0 L (All Spans)
Shear (lbs)	1306 @ 4' 4 7/8"	7343	Passed (18%)	1.00	1.0 D + 1.0 L (All Spans)
Pos Moment (Ft-lbs)	2746 @ 2' 9 3/8"	16452	Passed (17%)	1.00	1.0 D + 1.0 L (All Spans)
Live Load Defl. (in)	0.009 @ 2' 9 3/8"	0.131	Passed (L/999+)	--	1.0 D + 1.0 L (All Spans)
Total Load Defl. (in)	0.015 @ 2' 9 3/8"	0.261	Passed (L/999+)	--	1.0 D + 1.0 L (All Spans)

Member Length : 5' 4 3/4"
System : Floor
Member Type : Flush Beam
Building Use : Residential
Building Code : IBC 2018
Design Methodology : ASD

- Deflection criteria: LL (L/480) and TL (L/240).
- Allowed moment does not reflect the adjustment for the beam stability factor.
- Critical positive moment adjusted by a volume/size factor of 1.00 that was calculated using length L = 5' 2 3/4".
- The effects of positive or negative camber have not been accounted for when calculating deflection.
- The specified glulam is assumed to have its strong laminations at the bottom of the beam. Install with proper side up as indicated by the manufacturer.
- Applicable calculations are based on NDS.

Supports	Bearing Length			Loads to Supports (lbs)			Accessories
	Total	Available	Required	Dead	Floor Live	Factored	
1 - Stud wall - HF	3.50"	3.50"	1.58"	974	1261	2235	Blocking
2 - Hanger on 11 7/8" LSL beam	3.50"	Hanger ¹	1.50"	1015	1318	2332	See note ¹

- Blocking Panels are assumed to carry no loads applied directly above them and the full load is applied to the member being designed.
- At hanger supports, the Total Bearing dimension is equal to the width of the material that is supporting the hanger
- ¹ See Connector grid below for additional information and/or requirements.

Lateral Bracing	Bracing Intervals	Comments
Top Edge (Lu)	5' 5" o/c	
Bottom Edge (Lu)	5' 5" o/c	

- Maximum allowable bracing intervals based on applied load.

Connector: Simpson Strong-Tie							
Support	Model	Seat Length	Top Fasteners	Face Fasteners	Member Fasteners	Accessories	
2 - Face Mount Hanger	LUS414	2.00"	N/A	10-16d	6-16d		

- Refer to manufacturer notes and instructions for proper installation and use of all connectors.

Vertical Loads	Location (Side)	Tributary Width	Dead (0.90)	Floor Live (1.00)	Comments
0 - Self Weight (PLF)	0 to 5' 4 3/4"	N/A	10.1	--	
1 - Uniform (PSF)	0 to 5' 8 1/4" (Front)	11' 4"	30.0	40.0	Default Load

Weyerhaeuser Notes

Weyerhaeuser warrants that the sizing of its products will be in accordance with Weyerhaeuser product design criteria and published design values. Weyerhaeuser expressly disclaims any other warranties related to the software. Use of this software is not intended to circumvent the need for a design professional as determined by the authority having jurisdiction. The designer of record, builder or framer is responsible to assure that this calculation is compatible with the overall project. Accessories (Rim Board, Blocking Panels and Squash Blocks) are not designed by this software. Products manufactured at Weyerhaeuser facilities are third-party certified to sustainable forestry standards. Weyerhaeuser Engineered Lumber Products have been evaluated by ICC-ES under evaluation reports ESR-1153 and ESR-1387 and/or tested in accordance with applicable ASTM standards. For current code evaluation reports, Weyerhaeuser product literature and installation details refer to www.eyerhaeuser.com/woodproducts/document-library.

The product application, input design loads, dimensions and support information have been provided by ForteWEB Software Operator

ForteWEB Software Operator	Job Notes
Chon Pieruccioni Pieruccioni Engineering (206) 949-7866 cpieru@hotmail.com	



3rd Floor Framing, Grid 6 (D.5-D.6) Bedroom Door Header
1 piece(s) 4 x 8 DF No.2

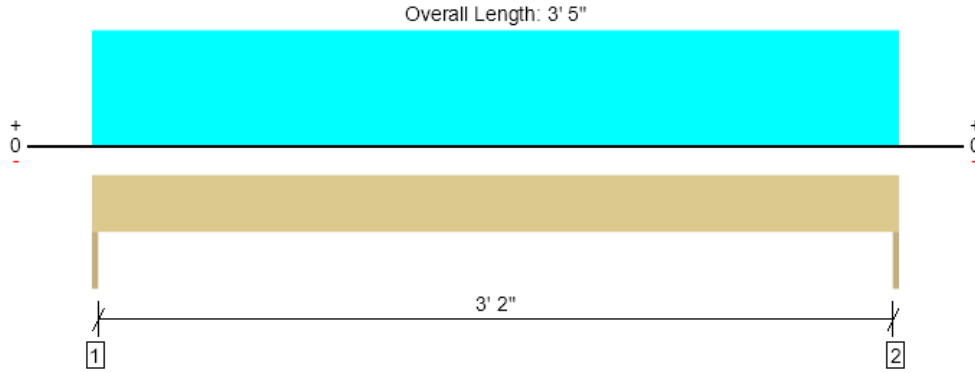

Drawing is Conceptual. All locations are measured from the outside face of left support (or left cantilever end). All dimensions are horizontal.

Design Results	Actual @ Location	Allowed	Result	LDF	Load: Combination (Pattern)
Member Reaction (lbs)	1366 @ 0	3281 (1.50")	Passed (42%)	--	1.0 D + 1.0 L (All Spans)
Shear (lbs)	783 @ 8 3/4"	3045	Passed (26%)	1.00	1.0 D + 1.0 L (All Spans)
Moment (Ft-lbs)	1167 @ 1' 8 1/2"	2989	Passed (39%)	1.00	1.0 D + 1.0 L (All Spans)
Live Load Defl. (in)	0.008 @ 1' 8 1/2"	0.114	Passed (L/999+)	--	1.0 D + 1.0 L (All Spans)
Total Load Defl. (in)	0.014 @ 1' 8 1/2"	0.171	Passed (L/999+)	--	1.0 D + 1.0 L (All Spans)

Member Length : 3' 5"
System : Wall
Member Type : Header
Building Use : Residential
Building Code : IBC 2018
Design Methodology : ASD

- Deflection criteria: LL (L/360) and TL (L/240).
- Allowed moment does not reflect the adjustment for the beam stability factor.
- Applicable calculations are based on NDS.

Supports	Bearing Length			Loads to Supports (lbs)			Accessories
	Total	Available	Required	Dead	Floor Live	Factored	
1 - Trimmer - HF	1.50"	1.50"	1.50"	592	774	1366	None
2 - Trimmer - HF	1.50"	1.50"	1.50"	592	774	1366	None

Lateral Bracing	Bracing Intervals	Comments
Top Edge (Lu)	3' 5" o/c	
Bottom Edge (Lu)	3' 5" o/c	

•Maximum allowable bracing intervals based on applied load.

Vertical Loads	Location	Tributary Width	Dead (0.90)	Floor Live (1.00)	Comments
0 - Self Weight (PLF)	0 to 3' 5"	N/A	6.4	--	
1 - Uniform (PSF)	0 to 3' 5"	11' 4"	30.0	40.0	Default Load

Weyerhaeuser Notes

Weyerhaeuser warrants that the sizing of its products will be in accordance with Weyerhaeuser product design criteria and published design values. Weyerhaeuser expressly disclaims any other warranties related to the software. Use of this software is not intended to circumvent the need for a design professional as determined by the authority having jurisdiction. The designer of record, builder or framer is responsible to assure that this calculation is compatible with the overall project. Accessories (Rim Board, Blocking Panels and Squash Blocks) are not designed by this software. Products manufactured at Weyerhaeuser facilities are third-party certified to sustainable forestry standards. Weyerhaeuser Engineered Lumber Products have been evaluated by ICC-ES under evaluation reports ESR-1153 and ESR-1387 and/or tested in accordance with applicable ASTM standards. For current code evaluation reports, Weyerhaeuser product literature and installation details refer to www.weyerhaeuser.com/woodproducts/document-library.

The product application, input design loads, dimensions and support information have been provided by ForteWEB Software Operator

ForteWEB Software Operator	Job Notes
Chon Pieruccioni Pieruccioni Engineering (206) 949-7866 cpieru@hotmail.com	



3rd Floor Framing, Grid 8 (D.5-D.6) Bedroom Door Header
1 piece(s) 4 x 8 DF No.2

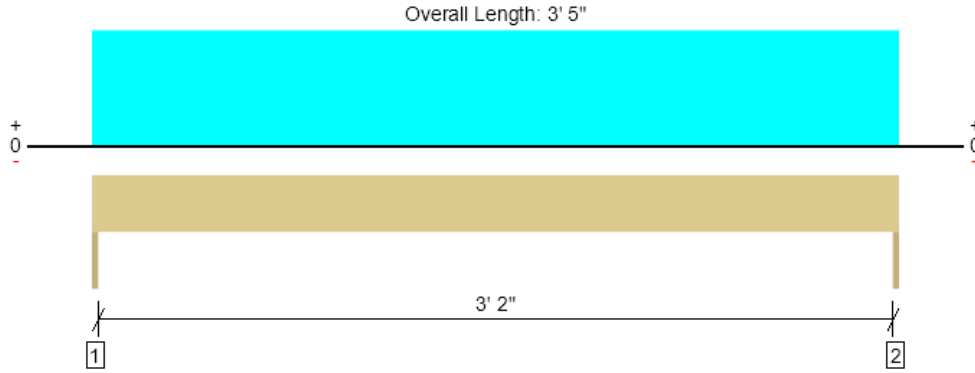

Drawing is Conceptual. All locations are measured from the outside face of left support (or left cantilever end). All dimensions are horizontal.

Design Results	Actual @ Location	Allowed	Result	LDF	Load: Combination (Pattern)
Member Reaction (lbs)	1366 @ 0	3281 (1.50")	Passed (42%)	--	1.0 D + 1.0 L (All Spans)
Shear (lbs)	783 @ 8 3/4"	3045	Passed (26%)	1.00	1.0 D + 1.0 L (All Spans)
Moment (Ft-lbs)	1167 @ 1' 8 1/2"	2989	Passed (39%)	1.00	1.0 D + 1.0 L (All Spans)
Live Load Defl. (in)	0.008 @ 1' 8 1/2"	0.114	Passed (L/999+)	--	1.0 D + 1.0 L (All Spans)
Total Load Defl. (in)	0.014 @ 1' 8 1/2"	0.171	Passed (L/999+)	--	1.0 D + 1.0 L (All Spans)

Member Length : 3' 5"
System : Wall
Member Type : Header
Building Use : Residential
Building Code : IBC 2018
Design Methodology : ASD

- Deflection criteria: LL (L/360) and TL (L/240).
- Allowed moment does not reflect the adjustment for the beam stability factor.
- Applicable calculations are based on NDS.

Supports	Bearing Length			Loads to Supports (lbs)			Accessories
	Total	Available	Required	Dead	Floor Live	Factored	
1 - Trimmer - HF	1.50"	1.50"	1.50"	592	774	1366	None
2 - Trimmer - HF	1.50"	1.50"	1.50"	592	774	1366	None

Lateral Bracing	Bracing Intervals	Comments
Top Edge (Lu)	3' 5" o/c	
Bottom Edge (Lu)	3' 5" o/c	

•Maximum allowable bracing intervals based on applied load.

Vertical Loads	Location	Tributary Width	Dead (0.90)	Floor Live (1.00)	Comments
0 - Self Weight (PLF)	0 to 3' 5"	N/A	6.4	--	
1 - Uniform (PSF)	0 to 3' 5"	11' 4"	30.0	40.0	Default Load

Weyerhaeuser Notes

Weyerhaeuser warrants that the sizing of its products will be in accordance with Weyerhaeuser product design criteria and published design values. Weyerhaeuser expressly disclaims any other warranties related to the software. Use of this software is not intended to circumvent the need for a design professional as determined by the authority having jurisdiction. The designer of record, builder or framer is responsible to assure that this calculation is compatible with the overall project. Accessories (Rim Board, Blocking Panels and Squash Blocks) are not designed by this software. Products manufactured at Weyerhaeuser facilities are third-party certified to sustainable forestry standards. Weyerhaeuser Engineered Lumber Products have been evaluated by ICC-ES under evaluation reports ESR-1153 and ESR-1387 and/or tested in accordance with applicable ASTM standards. For current code evaluation reports, Weyerhaeuser product literature and installation details refer to www.weyerhaeuser.com/woodproducts/document-library.

The product application, input design loads, dimensions and support information have been provided by ForteWEB Software Operator

ForteWEB Software Operator	Job Notes
Chon Pieruccioni Pieruccioni Engineering (206) 949-7866 cpieru@hotmail.com	



Roof Framing, Grid D.7 Entry Roof Beam
1 piece(s) 3 1/2" x 10 1/2" 24F-V4 DF Glulam

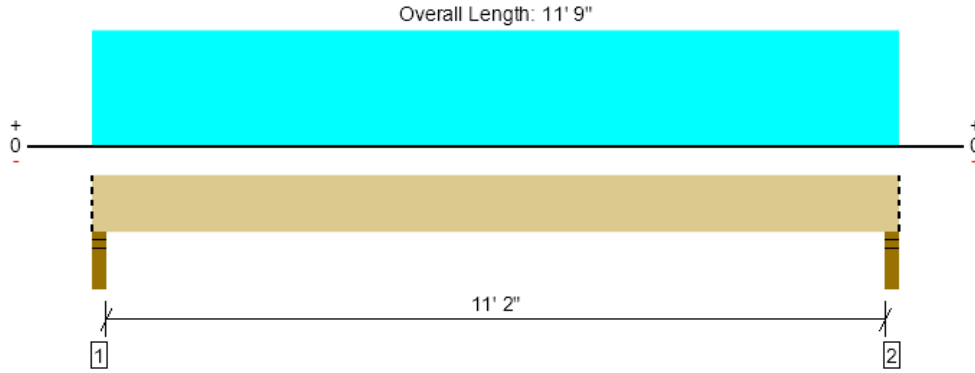

Drawing is Conceptual. All locations are measured from the outside face of left support (or left cantilever end). All dimensions are horizontal.

Design Results	Actual @ Location	Allowed	Result	LDF	Load: Combination (Pattern)
Member Reaction (lbs)	5084 @ 2"	4961 (3.50")	Passed (102%)	--	1.0 D + 1.0 S (All Spans)
Shear (lbs)	4075 @ 1' 2"	7466	Passed (55%)	1.15	1.0 D + 1.0 S (All Spans)
Pos Moment (Ft-lbs)	14099 @ 5' 10 1/2"	14792	Passed (95%)	1.15	1.0 D + 1.0 S (All Spans)
Live Load Defl. (in)	0.269 @ 5' 10 1/2"	0.571	Passed (L/509)	--	1.0 D + 1.0 S (All Spans)
Total Load Defl. (in)	0.545 @ 5' 10 1/2"	0.761	Passed (L/252)	--	1.0 D + 1.0 S (All Spans)

Member Length : 11' 9"
System : Roof
Member Type : Drop Beam
Building Use : Residential
Building Code : IBC 2018
Design Methodology : ASD
Member Pitch : 0.25/12

- Deflection criteria: LL (L/240) and TL (L/180).
- Allowed moment does not reflect the adjustment for the beam stability factor.
- Critical positive moment adjusted by a volume/size factor of 1.00 that was calculated using length L = 11' 5".
- The effects of positive or negative camber have not been accounted for when calculating deflection.
- The specified glulam is assumed to have its strong laminations at the bottom of the beam. Install with proper side up as indicated by the manufacturer.
- Applicable calculations are based on NDS.

Supports	Bearing Length			Loads to Supports (lbs)			Accessories
	Total	Available	Required	Dead	Snow	Factored	
1 - Stud wall - HF	3.50"	3.50"	3.59"	2569	2515	5084	Blocking
2 - Stud wall - HF	3.50"	3.50"	3.59"	2569	2515	5084	Blocking

- Blocking Panels are assumed to carry no loads applied directly above them and the full load is applied to the member being designed.

Lateral Bracing	Bracing Intervals	Comments
Top Edge (Lu)	11' 2" o/c	
Bottom Edge (Lu)	11' 9" o/c	

- Maximum allowable bracing intervals based on applied load.

Vertical Loads	Location (Side)	Tributary Width	Dead (0.90)	Snow (1.15)	Comments
0 - Self Weight (PLF)	0 to 11' 9"	N/A	8.9	--	
1 - Uniform (PSF)	0 to 11' 9" (Front)	17' 1 1/2"	25.0	25.0	Default Load

Weyerhaeuser Notes

Weyerhaeuser warrants that the sizing of its products will be in accordance with Weyerhaeuser product design criteria and published design values. Weyerhaeuser expressly disclaims any other warranties related to the software. Use of this software is not intended to circumvent the need for a design professional as determined by the authority having jurisdiction. The designer of record, builder or framer is responsible to assure that this calculation is compatible with the overall project. Accessories (Rim Board, Blocking Panels and Squash Blocks) are not designed by this software. Products manufactured at Weyerhaeuser facilities are third-party certified to sustainable forestry standards. Weyerhaeuser Engineered Lumber Products have been evaluated by ICC-ES under evaluation reports ESR-1153 and ESR-1387 and/or tested in accordance with applicable ASTM standards. For current code evaluation reports, Weyerhaeuser product literature and installation details refer to www.weyerhaeuser.com/woodproducts/document-library.

The product application, input design loads, dimensions and support information have been provided by ForteWEB Software Operator

ForteWEB Software Operator	Job Notes
Chon Pieruccioni Pieruccioni Engineering (206) 949-7866 cpieru@hotmail.com	



Roof Framing, Grid A 7'-3" Deck Roof Beam
1 piece(s) 3 1/2" x 7 1/2" 24F-V4 DF Glulam

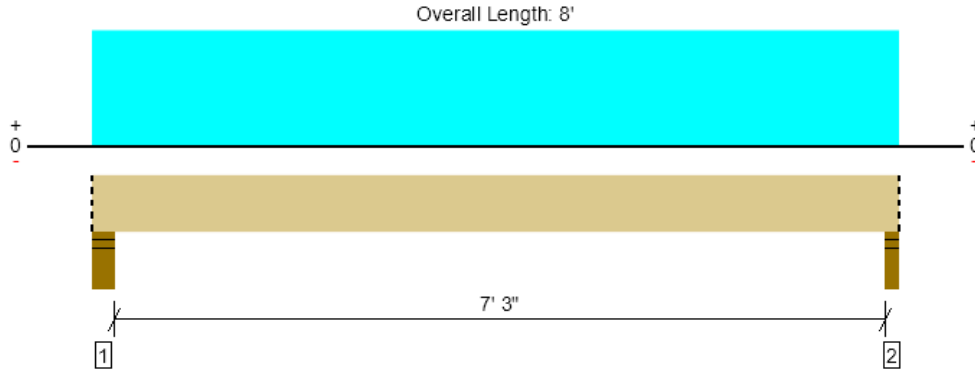

Drawing is Conceptual. All locations are measured from the outside face of left support (or left cantilever end). All dimensions are horizontal.

Design Results	Actual @ Location	Allowed	Result	LDF	Load: Combination (Pattern)
Member Reaction (lbs)	3257 @ 7' 10"	4961 (3.50")	Passed (66%)	--	1.0 D + 1.0 S (All Spans)
Shear (lbs)	2495 @ 1' 1"	5333	Passed (47%)	1.15	1.0 D + 1.0 S (All Spans)
Pos Moment (Ft-lbs)	5847 @ 4' 1"	7547	Passed (77%)	1.15	1.0 D + 1.0 S (All Spans)
Live Load Defl. (in)	0.133 @ 4' 1"	0.375	Passed (L/679)	--	1.0 D + 1.0 S (All Spans)
Total Load Defl. (in)	0.267 @ 4' 1"	0.500	Passed (L/337)	--	1.0 D + 1.0 S (All Spans)

Member Length : 8'
System : Roof
Member Type : Drop Beam
Building Use : Residential
Building Code : IBC 2018
Design Methodology : ASD
Member Pitch : 0.25/12

- Deflection criteria: LL (L/240) and TL (L/180).
- Allowed moment does not reflect the adjustment for the beam stability factor.
- Critical positive moment adjusted by a volume/size factor of 1.00 that was calculated using length L = 7' 6".
- The effects of positive or negative camber have not been accounted for when calculating deflection.
- The specified glulam is assumed to have its strong laminations at the bottom of the beam. Install with proper side up as indicated by the manufacturer.
- Applicable calculations are based on NDS.

Supports	Bearing Length			Loads to Supports (lbs)			Accessories
	Total	Available	Required	Dead	Snow	Factored	
1 - Stud wall - HF	5.50"	5.50"	2.40"	1711	1684	3396	Blocking
2 - Stud wall - HF	3.50"	3.50"	2.30"	1641	1616	3257	Blocking

- Blocking Panels are assumed to carry no loads applied directly above them and the full load is applied to the member being designed.

Lateral Bracing	Bracing Intervals	Comments
Top Edge (Lu)	8' o/c	
Bottom Edge (Lu)	8' o/c	

- Maximum allowable bracing intervals based on applied load.

Vertical Loads	Location (Side)	Tributary Width	Dead (0.90)	Snow (1.15)	Comments
0 - Self Weight (PLF)	0 to 8'	N/A	6.4	--	
1 - Uniform (PSF)	0 to 8' (Front)	16' 6"	25.0	25.0	Default Load

Weyerhaeuser Notes

Weyerhaeuser warrants that the sizing of its products will be in accordance with Weyerhaeuser product design criteria and published design values. Weyerhaeuser expressly disclaims any other warranties related to the software. Use of this software is not intended to circumvent the need for a design professional as determined by the authority having jurisdiction. The designer of record, builder or framer is responsible to assure that this calculation is compatible with the overall project. Accessories (Rim Board, Blocking Panels and Squash Blocks) are not designed by this software. Products manufactured at Weyerhaeuser facilities are third-party certified to sustainable forestry standards. Weyerhaeuser Engineered Lumber Products have been evaluated by ICC-ES under evaluation reports ESR-1153 and ESR-1387 and/or tested in accordance with applicable ASTM standards. For current code evaluation reports, Weyerhaeuser product literature and installation details refer to www.woyehaeuser.com/woodproducts/document-library.

The product application, input design loads, dimensions and support information have been provided by ForteWEB Software Operator

ForteWEB Software Operator	Job Notes
Chon Pieruccioni Pieruccioni Engineering (206) 949-7866 cpieru@hotmail.com	



Roof Framing, Grid G 9' Deck Roof Beam
1 piece(s) 3 1/2" x 9" 24F-V4 DF Glulam

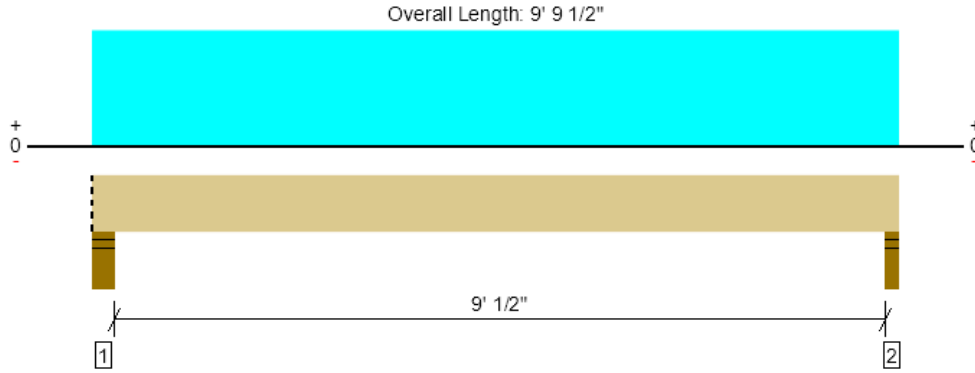

Drawing is Conceptual. All locations are measured from the outside face of left support (or left cantilever end). All dimensions are horizontal.

Design Results	Actual @ Location	Allowed	Result	LDF	Load: Combination (Pattern)
Member Reaction (lbs)	4414 @ 9' 7 1/2"	4961 (3.50")	Passed (89%)	--	1.0 D + 1.0 S (All Spans)
Shear (lbs)	3459 @ 1' 2 1/2"	6400	Passed (54%)	1.15	1.0 D + 1.0 S (All Spans)
Pos Moment (Ft-lbs)	9899 @ 4' 11 3/4"	10868	Passed (91%)	1.15	1.0 D + 1.0 S (All Spans)
Live Load Defl. (in)	0.199 @ 4' 11 3/4"	0.465	Passed (L/559)	--	1.0 D + 1.0 S (All Spans)
Total Load Defl. (in)	0.402 @ 4' 11 3/4"	0.620	Passed (L/277)	--	1.0 D + 1.0 S (All Spans)

Member Length : 9' 9 1/2"
System : Roof
Member Type : Drop Beam
Building Use : Residential
Building Code : IBC 2018
Design Methodology : ASD
Member Pitch : 0.25/12

- Deflection criteria: LL (L/240) and TL (L/180).
- Allowed moment does not reflect the adjustment for the beam stability factor.
- Critical positive moment adjusted by a volume/size factor of 1.00 that was calculated using length L = 9' 3 1/2".
- The effects of positive or negative camber have not been accounted for when calculating deflection.
- The specified glulam is assumed to have its strong laminations at the bottom of the beam. Install with proper side up as indicated by the manufacturer.
- Applicable calculations are based on NDS.

Supports	Bearing Length			Loads to Supports (lbs)			Accessories
	Total	Available	Required	Dead	Snow	Factored	
1 - Stud wall - HF	5.50"	5.50"	3.22"	2303	2264	4567	Blocking
2 - Stud wall - HF	3.50"	3.50"	3.11"	2226	2188	4414	None

- Blocking Panels are assumed to carry no loads applied directly above them and the full load is applied to the member being designed.

Lateral Bracing	Bracing Intervals	Comments
Top Edge (Lu)	9' 10" o/c	
Bottom Edge (Lu)	9' 10" o/c	

- Maximum allowable bracing intervals based on applied load.

Vertical Loads	Location (Side)	Tributary Width	Dead (0.90)	Snow (1.15)	Comments
0 - Self Weight (PLF)	0 to 9' 9 1/2"	N/A	7.7	--	
1 - Uniform (PSF)	0 to 9' 9 1/2" (Front)	18' 2 1/4"	25.0	25.0	Default Load

Weyerhaeuser Notes

Weyerhaeuser warrants that the sizing of its products will be in accordance with Weyerhaeuser product design criteria and published design values. Weyerhaeuser expressly disclaims any other warranties related to the software. Use of this software is not intended to circumvent the need for a design professional as determined by the authority having jurisdiction. The designer of record, builder or framer is responsible to assure that this calculation is compatible with the overall project. Accessories (Rim Board, Blocking Panels and Squash Blocks) are not designed by this software. Products manufactured at Weyerhaeuser facilities are third-party certified to sustainable forestry standards. Weyerhaeuser Engineered Lumber Products have been evaluated by ICC-ES under evaluation reports ESR-1153 and ESR-1387 and/or tested in accordance with applicable ASTM standards. For current code evaluation reports, Weyerhaeuser product literature and installation details refer to www.weyerhaeuser.com/woodproducts/document-library.

The product application, input design loads, dimensions and support information have been provided by ForteWEB Software Operator

ForteWEB Software Operator	Job Notes
Chon Pieruccioni Pieruccioni Engineering (206) 949-7866 cpieru@hotmail.com	



Roof Framing, 6' Window Header
1 piece(s) 4 x 10 DF No.2

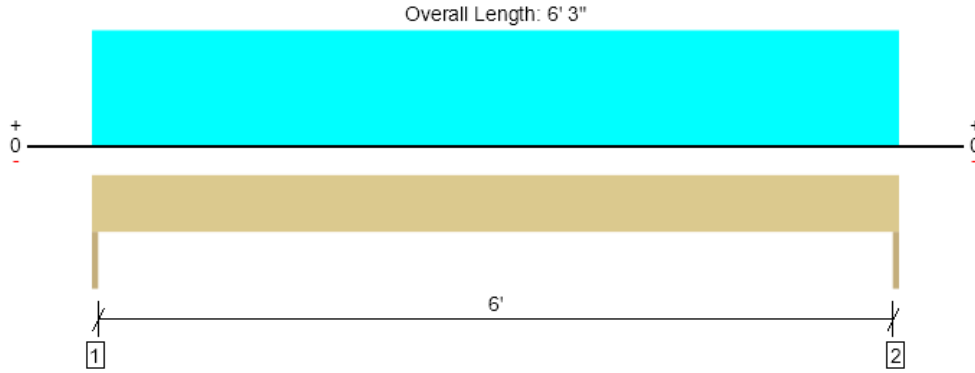

Drawing is Conceptual. All locations are measured from the outside face of left support (or left cantilever end). All dimensions are horizontal.

Design Results	Actual @ Location	Allowed	Result	LDF	Load: Combination (Pattern)
Member Reaction (lbs)	2956 @ 0	3281 (1.50")	Passed (90%)	--	1.0 D + 1.0 S (All Spans)
Shear (lbs)	2108 @ 10 3/4"	4468	Passed (47%)	1.15	1.0 D + 1.0 S (All Spans)
Moment (Ft-lbs)	4618 @ 3' 1 1/2"	5166	Passed (89%)	1.15	1.0 D + 1.0 S (All Spans)
Live Load Defl. (in)	0.044 @ 3' 1 1/2"	0.208	Passed (L/999+)	--	1.0 D + 1.0 S (All Spans)
Total Load Defl. (in)	0.088 @ 3' 1 1/2"	0.313	Passed (L/853)	--	1.0 D + 1.0 S (All Spans)

Member Length : 6' 3"
System : Wall
Member Type : Header
Building Use : Residential
Building Code : IBC 2018
Design Methodology : ASD

- Deflection criteria: LL (L/360) and TL (L/240).
- Allowed moment does not reflect the adjustment for the beam stability factor.
- Applicable calculations are based on NDS.

Supports	Bearing Length			Loads to Supports (lbs)			Accessories
	Total	Available	Required	Dead	Snow	Factored	
1 - Trimmer - HF	1.50"	1.50"	1.50"	1491	1465	2956	None
2 - Trimmer - HF	1.50"	1.50"	1.50"	1491	1465	2956	None

Lateral Bracing	Bracing Intervals	Comments
Top Edge (Lu)	6' 3" o/c	
Bottom Edge (Lu)	6' 3" o/c	

•Maximum allowable bracing intervals based on applied load.

Vertical Loads	Location	Tributary Width	Dead (0.90)	Snow (1.15)	Comments
0 - Self Weight (PLF)	0 to 6' 3"	N/A	8.2	--	
1 - Uniform (PSF)	0 to 6' 3"	18' 9"	25.0	25.0	Default Load

Weyerhaeuser Notes

Weyerhaeuser warrants that the sizing of its products will be in accordance with Weyerhaeuser product design criteria and published design values. Weyerhaeuser expressly disclaims any other warranties related to the software. Use of this software is not intended to circumvent the need for a design professional as determined by the authority having jurisdiction. The designer of record, builder or framer is responsible to assure that this calculation is compatible with the overall project. Accessories (Rim Board, Blocking Panels and Squash Blocks) are not designed by this software. Products manufactured at Weyerhaeuser facilities are third-party certified to sustainable forestry standards. Weyerhaeuser Engineered Lumber Products have been evaluated by ICC-ES under evaluation reports ESR-1153 and ESR-1387 and/or tested in accordance with applicable ASTM standards. For current code evaluation reports, Weyerhaeuser product literature and installation details refer to www.weyerhaeuser.com/woodproducts/document-library.

The product application, input design loads, dimensions and support information have been provided by ForteWEB Software Operator

ForteWEB Software Operator	Job Notes
Chon Pieruccioni Pieruccioni Engineering (206) 949-7866 cpieru@hotmail.com	



GEOMETRY			SOIL PRESSURES (D+L)		
Footing Length (X-dir)	3.50	ft	Gross Allow. Soil Pressure	2.0	ksf
Footing Width (Z-dir)	3.50	ft	Soil Pressure at Corner 1	1.5	ksf
Footing Thickness	8.0	in OK	Soil Pressure at Corner 2	1.5	ksf
Soil Cover	0.00	ft	Soil Pressure at Corner 3	1.5	ksf
Column Length (X-dir)	6.0	in	Soil Pressure at Corner 4	1.5	ksf
Column Width (Z-dir)	6.0	in	Bearing Pressure Ratio	0.76	OK
Offset (X-dir)	0.00	in OK	Ftg. Area in Contact with Soil	100.0	%
Offset (Z-dir)	0.00	in OK	X-eccentricity / Ftg. Length	0.00	OK
Base Plate (L x W)	6.0 x 6.0	in	Z-eccentricity / Ftg. Width	0.00	OK

APPLIED LOADS

	Dead	Live	RLive	Snow	Wind	Seismic	
Axial Force P	5.2	12.8	0.0	0.0	0.0	0.0	kip
Moment about X Mx ..	0.0	0.0	0.0	0.0	0.0	0.0	k-ft
Moment about Z Mz ..	0.0	0.0	0.0	0.0	0.0	0.0	k-ft
Shear Force Vx	0.0	0.0	0.0	0.0	0.0	0.0	kip
Shear Force Vz	0.0	0.0	0.0	0.0	0.0	0.0	kip

OVERTURNING CALCULATIONS (Comb: 0.6D+0.6W)

- Overturning about X-X

- Moment Mx = 0.6 * 0.0 + 0.6 * 0.0 = 0.0 k-ft

- Shear Force Vz = 0.6 * 0.0 + 0.6 * 0.0 = 0.0 kip

Arm = 0.00 + 8.0 / 12 = 0.67 ft

Moment = 0.0 * 0.67 = 0.0 k-ft

- Passive Force = 0.0 kip

Arm = 0.27 ft

Moment = 0.0 k-ft

- Overturning moment X-X = 0.0 + 0.0 = 0.0 k-ft

- Resisting about X-X

- Footing weight = $0.6 * W * L * Thick * Density = 0.6 * 3.50 * 3.50 * 8.0 / 12 * 0.15 = 0.7$ kip

Arm = $W / 2 = 3.50 / 2 = 1.75$ ft

Moment = $0.7 * 1.75 = 1.3$ k-ft

- Pedestal weight = $0.6 * W * L * H * Density = 0.6 * 6.0 / 12 * 6.0 / 12 * 0.0 * 0.15 = 0.0$ kip

Arm = $W / 2 - Offset = 3.50 / 2 - 0.0 / 12 = 1.75$ ft

Moment = $0.0 * 1.75 = 0.0$ k-ft

- Soil cover = $0.6 * W * L * SC * Density = 0.6 * (3.50 * 3.50 - 6.0 / 12 * 6.0 / 12) * 0.0 * 110 = 0.0$ kip

Arm = $W / 2 = 3.50 / 2 = 1.75$ ft

Moment = $0.0 * 1.75 = 0.0$ k-ft

- Buoyancy = $0.6 * W * L * \gamma * (SC + Thick - WT) = 0.6 * 3.50 * 3.50 * 62 * (0.67) = -0.3$ kip

Arm = $W / 2 = 3.50 / 2 = 1.75$ ft

Moment = $0.3 * 1.75 = -0.5$ k-ft

- Axial force P = $0.6 * 5.2 + 0.6 * 0.0 = 3.1$ kip

Arm = $W / 2 - Offset = 3.50 / 2 - 0.0 / 12 = 1.75$ ft

Moment = $3.1 * 1.75 = 5.5$ k-ft

- Resisting moment X-X = $1.3 + 0.0 + 0.0 + 5.5 + -0.5 = 6.2$ k-ft

- Overturning safety factor X-X = $\frac{Resisting\ moment}{Overturning\ moment} = \frac{6.2}{0.0} = 62.11 > 1.50$ OK

- Overturning about Z-Z

- Moment $M_z = 0.6 * 0.0 + 0.6 * 0.0 = 0.0$ k-ft

- Shear Force $V_x = 0.6 * 0.0 + 0.6 * 0.0 = 0.0$ kip

Arm = $0.00 + 8.0 / 12 = 0.67$ ft

Moment = $0.0 * 0.67 = 0.0$ k-ft

- Passive Force = 0.0 kip

Arm = 0.27 ft

Moment = 0.0 k-ft

- Overturning moment Z-Z = $0.0 + 0.0 = 0.0$ k-ft

- Resisting about Z-Z

- Footing weight = $0.6 * W * L * Thick * Density = 0.6 * 3.50 * 3.50 * 8.0 / 12 * 0.15 = 0.7$ kip

Arm = $L / 2 = 3.50 / 2 = 1.75$ ft

Moment = $0.7 * 1.75 = 1.3$ k-ft

- Pedestal weight = $0.6 * W * L * H * Density = 0.6 * 6.0 / 12 * 6.0 / 12 * 0.0 * 0.15 = 0.0$ kip

Arm = $L / 2 - Offset = 3.50 / 2 - 0.0 / 12 = 1.75$ ft

Moment = $0.0 * 1.75 = 0.0$ k-ft

- Soil cover = $0.6 * W * L * SC * Density = 0.6 * (3.50 * 3.50 - 6.0 / 12 * 6.0 / 12) * 0.0 * 110 = 0.0$ kip

Arm = $L / 2 = 3.50 / 2 = 1.75$ ft

Moment = $0.0 * 1.75 = 0.0$ k-ft

- Buoyancy = $0.6 * W * L * \gamma * (SC + Thick - WT) = 0.6 * 3.50 * 3.50 * 62 * (0.67) = -0.3$ kip

Arm = $L / 2 = 3.50 / 2 = 1.75$ ft

Moment = $0.3 * 1.75 = -0.5$ k-ft

- Axial force $P = 0.6 * 5.2 + 0.6 * 0.0 = 3.1$ kip

Arm = $L / 2 - Offset = 3.50 / 2 - 0.0 / 12 = 1.75$ ft

Moment = $3.1 * 1.75 = 5.5$ k-ft

- Resisting moment Z-Z = $1.3 + 0.0 + 0.0 + 5.5 + -0.5 = 6.2$ k-ft

- Overturning safety factor Z-Z = $\frac{Resisting\ moment}{Overturning\ moment} = \frac{6.2}{0.0} = 62.11 > 1.50$ OK

SOIL BEARING PRESSURES (Comb: D+L)

Overturning moment X-X = $0.0 + 0.0 = 0.0$ k-ft

Resisting moment X-X = $2.1 + 0.0 + 0.0 + -0.9 + 31.5 = 32.8$ k-ft

Overturning moment Z-Z = $0.0 + 0.0 = 0.0$ k-ft

Resisting moment Z-Z = $2.1 + 0.0 + 0.0 + -0.9 + 31.5 = 32.8$ k-ft

Resisting force = $Footing + Pedestal + Soil - Buoyancy + P = 1.2 + 0.0 + 0.0 - 0.5 + 18.0 = 18.7$ kip

X-coordinate of resultant from maximum bearing corner:

$$X_p = \frac{Z-Resisting\ moment - Z-Overturning\ moment}{Resisting\ force} = \frac{32.8 - 0.0}{18.7} = 1.75\text{ ft}$$

Z-coordinate of resultant from maximum bearing corner:

$$Z_p = \frac{X-Resisting\ moment - X-Overturning\ moment}{Resisting\ force} = \frac{32.8 - 0.0}{18.7} = 1.75\text{ ft}$$

X-ecc = $Length / 2 - X_p = 3.50 / 2 - 1.75 = 0.00$ ft

Z-ecc = $Width / 2 - Z_p = 3.50 / 2 - 1.75 = 0.00$ ft

Area = $Width * Length = 3.50 * 3.50 = 12.3$ ft²

S_x = $Length * Width^2 / 6 = 3.50 * 3.50^2 / 6 = 7.1$ ft³

S_z = $Width * Length^2 / 6 = 3.50 * 3.50^2 / 6 = 7.1$ ft³

- Footing is in full bearing. Soil pressures are as follows:

P₁ = $P * (1/A + Z-ecc / S_x + X-ecc / S_z) = 18.7 * (1 / 12.3 + 0.00 / 7.1 + 0.00 / 7.1) = 1.53$ ksf

P₂ = $P * (1/A - Z-ecc / S_x + X-ecc / S_z) = 18.7 * (1 / 12.3 - 0.00 / 7.1 + 0.00 / 7.1) = 1.53$ ksf

P₃ = $P * (1/A - Z-ecc / S_x - X-ecc / S_z) = 18.7 * (1 / 12.3 - 0.00 / 7.1 - 0.00 / 7.1) = 1.53$ ksf

P₄ = $P * (1/A + Z-ecc / S_x - X-ecc / S_z) = 18.7 * (1 / 12.3 + 0.00 / 7.1 - 0.00 / 7.1) = 1.53$ ksf

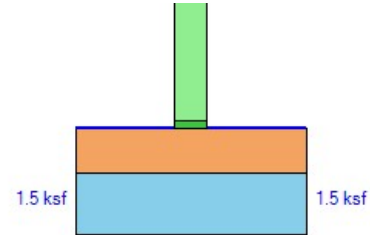
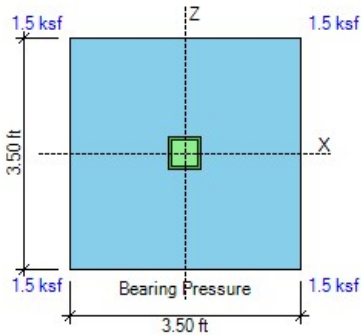

SLIDING CALCULATIONS (Comb: 0.6D+0.6W)

Internal friction angle = 28.0 deg

Passive coefficient $k_p = 4.33$ (per Coulomb)

Pressure at mid-depth = $k_p * Density * (Cover + Thick / 2) = 4.33 * 110 * (0.00 + 8.0 / 12 / 2) = 0.16$ ksf

X-Passive force = $Pressure * Thick * Width = 0.16 * 8.0 / 12 * 3.50 = 0.4$ kip

Z-Passive force = $Pressure * Thick * Length = 0.16 * 8.0 / 12 * 3.50 = 0.4$ kip

Friction force = $Resisting\ force * Friction\ coeff. = \text{Max}(0, 3.5 * 0.35) = 1.2$ kip

Use 100% of Passive + 100% of Friction for sliding resistance

$$\text{- Sliding safety factor X-X} = \frac{X\text{-Passive force} + \text{Friction}}{X\text{-Horizontal load}} = \frac{1.00 * 0.4 + 1.00 * 1.2}{0.0} = 16.12 > 1.50 \text{ OK}$$

$$\text{- Sliding safety factor Z-Z} = \frac{Z\text{-Passive force} + \text{Friction}}{Z\text{-Horizontal load}} = \frac{1.00 * 0.4 + 1.00 * 1.2}{0.0} = 16.12 > 1.50 \text{ OK}$$

UPLIFT CALCULATIONS (Comb: 0.6D+0.6W)

$$\text{- Uplift safety factor} = \frac{\text{Pedestal} + \text{Footing} + \text{Cover} - \text{Buoyancy}}{\text{Uplift load}} = \frac{0.0 + 0.7 + 0.0 - 0.3}{0.0} = 99.99 > 1.00 \text{ OK}$$

ONE-WAY SHEAR CALCULATIONS (Comb: 1.2D+1.6L+0.5Lr)

Concrete $f_c = 2.5$ ksi

Steel $f_y = 40.0$ ksi

Soil density = 110 pcf

d Top X-dir = $Thick - Cover - X\text{-diameter} / 2 = 8.0 - 2.0 - 0.8 / 2 = 5.6$ in

d Top Z-dir = $Thick - Cover - X\text{-diameter} - Z\text{-diameter} / 2 = 8.0 - 2.0 - 0.8 - 0.8 / 2 = 4.9$ in

d Bot X-dir = $Thick - Cover - X\text{-diameter} / 2 = 8.0 - 3.0 - 0.5 / 2 = 4.8$ in

d Bot Z-dir = $Thick - Cover - X\text{-diameter} - Z\text{-diameter} / 2 = 8.0 - 3.0 - 0.5 - 0.5 / 2 = 4.3$ in

$\phi V_{cx} = 2 * \phi * \sqrt{f_c} * Width * d / 1000 = 2 * 0.75 * \sqrt{2500} * 3.5 * 12 * 4.8 / 1000 = 15.0$ kip

ACI Eq. (22.5.5.1)

$\phi V_{cz} = 2 * \phi * \sqrt{f_c} * Length * d / 1000 = 2 * 0.75 * \sqrt{2500} * 3.5 * 12 * 4.3 / 1000 = 13.4$ kip

- Shear forces calculated as the volume of the bearing pressures under the effective areas:

One-way shear V_{ux} (- Side) = 8.6 kip < 15.0 kip OK

One-way shear V_{ux} (+ Side) = 8.6 kip < 15.0 kip OK

One-way shear V_{uz} (- Side) = 8.6 kip < 13.4 kip OK

One-way shear V_{uz} (+ Side) = 8.6 kip < 13.4 kip OK

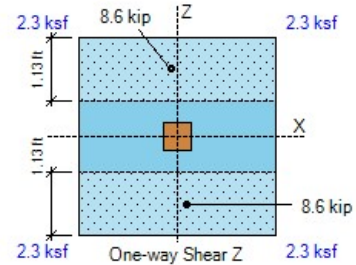
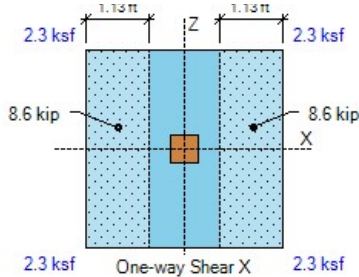

FLEXURE CALCULATIONS (Comb: 1.2D+1.6L+0.5Lr)

Plain $\phi M_{nx} = 5 * \phi * \sqrt{f_c} * L * Thick^2 / 6 = 5 * 0.60 * \sqrt{(2500)} * 3.50 * 8.0^2 / 6 / 1000 = 1.5 \text{ k-ft}$ ACI Eq. (14.5.2.1a)

Plain $\phi M_{nz} = 5 * \phi * \sqrt{f_c} * W * Thick^2 / 6 = 5 * 0.60 * \sqrt{(2500)} * 3.50 * 8.0^2 / 6 / 1000 = 1.5 \text{ k-ft}$

- Top Bars

No Top Reinforcement Provided at the Footing

Use Plain Concrete Flexural Strength at Top

- Top moments calculated as the overburden minus the bearing pressures times the lever arm:

Top moment -M_x (- Side) = 0.0 k-ft < 5.6 k-ft OK

Top moment -M_x (+ Side) = 0.0 k-ft < 5.6 k-ft OK

Top moment -M_z (- Side) = 0.0 k-ft < 5.6 k-ft OK

Top moment -M_z (+ Side) = 0.0 k-ft < 5.6 k-ft OK

- Bottom Bars

Use 5 #4 Z-Bars $\rho = A_s / b d = 1.0 / (3.50 * 12 * 4.3) = 0.0056$

$q = 0.0056 * 40 / 2.5 = 0.090$

Use 5 #4 X-Bars $\rho = A_s / b d = 1.0 / (3.50 * 12 * 4.8) = 0.0050$

$q = 0.0050 * 40 / 2.5 = 0.080$

$\beta = L / W = 3.50 / 3.50 = 1.00$ $\gamma_s = 2 * \beta / (\beta + 1) = 2 * 1.00 / (1.00 + 1) = 1.00$

ACI 13.3.3.3

Bending strength $\phi M_n = \phi * b * d^2 * f_c * q * (1 - 0.59 * q)$

ACI 22.2.2

$\phi M_{nx} = 0.90 * 3.50 * 12 * 4.3^2 * 2.5 * 0.090 * (1 - 0.59 * 0.090) = 12.1 \text{ k-ft}$

$\phi M_{nz} = 0.90 * 3.50 * 12 * 4.8^2 * 2.5 * 0.080 / 1.00 * (1 - 0.59 * 0.080 / 1.00) = 13.6 \text{ k-ft}$

- Bottom moments calculated as the bearing minus the overburden pressures times the lever arm:

Bottom moment M_x (- Side) = 8.6 k-ft < 12.1 k-ft OK ratio = 0.71

Bottom moment M_x (+ Side) = 8.6 k-ft < 12.1 k-ft OK ratio = 0.71

Bottom moment M_z (- Side) = 8.6 k-ft < 13.6 k-ft OK ratio = 0.63

Bottom moment M_z (+ Side) = 8.6 k-ft < 13.6 k-ft OK ratio = 0.63

X-As min = $0.0018 * Width * Thick = 0.0018 * 3.50 * 12 * 8.0 = 0.6 \text{ in}^2$ < 1.0 in² OK

ACI 8.6.1.1

Z-As min = $0.0018 * Length * Thick = 0.0018 * 3.50 * 12 * 8.0 = 0.6 \text{ in}^2$ < 1.0 in² OK

ACI 8.6.1.1

X-As max for 0.005 tension strain = 3.20 in² > 1.00 in² OK

ACI 21.2.2

Z-As max for 0.005 tension strain = 3.20 in² > 1.00 in² OK

ACI 21.2.2

X-Cover factor = $Min(2.5, (Cover + db / 2, Spacing / 2) / db) = Min(2.5, (3.0 + 0.50 / 2, 9.0 / 2) / 0.50) = 2.5$

Straight X-Ld = $Max(12.0, 3 / 40 * f_y / (f_c)^{1/2} * Grade * Size * Casting / Cover * db * ratio)$

ACI Eq. (25.4.2.3a)

X-Ld = $Max(12.0, 3 / 40 * 40.0 * 1000 / (2500)^{1/2} * 1.0 * 0.8 * 1.0 / 2.5 * 0.50 * 0.63) = 12.0 \text{ in}$

Hooked X-Ldh = $Max(8 db, 6, 0.02 * f_y / (f_c)^{1/2} * Confining * Location * Concrete * db * ratio) =$

ACI 25.4.3

X-Ldh = $Max(8 db, 6, 0.02 * 40.0 * 1000 / (2500)^{1/2} * 1.0 * 0.7 * 0.0 * 0.50 * 0.63) = 6.0 \text{ in}$

-X Ld provided = $(Length - Col) / 2 + Offset - Cover = 3.50 * 12 / 2 + 0.0 - 6.0 / 2 - 2.5 = 15.5 \text{ in}$ > 12.0 in OK

+X Ld provided = $(Length - Col) / 2 - Offset - Cover = 3.50 * 12 / 2 - 0.0 - 6.0 / 2 - 2.5 = 15.5 \text{ in}$ > 12.0 in OK

Z-Cover factor = $\text{Min}(2.5, (\text{Cover} + db / 2, \text{Spacing} / 2) / db) = \text{Min}(2.5, (3.0 + 0.50 / 2, 9.0 / 2) / 0.50) = 2.5$

Straight Z-Ld = $\text{Max}(12.0, 3 / 40 * fy / (fc)^{1/2} * \text{Grade} * \text{Size} * \text{Casting} / \text{Cover} * db * \text{ratio})$ ACI Eq. (25.4.2.3a)

Z-Ld = $\text{Max}(12.0, 3 / 40 * 40.0 * 1000 / (2500)^{1/2} * 1.0 * 0.8 * 1.0 / 2.5 * 0.50 * 0.63) = 12.0 \text{ in}$

Hooked Z-Ldh = $\text{Max}(8 db, 6, 0.02 * fy / (fc)^{1/2} * \text{Confining} * \text{Location} * \text{Concrete} * db * \text{ratio}) =$ ACI 25.4.3

Z-Ldh = $\text{Max}(8 db, 6, 0.02 * 40.0 * 1000 / (2500)^{1/2} * 1.0 * 0.7 * 0.0 * 0.50 * 0.71) = 6.0 \text{ in}$

-Z Ld provided = $(\text{Width} - \text{Col}) / 2 + \text{Offset} - \text{Cover} = 3.50 * 12 / 2 + 0.0 - 6.0 / 2 - 2.5 = 15.5 \text{ in} > 12.0 \text{ in OK}$

+Z Ld provided = $(\text{Width} - \text{Col}) / 2 - \text{Offset} - \text{Cover} = 3.50 * 12 / 2 - 0.0 - 6.0 / 2 - 2.5 = 15.5 \text{ in} > 12.0 \text{ in OK}$

X-bar spacing = 9.0 in < $\text{Min}(3 * t, 18.0) = 18.0 \text{ in OK}$ ACI 7.7.2.3

Z-bar spacing = 9.0 in < $\text{Min}(3 * t, 18.0) = 18.0 \text{ in OK}$

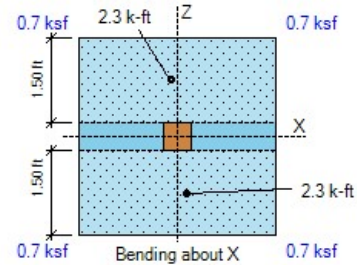
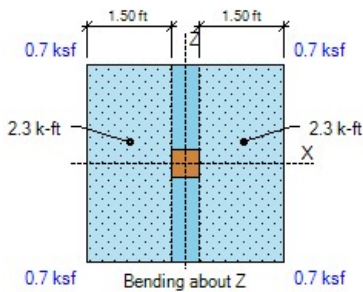

LOAD TRANSFER CALCULATIONS (Comb: 1.2D+1.6L+0.5Lr)

Area $A1 = col L * col W = 6.0 * 6.0 = 36.0 \text{ in}^2$

$Sx = col W * col L^2 / 6 = 6.0 * 6.0^2 / 6 = 36.0 \text{ in}^3$

$Sz = col L * col W^2 / 6 = 6.0 * 6.0^2 / 6 = 36.0 \text{ in}^3$

Bearing $Pbu = P / A1 + Mz / Sx + Mx / Sz = 26.7 / 36.0 + 0.0 * 12 / 36.0 + 0.0 * 12 / 36.0 = 0.7 \text{ ksi}$

Min edge = $\text{Min}(L / 2 - X\text{-offset} - col L / 2, W / 2 - Z\text{-offset} - col W / 2)$

Min edge = $\text{Min}(3.50 * 12 / 2 - 0.0 - 6.0 / 2, 3.50 * 12 / 2 - 0.0 - 6.0 / 2) = 18.0 \text{ in}$

Area $A2 = \text{Min}[L * W, (col L + 2 * \text{Min edge}) * (col W + 2 * \text{Min edge})]$ ACI R22.8.3.2

$A2 = \text{Min}[3.50 * 12 * 3.5 * 12, (6.0 + 2 * 18.0) * (6.0 + 2 * 18.0)] = 1764.0 \text{ in}^2$

Footing $\phi Pnc = \phi * 0.85 * fc * \text{Min}[2, \sqrt{(A2 / A1)}] = 0.65 * 0.85 * 2.5 * \text{Min}[2, \sqrt{(1764.0 / 36.0)}] = 2.8 \text{ ksi}$

Footing $\phi Pns = \phi * As * Fy / A1 = 0.0 \text{ ksi}$ ACI 22.8.3.2

Footing bearing $\phi Pn = \phi Pnc + \phi Pns = 2.8 + 0.0 = 2.8 \text{ ksi} > 0.7 \text{ psi OK}$

Hooked $L_{dh} = \text{Max}(8 db, 6, 0.02 * f_y / (f_c)^{1/2} * \text{Confining} * \text{Location} * \text{Concrete} * db * \text{ratio})$

ACI 25.4.3

$$L_{dh} = \text{Max}(8 db, 6, 0.02 * 60.0 * 1000 / (2500)^{1/2} * 1.0 * 0.7 * 0.0 * 0.75 * 0.13) = 6.0 \text{ in}$$

Ld provided = Dowel length = $3.00 * 12 = 36.0 \text{ in} > 23.1 \text{ in OK}$

Ldh provided = Footing thickness - Cover = $8.00 - 3.0 = 5.0 \text{ in} < 6.0 \text{ in NG}$

PUNCHING SHEAR CALCULATIONS (Comb: 1.2D+1.6L+0.5Lr)

X-Edge = $d/2 = 4.5 / 2 = 2.3 \text{ in}$ $as_x = 20$

Z-Edge = $d/2 = 4.5 / 2 = 2.3 \text{ in}$ $as_z = 20$

$as = as_x + as_z = 20 + 20 = 40$ Col type = Interior $\beta = L / W = 6.0 / 6.0 = 1.00$

ACI 22.6.5.2

Perimeter $bo = as_z / 10 * (L + d/2 + X\text{-Edge}) + as_x / 10 * (W + d/2 + Z\text{-Edge})$

ACI 22.6.4.2

$$bo = 20 / 10 * (6.0 + 4.5 / 2 + 2.3) + 20 / 10 * (6.0 + 4.5 / 2 + 2.3) = 42.0 \text{ in}$$

Area $A_{bo} = (L + d/2 + X\text{-Edge}) * (W + d/2 + Z\text{-Edge}) = (6.0 + 4.5 / 2 + 2.3) * (6.0 + 4.5 / 2 + 2.3) = 110.3 \text{ in}^2$

$\phi V_c = \phi * \text{Min}(2 + 4 / \beta, as * d / bo + 2, 4) * \sqrt{f_c}$

ACI 22.6.5.2

$$\phi V_c = 0.75 * \text{Min}(2 + 4 / 1.00, 40 * 4.5 / 42.0 + 2, 4) * \sqrt{2500} = 150.0 \text{ psi}$$

Punching force $F = P + \text{Overburden} * A_{bo} - \text{Bearing}$

$$F = 26.7 + 0.07 * 110.3 / 144 - 1.7 = 25.1 \text{ kip}$$

$b_1 = L + d/2 + X\text{-Edge} = 6.0 + 4.5 / 2 + 2.3 = 10.5 \text{ in}$ $b_2 = W + d/2 + Z\text{-Edge} = 6.0 + 4.5 / 2 + 2.3 = 10.5 \text{ in}$

$\gamma_{vx} \text{ factor} = 1 - \frac{1}{1 + (2/3) \sqrt{b_2 / b_1}} = 1 - \frac{1}{1 + (2/3) \sqrt{10.5 / 10.5}} = 0.40$

ACI Eq. (8.4.4.2.2)

$\gamma_{vz} \text{ factor} = 1 - \frac{1}{1 + (2/3) \sqrt{b_1 / b_2}} = 1 - \frac{1}{1 + (2/3) \sqrt{10.5 / 10.5}} = 0.40$

ACI Eq. (8.4.2.3.2)

$X_{2z} = b_1 / 2 = 10.5 / 2 = 5.3 \text{ in}$ $X_{2x} = b_2 / 2 = 10.5 / 2 = 5.3 \text{ in}$

$J_{cz} = b_1 * d^3 / 6 + b_1^3 * d / 6 + b_1^2 * b_2 * d / 2$

ACI R8.4.4.2.3

$$J_{cz} = 10.5 * 4.5^3 / 6 + 10.5^3 * 4.5 / 6 + 10.5^2 * 10.5 * 4.5 / 2 = 3632 \text{ in}^4$$

$J_{cx} = b_2 * d^3 / 6 + b_2^3 * d / 6 + b_2^2 * b_1 * d / 2$

ACI R8.4.4.2.3

$$J_{cx} = 10.5 * 4.5^3 / 6 + 10.5^3 * 4.5 / 6 + 10.5^2 * 10.5 * 4.5 / 2 = 3632 \text{ in}^4$$

Stress due to P = $F / (bo * d) * 1000 = 25.1 / (42.0 * 4.5) * 1000 = 132.5 \text{ psi}$

Stress due to Mx = $\gamma_{vx} * X\text{-OTM} * X_{2x} / J_{cx} = 0.40 * 0.0 * 12 * 5.3 / 3632 * 1000 = 0.0 \text{ psi}$

Stress due to Mz = $\gamma_{vz} * Z\text{-OTM} * X_{2z} / J_{cz} = 0.40 * 0.0 * 12 * 5.3 / 3632 * 1000 = 0.0 \text{ psi}$

Punching stress = $P\text{-stress} + Mx\text{-stress} + Mz\text{-stress} = 132.5 + 0.0 + 0.0 = 132.5 \text{ psi} < 150.0 \text{ psi OK}$

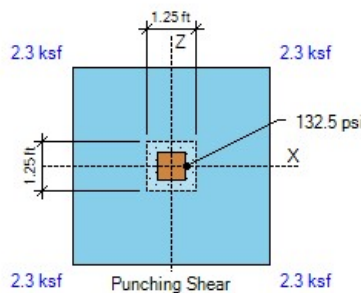

DESIGN CODES

Concrete Design ACI 318-14
Load Combinations ASCE 7-10/16

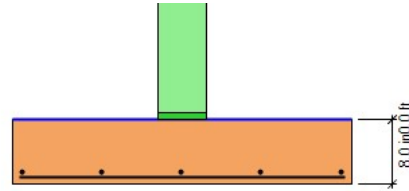

ELEVATION

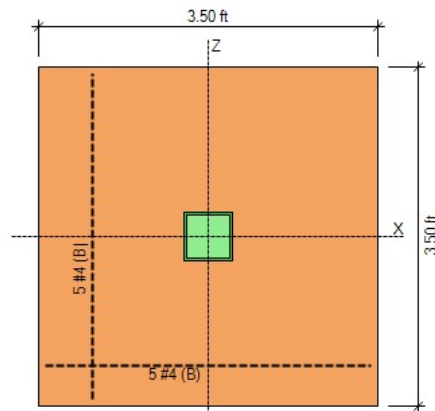

PLAN

Project:
 Engineer:
 Descip: Grid 5D Footing

Page # ____
 2/27/2024

ASDIP Foundation 4.8.2.7

SPREAD FOOTING DESIGN

www.asdipsoft.com

GEOMETRY				SOIL PRESSURES (D+L)			
Footing Length (X-dir)	3.50	ft		Gross Allow. Soil Pressure	2.0	ksf	
Footing Width (Z-dir)	3.50	ft		Soil Pressure at Corner 1	1.8	ksf	
Footing Thickness	8.0	in	OK	Soil Pressure at Corner 2	1.8	ksf	
Soil Cover	0.00	ft		Soil Pressure at Corner 3	1.8	ksf	
Column Length (X-dir)	6.0	in		Soil Pressure at Corner 4	1.8	ksf	
Column Width (Z-dir)	6.0	in		Bearing Pressure Ratio	0.90	OK	
Offset (X-dir)	0.00	in	OK	Ftg. Area in Contact with Soil	100.0	%	
Offset (Z-dir)	0.00	in	OK	X-eccentricity / Ftg. Length	0.00	OK	
Base Plate (L x W)	6.0 x 6.0	in		Z-eccentricity / Ftg. Width	0.00	OK	

APPLIED LOADS

	Dead	Live	RLive	Snow	Wind	Seismic	
Axial Force P	6.0	15.3	0.0	0.0	0.0	0.0	kip
Moment about X Mx	0.0	0.0	0.0	0.0	0.0	0.0	k-ft
Moment about Z Mz	0.0	0.0	0.0	0.0	0.0	0.0	k-ft
Shear Force Vx	0.0	0.0	0.0	0.0	0.0	0.0	kip
Shear Force Vz	0.0	0.0	0.0	0.0	0.0	0.0	kip

OVERTURNING CALCULATIONS (Comb: 0.6D+0.6W)

- Overturning about X-X

- Moment Mx = 0.6 * 0.0 + 0.6 * 0.0 = 0.0 k-ft

- Shear Force Vz = 0.6 * 0.0 + 0.6 * 0.0 = 0.0 kip

Arm = 0.00 + 8.0 / 12 = 0.67 ft

Moment = 0.0 * 0.67 = 0.0 k-ft

- Passive Force = 0.0 kip

Arm = 0.27 ft

Moment = 0.0 k-ft

- Overturning moment X-X = 0.0 + 0.0 = 0.0 k-ft

- Resisting about X-X

- Footing weight = 0.6 * W * L * Thick * Density = 0.6 * 3.50 * 3.50 * 8.0 / 12 * 0.15 = 0.7 kip

Arm = W / 2 = 3.50 / 2 = 1.75 ft

Moment = 0.7 * 1.75 = 1.3 k-ft

- Pedestal weight = 0.6 * W * L * H * Density = 0.6 * 6.0 / 12 * 6.0 / 12 * 0.0 * 0.15 = 0.0 kip

Arm = W / 2 - Offset = 3.50 / 2 - 0.0 / 12 = 1.75 ft

Moment = 0.0 * 1.75 = 0.0 k-ft

- Soil cover = 0.6 * W * L * SC * Density = 0.6 * (3.50 * 3.50 - 6.0 / 12 * 6.0 / 12) * 0.0 * 110 = 0.0 kip

Arm = W / 2 = 3.50 / 2 = 1.75 ft

Moment = 0.0 * 1.75 = 0.0 k-ft

- Buoyancy = 0.6 * W * L * γ * (SC + Thick - WT) = 0.6 * 3.50 * 3.50 * 62 * (0.67) = -0.3 kip

Arm = W / 2 = 3.50 / 2 = 1.75 ft

Moment = 0.3 * 1.75 = -0.5 k-ft

- Axial force P = 0.6 * 6.0 + 0.6 * 0.0 = 3.6 kip

Arm = W / 2 - Offset = 3.50 / 2 - 0.0 / 12 = 1.75 ft

Moment = 3.6 * 1.75 = 6.3 k-ft

- Resisting moment X-X = 1.3 + 0.0 + 0.0 + 6.3 + -0.5 = 7.1 k-ft

- Overturning safety factor X-X = $\frac{\text{Resisting moment}}{\text{Overturning moment}} = \frac{7.1}{0.0} = 70.51 > 1.50$ OK

- **Overturning about Z-Z**

- Moment $M_z = 0.6 * 0.0 + 0.6 * 0.0 = 0.0$ k-ft

- Shear Force $V_x = 0.6 * 0.0 + 0.6 * 0.0 = 0.0$ kip

Arm = $0.00 + 8.0 / 12 = 0.67$ ft

Moment = $0.0 * 0.67 = 0.0$ k-ft

- Passive Force = 0.0 kip

Arm = 0.27 ft

Moment = 0.0 k-ft

- Overturning moment Z-Z = $0.0 + 0.0 = 0.0$ k-ft

- **Resisting about Z-Z**

- Footing weight = $0.6 * W * L * Thick * Density = 0.6 * 3.50 * 3.50 * 8.0 / 12 * 0.15 = 0.7$ kip

Arm = $L / 2 = 3.50 / 2 = 1.75$ ft

Moment = $0.7 * 1.75 = 1.3$ k-ft

- Pedestal weight = $0.6 * W * L * H * Density = 0.6 * 6.0 / 12 * 6.0 / 12 * 0.0 * 0.15 = 0.0$ kip

Arm = $L / 2 - Offset = 3.50 / 2 - 0.0 / 12 = 1.75$ ft

Moment = $0.0 * 1.75 = 0.0$ k-ft

- Soil cover = $0.6 * W * L * SC * Density = 0.6 * (3.50 * 3.50 - 6.0 / 12 * 6.0 / 12) * 0.0 * 110 = 0.0$ kip

Arm = $L / 2 = 3.50 / 2 = 1.75$ ft

Moment = $0.0 * 1.75 = 0.0$ k-ft

- Buoyancy = $0.6 * W * L * \gamma * (SC + Thick - WT) = 0.6 * 3.50 * 3.50 * 62 * (0.67) = -0.3$ kip

Arm = $L / 2 = 3.50 / 2 = 1.75$ ft

Moment = $0.3 * 1.75 = -0.5$ k-ft

- Axial force $P = 0.6 * 6.0 + 0.6 * 0.0 = 3.6$ kip

Arm = $L / 2 - Offset = 3.50 / 2 - 0.0 / 12 = 1.75$ ft

Moment = $3.6 * 1.75 = 6.3$ k-ft

- Resisting moment Z-Z = $1.3 + 0.0 + 0.0 + 6.3 + -0.5 = 7.1$ k-ft

- Overturning safety factor Z-Z = $\frac{Resisting\ moment}{Overturning\ moment} = \frac{7.1}{0.0} = 70.51 > 1.50$ OK

SOIL BEARING PRESSURES (Comb: D+L)

Overturning moment X-X = $0.0 + 0.0 = 0.0$ k-ft

Resisting moment X-X = $2.1 + 0.0 + 0.0 + -0.9 + 37.3 = 38.5$ k-ft

Overturning moment Z-Z = $0.0 + 0.0 = 0.0$ k-ft

Resisting moment Z-Z = $2.1 + 0.0 + 0.0 + -0.9 + 37.3 = 38.5$ k-ft

Resisting force = $Footing + Pedestal + Soil - Buoyancy + P = 1.2 + 0.0 + 0.0 - 0.5 + 21.3 = 22.0$ kip

X-coordinate of resultant from maximum bearing corner:

$$X_p = \frac{Z-Resisting\ moment - Z-Overturning\ moment}{Resisting\ force} = \frac{38.5 - 0.0}{22.0} = 1.75\text{ ft}$$

Z-coordinate of resultant from maximum bearing corner:

$$Z_p = \frac{X-Resisting\ moment - X-Overturning\ moment}{Resisting\ force} = \frac{38.5 - 0.0}{22.0} = 1.75\text{ ft}$$

X-ecc = $Length / 2 - X_p = 3.50 / 2 - 1.75 = 0.00$ ft

Z-ecc = $Width / 2 - Z_p = 3.50 / 2 - 1.75 = 0.00$ ft

Area = $Width * Length = 3.50 * 3.50 = 12.3$ ft²

$S_x = Length * Width^2 / 6 = 3.50 * 3.50^2 / 6 = 7.1$ ft³

$S_z = Width * Length^2 / 6 = 3.50 * 3.50^2 / 6 = 7.1$ ft³

- Footing is in full bearing. Soil pressures are as follows:

$P_1 = P * (1/A + Z-ecc / S_x + X-ecc / S_z) = 22.0 * (1 / 12.3 + 0.00 / 7.1 + 0.00 / 7.1) = 1.80$ ksf

$P_2 = P * (1/A - Z-ecc / S_x + X-ecc / S_z) = 22.0 * (1 / 12.3 - 0.00 / 7.1 + 0.00 / 7.1) = 1.80$ ksf

$P_3 = P * (1/A - Z-ecc / S_x - X-ecc / S_z) = 22.0 * (1 / 12.3 - 0.00 / 7.1 - 0.00 / 7.1) = 1.80$ ksf

$P_4 = P * (1/A + Z-ecc / S_x - X-ecc / S_z) = 22.0 * (1 / 12.3 + 0.00 / 7.1 - 0.00 / 7.1) = 1.80$ ksf

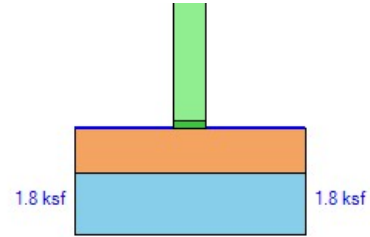
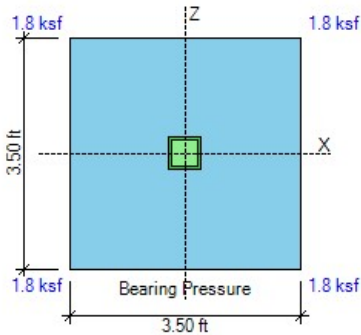

SLIDING CALCULATIONS (Comb: 0.6D+0.6W)

Internal friction angle = 28.0 deg

Passive coefficient $k_p = 4.33$ (per Coulomb)

Pressure at mid-depth = $k_p * Density * (Cover + Thick / 2) = 4.33 * 110 * (0.00 + 8.0 / 12 / 2) = 0.16$ ksf

X-Passive force = $Pressure * Thick * Width = 0.16 * 8.0 / 12 * 3.50 = 0.4$ kip

Z-Passive force = $Pressure * Thick * Length = 0.16 * 8.0 / 12 * 3.50 = 0.4$ kip

Friction force = $Resisting\ force * Friction\ coeff. = \text{Max}(0, 4.0 * 0.35) = 1.4$ kip

Use 100% of Passive + 100% of Friction for sliding resistance

$$\text{- Sliding safety factor X-X} = \frac{X\text{-Passive force} + \text{Friction}}{X\text{-Horizontal load}} = \frac{1.00 * 0.4 + 1.00 * 1.4}{0.0} = 17.80 > 1.50 \text{ OK}$$

$$\text{- Sliding safety factor Z-Z} = \frac{Z\text{-Passive force} + \text{Friction}}{Z\text{-Horizontal load}} = \frac{1.00 * 0.4 + 1.00 * 1.4}{0.0} = 17.80 > 1.50 \text{ OK}$$

UPLIFT CALCULATIONS (Comb: 0.6D+0.6W)

$$\text{- Uplift safety factor} = \frac{\text{Pedestal} + \text{Footing} + \text{Cover} - \text{Buoyancy}}{\text{Uplift load}} = \frac{0.0 + 0.7 + 0.0 - 0.3}{0.0} = 99.99 > 1.00 \text{ OK}$$

ONE-WAY SHEAR CALCULATIONS (Comb: 1.2D+1.6L+0.5Lr)

Concrete $f_c = 2.5$ ksi

Steel $f_y = 40.0$ ksi

Soil density = 110 pcf

d Top X-dir = $Thick - Cover - X\text{-diameter} / 2 = 8.0 - 2.0 - 0.8 / 2 = 5.6$ in

d Top Z-dir = $Thick - Cover - X\text{-diameter} - Z\text{-diameter} / 2 = 8.0 - 2.0 - 0.8 - 0.8 / 2 = 4.9$ in

d Bot X-dir = $Thick - Cover - X\text{-diameter} / 2 = 8.0 - 3.0 - 0.5 / 2 = 4.8$ in

d Bot Z-dir = $Thick - Cover - X\text{-diameter} - Z\text{-diameter} / 2 = 8.0 - 3.0 - 0.5 - 0.5 / 2 = 4.3$ in

$\phi V_{cx} = 2 * \phi * \sqrt{f_c} * Width * d / 1000 = 2 * 0.75 * \sqrt{2500} * 3.5 * 12 * 4.8 / 1000 = 15.0$ kip

ACI Eq. (22.5.5.1)

$\phi V_{cz} = 2 * \phi * \sqrt{f_c} * Length * d / 1000 = 2 * 0.75 * \sqrt{2500} * 3.5 * 12 * 4.3 / 1000 = 13.4$ kip

- Shear forces calculated as the volume of the bearing pressures under the effective areas:

One-way shear V_{ux} (- Side) = 10.2 kip < 15.0 kip OK

One-way shear V_{ux} (+ Side) = 10.2 kip < 15.0 kip OK

One-way shear V_{uz} (- Side) = 10.2 kip < 13.4 kip OK

One-way shear V_{uz} (+ Side) = 10.2 kip < 13.4 kip OK

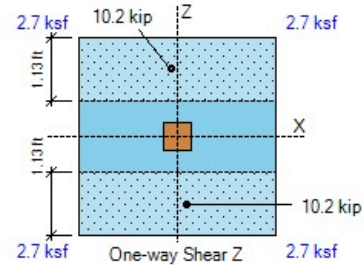
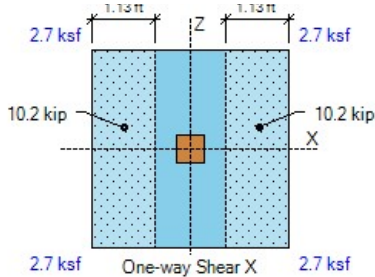

FLEXURE CALCULATIONS (Comb: 1.2D+1.6L+0.5Lr)

Plain $\phi M_{nx} = 5 * \phi * \sqrt{f_c} * L * Thick^2 / 6 = 5 * 0.60 * \sqrt{(2500)} * 3.50 * 8.0^2 / 6 / 1000 = 1.5 \text{ k-ft}$ ACI Eq. (14.5.2.1a)

Plain $\phi M_{nz} = 5 * \phi * \sqrt{f_c} * W * Thick^2 / 6 = 5 * 0.60 * \sqrt{(2500)} * 3.50 * 8.0^2 / 6 / 1000 = 1.5 \text{ k-ft}$

- Top Bars

No Top Reinforcement Provided at the Footing

Use Plain Concrete Flexural Strength at Top

- Top moments calculated as the overburden minus the bearing pressures times the lever arm:

Top moment -M_x (- Side) = 0.0 k-ft < 5.6 k-ft OK

Top moment -M_x (+ Side) = 0.0 k-ft < 5.6 k-ft OK

Top moment -M_z (- Side) = 0.0 k-ft < 5.6 k-ft OK

Top moment -M_z (+ Side) = 0.0 k-ft < 5.6 k-ft OK

- Bottom Bars

Use 5 #4 Z-Bars $\rho = A_s / b d = 1.0 / (3.50 * 12 * 4.3) = 0.0056$

$q = 0.0056 * 40 / 2.5 = 0.090$

Use 5 #4 X-Bars $\rho = A_s / b d = 1.0 / (3.50 * 12 * 4.8) = 0.0050$

$q = 0.0050 * 40 / 2.5 = 0.080$

$\beta = L / W = 3.50 / 3.50 = 1.00$ $\gamma_s = 2 * \beta / (\beta + 1) = 2 * 1.00 / (1.00 + 1) = 1.00$

ACI 13.3.3.3

Bending strength $\phi M_n = \phi * b * d^2 * f_c * q * (1 - 0.59 * q)$

ACI 22.2.2

$\phi M_{nx} = 0.90 * 3.50 * 12 * 4.3^2 * 2.5 * 0.090 * (1 - 0.59 * 0.090) = 12.1 \text{ k-ft}$

$\phi M_{nz} = 0.90 * 3.50 * 12 * 4.8^2 * 2.5 * 0.080 / 1.00 * (1 - 0.59 * 0.080 / 1.00) = 13.6 \text{ k-ft}$

- Bottom moments calculated as the bearing minus the overburden pressures times the lever arm:

Bottom moment M_x (- Side) = 10.2 k-ft < 12.1 k-ft OK ratio = 0.84

Bottom moment M_x (+ Side) = 10.2 k-ft < 12.1 k-ft OK ratio = 0.85

Bottom moment M_z (- Side) = 10.2 k-ft < 13.6 k-ft OK ratio = 0.75

Bottom moment M_z (+ Side) = 10.2 k-ft < 13.6 k-ft OK ratio = 0.75

X-As min = $0.0018 * Width * Thick = 0.0018 * 3.50 * 12 * 8.0 = 0.6 \text{ in}^2$ < 1.0 in² OK

ACI 8.6.1.1

Z-As min = $0.0018 * Length * Thick = 0.0018 * 3.50 * 12 * 8.0 = 0.6 \text{ in}^2$ < 1.0 in² OK

ACI 8.6.1.1

X-As max for 0.005 tension strain = 3.20 in² > 1.00 in² OK

ACI 21.2.2

Z-As max for 0.005 tension strain = 3.20 in² > 1.00 in² OK

ACI 21.2.2

X-Cover factor = $Min(2.5, (Cover + db / 2, Spacing / 2) / db) = Min(2.5, (3.0 + 0.50 / 2, 9.0 / 2) / 0.50) = 2.5$

Straight X-Ld = $Max(12.0, 3 / 40 * f_y / (f_c)^{1/2} * Grade * Size * Casting / Cover * db * ratio)$

ACI Eq. (25.4.2.3a)

X-Ld = $Max(12.0, 3 / 40 * 40.0 * 1000 / (2500)^{1/2} * 1.0 * 0.8 * 1.0 / 2.5 * 0.50 * 0.75) = 12.0 \text{ in}$

Hooked X-Ldh = $Max(8 db, 6, 0.02 * f_y / (f_c)^{1/2} * Confining * Location * Concrete * db * ratio) =$

ACI 25.4.3

X-Ldh = $Max(8 db, 6, 0.02 * 40.0 * 1000 / (2500)^{1/2} * 1.0 * 0.7 * 0.0 * 0.50 * 0.75) = 6.0 \text{ in}$

-X Ld provided = $(Length - Col) / 2 + Offset - Cover = 3.50 * 12 / 2 + 0.0 - 6.0 / 2 - 2.5 = 15.5 \text{ in}$ > 12.0 in OK

+X Ld provided = $(Length - Col) / 2 - Offset - Cover = 3.50 * 12 / 2 - 0.0 - 6.0 / 2 - 2.5 = 15.5 \text{ in}$ > 12.0 in OK

Z-Cover factor = $\text{Min}(2.5, (\text{Cover} + db / 2, \text{Spacing} / 2) / db) = \text{Min}(2.5, (3.0 + 0.50 / 2, 9.0 / 2) / 0.50) = 2.5$

Straight Z-Ld = $\text{Max}(12.0, 3 / 40 * fy / (fc)^{1/2} * \text{Grade} * \text{Size} * \text{Casting} / \text{Cover} * db * \text{ratio})$ ACI Eq. (25.4.2.3a)

Z-Ld = $\text{Max}(12.0, 3 / 40 * 40.0 * 1000 / (2500)^{1/2} * 1.0 * 0.8 * 1.0 / 2.5 * 0.50 * 0.75) = 12.0 \text{ in}$

Hooked Z-Ldh = $\text{Max}(8 db, 6, 0.02 * fy / (fc)^{1/2} * \text{Confining} * \text{Location} * \text{Concrete} * db * \text{ratio}) =$ ACI 25.4.3

Z-Ldh = $\text{Max}(8 db, 6, 0.02 * 40.0 * 1000 / (2500)^{1/2} * 1.0 * 0.7 * 0.0 * 0.50 * 0.85) = 6.0 \text{ in}$

-Z Ld provided = $(\text{Width} - \text{Col}) / 2 + \text{Offset} - \text{Cover} = 3.50 * 12 / 2 + 0.0 - 6.0 / 2 - 2.5 = 15.5 \text{ in} > 12.0 \text{ in OK}$

+Z Ld provided = $(\text{Width} - \text{Col}) / 2 - \text{Offset} - \text{Cover} = 3.50 * 12 / 2 - 0.0 - 6.0 / 2 - 2.5 = 15.5 \text{ in} > 12.0 \text{ in OK}$

X-bar spacing = 9.0 in < $\text{Min}(3 * t, 18.0) = 18.0 \text{ in OK}$ ACI 7.7.2.3

Z-bar spacing = 9.0 in < $\text{Min}(3 * t, 18.0) = 18.0 \text{ in OK}$

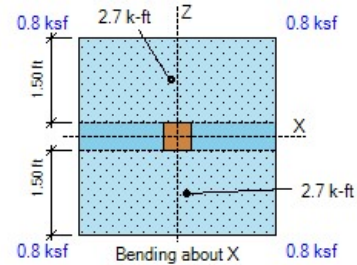
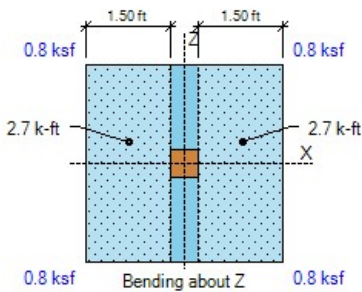

LOAD TRANSFER CALCULATIONS (Comb: 1.2D+1.6L+0.5Lr)

Area $A1 = col L * col W = 6.0 * 6.0 = 36.0 \text{ in}^2$

$Sx = col W * col L^2 / 6 = 6.0 * 6.0^2 / 6 = 36.0 \text{ in}^3$

$Sz = col L * col W^2 / 6 = 6.0 * 6.0^2 / 6 = 36.0 \text{ in}^3$

Bearing $Pbu = P / A1 + Mz / Sx + Mx / Sz = 31.7 / 36.0 + 0.0 * 12 / 36.0 + 0.0 * 12 / 36.0 = 0.9 \text{ ksi}$

Min edge = $\text{Min}(L / 2 - X\text{-offset} - col L / 2, W / 2 - Z\text{-offset} - col W / 2)$

Min edge = $\text{Min}(3.50 * 12 / 2 - 0.0 - 6.0 / 2, 3.50 * 12 / 2 - 0.0 - 6.0 / 2) = 18.0 \text{ in}$

Area $A2 = \text{Min}[L * W, (col L + 2 * \text{Min edge}) * (col W + 2 * \text{Min edge})]$

ACI R22.8.3.2

$A2 = \text{Min}[3.50 * 12 * 3.5 * 12, (6.0 + 2 * 18.0) * (6.0 + 2 * 18.0)] = 1764.0 \text{ in}^2$

Footing $\phi Pnc = \phi * 0.85 * fc * \text{Min}[2, \sqrt{(A2 / A1)}] = 0.65 * 0.85 * 2.5 * \text{Min}[2, \sqrt{(1764.0 / 36.0)}] = 2.8 \text{ ksi}$

Footing $\phi Pns = \phi * As * Fy / A1 = 0.0 \text{ ksi}$

ACI 22.8.3.2

Footing bearing $\phi Pn = \phi Pnc + \phi Pns = 2.8 + 0.0 = 2.8 \text{ ksi} > 0.9 \text{ psi OK}$

Hooked $L_{dh} = \text{Max}(8 db, 6, 0.02 * f_y / (f_c)^{1/2} * \text{Confining} * \text{Location} * \text{Concrete} * db * \text{ratio})$

ACI 25.4.3

$$L_{dh} = \text{Max}(8 db, 6, 0.02 * 60.0 * 1000 / (2500)^{1/2} * 1.0 * 0.7 * 0.0 * 0.75 * 0.15) = 6.0 \text{ in}$$

Ld provided = Dowel length = $3.00 * 12 = 36.0 \text{ in} > 27.4 \text{ in OK}$

Ldh provided = Footing thickness - Cover = $8.00 - 3.0 = 5.0 \text{ in} < 6.0 \text{ in NG}$

PUNCHING SHEAR CALCULATIONS (Comb: 1.2D+1.6L+0.5Lr)

X-Edge = $d/2 = 4.5 / 2 = 2.3 \text{ in}$ $as_x = 20$

Z-Edge = $d/2 = 4.5 / 2 = 2.3 \text{ in}$ $as_z = 20$

$as = as_x + as_z = 20 + 20 = 40$ Col type = Interior $\beta = L / W = 6.0 / 6.0 = 1.00$

ACI 22.6.5.2

Perimeter $bo = as_z / 10 * (L + d/2 + X\text{-Edge}) + as_x / 10 * (W + d/2 + Z\text{-Edge})$

ACI 22.6.4.2

$$bo = 20 / 10 * (6.0 + 4.5 / 2 + 2.3) + 20 / 10 * (6.0 + 4.5 / 2 + 2.3) = 42.0 \text{ in}$$

Area $A_{bo} = (L + d/2 + X\text{-Edge}) * (W + d/2 + Z\text{-Edge}) = (6.0 + 4.5 / 2 + 2.3) * (6.0 + 4.5 / 2 + 2.3) = 110.3 \text{ in}^2$

$\phi V_c = \phi * \text{Min}(2 + 4 / \beta, as * d / bo + 2, 4) * \sqrt{f_c}$

ACI 22.6.5.2

$$\phi V_c = 0.75 * \text{Min}(2 + 4 / 1.00, 40 * 4.5 / 42.0 + 2, 4) * \sqrt{2500} = 150.0 \text{ psi}$$

Punching force $F = P + \text{Overburden} * A_{bo} - \text{Bearing}$

$$F = 31.7 + 0.07 * 110.3 / 144 - 2.0 = 29.7 \text{ kip}$$

$b_1 = L + d/2 + X\text{-Edge} = 6.0 + 4.5 / 2 + 2.3 = 10.5 \text{ in}$ $b_2 = W + d/2 + Z\text{-Edge} = 6.0 + 4.5 / 2 + 2.3 = 10.5 \text{ in}$

$\gamma_{vx} \text{ factor} = 1 - \frac{1}{1 + (2/3) \sqrt{b_2 / b_1}} = 1 - \frac{1}{1 + (2/3) \sqrt{10.5 / 10.5}} = 0.40$

ACI Eq. (8.4.4.2.2)

$\gamma_{vz} \text{ factor} = 1 - \frac{1}{1 + (2/3) \sqrt{b_1 / b_2}} = 1 - \frac{1}{1 + (2/3) \sqrt{10.5 / 10.5}} = 0.40$

ACI Eq. (8.4.2.3.2)

$X_{2z} = b_1 / 2 = 10.5 / 2 = 5.3 \text{ in}$ $X_{2x} = b_2 / 2 = 10.5 / 2 = 5.3 \text{ in}$

$J_{cz} = b_1 * d^3 / 6 + b_1^3 * d / 6 + b_1^2 * b_2 * d / 2$

ACI R8.4.4.2.3

$$J_{cz} = 10.5 * 4.5^3 / 6 + 10.5^3 * 4.5 / 6 + 10.5^2 * 10.5 * 4.5 / 2 = 3632 \text{ in}^4$$

$J_{cx} = b_2 * d^3 / 6 + b_2^3 * d / 6 + b_2^2 * b_1 * d / 2$

ACI R8.4.4.2.3

$$J_{cx} = 10.5 * 4.5^3 / 6 + 10.5^3 * 4.5 / 6 + 10.5^2 * 10.5 * 4.5 / 2 = 3632 \text{ in}^4$$

Stress due to P = $F / (bo * d) * 1000 = 29.7 / (42.0 * 4.5) * 1000 = 157.1 \text{ psi}$

Stress due to Mx = $\gamma_{vx} * X\text{-OTM} * X_{2x} / J_{cx} = 0.40 * 0.0 * 12 * 5.3 / 3632 * 1000 = 0.0 \text{ psi}$

Stress due to Mz = $\gamma_{vz} * Z\text{-OTM} * X_{2z} / J_{cz} = 0.40 * 0.0 * 12 * 5.3 / 3632 * 1000 = 0.0 \text{ psi}$

Punching stress = $P\text{-stress} + Mx\text{-stress} + Mz\text{-stress} = 157.1 + 0.0 + 0.0 = 157.1 \text{ psi} > 150.0 \text{ psi NG}$

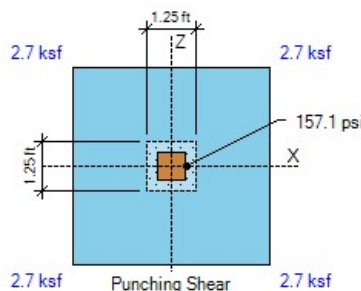

DESIGN CODES

Concrete Design ACI 318-14
Load Combinations ASCE 7-10/16

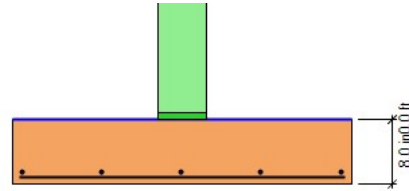

ELEVATION

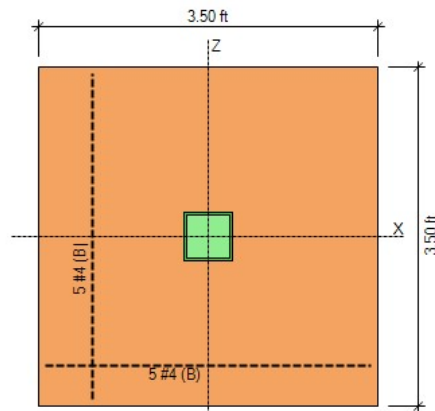

PLAN

GEOMETRY			SOIL PRESSURES (D+L)		
Footing Length (X-dir)	3.50	ft	Gross Allow. Soil Pressure	2.0	ksf
Footing Width (Z-dir)	3.50	ft	Soil Pressure at Corner 1	1.8	ksf
Footing Thickness	8.0	in OK	Soil Pressure at Corner 2	1.8	ksf
Soil Cover	0.00	ft	Soil Pressure at Corner 3	1.8	ksf
Column Length (X-dir)	6.0	in	Soil Pressure at Corner 4	1.8	ksf
Column Width (Z-dir)	6.0	in	Bearing Pressure Ratio	0.90	OK
Offset (X-dir)	0.00	in OK	Ftg. Area in Contact with Soil	100.0	%
Offset (Z-dir)	0.00	in OK	X-eccentricity / Ftg. Length	0.00	OK
Base Plate (L x W)	6.0 x 6.0	in	Z-eccentricity / Ftg. Width	0.00	OK

APPLIED LOADS

	Dead	Live	RLive	Snow	Wind	Seismic	
Axial Force P	6.0	15.3	0.0	0.0	0.0	0.0	kip
Moment about X Mx ..	0.0	0.0	0.0	0.0	0.0	0.0	k-ft
Moment about Z Mz ..	0.0	0.0	0.0	0.0	0.0	0.0	k-ft
Shear Force Vx	0.0	0.0	0.0	0.0	0.0	0.0	kip
Shear Force Vz	0.0	0.0	0.0	0.0	0.0	0.0	kip

OVERTURNING CALCULATIONS (Comb: 0.6D+0.6W)

- Overturning about X-X

- Moment Mx = 0.6 * 0.0 + 0.6 * 0.0 = 0.0 k-ft

- Shear Force Vz = 0.6 * 0.0 + 0.6 * 0.0 = 0.0 kip

Arm = 0.00 + 8.0 / 12 = 0.67 ft

Moment = 0.0 * 0.67 = 0.0 k-ft

- Passive Force = 0.0 kip

Arm = 0.27 ft

Moment = 0.0 k-ft

- Overturning moment X-X = 0.0 + 0.0 = 0.0 k-ft

- Resisting about X-X

- Footing weight = $0.6 * W * L * Thick * Density = 0.6 * 3.50 * 3.50 * 8.0 / 12 * 0.15 = 0.7$ kip

Arm = $W / 2 = 3.50 / 2 = 1.75$ ft

Moment = $0.7 * 1.75 = 1.3$ k-ft

- Pedestal weight = $0.6 * W * L * H * Density = 0.6 * 6.0 / 12 * 6.0 / 12 * 0.0 * 0.15 = 0.0$ kip

Arm = $W / 2 - Offset = 3.50 / 2 - 0.0 / 12 = 1.75$ ft

Moment = $0.0 * 1.75 = 0.0$ k-ft

- Soil cover = $0.6 * W * L * SC * Density = 0.6 * (3.50 * 3.50 - 6.0 / 12 * 6.0 / 12) * 0.0 * 110 = 0.0$ kip

Arm = $W / 2 = 3.50 / 2 = 1.75$ ft

Moment = $0.0 * 1.75 = 0.0$ k-ft

- Buoyancy = $0.6 * W * L * \gamma * (SC + Thick - WT) = 0.6 * 3.50 * 3.50 * 62 * (0.67) = -0.3$ kip

Arm = $W / 2 = 3.50 / 2 = 1.75$ ft

Moment = $0.3 * 1.75 = -0.5$ k-ft

- Axial force P = $0.6 * 6.0 + 0.6 * 0.0 = 3.6$ kip

Arm = $W / 2 - Offset = 3.50 / 2 - 0.0 / 12 = 1.75$ ft

Moment = $3.6 * 1.75 = 6.3$ k-ft

- Resisting moment X-X = $1.3 + 0.0 + 0.0 + 6.3 + -0.5 = 7.1$ k-ft

- Overturning safety factor X-X = $\frac{Resisting\ moment}{Overturning\ moment} = \frac{7.1}{0.0} = 70.51 > 1.50$ OK

- Overturning about Z-Z

- Moment $M_z = 0.6 * 0.0 + 0.6 * 0.0 = 0.0$ k-ft
- Shear Force $V_x = 0.6 * 0.0 + 0.6 * 0.0 = 0.0$ kip
 - Arm = $0.00 + 8.0 / 12 = 0.67$ ft
 - Moment = $0.0 * 0.67 = 0.0$ k-ft
- Passive Force = 0.0 kip
 - Arm = 0.27 ft
 - Moment = 0.0 k-ft
- Overturning moment Z-Z = $0.0 + 0.0 = 0.0$ k-ft

- Resisting about Z-Z

- Footing weight = $0.6 * W * L * Thick * Density = 0.6 * 3.50 * 3.50 * 8.0 / 12 * 0.15 = 0.7$ kip
 - Arm = $L / 2 = 3.50 / 2 = 1.75$ ft
 - Moment = $0.7 * 1.75 = 1.3$ k-ft
- Pedestal weight = $0.6 * W * L * H * Density = 0.6 * 6.0 / 12 * 6.0 / 12 * 0.0 * 0.15 = 0.0$ kip
 - Arm = $L / 2 - Offset = 3.50 / 2 - 0.0 / 12 = 1.75$ ft
 - Moment = $0.0 * 1.75 = 0.0$ k-ft
- Soil cover = $0.6 * W * L * SC * Density = 0.6 * (3.50 * 3.50 - 6.0 / 12 * 6.0 / 12) * 0.0 * 110 = 0.0$ kip
 - Arm = $L / 2 = 3.50 / 2 = 1.75$ ft
 - Moment = $0.0 * 1.75 = 0.0$ k-ft
- Buoyancy = $0.6 * W * L * \gamma * (SC + Thick - WT) = 0.6 * 3.50 * 3.50 * 62 * (0.67) = -0.3$ kip
 - Arm = $L / 2 = 3.50 / 2 = 1.75$ ft
 - Moment = $0.3 * 1.75 = -0.5$ k-ft
- Axial force $P = 0.6 * 6.0 + 0.6 * 0.0 = 3.6$ kip
 - Arm = $L / 2 - Offset = 3.50 / 2 - 0.0 / 12 = 1.75$ ft
 - Moment = $3.6 * 1.75 = 6.3$ k-ft
- Resisting moment Z-Z = $1.3 + 0.0 + 0.0 + 6.3 + -0.5 = 7.1$ k-ft
- Overturning safety factor Z-Z = $\frac{Resisting\ moment}{Overturning\ moment} = \frac{7.1}{0.0} = 70.51 > 1.50$ OK

SOIL BEARING PRESSURES (Comb: D+L)

- Overturning moment X-X = $0.0 + 0.0 = 0.0$ k-ft
- Resisting moment X-X = $2.1 + 0.0 + 0.0 + -0.9 + 37.3 = 38.5$ k-ft
- Overturning moment Z-Z = $0.0 + 0.0 = 0.0$ k-ft
- Resisting moment Z-Z = $2.1 + 0.0 + 0.0 + -0.9 + 37.3 = 38.5$ k-ft
- Resisting force = $Footing + Pedestal + Soil - Buoyancy + P = 1.2 + 0.0 + 0.0 - 0.5 + 21.3 = 22.0$ kip
- X-coordinate of resultant from maximum bearing corner:
 $X_p = \frac{Z-Resisting\ moment - Z-Overturning\ moment}{Resisting\ force} = \frac{38.5 - 0.0}{22.0} = 1.75$ ft
- Z-coordinate of resultant from maximum bearing corner:
 $Z_p = \frac{X-Resisting\ moment - X-Overturning\ moment}{Resisting\ force} = \frac{38.5 - 0.0}{22.0} = 1.75$ ft
- X-ecc = $Length / 2 - X_p = 3.50 / 2 - 1.75 = 0.00$ ft
- Z-ecc = $Width / 2 - Z_p = 3.50 / 2 - 1.75 = 0.00$ ft
- Area = $Width * Length = 3.50 * 3.50 = 12.3$ ft²
- S_x = $Length * Width^2 / 6 = 3.50 * 3.50^2 / 6 = 7.1$ ft³
- S_z = $Width * Length^2 / 6 = 3.50 * 3.50^2 / 6 = 7.1$ ft³
- Footing is in full bearing. Soil pressures are as follows:
P1 = $P * (1/A + Z-ecc / S_x + X-ecc / S_z) = 22.0 * (1 / 12.3 + 0.00 / 7.1 + 0.00 / 7.1) = 1.80$ ksf
P2 = $P * (1/A - Z-ecc / S_x + X-ecc / S_z) = 22.0 * (1 / 12.3 - 0.00 / 7.1 + 0.00 / 7.1) = 1.80$ ksf
P3 = $P * (1/A - Z-ecc / S_x - X-ecc / S_z) = 22.0 * (1 / 12.3 - 0.00 / 7.1 - 0.00 / 7.1) = 1.80$ ksf
P4 = $P * (1/A + Z-ecc / S_x - X-ecc / S_z) = 22.0 * (1 / 12.3 + 0.00 / 7.1 - 0.00 / 7.1) = 1.80$ ksf

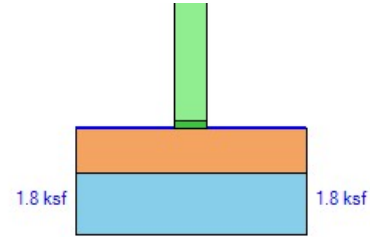
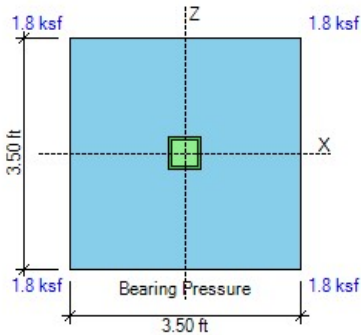

SLIDING CALCULATIONS (Comb: 0.6D+0.6W)

Internal friction angle = 28.0 deg

Passive coefficient $k_p = 4.33$ (per Coulomb)

Pressure at mid-depth = $k_p * Density * (Cover + Thick / 2) = 4.33 * 110 * (0.00 + 8.0 / 12 / 2) = 0.16$ ksf

X-Passive force = $Pressure * Thick * Width = 0.16 * 8.0 / 12 * 3.50 = 0.4$ kip

Z-Passive force = $Pressure * Thick * Length = 0.16 * 8.0 / 12 * 3.50 = 0.4$ kip

Friction force = $Resisting\ force * Friction\ coeff. = \text{Max}(0, 4.0 * 0.35) = 1.4$ kip

Use 100% of Passive + 100% of Friction for sliding resistance

$$\text{- Sliding safety factor X-X} = \frac{X\text{-Passive force} + \text{Friction}}{X\text{-Horizontal load}} = \frac{1.00 * 0.4 + 1.00 * 1.4}{0.0} = 17.80 > 1.50 \text{ OK}$$

$$\text{- Sliding safety factor Z-Z} = \frac{Z\text{-Passive force} + \text{Friction}}{Z\text{-Horizontal load}} = \frac{1.00 * 0.4 + 1.00 * 1.4}{0.0} = 17.80 > 1.50 \text{ OK}$$

UPLIFT CALCULATIONS (Comb: 0.6D+0.6W)

$$\text{- Uplift safety factor} = \frac{\text{Pedestal} + \text{Footing} + \text{Cover} - \text{Buoyancy}}{\text{Uplift load}} = \frac{0.0 + 0.7 + 0.0 - 0.3}{0.0} = 99.99 > 1.00 \text{ OK}$$

ONE-WAY SHEAR CALCULATIONS (Comb: 1.2D+1.6L+0.5Lr)

Concrete $f_c = 2.5$ ksi

Steel $f_y = 40.0$ ksi

Soil density = 110 pcf

d Top X-dir = $Thick - Cover - X\text{-diameter} / 2 = 8.0 - 2.0 - 0.8 / 2 = 5.6$ in

d Top Z-dir = $Thick - Cover - X\text{-diameter} - Z\text{-diameter} / 2 = 8.0 - 2.0 - 0.8 - 0.8 / 2 = 4.9$ in

d Bot X-dir = $Thick - Cover - X\text{-diameter} / 2 = 8.0 - 3.0 - 0.5 / 2 = 4.8$ in

d Bot Z-dir = $Thick - Cover - X\text{-diameter} - Z\text{-diameter} / 2 = 8.0 - 3.0 - 0.5 - 0.5 / 2 = 4.3$ in

$\phi V_{cx} = 2 * \phi * \sqrt{f_c} * Width * d / 1000 = 2 * 0.75 * \sqrt{2500} * 3.5 * 12 * 4.8 / 1000 = 15.0$ kip

ACI Eq. (22.5.5.1)

$\phi V_{cz} = 2 * \phi * \sqrt{f_c} * Length * d / 1000 = 2 * 0.75 * \sqrt{2500} * 3.5 * 12 * 4.3 / 1000 = 13.4$ kip

- Shear forces calculated as the volume of the bearing pressures under the effective areas:

One-way shear V_{ux} (- Side) = 10.2 kip < 15.0 kip OK

One-way shear V_{ux} (+ Side) = 10.2 kip < 15.0 kip OK

One-way shear V_{uz} (- Side) = 10.2 kip < 13.4 kip OK

One-way shear V_{uz} (+ Side) = 10.2 kip < 13.4 kip OK

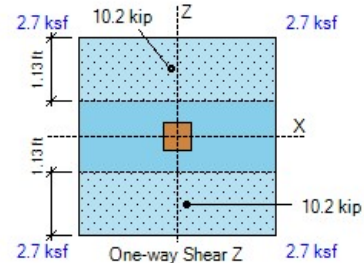
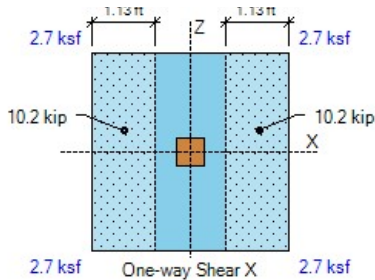

FLEXURE CALCULATIONS (Comb: 1.2D+1.6L+0.5Lr)

Plain $\phi M_{nx} = 5 * \phi * \sqrt{f_c} * L * Thick^2 / 6 = 5 * 0.60 * \sqrt{(2500)} * 3.50 * 8.0^2 / 6 / 1000 = 1.5 \text{ k-ft}$ ACI Eq. (14.5.2.1a)

Plain $\phi M_{nz} = 5 * \phi * \sqrt{f_c} * W * Thick^2 / 6 = 5 * 0.60 * \sqrt{(2500)} * 3.50 * 8.0^2 / 6 / 1000 = 1.5 \text{ k-ft}$

- Top Bars

No Top Reinforcement Provided at the Footing

Use Plain Concrete Flexural Strength at Top

- Top moments calculated as the overburden minus the bearing pressures times the lever arm:

Top moment -M_{ux} (- Side) = 0.0 k-ft < 5.6 k-ft OK

Top moment -M_{ux} (+ Side) = 0.0 k-ft < 5.6 k-ft OK

Top moment -M_{uz} (- Side) = 0.0 k-ft < 5.6 k-ft OK

Top moment -M_{uz} (+ Side) = 0.0 k-ft < 5.6 k-ft OK

- Bottom Bars

Use 5 #4 Z-Bars $\rho = A_s / b d = 1.0 / (3.50 * 12 * 4.3) = 0.0056$

$q = 0.0056 * 40 / 2.5 = 0.090$

Use 5 #4 X-Bars $\rho = A_s / b d = 1.0 / (3.50 * 12 * 4.8) = 0.0050$

$q = 0.0050 * 40 / 2.5 = 0.080$

$\beta = L / W = 3.50 / 3.50 = 1.00$ $\gamma_s = 2 * \beta / (\beta + 1) = 2 * 1.00 / (1.00 + 1) = 1.00$

ACI 13.3.3.3

Bending strength $\phi Mn = \phi * b * d^2 * f_c * q * (1 - 0.59 * q)$

ACI 22.2.2

$\phi Mn_x = 0.90 * 3.50 * 12 * 4.3^2 * 2.5 * 0.090 * (1 - 0.59 * 0.090) = 12.1 \text{ k-ft}$

$\phi Mn_z = 0.90 * 3.50 * 12 * 4.8^2 * 2.5 * 0.080 / 1.00 * (1 - 0.59 * 0.080 / 1.00) = 13.6 \text{ k-ft}$

- Bottom moments calculated as the bearing minus the overburden pressures times the lever arm:

Bottom moment M_{ux} (- Side) = 10.2 k-ft < 12.1 k-ft OK ratio = 0.84

Bottom moment M_{ux} (+ Side) = 10.2 k-ft < 12.1 k-ft OK ratio = 0.85

Bottom moment M_{uz} (- Side) = 10.2 k-ft < 13.6 k-ft OK ratio = 0.75

Bottom moment M_{uz} (+ Side) = 10.2 k-ft < 13.6 k-ft OK ratio = 0.75

X-As min = $0.0018 * Width * Thick = 0.0018 * 3.50 * 12 * 8.0 = 0.6 \text{ in}^2$ < 1.0 in² OK

ACI 8.6.1.1

Z-As min = $0.0018 * Length * Thick = 0.0018 * 3.50 * 12 * 8.0 = 0.6 \text{ in}^2$ < 1.0 in² OK

ACI 8.6.1.1

X-As max for 0.005 tension strain = 3.20 in² > 1.00 in² OK

ACI 21.2.2

Z-As max for 0.005 tension strain = 3.20 in² > 1.00 in² OK

ACI 21.2.2

X-Cover factor = $Min(2.5, (Cover + db / 2, Spacing / 2) / db) = Min(2.5, (3.0 + 0.50 / 2, 9.0 / 2) / 0.50) = 2.5$

Straight X-Ld = $Max(12.0, 3 / 40 * f_y / (f_c)^{1/2} * Grade * Size * Casting / Cover * db * ratio)$

ACI Eq. (25.4.2.3a)

X-Ld = $Max(12.0, 3 / 40 * 40.0 * 1000 / (2500)^{1/2} * 1.0 * 0.8 * 1.0 / 2.5 * 0.50 * 0.75) = 12.0 \text{ in}$

Hooked X-Ldh = $Max(8 db, 6, 0.02 * f_y / (f_c)^{1/2} * Confining * Location * Concrete * db * ratio) =$

ACI 25.4.3

X-Ldh = $Max(8 db, 6, 0.02 * 40.0 * 1000 / (2500)^{1/2} * 1.0 * 0.7 * 0.0 * 0.50 * 0.75) = 6.0 \text{ in}$

-X Ld provided = $(Length - Col) / 2 + Offset - Cover = 3.50 * 12 / 2 + 0.0 - 6.0 / 2 - 2.5 = 15.5 \text{ in}$ > 12.0 in OK

+X Ld provided = $(Length - Col) / 2 - Offset - Cover = 3.50 * 12 / 2 - 0.0 - 6.0 / 2 - 2.5 = 15.5 \text{ in}$ > 12.0 in OK

Z-Cover factor = $\text{Min}(2.5, (\text{Cover} + db / 2, \text{Spacing} / 2) / db) = \text{Min}(2.5, (3.0 + 0.50 / 2, 9.0 / 2) / 0.50) = 2.5$

Straight Z-Ld = $\text{Max}(12.0, 3 / 40 * fy / (fc)^{1/2} * \text{Grade} * \text{Size} * \text{Casting} / \text{Cover} * db * \text{ratio})$ ACI Eq. (25.4.2.3a)

Z-Ld = $\text{Max}(12.0, 3 / 40 * 40.0 * 1000 / (2500)^{1/2} * 1.0 * 0.8 * 1.0 / 2.5 * 0.50 * 0.75) = 12.0 \text{ in}$

Hooked Z-Ldh = $\text{Max}(8 db, 6, 0.02 * fy / (fc)^{1/2} * \text{Confining} * \text{Location} * \text{Concrete} * db * \text{ratio}) =$ ACI 25.4.3

Z-Ldh = $\text{Max}(8 db, 6, 0.02 * 40.0 * 1000 / (2500)^{1/2} * 1.0 * 0.7 * 0.0 * 0.50 * 0.85) = 6.0 \text{ in}$

-Z Ld provided = $(\text{Width} - \text{Col}) / 2 + \text{Offset} - \text{Cover} = 3.50 * 12 / 2 + 0.0 - 6.0 / 2 - 2.5 = 15.5 \text{ in} > 12.0 \text{ in OK}$

+Z Ld provided = $(\text{Width} - \text{Col}) / 2 - \text{Offset} - \text{Cover} = 3.50 * 12 / 2 - 0.0 - 6.0 / 2 - 2.5 = 15.5 \text{ in} > 12.0 \text{ in OK}$

X-bar spacing = 9.0 in < $\text{Min}(3 * t, 18.0) = 18.0 \text{ in OK}$ ACI 7.7.2.3

Z-bar spacing = 9.0 in < $\text{Min}(3 * t, 18.0) = 18.0 \text{ in OK}$

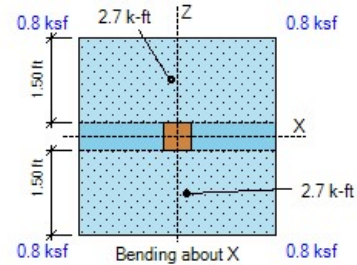
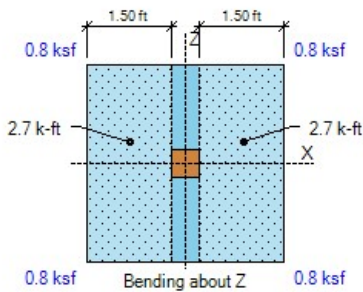

LOAD TRANSFER CALCULATIONS (Comb: 1.2D+1.6L+0.5Lr)

Area $A1 = col L * col W = 6.0 * 6.0 = 36.0 \text{ in}^2$

$Sx = col W * col L^2 / 6 = 6.0 * 6.0^2 / 6 = 36.0 \text{ in}^3$

$Sz = col L * col W^2 / 6 = 6.0 * 6.0^2 / 6 = 36.0 \text{ in}^3$

Bearing $Pbu = P / A1 + Mz / Sx + Mx / Sz = 31.7 / 36.0 + 0.0 * 12 / 36.0 + 0.0 * 12 / 36.0 = 0.9 \text{ ksi}$

Min edge = $\text{Min}(L / 2 - X\text{-offset} - col L / 2, W / 2 - Z\text{-offset} - col W / 2)$

Min edge = $\text{Min}(3.50 * 12 / 2 - 0.0 - 6.0 / 2, 3.50 * 12 / 2 - 0.0 - 6.0 / 2) = 18.0 \text{ in}$

Area $A2 = \text{Min}[L * W, (col L + 2 * \text{Min edge}) * (col W + 2 * \text{Min edge})]$

ACI R22.8.3.2

$A2 = \text{Min}[3.50 * 12 * 3.5 * 12, (6.0 + 2 * 18.0) * (6.0 + 2 * 18.0)] = 1764.0 \text{ in}^2$

Footing $\phi Pnc = \phi * 0.85 * fc * \text{Min}[2, \sqrt{(A2 / A1)}] = 0.65 * 0.85 * 2.5 * \text{Min}[2, \sqrt{(1764.0 / 36.0)}] = 2.8 \text{ ksi}$

Footing $\phi Pns = \phi * As * Fy / A1 = 0.0 \text{ ksi}$

ACI 22.8.3.2

Footing bearing $\phi Pn = \phi Pnc + \phi Pns = 2.8 + 0.0 = 2.8 \text{ ksi} > 0.9 \text{ psi OK}$

Hooked $L_{dh} = \text{Max}(8 db, 6, 0.02 * f_y / (f_c)^{1/2} * \text{Confining} * \text{Location} * \text{Concrete} * db * \text{ratio})$

ACI 25.4.3

$$L_{dh} = \text{Max}(8 db, 6, 0.02 * 60.0 * 1000 / (2500)^{1/2} * 1.0 * 0.7 * 0.0 * 0.75 * 0.15) = 6.0 \text{ in}$$

Ld provided = Dowel length = $3.00 * 12 = 36.0 \text{ in} > 27.4 \text{ in OK}$

Ldh provided = Footing thickness - Cover = $8.00 - 3.0 = 5.0 \text{ in} < 6.0 \text{ in NG}$

PUNCHING SHEAR CALCULATIONS (Comb: 1.2D+1.6L+0.5Lr)

X-Edge = $d/2 = 4.5 / 2 = 2.3 \text{ in}$ $as_x = 20$

Z-Edge = $d/2 = 4.5 / 2 = 2.3 \text{ in}$ $as_z = 20$

$as = as_x + as_z = 20 + 20 = 40$ Col type = Interior $\beta = L / W = 6.0 / 6.0 = 1.00$

ACI 22.6.5.2

Perimeter $bo = as_z / 10 * (L + d/2 + X\text{-Edge}) + as_x / 10 * (W + d/2 + Z\text{-Edge})$

ACI 22.6.4.2

$$bo = 20 / 10 * (6.0 + 4.5 / 2 + 2.3) + 20 / 10 * (6.0 + 4.5 / 2 + 2.3) = 42.0 \text{ in}$$

Area $A_{bo} = (L + d/2 + X\text{-Edge}) * (W + d/2 + Z\text{-Edge}) = (6.0 + 4.5 / 2 + 2.3) * (6.0 + 4.5 / 2 + 2.3) = 110.3 \text{ in}^2$

$\phi V_c = \phi * \text{Min}(2 + 4 / \beta, as * d / bo + 2, 4) * \sqrt{f_c}$

ACI 22.6.5.2

$$\phi V_c = 0.75 * \text{Min}(2 + 4 / 1.00, 40 * 4.5 / 42.0 + 2, 4) * \sqrt{2500} = 150.0 \text{ psi}$$

Punching force $F = P + \text{Overburden} * A_{bo} - \text{Bearing}$

$$F = 31.7 + 0.07 * 110.3 / 144 - 2.0 = 29.7 \text{ kip}$$

$b_1 = L + d/2 + X\text{-Edge} = 6.0 + 4.5 / 2 + 2.3 = 10.5 \text{ in}$ $b_2 = W + d/2 + Z\text{-Edge} = 6.0 + 4.5 / 2 + 2.3 = 10.5 \text{ in}$

$\gamma_{vx} \text{ factor} = 1 - \frac{1}{1 + (2/3) \sqrt{b_2 / b_1}} = 1 - \frac{1}{1 + (2/3) \sqrt{10.5 / 10.5}} = 0.40$

ACI Eq. (8.4.4.2.2)

$\gamma_{vz} \text{ factor} = 1 - \frac{1}{1 + (2/3) \sqrt{b_1 / b_2}} = 1 - \frac{1}{1 + (2/3) \sqrt{10.5 / 10.5}} = 0.40$

ACI Eq. (8.4.2.3.2)

$X_{2z} = b_1 / 2 = 10.5 / 2 = 5.3 \text{ in}$ $X_{2x} = b_2 / 2 = 10.5 / 2 = 5.3 \text{ in}$

$J_{cz} = b_1 * d^3 / 6 + b_1^3 * d / 6 + b_1^2 * b_2 * d / 2$

ACI R8.4.4.2.3

$$J_{cz} = 10.5 * 4.5^3 / 6 + 10.5^3 * 4.5 / 6 + 10.5^2 * 10.5 * 4.5 / 2 = 3632 \text{ in}^4$$

$J_{cx} = b_2 * d^3 / 6 + b_2^3 * d / 6 + b_2^2 * b_1 * d / 2$

ACI R8.4.4.2.3

$$J_{cx} = 10.5 * 4.5^3 / 6 + 10.5^3 * 4.5 / 6 + 10.5^2 * 10.5 * 4.5 / 2 = 3632 \text{ in}^4$$

Stress due to P = $F / (bo * d) * 1000 = 29.7 / (42.0 * 4.5) * 1000 = 157.1 \text{ psi}$

Stress due to Mx = $\gamma_{vx} * X\text{-OTM} * X_{2x} / J_{cx} = 0.40 * 0.0 * 12 * 5.3 / 3632 * 1000 = 0.0 \text{ psi}$

Stress due to Mz = $\gamma_{vz} * Z\text{-OTM} * X_{2z} / J_{cz} = 0.40 * 0.0 * 12 * 5.3 / 3632 * 1000 = 0.0 \text{ psi}$

Punching stress = $P\text{-stress} + Mx\text{-stress} + Mz\text{-stress} = 157.1 + 0.0 + 0.0 = 157.1 \text{ psi} > 150.0 \text{ psi NG}$

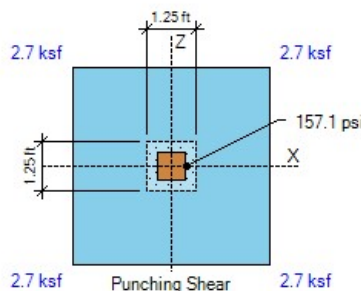

DESIGN CODES

Concrete Design ACI 318-14
Load Combinations ASCE 7-10/16

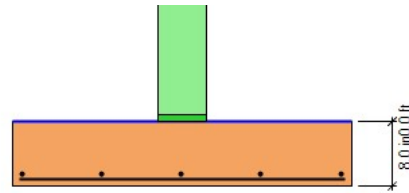

ELEVATION

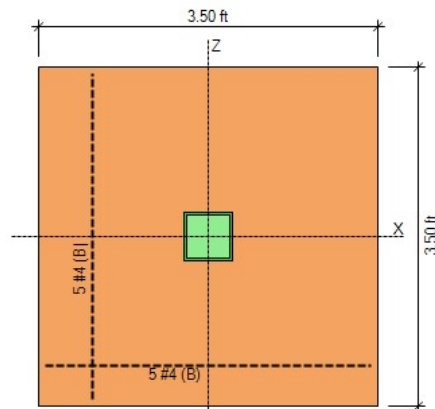

PLAN

GEOMETRY			SOIL PRESSURES (D+L)		
Footing Length (X-dir)	3.50	ft	Gross Allow. Soil Pressure	2.0	ksf
Footing Width (Z-dir)	3.50	ft	Soil Pressure at Corner 1	1.5	ksf
Footing Thickness	8.0	in OK	Soil Pressure at Corner 2	1.5	ksf
Soil Cover	0.00	ft	Soil Pressure at Corner 3	1.5	ksf
Column Length (X-dir)	6.0	in	Soil Pressure at Corner 4	1.5	ksf
Column Width (Z-dir)	6.0	in	Bearing Pressure Ratio	0.76	OK
Offset (X-dir)	0.00	in OK	Ftg. Area in Contact with Soil	100.0	%
Offset (Z-dir)	0.00	in OK	X-eccentricity / Ftg. Length	0.00	OK
Base Plate (L x W)	6.0 x 6.0	in	Z-eccentricity / Ftg. Width	0.00	OK

APPLIED LOADS

	Dead	Live	RLive	Snow	Wind	Seismic	
Axial Force P	5.2	12.8	0.0	0.0	0.0	0.0	kip
Moment about X Mx ..	0.0	0.0	0.0	0.0	0.0	0.0	k-ft
Moment about Z Mz ..	0.0	0.0	0.0	0.0	0.0	0.0	k-ft
Shear Force Vx	0.0	0.0	0.0	0.0	0.0	0.0	kip
Shear Force Vz	0.0	0.0	0.0	0.0	0.0	0.0	kip

OVERTURNING CALCULATIONS (Comb: 0.6D+0.6W)

- Overturning about X-X

- Moment Mx = 0.6 * 0.0 + 0.6 * 0.0 = 0.0 k-ft

- Shear Force Vz = 0.6 * 0.0 + 0.6 * 0.0 = 0.0 kip

Arm = 0.00 + 8.0 / 12 = 0.67 ft

Moment = 0.0 * 0.67 = 0.0 k-ft

- Passive Force = 0.0 kip

Arm = 0.27 ft

Moment = 0.0 k-ft

- Overturning moment X-X = 0.0 + 0.0 = 0.0 k-ft

- Resisting about X-X

- Footing weight = $0.6 * W * L * Thick * Density = 0.6 * 3.50 * 3.50 * 8.0 / 12 * 0.15 = 0.7$ kip

Arm = $W / 2 = 3.50 / 2 = 1.75$ ft

Moment = $0.7 * 1.75 = 1.3$ k-ft

- Pedestal weight = $0.6 * W * L * H * Density = 0.6 * 6.0 / 12 * 6.0 / 12 * 0.0 * 0.15 = 0.0$ kip

Arm = $W / 2 - Offset = 3.50 / 2 - 0.0 / 12 = 1.75$ ft

Moment = $0.0 * 1.75 = 0.0$ k-ft

- Soil cover = $0.6 * W * L * SC * Density = 0.6 * (3.50 * 3.50 - 6.0 / 12 * 6.0 / 12) * 0.0 * 110 = 0.0$ kip

Arm = $W / 2 = 3.50 / 2 = 1.75$ ft

Moment = $0.0 * 1.75 = 0.0$ k-ft

- Buoyancy = $0.6 * W * L * \gamma * (SC + Thick - WT) = 0.6 * 3.50 * 3.50 * 62 * (0.67) = -0.3$ kip

Arm = $W / 2 = 3.50 / 2 = 1.75$ ft

Moment = $0.3 * 1.75 = -0.5$ k-ft

- Axial force P = $0.6 * 5.2 + 0.6 * 0.0 = 3.1$ kip

Arm = $W / 2 - Offset = 3.50 / 2 - 0.0 / 12 = 1.75$ ft

Moment = $3.1 * 1.75 = 5.5$ k-ft

- Resisting moment X-X = $1.3 + 0.0 + 0.0 + 5.5 + -0.5 = 6.2$ k-ft

- Overturning safety factor X-X = $\frac{Resisting\ moment}{Overturning\ moment} = \frac{6.2}{0.0} = 62.11 > 1.50$ OK

- Overturning about Z-Z

- Moment $M_z = 0.6 * 0.0 + 0.6 * 0.0 = 0.0$ k-ft

- Shear Force $V_x = 0.6 * 0.0 + 0.6 * 0.0 = 0.0$ kip

Arm = $0.00 + 8.0 / 12 = 0.67$ ft

Moment = $0.0 * 0.67 = 0.0$ k-ft

- Passive Force = 0.0 kip

Arm = 0.27 ft

Moment = 0.0 k-ft

- Overturning moment Z-Z = $0.0 + 0.0 = 0.0$ k-ft

- Resisting about Z-Z

- Footing weight = $0.6 * W * L * Thick * Density = 0.6 * 3.50 * 3.50 * 8.0 / 12 * 0.15 = 0.7$ kip

Arm = $L / 2 = 3.50 / 2 = 1.75$ ft

Moment = $0.7 * 1.75 = 1.3$ k-ft

- Pedestal weight = $0.6 * W * L * H * Density = 0.6 * 6.0 / 12 * 6.0 / 12 * 0.0 * 0.15 = 0.0$ kip

Arm = $L / 2 - Offset = 3.50 / 2 - 0.0 / 12 = 1.75$ ft

Moment = $0.0 * 1.75 = 0.0$ k-ft

- Soil cover = $0.6 * W * L * SC * Density = 0.6 * (3.50 * 3.50 - 6.0 / 12 * 6.0 / 12) * 0.0 * 110 = 0.0$ kip

Arm = $L / 2 = 3.50 / 2 = 1.75$ ft

Moment = $0.0 * 1.75 = 0.0$ k-ft

- Buoyancy = $0.6 * W * L * \gamma * (SC + Thick - WT) = 0.6 * 3.50 * 3.50 * 62 * (0.67) = -0.3$ kip

Arm = $L / 2 = 3.50 / 2 = 1.75$ ft

Moment = $0.3 * 1.75 = -0.5$ k-ft

- Axial force $P = 0.6 * 5.2 + 0.6 * 0.0 = 3.1$ kip

Arm = $L / 2 - Offset = 3.50 / 2 - 0.0 / 12 = 1.75$ ft

Moment = $3.1 * 1.75 = 5.5$ k-ft

- Resisting moment Z-Z = $1.3 + 0.0 + 0.0 + 5.5 + -0.5 = 6.2$ k-ft

- Overturning safety factor Z-Z = $\frac{Resisting\ moment}{Overturning\ moment} = \frac{6.2}{0.0} = 62.11 > 1.50$ OK

SOIL BEARING PRESSURES (Comb: D+L)

Overturning moment X-X = $0.0 + 0.0 = 0.0$ k-ft

Resisting moment X-X = $2.1 + 0.0 + 0.0 + -0.9 + 31.5 = 32.8$ k-ft

Overturning moment Z-Z = $0.0 + 0.0 = 0.0$ k-ft

Resisting moment Z-Z = $2.1 + 0.0 + 0.0 + -0.9 + 31.5 = 32.8$ k-ft

Resisting force = $Footing + Pedestal + Soil - Buoyancy + P = 1.2 + 0.0 + 0.0 - 0.5 + 18.0 = 18.7$ kip

X-coordinate of resultant from maximum bearing corner:

$$X_p = \frac{Z-Resisting\ moment - Z-Overturning\ moment}{Resisting\ force} = \frac{32.8 - 0.0}{18.7} = 1.75\text{ ft}$$

Z-coordinate of resultant from maximum bearing corner:

$$Z_p = \frac{X-Resisting\ moment - X-Overturning\ moment}{Resisting\ force} = \frac{32.8 - 0.0}{18.7} = 1.75\text{ ft}$$

X-ecc = $Length / 2 - X_p = 3.50 / 2 - 1.75 = 0.00$ ft

Z-ecc = $Width / 2 - Z_p = 3.50 / 2 - 1.75 = 0.00$ ft

Area = $Width * Length = 3.50 * 3.50 = 12.3$ ft²

$S_x = Length * Width^2 / 6 = 3.50 * 3.50^2 / 6 = 7.1$ ft³

$S_z = Width * Length^2 / 6 = 3.50 * 3.50^2 / 6 = 7.1$ ft³

- Footing is in full bearing. Soil pressures are as follows:

$P_1 = P * (1/A + Z-ecc / S_x + X-ecc / S_z) = 18.7 * (1 / 12.3 + 0.00 / 7.1 + 0.00 / 7.1) = 1.53$ ksf

$P_2 = P * (1/A - Z-ecc / S_x + X-ecc / S_z) = 18.7 * (1 / 12.3 - 0.00 / 7.1 + 0.00 / 7.1) = 1.53$ ksf

$P_3 = P * (1/A - Z-ecc / S_x - X-ecc / S_z) = 18.7 * (1 / 12.3 - 0.00 / 7.1 - 0.00 / 7.1) = 1.53$ ksf

$P_4 = P * (1/A + Z-ecc / S_x - X-ecc / S_z) = 18.7 * (1 / 12.3 + 0.00 / 7.1 - 0.00 / 7.1) = 1.53$ ksf

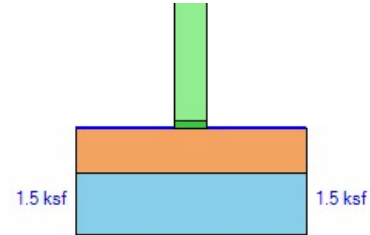
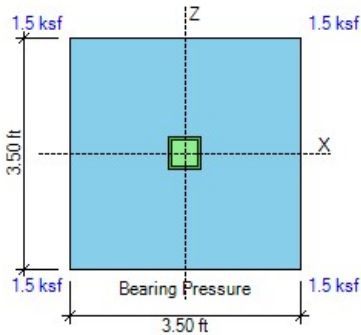

SLIDING CALCULATIONS (Comb: 0.6D+0.6W)

Internal friction angle = 28.0 deg

Passive coefficient $k_p = 4.33$ (per Coulomb)

Pressure at mid-depth = $k_p * Density * (Cover + Thick / 2) = 4.33 * 110 * (0.00 + 8.0 / 12 / 2) = 0.16$ ksf

X-Passive force = $Pressure * Thick * Width = 0.16 * 8.0 / 12 * 3.50 = 0.4$ kip

Z-Passive force = $Pressure * Thick * Length = 0.16 * 8.0 / 12 * 3.50 = 0.4$ kip

Friction force = $Resisting\ force * Friction\ coeff. = \text{Max}(0, 3.5 * 0.35) = 1.2$ kip

Use 100% of Passive + 100% of Friction for sliding resistance

$$\text{- Sliding safety factor X-X} = \frac{X\text{-Passive force} + Friction}{X\text{-Horizontal load}} = \frac{1.00 * 0.4 + 1.00 * 1.2}{0.0} = 16.12 > 1.50 \text{ OK}$$

$$\text{- Sliding safety factor Z-Z} = \frac{Z\text{-Passive force} + Friction}{Z\text{-Horizontal load}} = \frac{1.00 * 0.4 + 1.00 * 1.2}{0.0} = 16.12 > 1.50 \text{ OK}$$

UPLIFT CALCULATIONS (Comb: 0.6D+0.6W)

$$\text{- Uplift safety factor} = \frac{Pedestal + Footing + Cover - Buoyancy}{Uplift load} = \frac{0.0 + 0.7 + 0.0 - 0.3}{0.0} = 99.99 > 1.00 \text{ OK}$$

ONE-WAY SHEAR CALCULATIONS (Comb: 1.2D+1.6L+0.5Lr)

Concrete $f_c = 2.5$ ksi

Steel $f_y = 40.0$ ksi

Soil density = 110 pcf

d Top X-dir = $Thick - Cover - X\text{-diameter} / 2 = 8.0 - 2.0 - 0.8 / 2 = 5.6$ in

d Top Z-dir = $Thick - Cover - X\text{-diameter} - Z\text{-diameter} / 2 = 8.0 - 2.0 - 0.8 - 0.8 / 2 = 4.9$ in

d Bot X-dir = $Thick - Cover - X\text{-diameter} / 2 = 8.0 - 3.0 - 0.5 / 2 = 4.8$ in

d Bot Z-dir = $Thick - Cover - X\text{-diameter} - Z\text{-diameter} / 2 = 8.0 - 3.0 - 0.5 - 0.5 / 2 = 4.3$ in

$\phi V_{cx} = 2 * \phi * \sqrt{f_c} * Width * d / 1000 = 2 * 0.75 * \sqrt{2500} * 3.5 * 12 * 4.8 / 1000 = 15.0$ kip

ACI Eq. (22.5.5.1)

$\phi V_{cz} = 2 * \phi * \sqrt{f_c} * Length * d / 1000 = 2 * 0.75 * \sqrt{2500} * 3.5 * 12 * 4.3 / 1000 = 13.4$ kip

- Shear forces calculated as the volume of the bearing pressures under the effective areas:

One-way shear V_{ux} (- Side) = 8.6 kip < 15.0 kip OK

One-way shear V_{ux} (+ Side) = 8.6 kip < 15.0 kip OK

One-way shear V_{uz} (- Side) = 8.6 kip < 13.4 kip OK

One-way shear V_{uz} (+ Side) = 8.6 kip < 13.4 kip OK

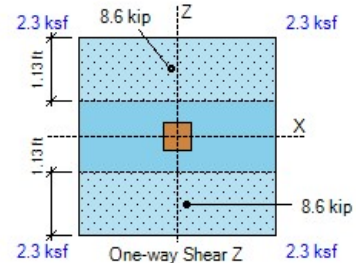
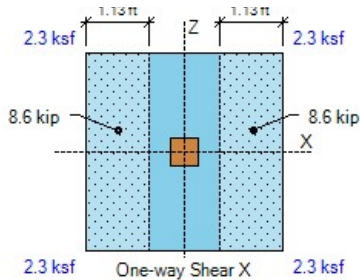

FLEXURE CALCULATIONS (Comb: 1.2D+1.6L+0.5Lr)

Plain $\phi M_{nx} = 5 * \phi * \sqrt{f_c} * L * Thick^2 / 6 = 5 * 0.60 * \sqrt{(2500)} * 3.50 * 8.0^2 / 6 / 1000 = 1.5 \text{ k-ft}$ ACI Eq. (14.5.2.1a)

Plain $\phi M_{nz} = 5 * \phi * \sqrt{f_c} * W * Thick^2 / 6 = 5 * 0.60 * \sqrt{(2500)} * 3.50 * 8.0^2 / 6 / 1000 = 1.5 \text{ k-ft}$

- Top Bars

No Top Reinforcement Provided at the Footing

Use Plain Concrete Flexural Strength at Top

- Top moments calculated as the overburden minus the bearing pressures times the lever arm:

Top moment -M_{ux} (- Side) = 0.0 k-ft < 5.6 k-ft OK

Top moment -M_{ux} (+ Side) = 0.0 k-ft < 5.6 k-ft OK

Top moment -M_{uz} (- Side) = 0.0 k-ft < 5.6 k-ft OK

Top moment -M_{uz} (+ Side) = 0.0 k-ft < 5.6 k-ft OK

- Bottom Bars

Use 5 #4 Z-Bars $\rho = A_s / b d = 1.0 / (3.50 * 12 * 4.3) = 0.0056$

$q = 0.0056 * 40 / 2.5 = 0.090$

Use 5 #4 X-Bars $\rho = A_s / b d = 1.0 / (3.50 * 12 * 4.8) = 0.0050$

$q = 0.0050 * 40 / 2.5 = 0.080$

$\beta = L / W = 3.50 / 3.50 = 1.00$ $\gamma_s = 2 * \beta / (\beta + 1) = 2 * 1.00 / (1.00 + 1) = 1.00$

ACI 13.3.3.3

Bending strength $\phi M_n = \phi * b * d^2 * f_c * q * (1 - 0.59 * q)$

ACI 22.2.2

$\phi M_{nx} = 0.90 * 3.50 * 12 * 4.3^2 * 2.5 * 0.090 * (1 - 0.59 * 0.090) = 12.1 \text{ k-ft}$

$\phi M_{nz} = 0.90 * 3.50 * 12 * 4.8^2 * 2.5 * 0.080 / 1.00 * (1 - 0.59 * 0.080 / 1.00) = 13.6 \text{ k-ft}$

- Bottom moments calculated as the bearing minus the overburden pressures times the lever arm:

Bottom moment M_{ux} (- Side) = 8.6 k-ft < 12.1 k-ft OK ratio = 0.71

Bottom moment M_{ux} (+ Side) = 8.6 k-ft < 12.1 k-ft OK ratio = 0.71

Bottom moment M_{uz} (- Side) = 8.6 k-ft < 13.6 k-ft OK ratio = 0.63

Bottom moment M_{uz} (+ Side) = 8.6 k-ft < 13.6 k-ft OK ratio = 0.63

X-As min = $0.0018 * Width * Thick = 0.0018 * 3.50 * 12 * 8.0 = 0.6 \text{ in}^2$ < 1.0 in² OK

ACI 8.6.1.1

Z-As min = $0.0018 * Length * Thick = 0.0018 * 3.50 * 12 * 8.0 = 0.6 \text{ in}^2$ < 1.0 in² OK

ACI 8.6.1.1

X-As max for 0.005 tension strain = 3.20 in² > 1.00 in² OK

ACI 21.2.2

Z-As max for 0.005 tension strain = 3.20 in² > 1.00 in² OK

ACI 21.2.2

X-Cover factor = $Min(2.5, (Cover + db / 2, Spacing / 2) / db) = Min(2.5, (3.0 + 0.50 / 2, 9.0 / 2) / 0.50) = 2.5$

Straight X-Ld = $Max(12.0, 3 / 40 * f_y / (f_c)^{1/2} * Grade * Size * Casting / Cover * db * ratio)$

ACI Eq. (25.4.2.3a)

X-Ld = $Max(12.0, 3 / 40 * 40.0 * 1000 / (2500)^{1/2} * 1.0 * 0.8 * 1.0 / 2.5 * 0.50 * 0.63) = 12.0 \text{ in}$

Hooked X-Ldh = $Max(8 db, 6, 0.02 * f_y / (f_c)^{1/2} * Confining * Location * Concrete * db * ratio) =$

ACI 25.4.3

X-Ldh = $Max(8 db, 6, 0.02 * 40.0 * 1000 / (2500)^{1/2} * 1.0 * 0.7 * 0.0 * 0.50 * 0.63) = 6.0 \text{ in}$

-X Ld provided = $(Length - Col) / 2 + Offset - Cover = 3.50 * 12 / 2 + 0.0 - 6.0 / 2 - 2.5 = 15.5 \text{ in}$ > 12.0 in OK

+X Ld provided = $(Length - Col) / 2 - Offset - Cover = 3.50 * 12 / 2 - 0.0 - 6.0 / 2 - 2.5 = 15.5 \text{ in}$ > 12.0 in OK

Z-Cover factor = $\text{Min}(2.5, (\text{Cover} + db / 2, \text{Spacing} / 2) / db) = \text{Min}(2.5, (3.0 + 0.50 / 2, 9.0 / 2) / 0.50) = 2.5$

Straight Z-Ld = $\text{Max}(12.0, 3 / 40 * fy / (fc)^{1/2} * \text{Grade} * \text{Size} * \text{Casting} / \text{Cover} * db * \text{ratio})$ ACI Eq. (25.4.2.3a)

Z-Ld = $\text{Max}(12.0, 3 / 40 * 40.0 * 1000 / (2500)^{1/2} * 1.0 * 0.8 * 1.0 / 2.5 * 0.50 * 0.63) = 12.0 \text{ in}$

Hooked Z-Ldh = $\text{Max}(8 db, 6, 0.02 * fy / (fc)^{1/2} * \text{Confining} * \text{Location} * \text{Concrete} * db * \text{ratio}) =$ ACI 25.4.3

Z-Ldh = $\text{Max}(8 db, 6, 0.02 * 40.0 * 1000 / (2500)^{1/2} * 1.0 * 0.7 * 0.0 * 0.50 * 0.71) = 6.0 \text{ in}$

-Z Ld provided = $(\text{Width} - \text{Col}) / 2 + \text{Offset} - \text{Cover} = 3.50 * 12 / 2 + 0.0 - 6.0 / 2 - 2.5 = 15.5 \text{ in} > 12.0 \text{ in OK}$

+Z Ld provided = $(\text{Width} - \text{Col}) / 2 - \text{Offset} - \text{Cover} = 3.50 * 12 / 2 - 0.0 - 6.0 / 2 - 2.5 = 15.5 \text{ in} > 12.0 \text{ in OK}$

X-bar spacing = 9.0 in < $\text{Min}(3 * t, 18.0) = 18.0 \text{ in OK}$ ACI 7.7.2.3

Z-bar spacing = 9.0 in < $\text{Min}(3 * t, 18.0) = 18.0 \text{ in OK}$

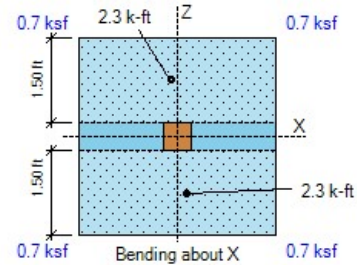
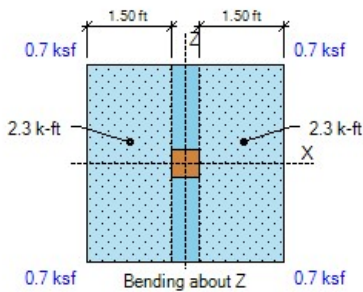

LOAD TRANSFER CALCULATIONS (Comb: 1.2D+1.6L+0.5Lr)

Area $A1 = col L * col W = 6.0 * 6.0 = 36.0 \text{ in}^2$

$Sx = col W * col L^2 / 6 = 6.0 * 6.0^2 / 6 = 36.0 \text{ in}^3$

$Sz = col L * col W^2 / 6 = 6.0 * 6.0^2 / 6 = 36.0 \text{ in}^3$

Bearing $Pbu = P / A1 + Mz / Sx + Mx / Sz = 26.7 / 36.0 + 0.0 * 12 / 36.0 + 0.0 * 12 / 36.0 = 0.7 \text{ ksi}$

Min edge = $\text{Min}(L / 2 - X\text{-offset} - col L / 2, W / 2 - Z\text{-offset} - col W / 2)$

Min edge = $\text{Min}(3.50 * 12 / 2 - 0.0 - 6.0 / 2, 3.50 * 12 / 2 - 0.0 - 6.0 / 2) = 18.0 \text{ in}$

Area $A2 = \text{Min}[L * W, (col L + 2 * \text{Min edge}) * (col W + 2 * \text{Min edge})]$ ACI R22.8.3.2

$A2 = \text{Min}[3.50 * 12 * 3.5 * 12, (6.0 + 2 * 18.0) * (6.0 + 2 * 18.0)] = 1764.0 \text{ in}^2$

Footing $\phi Pnc = \phi * 0.85 * fc * \text{Min}[2, \sqrt{(A2 / A1)}] = 0.65 * 0.85 * 2.5 * \text{Min}[2, \sqrt{(1764.0 / 36.0)}] = 2.8 \text{ ksi}$

Footing $\phi Pns = \phi * As * Fy / A1 = 0.0 \text{ ksi}$ ACI 22.8.3.2

Footing bearing $\phi Pn = \phi Pnc + \phi Pns = 2.8 + 0.0 = 2.8 \text{ ksi} > 0.7 \text{ psi OK}$

Hooked $L_{dh} = \text{Max} (8 db, 6, 0.02 * f_y / (f_c)^{1/2} * \text{Confining} * \text{Location} * \text{Concrete} * db * \text{ratio})$

ACI 25.4.3

$$L_{dh} = \text{Max} (8 db, 6, 0.02 * 60.0 * 1000 / (2500)^{1/2} * 1.0 * 0.7 * 0.0 * 0.75 * 0.13) = 6.0 \text{ in}$$

Ld provided = Dowel length = $3.00 * 12 = 36.0 \text{ in} > 23.1 \text{ in OK}$

Ldh provided = Footing thickness - Cover = $8.00 - 3.0 = 5.0 \text{ in} < 6.0 \text{ in NG}$

PUNCHING SHEAR CALCULATIONS (Comb: 1.2D+1.6L+0.5Lr)

X-Edge = $d/2 = 4.5 / 2 = 2.3 \text{ in}$ $as_x = 20$

Z-Edge = $d/2 = 4.5 / 2 = 2.3 \text{ in}$ $as_z = 20$

$as = as_x + as_z = 20 + 20 = 40$ Col type = Interior $\beta = L / W = 6.0 / 6.0 = 1.00$

ACI 22.6.5.2

Perimeter $bo = as_z / 10 * (L + d/2 + X\text{-Edge}) + as_x / 10 * (W + d/2 + Z\text{-Edge})$

ACI 22.6.4.2

$$bo = 20 / 10 * (6.0 + 4.5 / 2 + 2.3) + 20 / 10 * (6.0 + 4.5 / 2 + 2.3) = 42.0 \text{ in}$$

Area $A_{bo} = (L + d/2 + X\text{-Edge}) * (W + d/2 + Z\text{-Edge}) = (6.0 + 4.5 / 2 + 2.3) * (6.0 + 4.5 / 2 + 2.3) = 110.3 \text{ in}^2$

$\phi V_c = \phi * \text{Min} (2 + 4 / \beta, as * d / bo + 2, 4) * \sqrt{f_c}$

ACI 22.6.5.2

$$\phi V_c = 0.75 * \text{Min} (2 + 4 / 1.00, 40 * 4.5 / 42.0 + 2, 4) * \sqrt{2500} = 150.0 \text{ psi}$$

Punching force $F = P + \text{Overburden} * A_{bo} - \text{Bearing}$

$$F = 26.7 + 0.07 * 110.3 / 144 - 1.7 = 25.1 \text{ kip}$$

$b_1 = L + d/2 + X\text{-Edge} = 6.0 + 4.5 / 2 + 2.3 = 10.5 \text{ in}$ $b_2 = W + d/2 + Z\text{-Edge} = 6.0 + 4.5 / 2 + 2.3 = 10.5 \text{ in}$

$\gamma_{vx} \text{ factor} = 1 - \frac{1}{1 + (2/3) \sqrt{b_2 / b_1}} = 1 - \frac{1}{1 + (2/3) \sqrt{10.5 / 10.5}} = 0.40$

ACI Eq. (8.4.4.2.2)

$\gamma_{vz} \text{ factor} = 1 - \frac{1}{1 + (2/3) \sqrt{b_1 / b_2}} = 1 - \frac{1}{1 + (2/3) \sqrt{10.5 / 10.5}} = 0.40$

ACI Eq. (8.4.2.3.2)

$X_{2z} = b_1 / 2 = 10.5 / 2 = 5.3 \text{ in}$ $X_{2x} = b_2 / 2 = 10.5 / 2 = 5.3 \text{ in}$

$J_{cz} = b_1 * d^3 / 6 + b_1^3 * d / 6 + b_1^2 * b_2 * d / 2$

ACI R8.4.4.2.3

$$J_{cz} = 10.5 * 4.5^3 / 6 + 10.5^3 * 4.5 / 6 + 10.5^2 * 10.5 * 4.5 / 2 = 3632 \text{ in}^4$$

$J_{cx} = b_2 * d^3 / 6 + b_2^3 * d / 6 + b_2^2 * b_1 * d / 2$

ACI R8.4.4.2.3

$$J_{cx} = 10.5 * 4.5^3 / 6 + 10.5^3 * 4.5 / 6 + 10.5^2 * 10.5 * 4.5 / 2 = 3632 \text{ in}^4$$

Stress due to P = $F / (bo * d) * 1000 = 25.1 / (42.0 * 4.5) * 1000 = 132.5 \text{ psi}$

Stress due to Mx = $\gamma_{vx} * X\text{-OTM} * X_{2x} / J_{cx} = 0.40 * 0.0 * 12 * 5.3 / 3632 * 1000 = 0.0 \text{ psi}$

Stress due to Mz = $\gamma_{vz} * Z\text{-OTM} * X_{2z} / J_{cz} = 0.40 * 0.0 * 12 * 5.3 / 3632 * 1000 = 0.0 \text{ psi}$

Punching stress = $P\text{-stress} + Mx\text{-stress} + Mz\text{-stress} = 132.5 + 0.0 + 0.0 = 132.5 \text{ psi} < 150.0 \text{ psi OK}$

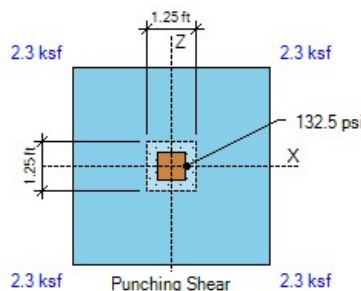

DESIGN CODES

Concrete Design ACI 318-14
Load Combinations ASCE 7-10/16

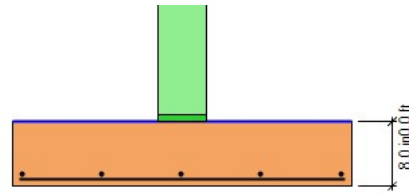

ELEVATION

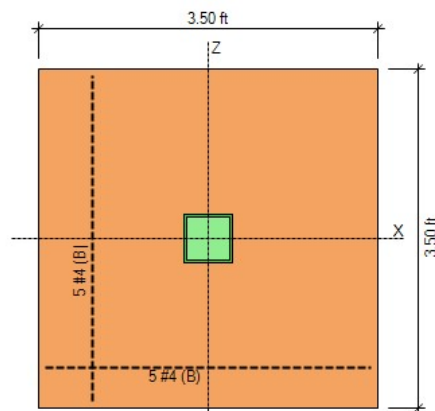

PLAN

ASDIP Foundation 4.8.2.7 **SPREAD FOOTING DESIGN** www.asdipsoft.com

GEOMETRY			SOIL PRESSURES (D+L)		
Footing Length (X-dir)	2.00	ft	Gross Allow. Soil Pressure	2.0	ksf
Footing Width (Z-dir)	2.60	ft	Soil Pressure at Corner 1	2.0	ksf
Footing Thickness	8.0	in OK	Soil Pressure at Corner 2	2.0	ksf
Soil Cover	0.00	ft	Soil Pressure at Corner 3	2.0	ksf
Column Length (X-dir)	6.0	in	Soil Pressure at Corner 4	2.0	ksf
Column Width (Z-dir)	6.0	in	Bearing Pressure Ratio	0.99	OK
Offset (X-dir)	0.00	in OK	Ftg. Area in Contact with Soil	100.0	%
Offset (Z-dir)	0.00	in OK	X-eccentricity / Ftg. Length	0.00	OK
Base Plate (L x W)	6.0 x 6.0	in	Z-eccentricity / Ftg. Width	0.00	OK

APPLIED LOADS

	Dead	Live	RLive	Snow	Wind	Seismic	
Axial Force P	4.5	5.5	0.0	0.0	0.0	0.0	kip
Moment about X Mx ..	0.0	0.0	0.0	0.0	0.0	0.0	k-ft
Moment about Z Mz ..	0.0	0.0	0.0	0.0	0.0	0.0	k-ft
Shear Force Vx	0.0	0.0	0.0	0.0	0.0	0.0	kip
Shear Force Vz	0.0	0.0	0.0	0.0	0.0	0.0	kip

OVERTURNING CALCULATIONS (Comb: 0.6D+0.6W)

- Overturning about X-X

- Moment Mx = 0.6 * 0.0 + 0.6 * 0.0 = 0.0 k-ft
- Shear Force Vz = 0.6 * 0.0 + 0.6 * 0.0 = 0.0 kip
 Arm = 0.00 + 8.0 / 12 = 0.67 ft Moment = 0.0 * 0.67 = 0.0 k-ft
- Passive Force = 0.0 kip Arm = 0.27 ft Moment = 0.0 k-ft
- Overturning moment X-X = 0.0 + 0.0 = 0.0 k-ft

- Resisting about X-X

- Footing weight = 0.6 * W * L * Thick * Density = 0.6 * 2.60 * 2.00 * 8.0 / 12 * 0.15 = 0.3 kip
 Arm = W / 2 = 2.60 / 2 = 1.30 ft Moment = 0.3 * 1.30 = 0.4 k-ft
- Pedestal weight = 0.6 * W * L * H * Density = 0.6 * 6.0 / 12 * 6.0 / 12 * 0.0 * 0.15 = 0.0 kip
 Arm = W / 2 - Offset = 2.60 / 2 - 0.0 / 12 = 1.30 ft Moment = 0.0 * 1.30 = 0.0 k-ft
- Soil cover = 0.6 * W * L * SC * Density = 0.6 * (2.60 * 2.00 - 6.0 / 12 * 6.0 / 12) * 0.0 * 110 = 0.0 kip
 Arm = W / 2 = 2.60 / 2 = 1.30 ft Moment = 0.0 * 1.30 = 0.0 k-ft
- Buoyancy = 0.6 * W * L * γ * (SC + Thick - WT) = 0.6 * 2.60 * 2.00 * 62 * (0.67) = -0.1 kip
 Arm = W / 2 = 2.60 / 2 = 1.30 ft Moment = 0.1 * 1.30 = -0.2 k-ft
- Axial force P = 0.6 * 4.5 + 0.6 * 0.0 = 2.7 kip
 Arm = W / 2 - Offset = 2.60 / 2 - 0.0 / 12 = 1.30 ft Moment = 2.7 * 1.30 = 3.5 k-ft
- Resisting moment X-X = 0.4 + 0.0 + 0.0 + 3.5 + -0.2 = 3.7 k-ft

- Overturning safety factor X-X = $\frac{\text{Resisting moment}}{\text{Overturning moment}} = \frac{3.7}{0.0} = 37.47 > 1.50$ **OK**

ASDIP Foundation 4.8.2.7 **SPREAD FOOTING DESIGN** www.asdipsoft.com

- Overturning about Z-Z

- Moment $M_z = 0.6 * 0.0 + 0.6 * 0.0 = 0.0$ k-ft
- Shear Force $V_x = 0.6 * 0.0 + 0.6 * 0.0 = 0.0$ kip
 Arm = $0.00 + 8.0 / 12 = 0.67$ ft Moment = $0.0 * 0.67 = 0.0$ k-ft
- Passive Force = 0.0 kip Arm = 0.27 ft Moment = 0.0 k-ft
- Overturning moment Z-Z = $0.0 + 0.0 = 0.0$ k-ft

- Resisting about Z-Z

- Footing weight = $0.6 * W * L * Thick * Density = 0.6 * 2.60 * 2.00 * 8.0 / 12 * 0.15 = 0.3$ kip
 Arm = $L / 2 = 2.00 / 2 = 1.00$ ft Moment = $0.3 * 1.00 = 0.3$ k-ft
- Pedestal weight = $0.6 * W * L * H * Density = 0.6 * 6.0 / 12 * 6.0 / 12 * 0.0 * 0.15 = 0.0$ kip
 Arm = $L / 2 - Offset = 2.00 / 2 - 0.0 / 12 = 1.00$ ft Moment = $0.0 * 1.00 = 0.0$ k-ft
- Soil cover = $0.6 * W * L * SC * Density = 0.6 * (2.60 * 2.00 - 6.0 / 12 * 6.0 / 12) * 0.0 * 110 = 0.0$ kip
 Arm = $L / 2 = 2.00 / 2 = 1.00$ ft Moment = $0.0 * 1.00 = 0.0$ k-ft
- Buoyancy = $0.6 * W * L * \gamma * (SC + Thick - WT) = 0.6 * 2.60 * 2.00 * 62 * (0.67) = -0.1$ kip
 Arm = $L / 2 = 2.00 / 2 = 1.00$ ft Moment = $0.1 * 1.00 = -0.1$ k-ft
- Axial force $P = 0.6 * 4.5 + 0.6 * 0.0 = 2.7$ kip
 Arm = $L / 2 - Offset = 2.00 / 2 - 0.0 / 12 = 1.00$ ft Moment = $2.7 * 1.00 = 2.7$ k-ft
- Resisting moment Z-Z = $0.3 + 0.0 + 0.0 + 2.7 + -0.1 = 2.9$ k-ft
- Overturning safety factor Z-Z = $\frac{Resisting\ moment}{Overturning\ moment} = \frac{2.9}{0.0} = 28.82 > 1.50$ OK

SOIL BEARING PRESSURES (Comb: D+L)

- Overturning moment X-X = $0.0 + 0.0 = 0.0$ k-ft
- Resisting moment X-X = $0.7 + 0.0 + 0.0 + -0.3 + 13.0 = 13.4$ k-ft
- Overturning moment Z-Z = $0.0 + 0.0 = 0.0$ k-ft
- Resisting moment Z-Z = $0.5 + 0.0 + 0.0 + -0.2 + 10.0 = 10.3$ k-ft
- Resisting force = $Footing + Pedestal + Soil - Buoyancy + P = 0.5 + 0.0 + 0.0 - 0.2 + 10.0 = 10.3$ kip

X-coordinate of resultant from maximum bearing corner:

$$X_p = \frac{Z-Resisting\ moment - Z-Overturning\ moment}{Resisting\ force} = \frac{10.3 - 0.0}{10.3} = 1.00\text{ ft}$$

Z-coordinate of resultant from maximum bearing corner:

$$Z_p = \frac{X-Resisting\ moment - X-Overturning\ moment}{Resisting\ force} = \frac{13.4 - 0.0}{10.3} = 1.30\text{ ft}$$

X-ecc = $Length / 2 - X_p = 2.00 / 2 - 1.00 = 0.00$ ft

Z-ecc = $Width / 2 - Z_p = 2.60 / 2 - 1.30 = 0.00$ ft

Area = $Width * Length = 2.60 * 2.00 = 5.2$ ft²

$S_x = Length * Width^2 / 6 = 2.00 * 2.60^2 / 6 = 2.3$ ft³

$S_z = Width * Length^2 / 6 = 2.60 * 2.00^2 / 6 = 1.7$ ft³

- Footing is in full bearing. Soil pressures are as follows:

$P_1 = P * (1/A + Z-ecc / S_x + X-ecc / S_z) = 10.3 * (1 / 5.2 + 0.00 / 2.3 + 0.00 / 1.7) = 1.98$ ksf

$P_2 = P * (1/A - Z-ecc / S_x + X-ecc / S_z) = 10.3 * (1 / 5.2 - 0.00 / 2.3 + 0.00 / 1.7) = 1.98$ ksf

$P_3 = P * (1/A - Z-ecc / S_x - X-ecc / S_z) = 10.3 * (1 / 5.2 - 0.00 / 2.3 - 0.00 / 1.7) = 1.98$ ksf

$P_4 = P * (1/A + Z-ecc / S_x - X-ecc / S_z) = 10.3 * (1 / 5.2 + 0.00 / 2.3 - 0.00 / 1.7) = 1.98$ ksf

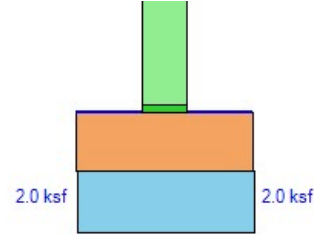
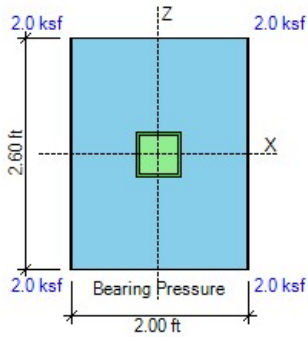

SLIDING CALCULATIONS (Comb: 0.6D+0.6W)

Internal friction angle = 28.0 deg

Passive coefficient $k_p = 4.33$ (per Coulomb)

Pressure at mid-depth = $k_p * Density * (Cover + Thick / 2) = 4.33 * 110 * (0.00 + 8.0 / 12 / 2) = 0.16$ ksf

X-Passive force = $Pressure * Thick * Width = 0.16 * 8.0 / 12 * 2.60 = 0.3$ kip

Z-Passive force = $Pressure * Thick * Length = 0.16 * 8.0 / 12 * 2.00 = 0.2$ kip

Friction force = $Resisting\ force * Friction\ coeff. = \text{Max}(0, 2.9 * 0.35) = 1.0$ kip

Use 100% of Passive + 100% of Friction for sliding resistance

$$\text{- Sliding safety factor X-X} = \frac{X\text{-Passive force} + Friction}{X\text{-Horizontal load}} = \frac{1.00 * 0.3 + 1.00 * 1.0}{0.0} = 12.84 > 1.50 \text{ OK}$$

$$\text{- Sliding safety factor Z-Z} = \frac{Z\text{-Passive force} + Friction}{Z\text{-Horizontal load}} = \frac{1.00 * 0.2 + 1.00 * 1.0}{0.0} = 12.20 > 1.50 \text{ OK}$$

UPLIFT CALCULATIONS (Comb: 0.6D+0.6W)

$$\text{- Uplift safety factor} = \frac{Pedestal + Footing + Cover - Buoyancy}{Uplift load} = \frac{0.0 + 0.3 + 0.0 - 0.1}{0.0} = 99.99 > 1.00 \text{ OK}$$

ONE-WAY SHEAR CALCULATIONS (Comb: 1.2D+1.6L+0.5Lr)

Concrete $f_c = 2.5$ ksi

Steel $f_y = 40.0$ ksi

Soil density = 110 pcf

Use Plain Concrete Shear Strength

$$\phi V_{cx} = \frac{4}{3} * \phi * \sqrt{f_c} * Width * t / 1000 = \frac{4}{3} * 0.60 * \sqrt{2500} * 2.6 * 12 * 8.0 / 1000 = 10.0 \text{ kip}$$

ACI 14.5.5.1

$$\phi V_{cz} = \frac{4}{3} * \phi * \sqrt{f_c} * Length * t / 1000 = \frac{4}{3} * 0.60 * \sqrt{2500} * 2.0 * 12 * 8.0 / 1000 = 7.7 \text{ kip}$$

- Shear forces calculated as the volume of the bearing pressures under the effective areas:

$$\text{One-way shear } V_{ux} \text{ (- Side)} = 0.6 \text{ kip} < 10.0 \text{ kip OK}$$

$$\text{One-way shear } V_{ux} \text{ (+ Side)} = 0.6 \text{ kip} < 10.0 \text{ kip OK}$$

$$\text{One-way shear } V_{uz} \text{ (- Side)} = 2.1 \text{ kip} < 7.7 \text{ kip OK}$$

$$\text{One-way shear } V_{uz} \text{ (+ Side)} = 2.1 \text{ kip} < 7.7 \text{ kip OK}$$

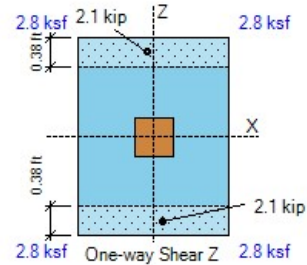
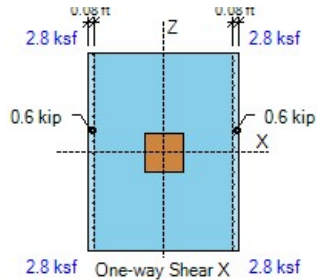

FLEXURE CALCULATIONS (Comb: 1.2D+1.6L+0.5Lr)

Plain $\phi M_{nx} = 5 * \phi * \sqrt{f_c} * L * Thick^2 / 6 = 5 * 0.60 * \sqrt{(2500)} * 2.00 * 8.0^2 / 6 / 1000 = 0.9$ k-ft

ACI Eq. (14.5.2.1a)

Plain $\phi M_{nz} = 5 * \phi * \sqrt{f_c} * W * Thick^2 / 6 = 5 * 0.60 * \sqrt{(2500)} * 2.60 * 8.0^2 / 6 / 1000 = 1.1$ k-ft

- Top Bars

No Top Reinforcement Provided at the Footing

Use Plain Concrete Flexural Strength at Top

- Top moments calculated as the overburden minus the bearing pressures times the lever arm:

Top moment -M_{ux} (- Side) = 0.0 k-ft < 3.2 k-ft OK

Top moment -M_{ux} (+ Side) = 0.0 k-ft < 3.2 k-ft OK

Top moment -M_{uz} (- Side) = 0.0 k-ft < 4.2 k-ft OK

Top moment -M_{uz} (+ Side) = 0.0 k-ft < 4.2 k-ft OK

- Bottom Bars

No Bottom Reinforcement Provided at the Footing

Use Plain Concrete Flexural Strength at Bottom

- Bottom moments calculated as the bearing pressure minus the overburden pressures times the lever arm:

Bottom moment M_{ux} (- Side) = 3.0 k-ft < 3.2 k-ft OK ratio = 0.94

Bottom moment M_{ux} (+ Side) = 3.0 k-ft < 3.2 k-ft OK ratio = 0.94

Bottom moment M_{uz} (- Side) = 2.0 k-ft < 4.2 k-ft OK ratio = 0.48

Bottom moment M_{uz} (+ Side) = 2.0 k-ft < 4.2 k-ft OK ratio = 0.48

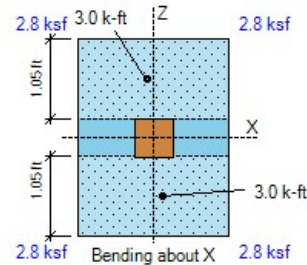
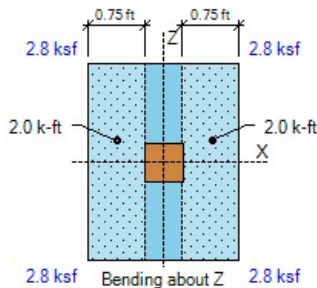

LOAD TRANSFER CALCULATIONS (Comb: 1.2D+1.6L+0.5Lr)

Area $A1 = col L * col W = 6.0 * 6.0 = 36.0 \text{ in}^2$

$Sx = col W * col L^2 / 6 = 6.0 * 6.0^2 / 6 = 36.0 \text{ in}^3$

$Sz = col L * col W^2 / 6 = 6.0 * 6.0^2 / 6 = 36.0 \text{ in}^3$

Bearing $Pbu = P / A1 + Mz / Sx + Mx / Sz = 14.2 / 36.0 + 0.0 * 12 / 36.0 + 0.0 * 12 / 36.0 = 0.4 \text{ ksi}$

Min edge = $Min (L / 2 - X\text{-offset} - col L / 2, W / 2 - Z\text{-offset} - col W / 2)$

Min edge = $Min (2.00 * 12 / 2 - 0.0 - 6.0 / 2, 2.60 * 12 / 2 - 0.0 - 6.0 / 2) = 9.0 \text{ in}$

Area $A2 = Min [L * W, (col L + 2 * Min edge) * (col W + 2 * Min edge)]$

ACI R22.8.3.2

$A2 = Min [2.00 * 12 * 2.6 * 12, (6.0 + 2 * 9.0) * (6.0 + 2 * 9.0)] = 576.0 \text{ in}^2$

Footing $\phi Pnc = \phi * 0.85 * fc * Min [2, \sqrt{(A2 / A1)}] = 0.65 * 0.85 * 2.5 * Min [2, \sqrt{(576.0 / 36.0)}] = 2.8 \text{ ksi}$

Footing $\phi Pns = \phi * As * Fy / A1 = 0.0 \text{ ksi}$

ACI 22.8.3.2

Footing bearing $\phi Pn = \phi Pnc + \phi Pns = 2.8 + 0.0 = 2.8 \text{ ksi} > 0.4 \text{ psi OK}$

ASDIP Foundation 4.8.2.7 SPREAD FOOTING DESIGN www.asdipsoft.com

Hooked $L_{dh} = \text{Max}(8 db, 6, 0.02 * f_y / (f_c)^{1/2} * \text{Confining} * \text{Location} * \text{Concrete} * db * \text{ratio})$ ACI 25.4.3
 $L_{dh} = \text{Max}(8 db, 6, 0.02 * 60.0 * 1000 / (2500)^{1/2} * 1.0 * 0.7 * 0.0 * 0.75 * 0.07) = 6.0 \text{ in}$
 Ld provided = Dowel length = $3.00 * 12 = 36.0 \text{ in} > 12.3 \text{ in OK}$
 Ldh provided = Footing thickness - Cover = $8.00 - 3.0 = 5.0 \text{ in} < 6.0 \text{ in NG}$

PUNCHING SHEAR CALCULATIONS (Comb: 1.2D+1.6L+0.5Lr)

X-Edge = $\text{Length} / 2 - \text{Offset} - \text{Col} / 2 = 2.00 * 12 / 2 - 0.0 - 6.0 / 2 = 9.0 \text{ in}$ asx = 10
 Z-Edge = $\text{Width} / 2 - \text{Offset} - \text{Col} / 2 = 2.60 * 12 / 2 - 0.0 - 6.0 / 2 = 12.6 \text{ in}$ asz = 10
 as = asx + asz = 10 + 10 = 20 Col type = Corner $\beta = L / W = 6.0 / 6.0 = 1.00$ ACI 22.6.5.2

Perimeter $b_o = asz / 10 * (L + d / 2 + X\text{-Edge}) + asx / 10 * (W + d / 2 + Z\text{-Edge})$ ACI 22.6.4.2
 $b_o = 10 / 10 * (6.0 + 8.0 / 2 + 9.0) + 10 / 10 * (6.0 + 8.0 / 2 + 12.6) = 41.6 \text{ in}$
 Area $A_{bo} = (L + d / 2 + X\text{-Edge}) * (W + d / 2 + Z\text{-Edge}) = (6.0 + 8.0 / 2 + 9.0) * (6.0 + 8.0 / 2 + 12.6) = 429.4 \text{ in}^2$

Use Plain Concrete Shear Strength
 $\phi V_c = \phi * \text{Min}(1 + 2 / \beta, 2) * 4/3 * \sqrt{f_c}$ ACI 14.5.5.1
 $\phi V_c = 0.60 * \text{Min}(1 + 2 / 1.00, 2) * 4/3 * \sqrt{2500} = 80.0 \text{ psi}$

Punching force $F = P + \text{Overburden} * A_{bo} - \text{Bearing}$
 $F = 14.2 + 0.07 * 429.4 / 144 - 3.8 = 10.6 \text{ kip}$
 $b_1 = L + d / 2 + X\text{-Edge} = 6.0 + 8.0 / 2 + 9.0 = 19.0 \text{ in}$ $b_2 = W + d / 2 + Z\text{-Edge} = 6.0 + 8.0 / 2 + 12.6 = 22.6 \text{ in}$

$\gamma_{vx} \text{ factor} = 1 - \frac{1}{1 + (2/3) \sqrt{b_2 / b_1}} = 1 - \frac{1}{1 + (2/3) \sqrt{22.6 / 19.0}} = 0.42$ ACI Eq. (8.4.4.2.2)
 $\gamma_{vz} \text{ factor} = 1 - \frac{1}{1 + (2/3) \sqrt{b_1 / b_2}} = 1 - \frac{1}{1 + (2/3) \sqrt{19.0 / 22.6}} = 0.38$ ACI Eq. (8.4.2.3.2)

$X_{2z} = b_1^2 / 2 / (b_1 + b_2) = 19.0^2 / 2 / (19.0 + 22.6) = 4.3 \text{ in}$ $X_{2x} = b_2^2 / 2 / (b_2 + b_1) = 6.1 \text{ in}$
 $J_{cz} = b_1 * d^3 / 12 + b_1^3 * d / 12 + b_1 * d * (b_1 / 2 - X_{2z})^2 + b_2 * d * X_{2z}^2$ ACI R8.4.4.2.3

$J_{cz} = 19.0 * 8.0^3 / 12 + 19.0^3 * 8.0 / 12 + 19.0 * 8.0 * (19.0 / 2 * 4.3)^2 + 22.6 * 8.0 * 4.3^2 = 12836 \text{ in}^4$
 $J_{cx} = b_2 * d^3 / 12 + b_2^3 * d / 12 + b_2 * d * (b_2 / 2 - X_{2x})^2 + b_1 * d * X_{2x}^2$ ACI R8.4.4.2.3
 $J_{cx} = 22.6 * 8.0^3 / 12 + 22.6^3 * 8.0 / 12 + 22.6 * 8.0 * (22.6 / 2 * 6.1)^2 + 19.0 * 8.0 * 6.1^2 = 19204 \text{ in}^4$

Stress due to P = $F / (b_o * d) * 1000 = 10.6 / (41.6 * 8.0) * 1000 = 31.8 \text{ psi}$
 Stress due to Mx = $\gamma_{vx} * X\text{-OTM} * X_{2x} / J_{cx} = 0.42 * 0.0 * 12 * 6.1 / 19204 * 1000 = 0.0 \text{ psi}$
 Stress due to Mz = $\gamma_{vz} * Z\text{-OTM} * X_{2z} / J_{cz} = 0.42 * 0.0 * 12 * 4.3 / 12836 * 1000 = 0.0 \text{ psi}$
 Punching stress = P-stress + Mx-stress + Mz-stress = $31.8 + 0.0 + 0.0 = 31.8 \text{ psi} < 80.0 \text{ psi OK}$

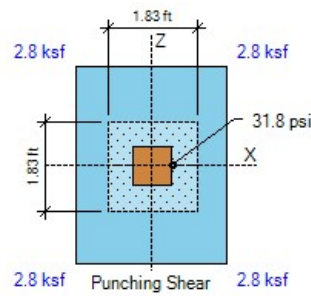

DESIGN CODES

Concrete Design ACI 318-14
Load Combinations ASCE 7-10/16

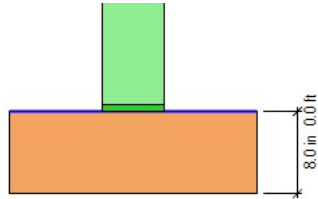

ELEVATION

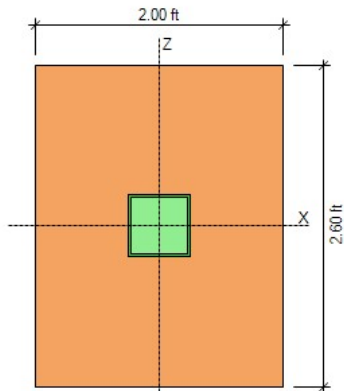

PLAN

ASDIP Foundation 4.8.2.7 **SPREAD FOOTING DESIGN** www.asdipsoft.com

GEOMETRY			SOIL PRESSURES (D+L)		
Footing Length (X-dir)	1.50	ft	Gross Allow. Soil Pressure	2.0	ksf
Footing Width (Z-dir)	2.60	ft	Soil Pressure at Corner 1	2.0	ksf
Footing Thickness	8.0	in OK	Soil Pressure at Corner 2	2.0	ksf
Soil Cover	0.00	ft	Soil Pressure at Corner 3	2.0	ksf
Column Length (X-dir)	6.0	in	Soil Pressure at Corner 4	2.0	ksf
Column Width (Z-dir)	6.0	in	Bearing Pressure Ratio	0.99	OK
Offset (X-dir)	0.00	in OK	Ftg. Area in Contact with Soil	100.0	%
Offset (Z-dir)	0.00	in OK	X-eccentricity / Ftg. Length	0.00	OK
Base Plate (L x W)	6.0 x 6.0	in	Z-eccentricity / Ftg. Width	0.00	OK

APPLIED LOADS

	Dead	Live	RLive	Snow	Wind	Seismic	
Axial Force P	3.0	4.5	0.0	0.0	0.0	0.0	kip
Moment about X Mx ..	0.0	0.0	0.0	0.0	0.0	0.0	k-ft
Moment about Z Mz ..	0.0	0.0	0.0	0.0	0.0	0.0	k-ft
Shear Force Vx	0.0	0.0	0.0	0.0	0.0	0.0	kip
Shear Force Vz	0.0	0.0	0.0	0.0	0.0	0.0	kip

OVERTURNING CALCULATIONS (Comb: 0.6D+0.6W)

- Overturning about X-X

- Moment Mx = 0.6 * 0.0 + 0.6 * 0.0 = 0.0 k-ft

- Shear Force Vz = 0.6 * 0.0 + 0.6 * 0.0 = 0.0 kip

Arm = 0.00 + 8.0 / 12 = 0.67 ft

Moment = 0.0 * 0.67 = 0.0 k-ft

- Passive Force = 0.0 kip

Arm = 0.27 ft

Moment = 0.0 k-ft

- Overturning moment X-X = 0.0 + 0.0 = 0.0 k-ft

- Resisting about X-X

- Footing weight = 0.6 * W * L * Thick * Density = 0.6 * 2.60 * 1.50 * 8.0 / 12 * 0.15 = 0.2 kip

Arm = W / 2 = 2.60 / 2 = 1.30 ft

Moment = 0.2 * 1.30 = 0.3 k-ft

- Pedestal weight = 0.6 * W * L * H * Density = 0.6 * 6.0 / 12 * 6.0 / 12 * 0.0 * 0.15 = 0.0 kip

Arm = W / 2 - Offset = 2.60 / 2 - 0.0 / 12 = 1.30 ft

Moment = 0.0 * 1.30 = 0.0 k-ft

- Soil cover = 0.6 * W * L * SC * Density = 0.6 * (2.60 * 1.50 - 6.0 / 12 * 6.0 / 12) * 0.0 * 110 = 0.0 kip

Arm = W / 2 = 2.60 / 2 = 1.30 ft

Moment = 0.0 * 1.30 = 0.0 k-ft

- Buoyancy = 0.6 * W * L * γ * (SC + Thick - WT) = 0.6 * 2.60 * 1.50 * 62 * (0.67) = -0.1 kip

Arm = W / 2 = 2.60 / 2 = 1.30 ft

Moment = 0.1 * 1.30 = -0.1 k-ft

- Axial force P = 0.6 * 3.0 + 0.6 * 0.0 = 1.8 kip

Arm = W / 2 - Offset = 2.60 / 2 - 0.0 / 12 = 1.30 ft

Moment = 1.8 * 1.30 = 2.3 k-ft

- Resisting moment X-X = 0.3 + 0.0 + 0.0 + 2.3 + -0.1 = 2.5 k-ft

- Overturning safety factor X-X = $\frac{\text{Resisting moment}}{\text{Overturning moment}} = \frac{2.5}{0.0} = 25.18 > 1.50$ OK

- Overturning about Z-Z

$$\text{- Moment } M_z = 0.6 * 0.0 + 0.6 * 0.0 = 0.0 \text{ k-ft}$$

$$\text{- Shear Force } V_x = 0.6 * 0.0 + 0.6 * 0.0 = 0.0 \text{ kip}$$

$$\text{Arm} = 0.00 + 8.0 / 12 = 0.67 \text{ ft}$$

$$\text{Moment} = 0.0 * 0.67 = 0.0 \text{ k-ft}$$

$$\text{- Passive Force} = 0.0 \text{ kip}$$

$$\text{Arm} = 0.27 \text{ ft}$$

$$\text{Moment} = 0.0 \text{ k-ft}$$

$$\text{- Overturning moment Z-Z} = 0.0 + 0.0 = 0.0 \text{ k-ft}$$

- Resisting about Z-Z

$$\text{- Footing weight} = 0.6 * W * L * Thick * Density = 0.6 * 2.60 * 1.50 * 8.0 / 12 * 0.15 = 0.2 \text{ kip}$$

$$\text{Arm} = L / 2 = 1.50 / 2 = 0.75 \text{ ft}$$

$$\text{Moment} = 0.2 * 0.75 = 0.2 \text{ k-ft}$$

$$\text{- Pedestal weight} = 0.6 * W * L * H * Density = 0.6 * 6.0 / 12 * 6.0 / 12 * 0.0 * 0.15 = 0.0 \text{ kip}$$

$$\text{Arm} = L / 2 - Offset = 1.50 / 2 - 0.0 / 12 = 0.75 \text{ ft}$$

$$\text{Moment} = 0.0 * 0.75 = 0.0 \text{ k-ft}$$

$$\text{- Soil cover} = 0.6 * W * L * SC * Density = 0.6 * (2.60 * 1.50 - 6.0 / 12 * 6.0 / 12) * 0.0 * 110 = 0.0 \text{ kip}$$

$$\text{Arm} = L / 2 = 1.50 / 2 = 0.75 \text{ ft}$$

$$\text{Moment} = 0.0 * 0.75 = 0.0 \text{ k-ft}$$

$$\text{- Buoyancy} = 0.6 * W * L * \gamma * (SC + Thick - WT) = 0.6 * 2.60 * 1.50 * 62 * (0.67) = -0.1 \text{ kip}$$

$$\text{Arm} = L / 2 = 1.50 / 2 = 0.75 \text{ ft}$$

$$\text{Moment} = 0.1 * 0.75 = -0.1 \text{ k-ft}$$

$$\text{- Axial force } P = 0.6 * 3.0 + 0.6 * 0.0 = 1.8 \text{ kip}$$

$$\text{Arm} = L / 2 - Offset = 1.50 / 2 - 0.0 / 12 = 0.75 \text{ ft}$$

$$\text{Moment} = 1.8 * 0.75 = 1.4 \text{ k-ft}$$

$$\text{- Resisting moment Z-Z} = 0.2 + 0.0 + 0.0 + 1.4 + -0.1 = 1.5 \text{ k-ft}$$

$$\text{- Overturning safety factor Z-Z} = \frac{\text{Resisting moment}}{\text{Overturning moment}} = \frac{1.5}{0.0} = 14.52 > 1.50 \text{ OK}$$

SOIL BEARING PRESSURES (Comb: D+L)

$$\text{Overturning moment X-X} = 0.0 + 0.0 = 0.0 \text{ k-ft}$$

$$\text{Resisting moment X-X} = 0.5 + 0.0 + 0.0 + -0.2 + 9.8 = 10.0 \text{ k-ft}$$

$$\text{Overturning moment Z-Z} = 0.0 + 0.0 = 0.0 \text{ k-ft}$$

$$\text{Resisting moment Z-Z} = 0.3 + 0.0 + 0.0 + -0.1 + 5.6 = 5.8 \text{ k-ft}$$

$$\text{Resisting force} = \text{Footing} + \text{Pedestal} + \text{Soil} - \text{Buoyancy} + P = 0.4 + 0.0 + 0.0 - 0.2 + 7.5 = 7.7 \text{ kip}$$

X-coordinate of resultant from maximum bearing corner:

$$X_p = \frac{Z\text{-Resisting moment} - Z\text{-Overturning moment}}{\text{Resisting force}} = \frac{5.8 - 0.0}{7.7} = 0.75 \text{ ft}$$

Z-coordinate of resultant from maximum bearing corner:

$$Z_p = \frac{X\text{-Resisting moment} - X\text{-Overturning moment}}{\text{Resisting force}} = \frac{10.0 - 0.0}{7.7} = 1.30 \text{ ft}$$

$$X\text{-ecc} = \text{Length} / 2 - X_p = 1.50 / 2 - 0.75 = 0.00 \text{ ft}$$

$$Z\text{-ecc} = \text{Width} / 2 - Z_p = 2.60 / 2 - 1.30 = 0.00 \text{ ft}$$

$$\text{Area} = \text{Width} * \text{Length} = 2.60 * 1.50 = 3.9 \text{ ft}^2$$

$$S_x = \text{Length} * \text{Width}^2 / 6 = 1.50 * 2.60^2 / 6 = 1.7 \text{ ft}^3$$

$$S_z = \text{Width} * \text{Length}^2 / 6 = 2.60 * 1.50^2 / 6 = 1.0 \text{ ft}^3$$

- Footing is in full bearing. Soil pressures are as follows:

$$P_1 = P * (1/A + Z\text{-ecc} / S_x + X\text{-ecc} / S_z) = 7.7 * (1 / 3.9 + 0.00 / 1.7 + 0.00 / 1.0) = 1.98 \text{ ksf}$$

$$P_2 = P * (1/A - Z\text{-ecc} / S_x + X\text{-ecc} / S_z) = 7.7 * (1 / 3.9 - 0.00 / 1.7 + 0.00 / 1.0) = 1.98 \text{ ksf}$$

$$P_3 = P * (1/A - Z\text{-ecc} / S_x - X\text{-ecc} / S_z) = 7.7 * (1 / 3.9 - 0.00 / 1.7 - 0.00 / 1.0) = 1.98 \text{ ksf}$$

$$P_4 = P * (1/A + Z\text{-ecc} / S_x - X\text{-ecc} / S_z) = 7.7 * (1 / 3.9 + 0.00 / 1.7 - 0.00 / 1.0) = 1.98 \text{ ksf}$$

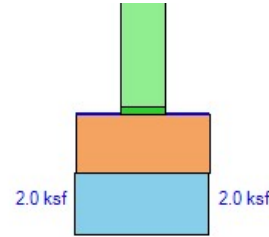
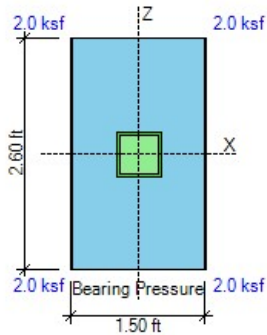

SLIDING CALCULATIONS (Comb: 0.6D+0.6W)

Internal friction angle = 28.0 deg

Passive coefficient $k_p = 4.33$ (per Coulomb)

Pressure at mid-depth = $k_p * Density * (Cover + Thick / 2) = 4.33 * 110 * (0.00 + 8.0 / 12 / 2) = 0.16$ ksf

X-Passive force = $Pressure * Thick * Width = 0.16 * 8.0 / 12 * 2.60 = 0.3$ kip

Z-Passive force = $Pressure * Thick * Length = 0.16 * 8.0 / 12 * 1.50 = 0.2$ kip

Friction force = $Resisting\ force * Friction\ coeff. = \text{Max}(0, 1.9 * 0.35) = 0.7$ kip

Use 100% of Passive + 100% of Friction for sliding resistance

$$\text{- Sliding safety factor X-X} = \frac{X\text{-Passive force} + \text{Friction}}{X\text{-Horizontal load}} = \frac{1.00 * 0.3 + 1.00 * 0.7}{0.0} = 9.53 > 1.50 \text{ OK}$$

$$\text{- Sliding safety factor Z-Z} = \frac{Z\text{-Passive force} + \text{Friction}}{Z\text{-Horizontal load}} = \frac{1.00 * 0.2 + 1.00 * 0.7}{0.0} = 8.36 > 1.50 \text{ OK}$$

UPLIFT CALCULATIONS (Comb: 0.6D+0.6W)

$$\text{- Uplift safety factor} = \frac{\text{Pedestal} + \text{Footing} + \text{Cover} - \text{Buoyancy}}{\text{Uplift load}} = \frac{0.0 + 0.2 + 0.0 - 0.1}{0.0} = 99.99 > 1.00 \text{ OK}$$

ONE-WAY SHEAR CALCULATIONS (Comb: 1.2D+1.6L+0.5Lr)

Concrete $f_c = 2.5$ ksi

Steel $f_y = 40.0$ ksi

Soil density = 110 pcf

Use Plain Concrete Shear Strength

$$\phi V_{cx} = \frac{4}{3} * \phi * \sqrt{f_c} * Width * t / 1000 = \frac{4}{3} * 0.60 * \sqrt{2500} * 2.6 * 12 * 8.0 / 1000 = 10.0 \text{ kip}$$

ACI 14.5.5.1

$$\phi V_{cz} = \frac{4}{3} * \phi * \sqrt{f_c} * Length * t / 1000 = \frac{4}{3} * 0.60 * \sqrt{2500} * 1.5 * 12 * 8.0 / 1000 = 5.8 \text{ kip}$$

- Shear forces calculated as the volume of the bearing pressures under the effective areas:

$$\text{One-way shear } V_{ux} \text{ (- Side)} = 0.0 \text{ kip} < 10.0 \text{ kip OK}$$

$$\text{One-way shear } V_{ux} \text{ (+ Side)} = 0.0 \text{ kip} < 10.0 \text{ kip OK}$$

$$\text{One-way shear } V_{uz} \text{ (- Side)} = 1.6 \text{ kip} < 5.8 \text{ kip OK}$$

$$\text{One-way shear } V_{uz} \text{ (+ Side)} = 1.6 \text{ kip} < 5.8 \text{ kip OK}$$

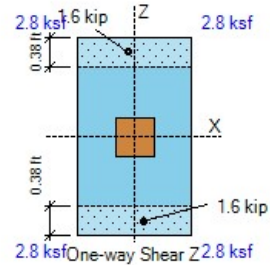
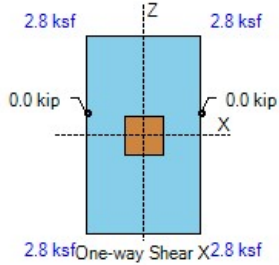

FLEXURE CALCULATIONS (Comb: 1.2D+1.6L+0.5Lr)

Plain $\phi M_{nx} = 5 * \phi * \sqrt{f_c} * L * Thick^2 / 6 = 5 * 0.60 * \sqrt{(2500)} * 1.50 * 8.0^2 / 6 / 1000 = 0.6$ k-ft ACI Eq. (14.5.2.1a)

Plain $\phi M_{nz} = 5 * \phi * \sqrt{f_c} * W * Thick^2 / 6 = 5 * 0.60 * \sqrt{(2500)} * 2.60 * 8.0^2 / 6 / 1000 = 1.1$ k-ft

- Top Bars

No Top Reinforcement Provided at the Footing

Use Plain Concrete Flexural Strength at Top

- Top moments calculated as the overburden minus the bearing pressures times the lever arm:

Top moment -M_{ux} (- Side) = 0.0 k-ft < 2.4 k-ft OK

Top moment -M_{ux} (+ Side) = 0.0 k-ft < 2.4 k-ft OK

Top moment -M_{uz} (- Side) = 0.0 k-ft < 4.2 k-ft OK

Top moment -M_{uz} (+ Side) = 0.0 k-ft < 4.2 k-ft OK

- Bottom Bars

No Bottom Reinforcement Provided at the Footing

Use Plain Concrete Flexural Strength at Bottom

- Bottom moments calculated as the bearing pressure minus the overburden pressures times the lever arm:

Bottom moment M_{ux} (- Side) = 2.3 k-ft < 2.4 k-ft OK ratio = 0.96

Bottom moment M_{ux} (+ Side) = 2.3 k-ft < 2.4 k-ft OK ratio = 0.96

Bottom moment M_{uz} (- Side) = 0.9 k-ft < 4.2 k-ft OK ratio = 0.22

Bottom moment M_{uz} (+ Side) = 0.9 k-ft < 4.2 k-ft OK ratio = 0.22

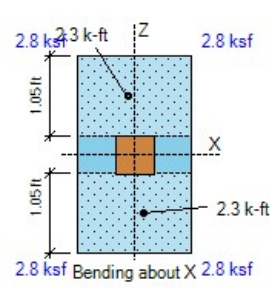
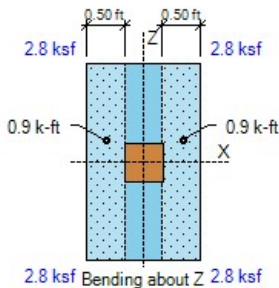

Project:

Page # ____

Engineer:

2/27/2024

Descrip: Typical Interior Footing 6,500# point load

ASDIP Foundation 4.8.2.7

SPREAD FOOTING DESIGN

www.asdipsoft.com

LOAD TRANSFER CALCULATIONS (Comb: 1.2D+1.6L+0.5Lr)

$$\text{Area } A1 = \text{col } L * \text{col } W = 6.0 * 6.0 = 36.0 \text{ in}^2$$

$$Sx = \text{col } W * \text{col } L^2 / 6 = 6.0 * 6.0^2 / 6 = 36.0 \text{ in}^3$$

$$Sz = \text{col } L * \text{col } W^2 / 6 = 6.0 * 6.0^2 / 6 = 36.0 \text{ in}^3$$

$$\text{Bearing } Pbu = P / A1 + Mz / Sx + Mx / Sz = 10.8 / 36.0 + 0.0 * 12 / 36.0 + 0.0 * 12 / 36.0 = 0.3 \text{ ksi}$$

$$\text{Min edge} = \text{Min} (L / 2 - X\text{-offset} - \text{col } L / 2, W / 2 - Z\text{-offset} - \text{col } W / 2)$$

$$\text{Min edge} = \text{Min} (1.50 * 12 / 2 - 0.0 - 6.0 / 2, 2.60 * 12 / 2 - 0.0 - 6.0 / 2) = 6.0 \text{ in}$$

$$\text{Area } A2 = \text{Min} [L * W, (\text{col } L + 2 * \text{Min edge}) * (\text{col } W + 2 * \text{Min edge})]$$

ACI R22.8.3.2

$$A2 = \text{Min} [1.50 * 12 * 2.6 * 12, (6.0 + 2 * 6.0) * (6.0 + 2 * 6.0)] = 324.0 \text{ in}^2$$

$$\text{Footing } \phi Pnc = \phi * 0.85 * fc * \text{Min} [2, \sqrt{(A2 / A1)}] = 0.65 * 0.85 * 2.5 * \text{Min} [2, \sqrt{(324.0 / 36.0)}] = 2.8 \text{ ksi}$$

$$\text{Footing } \phi Pns = \phi * As * Fy / A1 = 0.0 \text{ ksi}$$

ACI 22.8.3.2

$$\text{Footing bearing } \phi Pn = \phi Pnc + \phi Pns = 2.8 + 0.0 = 2.8 \text{ ksi} > 0.3 \text{ psi OK}$$

ASDIP Foundation 4.8.2.7 SPREAD FOOTING DESIGN www.asdipsoft.com

Hooked $L_{dh} = \text{Max}(8 db, 6, 0.02 * f_y / (f_c)^{1/2} * \text{Confining} * \text{Location} * \text{Concrete} * db * \text{ratio})$ ACI 25.4.3
 $L_{dh} = \text{Max}(8 db, 6, 0.02 * 60.0 * 1000 / (2500)^{1/2} * 1.0 * 0.7 * 0.0 * 0.75 * 0.05) = 6.0 \text{ in}$
 Ld provided = Dowel length = $3.00 * 12 = 36.0 \text{ in} > 12.0 \text{ in OK}$
 Ldh provided = Footing thickness - Cover = $8.00 - 3.0 = 5.0 \text{ in} < 6.0 \text{ in NG}$

PUNCHING SHEAR CALCULATIONS (Comb: 1.2D+1.6L+0.5Lr)

X-Edge = $\text{Length} / 2 - \text{Offset} - \text{Col} / 2 = 1.50 * 12 / 2 - 0.0 - 6.0 / 2 = 6.0 \text{ in}$ asx = 10
 Z-Edge = $\text{Width} / 2 - \text{Offset} - \text{Col} / 2 = 2.60 * 12 / 2 - 0.0 - 6.0 / 2 = 12.6 \text{ in}$ asz = 10
 as = asx + asz = 10 + 10 = 20 Col type = Corner $\beta = L / W = 6.0 / 6.0 = 1.00$ ACI 22.6.5.2

Perimeter $b_o = asz / 10 * (L + d / 2 + X\text{-Edge}) + asx / 10 * (W + d / 2 + Z\text{-Edge})$ ACI 22.6.4.2
 $b_o = 10 / 10 * (6.0 + 8.0 / 2 + 6.0) + 10 / 10 * (6.0 + 8.0 / 2 + 12.6) = 38.6 \text{ in}$
 Area $A_{bo} = (L + d / 2 + X\text{-Edge}) * (W + d / 2 + Z\text{-Edge}) = (6.0 + 8.0 / 2 + 6.0) * (6.0 + 8.0 / 2 + 12.6) = 361.6 \text{ in}^2$

Use Plain Concrete Shear Strength
 $\phi V_c = \phi * \text{Min}(1 + 2 / \beta, 2) * 4/3 * \sqrt{f_c}$ ACI 14.5.5.1
 $\phi V_c = 0.60 * \text{Min}(1 + 2 / 1.00, 2) * 4/3 * \sqrt{2500} = 80.0 \text{ psi}$

Punching force $F = P + \text{Overburden} * A_{bo} - \text{Bearing}$
 $F = 10.8 + 0.07 * 361.6 / 144 - 3.9 = 7.1 \text{ kip}$
 $b_1 = L + d / 2 + X\text{-Edge} = 6.0 + 8.0 / 2 + 6.0 = 16.0 \text{ in}$ $b_2 = W + d / 2 + Z\text{-Edge} = 6.0 + 8.0 / 2 + 12.6 = 22.6 \text{ in}$

$\gamma_{vx} \text{ factor} = 1 - \frac{1}{1 + (2/3) \sqrt{b_2 / b_1}} = 1 - \frac{1}{1 + (2/3) \sqrt{22.6 / 16.0}} = 0.44$ ACI Eq. (8.4.4.2.2)

$\gamma_{vz} \text{ factor} = 1 - \frac{1}{1 + (2/3) \sqrt{b_1 / b_2}} = 1 - \frac{1}{1 + (2/3) \sqrt{16.0 / 22.6}} = 0.36$ ACI Eq. (8.4.2.3.2)

$X_{2z} = b_1^2 / 2 / (b_1 + b_2) = 16.0^2 / 2 / (16.0 + 22.6) = 3.3 \text{ in}$ $X_{2x} = b_2^2 / 2 / (b_2 + b_1) = 6.6 \text{ in}$

$J_{cz} = b_1 * d^3 / 12 + b_1^3 * d / 12 + b_1 * d * (b_1 / 2 - X_{2z})^2 + b_2 * d * X_{2z}^2$ ACI R8.4.4.2.3

$J_{cz} = 16.0 * 8.0^3 / 12 + 16.0^3 * 8.0 / 12 + 16.0 * 8.0 * (16.0 / 2 - 3.3)^2 + 22.6 * 8.0 * 3.3^2 = 8210 \text{ in}^4$

$J_{cx} = b_2 * d^3 / 12 + b_2^3 * d / 12 + b_2 * d * (b_2 / 2 - X_{2x})^2 + b_1 * d * X_{2x}^2$ ACI R8.4.4.2.3

$J_{cx} = 22.6 * 8.0^3 / 12 + 22.6^3 * 8.0 / 12 + 22.6 * 8.0 * (22.6 / 2 - 6.6)^2 + 16.0 * 8.0 * 6.6^2 = 18229 \text{ in}^4$

Stress due to P = $F / (b_o * d) * 1000 = 7.1 / (38.6 * 8.0) * 1000 = 23.0 \text{ psi}$

Stress due to Mx = $\gamma_{vx} * X\text{-OTM} * X_{2x} / J_{cx} = 0.44 * 0.0 * 12 * 6.6 / 18229 * 1000 = 0.0 \text{ psi}$

Stress due to Mz = $\gamma_{vz} * Z\text{-OTM} * X_{2z} / J_{cz} = 0.44 * 0.0 * 12 * 3.3 / 8210 * 1000 = 0.0 \text{ psi}$

Punching stress = P-stress + Mx-stress + Mz-stress = 23.0 + 0.0 + 0.0 = 23.0 psi < 80.0 psi OK

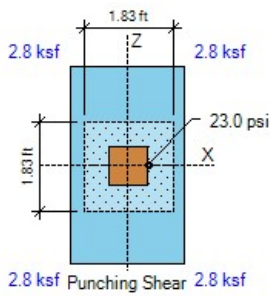

DESIGN CODES

Concrete Design ACI 318-14
Load Combinations ASCE 7-10/16

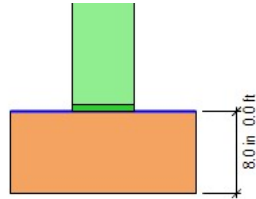

ELEVATION

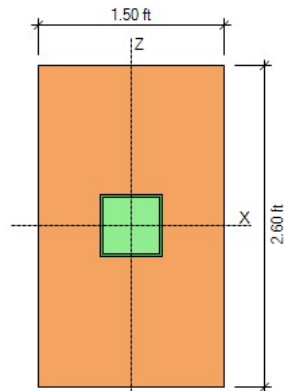

PLAN

WIND $V_{ASD} = 85 \text{ mph}$ $V_{ULF} = 110 \text{ mph}$ Exp. B $K_{zt} = 1.0$ $SLOPE = 0.340$
 $h = 36'$ $\lambda = 1.06$

ZONE A = $12.9 \text{ psf} \times 1.06 = 13.7 \text{ psf}$ 16.0 psf MIN

ZONE B = $8.8 \text{ psf} \times 1.06 = 9.3 \text{ psf}$

ZONE C = $10.2 \text{ psf} \times 1.06 = 10.8 \text{ psf}$ 16.0 psf MIN

ZONE D = $7.0 \text{ psf} \times 1.06 = 7.4 \text{ psf}$ 8.0 psf MIN

SEISMIC $S_{DS} = 0.831$ $R = 6.5$ $C = 1.0$

$C_s = (0.831 / (6.5 / 1.0))^{1/4} = 0.091$

$W_{ROOF} = (35 \text{ psf} \times 8467 \text{ SF}) = 296,345 \#$	$h_1 = 9'$	$h_2 = 29'$
$W_{LEVEL3} = (40 \text{ psf} \times 7465 \text{ SF}) = 298,600 \#$	$h_1 = 9'$	$h_3 = 20'$
$W_{LEVEL2} = (40 \text{ psf} \times 7742 \text{ SF}) = 309,680 \#$	$h_1 = 9'$	$h_2 = 10'$
$W_{TOTAL} = 904,625 \#$		

$U_S = 904,625 \# \times 0.091 = 82,321 \#$ 17,662,805

$F_{ROOF} = \left[\frac{(296,345 \# \times 29')}{(296,345 \# \times 29') + (298,600 \# \times 20') + (309,680 \# \times 10')} \right] \times 82,321 \# = 40,054 \#$

$F_{LEVEL3} = \left[\frac{(298,600 \# \times 20')}{(296,345 \# \times 29') + (298,600 \# \times 20') + (309,680 \# \times 10')} \right] \times 82,321 \# = 27,934 \#$

$F_{LEVEL2} = \left[\frac{(309,680 \# \times 10')}{(296,345 \# \times 29') + (298,600 \# \times 20') + (309,680 \# \times 10')} \right] \times 82,321 \# = 14,433 \#$

GR. 10 12/13

$$F_{3W} = (16.0 \text{ psf} \times 153 \text{ SF}) + (9.3 \text{ psf} \times 84 \text{ SF}) + (8.0 \text{ psf} \times 34 \text{ SF}) = 3,501 \#$$

$$F_{3E} = 40,054 \# \times (1180 \text{ SF} / 8,467 \text{ SF}) = 5,582 \#$$

$$F_{2W} = 3,501 \# + (16.0 \text{ psf} \times 172 \text{ SF}) = 6,253 \#$$

$$F_{2E} = 5,582 \# + 27,834 \# \times (1053 \text{ SF} / 7,465 \text{ SF}) = 9,508 \#$$

$$F_{1W} = 6,253 \# + (16.0 \text{ psf} \times 172 \text{ SF}) = 9,005 \#$$

$$F_{1E} = 9,508 \# + 14,433 \# \times (1053 \text{ SF} / 7,742 \text{ SF}) = 11,471 \#$$

GR. 10 4/5 & 9/10

$$F_{3W} = (16.0 \text{ psf} \times 297 \text{ SF}) = 4,752 \#$$

$$F_{3E} = 40,054 \# \times (2057 \text{ SF} / 8,467 \text{ SF}) = 9,731 \#$$

$$F_{2W} = 4,752 \# + (16.0 \text{ psf} \times 327 \text{ SF}) = 9,984 \#$$

$$F_{2E} = 9,731 \# + 27,834 \# \times (1,732 \text{ SF} / 7,465 \text{ SF}) = 16,189 \#$$

$$F_{1W} = 9,984 \# + (16.0 \text{ psf} \times 328 \text{ SF}) = 15,232 \#$$

$$F_{1E} = 16,189 \# + 14,433 \# \times (1871 \text{ SF} / 7,742 \text{ SF}) = 19,877 \#$$

GR. 10 7

$$F_{3W} = (16.0 \text{ psf} \times 339 \text{ SF}) = 5,424 \#$$

$$F_{3E} = 40,054 \# \times (1,193 \text{ SF} / 8,467 \text{ SF}) = 9,428 \#$$

$$F_{2W} = 5,424 \# + (16.0 \text{ psf} \times 300 \text{ SF}) = 10,224 \#$$

$$F_{2E} = 9,428 \# + 27,834 \# \times (1,895 \text{ SF} / 7,465 \text{ SF}) = 16,494 \#$$

$$F_{1W} = 10,224 \# + (16.0 \text{ psf} \times 301 \text{ SF}) = 15,040 \#$$

$$F_{1E} = 16,494 \# + 14,433 \# \times (1,894 \text{ SF} / 7,742 \text{ SF}) = 20,025 \#$$

GRID A-B

$$F_{3W} = (16.0 \text{ psf} \times 122 \text{ sf}) + (9.3 \text{ psf} \times 106 \text{ sf}) + (8.0 \text{ psf} \times 33 \text{ sf}) = 3,202 \#$$

$$F_{3E} = 40,054 \# \times (2,051 \text{ sf} / 8,467 \text{ sf}) = 9,702 \#$$

$$F_{2W} = 3,202 \# + (16.0 \text{ psf} \times 155 \text{ sf}) = 5,682 \#$$

$$F_{2E} = 9,702 \# + 27,834 \# \times (1,825 \text{ sf} / 7,465 \text{ sf}) = 16,507 \#$$

$$F_{1W} = 5,682 \# + (16.0 \text{ psf} \times 156 \text{ sf}) = 8,178 \#$$

$$F_{1E} = 16,507 \# + 14,433 \# \times (1,824 \text{ sf} / 7,742 \text{ sf}) = 19,908 \#$$

GRID C

$$F_{3W} = (16.0 \text{ psf} \times 270 \text{ sf}) + (8.0 \text{ psf} \times 42 \text{ sf}) = 4,656 \#$$

$$F_{3E} = 40,054 \# \times (4,022 \text{ sf} / 8,467 \text{ sf}) = 19,026 \#$$

$$F_{2W} = 4,656 \# + (16.0 \text{ psf} \times 324 \text{ sf}) = 9,840 \#$$

$$F_{2E} = 19,026 \# + 27,834 \# \times (3,774 \text{ sf} / 7,465 \text{ sf}) = 33,098 \#$$

$$F_{1W} = 9,840 \# + (16.0 \text{ psf} \times 325 \text{ sf}) = 15,040 \#$$

$$F_{1E} = 33,098 \# + 14,433 \# \times (3,973 \text{ sf} / 7,742 \text{ sf}) = 40,505 \#$$

GRIDS G-H

$$F_{3W} = (16.0 \text{ psf} \times 242 \text{ sf}) + (9.3 \text{ psf} \times 32 \text{ sf}) = 4,170 \#$$

$$F_{3E} = 40,054 \# \times (2,139 \text{ sf} / 8,467 \text{ sf}) = 11,325 \#$$

$$F_{2W} = 4,170 \# + (16.0 \text{ psf} \times 194 \text{ sf}) = 7,274 \#$$

$$F_{2E} = 11,325 \# + 27,834 \# \times (1,866 \text{ sf} / 7,465 \text{ sf}) = 18,283 \#$$

$$F_{1W} = 7,274 \# + (16.0 \text{ psf} \times 196 \text{ sf}) = 10,410 \#$$

$$F_{1E} = 18,283 \# + 14,433 \# \times (1,945 \text{ sf} / 7,742 \text{ sf}) = 21,909 \#$$

GRID 1813 (LEVEL 3) FE = 5,582# 7 SEGMENTS L = 6'-0" h = 9'
 VE = 5,582# / 34.16' = 163 PIF
 USE  VE ALLOW = 2420 PIF x (1.25 - 0.125 x 9' / 2.93') = 206 PIF
HOLD DOWNS
 TE = 163 PIF x 9' x 1.25 - 1/2 (250 PIF x 1' x 1.42') - 1/2 (1200 PIF x 4.5' x 1.42') = 1,778#

- L = 6'-0"
- L = 6'-0"
- L = 7'-5"
- L = 4'-3"
- L = 4'-10"
- L = 2'-10"
- L = 2'-10"
- L = 3'-2"

USE MST37 w/ 2 STUDS TE ALLOW = 2,140# x 1.4 / 1.6 = 1,874#

GRID 1813 (LEVEL 2) FE = 9,508# 7 SEGMENTS L = 34'-2" h = 9'
 VE = 9,508# / 34.16' = 278 PIF
 USE  VE ALLOW = 3530 PIF x (1.25 - 0.125 x 9' / 2.93') = 301 PIF
HOLD DOWNS

TE = 278 PIF x 9' x 1.25 + 1,778# - 1/2 (300 PIF x 7' x 1.42') - 1/2 (1200 PIF x 9' x 1.42') = 4,680#

USE MST60 w/ 2 STUDS TE ALLOW = 5,405# x 1.4 / 1.6 = 4,729#

GRID 1813 (LEVEL 1) FE = 11,471# 7 SEGMENTS L = 34'-2" h = 9'
 VE = 11,471# / 34.16' = 336 PIF
 USE  VE ALLOW = 4560 PIF x (1.25 - 0.125 x 9' / 2.93') = 388 PIF
HOLD DOWNS

TE = 336 PIF x 9' x 1.25 + 4,680# - 1/2 (300 PIF x 7' x 1.42') - 1/2 (1200 PIF x 9' x 1.42') = 8,234#

USE HDU14-SDS2.5 w/ 4 STUDS TE ALLOW = 12,425# x 1.4 / 1.6 = 10,872#

GRID 4/5 & 9/10 (LEVEL 3) FE = 9,731# 2 SEGMENTS L=29'-4" h=9'

VE = 9,731# / 58.67' = 166 PIF

L=29'-4"
L=58'-8"

USE  VE ALLOW = 242 PIF

HOLD DOWNS

TE = 166 PIF x 9' x 1.25 - 1/2 (65 PIF x 2' x 14.67') - 1/2 (12 PIF x 2.5' x 14.67') = 1,103#

USE M15T37W12STUOS TE ALLOW = 2,140# x 1.4/1.6 = 1,874#

GRID 4/5 & 9/10 (LEVEL 2) FE = 16,189# 2 SEGMENTS L=58'-8" h=9'

VE = 16,189# / 58.67' = 276 PIF

USE  VE ALLOW = 353 PIF

HOLD DOWNS

TE = 276 PIF x 9' x 1.25 + 1,103# - 1/2 (30 PIF x 4' x 14.67') - 1/2 (12 PIF x 9' x 14.67') = 2,535#

USE M15T48W17STUOS TE ALLOW = 3,425# x 1.4/1.6 = 2,997#

GRID 4/5 & 9/10 (LEVEL 1) FE = 19,677# 2 SEGMENTS L=58'-8" h=9'

VE = 19,677# / 58.67' = 335 PIF

USE  VE ALLOW = 353 PIF

HOLD DOWNS

TE = 335 PIF x 9' x 1.25 + 2,535# - 1/2 (30 PIF x 4' x 14.67') - 1/2 (12 PIF x 9' x 14.67') = 4,636#

USE H108-SDS7.5W12STUOS TE ALLOW = 5,820# x 1.4/1.6 = 5,093#

GRID 7 (LEVEL 3) FE = 9,428#

2 SEGMENTS L = 27'-0" h = 9'
L = 28'-1"
LT = 35'-1"

$$VE = 9,428\# / 55.08' = 171\text{PIF}$$

USE  VE ALLOW = 242 PIF

HOLD DOWNS

$$TE = 171\text{PIF} \times 9' \times 1.25 - \frac{1}{2}(25\text{PSF} \times 1' \times 13.5') - \frac{1}{2}(8\text{PSF} \times 4.5' \times 13.5') = 1,514\#$$

USE (2) HDU2-SDS2.5 w/ 2 STUDS TE ALLOW = 2,215# x 1.4/1.6 = 1,938#

GRID 7 (LEVEL 2) FE = 16,494#

2 SEGMENTS L = 27'-0" h = 9'
L = 28'-1"
LT = 35'-1"

$$VE = 16,494\# / 55.08' = 299\text{PIF}$$

USE  VE ALLOW = 353 PIF

HOLD DOWNS

$$TE = 299\text{PIF} \times 9' \times 1.25 + 1,514\# - \frac{1}{2}(30\text{PSF} \times 6.33' \times 13.5') - \frac{1}{2}(8\text{PSF} \times 9' \times 13.5') = 3,115\#$$

USE (2) HDU5-SDS2.5 w/ 2 STUDS TE ALLOW = 4,340# x 1.4/1.6 = 2,997#

GRID 7 (LEVEL 1) FE = 20,025#

2 SEGMENTS L = 27'-0" h = 9'
L = 28'-1"
LT = 35'-1"

$$VE = 20,025\# / 55.08' = 364\text{PIF}$$

USE  VE ALLOW = 456 PIF

HOLD DOWNS

$$TE = 364\text{PIF} \times 9' \times 1.25 + 3,115\# - \frac{1}{2}(30\text{PSF} \times 6.33' \times 13.5') - \frac{1}{2}(8\text{PSF} \times 9' \times 13.5') = 3,437\#$$

USE HDU8-SDS2.5 w/ 3 STUDS TE ALLOW = 6,580# x 1.4/1.6 = 5,758#

2/27/2024

C. P. ERUCCIONI, PE

ETC-BUILDING 6

SHEAR

7

GRID A-B (LEVEL 3) FE = 9,702# 11 SEGMENTS L = 2'-10" L = 4'-9" 17'-9"

VE = 9,702# / 39.08' = 248 PIF

USE W7 VEA_{allow} = 353 PIF x (1.25 - 0.125 x 9 / 2.33) = 301 PIF

HOLD DOWNS

TE = 248 PIF x 9' x 1.25 - 1/2 (25 PIF x 11' x 1.42) - 1/2 (12 PIF x 4.5' x 1.42) = 2,559#

USE CAST 48 w/ 2 STOPS TE_{allow} = 3,425# x 1.4 / 1.6 = 2,997#

GRID A-B (LEVEL 2) FE = 16,507# 11 SEGMENTS L = 39'-1" 17'-9"

VE = 16,507# / 39.08' = 422 PIF

USE W4 VEA_{allow} = 595 PIF x (1.25 - 0.125 x 9 / 2.33) = 507 PIF

HOLD DOWNS

TE = 422 PIF x 9' x 1.25 + 2,559# - 1/2 (30 PIF x 11' x 1.42) - 1/2 (12 PIF x 9' x 1.42) = 7,208#

USE CAST 12 w/ 2 STOPS TE_{allow} = 9,215# x 1.4 / 1.6 = 8,063#

GRID A-B (LEVEL 1) FE = 19,909# 15 SEGMENTS L = 39'-1" 17'-9"

VE = 19,909# / 51.75' = 385 PIF

USE W4 VEA_{allow} = 595 PIF x (1.25 - 0.125 x 9 / 2.33) = 507 PIF

HOLD DOWNS

STACKED TE = 385 PIF x 9' x 1.25 + 7,208# - 1/2 (30 PIF x 11' x 1.42) - 1/2 (12 PIF x 9' x 1.42) = 11,438#

USE HD 014-SDS 2.5 w/ 4 DF & 2 STOPS TE_{allow} = 14,445# x 1.4 / 1.6 = 12,639#

UNSTACKED TE = 385 PIF x 9' x 1.25 - 1/2 (12 PIF x 7.5' x 1.58) - 1/2 (30 PIF x 3' x 1.58) = 4,046#

USE HD 05-SDS 2.5 w/ 2 STOPS TE_{allow} = 4,340#

GRID C (LEVEL 3) FE = 19,026#

4 SEGMENTS L = 18'-7" h = 9'
 L = 15'-10"
 L = 15'-10"
 L = 18'-7"
 63'-10"

$V_E = 19,026\# / 63.93' = 296\text{ PLF}$

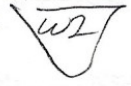
USE  $V_{EALLOW} = 353\text{ PLF}$

HOLD DOWNS

18'-7" TE = 276 PLF x 9' x 1.25 - 1/2 (25 PLF x 19.67' x 9.3') - 1/2 (20 PLF x 4.5' x 9.3') = 767#
 15'-10" TE = 276 PLF x 9' x 1.25 - 1/2 (25 PLF x 28' x 7.92') - 1/2 (12 PLF x 4.5' x 7.92') = 123#

18'-7" USE (2) H002-SDS25 w/ 2 STUDS TEALLOW = 2,215# x 1.4/1.6 = 1,938#
 15'-10" OR MS537 w/ 2 STUDS TEALLOW = 2,140# x 1.4/1.6 = 1,874#

GRID C (LEVEL 2) FE = 33,098#

2 SEGMENTS L = 68'-10" h = 9'

$V_E = 33,098\# / 68.93' = 481\text{ PLF}$

USE  $V_{EALLOW} = 595\text{ PLF}$

HOLD DOWNS

18'-7" TE = 481 PLF x 9' x 1.25 + 767# - 1/2 (8 PLF x 9' x 9.3') = 5,893#
 15'-10" TE = 481 PLF x 9' x 1.25 + 123# - 1/2 (30 PLF x 5' x 7.92') - 1/2 (12 PLF x 4.5' x 7.92') = 4,513#

18'-7" USE (2) H0011-SDS25 w/ 3 STUDS TEALLOW = 8,030# x 1.4/1.6 = 7,026#
 15'-10" OR MS60 w/ 2 STUDS TEALLOW = 5,405# x 1.4/1.6 = 4,729#

GRID C (LEVEL 1) FE = 40,505#

6 SEGMENTS L = 18'-7" h = 9'
 L = 15'-10"
 L = 13'-4"
 L = 13'-4"
 L = 15'-10"
 L = 18'-7"
 4 = 95'-6"

$V_E = 40,505\# / 95.5' = 424\text{ PLF}$

USE  $V_{EALLOW} = 595\text{ PLF}$

HOLD DOWNS

18'-7" TE = 424 PLF x 9' x 1.25 + 5842# - 1/2 (8 PLF x 9' x 9.3') = 10,057#
 15'-10" TE = 424 PLF x 9' x 1.25 + 4,513# - 1/2 (30 PLF x 5' x 7.92') - 1/2 (12 PLF x 4.5' x 7.92') = 8,261#
 13'-4" TE = 424 PLF x 9' x 1.25 + 1/2 (25 PLF x 25.33' x 6.67') - 1/2 (8 PLF x 22.5' x 6.67') = 2,058#

18'-7" USE H0014-SDS25 w/ 4 STUDS TEALLOW = 12,425# x 1.4/1.6 = 10,871#
 15'-10" OR H0011-SDS25 w/ 4 STUDS TEALLOW = 9,610# x 1.4/1.6 = 8,409#
 13'-4" OR H004-SDS25 w/ 2 STUDS TEALLOW = 3,285# x 1.4/1.6 = 2,874#

0.829

GRIDS G-H (LEVEL 3) FE = 11,325# 13 SEGMENTS

- L = 9'-0"
- L = 3'-4"
- L = 4'-5"
- L = 4'-5"
- L = 2'-8"
- L = 2'-0"
- L = 7'-8"
- LT = 50'-8"

5.99'

VE = 11,325# / 50.67' = 224 plf

USE W2 V_{ALLOW} = 353 plf x (1.25 - 0.125 x 9 / 2.67) = 293 plf

HOLD DOWNS

TE = 224 plf x 9' x 1.25 - 1/2 (293 plf x 20.58' x 1.33') = 2,142#

USE A5T48 w/ 2 STUDS T_{ALLOW} = 3,425# x 1.4 / 1.6 = 2,997#

GRIDS G-H (LEVEL 2) FE = 18,283# 13 SEGMENTS LT = 50'-8" h = 9'

VE = 18,283# / 50.67' = 361 plf

USE W3 V_{ALLOW} = 456 plf x (1.25 - 0.125 x 9 / 2.67) = 378 plf

HOLD DOWNS

TE = 361 plf x 9' x 1.25 + 2,142# - 1/2 (378 plf x 9' x 1.33') = 6,131#

USE C12T12 w/ 2 STUDS T_{ALLOW} = 9,215# x 1.4 / 1.6 = 8,063#

GRIDS G-H (LEVEL 1) FE = 21,909# 13 SEGMENTS LT = 50'-8" h = 9'

VE = 21,909# / 50.67' = 432 plf

USE W4 V_{ALLOW} = 595 plf x (1.25 - 0.125 x 9 / 2.67) = 493 plf

HOLD DOWNS

TE = 432 plf x 9' x 1.25 + 6,131# - 1/2 (493 plf x 9' x 1.33') = 10,919#

USE HDV14-50S25 w/ 4 DF #2 STUDS T_{ALLOW} = 14,445# x 1.4 / 1.6 = 12,639#