

***C.E.S. NW Inc.***  
*Civil Engineering & Surveying*

STORMWATER SITE PLAN  
FOR  
PUYALLUP DUPLEXES

---

DECEMBER 2023

PREPARED FOR:

HC HOMES, INC.  
P.O. Box 7707  
BONNEY LAKE, WA 98391

---

PREPARED BY:

ERIC OEHLER, PROJECT MANAGER

REVIEWED BY:

FRED BROWN, P.E., SENIOR PROJECT MANAGER

---

C.E.S. NW, INC.  
429 29<sup>TH</sup> STREET NE, SUITE D  
PUYALLUP, WA 98372  
(253) 848-4282

# STORMWATER SITE PLAN

FOR

## Puyallup Duplexes City of Puyallup, Washington

June 2023

Revised October 2023

Revised December 2023

Prepared for:

HC Homes, Inc.  
P.O. Box 7707  
Bonney Lake, WA 98391

Prepared by:

Eric Oehler, Project Manager

Reviewed By:

Fred Brown, P.E., Senior Project Manager

REPORT #20069



This analysis is based on data and records either supplied to, or obtained by, C.E.S. NW, Inc. These documents are referenced within the text of the analysis. The analysis has been prepared utilizing procedures and practices within the standard accepted practices of the industry.



# TABLE OF CONTENTS

	PAGE
<b>STORM DRAINAGE</b> .....	<b>1</b>
1. PROJECT OVERVIEW .....	1
2. EXISTING CONDITIONS SUMMARY .....	3
3. OFF-SITE ANALYSIS REPORT.....	3
4. PERMANENT STORMWATER CONTROL PLAN .....	5
5. DISCUSSION OF MINIMUM REQUIREMENTS .....	9
<i>Appendix A</i> <b>General Exhibits</b>	
Aerial Map .....	A-1
Soil Map .....	A-2
Soil Description .....	A-3
FIRMette Map 53053C0343E.....	A-5
<i>Appendix B</i> <b>Basin Exhibits</b>	
Pre-Developed Wetland Analysis Map.....	B-1
Post-Developed Wetland Analysis Map.....	B-2
Post-Developed Infiltration Basin Map .....	B-3
<i>Appendix C</i> <b>Stormwater Calculations</b>	
WWHM2012 Wetland “A” Hydrology Analysis .....	C-1
WWHM2012 Infiltration Trench Sizing Calculation .....	C-12
WWHM2012 Dispersal Trench Stormwater Flow Calculation.....	C-18
<i>Appendix D</i> <b>Critical Areas Assessment</b>	
Habitat Technologies – Critical Areas Assessment (Parcel 0419095003) .....	D-1
Habitat Technologies – Critical Areas Assessment (Parcel 0419095022) .....	D-50
<i>Appendix E</i> <b>Geotechnical Reports</b>	
Innovative GEO-Services, LLC – Artz Site and Soil Evaluation.....	E-1
Earth Solutions NW – Infiltration Eval. and Seasonal Groundwater. Monitoring ..	E-8

# STORM DRAINAGE

## 1. Project Overview

This report accompanies the Short Plat Amendment, Boundary Line Adjustment, Civil Construction Plans (Frontage Plans OS1-OS2) and building site plan submittals prepared for the Puyallup Duplex Lot 1 and Lot 2 project which are submitted to the City of Puyallup for review and approval. This document provides site information, and the analysis used to prepare the storm drainage design for each proposed duplex. The *Washington State Department of Ecology 2019 Stormwater Management Manual for Western Washington, (SWMMWW)*, and the City of Puyallup's modifications to that document establishes the methodology and design criteria used for this project.

The proposed Puyallup Duplexes project is comprised of 3 vacant parcels (0419095003, 0419095004, and 0419095022) totaling approximately 5.02 acres. Along with building site plan submittals for each duplex, there are 2 other land use actions proposed for the project. A Short Plat Amendment will be completed to create 2 newly configured lots (Lots 1 and 2) and a Native Growth Protection area tract (Tract A). Once the Short Plat Amendment is completed a Boundary Line Adjustment will be completed affecting newly created Lot 2. The boundary line adjustment will decrease the east side of Lot 2 and expand the western boundary of adjacent Parcel 0419091020 to account for an existing asphalt pavement parking area used by the adjacent apartment building that encroaches into Parcel 0419095022. A frontage improvement plan (OS1-OS2) consisting of a proposed 5' wide asphalt pavement sidewalk on the north side of 43<sup>rd</sup> Ave. SW along with a street light plan will be submitted in conjunction with the above-described land use actions.

The Puyallup Duplexes project proposes 2 residential duplex buildings containing a total of 4 living units. One duplex building will be constructed on each newly configured lot. The site will be accessed from 43<sup>rd</sup> Ave. SW by a new 24' wide asphalt driveway approach. The new asphalt driveway approach will connect to a proposed 24' wide by 40' long shared access driveway constructed onsite centered on the common lot line of proposed Lots 1 and 2. Individual 20' wide driveways will extend in each direction from the shared access to the garages of each duplex. A minimum of 20' wide by 20' deep apron will be constructed in front of each garage providing a minimum of 2 parking spaces per unit. The site will be complete with sidewalks extending from the garage aprons to the front entrance of each unit.

A Vicinity Map has been included in Appendix “A” of this report. A project summary is as follows:

**Permit Applied for** – Building Permits

**Address** – 409 and 433 43<sup>rd</sup> Ave. SW, Puyallup, WA 98373

**Parcel Numbers** – 0419095003, 0419095004, 0419095022

**Legal description** – PER CITY OF PUYALLUP BOUNDARY LINE ADJUSTMENT NO. PLBDJ20220164. PENDING RECORDING.

The project proposes to create approximately 0.266 acres of impervious surface consisting of approximately 0.167 acres of rooftops and 0.099 acres of shared access, driveways, parking spaces, and sidewalks. All disturbed pervious areas that are not converted to impervious surfaces will apply soil amendment per Ecology BMP T5.13.

New water services and meters will be installed for each duplex and unit. Installation will be coordinated with Fruitland Mutual Water Company.

Onsite septic systems for each lot/duplex were originally designed by Peninsula Septic Designs and received health department approval on January 20, 2021 and January 21, 2021, respectively. Approvals subsequently expired and were re-applied for by C.E.S. NW, Inc. and re-approved on June 12, 2023.

A Fee-in-Lieu Program Request was submitted but denied by the city. As a result, the project is required to complete frontage improvements along the north side of 43<sup>rd</sup> Ave. SW consisting of a 5’ wide asphalt pavement sidewalk adjacent to the edge of right of way. The 5’ wide paved sidewalk will connect to the proposed 24’ wide asphalt pavement driveway approach. An interceptor trench will be constructed along the front of Lots 1 and 2 to collect runoff from the proposed sidewalk, small amount of offsite right of way area, and the small amount of onsite landscape area that is contributory to it.

According to Figure I-3.1 of Volume I, Chapter 3 of the SWMMWW, the project must evaluate all minimum requirements. See Section 5 of this report for a detailed discussion of the minimum requirements.

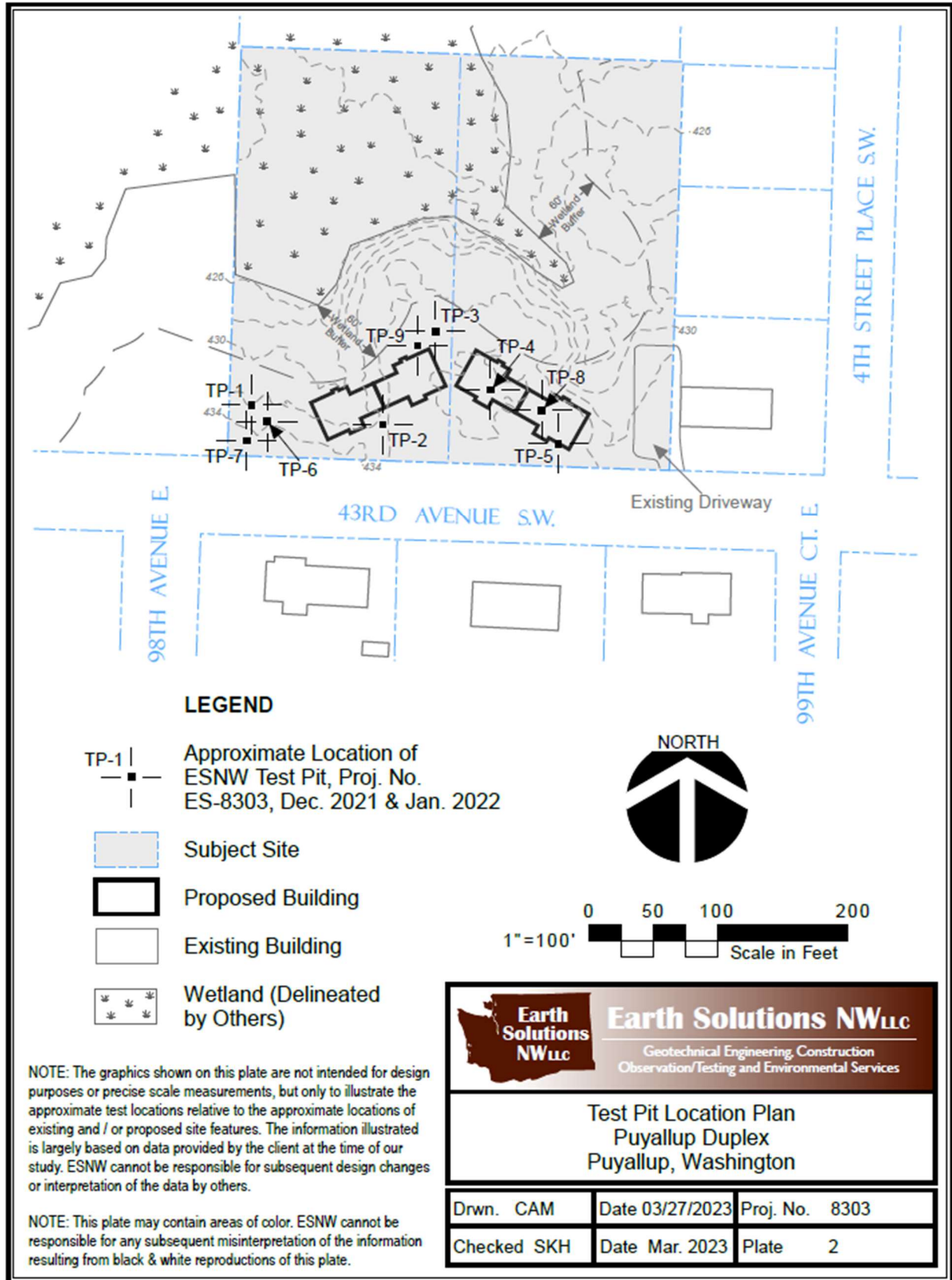
## **2. Existing Conditions Summary**

The project site is rectangular in shape and approximately 5.02 acres in size. The existing topography of the southern portion of the site is generally rolling sloping downward from south to north. The existing wetland area comprising most of the site is generally flat. The existing site elevations range between approximately 418-ft. to 434-ft. Due to existing topography, there is minimal offsite drainage coming onto the site but what does is coming from the north half of 43<sup>rd</sup> Ave. SW and the offsite parking lot east of proposed Lot 2. Most of the site is covered with trees and brush. The site is bordered by 43<sup>rd</sup> Ave. SW to the south, a multi-family and single-family residences to the east, and undeveloped land to the north and west.

A Artz Site and Soil Evaluation was prepared by Innovative GEO-Services, LLC on January 29, 2020. The intent of the evaluation was to present site and soil characteristics with regard to potential critical areas located on site. Per the evaluation, “Site observations, subsurface soil observations and research conducted for the three lots and specifically the two southern parcels found no critical areas as defined by the City of Puyallup ordinance. The Soil Evaluation indicates the Natural Resource Conservation Service (NRCS) identifies the soil on the southern two lots as Everett gravelly sandy loam (13B) and that test pits excavated north and east of the proposed structure as a portion of the wastewater permitting phase confirmed soil typical of Everett gravelly sandy loam. See Geotechnical Reports – Appendix “E” for complete information provided within the Artz Site and Soil Evaluation.

An Infiltration Evaluation and Seasonal Groundwater Monitoring study was prepared by Earth Solutions NW (ESNW) on March 30, 2023. ESNW excavated a total of 9 test pits within the area of proposed Lots 1 and 2. Per ESNW “Fill was encountered at test pit locations TP-2, TP-3, TP-4, TP-5, TP-8, and TP-9 to depths of about six to nine-and-one-half feet below the existing ground surface (bgs). The fill was characterized as silty sand with and without gravel, primarily in a loose to medium dense and damp to moist condition. Small pieces of asphalt, wood, and plastic were observed in the fill. Based on the field investigations, a design infiltration rate of 30 inch/hour is applicable only within the southwest corner of Lot 1 (TP-1, TP-6, and TP-7). Elsewhere on site, infiltration is not feasible from a geotechnical standpoint given the widespread existing fill and the presence of relatively impermeable native soil at depth. The recommended seasonal high groundwater table elevation of 6.7 feet below ground surface was established in the southwest corner of Lot 1 near TP-6. See Geotechnical Reports – Appendix “E” for complete information

provided within the Infiltration Evaluation and Seasonal Groundwater Monitoring study. Plate 2 from the ESNW study has been extracted from the report to illustrate the above description.



A Critical Areas Assessment was prepared by Habitat Technologies for 409 – 43<sup>rd</sup> Ave. SW and 433 – 43<sup>rd</sup> Ave. SW on October 7, 2020 and September 18, 2020, respectively. The Critical Areas Assessment identified the project contains an existing onsite wetland (Wetland A). Wetland A has been identified as a Category III wetland requiring a standard 60-ft. wetland buffer by the City of Puyallup. See Critical Areas Assessment – Appendix “D” for complete information provided within the assessment.

There are no known septic systems or fuel tanks in use or abandoned on the project site. If either are found during site construction, they will be removed or abandoned per all appropriate city and health department standards.

Federal Emergency Management Agency (FEMA) has prepared flood insurance maps identifying floodplains within the City of Puyallup. Based on FIRM map 53053C0343E), The parcel and all the proposed improvements are located within Zone X, which is the area determined to be outside the 500-year flood and protected by levee from the 100-year flood. A copy of the FIRM Panel 53053C0343E can be found in Appendix “A” of this report.

### **3. Off-site Analysis Report**

As previously indicated, from site reconnaissance and existing topography, there is minimal offsite drainage coming onto the site. But what does is coming from the north half of 43<sup>rd</sup> Ave. SW and the offsite parking lot east of proposed Lot 2. A quarter mile downstream analysis is required by the City of Puyallup. Due to the infiltration characteristics of the onsite soils (Everett gravelly sandy loam), all the stormwater from the site will be fully infiltrated to the groundwater or evaporated within the wetland, where the ¼ miles downstream limit ends.

### **4. Permanent Stormwater Control Plan**

#### ***Existing Site Hydrology***

The existing topography of the southern portion of the site is generally rolling sloping downward from south to north. The existing wetland area comprising most of the site is generally flat. The existing site elevations range between approximately 418-ft. to 434-ft. Due to existing topography, there is minimal offsite drainage coming onto the site but what does is coming from the north half of 43<sup>rd</sup> Ave. SW and the offsite parking lot east of proposed Lot 2. The Soil Evaluation indicates the Natural Resource Conservation Service (NRCS) identifies the soil on the southern two lots as

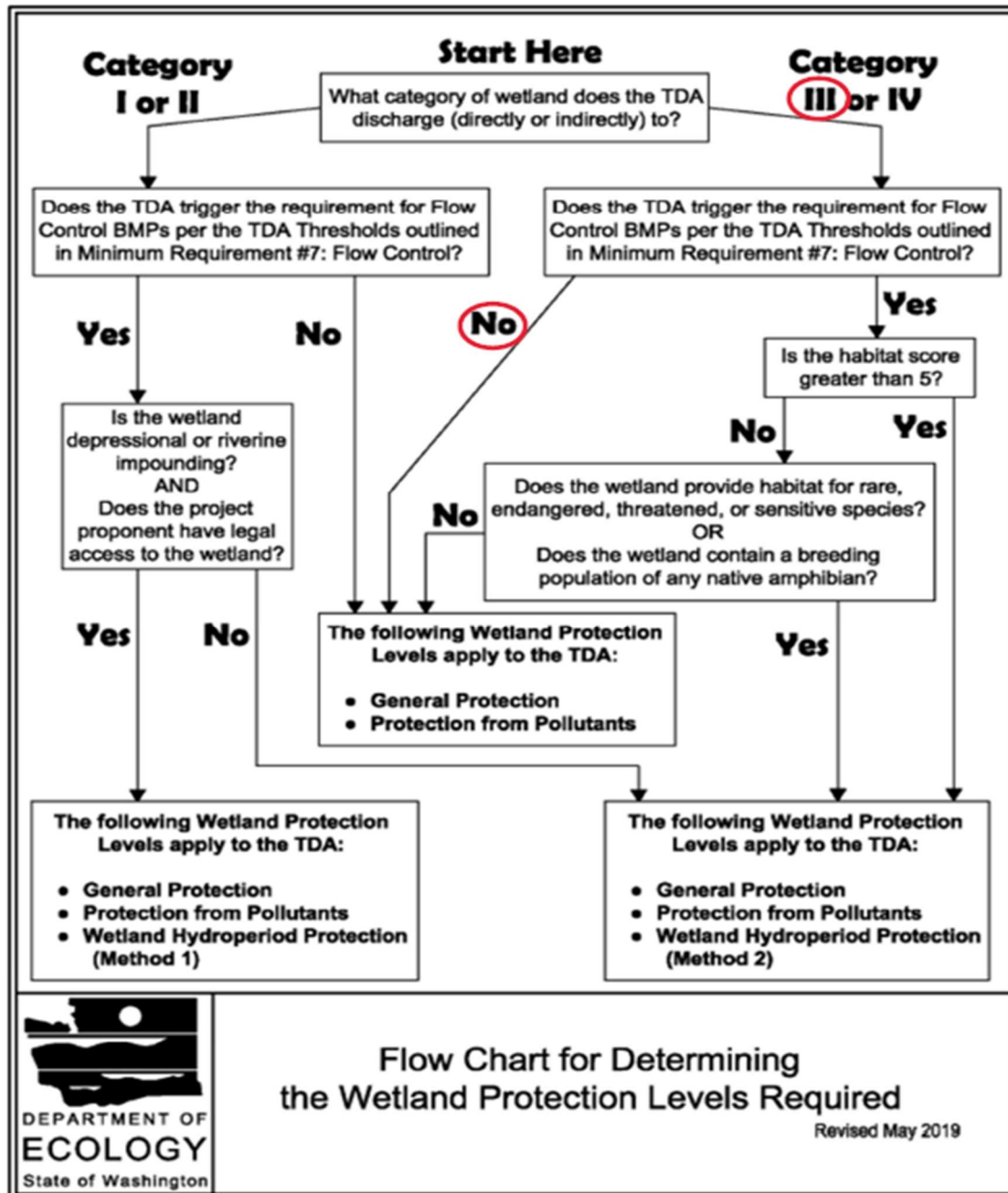
Everett gravelly sandy loam (13B) and that test pits excavated north and east of the proposed structure as a portion of the wastewater permitting phase confirmed soil typical of Everett gravelly sandy loam. Most of the project site appears to be well drained and does not exhibit field indicators associated with the movement of seasonal stormwater runoff.

### ***Developed Site Hydrology***

As previously mentioned, the site consists of an existing onsite wetland (Wetland A) as identified in the Critical Areas Assessment prepared by Habitat Technologies. Per the requirements of the 2019 SWMMWW the project is required to satisfy Minimum Requirement #8, Wetlands Protection. **Figure I-3.5: Flow Chart for Determining Wetland Protection Level Requirements** within the 2019 SWMMWW provides the guideline for determining the level of wetland protection. Since this project creates less than 10,000 square feet of effective impervious surface within the threshold discharge area the project is only required to provide General Protection and Protection from Pollutants for Wetland A as illustrated by the filled-out Figure I-3.5. Although Wetland Hydroperiod Protection (Method 2) is not technically required due to the amount of effective impervious surface created by the project a wetland hydrology analysis was still completed for the project following Appendix I-C.4: Wetland Hydroperiod Protection within the 2019 SWMMWW which establishes the design criteria for wetlands protection. Specifically, Method 2: Site Discharge Modeling provides two criteria, Criteria 1 and Criteria 2, for maintaining stormwater volumes to existing wetlands. When modeling the differences in stormwater volume to a wetland under existing and developed scenarios, the manual instructs the designer to analyze the effects of surface, interflow, and groundwater. In addition, the existing land use coverages were used for modeling purposes. Utilizing WWHM2012, a hydrology analysis was completed for Wetland A to show compliance with Criteria 1 and Criteria 2. To achieve compliance in the field, developed stormwater runoff from one of the duplexes roof surfaces (Lot 2) and most of the landscaped areas were directed to the existing wetland in addition to existing offsite stormwater runoff using a combination of interceptor trenches, stormwater dispersal trench, riprap outfall, and finish grading. The result is compliance of all months and days meeting their respective exceedance requirements. See Basin Exhibits – Appendix “B” and Wetland A Hydrology Analysis – Appendix “C” for detailed stormwater information. The stormwater dispersal trench and riprap outfall both have a minimum 25’ vegetated flow path meeting the requirements of basic dispersion. Both the stormwater dispersal trench and riprap outfall are located outside of the required 60’ wetland buffer. General Protection of the wetland will be achieved by staking clearing limits

outside of the required 60' wetland buffer, installing temporary silt fence protecting the wetland during construction, and by installing permanent buffer signs staked every 50' around the perimeter of the wetland buffer. Protection from Pollutants will be achieved by directing stormwater runoff from pollution generating impervious surfaces away from the wetland other than those surfaces that currently drain to the wetland under existing conditions.

**Figure I-3.5: Flow Chart for Determining Wetland Protection Level Requirements**





Developed stormwater runoff from the remaining roof surface (Lot 1) and shared access driveway, driveways, parking spaces, sidewalks, and landscape will be directed to a proposed infiltration trench located in the southwest corner of Lot 1. In addition to the onsite area the infiltration trench is sized to infiltrate offsite stormwater runoff from the proposed asphalt driveway approach and the north half of 43<sup>rd</sup> Ave. SW that flows onto the driveway approach. The infiltration trench was sized utilizing WWHM2012 and a design infiltration rate of 30 inches per hour provided by ESNW. Per WWHM modeling program a 21' long x 10' wide x 3' deep infiltration trench is required to infiltrate developed and existing stormwater runoff from the previously mentioned areas. The bottom of the 3' deep infiltration trench is set at an elevation of 429.00. The recommended seasonal high groundwater table elevation of 6.7 below ground surface sets the seasonal groundwater elevation at 427.30 or 1.7' below the bottom of the proposed infiltration trench. See Basin Exhibits – Appendix “B” and Stormwater Calculations – Appendix “C” for detailed stormwater information.

A dispersal trench stormwater flow calculation has been provided in Appendix “C” supporting the design length of the proposed trench. Trench length has been adjusted to sufficiently convey 0.1 cfs per 10' of trench length which is the ratio derived from a 50' trench length being able to convey a maximum 0.5 cfs.

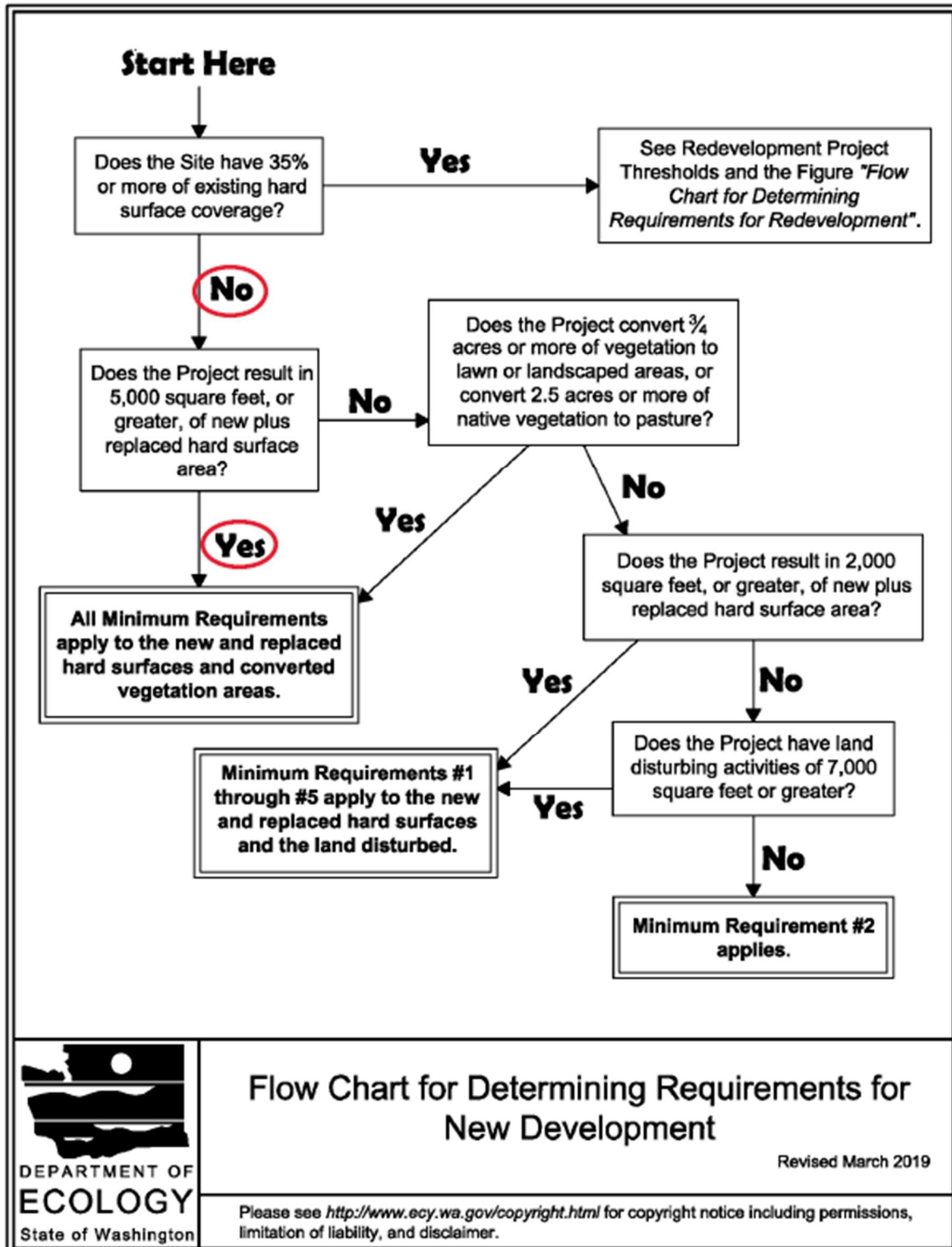
### ***Water Quality System***

Water quality treatment mitigation is not required as the project proposes to create less than 5,000 square feet of pollution-generating hard surface (4,581 sf) and does not create 3/4 of an acre or more of pollution-generating pervious surfaces.

## 5. Discussion of Minimum Requirements

The following is a summary of the Minimum Requirements as described in Volume 1, Chapter 3 of the SWMMWW. Minimum requirements #1 through #9 must be met according to Figure I-3.1.

**Figure I-3.1: Flow Chart for Determining Requirements for New Development**



### 5.1 Minimum Requirement #1: Preparation of Stormwater Site Plans

Minimum Requirement #1 is satisfied by the completion of this Stormwater Site Plan as submitted for approval of the Short Plat Amendment and building permits for each proposed duplex.

### 5.2 Minimum Requirement #2: Construction Stormwater Pollution Prevention (SWPPP)

Minimum Requirement #2 will be satisfied by the separately completed and approved Construction Stormwater Pollution Prevention Plan (SWPPP) addressing all thirteen (13) elements and will be provided during building site plan submittal.

### 5.3 Minimum Requirement #3: Source Control of Pollution

Minimum Requirement #3 will be satisfied by the separately prepared SWPPP report and the separately prepared Pollution Source Control Manual for Homeowners which is included as part of the Stormwater Site Plan as Attachment “B” and will be provided during building site plan submittal.

### 5.4 Minimum Requirement #4: Preservation of Natural Drainage Systems and Outfalls

Minimum Requirement #4 is satisfied by maintaining to the maximum extent practical, the natural drainage patterns and the natural discharge locations by proposing to discharge developed stormwater runoff to the groundwater through an infiltration trench and to the existing wetland through the use of a stormwater dispersal trench and riprap outfall which is the historic discharge location of the site.

### 5.5 Minimum Requirement #5: Onsite Stormwater Management

The City of Puyallup requires projects to implement onsite stormwater management BMPs when feasible. This project must meet minimum requirements #1 to #9. Therefore, this project will evaluate List 2 of the SWMMWW for onsite stormwater management compliance. These BMPs were evaluated and discussed as follows:

#### Lawn and Landscape Areas

##### Soil Preservation and Amendment (Ecology BMP T5.13)

All disturbed pervious areas that are not converted to impervious surfaces will apply soil amendment per Ecology BMP T5.13.

## Roof Areas

- Full dispersion is deemed feasible since the developed site maintains 65% of forested or native condition. However, full dispersion is not feasible as 100-foot flow paths are not available.
- Downspout full infiltration is deemed feasible within Lot 1 and will be utilized for the roof surface area of the duplex on this lot. Soils within Lot 2 are not suitable for infiltration and therefore downspout full infiltration is deemed infeasible for this lot. However, the roof surface area for the duplex on Lot 2 is directed to a downspout dispersion trench used to maintain hydroperiod utilizing BMP T5.12.
- Other BMPs are not necessary since downspout full infiltration has been proposed above and has higher priority.

## Other Hard Surface

- Full dispersion of BMP T5.30 was deemed feasible since the developed site maintains 65% of forested or native condition. However, full dispersion is not feasible as 100-foot flow paths are not available.
- Permeable Pavement BMP T5.15 is deemed infeasible and not proposed for the shared access and individual driveways as the soil conditions in this area do not support infiltration systems according to the Infiltration Evaluation and Seasonal Groundwater Monitoring report prepared by ESNW and as described in detail in the Existing Conditions Summary.
- Bioretention BMP T7.30 not evaluated for feasibility as Sheet Flow Dispersion BMP T5.12 used instead.
- Sheet Flow Dispersion BMP T5.12 will be utilized on the roof surface area for the duplex on Lot 2. The proposed dispersion trench provides a minimum 60' vegetated flowpath to the existing onsite wetland meeting the minimum requirement of a 25'-50' vegetated flowpath.
- Concentrated Flow Dispersion BMP T5.11 not evaluated for feasibility as Sheet Flow Dispersion BMP T5.12 used instead.

### 5.6 Minimum Requirement #6: Runoff Treatment

Minimum Requirement #6 is not required as the project proposes to create less than 5,000 square feet of pollution-generating hard surface (4,581 sf) and does not create 3/4 of an acre or more of pollution-generating pervious surfaces.

## 5.7 Minimum Requirement #7: Flow Control

Minimum Requirement #7 is not required as the project proposes to create less than 10,000 square feet of effective impervious surface. The project will create approximately 13,461 square of onsite and offsite impervious surfaces through the construction of the proposed duplexes, shared driveway access, driveways, and onsite and offsite sidewalks. However, the infiltration trench constructed in the southwest corner of Lot 1 has been designed to infiltrate the stormwater runoff from the roof surface of Lot 1, the shared driveway access, driveways, and a portion of sidewalks located within the contributing basin. The proposed impervious surface area that will be infiltrated totals approximately 8,195 square feet rendering this area as ineffective impervious surface. Therefore, the amount of effective impervious surface area within the threshold discharge area totals 5,266 square feet which is below the threshold for requiring compliance with Minimum Requirement #7. Design of the infiltration trench to mitigate the stormwater runoff from the areas described above was determined utilizing WWHM2012.

## 5.8 Minimum Requirement #8: Wetlands Protection

Minimum Requirement #8 is required due to the project containing an existing onsite wetland (Wetland A) as identified in the Critical Areas Assessment prepared by Habitat Technologies. Wetland A has been identified as a Category III wetland requiring a standard 60-ft. wetland buffer by the City of Puyallup. **Figure I-3.5: Flow Chart for Determining Wetland Protection Level Requirements** within the 2019 SWMMWW provides the guideline for determining the level of wetland protection. Since this project creates less than 10,000 square feet of effective impervious surface within the threshold discharge area the project is only required to provide General Protection and Protection from Pollutants for Wetland A as illustrated by the filled-out Figure I-3.5. Although Wetland Hydroperiod Protection (Method 2) is not technically required due to the amount of effective impervious surface created by the project a wetland hydrology analysis was still completed for the project following Appendix I-C.4: Wetland Hydroperiod Protection within the 2019 SWMMWW which establishes the design criteria for wetlands protection. Specifically, Method 2: Site Discharge Modeling provides two criteria, Criteria 1 and Criteria 2, for maintaining stormwater volumes to existing wetlands. When modeling the differences in stormwater volume to a wetland under existing and developed scenarios, the manual instructs the designer to analyze the effects of surface, interflow, and groundwater. In addition, the existing land use coverages were used for modeling purposes. Utilizing WWHM2012, a hydrology analysis was completed for Wetland A to show compliance with Criteria 1 and Criteria 2. To achieve compliance in the

field, developed stormwater runoff from one of the duplexes roof surfaces (Lot 2) and most of the landscaped areas were directed to the existing wetland in addition to existing offsite stormwater runoff using a combination of interceptor trenches, stormwater dispersal trench, riprap outfall, and finish grading. The result is compliance of all months and days meeting their respective exceedance requirements. See Basin Exhibits – Appendix “B” and Wetland A Hydrology Analysis – Appendix “C” for detailed stormwater information. The stormwater dispersal trench and riprap outfall both have a minimum 25’ vegetated flow path meeting the requirements of basic dispersion. Both the stormwater dispersal trench and riprap outfall are located outside of the required 60’ wetland buffer. General Protection of the wetland will be achieved by staking clearing limits outside of the required 60’ wetland buffer, installing temporary silt fence protecting the wetland during construction, and by installing permanent buffer signs staked every 50’ around the perimeter of the wetland buffer. Protection from Pollutants will be achieved by directing stormwater runoff from pollution generating impervious surfaces away from the wetland other than those surfaces that currently drain to the wetland under existing conditions.

#### 5.9 Minimum Requirement #9: Operation and Maintenance

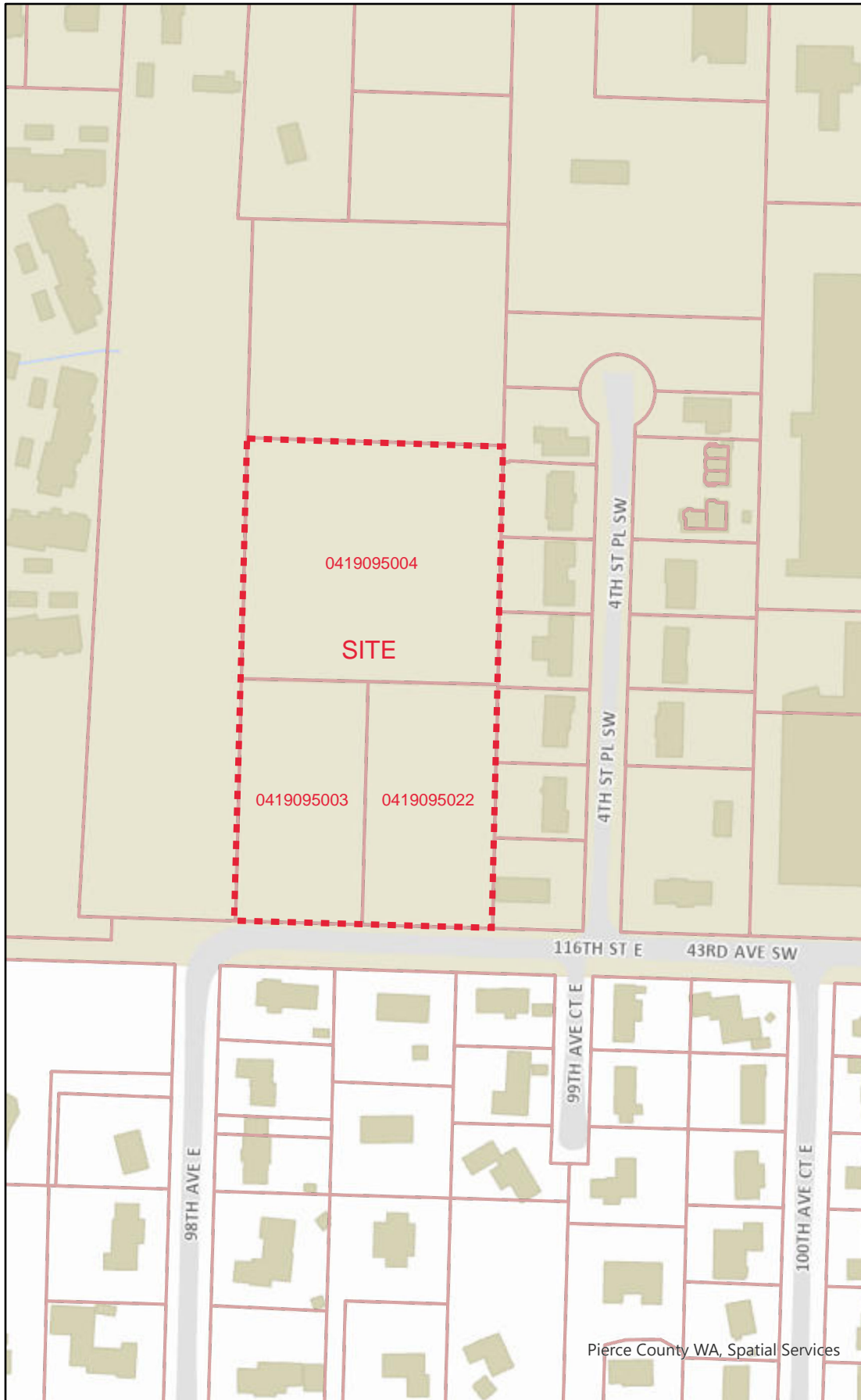
Minimum Requirement #9 will be satisfied by the separately prepared Operation and Maintenance Manual for Drainage Facilities which will be provided during the building site plan submittal.

# APPENDIX A

## General Exhibits

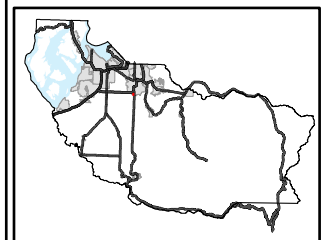
Vicinity Map	A-1
Soil Map	A-2
Soil Description	A-3
FIRMette Map 53053C0343E	A-5

# Vicinity Map



## Legend

 Tax Parcels



0 45 90 180  
Feet

1:2,400

Pierce County WA, Spatial Services

*Disclaimer: The map features are approximate and have not been surveyed. Additional features not yet mapped may be present. Pierce County assumes no liability for variations ascertained by formal survey.*

Date: 2/3/2022 11:03 AM



Soil Map—Pierce County Area, Washington



Map Scale: 1:1,150 if printed on A portrait (8.5" x 11") sheet.



Map projection: Web Mercator Corner coordinates: WGS84 Edge tics: UTM Zone 10N WGS84








































Natural Resources Conservation Service

Web Soil Survey National Cooperative Soil Survey

2/3/2022 Page 1 of 3

## MAP LEGEND

-  Area of Interest (AOI)
-  Area of Interest (AOI)
-  Soil Map Unit Polygons
-  Soil Map Unit Lines
-  Soil Map Unit Points
- Special Point Features**
-  Blowout
-  Borrow Pit
-  Clay Spot
-  Closed Depression
-  Gravel Pit
-  Gravelly Spot
-  Landfill
-  Lava Flow
-  Marsh or swamp
-  Mine or Quarry
-  Miscellaneous Water
-  Perennial Water
-  Rock Outcrop
-  Saline Spot
-  Sandy Spot
-  Severely Eroded Spot
-  Sinkhole
-  Slide or Slip
-  Sodic Spot
-  Spoil Area
-  Stony Spot
-  Very Stony Spot
-  Wet Spot
-  Other
-  Special Line Features
- Water Features**
-  Streams and Canals
- Transportation**
-  Rails
-  Interstate Highways
-  US Routes
-  Major Roads
-  Local Roads
- Background**
-  Aerial Photography

## MAP INFORMATION

The soil surveys that comprise your AOI were mapped at 1:24,000.

Warning: Soil Map may not be valid at this scale.

Enlargement of maps beyond the scale of mapping can cause misunderstanding of the detail of mapping and accuracy of soil line placement. The maps do not show the small areas of contrasting soils that could have been shown at a more detailed scale.

Please rely on the bar scale on each map sheet for map measurements.

Source of Map: Natural Resources Conservation Service  
 Web Soil Survey URL:  
 Coordinate System: Web Mercator (EPSG:3857)

Maps from the Web Soil Survey are based on the Web Mercator projection, which preserves direction and shape but distorts distance and area. A projection that preserves area, such as the Albers equal-area conic projection, should be used if more accurate calculations of distance or area are required.

This product is generated from the USDA-NRCS certified data as of the version date(s) listed below.

Soil Survey Area: Pierce County Area, Washington  
 Survey Area Data: Version 17, Aug 31, 2021

Soil map units are labeled (as space allows) for map scales 1:50,000 or larger.

Date(s) aerial images were photographed: Jul 18, 2020—Aug 2, 2020

The orthophoto or other base map on which the soil lines were compiled and digitized probably differs from the background imagery displayed on these maps. As a result, some minor shifting of map unit boundaries may be evident.

## Map Unit Legend

Map Unit Symbol	Map Unit Name	Acres in AOI	Percent of AOI
13B	Everett very gravelly sandy loam, 0 to 8 percent slopes	2.7	49.8%
13C	Everett very gravelly sandy loam, 8 to 15 percent slopes	0.1	0.9%
26A	Norma fine sandy loam	2.5	45.8%
W	Water	0.2	3.5%
<b>Totals for Area of Interest</b>		<b>5.4</b>	<b>100.0%</b>



# National Flood Hazard Layer FIRMette



122°18'10"W 47°9'21"N



## Legend

SEE FIS REPORT FOR DETAILED LEGEND AND INDEX MAP FOR FIRM PANEL LAYOUT

SPECIAL FLOOD HAZARD AREAS		Without Base Flood Elevation (BFE) Zone A, V, A99
		With BFE or Depth Zone AE, AO, AH, VE, AR
OTHER AREAS OF FLOOD HAZARD		0.2% Annual Chance Flood Hazard, Areas of 1% annual chance flood with average depth less than one foot or with drainage areas of less than one square mile Zone X
		Future Conditions 1% Annual Chance Flood Hazard Zone X
		Area with Reduced Flood Risk due to Levee. See Notes. Zone X
		Area with Flood Risk due to Levee Zone D
OTHER AREAS		NO SCREEN Area of Minimal Flood Hazard Zone X
		Effective LOMRs
GENERAL STRUCTURES		Area of Undetermined Flood Hazard Zone D
		Channel, Culvert, or Storm Sewer
OTHER FEATURES		Levee, Dike, or Floodwall
		20.2 Cross Sections with 1% Annual Chance Water Surface Elevation
MAP PANELS		17.5 Coastal Transect
		Base Flood Elevation Line (BFE)
OTHER FEATURES		Limit of Study
		Jurisdiction Boundary
OTHER FEATURES		Coastal Transect Baseline
		Profile Baseline
OTHER FEATURES		Hydrographic Feature
		Digital Data Available
MAP PANELS		No Digital Data Available
		Unmapped



The pin displayed on the map is an approximate point selected by the user and does not represent an authoritative property location.

This map complies with FEMA's standards for the use of digital flood maps if it is not void as described below. The basemap shown complies with FEMA's basemap accuracy standards

The flood hazard information is derived directly from the authoritative NFHL web services provided by FEMA. This map was exported on 4/27/2022 at 5:51 PM and does not reflect changes or amendments subsequent to this date and time. The NFHL and effective information may change or become superseded by new data over time.

This map image is void if the one or more of the following map elements do not appear: basemap imagery, flood zone labels, legend, scale bar, map creation date, community identifiers, FIRM panel number, and FIRM effective date. Map images for unmapped and unmodernized areas cannot be used for regulatory purposes.

# APPENDIX B

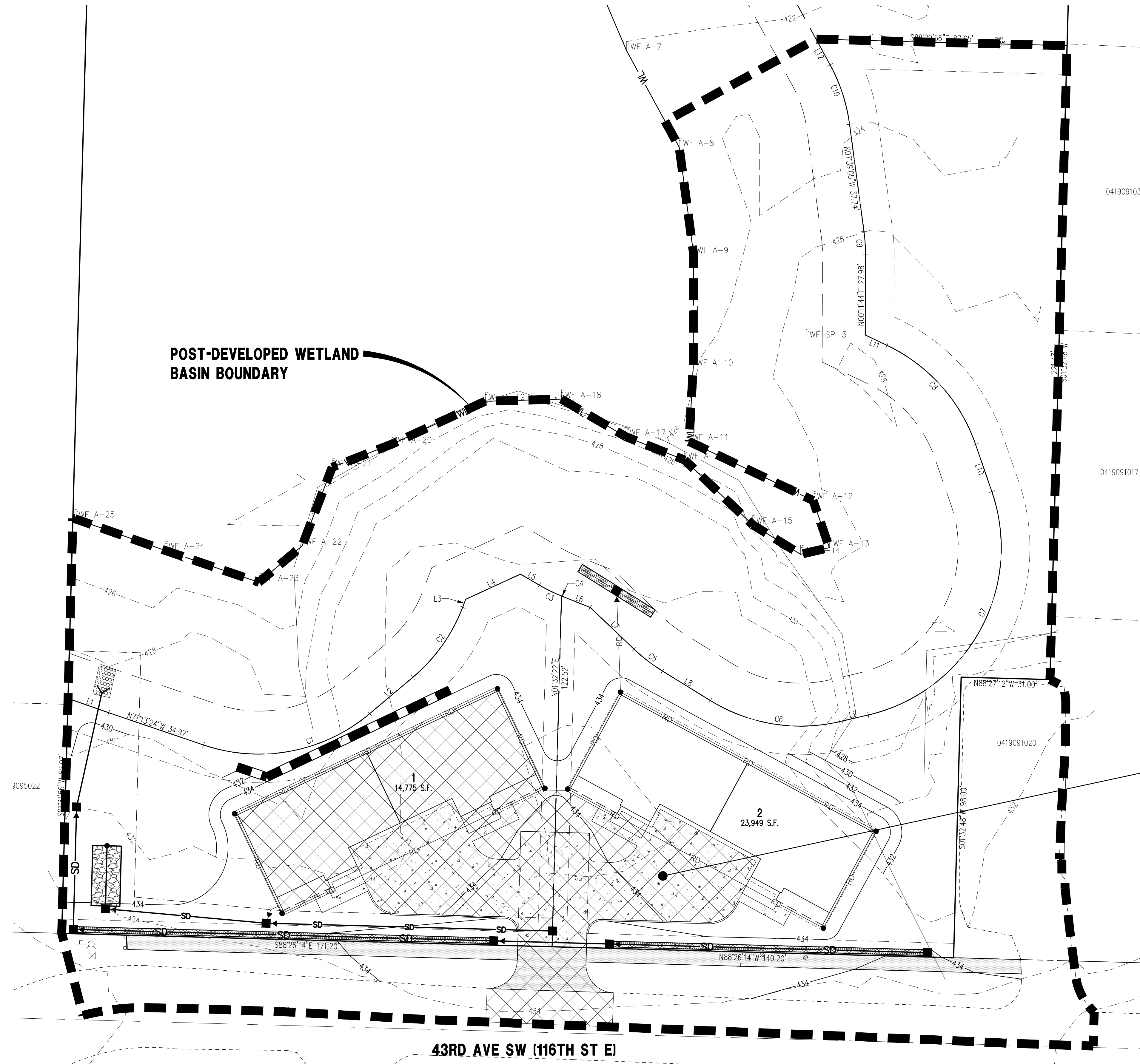
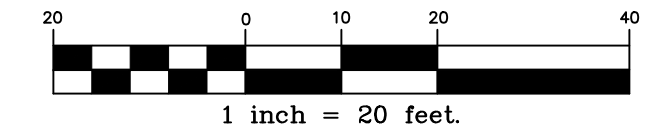
## Basin Exhibits

Pre-Developed Wetland Analysis Map	B-1
Post-Developed Wetland Analysis Map	B-2
Post-Developed Infiltration Basin Map	B-3





**PUYALLUP DUPLEX**  
 A PORTION OF THE NW 1/4 OF THE NW 1/4 OF SEC. 34, TWP. 20 N., RGE. 4 E.,  
 WILLAMETTE MERIDIAN, CITY OF PUYALLUP, PIERCE COUNTY, WASHINGTON



**POST-DEVELOPED WETLAND ANALYSIS**  
 BASIN AREA = 1.731 AC  
**LAND USE BREAKDOWN AREAS**  
 C, FOREST, FLAT = 0.960  
 C, PASTURE, FLAT = 0.415  
 C, LAWN, FLAT = 0.065 AC  
 ROADS FLAT = 0.174 AC  
 ROOF TOPS FLAT = 0.084  
 SIDEWALK FLAT = 0.033  
**TOTAL AREA = 1.731 AC**

FEATURES CONTAINED IN THIS DRAWING,  
 INCLUDING BUT NOT LIMITED TO, BOUNDARY,  
 RIGHT-OF-WAY, EASEMENT, PARCEL LINES,  
 BEARINGS, DISTANCES, WETLANDS AND  
 BUFFERS, WERE DERIVED FROM PUBLIC  
 RECORDS OR ACQUIRED FROM AUTOCAD  
 DRAWINGS SUPPLIED BY OTHERS.

No.	Int.	Date:

**C.E.S. NW INC.**  
 CIVIL ENGINEERING & SURVEYING  
 P.O. BOX 7707, BONNEY LAKE, WA 98391  
 Phone: (253) 848-4388  
 Fax: (253) 848-4278  
 ceservices@cesnwn.com

**PUYALLUP DUPLEX**  
 POST-DEVELOPED WETLAND ANALYSIS MAP

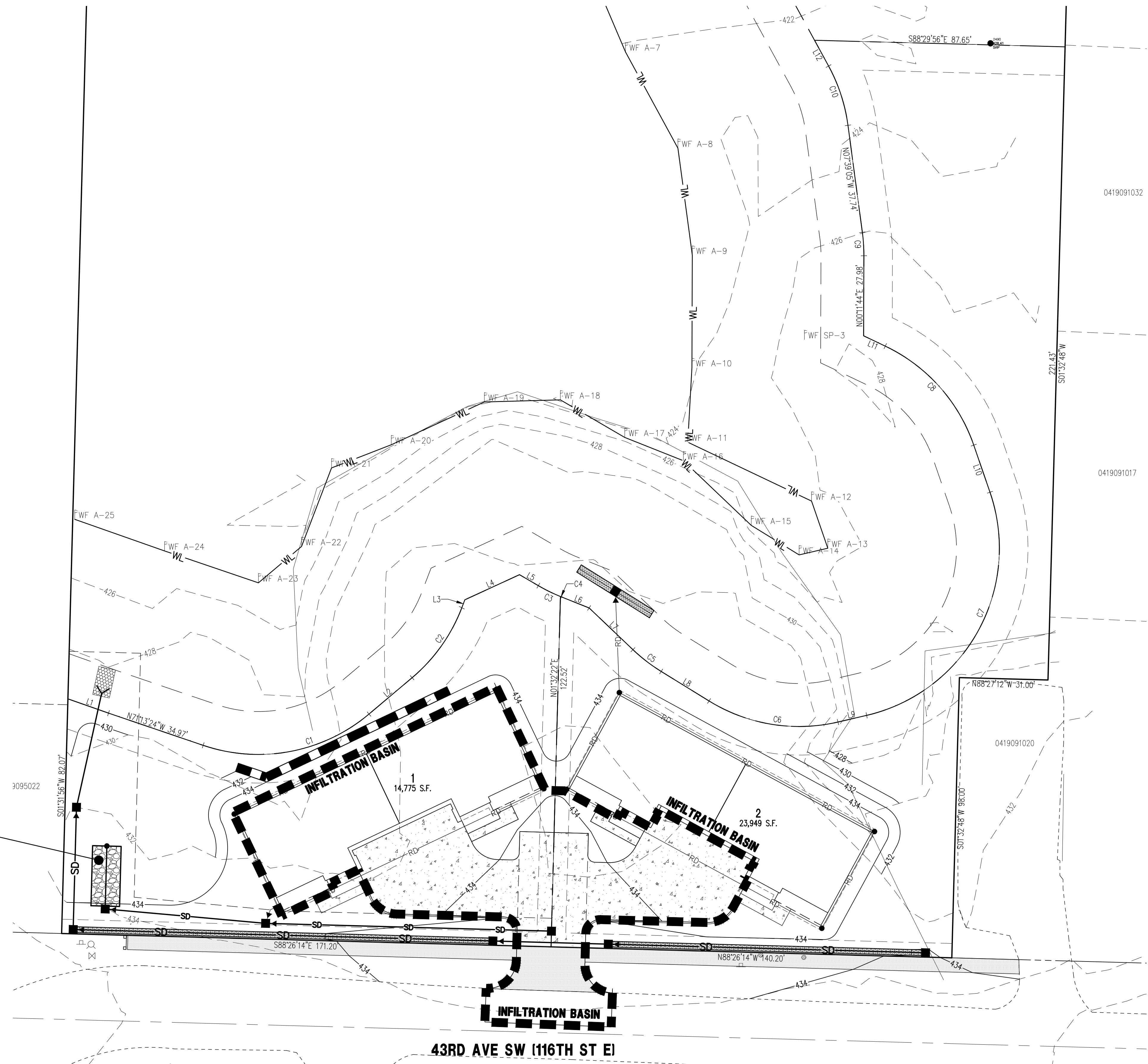
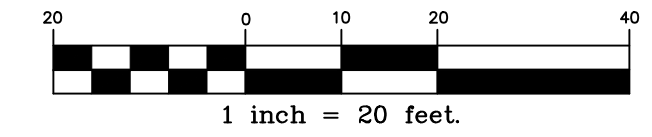
Project: HC HOMES INC.  
 Client: P.O. BOX 7707, BONNEY LAKE, WA 98391

Designed: MAS  
 Drawn: MAS  
 Checked: EC

Scale: 1"=20'  
 Date: 10/6/2023  
 Job No.: 20069

Sheet No.: **B-2**  
 2 of 3 Sheets

**PUYALLUP DUPLEX**  
 A PORTION OF THE NW 1/4 OF THE NW 1/4 OF SEC. 34, TWP. 20 N., RGE. 4 E.,  
 WILLAMETTE MERIDIAN, CITY OF PUYALLUP, PIERCE COUNTY, WASHINGTON



**POST-DEVELOPED INFILTRATION  
 TRENCH BASIN AREA = 0.218 AC**  
**LAND USE BREAKDOWN AREAS**  
 C, PASTURE, FLAT = 0.017 AC  
 ROOF TOPS/FLAT = 0.084 AC  
 DRIVEWAYS FLAT = 0.114 AC  
 SIDEWALKS FLAT = 0.003 AC  
**TOTAL AREA = 0.218 AC**

FEATURES CONTAINED IN THIS DRAWING,  
 INCLUDING BUT NOT LIMITED TO, BOUNDARY,  
 RIGHT-OF-WAY, EASEMENT, PARCEL LINES,  
 BEARINGS, DISTANCES, WETLANDS AND  
 BUFFERS, WERE DERIVED FROM PUBLIC  
 RECORDS OR ACQUIRED FROM AUTOCAD  
 DRAWINGS SUPPLIED BY OTHERS.

No.	Int.	Date:

**C.E.S. NW INC.**  
**CIVIL ENGINEERING & SURVEYING**  
 P.O. BOX 7707, BONNEY LAKE, WA 98391  
 Phone: (253) 848-4388  
 Fax: (253) 848-4278  
 ceservices@cesanwinc.com

**Project:** PUYALLUP DUPLEX  
**POST-DEVELOPED INFIL. BASIN MAP**  
**Client:** HC HOMES INC.  
 P.O. BOX 7707, BONNEY LAKE, WA 98391

**Designed:** MAS  
**Drawn:** MAS  
**Checked:** EOC  
**Scale:** 1"=20'  
**Date:** 10/6/2023  
**Job No.:** 20069  
**Sheet No.:**  
**B-3**  
 3 of 3 Sheets



# APPENDIX C

## Stormwater Calculations

WWHM2012 Wetland "A" Hydrology Analysis	C-1
WWHM2012 Infiltration Trench Sizing Calculation	C-12
WWHM2012 Dispersal Trench Stormwater Flow Calculation	C-18

WWHM2012  
PROJECT REPORT

---

**Project Name:** Wetland "A" Hydrology Analysis  
**Site Name:** Puyallup Duplex  
**Site Address:**  
**City:**  
**Report Date:** 10/9/2023  
**Gage:** 38 IN CENTRAL  
**Data Start:** 10/01/1901  
**Data End:** 09/30/2059  
**Precip Scale:** 1.00  
**Version Date:** 2021/08/18  
**Version:** 4.2.18

---

**PREDEVELOPED LAND USE**

**Name:** Road  
**Bypass:** No  
**Impervious Land Use**                      **acre**  
ROADS FLAT                                      0.186

---

**Element Flows To:**  
**Outlet 1**                                      **Outlet 2**  
Shoulder

---

**Name:** Shoulder  
**Bypass:** No  
**GroundWater:** No  
**Pervious Land Use**                      **acre**  
C, Lawn, Flat                                      .116

**Element Flows To:**  
**Surface**                                      **Interflow**                                      **Groundwater**  
Lot Area                                      Lot Area                                      Lot Area

---

**Name:** Lot Area  
**Bypass:** No  
**GroundWater:** No  
**Pervious Land Use**                      **acre**  
A B, Forest, Flat                                      .893

**Element Flows To:**  
**Surface**                                      **Interflow**                                      **Groundwater**  
Wetland Buffer                                      Wetland Buffer                                      Wetland Buffer

---

Name: Wetland Buffer  
Bypass: No

GroundWater: No

Pervious Land Use                      acre  
A B, Forest, Flat                      .754

Element Flows To:  
Surface                      Interflow                      Groundwater

---

MITIGATED LAND USE

Name: Road  
Bypass: No

Impervious Land Use                      acre  
ROADS FLAT                      0.174

Element Flows To:  
Outlet 1                      Outlet 2  
Shoulder

---

Name: Shoulder  
Bypass: No

GroundWater: No

Pervious Land Use                      acre  
C, Lawn, Flat                      .065

Element Flows To:  
Surface                      Interflow                      Groundwater  
Wetland Buffer                      Wetland Buffer                      Wetland Buffer

---

Name: Wetland Buffer  
Bypass: No

GroundWater: No

Pervious Land Use                      acre  
A B, Forest, Flat                      .754

Element Flows To:  
Surface                      Interflow                      Groundwater

---

Name: Lateral I Basin 2  
Bypass: No

Impervious Land Use                      acre  
ROOF TOPS FLAT                      0.084

---

Element Flows To:  
Outlet 1                      Outlet 2  
Wetland Buffer

---

Name: Developed Pervious Cleared Area  
Bypass: No

GroundWater: No

<u>Pervious Land Use</u>	<u>acre</u>
A B, Pasture, Flat	.415

Element Flows To:		
Surface	Interflow	Groundwater
Wetland Buffer	Wetland Buffer	Wetland Buffer

---

Name: Existing Forested Area  
Bypass: No

GroundWater: No

<u>Pervious Land Use</u>	<u>acre</u>
A B, Forest, Flat	.206

Element Flows To:		
Surface	Interflow	Groundwater
Wetland Buffer	Wetland Buffer	Wetland Buffer

---

Name: Lateral I Basin 3  
Bypass: No

<u>Impervious Land Use</u>	<u>acre</u>
SIDEWALKS FLAT	0.033

---

Element Flows To:  
Outlet 1                      Outlet 2  
Wetland Buffer

---

#### ANALYSIS RESULTS

##### Stream Protection Duration

---

Predeveloped Landuse Totals for POC #1  
Total Pervious Area:1.763  
Total Impervious Area:0.186

---

Mitigated Landuse Totals for POC #1  
Total Pervious Area:1.44  
Total Impervious Area:0.291

---

Flow Frequency Return Periods for Predeveloped. POC #1

<u>Return Period</u>	<u>Flow(cfs)</u>
2 year	0.009831
5 year	0.01333
10 year	0.015577
25 year	0.018343
50 year	0.020358
100 year	0.022339

Flow Frequency Return Periods for Mitigated. POC #1

<u>Return Period</u>	<u>Flow(cfs)</u>
2 year	0.009926
5 year	0.013863
10 year	0.016692
25 year	0.020521
50 year	0.023561
100 year	0.026765

Wetlands Input Volume

Average Annual Volume (acft)

Series 1: 501 POC 1 Predeveloped flow

Series 2: 801 POC 1 Mitigated flow

Month	Series 1	Series 2	Percent	Pass/Fail
Jan	0.3809	0.3739	98.1	Pass
Feb	0.3935	0.3753	95.4	Pass
Mar	0.4212	0.3907	92.8	Pass
Apr	0.3391	0.3074	90.7	Pass
May	0.2656	0.2388	89.9	Pass
Jun	0.1957	0.1755	89.7	Pass
Jul	0.1529	0.1355	88.6	Pass
Aug	0.1219	0.1075	88.2	Pass
Sep	0.1078	0.0958	88.9	Pass
Oct	0.1203	0.1102	91.6	Pass
Nov	0.1811	0.1728	95.4	Pass
Dec	0.2964	0.2937	99.1	Pass

Day	Series 1	Series 2	Percent	Pass/Fail
Jan1	0.0110	0.0108	98.7	Pass
2	0.0110	0.0109	98.5	Pass
3	0.0111	0.0111	99.3	Pass
4	0.0112	0.0112	99.7	Pass
5	0.0113	0.0112	99.2	Pass
6	0.0114	0.0113	99.0	Pass
7	0.0114	0.0113	99.1	Pass
8	0.0115	0.0114	99.1	Pass
9	0.0116	0.0115	99.0	Pass
10	0.0117	0.0115	98.9	Pass
11	0.0117	0.0116	98.9	Pass
12	0.0118	0.0116	98.7	Pass
13	0.0119	0.0118	98.9	Pass
14	0.0121	0.0121	99.6	Pass
15	0.0123	0.0123	99.8	Pass
16	0.0125	0.0124	99.4	Pass
17	0.0126	0.0125	98.9	Pass
18	0.0128	0.0126	98.7	Pass
19	0.0130	0.0128	98.6	Pass

20	0.0131	0.0128	98.1	Pass
21	0.0131	0.0127	96.9	Pass
22	0.0131	0.0127	96.4	Pass
23	0.0132	0.0128	96.9	Pass
24	0.0133	0.0130	97.4	Pass
25	0.0133	0.0129	97.2	Pass
26	0.0134	0.0130	96.8	Pass
27	0.0134	0.0130	96.6	Pass
28	0.0134	0.0129	96.2	Pass
29	0.0133	0.0128	95.6	Pass
30	0.0133	0.0127	95.3	Pass
31	0.0133	0.0128	96.0	Pass
Feb1	0.0134	0.0129	96.7	Pass
2	0.0134	0.0130	96.8	Pass
3	0.0135	0.0130	96.4	Pass
4	0.0135	0.0129	95.7	Pass
5	0.0135	0.0129	95.6	Pass
6	0.0135	0.0130	96.1	Pass
7	0.0136	0.0130	95.9	Pass
8	0.0136	0.0131	95.9	Pass
9	0.0136	0.0130	95.5	Pass
10	0.0136	0.0129	95.2	Pass
11	0.0136	0.0129	95.1	Pass
12	0.0136	0.0130	95.5	Pass
13	0.0136	0.0131	95.8	Pass
14	0.0137	0.0131	95.8	Pass
15	0.0138	0.0131	95.5	Pass
16	0.0139	0.0134	95.9	Pass
17	0.0141	0.0137	96.7	Pass
18	0.0143	0.0139	96.9	Pass
19	0.0145	0.0140	96.5	Pass
20	0.0146	0.0139	95.4	Pass
21	0.0146	0.0138	94.3	Pass
22	0.0146	0.0137	93.7	Pass
23	0.0145	0.0136	93.3	Pass
24	0.0145	0.0135	93.3	Pass
25	0.0144	0.0136	93.9	Pass
26	0.0144	0.0136	94.0	Pass
27	0.0145	0.0136	94.2	Pass
28	0.0148	0.0140	94.1	Pass
29	0.0144	0.0135	93.6	Pass
Mar1	0.0143	0.0133	93.2	Pass
2	0.0142	0.0133	93.2	Pass
3	0.0142	0.0132	93.0	Pass
4	0.0141	0.0132	93.2	Pass
5	0.0141	0.0131	93.3	Pass
6	0.0140	0.0131	93.2	Pass
7	0.0139	0.0129	92.9	Pass
8	0.0139	0.0129	93.2	Pass
9	0.0139	0.0130	93.6	Pass
10	0.0138	0.0129	93.5	Pass
11	0.0138	0.0129	93.3	Pass
12	0.0138	0.0129	93.5	Pass
13	0.0138	0.0130	93.6	Pass
14	0.0138	0.0129	93.2	Pass
15	0.0138	0.0128	92.9	Pass
16	0.0137	0.0127	92.4	Pass

17	0.0136	0.0125	92.0	Pass
18	0.0135	0.0123	91.7	Pass
19	0.0133	0.0122	91.5	Pass
20	0.0132	0.0121	91.4	Pass
21	0.0131	0.0120	91.6	Pass
22	0.0131	0.0120	92.1	Pass
23	0.0130	0.0121	92.8	Pass
24	0.0130	0.0121	92.9	Pass
25	0.0130	0.0120	92.6	Pass
26	0.0130	0.0120	92.4	Pass
27	0.0130	0.0120	92.3	Pass
28	0.0129	0.0119	92.1	Pass
29	0.0130	0.0119	92.2	Pass
30	0.0129	0.0119	92.2	Pass
31	0.0129	0.0118	91.9	Pass
Apr1	0.0128	0.0117	91.3	Pass
2	0.0127	0.0115	90.6	Pass
3	0.0125	0.0113	90.2	Pass
4	0.0124	0.0111	90.2	Pass
5	0.0122	0.0111	90.5	Pass
6	0.0121	0.0110	90.7	Pass
7	0.0120	0.0109	90.7	Pass
8	0.0119	0.0108	91.0	Pass
9	0.0118	0.0108	91.3	Pass
10	0.0118	0.0108	91.4	Pass
11	0.0117	0.0107	91.3	Pass
12	0.0116	0.0106	91.3	Pass
13	0.0115	0.0105	90.9	Pass
14	0.0114	0.0103	90.4	Pass
15	0.0113	0.0101	90.1	Pass
16	0.0111	0.0100	90.0	Pass
17	0.0110	0.0099	90.1	Pass
18	0.0108	0.0097	89.9	Pass
19	0.0107	0.0097	90.2	Pass
20	0.0106	0.0097	90.8	Pass
21	0.0105	0.0096	90.8	Pass
22	0.0105	0.0095	90.6	Pass
23	0.0104	0.0095	91.0	Pass
24	0.0104	0.0095	91.2	Pass
25	0.0103	0.0094	90.8	Pass
26	0.0102	0.0092	90.3	Pass
27	0.0101	0.0091	90.2	Pass
28	0.0100	0.0090	90.0	Pass
29	0.0099	0.0089	89.8	Pass
30	0.0098	0.0088	89.8	Pass
May1	0.0097	0.0088	90.3	Pass
2	0.0097	0.0088	90.8	Pass
3	0.0096	0.0087	90.7	Pass
4	0.0096	0.0086	90.4	Pass
5	0.0095	0.0086	90.5	Pass
6	0.0094	0.0085	90.4	Pass
7	0.0094	0.0084	90.1	Pass
8	0.0093	0.0083	89.7	Pass
9	0.0091	0.0081	89.2	Pass
10	0.0090	0.0080	88.8	Pass
11	0.0089	0.0079	88.8	Pass
12	0.0087	0.0078	89.0	Pass

13	0.0086	0.0077	89.7	Pass
14	0.0085	0.0077	90.2	Pass
15	0.0085	0.0076	90.1	Pass
16	0.0084	0.0076	90.2	Pass
17	0.0083	0.0075	90.3	Pass
18	0.0082	0.0074	90.1	Pass
19	0.0082	0.0073	89.7	Pass
20	0.0081	0.0073	89.7	Pass
21	0.0080	0.0072	89.7	Pass
22	0.0079	0.0071	89.6	Pass
23	0.0079	0.0070	89.5	Pass
24	0.0078	0.0070	89.6	Pass
25	0.0077	0.0069	89.8	Pass
26	0.0076	0.0069	89.9	Pass
27	0.0076	0.0068	90.1	Pass
28	0.0075	0.0068	90.1	Pass
29	0.0075	0.0068	90.2	Pass
30	0.0074	0.0067	90.2	Pass
31	0.0074	0.0067	90.2	Pass
Jun1	0.0073	0.0066	90.3	Pass
2	0.0073	0.0066	90.3	Pass
3	0.0072	0.0065	89.9	Pass
4	0.0072	0.0064	89.7	Pass
5	0.0071	0.0064	89.7	Pass
6	0.0071	0.0063	89.6	Pass
7	0.0070	0.0063	89.8	Pass
8	0.0069	0.0062	90.0	Pass
9	0.0069	0.0062	90.2	Pass
10	0.0068	0.0061	90.0	Pass
11	0.0068	0.0061	89.7	Pass
12	0.0067	0.0060	89.3	Pass
13	0.0066	0.0059	89.1	Pass
14	0.0065	0.0058	89.1	Pass
15	0.0065	0.0058	89.3	Pass
16	0.0064	0.0057	89.5	Pass
17	0.0063	0.0057	89.7	Pass
18	0.0063	0.0056	89.7	Pass
19	0.0062	0.0056	89.5	Pass
20	0.0061	0.0055	89.3	Pass
21	0.0061	0.0055	89.6	Pass
22	0.0060	0.0054	89.5	Pass
23	0.0060	0.0053	89.4	Pass
24	0.0059	0.0053	89.9	Pass
25	0.0059	0.0053	90.0	Pass
26	0.0058	0.0052	89.8	Pass
27	0.0058	0.0052	89.4	Pass
28	0.0057	0.0051	89.2	Pass
29	0.0057	0.0051	89.3	Pass
30	0.0056	0.0050	89.6	Pass
Jul1	0.0056	0.0050	89.5	Pass
2	0.0055	0.0049	89.4	Pass
3	0.0055	0.0049	89.2	Pass
4	0.0054	0.0048	88.8	Pass
5	0.0054	0.0048	88.8	Pass
6	0.0053	0.0047	88.8	Pass
7	0.0053	0.0047	88.8	Pass
8	0.0052	0.0046	88.9	Pass



9	0.0052	0.0046	89.0	Pass
10	0.0051	0.0045	88.6	Pass
11	0.0051	0.0045	88.6	Pass
12	0.0050	0.0045	89.0	Pass
13	0.0050	0.0045	89.3	Pass
14	0.0050	0.0044	89.0	Pass
15	0.0049	0.0044	88.8	Pass
16	0.0049	0.0043	88.7	Pass
17	0.0049	0.0043	88.6	Pass
18	0.0048	0.0043	88.7	Pass
19	0.0048	0.0042	88.3	Pass
20	0.0047	0.0042	87.9	Pass
21	0.0047	0.0041	87.8	Pass
22	0.0046	0.0041	87.7	Pass
23	0.0046	0.0040	87.5	Pass
24	0.0045	0.0040	87.5	Pass
25	0.0045	0.0039	87.5	Pass
26	0.0044	0.0039	87.8	Pass
27	0.0044	0.0039	88.0	Pass
28	0.0044	0.0039	88.2	Pass
29	0.0043	0.0038	88.1	Pass
30	0.0043	0.0038	87.9	Pass
31	0.0043	0.0037	87.7	Pass
Aug1	0.0042	0.0037	87.6	Pass
2	0.0042	0.0037	87.6	Pass
3	0.0042	0.0037	87.7	Pass
4	0.0041	0.0036	87.9	Pass
5	0.0041	0.0036	88.0	Pass
6	0.0041	0.0036	87.9	Pass
7	0.0041	0.0036	87.8	Pass
8	0.0040	0.0036	87.9	Pass
9	0.0040	0.0035	87.9	Pass
10	0.0040	0.0035	87.8	Pass
11	0.0040	0.0035	87.7	Pass
12	0.0040	0.0035	87.5	Pass
13	0.0039	0.0034	87.6	Pass
14	0.0039	0.0034	87.9	Pass
15	0.0039	0.0034	88.3	Pass
16	0.0039	0.0034	88.5	Pass
17	0.0039	0.0034	88.6	Pass
18	0.0039	0.0034	88.6	Pass
19	0.0038	0.0034	88.2	Pass
20	0.0038	0.0034	88.0	Pass
21	0.0038	0.0033	87.7	Pass
22	0.0038	0.0033	87.7	Pass
23	0.0038	0.0033	87.8	Pass
24	0.0038	0.0033	88.5	Pass
25	0.0037	0.0033	88.9	Pass
26	0.0037	0.0033	89.1	Pass
27	0.0037	0.0033	89.2	Pass
28	0.0037	0.0033	89.4	Pass
29	0.0037	0.0034	89.6	Pass
30	0.0038	0.0033	89.0	Pass
31	0.0037	0.0033	88.7	Pass
Sep1	0.0037	0.0033	89.1	Pass
2	0.0038	0.0034	89.5	Pass
3	0.0038	0.0033	89.0	Pass

4	0.0038	0.0033	88.2	Pass
5	0.0037	0.0033	87.8	Pass
6	0.0037	0.0032	87.4	Pass
7	0.0037	0.0032	87.0	Pass
8	0.0037	0.0032	87.0	Pass
9	0.0036	0.0032	87.1	Pass
10	0.0036	0.0031	87.5	Pass
11	0.0036	0.0031	87.6	Pass
12	0.0035	0.0031	87.5	Pass
13	0.0035	0.0031	87.5	Pass
14	0.0035	0.0030	87.5	Pass
15	0.0035	0.0031	88.5	Pass
16	0.0035	0.0031	89.5	Pass
17	0.0035	0.0031	90.5	Pass
18	0.0035	0.0032	91.7	Pass
19	0.0035	0.0032	91.4	Pass
20	0.0035	0.0032	91.1	Pass
21	0.0035	0.0032	90.8	Pass
22	0.0036	0.0032	90.7	Pass
23	0.0036	0.0032	90.6	Pass
24	0.0036	0.0032	90.2	Pass
25	0.0036	0.0032	89.1	Pass
26	0.0036	0.0032	88.0	Pass
27	0.0036	0.0032	88.6	Pass
28	0.0036	0.0032	89.4	Pass
29	0.0036	0.0032	88.8	Pass
30	0.0035	0.0031	88.2	Pass
Oct1	0.0035	0.0031	88.8	Pass
2	0.0035	0.0031	89.3	Pass
3	0.0035	0.0031	88.9	Pass
4	0.0035	0.0031	88.5	Pass
5	0.0035	0.0031	88.9	Pass
6	0.0035	0.0032	90.3	Pass
7	0.0035	0.0033	92.2	Pass
8	0.0036	0.0033	93.2	Pass
9	0.0037	0.0034	93.4	Pass
10	0.0037	0.0035	93.2	Pass
11	0.0038	0.0035	92.0	Pass
12	0.0038	0.0035	90.7	Pass
13	0.0038	0.0034	89.9	Pass
14	0.0038	0.0034	89.5	Pass
15	0.0038	0.0034	89.5	Pass
16	0.0038	0.0034	89.3	Pass
17	0.0038	0.0034	89.7	Pass
18	0.0038	0.0035	91.4	Pass
19	0.0039	0.0036	92.6	Pass
20	0.0039	0.0037	93.4	Pass
21	0.0040	0.0038	94.5	Pass
22	0.0041	0.0038	94.2	Pass
23	0.0041	0.0038	93.2	Pass
24	0.0042	0.0039	92.6	Pass
25	0.0042	0.0039	92.3	Pass
26	0.0043	0.0040	93.1	Pass
27	0.0044	0.0041	94.1	Pass
28	0.0045	0.0042	94.0	Pass
29	0.0046	0.0043	93.1	Pass
30	0.0047	0.0043	91.6	Pass

31	0.0047	0.0043	91.3	Pass
Nov1	0.0048	0.0043	90.9	Pass
2	0.0048	0.0044	91.5	Pass
3	0.0049	0.0045	92.5	Pass
4	0.0049	0.0046	93.6	Pass
5	0.0050	0.0047	93.4	Pass
6	0.0051	0.0047	92.8	Pass
7	0.0051	0.0047	92.5	Pass
8	0.0052	0.0047	91.7	Pass
9	0.0052	0.0048	92.2	Pass
10	0.0053	0.0050	93.6	Pass
11	0.0054	0.0051	95.4	Pass
12	0.0055	0.0053	96.2	Pass
13	0.0057	0.0055	96.8	Pass
14	0.0058	0.0056	96.9	Pass
15	0.0059	0.0057	96.2	Pass
16	0.0061	0.0059	96.2	Pass
17	0.0062	0.0059	96.0	Pass
18	0.0063	0.0061	96.2	Pass
19	0.0064	0.0062	96.4	Pass
20	0.0065	0.0063	96.3	Pass
21	0.0067	0.0064	95.7	Pass
22	0.0068	0.0065	96.2	Pass
23	0.0070	0.0068	97.3	Pass
24	0.0072	0.0071	98.9	Pass
25	0.0074	0.0074	99.5	Pass
26	0.0076	0.0075	98.7	Pass
27	0.0078	0.0075	97.0	Pass
28	0.0079	0.0075	95.9	Pass
29	0.0079	0.0076	95.7	Pass
30	0.0080	0.0078	97.0	Pass
Dec1	0.0081	0.0080	97.7	Pass
2	0.0083	0.0082	98.6	Pass
3	0.0084	0.0084	99.1	Pass
4	0.0086	0.0085	98.9	Pass
5	0.0088	0.0086	98.8	Pass
6	0.0089	0.0088	98.7	Pass
7	0.0090	0.0089	98.4	Pass
8	0.0091	0.0089	97.9	Pass
9	0.0091	0.0088	97.4	Pass
10	0.0092	0.0090	98.2	Pass
11	0.0092	0.0091	98.9	Pass
12	0.0093	0.0093	99.4	Pass
13	0.0094	0.0093	99.1	Pass
14	0.0095	0.0094	99.1	Pass
15	0.0096	0.0095	99.1	Pass
16	0.0096	0.0096	99.3	Pass
17	0.0097	0.0097	99.5	Pass
18	0.0098	0.0097	99.2	Pass
19	0.0098	0.0098	99.2	Pass
20	0.0099	0.0099	100.1	Pass
21	0.0101	0.0102	100.8	Pass
22	0.0102	0.0103	100.7	Pass
23	0.0103	0.0103	100.1	Pass
24	0.0104	0.0103	99.5	Pass
25	0.0105	0.0104	99.2	Pass
26	0.0106	0.0105	99.4	Pass

27	0.0107	0.0106	99.4	Pass
28	0.0107	0.0107	99.3	Pass
29	0.0108	0.0108	99.6	Pass
30	0.0109	0.0108	99.5	Pass
31	0.0109	0.0108	98.9	Pass

---

This program and accompanying documentation are provided 'as-is' without warranty of any kind. The entire risk regarding the performance and results of this program is assumed by End User. Clear Creek Solutions Inc. and the governmental licensee or sublicensees disclaim all warranties, either expressed or implied, including but not limited to implied warranties of program and accompanying documentation. In no event shall Clear Creek Solutions Inc. be liable for any damages whatsoever (including without limitation to damages for loss of business profits, loss of business information, business interruption, and the like) arising out of the use of, or inability to use this program even if Clear Creek Solutions Inc. or their authorized representatives have been advised of the possibility of such damages. Software Copyright © by : Clear Creek Solutions, Inc. 2005-2023; All Rights Reserved.

**WWHM2012  
PROJECT REPORT**

---

**Project Name:** Infiltration Trench Sizing Calculation  
**Site Name:** Puyallup Duplex  
**Site Address:**  
**City:**  
**Report Date:** 10/9/2023  
**Gage:** 40 IN EAST  
**Data Start:** 10/01/1901  
**Data End:** 09/30/2059  
**Precip Scale:** 1.00  
**Version Date:** 2021/08/18  
**Version:** 4.2.18

---

**MITIGATED LAND USE**

**Name:** Basin 1  
**Bypass:** No

**GroundWater:** No

<u>Pervious Land Use</u>	<u>acre</u>
C, Pasture, Flat	.017
<b>Pervious Total</b>	<b>0.017</b>
<u>Impervious Land Use</u>	<u>acre</u>
ROOF TOPS FLAT	0.084
DRIVEWAYS FLAT	0.114
SIDEWALKS FLAT	0.003
<b>Impervious Total</b>	<b>0.201</b>
<b>Basin Total</b>	<b>0.218</b>

---

**Element Flows To:**

<b>Surface</b>	<b>Interflow</b>	<b>Groundwater</b>
Gravel Trench Bed 1	Gravel Trench Bed 1	

---

**Name:** Gravel Trench Bed 1  
**Bottom Length:** 21.00 ft.  
**Bottom Width:** 10.00 ft.  
**Trench bottom slope 1:** 0 To 1  
**Trench left side slope 0:** 0 To 1  
**Trench right side slope 2:** 0 To 1  
**Material thickness of first layer:** 3  
**Pour Space of material for first layer:** 0.33  
**Material thickness of second layer:** 0  
**Pour Space of material for second layer:** 0  
**Material thickness of third layer:** 0  
**Pour Space of material for third layer:** 0  
**Infiltration On**

Infiltration rate: 30  
 Infiltration safety factor: 1  
 Total Volume Infiltrated (ac-ft.): 85.004  
 Total Volume Through Riser (ac-ft.): 0  
 Total Volume Through Facility (ac-ft.): 85.004  
 Percent Infiltrated: 100  
 Total Precip Applied to Facility: 0  
 Total Evap From Facility: 0  
Discharge Structure  
 Riser Height: 3 ft.  
 Riser Diameter: 8 in.

Element Flows To:  
 Outlet 1                      Outlet 2

---

**Gravel Trench Bed Hydraulic Table**

Stage(feet)	Area(ac.)	Volume(ac-ft.)	Discharge(cfs)	Infilt(cfs)
0.0000	0.004	0.000	0.000	0.000
0.0444	0.004	0.000	0.000	0.145
0.0889	0.004	0.000	0.000	0.145
0.1333	0.004	0.000	0.000	0.145
0.1778	0.004	0.000	0.000	0.145
0.2222	0.004	0.000	0.000	0.145
0.2667	0.004	0.000	0.000	0.145
0.3111	0.004	0.000	0.000	0.145
0.3556	0.004	0.000	0.000	0.145
0.4000	0.004	0.000	0.000	0.145
0.4444	0.004	0.000	0.000	0.145
0.4889	0.004	0.000	0.000	0.145
0.5333	0.004	0.000	0.000	0.145
0.5778	0.004	0.000	0.000	0.145
0.6222	0.004	0.001	0.000	0.145
0.6667	0.004	0.001	0.000	0.145
0.7111	0.004	0.001	0.000	0.145
0.7556	0.004	0.001	0.000	0.145
0.8000	0.004	0.001	0.000	0.145
0.8444	0.004	0.001	0.000	0.145
0.8889	0.004	0.001	0.000	0.145
0.9333	0.004	0.001	0.000	0.145
0.9778	0.004	0.001	0.000	0.145
1.0222	0.004	0.001	0.000	0.145
1.0667	0.004	0.001	0.000	0.145
1.1111	0.004	0.001	0.000	0.145
1.1556	0.004	0.001	0.000	0.145
1.2000	0.004	0.001	0.000	0.145
1.2444	0.004	0.002	0.000	0.145
1.2889	0.004	0.002	0.000	0.145
1.3333	0.004	0.002	0.000	0.145
1.3778	0.004	0.002	0.000	0.145
1.4222	0.004	0.002	0.000	0.145
1.4667	0.004	0.002	0.000	0.145
1.5111	0.004	0.002	0.000	0.145
1.5556	0.004	0.002	0.000	0.145
1.6000	0.004	0.002	0.000	0.145
1.6444	0.004	0.002	0.000	0.145
1.6889	0.004	0.002	0.000	0.145

1.7333	0.004	0.002	0.000	0.145
1.7778	0.004	0.002	0.000	0.145
1.8222	0.004	0.002	0.000	0.145
1.8667	0.004	0.003	0.000	0.145
1.9111	0.004	0.003	0.000	0.145
1.9556	0.004	0.003	0.000	0.145
2.0000	0.004	0.003	0.000	0.145
2.0444	0.004	0.003	0.000	0.145
2.0889	0.004	0.003	0.000	0.145
2.1333	0.004	0.003	0.000	0.145
2.1778	0.004	0.003	0.000	0.145
2.2222	0.004	0.003	0.000	0.145
2.2667	0.004	0.003	0.000	0.145
2.3111	0.004	0.003	0.000	0.145
2.3556	0.004	0.003	0.000	0.145
2.4000	0.004	0.003	0.000	0.145
2.4444	0.004	0.003	0.000	0.145
2.4889	0.004	0.004	0.000	0.145
2.5333	0.004	0.004	0.000	0.145
2.5778	0.004	0.004	0.000	0.145
2.6222	0.004	0.004	0.000	0.145
2.6667	0.004	0.004	0.000	0.145
2.7111	0.004	0.004	0.000	0.145
2.7556	0.004	0.004	0.000	0.145
2.8000	0.004	0.004	0.000	0.145
2.8444	0.004	0.004	0.000	0.145
2.8889	0.004	0.004	0.000	0.145
2.9333	0.004	0.004	0.000	0.145
2.9778	0.004	0.004	0.000	0.145
3.0222	0.004	0.005	0.023	0.145
3.0667	0.004	0.005	0.121	0.145
3.1111	0.004	0.005	0.255	0.145
3.1556	0.004	0.005	0.404	0.145
3.2000	0.004	0.005	0.547	0.145
3.2444	0.004	0.006	0.665	0.145
3.2889	0.004	0.006	0.747	0.145
3.3333	0.004	0.006	0.799	0.145
3.3778	0.004	0.006	0.860	0.145
3.4222	0.004	0.006	0.909	0.145
3.4667	0.004	0.007	0.956	0.145
3.5111	0.004	0.007	1.000	0.145
3.5556	0.004	0.007	1.043	0.145
3.6000	0.004	0.007	1.084	0.145
3.6444	0.004	0.008	1.123	0.145
3.6889	0.004	0.008	1.161	0.145
3.7333	0.004	0.008	1.198	0.145
3.7778	0.004	0.008	1.234	0.145
3.8222	0.004	0.008	1.269	0.145
3.8667	0.004	0.009	1.303	0.145
3.9111	0.004	0.009	1.336	0.145
3.9556	0.004	0.009	1.368	0.145
4.0000	0.004	0.009	1.399	0.145

---

**Stream Protection Duration**

**POC #1**

**The Facility PASSED**

**The Facility PASSED.**

<b>Flow(cfs)</b>	<b>Predev</b>	<b>Mit</b>	<b>Percentage</b>	<b>Pass/Fail</b>
0.0001	4672	0	0	Pass
0.0001	4558	0	0	Pass
0.0001	4433	0	0	Pass
0.0001	4191	0	0	Pass
0.0001	4075	0	0	Pass
0.0001	3861	0	0	Pass
0.0001	3733	0	0	Pass
0.0001	3649	0	0	Pass
0.0001	3461	0	0	Pass
0.0001	3388	0	0	Pass
0.0001	3208	0	0	Pass
0.0001	3125	0	0	Pass
0.0001	3012	0	0	Pass
0.0001	2868	0	0	Pass
0.0001	2807	0	0	Pass
0.0001	2660	0	0	Pass
0.0001	2613	0	0	Pass
0.0001	2473	0	0	Pass
0.0001	2403	0	0	Pass
0.0001	2364	0	0	Pass
0.0001	2265	0	0	Pass
0.0001	2217	0	0	Pass
0.0001	2123	0	0	Pass
0.0001	2072	0	0	Pass
0.0001	2018	0	0	Pass
0.0001	1907	0	0	Pass
0.0001	1863	0	0	Pass
0.0001	1790	0	0	Pass
0.0001	1748	0	0	Pass
0.0001	1676	0	0	Pass
0.0001	1611	0	0	Pass
0.0001	1583	0	0	Pass
0.0001	1507	0	0	Pass
0.0001	1480	0	0	Pass
0.0001	1400	0	0	Pass
0.0001	1338	0	0	Pass
0.0001	1285	0	0	Pass
0.0001	1170	0	0	Pass
0.0001	1124	0	0	Pass
0.0001	1047	0	0	Pass
0.0001	1018	0	0	Pass
0.0001	993	0	0	Pass
0.0001	958	0	0	Pass
0.0001	938	0	0	Pass
0.0001	864	0	0	Pass
0.0001	841	0	0	Pass
0.0001	769	0	0	Pass
0.0001	749	0	0	Pass
0.0001	720	0	0	Pass
0.0001	670	0	0	Pass





business information, business interruption, and the like) arising out of the use of, or inability to use this program even if Clear Creek Solutions Inc. or their authorized representatives have been advised of the possibility of such damages. Software Copyright © by: Clear Creek Solutions, Inc. 2005-2023; All Rights Reserved.

**WWHM2012  
PROJECT REPORT**

---

**Project Name:** 30 ft. Dispersion Trench Flow Calculation for Lot 2  
**Site Name:** Puyallup Duplex - Lot 2  
**Site Address:**  
**City:**  
**Report Date:** 10/6/2023  
**Gage:** 40 IN EAST  
**Data Start:** 10/01/1901  
**Data End:** 09/30/2059  
**Precip Scale:** 1.00  
**Version Date:** 2021/08/18  
**Version:** 4.2.18

---

**MITIGATED LAND USE**

**Name:** Basin 1  
**Bypass:** No

**GroundWater:** No

<u>Pervious Land Use</u>	<u>acre</u>
Pervious Total	0
<u>Impervious Land Use</u>	<u>acre</u>
ROOF TOPS FLAT	0.084 (Roof Surface Totaling ~ 3,639 sf)
Impervious Total	0.084
Basin Total	0.084

---

Element Flows To:		
Surface	Interflow	Groundwater

---

**ANALYSIS RESULTS  
Stream Protection Duration**

---

Mitigated Landuse Totals for POC #1  
Total Pervious Area:0  
Total Impervious Area:0.084

---

<u>Return Period</u>	<u>Flow(cfs)</u>
2 year	0.030123
5 year	0.040409
10 year	0.047881
25 year	0.058104
50 year	0.066305
100 year	0.075025 < 0.30 cfs (Capacity of 30 ft. Long Trench)

---

This program and accompanying documentation are provided 'as-is' without warranty of any kind. The entire risk regarding the performance and results of this program is assumed by End User. Clear Creek Solutions Inc. and the governmental licensee or sublicensees disclaim all warranties, either expressed or implied, including but not limited to implied warranties of program and accompanying documentation. In no event shall Clear Creek Solutions Inc. be liable for any damages whatsoever (including without limitation to damages for loss of business profits, loss of business information, business interruption, and the like) arising out of the use of, or inability to use this program even if Clear Creek Solutions Inc. or their authorized representatives have been advised of the possibility of such damages. Software Copyright © by : Clear Creek Solutions, Inc. 2005-2023; All Rights Reserved.

# APPENDIX D

## Critical Areas Assessment

Habitat Technologies - Critical Areas Assessment (Parcel 0419095003)

D-1

Habitat Technologies - Critical Areas Assessment (Parcel 0419095022)

D-50

# **HABITAT TECHNOLOGIES**

---

## **CRITICAL AREAS ASSESSMENT**

**Parcel 0419095003**  
**433 - 43<sup>rd</sup> Avenue SW**  
**City of Puyallup, Washington**

*This document incorporates comments provided by City of Puyallup review*

prepared for

**Mr. David Artz**  
**7917 - 110<sup>th</sup> Street NW**  
**Gig Harbor, Washington 98332**

prepared by

**HABITAT TECHNOLOGIES**  
**P.O. Box 1088**  
**Puyallup, Washington 98371-1088**  
**253-845-5119**

**June 4, 2019**  
**REVISED**  
**September 18, 2020**

## Table of Contents

<b>INTRODUCTION</b> .....	<b>1</b>
PROJECT SITE DESCRIPTION.....	1
<b>BACKGROUND INFORMATION</b> .....	<b>2</b>
NATIONAL WETLAND INVENTORY.....	2
STATE OF WASHINGTON PRIORITY HABITATS AND SPECIES .....	2
STATE OF WASHINGTON DEPARTMENT OF FISH AND WILDLIFE.....	2
STATE OF WASHINGTON DEPARTMENT OF NATURAL RESOURCES.....	2
CITY OF PUYALLUP MAPPING.....	2
SOILS MAPPING.....	3
PRIOR ASSESSMENTS.....	3
<b>ONSITE ANALYSIS</b> .....	<b>3</b>
CRITERIA FOR CRITICAL AREAS IDENTIFICATION.....	3
STUDY METHODS.....	4
FIELD OBSERVATION.....	5
<input type="checkbox"/> <i>Plant Communities</i> .....	5
<input type="checkbox"/> <i>Hydrology</i> .....	6
<input type="checkbox"/> <i>Soils</i> .....	6
<input type="checkbox"/> <i>Fish and Wildlife</i> .....	7
<b>CRITICAL AREAS DETERMINATION</b> .....	<b>9</b>
WETLANDS .....	9
FISH AND WILDLIFE HABITAT AREAS .....	9
<b>SELECTED DEVELOPMENT ACTION</b> .....	<b>10</b>
<b>STANDARD OF CARE</b> .....	<b>10</b>
<b>REFERENCE AND BACKGROUND LIST</b> .....	<b>12</b>
<b>APPENDIX A – REPRESENTATIVE FIELD DATA</b> .....	<b>14</b>
<b>APPENDIX B – WETLAND RATING WORKSHEET</b> .....	<b>15</b>
<b>APPENDIX C – SITE PLAN</b> .....	<b>16</b>

## INTRODUCTION

This document details the culmination of activities and onsite evaluations undertaken to complete a critical areas assessment (i.e. wetlands, streams, fish and wildlife habitats) of **Parcel 0419095003** and a septic easement area within parcel 0419091068 (**Project site**). The project site was located at 433 - 43<sup>rd</sup> Avenue SW within the City of Puyallup, Pierce County, Washington (Figure 1). The evaluation and characterization of onsite and adjacent critical areas is a vital element in land use planning. The goal of this approach is to ensure that the proposed development of a single duplex and associated primary and reserve septic drainfield areas does not result in adverse environmental impacts to an identified City of Puyallup Category III Wetland and the associated 60-foot standard City of Puyallup buffer identified within the project site. As presently proposed all development activities would be accomplished without an encroachment into the identified wetland or associated 60-foot buffer.

The assessment and delineation of specific critical areas within and immediately adjacent to the project site followed the methods and procedures defined in the *Corps of Engineers Wetland Delineation Manual* (United States Army Corps of Engineers, 1987) with the *Regional Supplement to the Corps of Engineers Wetland Delineation Manual: Western Mountains, Valleys, and Coast Region* (United States Army Corps of Engineers, 2010); the Washington State *Wetland Rating System for Western Washington* (Hruby, 2014), the State of Washington Department of Natural Resources (WDNR) Forest Practice Rules (WAC 222-16-030), and the City of Puyallup Chapter 21. This document was designed to accommodate site planning and potential regulatory actions and is suitable for submittal to federal, state, and local authorities for potential critical areas verification and permitting actions.

## PROJECT SITE DESCRIPTION

The project site was composed of an existing vacant parcel of record totaling approximately 1.25-acres in size. As outlined below the majority of the project site was encumbered by wetland and wetland buffers. The project site was located within an area of increasing urbanization focusing on more intense commercial retail and higher intensity residential development. The southern boundary of the project site was formed by 43<sup>rd</sup> Avenue SW. A single-family homesite on a large parcel was noted to the west and vacant lands were present to the north and east.

**Directions to Project Site:** From Meridian Avenue East (southbound) turn west onto 43<sup>rd</sup> Avenue SW. Continue on 43<sup>rd</sup> Avenue SW to the project site at 433 - 43<sup>rd</sup> Avenue SW.



## **BACKGROUND INFORMATION**

### **NATIONAL WETLAND INVENTORY**

The *National Wetland Inventory (NWI) Mapping* completed by the U.S. Fish and Wildlife Service was reviewed as a part of this assessment (Figure 2). This mapping resource identified a wetland complex throughout the majority of the project site. This wetland was identified as palustrine, forested, seasonally flooded (PFOC); and palustrine, scrub-shrub, seasonally flooded (PSSC) within the project site.

### **STATE OF WASHINGTON PRIORITY HABITATS AND SPECIES**

The State of Washington *Priority Habitats and Species (PHS) Mapping* was reviewed as a part of this assessment (Figure 3). This mapping resource identified the same wetland areas within and adjacent to the project site as the *NWI Mapping* above.

### **STATE OF WASHINGTON DEPARTMENT OF FISH AND WILDLIFE**

The State of Washington Department of Fish and Wildlife (WDFW) *SalmonScape Mapping* was reviewed as a part of this assessment (Figure 4). This mapping resource did not identify any drainage corridors within or adjacent to the project site. This mapping resource did identify a pond generally adjacent to the eastern boundary in the central portion of the project site.

### **STATE OF WASHINGTON DEPARTMENT OF NATURAL RESOURCES**

The State of Washington Department of Natural Resources (WDNR) *Water Type Mapping* was reviewed as a part of this assessment (Figure 5). This mapping resource generally identified the same wetland noted in the NWI Mapping Resource above within the project site. This mapping resource further noted a pond adjacent to the eastern boundary as noted in the WDFW Mapping above. This mapping noted this pond as a Type F Water (fish-bearing).

### **CITY OF PUYALLUP MAPPING**

The *City of Puyallup Inventory Mapping* was reviewed as a part of this assessment (Figure 6). This mapping resource generally identified the wetland noted in the other mapping

resources above within the project site and adjacent properties. This wetland was further identified as “field verified” by the City of Puyallup.

## **SOILS MAPPING**

The *Soil Mapping Inventory* completed by the Natural Resources Conservation Service was reviewed as a part of this assessment (Figure 7). This mapping resource identified the soil throughout the majority of project site as Norma fine sandy loam (26A). The Norma soil series is defined as poorly drained; as formed in alluvium under sedges; and as listed as a “hydric” soil.

This mapping resource further noted the southern portion of the project site to contain Everett gravelly sandy loam (13B). The Everett soils series is defined as somewhat excessively drained, as formed in glacial outwash, and as not listed as “hydric” soil.

## **PRIOR ASSESSMENTS**

Habitat Technologies had completed prior assessments for parcels within the surrounding area of the project site. These prior assessments had identified a wetland complex within the area. This wetland complex was ditched along the western boundary then entered a culvert within the Willow Springs Apartment complex. This drainage continued through a series of ditch lines, pipes, and culverts to eventually enter a Pierce County Storm Pond adjacent to 89<sup>th</sup> Avenue Court East (Figure 8). This storm pond did not appear to exhibit an outflow.

# **ONSITE ANALYSIS**

## **CRITERIA FOR CRITICAL AREAS IDENTIFICATION**

The City of Puyallup defines “critical areas” to include wetlands, fish and wildlife habitat areas, critical aquifer recharge areas, geologically hazardous areas, and frequently flooded areas. The critical areas assessment reported in this document has been limited to address wetlands and fish and wildlife habitat areas.

**Wetlands:** Wetlands are transitional areas between aquatic and upland habitats. In general terms, wetlands are lands where the extent and duration of saturation with water is the primary factor determining the nature of soil development and the types of plant and animal communities living in the soil and on its surface (Cowardin, et al., 1979). Wetlands are generally defined within land use regulations as "areas that are inundated or saturated by surface or groundwater at a frequency and duration sufficient to support,

and that under normal circumstances do support, a prevalence of vegetation typically adapted for life in saturated soil conditions" (US Army Corps of Engineers 1987).

Wetlands exhibit three essential characteristics, all of which must be present for an area to meet the established criteria (United States Army Corps of Engineers, 1987 and United States Army Corps of Engineers, 2010). These essential characteristics are:

1. **Hydrophytic Vegetation:** The assemblage of macrophytes that occurs in areas where inundation or soil saturation is either permanent or of sufficient frequency and duration to influence plant occurrence. Hydrophytic vegetation is present when the plant community is dominated by species that require or can tolerate prolonged inundation or soil saturation during the growing season.
2. **Hydric Soil:** A soil that formed under conditions of saturation, flooding, or ponding long enough during the growing season to develop anaerobic conditions in the upper parts. Most hydric soils exhibit characteristic morphologies that result from recent periods of saturation or inundation. These processes result in distinctive characteristics that persist in the soil during both wet and dry periods.
3. **Wetland Hydrology:** Permanent or periodic inundation, or surface soil saturation, at least seasonally. Wetland hydrology indicators are used in combination with indicators of hydric soil and hydrophytic vegetation to define the area. Wetland hydrology indications provide evidence that the site has a continuing wetland hydrology regime. Where hydrology has not been altered vegetation and soils provide strong evidence that wetland hydrology is present.

**Fish and Wildlife Habitat Areas:** The City of Puyallup has defined "fish and wildlife habitat areas" to include those areas necessary for maintaining species in suitable habitats within their natural geographic distribution so that isolated subpopulations are not created as designated by WAC 365-190-080. These areas include:

- (a) Areas with which state or federally designated endangered, threatened, and sensitive species have a primary association;
- (b) Habitats of local importance, including but not limited to areas designated as priority habitat by the Department of Fish and Wildlife;
- (c) Streams and surface waters within the jurisdiction of the state of Washington; and
- (d) Land essential for preserving connections between habitats and open spaces.

## STUDY METHODS

Habitat Technologies completed a series of onsite assessments from May through early-September 2018 and again in the late spring and summer of both 2019 and 2020. In

addition, Habitat Technologies has completed similar critical areas assessments for the parcels associated with the project site as well as parcels located within the general area of the project site. The objective of this evaluation was to define and delineate potential critical areas (wetlands; drainage corridors; and fish and wildlife habitats) that may be present within or immediately adjacent to the project area. Onsite activities were completed in accordance with criteria and procedures established in the *Corps of Engineers Wetland Delineation Manual* (United States Army Corps of Engineers, 1987) with the *Regional Supplement to the Corps of Engineers Wetland Delineation Manual: Western Mountains, Valleys, and Coast Region* (United States Army Corps of Engineers, 2010); the *Washington State Wetland Rating System for Western Washington* (Hruby, 2014), the State of Washington Department of Natural Resources (WDNR) Forest Practice Rules (WAC 222-16-030), and the City of Puyallup Chapter 21.

## FIELD OBSERVATION

The project site was accessed via 43<sup>rd</sup> Avenue SW that formed the southern boundary of the project site. The southern portion of the project site appeared to contain a historic fill pad that was overgrown with blackberries and contained a small “tent city” during the onsite assessments period. The southern project site was also heavily littered with garbage and debris from the onsite campers. The majority of the central and northern portion of the project site was encumbered by a portion of a wetland complex within area parcels. Representative field data are provided in Appendix A.

- **Plant Communities**

As noted above the southern project site had been modified by the placement of historic fill and had become overrun with primarily Himalayan blackberry (*Rubus armeniacus*).

The plant community located directly to the north of the historic fill placement was dominated by species typically associated with seasonal saturation or seasonal shallow ponding. Observed species included black cottonwood (*Populus trichocarpa*), red alder (*Alnus rubra*), Western red cedar (*Thuja plicata*), Oregon ash (*Fraxinus latifolia*), Pacific willow (*Salix lasiandra*), Sitka willow (*Salix sitchensis*), crabapple (*Pyrus fusca*), Douglas spiraea (*Spiraea douglasii*), salmonberry (*Rubus spectabilis*), Himalayan blackberry (*Rubus armeniacus*), Pacific ninebark (*Physocarpus capitatus*), black twinberry (*Lonicera involucrata*), red osier dogwood (*Cornus stolonifera*), Nootka rose (*Rosa nutkana*), common lady fern (*Athyrium filix-femina*), deer fern (*Blechnum spicant*), maiden hair fern (*Adiantum pedatum*), cattail (*Typha latifolia*), skunk cabbage (*Lysichitum americanum*), small fruited bulrush (*Scirpus microcarpus*), slough sedge (*Carex obnupta*), water parsley (*Oenanthe sarmentosa*), speedwell (*Veronica scutellata*), buttercup (*Ranunculus repens*), curled dock (*Rumex crispus*), big leaf avens (*Geum macrophyllum*), reed canarygrass (*Phalaris arundinacea*), and reed mannagrass (*Glyceria grandis*). This plant community was identified as hydrophytic in character (i.e. typical of wetlands).

Along the western boundary the project site and adjacent parcel to the west a remnant upland forest community was noted. Observed species included Douglas fir (*Pseudotsuga menziesii*), Western red cedar (*Thuja plicata*), Western hemlock (*Tsuga heterophylla*), red alder (*Alnus rubra*), big leaf maple (*Acer macrophyllum*), cherry (*Prunus* spp.), Himalayan blackberry, evergreen blackberry (*Rubus laciniatus*), salal (*Gaultheria shallon*), Oregon grape (*Berberis nervosa*), holly (*Ilex aquifolium*), rose (*Rosa* spp.), Indian plum (*Oemleria cerasiformis*), Pacific red elderberry (*Sambucus racemosa*), salmonberry (*Rubus spectabilis*), Oceanspray (*Holodiscus discolor*), foam flower (*Tiarella trifoliata*), sword fern (*Polystichum munitum*), bracken fern (*Pteridium aquilium*), nettle (*Urtica dioica*), bluegrass (*Poa* spp.), daisy (*Bellis perennis*), clover (*Trifolium* spp.), bleeding heart (*Dicentra Formosa*), and buttercup. This plant community was identified as non-hydrophytic in character (i.e. typical of uplands).

- **Hydrology**

Onsite hydrology appeared to be the result of seasonal stormwater runoff from onsite, seasonal stormwater runoff from adjacent parcels and adjacent public roadways, and onsite soil characteristics. The southern portion (prior fill area) of the project site appeared to drain moderately well and did not exhibit field indicators typically associated with wetland hydrology.

The majority of the project site appeared to drain somewhat poorly to poorly. A portion of a wetland complex within the area dominated the area to the north of the southern prior fill area. As noted during prior assessments this wetland was ditched along the western boundary of the wetland offsite to the northwest. Seasonal hydrology from the wetland then entered a culvert within the Willow Springs apartment complex. This hydrology continued through a series of ditch lines, pipes, and culverts then eventually entered a Pierce County Storm Pond adjacent to 89<sup>th</sup> Avenue Court East.

- **Soils**

As noted above the project site had been modified by the historic prior placement of fill material in the southern portion of the project site. Within remnant upland areas the soil exhibited a gravelly sandy loam to gravelly loam texture and coloration typical of an Everett soil series. The surface soil typically exhibited a very dark grayish brown (10YR 3/2) coloration and a gravelly sandy loam to gravelly loam texture. The subsoil to a depth of approximately 20 inches also exhibited a dark brown (10YR 3/3) to brown (10YR 4/3) coloration, and gravelly sandy loam to gravelly loam texture. This soil was identified as non-hydric in character.

The soil identified throughout the majority of the project site exhibited a surface soil coloration of very dark grayish brown (10YR 3/2) to black (10YR 2/1). The subsoil varied

from black (10YR 2/1) to dark grayish brown (10YR 4/2) and exhibited prominent redoximorphic features (i.e. depleted matrix and redox concentrations). Oxidized root channels were also very evident. The soil ranged from gravelly loam, silt loam, to muck in texture. The soils within the majority of the project site exhibited field characteristics typical of hydric soil.

- **Fish and Wildlife**

Wildlife species observed or that would be reasonably expected to utilize the habitats provided within or adjacent to the project site would include red tailed hawk (*Buteo jamaicensis*), American crow (*Corvus brachynchos*), American robin (*Turdus migratorius*), black capped chickadee (*Parus atricapillus*), dark eyed junco (*Junco hyemalis*), rufous hummingbird (*Selasphorus rufus*), merlin (*Falco columbarius*), golden crowned sparrow (*Zonotrichia atricapilla*), mourning dove (*Zenaida macroura*), song sparrow (*Melospiza melodia*), white crowned sparrow (*Zonotrichia leucophrys*), house sparrow, house finch (*Carpodacus mexicanus*), starling (*Sturnus vulgaris*), American goldfinch (*Carduelis tristis*), purple finch (*Carpodacus purpureus*), violet green swallow (*Tachycineta thalassina*), tree swallow (*Tachycineta bicolor*), red winged blackbird (*Agelaius phoeniceus*), brewer blackbird (*Euphagus cyanocephalus*), marsh wren (*Cistothorus palustris*), great blue heron (*Ardea herodias*), common mallard (*Anas platyrhynchos*), Canada goose (*Branta canadensis*), northern flicker (*Colaptes auratus*), hairy woodpecker (*Picoides villosus*), black tailed deer (*Odocoileus hemionus*), raccoon (*Procyon lotor*), coyote (*Canis latrans*), striped skunk (*Mephitis mephitis*), opossum (*Didelphis virginianus*), deer mouse (*Peromyscus maniculatus*), shrew (*Sorex spp.*), Townsend mole (*Scapanus townsendii*), voles (*Microtus spp.*), Norway rat (*Rattus norvegicus*), bats (*Myotis spp.*), eastern gray squirrel (*Sciurus carolinensis*), common garter snake (*Thamnophis sirtalis*), Pacific treefrog (*Hyla regilla*), and red legged frog (*Rana aurora*). The project site was not evaluated for the presence or absences of fish species since all seasonal drainage enters an offsite storm pond that appears to fully infiltrate.

**Wildlife Movement Corridors:** The project site was within a well urbanized area. As identified by onsite wildlife trials, small and medium sized mammals appeared to be moving throughout vacant parcels generally to the east and southeast of the project site. The project site is also within the general area of the migratory movement of waterfowl and passerine birds.

**State Priority Species:** Several species identified by the State of Washington as "Priority Species" were observed onsite or potentially may utilize the project site. Priority species require protective measures for their survival due to their population status, sensitivity to habitat alteration, and/or recreational, commercial, or tribal importance.

**Game Species:** "Game species" are regulated by the State of Washington through recreational hunting bag limits, harvest seasons, and harvest area

restrictions. Observed, documented, or reasonably expected “game species” within and adjacent to the project site included black tailed deer, mourning dove, common mallard, and Canada goose.

**State Monitored:** State Monitored species are native to Washington but require habitat that has limited availability, are indicators of environmental quality, require further assessment, have unresolved taxonomy, may be competing with other species of concern, or have significant popular appeal. Observed, documented, or reasonably expected “State Monitored” species within and adjacent to the project site included great blue heron.

**State Candidate:** State Candidate species are presently under review by the State of Washington Department of Fish and Wildlife (WDFW) for possible listing as endangered, threatened, or sensitive. No State Candidate species were observed or have been documented to use the habitats associated with the project site.

**State Sensitive:** State Sensitive species are native to Washington and is vulnerable to declining and is likely to become endangered or threatened throughout a significant portion of its range without cooperative management or removal of threats. No State Sensitive species were observed or have been documented to use the habitats associated with the project site.

**State Threatened:** State Threatened species means any wildlife species native to the state of Washington that is likely to become an endangered species within the foreseeable future throughout a significant portion of its range within the state without cooperative management or removal of threats. The project site did not appear and has not been documented to provide direct critical habitats for State Listed Threatened species.

**State Endangered:** State endangered species means any species native to the state of Washington that is seriously threatened with extinction throughout all or a significant portion of its range within the state. The project site did not appear and has not been documented to provide direct critical habitats for State Listed Endangered species.

**Federally Listed Species:** No federally listed endangered or threatened species were observed or have been documented to utilize the habitats provided by the project site. A single, federally listed “species of concern” – bald eagle – has been documented to utilize the habitats generally associated with the area lakes, ponds and the Puyallup River Corridor. However, the project site did not provide critical habitats for this species. This species may occasionally overfly the project site.

## CRITICAL AREAS DETERMINATION

### WETLANDS

Wetland determination was based on observations of hydrophytic vegetation, hydric soils, and wetland hydrology in accordance with the *Corps of Engineers Wetland Delineation Manual* (United States Army Corps of Engineers, 1987) with the *Regional Supplement to the Corps of Engineers Wetland Delineation Manual: Western Mountains, Valleys, and Coast Region* (United States Army Corps of Engineers, 2010). Based on these methods one (1) wetland area was identified to be associated with a topographic swale that dominated the project site.

WETLAND	CLASSIFICATION (USFWS)	CITY OF PUYALLUP CATEGORY	WDOE RATING SCORE	WDOE HABITAT SCORE
A	PFOCd, PEMCd	III	18	5

**Wetland A:** Wetland A was identified throughout the majority of the project and to extend into adjacent parcels. Wetland A exhibited a mixed forest plant community within the project site. Offsite to the northwest this wetland exhibited an emergent plant community. Seasonal hydrology from the wetland entered a culvert within the Willow Springs apartment complex offsite to the northwest. This hydrology continued through a series of ditch lines, pipes, and culverts then eventually entered a Pierce County Stormwater Infiltration Pond adjacent to 89<sup>th</sup> Avenue Court East (Figure 8).

Wetland A met the U.S. Fish and Wildlife Service (USFWS) criteria for classification of palustrine, forested, seasonally flooded, ditched (PFOCd); and palustrine, emergent, seasonally flooded, ditched (PEMCd). Wetland A appeared to meet the criteria for designation as a City of Puyallup Category III Wetland and have an associated buffer of 60 feet for a moderate intensity land use. Wetland A achieved a total functions score of 18 points utilizing the Washington State Department of Ecology (WDOE) Wetland Rating Form for Western Washington (Hruby 2014) (Appendix B).

### FISH AND WILDLIFE HABITAT AREAS

No areas were identified, or have been documented, with which state or federally designated endangered, threatened, and sensitive species have a primary association. In addition, no lands essential for preserving connections between habitats and open species were identified or previously documented.

The City of Puyallup Category III Wetland identified within the project site appears to meet the designation as a WDFW "priority habitat" and would be subject to the jurisdiction of the State of Washington.



## SELECTED DEVELOPMENT ACTION

The *Selected Development Action* for the project site focuses on the future development of one duplex homesite within the project site (**Parcel 0419095003**). The development of this duplex would be completed without direct adverse impacts to the identified onsite City of Puyallup Category III Wetland or an encroachment into the associated standard wetland buffer (see Site Plan). A 10-foot building setback would also be established between the outer wetland buffer boundary and the proposed duplex.

## STANDARD OF CARE

This document has been completed by Habitat Technologies for use by **Mr. David Artz**. Prior to extensive site planning the findings documented in this document should be reviewed and verified by the City of Puyallup. Habitat Technologies has provided professional services that are in accordance with the degree of care and skill generally accepted in the nature of the work accomplished. No other warranties are expressed or implied. Habitat Technologies is not responsible for design costs incurred before this document is approved by the appropriate resource and permitting agencies.

*Bryan W. Peck*

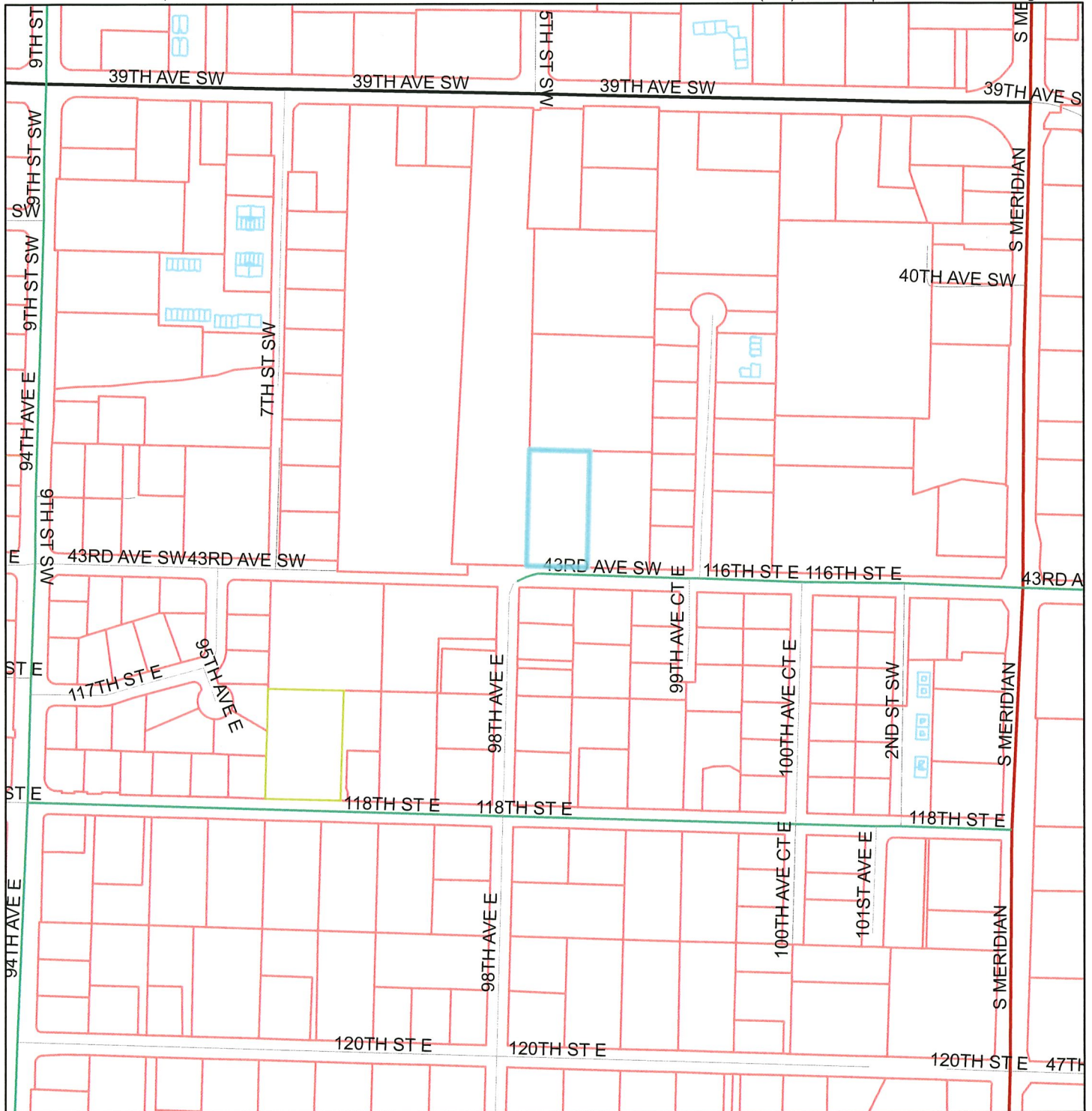
Bryan W. Peck  
Wetland Biologist

*Thomas D. Deming*

Thomas D. Deming, SPWS  
Habitat Technologies

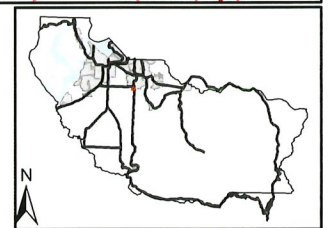
## FIGURES

# Figure 1 Site Vicinity

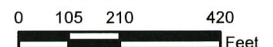


### Legend

- |                    |                    |                              |             |
|--------------------|--------------------|------------------------------|-------------|
| <b>Tax Parcels</b> | Other              | Highway Ramp                 | Major Road  |
| Base Parcel        | <b>Roads</b>       | Limited Access State Highway | Arterial    |
| Condominium        | Interstate Highway | Other State Highway          | Residential |
|                    |                    |                              | Unknown     |

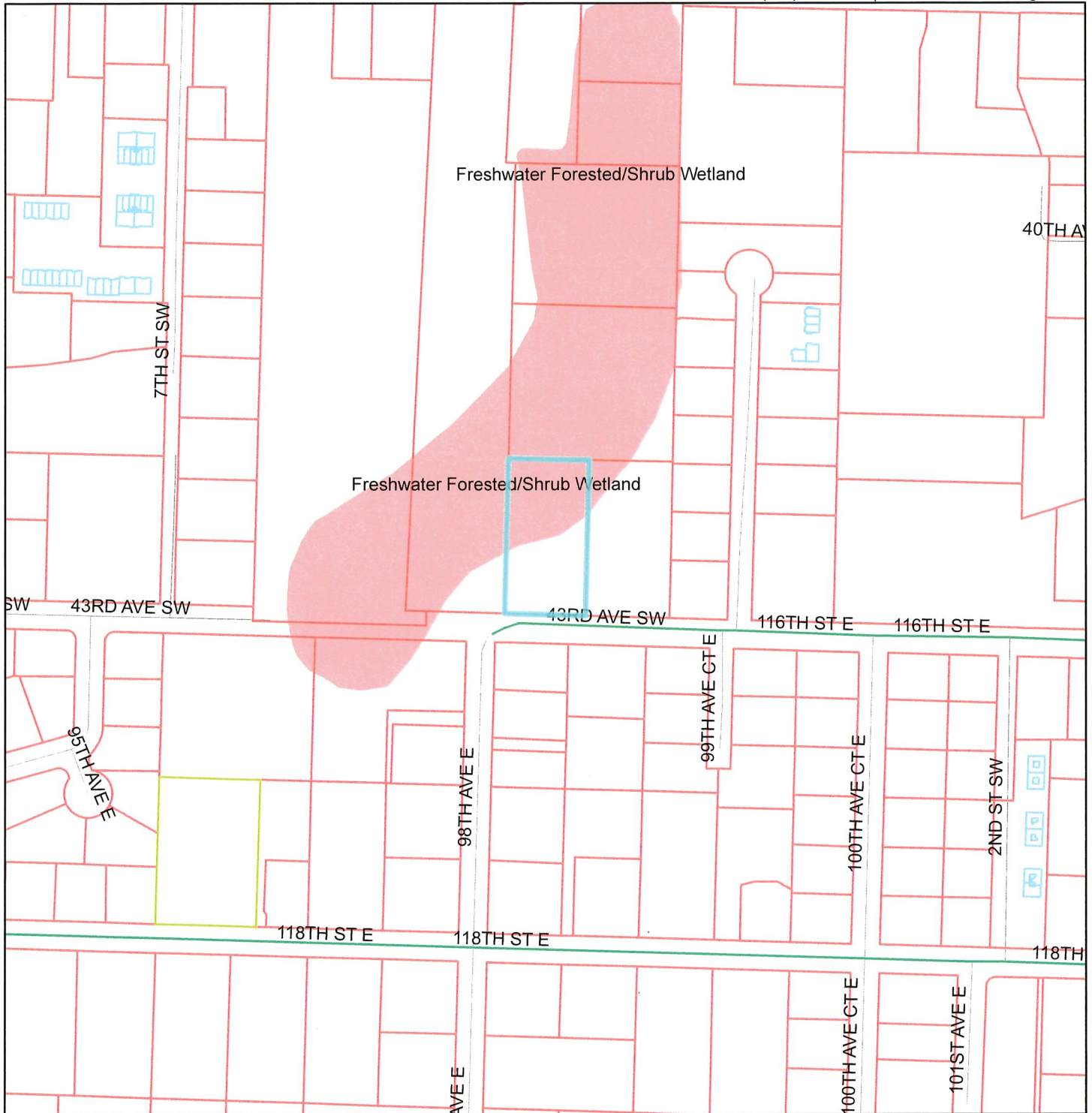


1:4,800



The map features are approximate and are intended only to provide an indication of said feature. Additional areas that have not been mapped may be present. This is not a survey. Orthophotos and other data may not align. The County assumes no liability for variations ascertained by actual survey. ALL DATA IS EXPRESSLY PROVIDED 'AS IS' AND 'WITH ALL FAULTS'. The County makes no warranty of fitness for a particular purpose.  
 Date: 1/6/2020 01:46 PM

# Figure 2 NWI Mapping

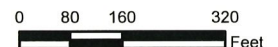


### Legend

- |                    |                      |                                |                               |
|--------------------|----------------------|--------------------------------|-------------------------------|
| <b>Tax Parcels</b> | <b>Roads</b>         | — Limited Access State Highway | — Residential                 |
| □ Base Parcel      | — Interstate Highway | — Other State Highway          | — Unknown                     |
| □ Condominium      | — Highway Ramp       | — Major Road                   | — National Wetlands Inventory |
| □ Other            |                      | — Arterial                     |                               |



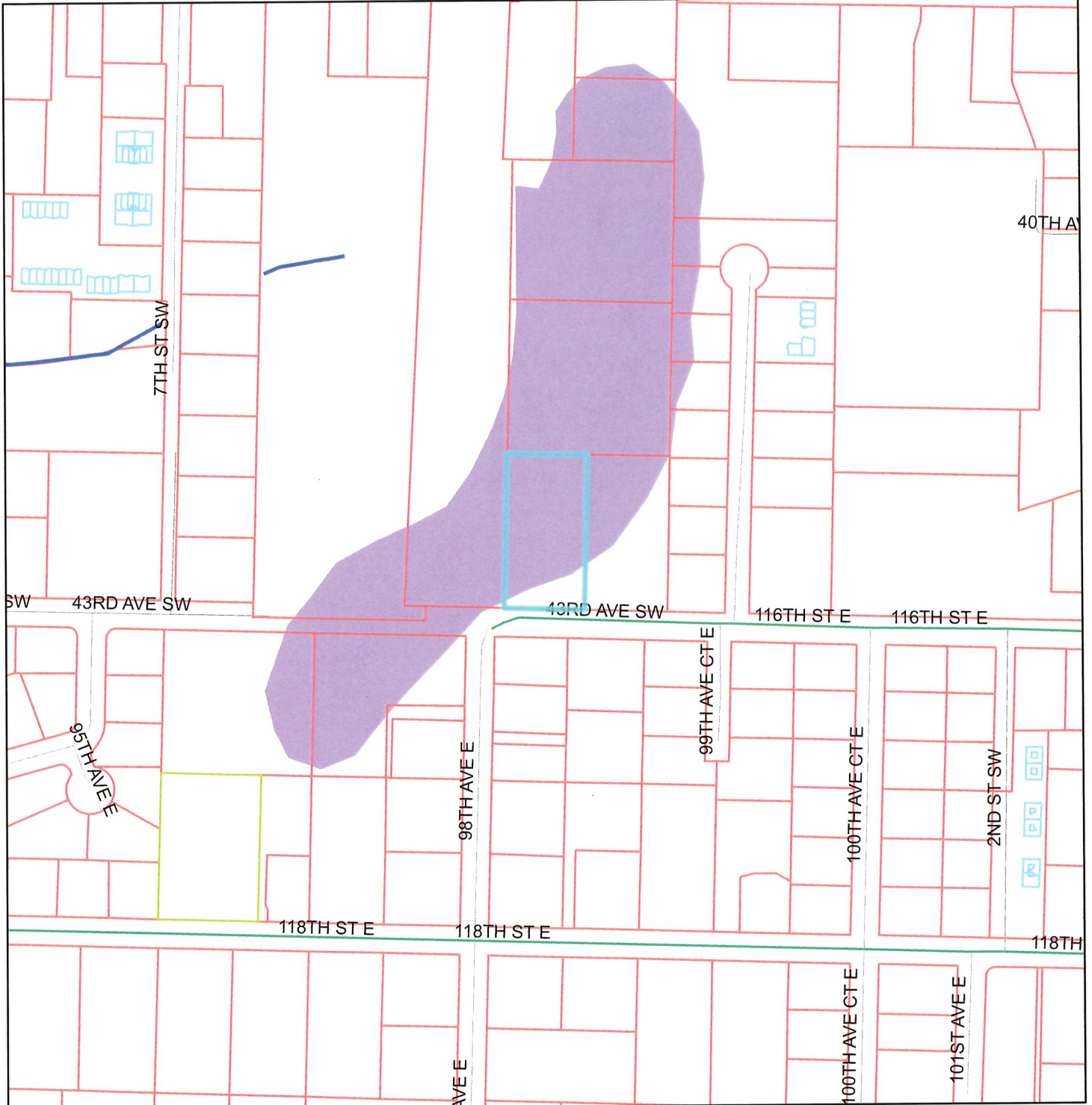
1:3,600



*The map features are approximate and are intended only to provide an indication of said feature. Additional areas that have not been mapped may be present. This is not a survey. Orthophotos and other data may not align. The County assumes no liability for variations ascertained by actual survey. ALL DATA IS EXPRESSLY PROVIDED 'AS IS' AND 'WITH ALL FAULTS'. The County makes no warranty of fitness for a particular purpose.*

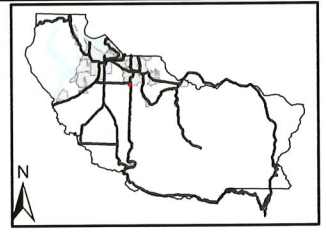


# Figure 3 PHS Mapping



### Legend

- |                    |                    |                              |                              |
|--------------------|--------------------|------------------------------|------------------------------|
| Streams - Puyallup | Other              | Limited Access State Highway | Residential                  |
| <b>Tax Parcels</b> | <b>Roads</b>       | Other State Highway          | Unknown                      |
| Base Parcel        | Interstate Highway | Major Road                   | Priority Habitat and Species |
| Condominium        | Highway Ramp       | Arterial                     |                              |

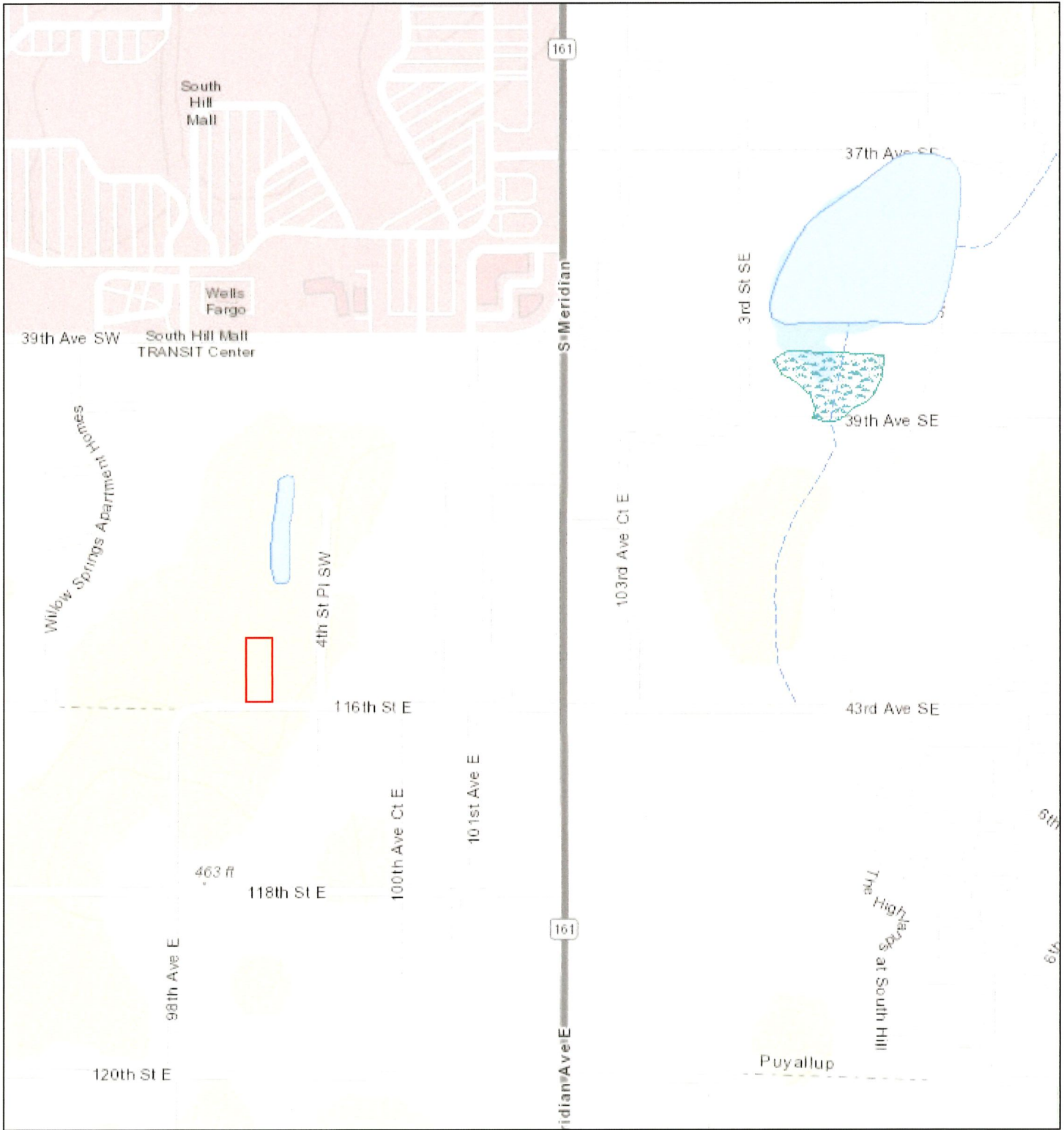


1:3,600



The map features are approximate and are intended only to provide an indication of said feature. Additional areas that have not been mapped may be present. This is not a survey. Orthophotos and other data may not align. The County assumes no liability for variations ascertained by actual survey. ALL DATA IS EXPRESSLY PROVIDED 'AS IS' AND 'WITH ALL FAULTS'. The County makes no warranty of fitness for a particular purpose. Date: 1/6/2020 01:43 PM

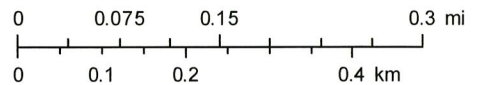
# Figure 4 WDFW Salmonscape Mapping



June 4, 2019

— All SalmonScape Species

1:9,028



USGS/NHD  
 Sources: Esri, HERE, Garmin, Intermap, increment P Corp., GEBCO, USGS, FAO, NPS, NRCAN, GeoBase, IGN, Kadaster NL, Ordnance Survey, Esri Japan, METI, Esri China (Hong Kong), (c) OpenStreetMap contributors, and the GIS User Community



# Figure 5 Forest Practice Water Type Map

S10 T19.0N R04.0E, S03 T19.0N R04.0E, S04 T19.0N R04.0E  
S09 T19.0N R04.0E

Application #: \_\_\_\_\_



Esri, HERE, Garmin, (c) OpenStreetMap contributors, and the GIS user community, Source: Esri, DigitalGlobe, GeoEye, Earthstar Geographics, CNES/Airbus, AeroGRID, IGN, and the GIS User Community

Date: 6/4/2019 Time: 3:20:46 PM

NAD 83 Scale: 1:4,800

Contour Interval: 10 Feet



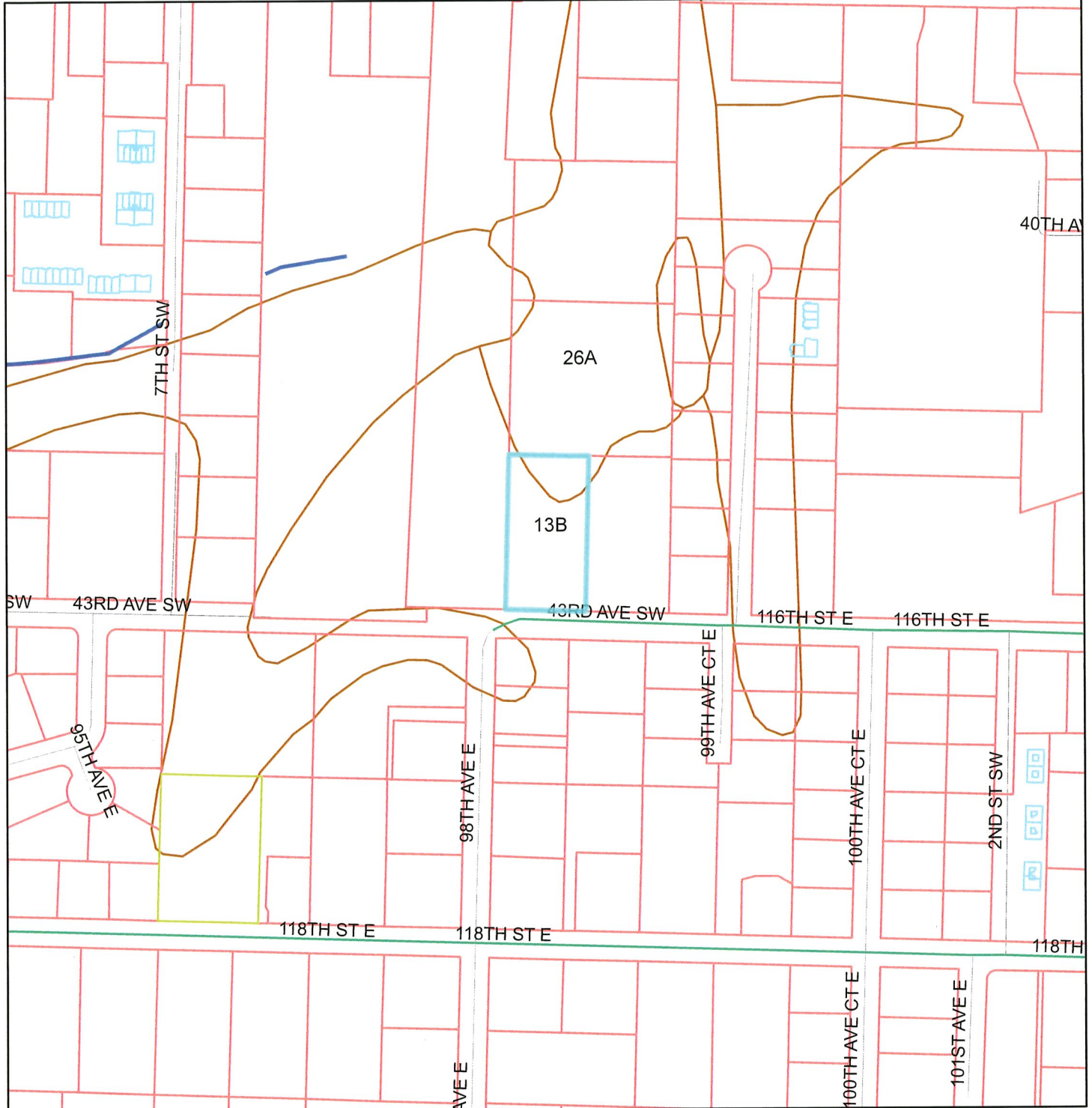




# Figure 7 Soils Mapping

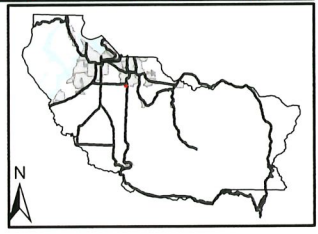
**Habitat Technologies**

P.O.Box 1088  
 Puyallup, WA 98371  
 (253) 845-5119 | www.habitattechnologies.net

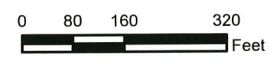


### Legend

- |                    |                    |                              |             |
|--------------------|--------------------|------------------------------|-------------|
| Streams - Puyallup | Other              | Limited Access State Highway | Residential |
| <b>Tax Parcels</b> | <b>Roads</b>       | Other State Highway          | Unknown     |
| Base Parcel        | Interstate Highway | Major Road                   | Soils       |
| Condominium        | Highway Ramp       | Arterial                     |             |



1:3,600

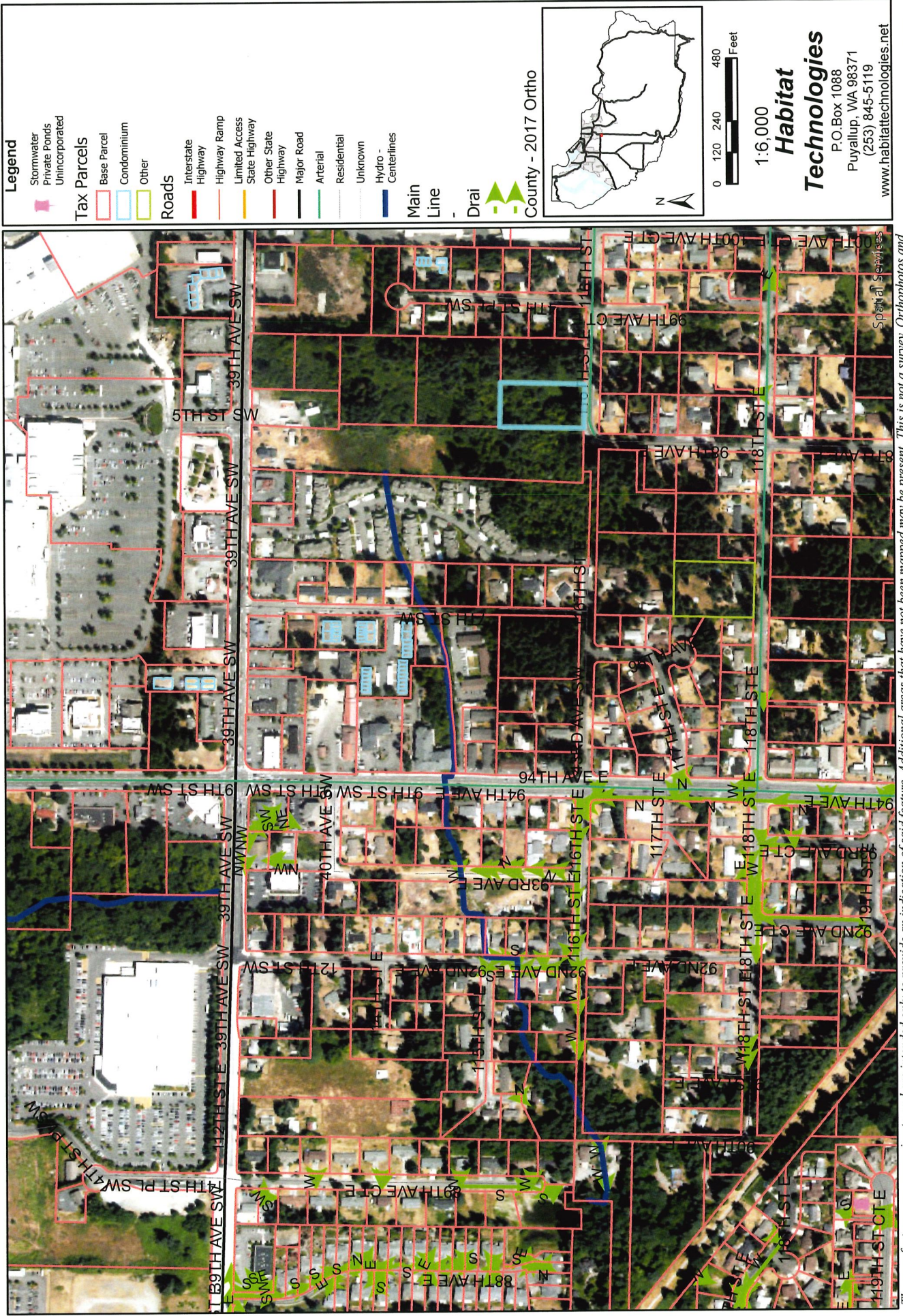


*The map features are approximate and are intended only to provide an indication of said feature. Additional areas that have not been mapped may be present. This is not a survey. Orthophotos and other data may not align. The County assumes no liability for variations ascertained by actual survey. ALL DATA IS EXPRESSLY PROVIDED 'AS IS' AND 'WITH ALL FAULTS'. The County makes no warranty of fitness for a particular purpose.*

Date: 1/6/2020 01:42 PM



Figure 8 Wetland Outlet



The map features are approximate and are intended only to provide an indication of said feature. Additional areas that have not been mapped may be present. This is not a survey. Orthophotos and other data may not align. The County assumes no liability for variations ascertained by actual survey. ALL DATA IS EXPRESSLY PROVIDED 'AS IS' AND 'WITH ALL FAULTS'. The County makes no warranty of fitness for a particular purpose.



## REFERENCE AND BACKGROUND LIST

- Adamus, P.R., E.J. Clairain Jr., R.D. Smith, and R.E. Young. 1987. Wetland Evaluation Technique (WET); Volume II: Methodology, Operational Draft Technical Report Y-87, U.S. Army Engineer Waterways Experiment Station, Vicksburg, Mississippi.
- Cowardin, Lewis M. et al, 1979. Classification of Wetlands and Deepwater Habitats of the United States. Office of Biological Services, U.S. Fish and Wildlife Service, U.S. Department of the Interior, FWS/OBS-79/31.
- Hitchcock, C.L., A. Cronquist. 1977. Flora of the Pacific Northwest. University of Washington Press. Seattle, Washington.
- Hruby, T. 2008. Washington State Wetland Rating System for Western Washington: 2008 Update. Publication #08-06-029. Olympia, WA: Washington Department of Ecology.
- Hruby, T. 2014. Washington State Wetland Rating System for Western Washington: 2014 Update. Publication #14-06-029. Olympia, WA: Washington Department of Ecology.
- Lichvar, R.W., D.L. Banks, W.N. Kirchner, and N.C. Melvin. 2016. The National Wetlands Plant List: 2016 wetland ratings. Phytoneuron 2016-30: 1-17. Published 28 April 2016. ISSN 2153 733X. <http://wetland-plands.usace.army.mil/>
- Reppert, R.T., W. Sigleo, E. Stakhiv, L. Messman, and C. Meyers. 1979. Wetland Values - Concepts and Methods for Wetland Evaluation. Research Report 79-R1, U.S. Army Corps of Engineers, Institute for Water Resources, Fort Belvoir, Virginia.
- United States Army Corps of Engineers, 1987. Wetlands Delineation Manual. Technical Report Y-87-1, US Army Engineer Waterways Experiment Station, Vicksburg, Mississippi. March 1987.
- United States Army Corps of Engineers. 2010. Regional Supplement to the Corps of Engineers Wetland Delineation Manual: Western Mountains, Valleys, and Coast Region (Version 2.0), Environmental Laboratory ERDC/EL TR-08-13.
- US Climate Data, 2015 <http://www.usclimatedata.com/climate/tacoma/washington/united-states/uswa0441/0441/2014/1>
- USDA Natural Resource Conservation Service Plants Database, 2015 (for hydrophytic plan classification): <http://plants.usda.gov/>
- United States Department of Agriculture, Natural Resources Conservation Service. Web Soil Survey. 2016 <http://vewsoilsurvey.nrcs.usda.gov/app/newfeatures.2.3.htm>.

US Fish and Wildlife Service National Wetland Inventory Mapper, 2016 (for NWI wetland mapping): <http://www.fws.gov/wetlands/Data/Mapper.html>.

Washington State Department of Ecology. 1997. Washington State Wetlands Identification and Delineation Manual. Publication Number 96-94.

Washington State Department of Fish and Wildlife Priority Habitats and Species Maps 2016 <http://wdfw.wa.gov/mapping/phs/>

Washington State Department of Fish and Wildlife SalmonScape Mapping System, 2016 (for fish presence): <http://apps.wdfw.wa.gov/salmonscape/map.html>

Washington State Department of Natural Resources FPARS Mapping System, 2016 (for stream typing): <http://fortess.wa.gov/dnr/app1/fpars/viewer.htm>

## APPENDIX A – Representative Field Data

**WETLAND DETERMINATION DATA FORM – Western Mountains, Valleys, and Coast Region**

Project/Site: Artz Parcels City/County: Puyallup / Pierce Sampling Date: 29 AUG 2018  
 Applicant/Owner: \_\_\_\_\_ State: Washington Sampling Point: SP-1  
 Investigator(s): Habitat Technologies Section, Township, Range: S09, T19, R04E  
 Landform (hillslope, terrace, etc.): \_\_\_\_\_ Local relief (concave, convex, none): \_\_\_\_\_ Slope (%): \_\_\_\_\_  
 Subregion (LRR): A Lat: \_\_\_\_\_ Long: \_\_\_\_\_ Datum: \_\_\_\_\_  
 Soil Map Unit Name: Everett very gravelly sandy loam NWI classification: \_\_\_\_\_

Are climatic / hydrologic conditions on the site typical for this time of year? Yes  No  (If no, explain in Remarks.)  
 Are Vegetation \_\_\_\_\_, Soil \_\_\_\_\_, or Hydrology \_\_\_\_\_ significantly disturbed? Are "Normal Circumstances" present? Yes  No   
 Are Vegetation \_\_\_\_\_, Soil \_\_\_\_\_, or Hydrology \_\_\_\_\_ naturally problematic? (If needed, explain any answers in Remarks.)

**SUMMARY OF FINDINGS – Attach site map showing sampling point locations, transects, important features, etc.**

Hydrophytic Vegetation Present? Yes <input checked="" type="checkbox"/> No <input type="checkbox"/> Hydric Soil Present? Yes <input checked="" type="checkbox"/> No <input type="checkbox"/> Wetland Hydrology Present? Yes <input checked="" type="checkbox"/> No <input type="checkbox"/>	Is the Sampled Area within a Wetland? Yes <input checked="" type="checkbox"/> No <input type="checkbox"/>
Remarks: Wetland	

**VEGETATION – Use scientific names of plants.**

	Absolute % Cover	Dominant Species?	Indicator Status		
<b>Tree Stratum</b> (Plot size: 15ft radius)					
1. <u>Populus trichocarpai</u>	30	YES	FAC	<b>Dominance Test worksheet:</b> Number of Dominant Species That Are OBL, FACW, or FAC: <u>6</u> (A)  Total Number of Dominant Species Across All Strata: <u>6</u> (B)  Percent of Dominant Species That Are OBL, FACW, or FAC: <u>100</u> (A/B)	
2. <u>Alnus rubra</u>	40	YES	FAC		
3. _____	_____	_____	_____		
4. _____	_____	_____	_____		
	70	= Total Cover		<b>Prevalence Index worksheet:</b> Total % Cover of: _____ Multiply by: OBL species _____ x 1 = _____ FACW species _____ x 2 = _____ FAC species _____ x 3 = _____ FACU species _____ x 4 = _____ UPL species _____ x 5 = _____ Column Totals: _____ (A) _____ (B)  Prevalence Index = B/A = _____	
<b>Sapling/Shrub Stratum</b> (Plot size: 15ft radius)					
1. <u>Lonicera involucrata</u>	30	YES	FAC		
2. <u>Rubus spectabilis</u>	25	YES	FAC		
3. <u>Spiraea douglasii</u>	15	YES	FACW		
4. _____	_____	_____	_____		
5. _____	_____	_____	_____	<b>Hydrophytic Vegetation Indicators:</b> <input type="checkbox"/> Rapid Test for Hydrophytic Vegetation <input checked="" type="checkbox"/> Dominance Test is >50% <input type="checkbox"/> Prevalence Index is ≤3.0 <sup>1</sup> <input type="checkbox"/> Morphological Adaptations <sup>1</sup> (Provide supporting data in Remarks or on a separate sheet) <input type="checkbox"/> Wetland Non-Vascular Plants <sup>1</sup> <input type="checkbox"/> Problematic Hydrophytic Vegetation <sup>1</sup> (Explain) <sup>1</sup> Indicators of hydric soil and wetland hydrology must be present, unless disturbed or problematic.	
	70	= Total Cover			
<b>Herb Stratum</b> (Plot size: 15ft radius)					
1. <u>Carex obnupta</u>	90	YES	OBL		
2. _____	_____	_____	_____		
3. _____	_____	_____	_____		
4. _____	_____	_____	_____		
5. _____	_____	_____	_____		
6. _____	_____	_____	_____		
7. _____	_____	_____	_____		
8. _____	_____	_____	_____		
9. _____	_____	_____	_____		
10. _____	_____	_____	_____		
11. _____	_____	_____	_____		
	90	= Total Cover			
<b>Woody Vine Stratum</b> (Plot size: 15ft radius)					
1. _____	_____	_____	_____	<b>Hydrophytic Vegetation Present?</b> Yes <input checked="" type="checkbox"/> No <input type="checkbox"/>	
2. _____	_____	_____	_____		
	0	= Total Cover			
<b>% Bare Ground in Herb Stratum</b> <u>0</u>					

Remarks:

**SOIL**

Sampling Point: SP-1

**Profile Description: (Describe to the depth needed to document the indicator or confirm the absence of indicators.)**

Depth (inches)	Matrix		Redox Features			Loc <sup>2</sup>	Texture	Remarks
	Color (moist)	%	Color (moist)	%	Type <sup>1</sup>			
0-18	10YR 3/1	100					L	

<sup>1</sup>Type: C=Concentration, D=Depletion, RM=Reduced Matrix, CS=Covered or Coated Sand Grains.      <sup>2</sup>Location: PL=Pore Lining, M=Matrix.

**Hydric Soil Indicators: (Applicable to all LRRs, unless otherwise noted.)**

<input type="checkbox"/> Histosol (A1)	<input type="checkbox"/> Sandy Redox (S5)	<b>Indicators for Problematic Hydric Soils<sup>3</sup>:</b> <input type="checkbox"/> 2 cm Muck (A10) <input type="checkbox"/> Red Parent Material (TF2) <input type="checkbox"/> Very Shallow Dark Surface (TF12) <input type="checkbox"/> Other (Explain in Remarks)
<input type="checkbox"/> Histic Epipedon (A2)	<input type="checkbox"/> Stripped Matrix (S6)	
<input type="checkbox"/> Black Histic (A3)	<input type="checkbox"/> Loamy Mucky Mineral (F1) (except MLRA 1)	
<input type="checkbox"/> Hydrogen Sulfide (A4)	<input type="checkbox"/> Loamy Gleyed Matrix (F2)	
<input type="checkbox"/> Depleted Below Dark Surface (A11)	<input type="checkbox"/> Depleted Matrix (F3)	
<input checked="" type="checkbox"/> Thick Dark Surface (A12)	<input type="checkbox"/> Redox Dark Surface (F6)	
<input type="checkbox"/> Sandy Mucky Mineral (S1)	<input type="checkbox"/> Depleted Dark Surface (F7)	
<input type="checkbox"/> Sandy Gleyed Matrix (S4)	<input type="checkbox"/> Redox Depressions (F8)	

<sup>3</sup>Indicators of hydrophytic vegetation and wetland hydrology must be present, unless disturbed or problematic.

**Restrictive Layer (if present):**  
Type: \_\_\_\_\_  
Depth (inches): \_\_\_\_\_

**Hydric Soil Present?** Yes  No

Remarks:

**HYDROLOGY**

**Wetland Hydrology Indicators:**

<b>Primary Indicators (minimum of one required; check all that apply)</b>		<b>Secondary Indicators (2 or more required)</b>
<input type="checkbox"/> Surface Water (A1)	<input checked="" type="checkbox"/> Water-Stained Leaves (B9) (except MLRA 1, 2, 4A, and 4B)	<input checked="" type="checkbox"/> Water-Stained Leaves (B9) (MLRA 1, 2, 4A, and 4B)
<input type="checkbox"/> High Water Table (A2)	<input type="checkbox"/> Salt Crust (B11)	<input type="checkbox"/> Drainage Patterns (B10)
<input checked="" type="checkbox"/> Saturation (A3)	<input type="checkbox"/> Aquatic Invertebrates (B13)	<input type="checkbox"/> Dry-Season Water Table (C2)
<input checked="" type="checkbox"/> Water Marks (B1)	<input type="checkbox"/> Hydrogen Sulfide Odor (C1)	<input type="checkbox"/> Saturation Visible on Aerial Imagery (C9)
<input type="checkbox"/> Sediment Deposits (B2)	<input type="checkbox"/> Oxidized Rhizospheres along Living Roots (C3)	<input type="checkbox"/> Geomorphic Position (D2)
<input type="checkbox"/> Drift Deposits (B3)	<input type="checkbox"/> Presence of Reduced Iron (C4)	<input type="checkbox"/> Shallow Aquitard (D3)
<input type="checkbox"/> Algal Mat or Crust (B4)	<input type="checkbox"/> Recent Iron Reduction in Tilled Soils (C6)	<input type="checkbox"/> FAC-Neutral Test (D5)
<input type="checkbox"/> Iron Deposits (B5)	<input type="checkbox"/> Stunted or Stressed Plants (D1) (LRR A)	<input type="checkbox"/> Raised Ant Mounds (D6) (LRR A)
<input checked="" type="checkbox"/> Surface Soil Cracks (B6)	<input type="checkbox"/> Other (Explain in Remarks)	<input type="checkbox"/> Frost-Heave Hummocks (D7)
<input type="checkbox"/> Inundation Visible on Aerial Imagery (B7)		
<input checked="" type="checkbox"/> Sparsely Vegetated Concave Surface (B8)		

**Field Observations:**

Surface Water Present?	Yes <input type="checkbox"/> No <input checked="" type="checkbox"/>	Depth (inches): _____	<b>Wetland Hydrology Present?</b> Yes <input checked="" type="checkbox"/> No <input type="checkbox"/>
Water Table Present?	Yes <input type="checkbox"/> No <input checked="" type="checkbox"/>	Depth (inches): _____	
Saturation Present? (includes capillary fringe)	Yes <input checked="" type="checkbox"/> No <input type="checkbox"/>	Depth (inches): 0	
Describe Recorded Data (stream gauge, monitoring well, aerial photos, previous inspections), if available:			

Remarks:

**WETLAND DETERMINATION DATA FORM – Western Mountains, Valleys, and Coast Region**

Project/Site: Artz Parcels City/County: Puyallup / Pierce Sampling Date: 29 AUG 2018  
 Applicant/Owner: \_\_\_\_\_ State: Washington Sampling Point: SP-2  
 Investigator(s): Habitat Technologies Section, Township, Range: S09, T19, R04E  
 Landform (hillslope, terrace, etc.): \_\_\_\_\_ Local relief (concave, convex, none): \_\_\_\_\_ Slope (%): \_\_\_\_\_  
 Subregion (LRR): A Lat: \_\_\_\_\_ Long: \_\_\_\_\_ Datum: \_\_\_\_\_  
 Soil Map Unit Name: Everett very gravelly sandy loam NWI classification: \_\_\_\_\_

Are climatic / hydrologic conditions on the site typical for this time of year? Yes  No  (If no, explain in Remarks.)  
 Are Vegetation \_\_\_\_\_, Soil \_\_\_\_\_, or Hydrology \_\_\_\_\_ significantly disturbed? Are "Normal Circumstances" present? Yes  No   
 Are Vegetation \_\_\_\_\_, Soil \_\_\_\_\_, or Hydrology \_\_\_\_\_ naturally problematic? (If needed, explain any answers in Remarks.)

**SUMMARY OF FINDINGS – Attach site map showing sampling point locations, transects, important features, etc.**

Hydrophytic Vegetation Present? Yes <input type="checkbox"/> No <input checked="" type="checkbox"/> Hydric Soil Present? Yes <input type="checkbox"/> No <input checked="" type="checkbox"/> Wetland Hydrology Present? Yes <input type="checkbox"/> No <input checked="" type="checkbox"/>	Is the Sampled Area within a Wetland? Yes <input type="checkbox"/> No <input checked="" type="checkbox"/>
Remarks: Upland	

**VEGETATION – Use scientific names of plants.**

<u>Tree Stratum</u> (Plot size: <u>15ft radius</u> )	Absolute % Cover	Dominant Species?	Indicator Status	<b>Dominance Test worksheet:</b>
1. <u>Pseudotsuga menziesii</u>	<u>40</u>	<u>YES</u>	<u>FACU</u>	Number of Dominant Species That Are OBL, FACW, or FAC: <u>2</u> (A)  Total Number of Dominant Species Across All Strata: <u>6</u> (B)  Percent of Dominant Species That Are OBL, FACW, or FAC: <u>33</u> (A/B)
2. <u>Alnus rubra</u>	<u>20</u>	<u>YES</u>	<u>FAC</u>	
3. _____	_____	_____	_____	
4. _____	_____	_____	_____	
	<u>60</u>	= Total Cover		<b>Prevalence Index worksheet:</b> Total % Cover of: _____ Multiply by: OBL species _____ x 1 = _____ FACW species _____ x 2 = _____ FAC species _____ x 3 = _____ FACU species _____ x 4 = _____ UPL species _____ x 5 = _____ Column Totals: _____ (A) _____ (B)  Prevalence Index = B/A = _____
<u>Sapling/Shrub Stratum</u> (Plot size: <u>15ft radius</u> )				
1. <u>Alnus rubra</u>	<u>40</u>	<u>YES</u>	<u>FACU</u>	
2. <u>Gaultheria shallon</u>	<u>10</u>	<u>YES</u>	<u>FACU</u>	
3. <u>Rubus spectabilis</u>	<u>30</u>	<u>YES</u>	<u>FAC</u>	
4. _____	_____	_____	_____	
5. _____	_____	_____	_____	
	<u>80</u>	= Total Cover		
<u>Herb Stratum</u> (Plot size: <u>15ft radius</u> )				
1. <u>Polystichum munitum</u>	<u>30</u>	<u>YES</u>	<u>FACU</u>	<b>Hydrophytic Vegetation Indicators:</b> <input type="checkbox"/> Rapid Test for Hydrophytic Vegetation <input type="checkbox"/> Dominance Test is >50% <input type="checkbox"/> Prevalence Index is ≤3.0 <sup>1</sup> <input type="checkbox"/> Morphological Adaptations <sup>1</sup> (Provide supporting data in Remarks or on a separate sheet) <input type="checkbox"/> Wetland Non-Vascular Plants <sup>1</sup> <input type="checkbox"/> Problematic Hydrophytic Vegetation <sup>1</sup> (Explain) <sup>1</sup> Indicators of hydric soil and wetland hydrology must be present, unless disturbed or problematic.
2. _____	_____	_____	_____	
3. _____	_____	_____	_____	
4. _____	_____	_____	_____	
5. _____	_____	_____	_____	
6. _____	_____	_____	_____	
7. _____	_____	_____	_____	
8. _____	_____	_____	_____	
9. _____	_____	_____	_____	
10. _____	_____	_____	_____	
11. _____	_____	_____	_____	
	<u>30</u>	= Total Cover		
<u>Woody Vine Stratum</u> (Plot size: <u>15ft radius</u> )				
1. _____	_____	_____	_____	
2. _____	_____	_____	_____	
	<u>0</u>	= Total Cover		
<u>% Bare Ground in Herb Stratum</u> <u>0</u>				

Remarks: \_\_\_\_\_



**SOIL**

Sampling Point: SP-2

Profile Description: (Describe to the depth needed to document the indicator or confirm the absence of indicators.)							
Depth (inches)	Matrix		Redox Features			Texture	Remarks
	Color (moist)	%	Color (moist)	%	Type <sup>1</sup>		
0-10	10YR 3/2	100				GSL	
10-18	10YR-4/3	100				GSL	

<sup>1</sup>Type: C=Concentration, D=Depletion, RM=Reduced Matrix, CS=Covered or Coated Sand Grains.      <sup>2</sup>Location: PL=Pore Lining, M=Matrix.

<b>Hydric Soil Indicators: (Applicable to all LRRs, unless otherwise noted.)</b> <input type="checkbox"/> Histosol (A1) <input type="checkbox"/> Histic Epipedon (A2) <input type="checkbox"/> Black Histic (A3) <input type="checkbox"/> Hydrogen Sulfide (A4) <input type="checkbox"/> Depleted Below Dark Surface (A11) <input type="checkbox"/> Thick Dark Surface (A12) <input type="checkbox"/> Sandy Mucky Mineral (S1) <input type="checkbox"/> Sandy Gleyed Matrix (S4)	<input type="checkbox"/> Sandy Redox (S5) <input type="checkbox"/> Stripped Matrix (S6) <input type="checkbox"/> Loamy Mucky Mineral (F1) (except MLRA 1) <input type="checkbox"/> Loamy Gleyed Matrix (F2) <input type="checkbox"/> Depleted Matrix (F3) <input type="checkbox"/> Redox Dark Surface (F6) <input type="checkbox"/> Depleted Dark Surface (F7) <input type="checkbox"/> Redox Depressions (F8)	<b>Indicators for Problematic Hydric Soils<sup>3</sup>:</b> <input type="checkbox"/> 2 cm Muck (A10) <input type="checkbox"/> Red Parent Material (TF2) <input type="checkbox"/> Very Shallow Dark Surface (TF12) <input type="checkbox"/> Other (Explain in Remarks)
--	---	---

<sup>3</sup>Indicators of hydrophytic vegetation and wetland hydrology must be present, unless disturbed or problematic.

<b>Restrictive Layer (if present):</b> Type: _____ Depth (inches): _____	<b>Hydric Soil Present?</b> Yes <input type="checkbox"/> No <input checked="" type="checkbox"/>
--	---

Remarks:

**HYDROLOGY**

<b>Wetland Hydrology Indicators:</b> Primary Indicators (minimum of one required; check all that apply)			Secondary Indicators (2 or more required)		
<input type="checkbox"/> Surface Water (A1)	<input type="checkbox"/> High Water Table (A2)	<input type="checkbox"/> Saturation (A3)	<input type="checkbox"/> Water-Stained Leaves (B9) (except MLRA 1, 2, 4A, and 4B)	<input type="checkbox"/> Salt Crust (B11)	<input checked="" type="checkbox"/> Water-Stained Leaves (B9) (MLRA 1, 2, 4A, and 4B)
<input type="checkbox"/> Water Marks (B1)	<input type="checkbox"/> Sediment Deposits (B2)	<input type="checkbox"/> Drift Deposits (B3)	<input type="checkbox"/> Aquatic Invertebrates (B13)	<input type="checkbox"/> Aquatic Invertebrates (B13)	<input type="checkbox"/> Drainage Patterns (B10)
<input type="checkbox"/> Algal Mat or Crust (B4)	<input type="checkbox"/> Iron Deposits (B5)	<input type="checkbox"/> Surface Soil Cracks (B6)	<input type="checkbox"/> Hydrogen Sulfide Odor (C1)	<input type="checkbox"/> Oxidized Rhizospheres along Living Roots (C3)	<input type="checkbox"/> Dry-Season Water Table (C2)
<input type="checkbox"/> Inundation Visible on Aerial Imagery (B7)	<input type="checkbox"/> Sparsely Vegetated Concave Surface (B8)		<input type="checkbox"/> Presence of Reduced Iron (C4)	<input type="checkbox"/> Recent Iron Reduction in Tilled Soils (C6)	<input type="checkbox"/> Saturation Visible on Aerial Imagery (C9)
			<input type="checkbox"/> Stunted or Stressed Plants (D1) (LRR A)	<input type="checkbox"/> Other (Explain in Remarks)	<input type="checkbox"/> Geomorphic Position (D2)
					<input type="checkbox"/> Shallow Aquitard (D3)
					<input type="checkbox"/> FAC-Neutral Test (D5)
					<input type="checkbox"/> Raised Ant Mounds (D6) (LRR A)
					<input type="checkbox"/> Frost-Heave Hummocks (D7)

<b>Field Observations:</b> Surface Water Present?    Yes <input type="checkbox"/> No <input checked="" type="checkbox"/> Depth (inches): _____ Water Table Present?      Yes <input type="checkbox"/> No <input checked="" type="checkbox"/> Depth (inches): _____ Saturation Present?        Yes <input type="checkbox"/> No <input checked="" type="checkbox"/> Depth (inches): _____ (includes capillary fringe)	<b>Wetland Hydrology Present?</b> Yes <input type="checkbox"/> No <input checked="" type="checkbox"/>
---	---

Describe Recorded Data (stream gauge, monitoring well, aerial photos, previous inspections), if available:

Remarks:

## WETLAND DETERMINATION DATA FORM – Western Mountains, Valleys, and Coast Region

Project/Site: Artz Parcels City/County: Puyallup / Pierce Sampling Date: 29 AUG 2018  
 Applicant/Owner: \_\_\_\_\_ State: Washington Sampling Point: SP-3  
 Investigator(s): Habitat Technologies Section, Township, Range: S09, T19, R04E  
 Landform (hillslope, terrace, etc.): \_\_\_\_\_ Local relief (concave, convex, none): \_\_\_\_\_ Slope (%): \_\_\_\_\_  
 Subregion (LRR): A Lat: \_\_\_\_\_ Long: \_\_\_\_\_ Datum: \_\_\_\_\_  
 Soil Map Unit Name: Everett very gravelly sandy loam NWI classification: \_\_\_\_\_

Are climatic / hydrologic conditions on the site typical for this time of year? Yes  No  (If no, explain in Remarks.)  
 Are Vegetation \_\_\_\_\_, Soil \_\_\_\_\_, or Hydrology \_\_\_\_\_ significantly disturbed? Are "Normal Circumstances" present? Yes  No   
 Are Vegetation \_\_\_\_\_, Soil \_\_\_\_\_, or Hydrology \_\_\_\_\_ naturally problematic? (If needed, explain any answers in Remarks.)

### SUMMARY OF FINDINGS – Attach site map showing sampling point locations, transects, important features, etc.

Hydrophytic Vegetation Present? Yes <input type="checkbox"/> No <input checked="" type="checkbox"/> Hydric Soil Present? Yes <input type="checkbox"/> No <input checked="" type="checkbox"/> Wetland Hydrology Present? Yes <input type="checkbox"/> No <input checked="" type="checkbox"/>	Is the Sampled Area within a Wetland? Yes <input type="checkbox"/> No <input checked="" type="checkbox"/>
Remarks: Upland	

### VEGETATION – Use scientific names of plants.

<u>Tree Stratum</u> (Plot size: <u>15ft radius</u> )	Absolute % Cover	Dominant Species?	Indicator Status	<b>Dominance Test worksheet:</b>
1. <u>Pseudotsuga menziesii</u>	<u>60</u>	<u>YES</u>	<u>FACU</u>	Number of Dominant Species That Are OBL, FACW, or FAC: <u>1</u> (A)
2. _____	_____	_____	_____	Total Number of Dominant Species Across All Strata: <u>6</u> (B)
3. _____	_____	_____	_____	Percent of Dominant Species That Are OBL, FACW, or FAC: <u>17</u> (A/B)
4. _____	_____	_____	_____	
	<u>60</u>	= Total Cover		
<u>Sapling/Shrub Stratum</u> (Plot size: <u>15ft radius</u> )	Absolute % Cover	Dominant Species?	Indicator Status	<b>Prevalence Index worksheet:</b>
1. <u>Acer circinatum</u>	<u>30</u>	<u>YES</u>	<u>FAC</u>	Total % Cover of: _____ Multiply by:
2. <u>Corylus cornuta</u>	<u>30</u>	<u>YES</u>	<u>FACU</u>	OBL species _____ x 1 = _____
3. <u>Cornus stolonifera</u>	<u>30</u>	<u>YES</u>	<u>FACU</u>	FACW species _____ x 2 = _____
4. <u>Kalmia latifolia</u>	<u>10</u>	<u>YES</u>	<u>FACU</u>	FAC species _____ x 3 = _____
5. _____	_____	_____	_____	FACU species _____ x 4 = _____
	<u>100</u>	= Total Cover		UPL species _____ x 5 = _____
				Column Totals: _____ (A) _____ (B)
				Prevalence Index = B/A = _____
<u>Herb Stratum</u> (Plot size: <u>15ft radius</u> )	Absolute % Cover	Dominant Species?	Indicator Status	<b>Hydrophytic Vegetation Indicators:</b>
1. <u>Hedera Helix</u>	<u>75</u>	<u>YES</u>	<u>FACU</u>	<input type="checkbox"/> Rapid Test for Hydrophytic Vegetation
2. _____	_____	_____	_____	<input type="checkbox"/> Dominance Test is >50%
3. _____	_____	_____	_____	<input type="checkbox"/> Prevalence Index is ≤3.0 <sup>1</sup>
4. _____	_____	_____	_____	<input type="checkbox"/> Morphological Adaptations <sup>1</sup> (Provide supporting data in Remarks or on a separate sheet)
5. _____	_____	_____	_____	<input type="checkbox"/> Wetland Non-Vascular Plants <sup>1</sup>
6. _____	_____	_____	_____	<input type="checkbox"/> Problematic Hydrophytic Vegetation <sup>1</sup> (Explain)
7. _____	_____	_____	_____	<sup>1</sup> Indicators of hydric soil and wetland hydrology must be present, unless disturbed or problematic.
8. _____	_____	_____	_____	
9. _____	_____	_____	_____	
10. _____	_____	_____	_____	
11. _____	_____	_____	_____	
	<u>75</u>	= Total Cover		
<u>Woody Vine Stratum</u> (Plot size: <u>15ft radius</u> )	Absolute % Cover	Dominant Species?	Indicator Status	<b>Hydrophytic Vegetation Present?</b>
1. _____	_____	_____	_____	Yes <input type="checkbox"/> No <input checked="" type="checkbox"/>
2. _____	_____	_____	_____	
	<u>0</u>	= Total Cover		
% Bare Ground in Herb Stratum <u>0</u>				
Remarks:				

**SOIL**

Sampling Point: SP-3

Profile Description: (Describe to the depth needed to document the indicator or confirm the absence of indicators.)								
Depth (inches)	Matrix		Redox Features			Loc <sup>2</sup>	Texture	Remarks
	Color (moist)	%	Color (moist)	%	Type <sup>1</sup>			
0-18	10YR 4/3	100					GSL	

<sup>1</sup>Type: C=Concentration, D=Depletion, RM=Reduced Matrix, CS=Covered or Coated Sand Grains. <sup>2</sup>Location: PL=Pore Lining, M=Matrix.

<b>Hydric Soil Indicators: (Applicable to all LRRs, unless otherwise noted.)</b> <input type="checkbox"/> Histosol (A1) <input type="checkbox"/> Histic Epipedon (A2) <input type="checkbox"/> Black Histic (A3) <input type="checkbox"/> Hydrogen Sulfide (A4) <input type="checkbox"/> Depleted Below Dark Surface (A11) <input type="checkbox"/> Thick Dark Surface (A12) <input type="checkbox"/> Sandy Mucky Mineral (S1) <input type="checkbox"/> Sandy Gleyed Matrix (S4)	<input type="checkbox"/> Sandy Redox (S5) <input type="checkbox"/> Stripped Matrix (S6) <input type="checkbox"/> Loamy Mucky Mineral (F1) (except MLRA 1) <input type="checkbox"/> Loamy Gleyed Matrix (F2) <input type="checkbox"/> Depleted Matrix (F3) <input type="checkbox"/> Redox Dark Surface (F6) <input type="checkbox"/> Depleted Dark Surface (F7) <input type="checkbox"/> Redox Depressions (F8)	<b>Indicators for Problematic Hydric Soils<sup>3</sup>:</b> <input type="checkbox"/> 2 cm Muck (A10) <input type="checkbox"/> Red Parent Material (TF2) <input type="checkbox"/> Very Shallow Dark Surface (TF12) <input type="checkbox"/> Other (Explain in Remarks)
--	---	---

<sup>3</sup>Indicators of hydrophytic vegetation and wetland hydrology must be present, unless disturbed or problematic.

<b>Restrictive Layer (if present):</b> Type: _____ Depth (inches): _____	<b>Hydric Soil Present?</b> Yes <input type="checkbox"/> No <input checked="" type="checkbox"/>
--	---

Remarks: \_\_\_\_\_

**HYDROLOGY**

<b>Wetland Hydrology Indicators:</b> <u>Primary Indicators (minimum of one required; check all that apply)</u>		<u>Secondary Indicators (2 or more required)</u>	
<input type="checkbox"/> Surface Water (A1) <input type="checkbox"/> High Water Table (A2) <input type="checkbox"/> Saturation (A3) <input type="checkbox"/> Water Marks (B1) <input type="checkbox"/> Sediment Deposits (B2) <input type="checkbox"/> Drift Deposits (B3) <input type="checkbox"/> Algal Mat or Crust (B4) <input type="checkbox"/> Iron Deposits (B5) <input type="checkbox"/> Surface Soil Cracks (B6) <input type="checkbox"/> Inundation Visible on Aerial Imagery (B7) <input type="checkbox"/> Sparsely Vegetated Concave Surface (B8)	<input type="checkbox"/> Water-Stained Leaves (B9) (except MLRA 1, 2, 4A, and 4B) <input type="checkbox"/> Salt Crust (B11) <input type="checkbox"/> Aquatic Invertebrates (B13) <input type="checkbox"/> Hydrogen Sulfide Odor (C1) <input type="checkbox"/> Oxidized Rhizospheres along Living Roots (C3) <input type="checkbox"/> Presence of Reduced Iron (C4) <input type="checkbox"/> Recent Iron Reduction in Tilled Soils (C6) <input type="checkbox"/> Stunted or Stressed Plants (D1) (LRR A) <input type="checkbox"/> Other (Explain in Remarks)	<input type="checkbox"/> Water-Stained Leaves (B9) (MLRA 1, 2, 4A, and 4B) <input type="checkbox"/> Drainage Patterns (B10) <input type="checkbox"/> Dry-Season Water Table (C2) <input type="checkbox"/> Saturation Visible on Aerial Imagery (C9) <input type="checkbox"/> Geomorphic Position (D2) <input type="checkbox"/> Shallow Aquitard (D3) <input type="checkbox"/> FAC-Neutral Test (D5) <input type="checkbox"/> Raised Ant Mounds (D6) (LRR A) <input type="checkbox"/> Frost-Heave Hummocks (D7)	
<b>Field Observations:</b> Surface Water Present? Yes <input type="checkbox"/> No <input checked="" type="checkbox"/> Depth (inches): _____ Water Table Present? Yes <input type="checkbox"/> No <input checked="" type="checkbox"/> Depth (inches): _____ Saturation Present? (includes capillary fringe) Yes <input type="checkbox"/> No <input checked="" type="checkbox"/> Depth (inches): _____		<b>Wetland Hydrology Present?</b> Yes <input type="checkbox"/> No <input checked="" type="checkbox"/>	
Describe Recorded Data (stream gauge, monitoring well, aerial photos, previous inspections), if available:			
Remarks: _____			

**WETLAND DETERMINATION DATA FORM – Western Mountains, Valleys, and Coast Region**

Project/Site: Artz Parcels City/County: Puyallup / Pierce Sampling Date: 29 AUG 2018  
 Applicant/Owner: \_\_\_\_\_ State: Washington Sampling Point: SP-6  
 Investigator(s): Habitat Technologies Section, Township, Range: S09, T19, R04E  
 Landform (hillslope, terrace, etc.): \_\_\_\_\_ Local relief (concave, convex, none): \_\_\_\_\_ Slope (%): \_\_\_\_\_  
 Subregion (LRR): A Lat: \_\_\_\_\_ Long: \_\_\_\_\_ Datum: \_\_\_\_\_  
 Soil Map Unit Name: Everett very gravelly sandy loam NWI classification: \_\_\_\_\_

Are climatic / hydrologic conditions on the site typical for this time of year? Yes  No  (If no, explain in Remarks.)  
 Are Vegetation \_\_\_\_\_, Soil \_\_\_\_\_, or Hydrology \_\_\_\_\_ significantly disturbed? Are "Normal Circumstances" present? Yes  No   
 Are Vegetation \_\_\_\_\_, Soil \_\_\_\_\_, or Hydrology \_\_\_\_\_ naturally problematic? (If needed, explain any answers in Remarks.)

**SUMMARY OF FINDINGS – Attach site map showing sampling point locations, transects, important features, etc.**

Hydrophytic Vegetation Present? Yes <input checked="" type="checkbox"/> No <input type="checkbox"/> Hydric Soil Present? Yes <input checked="" type="checkbox"/> No <input type="checkbox"/> Wetland Hydrology Present? Yes <input checked="" type="checkbox"/> No <input type="checkbox"/>	Is the Sampled Area within a Wetland? Yes <input checked="" type="checkbox"/> No <input type="checkbox"/>
Remarks: Wetland	

**VEGETATION – Use scientific names of plants.**

<u>Tree Stratum</u> (Plot size: <u>15ft radius</u> )	Absolute % Cover	Dominant Species?	Indicator Status	<b>Dominance Test worksheet:</b>
1. <u>i</u>	_____	_____	_____	Number of Dominant Species That Are OBL, FACW, or FAC: <u>3</u> (A)  Total Number of Dominant Species Across All Strata: <u>4</u> (B)  Percent of Dominant Species That Are OBL, FACW, or FAC: <u>75</u> (A/B)
2. _____	_____	_____	_____	
3. _____	_____	_____	_____	
4. _____	_____	_____	_____	
0 = Total Cover				<b>Prevalence Index worksheet:</b> Total % Cover of: _____ Multiply by: OBL species _____ x 1 = _____ FACW species _____ x 2 = _____ FAC species _____ x 3 = _____ FACU species _____ x 4 = _____ UPL species _____ x 5 = _____ Column Totals: _____ (A) _____ (B)  Prevalence Index = B/A = _____
<u>Sapling/Shrub Stratum</u> (Plot size: <u>15ft radius</u> )				
1. <u>Cornus stolonifera</u>	<u>100</u>	<u>YES</u>	<u>FACW</u>	
2. <u>Rubus spectabilis</u>	<u>10</u>	<u>YES</u>	<u>FAC+</u>	
3. _____	_____	_____	_____	
4. _____	_____	_____	_____	
5. _____	_____	_____	_____	
110 = Total Cover				
<u>Herb Stratum</u> (Plot size: <u>15ft radius</u> )				<b>Hydrophytic Vegetation Indicators:</b> <input type="checkbox"/> Rapid Test for Hydrophytic Vegetation <input checked="" type="checkbox"/> Dominance Test is >50% <input type="checkbox"/> Prevalence Index is ≤3.0 <sup>1</sup> <input type="checkbox"/> Morphological Adaptations <sup>1</sup> (Provide supporting data in Remarks or on a separate sheet) <input type="checkbox"/> Wetland Non-Vascular Plants <sup>1</sup> <input type="checkbox"/> Problematic Hydrophytic Vegetation <sup>1</sup> (Explain)  <sup>1</sup> Indicators of hydric soil and wetland hydrology must be present, unless disturbed or problematic.
1. <u>Athyrium filix-femina</u>	<u>5</u>	<u>YES</u>	<u>FAC</u>	
2. <u>Lysichitum americanum</u>	<u>20</u>	<u>YES</u>	<u>OBL</u>	
3. _____	_____	_____	_____	
4. _____	_____	_____	_____	
5. _____	_____	_____	_____	
6. _____	_____	_____	_____	
7. _____	_____	_____	_____	
8. _____	_____	_____	_____	
9. _____	_____	_____	_____	
10. _____	_____	_____	_____	
11. _____	_____	_____	_____	
25 = Total Cover				
<u>Woody Vine Stratum</u> (Plot size: <u>15ft radius</u> )				<b>Hydrophytic Vegetation Present?</b> Yes <input checked="" type="checkbox"/> No <input type="checkbox"/>
1. _____	_____	_____	_____	
2. _____	_____	_____	_____	
0 = Total Cover				
% Bare Ground in Herb Stratum <u>0</u>				
Remarks:				

**SOIL**

Sampling Point: SP-6

**Profile Description: (Describe to the depth needed to document the indicator or confirm the absence of indicators.)**

Depth (inches)	Matrix		Redox Features			Loc <sup>2</sup>	Texture	Remarks
	Color (moist)	%	Color (moist)	%	Type <sup>1</sup>			
0-20	10YR 2/1	100					SIL	

<sup>1</sup>Type: C=Concentration, D=Depletion, RM=Reduced Matrix, CS=Covered or Coated Sand Grains. <sup>2</sup>Location: PL=Pore Lining, M=Matrix.

<p><b>Hydric Soil Indicators: (Applicable to all LRRs, unless otherwise noted.)</b></p> <input type="checkbox"/> Histosol (A1) <input type="checkbox"/> Histic Epipedon (A2) <input type="checkbox"/> Black Histic (A3) <input type="checkbox"/> Hydrogen Sulfide (A4) <input type="checkbox"/> Depleted Below Dark Surface (A11) <input checked="" type="checkbox"/> Thick Dark Surface (A12) <input type="checkbox"/> Sandy Mucky Mineral (S1) <input type="checkbox"/> Sandy Gleyed Matrix (S4) <input type="checkbox"/> Sandy Redox (S5) <input type="checkbox"/> Stripped Matrix (S6) <input type="checkbox"/> Loamy Mucky Mineral (F1) (except MLRA 1) <input type="checkbox"/> Loamy Gleyed Matrix (F2) <input type="checkbox"/> Depleted Matrix (F3) <input type="checkbox"/> Redox Dark Surface (F6) <input type="checkbox"/> Depleted Dark Surface (F7) <input type="checkbox"/> Redox Depressions (F8)	<p><b>Indicators for Problematic Hydric Soils<sup>3</sup>:</b></p> <input type="checkbox"/> 2 cm Muck (A10) <input type="checkbox"/> Red Parent Material (TF2) <input type="checkbox"/> Very Shallow Dark Surface (TF12) <input type="checkbox"/> Other (Explain in Remarks)
---	--

<sup>3</sup>Indicators of hydrophytic vegetation and wetland hydrology must be present, unless disturbed or problematic.

<p><b>Restrictive Layer (if present):</b>          Type: _____          Depth (inches): _____</p>	<p><b>Hydric Soil Present?</b> Yes <input checked="" type="checkbox"/> No <input type="checkbox"/></p>
---	--

Remarks:

**HYDROLOGY**

<p><b>Wetland Hydrology Indicators:</b></p> <p>Primary Indicators (minimum of one required; check all that apply)</p> <input type="checkbox"/> Surface Water (A1) <input type="checkbox"/> High Water Table (A2) <input checked="" type="checkbox"/> Saturation (A3) <input checked="" type="checkbox"/> Water Marks (B1) <input type="checkbox"/> Sediment Deposits (B2) <input type="checkbox"/> Drift Deposits (B3) <input type="checkbox"/> Algal Mat or Crust (B4) <input type="checkbox"/> Iron Deposits (B5) <input checked="" type="checkbox"/> Surface Soil Cracks (B6) <input type="checkbox"/> Inundation Visible on Aerial Imagery (B7) <input checked="" type="checkbox"/> Sparsely Vegetated Concave Surface (B8) <input checked="" type="checkbox"/> Water-Stained Leaves (B9) (except MLRA 1, 2, 4A, and 4B) <input type="checkbox"/> Salt Crust (B11) <input type="checkbox"/> Aquatic Invertebrates (B13) <input type="checkbox"/> Hydrogen Sulfide Odor (C1) <input type="checkbox"/> Oxidized Rhizospheres along Living Roots (C3) <input type="checkbox"/> Presence of Reduced Iron (C4) <input type="checkbox"/> Recent Iron Reduction in Tilled Soils (C6) <input type="checkbox"/> Stunted or Stressed Plants (D1) (LRR A) <input type="checkbox"/> Other (Explain in Remarks)		<p>Secondary Indicators (2 or more required)</p> <input checked="" type="checkbox"/> Water-Stained Leaves (B9) (MLRA 1, 2, 4A, and 4B) <input type="checkbox"/> Drainage Patterns (B10) <input type="checkbox"/> Dry-Season Water Table (C2) <input type="checkbox"/> Saturation Visible on Aerial Imagery (C9) <input type="checkbox"/> Geomorphic Position (D2) <input type="checkbox"/> Shallow Aquitard (D3) <input type="checkbox"/> FAC-Neutral Test (D5) <input type="checkbox"/> Raised Ant Mounds (D6) (LRR A) <input type="checkbox"/> Frost-Heave Hummocks (D7)
--	--	--

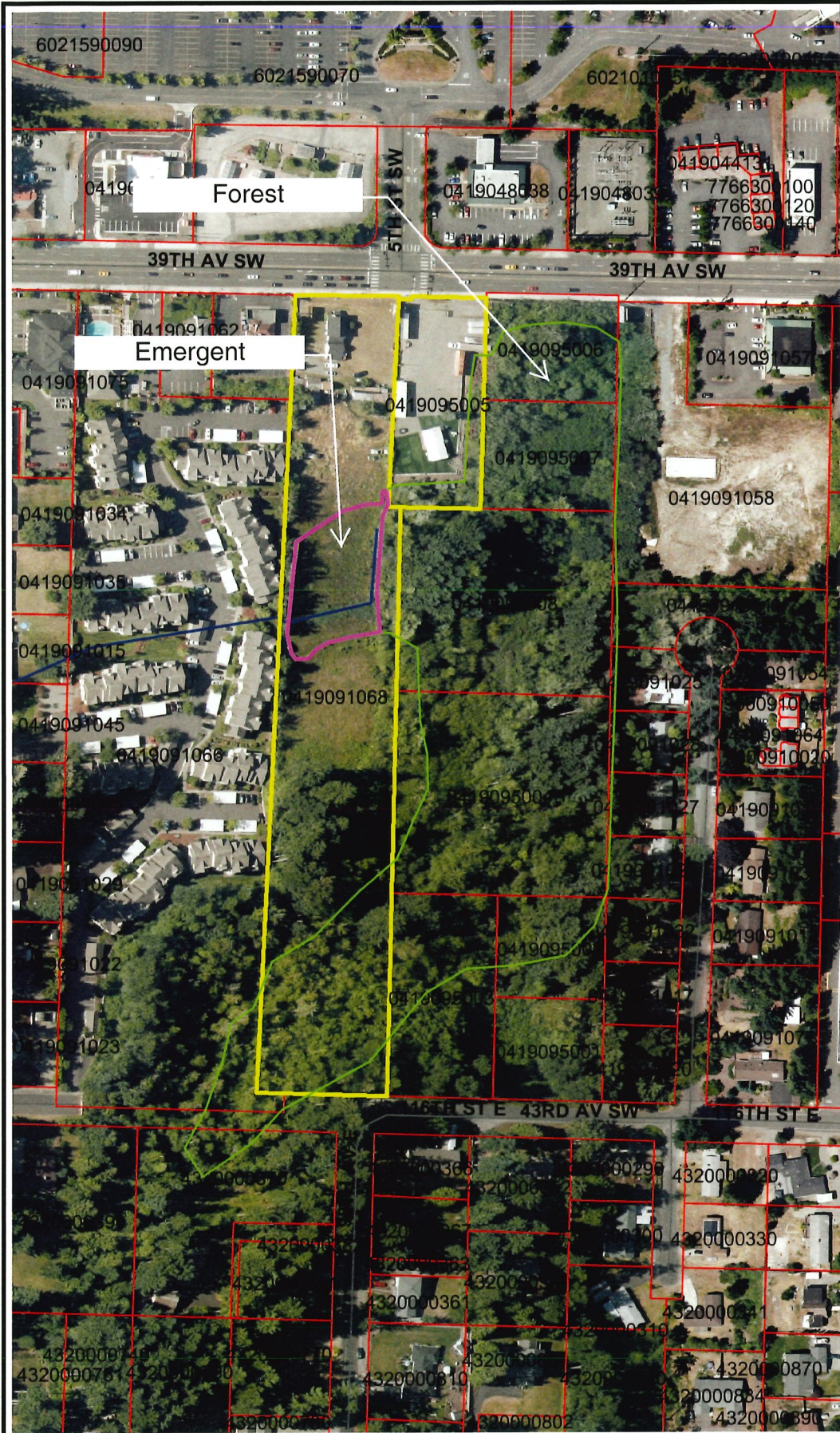
<p><b>Field Observations:</b></p> Surface Water Present? Yes <input type="checkbox"/> No <input checked="" type="checkbox"/> Depth (inches): _____ Water Table Present? Yes <input type="checkbox"/> No <input checked="" type="checkbox"/> Depth (inches): _____ Saturation Present? (includes capillary fringe) Yes <input checked="" type="checkbox"/> No <input type="checkbox"/> Depth (inches): 0	<p><b>Wetland Hydrology Present?</b> Yes <input checked="" type="checkbox"/> No <input type="checkbox"/></p>
---	--

Describe Recorded Data (stream gauge, monitoring well, aerial photos, previous inspections), if available:

Remarks:

## **APPENDIX B – Wetland Rating Worksheet**





The map features are approximate and are intended only to provide an indication of said feature. Additional areas that have not been mapped may be present. This is not a survey. The orthophotos and other data may not align. Pierce County and Habitat Technologies assume no liability for variations ascertained by actual survey. All data is expressly provided AS IS and WITH ALL FAULTS. Pierce County and Habitat Technologies make no warranty of fitness for a particular purpose.

- ### Map Legend
- Highlighted Tax Parcels
  - Tax Parcels
  - Drainage - Main Lines
  - Hydro - Centerlines
  - Roads
  - County - 2014 - Ortho
  - Forested
  - Emergent

**Figure W1**





The map features are approximate and are intended only to provide an indication of said feature. Additional areas that have not been mapped may be present. This is not a survey. The orthophotos and other data may not align. Pierce County and Habitat Technologies assume no liability for variations ascertained by actual survey. All data is expressly provided AS IS and WITH ALL FAULTS. Pierce County and Habitat Technologies make no warranty of fitness for a particular purpose.

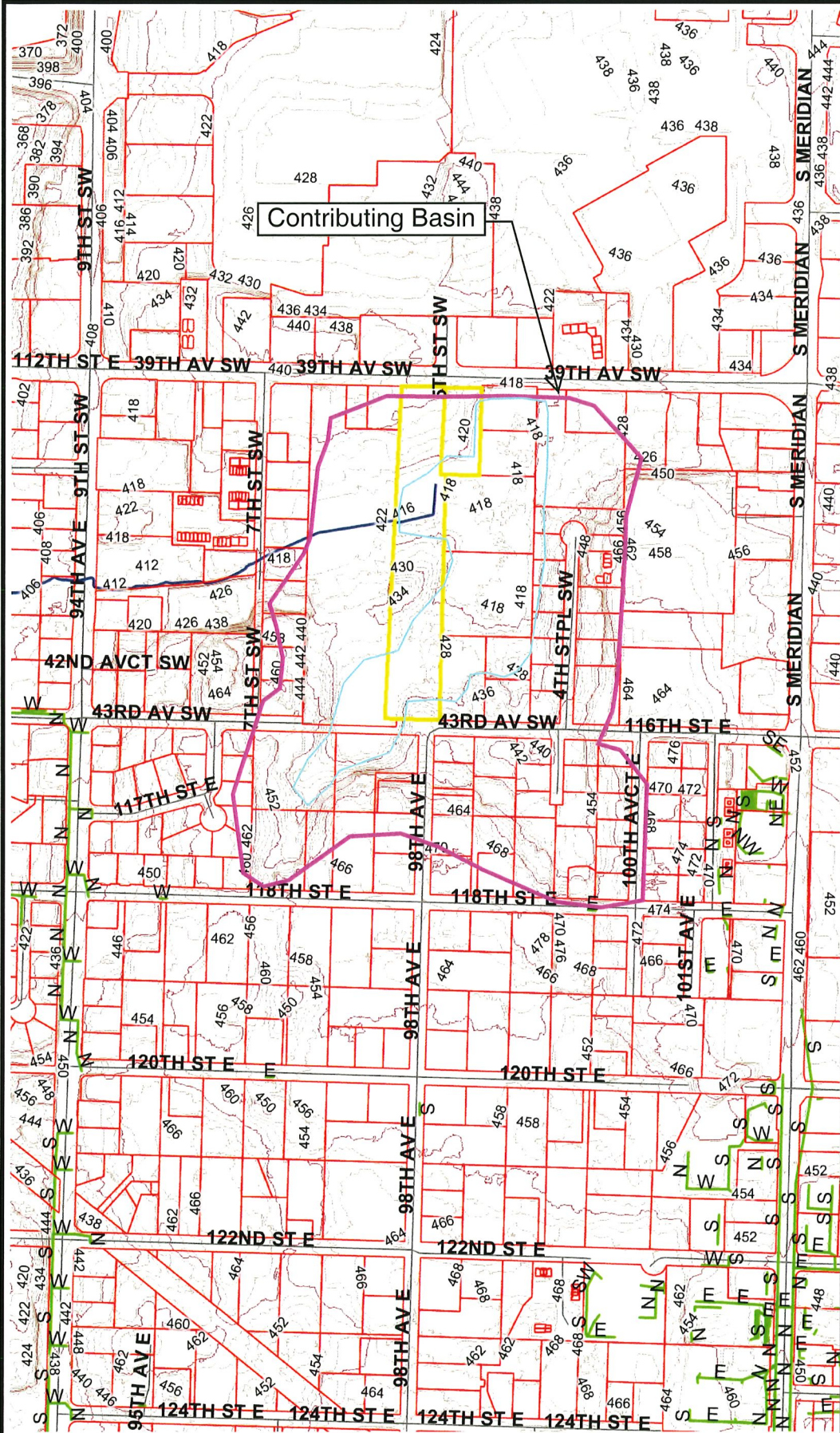
### Map Legend

- Highlighted Tax Parcels
- Tax Parcels
- Drainage - Main Lines
- Hydro - Centerlines
- Roads
- Hydro - Surface Boundaries
- County - 2014 - Ortho Permanent Ponding
- Seasonal Ponding
- Seasonal Saturation
- Area within 150 Feet of Wetland Boundary

**Figure W2**







The map features are approximate and are intended only to provide an indication of said feature. Additional areas that have not been mapped may be present. This is not a survey. The orthophotos and other data may not align. Pierce County and Habitat Technologies assume no liability for variations ascertained by actual survey. All data is expressly provided AS IS and WITH ALL FAULTS. Pierce County and Habitat Technologies make no warranty of fitness for a particular purpose.

- ### Map Legend
- Highlighted Tax Parcels
  - Tax Parcels
  - Drainage - Main Lines
  - Hydro - Centerlines
  - Roads
  - Contours - 2011
  - 10' Contour Line
  - 2' Contour Line
  - Contributing Basin Area

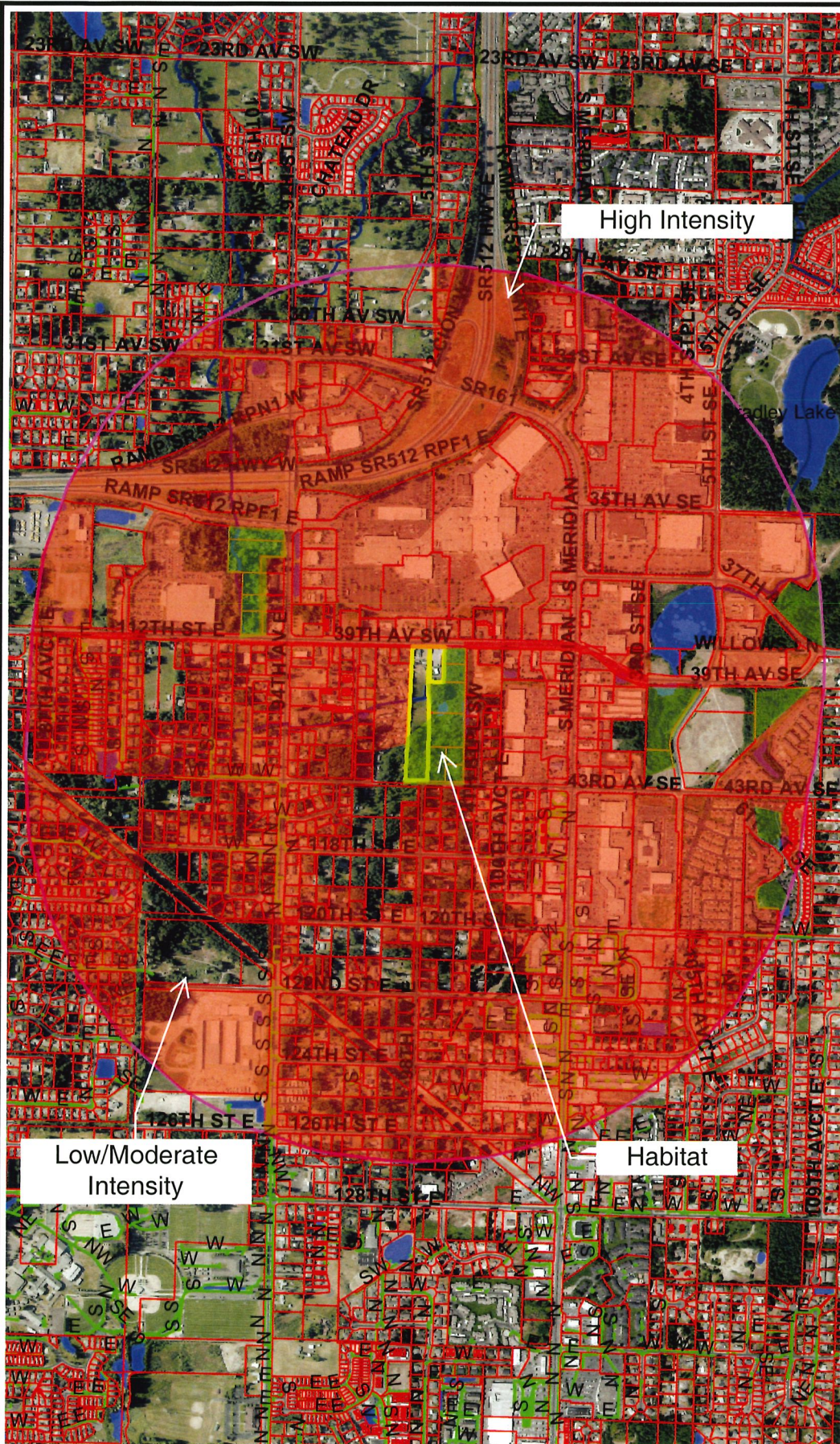
**Figure W3**



The map features are approximate and are intended only to provide an indication of said feature. Additional areas that have not been mapped may be present. This is not a survey. The orthophotos and other data may not align. Pierce County and Habitat Technologies assume no liability for variations ascertained by actual survey. All data is expressly provided AS IS and WITH ALL FAULTS. Pierce County and Habitat Technologies make no warranty of fitness for a particular purpose.

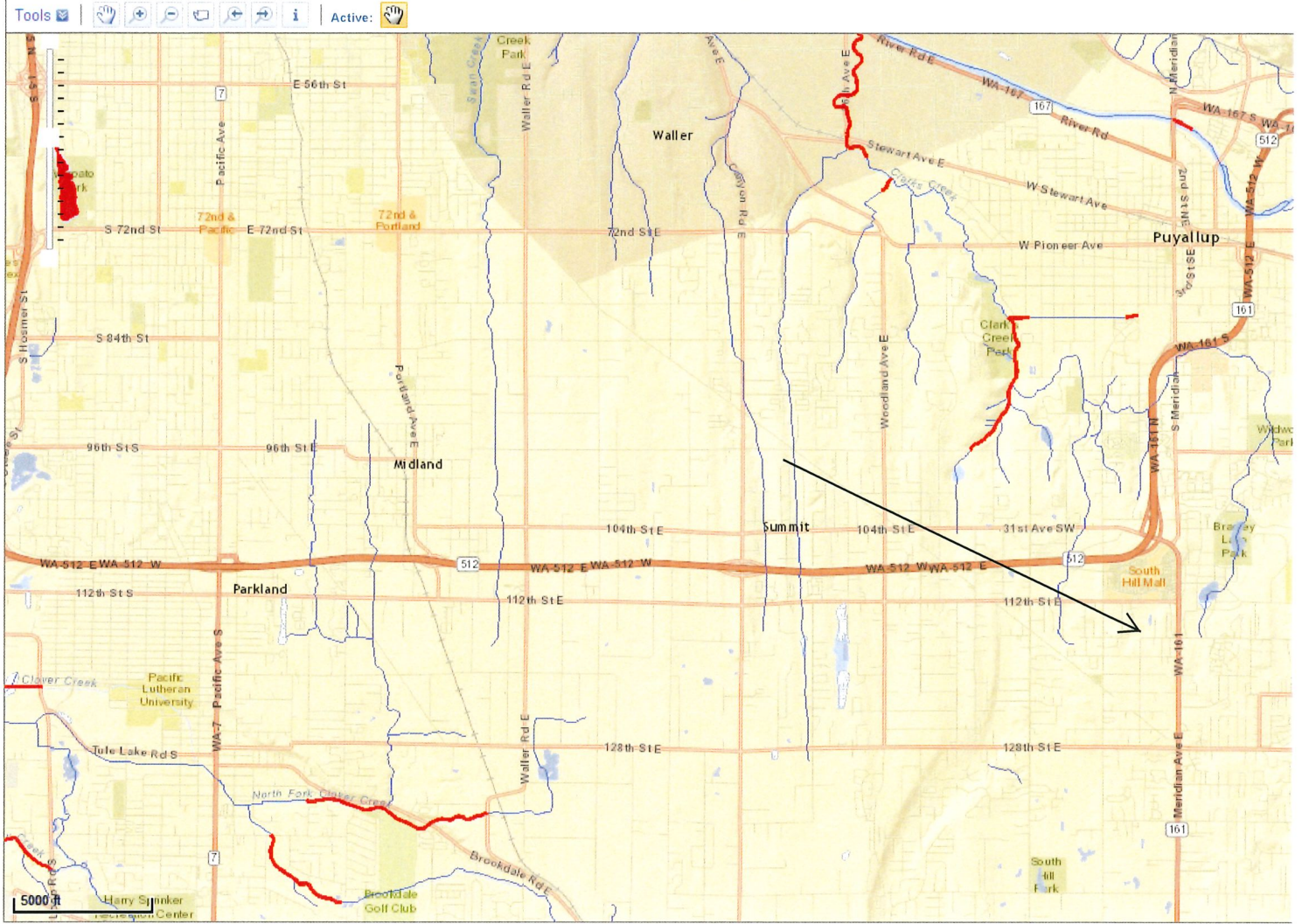
### Map Legend

- Highlighted Tax Parcels
- Tax Parcels
- Drainage - Main Lines
- Hydro - Centerlines
- Roads
- Hydro - Surface Boundaries
- County - 2014 - Ortho
- High Intensity Land Use
- Low/Moderate Intensity Land Use
- Habitat Area



**Figure W4**



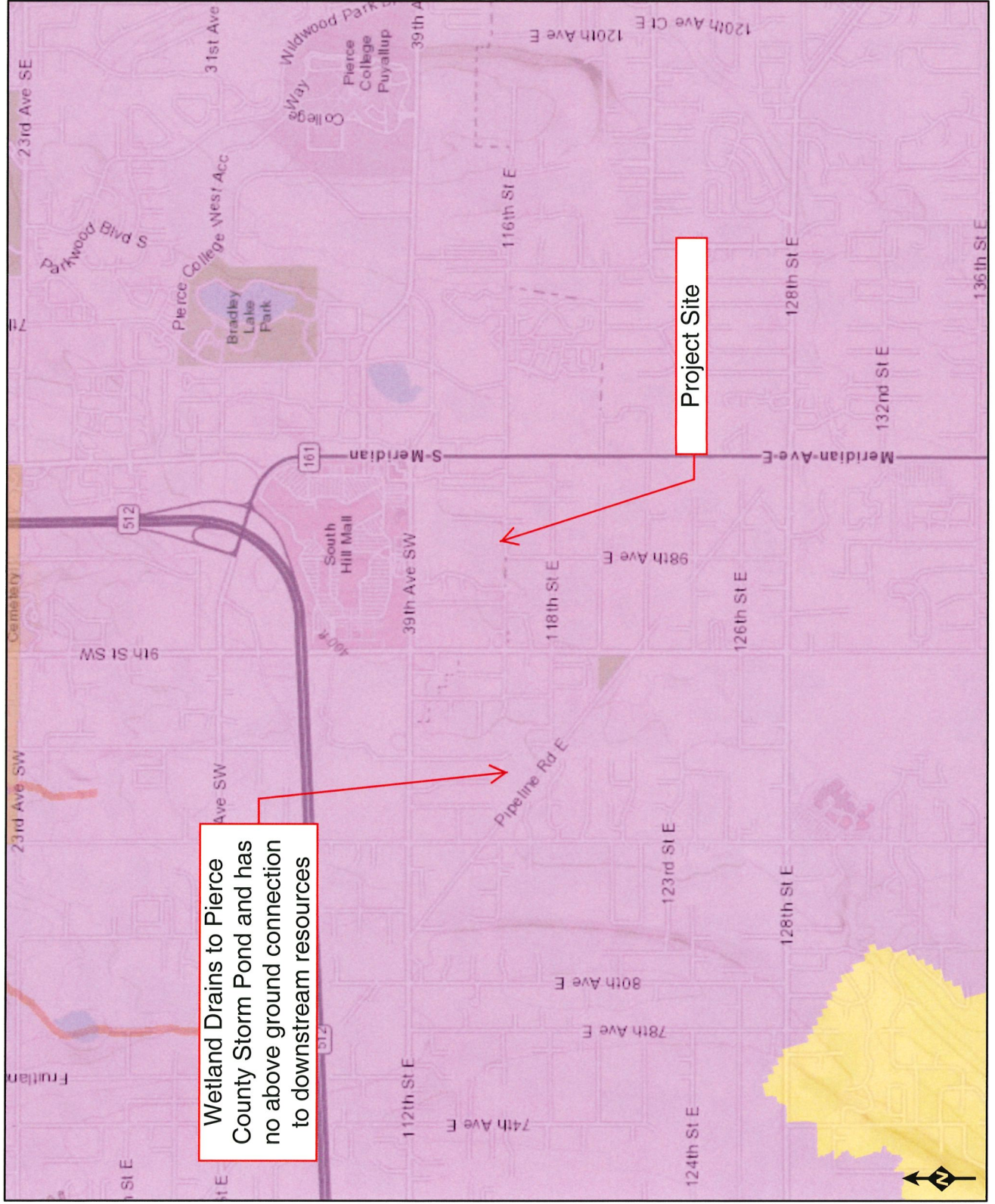


Water Quality Assessment for Washington [Data Disclaimer](#) [Privacy Notice](#) [Contact Us](#)  
Copyright © 2012 Washington State Department of Ecology. All Rights Reserved.

**Figure W5**



Figure W6



**Assessed Waters/Sediment**

- Water
- Category 5 - 303d
- Category 4C
- Category 4B
- Category 4A
- Category 2
- Category 1

- Sediment
- Category 5 - 303d
- Category 4C
- Category 4B
- Category 4A
- Category 2
- Category 1

**WQ Improvement Projects**

- Approved
- In Development



Sources: Esri, HERE, Garmin, Intermap, increment P Corp., GEBCO, USGS, FAO, NPS, NRCAN, GeoBase, IGN, Kadaster NL, Ordnance Survey, Esri Japan, METI, Esri China (Hong Kong), (c) OpenStreetMap contributors, and

Wetland name or number A

## RATING SUMMARY – Western Washington

Name of wetland (or ID #): Wetland A Date of site visit: 27 APR 2015

Rated by Habitat Technologies Trained by Ecology?  Yes  No Date of training 2014

HGM Class used for rating Depressional Wetland has multiple HGM classes?  Y  N

**NOTE: Form is not complete without the figures requested (figures can be combined).**  
Source of base aerial photo/map Pierce County GIS

**OVERALL WETLAND CATEGORY 3** (based on functions  or special characteristics )

### 1. Category of wetland based on FUNCTIONS

Category I – Total score = 23 - 27

Category II – Total score = 20 - 22

Category III – Total score = 16 - 19

Category IV – Total score = 9 - 15

FUNCTION	Improving Water Quality	Hydrologic	Habitat	
<i>Circle the appropriate ratings</i>				
Site Potential	H <input checked="" type="checkbox"/> L	H <input checked="" type="checkbox"/> L	H <input checked="" type="checkbox"/> L	
Landscape Potential	<input checked="" type="checkbox"/> M L	<input checked="" type="checkbox"/> M L	H M <input checked="" type="checkbox"/> L	
Value	H M <input checked="" type="checkbox"/> L	H <input checked="" type="checkbox"/> L	H <input checked="" type="checkbox"/> L	<b>TOTAL</b>
Score Based on Ratings	6	7	5	18

**Score for each function based on three ratings (order of ratings is not important)**

9 = H,H,H  
8 = H,H,M  
7 = H,H,L  
7 = H,M,M  
6 = H,M,L  
6 = M,M,M  
5 = H,L,L  
5 = M,M,L  
4 = M,L,L  
3 = L,L,L

### 2. Category based on SPECIAL CHARACTERISTICS of wetland

CHARACTERISTIC	CATEGORY
Estuarine	I II
Wetland of High Conservation Value	I
Bog	I
Mature Forest	I
Old Growth Forest	I
Coastal Lagoon	I II
Interdunal	I II III IV
None of the above	X

Wetland name or number  A

## Maps and figures required to answer questions correctly for Western Washington

### Depressional Wetlands

Map of:	To answer questions:	Figure #
Cowardin plant classes	D 1.3, H 1.1, H 1.4	W1
Hydroperiods	D 1.4, H 1.2	W2
Location of outlet ( <i>can be added to map of hydroperiods</i> )	D 1.1, D 4.1	W2
Boundary of area within 150 ft of the wetland ( <i>can be added to another figure</i> )	D 2.2, D 5.2	W2
Map of the contributing basin	D 4.3, D 5.3	W3
1 km Polygon: Area that extends 1 km from entire wetland edge - including polygons for accessible habitat and undisturbed habitat	H 2.1, H 2.2, H 2.3	W4
Screen capture of map of 303(d) listed waters in basin (from Ecology website)	D 3.1, D 3.2	W5
Screen capture of list of TMDLs for WRIA in which unit is found (from web)	D 3.3	W6

### Riverine Wetlands

Map of:	To answer questions:	Figure #
Cowardin plant classes	H 1.1, H 1.4	↑
Hydroperiods	H 1.2	
Ponded depressions	R 1.1	
Boundary of area within 150 ft of the wetland ( <i>can be added to another figure</i> )	R 2.4	
Plant cover of trees, shrubs, and herbaceous plants	R 1.2, R 4.2	
Width of unit vs. width of stream ( <i>can be added to another figure</i> )	R 4.1	N/A
Map of the contributing basin	R 2.2, R 2.3, R 5.2	
1 km Polygon: Area that extends 1 km from entire wetland edge - including polygons for accessible habitat and undisturbed habitat	H 2.1, H 2.2, H 2.3	
Screen capture of map of 303(d) listed waters in basin (from Ecology website)	R 3.1	
Screen capture of list of TMDLs for WRIA in which unit is found (from web)	R 3.2, R 3.3	↓

### Lake Fringe Wetlands

Map of:	To answer questions:	Figure #
Cowardin plant classes	L 1.1, L 4.1, H 1.1, H 1.4	↑
Plant cover of trees, shrubs, and herbaceous plants	L 1.2	
Boundary of area within 150 ft of the wetland ( <i>can be added to another figure</i> )	L 2.2	
1 km Polygon: Area that extends 1 km from entire wetland edge - including polygons for accessible habitat and undisturbed habitat	H 2.1, H 2.2, H 2.3	N/A
Screen capture of map of 303(d) listed waters in basin (from Ecology website)	L 3.1, L 3.2	
Screen capture of list of TMDLs for WRIA in which unit is found (from web)	L 3.3	↓

### Slope Wetlands

Map of:	To answer questions:	Figure #
Cowardin plant classes	H 1.1, H 1.4	↑
Hydroperiods	H 1.2	
Plant cover of <b>dense</b> trees, shrubs, and herbaceous plants	S 1.3	
Plant cover of <b>dense, rigid</b> trees, shrubs, and herbaceous plants ( <i>can be added to figure above</i> )	S 4.1	N/A
Boundary of 150 ft buffer ( <i>can be added to another figure</i> )	S 2.1, S 5.1	
1 km Polygon: Area that extends 1 km from entire wetland edge - including polygons for accessible habitat and undisturbed habitat	H 2.1, H 2.2, H 2.3	
Screen capture of map of 303(d) listed waters in basin (from Ecology website)	S 3.1, S 3.2	
Screen capture of list of TMDLs for WRIA in which unit is found (from web)	S 3.3	↓



## HGM Classification of Wetlands in Western Washington

For questions 1-7, the criteria described must apply to the entire unit being rated.

If the hydrologic criteria listed in each question do not apply to the entire unit being rated, you probably have a unit with multiple HGM classes. In this case, identify which hydrologic criteria in questions 1-7 apply, and go to Question 8.

1. Are the water levels in the entire unit usually controlled by tides except during floods?

**NO** – go to 2

**YES** – the wetland class is **Tidal Fringe** – go to 1.1

- 1.1 Is the salinity of the water during periods of annual low flow below 0.5 ppt (parts per thousand)?

**NO** – Saltwater Tidal Fringe (Estuarine)

**YES** – Freshwater Tidal Fringe

*If your wetland can be classified as a Freshwater Tidal Fringe use the forms for **Riverine** wetlands. If it is Saltwater Tidal Fringe it is an **Estuarine** wetland and is not scored. This method **cannot** be used to score functions for estuarine wetlands.*

2. The entire wetland unit is flat and precipitation is the only source (>90%) of water to it. Groundwater and surface water runoff are NOT sources of water to the unit.

**NO** – go to 3

**YES** – The wetland class is **Flats**

*If your wetland can be classified as a Flats wetland, use the form for **Depressional** wetlands.*

3. Does the entire wetland unit **meet all** of the following criteria?

The vegetated part of the wetland is on the shores of a body of permanent open water (without any plants on the surface at any time of the year) at least 20 ac (8 ha) in size;

At least 30% of the open water area is deeper than 6.6 ft (2 m).

**NO** – go to 4

**YES** – The wetland class is **Lake Fringe** (Lacustrine Fringe)

4. Does the entire wetland unit **meet all** of the following criteria?

The wetland is on a slope (*slope can be very gradual*),

The water flows through the wetland in one direction (unidirectional) and usually comes from seeps. It may flow subsurface, as sheetflow, or in a swale without distinct banks,

The water leaves the wetland **without being impounded**.

**NO** – go to 5

**YES** – The wetland class is **Slope**

**NOTE:** Surface water does not pond in these type of wetlands except occasionally in very small and shallow depressions or behind hummocks (depressions are usually <3 ft diameter and less than 1 ft deep).

5. Does the entire wetland unit **meet all** of the following criteria?

The unit is in a valley, or stream channel, where it gets inundated by overbank flooding from that stream or river,

The overbank flooding occurs at least once every 2 years.

Wetland name or number   A  

**NO – go to 6**

**YES – The wetland class is Riverine**

**NOTE:** The Riverine unit can contain depressions that are filled with water when the river is not flooding

6. Is the entire wetland unit in a topographic depression in which water ponds, or is saturated to the surface, at some time during the year? *This means that any outlet, if present, is higher than the interior of the wetland.*

NO – go to 7

**YES – The wetland class is Depressional**

7. Is the entire wetland unit located in a very flat area with no obvious depression and no overbank flooding? The unit does not pond surface water more than a few inches. The unit seems to be maintained by high groundwater in the area. The wetland may be ditched, but has no obvious natural outlet.

**NO – go to 8**

**YES – The wetland class is Depressional**

8. Your wetland unit seems to be difficult to classify and probably contains several different HGM classes. For example, seeps at the base of a slope may grade into a riverine floodplain, or a small stream within a Depressional wetland has a zone of flooding along its sides. **GO BACK AND IDENTIFY WHICH OF THE HYDROLOGIC REGIMES DESCRIBED IN QUESTIONS 1-7 APPLY TO DIFFERENT AREAS IN THE UNIT** (make a rough sketch to help you decide). Use the following table to identify the appropriate class to use for the rating system if you have several HGM classes present within the wetland unit being scored.

**NOTE:** Use this table only if the class that is recommended in the second column represents 10% or more of the total area of the wetland unit being rated. If the area of the HGM class listed in column 2 is less than 10% of the unit; classify the wetland using the class that represents more than 90% of the total area.

HGM classes within the wetland unit being rated	HGM class to use in rating
Slope + Riverine	Riverine
Slope + Depressional	Depressional
Slope + Lake Fringe	Lake Fringe
Depressional + Riverine along stream within boundary of depression	Depressional
Depressional + Lake Fringe	Depressional
Riverine + Lake Fringe	Riverine
Salt Water Tidal Fringe and any other class of freshwater wetland	Treat as ESTUARINE

*If you are still unable to determine which of the above criteria apply to your wetland, or if you have **more than 2 HGM classes** within a wetland boundary, classify the wetland as Depressional for the rating.*

Wetland name or number   A  

<b>DEPRESSIONAL AND FLATS WETLANDS</b>	
<b>Water Quality Functions - Indicators that the site functions to improve water quality</b>	
<b>D 1.0. Does the site have the potential to improve water quality?</b>	
<b>D 1.1. Characteristics of surface water outflows from the wetland:</b> Wetland is a depression or flat depression (QUESTION 7 on key) with no surface water leaving it (no outlet). <div style="text-align: right;">points = 3</div> Wetland has an intermittently flowing stream or ditch, OR highly constricted permanently flowing outlet. <div style="text-align: right;">points = 2</div> Wetland has an unconstricted, or slightly constricted, surface outlet that is permanently flowing <div style="text-align: right;">points = 1</div> Wetland is a flat depression (QUESTION 7 on key), whose outlet is a permanently flowing ditch. <div style="text-align: right;">points = 1</div>	<b>2</b>
<b>D 1.2. The soil 2 in below the surface (or duff layer) is true clay or true organic (use NRCS definitions). Yes = 4 No = 0</b>	<b>0</b>
<b>D 1.3. Characteristics and distribution of persistent plants (Emergent, Scrub-shrub, and/or Forested Cowardin classes):</b> Wetland has persistent, ungrazed, plants > 95% of area <div style="text-align: right;">points = 5</div> Wetland has persistent, ungrazed, plants > ½ of area <div style="text-align: right;">points = 3</div> Wetland has persistent, ungrazed plants > 1/10 of area <div style="text-align: right;">points = 1</div> Wetland has persistent, ungrazed plants < 1/10 of area <div style="text-align: right;">points = 0</div>	<b>3</b>
<b>D 1.4. Characteristics of seasonal ponding or inundation:</b> <i>This is the area that is ponded for at least 2 months. See description in manual.</i> Area seasonally ponded is > ½ total area of wetland <div style="text-align: right;">points = 4</div> Area seasonally ponded is > ¼ total area of wetland <div style="text-align: right;">points = 2</div> Area seasonally ponded is < ¼ total area of wetland <div style="text-align: right;">points = 0</div>	<b>2</b>
<b>Total for D 1</b>	<b>7</b>

**Rating of Site Potential** If score is:    12-16 = H   X   6-11 = M    0-5 = L *Record the rating on the first page*

<b>D 2.0. Does the landscape have the potential to support the water quality function of the site?</b>		
<b>D 2.1. Does the wetland unit receive stormwater discharges?</b>	Yes = 1 No = 0	<b>1</b>
<b>D 2.2. Is &gt; 10% of the area within 150 ft of the wetland in land uses that generate pollutants?</b>	Yes = 1 No = 0	<b>1</b>
<b>D 2.3. Are there septic systems within 250 ft of the wetland?</b>	Yes = 1 No = 0	<b>1</b>
<b>D 2.4. Are there other sources of pollutants coming into the wetland that are not listed in questions D 2.1-D 2.3?</b>	Yes = 1 No = 0	<b>0</b>
Source _____	Yes = 1 No = 0	
<b>Total for D 2</b>	<b>3</b>	

**Rating of Landscape Potential** If score is:   X   3 or 4 = H    1 or 2 = M    0 = L *Record the rating on the first page*

<b>D 3.0. Is the water quality improvement provided by the site valuable to society?</b>		
<b>D 3.1. Does the wetland discharge directly (i.e., within 1 mi) to a stream, river, lake, or marine water that is on the 303(d) list?</b>	Yes = 1 No = 0	<b>0</b>
<b>D 3.2. Is the wetland in a basin or sub-basin where an aquatic resource is on the 303(d) list?</b>	Yes = 1 No = 0	<b>0</b>
<b>D 3.3. Has the site been identified in a watershed or local plan as important for maintaining water quality (answer YES if there is a TMDL for the basin in which the unit is found)?</b>	Yes = 2 No = 0	<b>0</b>
<b>Total for D 3</b>	<b>0</b>	

**Rating of Value** If score is:    2-4 = H    1 = M   X   0 = L *Record the rating on the first page*



Wetland name or number   A  

### DEPRESSIONAL AND FLATS WETLANDS

#### Hydrologic Functions - Indicators that the site functions to reduce flooding and stream degradation

D 4.0. Does the site have the potential to reduce flooding and erosion?

<p>D 4.1. <u>Characteristics of surface water outflows from the wetland:</u></p> <p>Wetland is a depression or flat depression with no surface water leaving it (no outlet) <span style="float: right;">points = 4</span></p> <p>Wetland has an intermittently flowing stream or ditch, OR highly constricted permanently flowing outlet <span style="float: right;">points = 2</span></p> <p>Wetland is a flat depression (QUESTION 7 on key), whose outlet is a permanently flowing ditch <span style="float: right;">points = 1</span></p> <p>Wetland has an unconstricted, or slightly constricted, surface outlet that is permanently flowing <span style="float: right;">points = 0</span></p>	<b>2</b>
<p>D 4.2. <u>Depth of storage during wet periods:</u> <i>Estimate the height of ponding above the bottom of the outlet. For wetlands with no outlet, measure from the surface of permanent water or if dry, the deepest part.</i></p> <p>Marks of ponding are 3 ft or more above the surface or bottom of outlet <span style="float: right;">points = 7</span></p> <p>Marks of ponding between 2 ft to &lt; 3 ft from surface or bottom of outlet <span style="float: right;">points = 5</span></p> <p>Marks are at least 0.5 ft to &lt; 2 ft from surface or bottom of outlet <span style="float: right;">points = 3</span></p> <p>The wetland is a "headwater" wetland <span style="float: right;">points = 3</span></p> <p>Wetland is flat but has small depressions on the surface that trap water <span style="float: right;">points = 1</span></p> <p>Marks of ponding less than 0.5 ft (6 in) <span style="float: right;">points = 0</span></p>	<b>3</b>
<p>D 4.3. <u>Contribution of the wetland to storage in the watershed:</u> <i>Estimate the ratio of the area of upstream basin contributing surface water to the wetland to the area of the wetland unit itself.</i></p> <p>The area of the basin is less than 10 times the area of the unit <span style="float: right;">points = 5</span></p> <p>The area of the basin is 10 to 100 times the area of the unit <span style="float: right;">points = 3</span></p> <p>The area of the basin is more than 100 times the area of the unit <span style="float: right;">points = 0</span></p> <p>Entire wetland is in the Flats class <span style="float: right;">points = 5</span></p>	<b>5</b>
Total for D 4	<b>10</b>

**Rating of Site Potential** If score is:    12-16 = H   X   6-11 = M    0-5 = L *Record the rating on the first page*

D 5.0. Does the landscape have the potential to support hydrologic functions of the site?

D 5.1. Does the wetland receive stormwater discharges?	Yes = 1 No = 0	<b>1</b>
D 5.2. Is >10% of the area within 150 ft of the wetland in land uses that generate excess runoff?	Yes = 1 No = 0	<b>1</b>
D 5.3. Is more than 25% of the contributing basin of the wetland covered with intensive human land uses (residential at >1 residence/ac, urban, commercial, agriculture, etc.)?	Yes = 1 No = 0	<b>1</b>
Total for D 5	Add the points in the boxes above	<b>3</b>

**Rating of Landscape Potential** If score is:   X   3 = H    1 or 2 = M    0 = L *Record the rating on the first page*

D 6.0. Are the hydrologic functions provided by the site valuable to society?

<p>D 6.1. <u>The unit is in a landscape that has flooding problems. Choose the description that best matches conditions around the wetland unit being rated. Do not add points. Choose the highest score if more than one condition is met.</u></p> <p>The wetland captures surface water that would otherwise flow down-gradient into areas where flooding has damaged human or natural resources (e.g., houses or salmon redds):</p> <ul style="list-style-type: none"> <li>• Flooding occurs in a sub-basin that is immediately down-gradient of unit. <span style="float: right;">points = 2</span></li> <li>• Surface flooding problems are in a sub-basin farther down-gradient. <span style="float: right;">points = 1</span></li> </ul> <p>Flooding from groundwater is an issue in the sub-basin. <span style="float: right;">points = 1</span></p> <p>The existing or potential outflow from the wetland is so constrained by human or natural conditions that the water stored by the wetland cannot reach areas that flood. <i>Explain why</i> _____ <span style="float: right;">points = 0</span></p> <p>There are no problems with flooding downstream of the wetland. <span style="float: right;">points = 0</span></p>	<b>1</b>	
<p>D 6.2. Has the site been identified as important for flood storage or flood conveyance in a regional flood control plan?</p> <p style="text-align: right;">Yes = 2 No = 0</p>	<b>0</b>	
Total for D 6	Add the points in the boxes above	<b>1</b>

**Rating of Value** If score is:    2-4 = H   X   1 = M    0 = L *Record the rating on the first page*

Wetland name or number A

**These questions apply to wetlands of all HGM classes.**

**HABITAT FUNCTIONS** - Indicators that site functions to provide important habitat

H 1.0. Does the site have the potential to provide habitat?

H 1.1. Structure of plant community: *Indicators are Cowardin classes and strata within the Forested class.* Check the Cowardin plant classes in the wetland. *Up to 10 patches may be combined for each class to meet the threshold of ¼ ac or more than 10% of the unit if it is smaller than 2.5 ac. Add the number of structures checked.*

- |  |                                  |          |
|--|----------------------------------|----------|
| <input type="checkbox"/> Aquatic bed   | 4 structures or more: points = 4 | <b>2</b> |
| <input checked="" type="checkbox"/> Emergent   | 3 structures: points = 2         |          |
| <input type="checkbox"/> Scrub-shrub (areas where shrubs have > 30% cover)   | 2 structures: points = 1         |          |
| <input checked="" type="checkbox"/> Forested (areas where trees have > 30% cover)  | 1 structure: points = 0          |          |
| <i>If the unit has a Forested class, check if:</i>   |                                  |          |
| <input checked="" type="checkbox"/> The Forested class has 3 out of 5 strata (canopy, sub-canopy, shrubs, herbaceous, moss/ground-cover) that each cover 20% within the Forested polygon |                                  |          |

H 1.2. Hydroperiods

Check the types of water regimes (hydroperiods) present within the wetland. The water regime has to cover more than 10% of the wetland or ¼ ac to count (*see text for descriptions of hydroperiods*).

- |   |                                     |          |
|---|-------------------------------------|----------|
| <input checked="" type="checkbox"/> Permanently flooded or inundated                          | 4 or more types present: points = 3 | <b>3</b> |
| <input checked="" type="checkbox"/> Seasonally flooded or inundated                           | 3 types present: points = 2         |          |
| <input type="checkbox"/> Occasionally flooded or inundated                                    | 2 types present: points = 1         |          |
| <input checked="" type="checkbox"/> Saturated only  | 1 type present: points = 0          |          |
| <input type="checkbox"/> Permanently flowing stream or river in, or adjacent to, the wetland  |                                     |          |
| <input checked="" type="checkbox"/> Seasonally flowing stream in, or adjacent to, the wetland |                                     |          |
| <input type="checkbox"/> Lake Fringe wetland  | <b>2 points</b>                     |          |
| <input type="checkbox"/> Freshwater tidal wetland   | <b>2 points</b>                     |          |

H 1.3. Richness of plant species

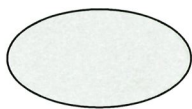
Count the number of plant species in the wetland that cover at least 10 ft<sup>2</sup>.

*Different patches of the same species can be combined to meet the size threshold and you do not have to name the species. Do not include Eurasian milfoil, reed canarygrass, purple loosestrife, Canadian thistle*

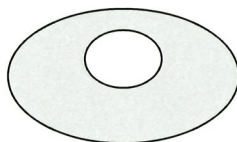
- |                              |            |          |
|------------------------------|------------|----------|
| If you counted: > 19 species | points = 2 | <b>2</b> |
| 5 - 19 species               | points = 1 |          |
| < 5 species                  | points = 0 |          |

H 1.4. Interspersion of habitats

Decide from the diagrams below whether interspersion among Cowardin plants classes (described in H 1.1), or the classes and unvegetated areas (can include open water or mudflats) is high, moderate, low, or none. *If you have four or more plant classes or three classes and open water, the rating is always high.*



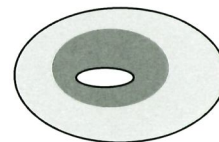
**None** = 0 points



**Low** = 1 point

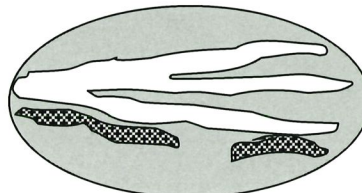
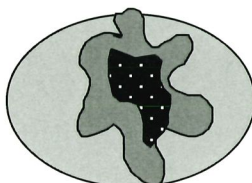
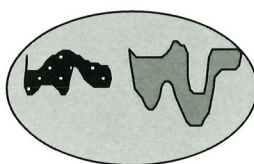


**Moderate** = 2 points



**1**

All three diagrams in this row are **HIGH** = 3 points





Wetland name or number A

<p>H 1.5. Special habitat features:            Check the habitat features that are present in the wetland. <i>The number of checks is the number of points.</i>  <input checked="" type="checkbox"/> Large, downed, woody debris within the wetland (&gt; 4 in diameter and 6 ft long).  <input checked="" type="checkbox"/> Standing snags (dbh &gt; 4 in) within the wetland  <input type="checkbox"/> Undercut banks are present for at least 6.6 ft (2 m) <b>and/or</b> overhanging plants extends at least 3.3 ft (1 m) over a stream (or ditch) in, or contiguous with the wetland, for at least 33 ft (10 m)  <input type="checkbox"/> Stable steep banks of fine material that might be used by beaver or muskrat for denning (&gt; 30 degree slope) OR signs of recent beaver activity are present (<i>cut shrubs or trees that have not yet weathered where wood is exposed</i>)  <input checked="" type="checkbox"/> At least ¼ ac of thin-stemmed persistent plants or woody branches are present in areas that are permanently or seasonally inundated (<i>structures for egg-laying by amphibians</i>)  <input type="checkbox"/> Invasive plants cover less than 25% of the wetland area in every stratum of plants (<i>see H 1.1 for list of strata</i>)</p>	3
Total for H 1	Add the points in the boxes above
11	

**Rating of Site Potential** If score is: 15-18 = H X 7-14 = M 0-6 = L *Record the rating on the first page*

<p>H 2.0. Does the landscape have the potential to support the habitat functions of the site?</p>	
<p>H 2.1. Accessible habitat (include <i>only habitat that directly abuts wetland unit</i>).  <i>Calculate:</i> % undisturbed habitat <u>0</u> + [(% moderate and low intensity land uses)/2] <u>2</u> = <u>2</u> %            If total accessible habitat is:            &gt; 1/3 (33.3%) of 1 km Polygon points = 3            20-33% of 1 km Polygon points = 2            10-19% of 1 km Polygon points = 1            &lt; 10% of 1 km Polygon points = 0</p>	0
<p>H 2.2. Undisturbed habitat in 1 km Polygon around the wetland.  <i>Calculate:</i> % undisturbed habitat <u>0</u> + [(% moderate and low intensity land uses)/2] <u>10</u> = <u>10</u> %            Undisturbed habitat &gt; 50% of Polygon points = 3            Undisturbed habitat 10-50% and in 1-3 patches points = 2            Undisturbed habitat 10-50% and &gt; 3 patches points = 1            Undisturbed habitat &lt; 10% of 1 km Polygon points = 0</p>	0
<p>H 2.3. Land use intensity in 1 km Polygon: If            &gt; 50% of 1 km Polygon is high intensity land use points = (- 2)            ≤ 50% of 1 km Polygon is high intensity points = 0</p>	(-2)
Total for H 2	Add the points in the boxes above
(-2)	

**Rating of Landscape Potential** If score is: 4-6 = H 1-3 = M X < 1 = L *Record the rating on the first page*

<p>H 3.0. Is the habitat provided by the site valuable to society?</p>	
<p>H 3.1. Does the site provide habitat for species valued in laws, regulations, or policies? <i>Choose only the highest score that applies to the wetland being rated.</i>            Site meets ANY of the following criteria: points = 2            — It has 3 or more priority habitats within 100 m (see next page)            — It provides habitat for Threatened or Endangered species (any plant or animal on the state or federal lists)            — It is mapped as a location for an individual WDFW priority species            — It is a Wetland of High Conservation Value as determined by the Department of Natural Resources            — It has been categorized as an important habitat site in a local or regional comprehensive plan, in a Shoreline Master Plan, or in a watershed plan            Site has 1 or 2 priority habitats (listed on next page) within 100 m points = 1            Site does not meet any of the criteria above points = 0</p>	1

**Rating of Value** If score is: 2 = H X 1 = M 0 = L *Record the rating on the first page*



## WDFW Priority Habitats

Priority habitats listed by WDFW (see complete descriptions of WDFW priority habitats, and the counties in which they can be found, in: Washington Department of Fish and Wildlife. 2008. Priority Habitat and Species List. Olympia, Washington. 177 pp. <http://wdfw.wa.gov/publications/00165/wdfw00165.pdf> or access the list from here: <http://wdfw.wa.gov/conservation/phs/list/>)

Count how many of the following priority habitats are within 330 ft (100 m) of the wetland unit: **NOTE:** *This question is independent of the land use between the wetland unit and the priority habitat.*

- **Aspen Stands:** Pure or mixed stands of aspen greater than 1 ac (0.4 ha).
- **Biodiversity Areas and Corridors:** Areas of habitat that are relatively important to various species of native fish and wildlife (*full descriptions in WDFW PHS report*).
- **Herbaceous Balds:** Variable size patches of grass and forbs on shallow soils over bedrock.
- X **Old-growth/Mature forests:** Old-growth west of Cascade crest – Stands of at least 2 tree species, forming a multi-layered canopy with occasional small openings; with at least 8 trees/ac (20 trees/ha) > 32 in (81 cm) dbh or > 200 years of age. Mature forests – Stands with average diameters exceeding 21 in (53 cm) dbh; crown cover may be less than 100%; decay, decadence, numbers of snags, and quantity of large downed material is generally less than that found in old-growth; 80-200 years old west of the Cascade crest.
- **Oregon White Oak:** Woodland stands of pure oak or oak/conifer associations where canopy coverage of the oak component is important (*full descriptions in WDFW PHS report p. 158 – see web link above*).
- **Riparian:** The area adjacent to aquatic systems with flowing water that contains elements of both aquatic and terrestrial ecosystems which mutually influence each other.
- **Westside Prairies:** Herbaceous, non-forested plant communities that can either take the form of a dry prairie or a wet prairie (*full descriptions in WDFW PHS report p. 161 – see web link above*).
- **Instream:** The combination of physical, biological, and chemical processes and conditions that interact to provide functional life history requirements for instream fish and wildlife resources.
- **Nearshore:** Relatively undisturbed nearshore habitats. These include Coastal Nearshore, Open Coast Nearshore, and Puget Sound Nearshore. (*full descriptions of habitats and the definition of relatively undisturbed are in WDFW report – see web link on previous page*).
- **Caves:** A naturally occurring cavity, recess, void, or system of interconnected passages under the earth in soils, rock, ice, or other geological formations and is large enough to contain a human.
- **Cliffs:** Greater than 25 ft (7.6 m) high and occurring below 5000 ft elevation.
- **Talus:** Homogenous areas of rock rubble ranging in average size 0.5 - 6.5 ft (0.15 - 2.0 m), composed of basalt, andesite, and/or sedimentary rock, including riprap slides and mine tailings. May be associated with cliffs.
- **Snags and Logs:** Trees are considered snags if they are dead or dying and exhibit sufficient decay characteristics to enable cavity excavation/use by wildlife. Priority snags have a diameter at breast height of > 20 in (51 cm) in western Washington and are > 6.5 ft (2 m) in height. Priority logs are > 12 in (30 cm) in diameter at the largest end, and > 20 ft (6 m) long.

**Note:** All vegetated wetlands are by definition a priority habitat but are not included in this list because they are addressed elsewhere.

## **APPENDIX C – Site Plan**

# **HABITAT TECHNOLOGIES**

---

## **CRITICAL AREAS ASSESSMENT**

**Parcel 0419095022  
409 - 43<sup>rd</sup> Avenue SW  
City of Puyallup, Washington**

*This document incorporates comments provided by City of Puyallup review*

prepared for

**Mr. David Artz  
7917 - 110<sup>th</sup> Street NW  
Gig Harbor, Washington 98332**

prepared by

**HABITAT TECHNOLOGIES  
P.O. Box 1088  
Puyallup, Washington 98371-1088  
253-845-5119**

**June 4, 2019  
Revised  
October 7, 2020**

# Table of Contents

<b>INTRODUCTION .....</b>	<b>1</b>
PROJECT SITE DESCRIPTION.....	1
<b>BACKGROUND INFORMATION .....</b>	<b>2</b>
NATIONAL WETLAND INVENTORY .....	2
STATE OF WASHINGTON PRIORITY HABITATS AND SPECIES .....	2
STATE OF WASHINGTON DEPARTMENT OF FISH AND WILDLIFE .....	2
STATE OF WASHINGTON DEPARTMENT OF NATURAL RESOURCES.....	2
CITY OF PUYALLUP MAPPING.....	2
PIERCE COUNTY MAPPING.....	3
SOILS MAPPING.....	3
PRIOR ASSESSMENTS .....	3
<b>ONSITE ANALYSIS .....</b>	<b>3</b>
CRITERIA FOR CRITICAL AREAS IDENTIFICATION.....	3
STUDY METHODS.....	5
FIELD OBSERVATION.....	5
<input type="checkbox"/> <i>Plant Communities</i> .....	5
<input type="checkbox"/> <i>Hydrology Patterns</i> .....	6
<input type="checkbox"/> <i>Soils</i> .....	6
<input type="checkbox"/> <i>Fish and Wildlife</i> .....	7
<b>CRITICAL AREAS DETERMINATION .....</b>	<b>9</b>
WETLANDS.....	9
FISH AND WILDLIFE HABITAT AREAS .....	10
<b>SELECTED DEVELOPMENT ACTION .....</b>	<b>10</b>
<b>STANDARD OF CARE.....</b>	<b>10</b>
<b>REFERENCE AND BACKGROUND LIST.....</b>	<b>12</b>
<b>APPENDIX A – REPRESENTATIVE FIELD DATA.....</b>	<b>14</b>
<b>APPENDIX B – WETLAND RATING WORKSHEET .....</b>	<b>15</b>
<b>SITE PLAN .....</b>	<b>16</b>

## INTRODUCTION

This document details the culmination of activities and onsite evaluations undertaken to complete a critical areas assessment (i.e. wetlands, streams, fish and wildlife habitats) of **Parcel 0419095022 (project site)**. The project site was located generally to the north of 43<sup>rd</sup> Avenue SW within the City of Puyallup, Pierce County, Washington (Figure 1). The evaluation and characterization of onsite and adjacent critical areas is a vital element in land use planning. The goal of this approach is to ensure that the proposed development of a single duplex and associated primary and reserve septic drainfield areas does not result in adverse environmental impacts to an identified City of Puyallup Category III Wetland and the associated 60-foot standard City of Puyallup buffer identified within the project site. **As presently proposed, all development activities shall be accomplished without intrusion into the wetland or standard buffer areas.**

The assessment and delineation of specific critical areas within and immediately adjacent to the project site followed the methods and procedures defined in the *Corps of Engineers Wetland Delineation Manual* (United States Army Corps of Engineers, 1987) with the *Regional Supplement to the Corps of Engineers Wetland Delineation Manual: Western Mountains, Valleys, and Coast Region* (United States Army Corps of Engineers, 2010); the Washington State *Wetland Rating System for Western Washington* (Hruby, 2014), the State of Washington Department of Natural Resources (WDNR) Forest Practice Rules (WAC 222-16-030), and the City of Puyallup Chapter 21. This document was designed to accommodate site planning and potential regulatory actions and is suitable for submittal to federal, state, and local authorities for potential critical areas verification and permitting actions.

## PROJECT SITE DESCRIPTION

The project site was composed of an existing vacant parcel of record totaling approximately 1.26-acres in size. As outlined below the majority of the project site was encumbered by wetland and wetland buffers. The project site was located within an area of increasing urbanization focusing on more intense commercial retail and higher intensity residential development. The southern boundary of the project site was formed by 43<sup>rd</sup> Avenue SW. Existing multi-family residential development was identified to the east of the eastern boundary. Vacant land was present to the north and west.

**Directions to Project Site:** From Meridian Avenue East (southbound) turn west onto 43<sup>rd</sup> Avenue SW. Continue on 43<sup>rd</sup> Avenue SW to 409 - 43<sup>rd</sup> Avenue SW.

## **BACKGROUND INFORMATION**

### **NATIONAL WETLAND INVENTORY**

The *National Wetland Inventory (NWI) Mapping* completed by the U.S. Fish and Wildlife Service was reviewed as a part of this assessment (Figure 2). This mapping resource identified a wetland complex throughout the majority of the northwestern portion of the project site. This wetland site identified to continue offsite and was noted as palustrine, forested, seasonally flooded (PFOC); and palustrine, scrub-shrub, seasonally flooded (PSSC) within the project site.

### **STATE OF WASHINGTON PRIORITY HABITATS AND SPECIES**

The State of Washington *Priority Habitats and Species (PHS) Mapping* was reviewed as a part of this assessment (Figure 3). This mapping resource identified the same wetland areas within and adjacent to the project site as the NWI Mapping above.

### **STATE OF WASHINGTON DEPARTMENT OF FISH AND WILDLIFE**

The State of Washington Department of Fish and Wildlife (WDFW) *SalmonScape Mapping* was reviewed as a part of this assessment (Figure 4). This mapping resource did not identify any drainage corridors within or adjacent to the project site. This mapping resource did identify a pond generally adjacent to the eastern boundary in the central portion of the project site. This pond was not identified to provide habitats for salmonid fish species (genus *Oncorhynchus*).

### **STATE OF WASHINGTON DEPARTMENT OF NATURAL RESOURCES**

The State of Washington Department of Natural Resources (WDNR) *Water Type Mapping* was reviewed as a part of this assessment (Figure 5). This mapping resource generally identified the same wetland noted in the NWI Mapping Resource above within the project site. This mapping resource further noted a pond adjacent to the eastern boundary as noted in the WDFW Mapping above. This mapping noted this offsite pond as a Type F Water (fish-bearing).

### **CITY OF PUYALLUP MAPPING**

The *City of Puyallup Inventory Mapping* was reviewed as a part of this assessment (Figure 6). This mapping resource generally identified the wetland noted in the other mapping



resources above within the project site and adjacent properties. This wetland was further identified as “field verified” by the City of Puyallup.

## **PIERCE COUNTY MAPPING**

The *Pierce County Mapping* was reviewed as a part of this assessment. This mapping resource identified that the Base Flood Plain Elevation (BFE) noted at 419.5 feet elevation floodplain did not extend onto the project site. The northern portion of the project site was noted as 424 feet elevation and the southern portion at 434 feet elevation.

## **SOILS MAPPING**

The *Soil Mapping Inventory* completed by the Natural Resources Conservation Service was reviewed as a part of this assessment (Figure 7). This mapping resource identified the soil throughout the majority of project site as Norma fine sandy loam (26A). The Norma soil series is defined as poorly drained; as formed in alluvium under sedges; and as listed as a “hydric” soil.

This mapping resource further noted the southern portion of the project site to contain Everett gravelly sandy loam (13B). The Everett soils series is defined as somewhat excessively drained, as formed in glacial outwash, and as not listed as “hydric” soil.

## **PRIOR ASSESSMENTS**

Habitat Technologies had completed prior assessments for parcels within the surrounding area of the project site. These prior assessments had identified a wetland complex within the area. This wetland complex was ditched along the western boundary then entered a culvert within the Willow Springs Apartment complex. This drainage continued through a series of ditch lines, pipes, and culverts to eventually enter a Pierce County Storm Pond adjacent to 89<sup>th</sup> Avenue Court East. This storm pond did not appear to exhibit an outflow.

# **ONSITE ANALYSIS**

## **CRITERIA FOR CRITICAL AREAS IDENTIFICATION**

The City of Puyallup defines “critical areas” to include wetlands, fish and wildlife habitat areas, critical aquifer recharge areas, geologically hazardous areas, and frequently flooded areas. The critical areas assessment reported in this document has been limited to address wetlands, surface water drainages, and fish and wildlife habitat areas.

**Wetlands:** Wetlands are transitional areas between aquatic and upland habitats. In general terms, wetlands are lands where the extent and duration of saturation with water is the primary factor determining the nature of soil development and the types of plant and animal communities living in the soil and on its surface (Cowardin, et al., 1979). Wetlands are generally defined within land use regulations as "areas that are inundated or saturated by surface or groundwater at a frequency and duration sufficient to support, and that under normal circumstances do support, a prevalence of vegetation typically adapted for life in saturated soil conditions" (US Army Corps of Engineers 1987).

Wetlands exhibit three essential characteristics, all of which must be present for an area to meet the established criteria (United States Army Corps of Engineers, 1987 and United States Army Corps of Engineers, 2010). These essential characteristics are:

1. **Hydrophytic Vegetation:** The assemblage of macrophytes that occurs in areas where inundation or soil saturation is either permanent or of sufficient frequency and duration to influence plant occurrence. Hydrophytic vegetation is present when the plant community is dominated by species that require or can tolerate prolonged inundation or soil saturation during the growing season.
2. **Hydric Soil:** A soil that formed under conditions of saturation, flooding, or ponding long enough during the growing season to develop anaerobic conditions in the upper parts. Most hydric soils exhibit characteristic morphologies that result from recent periods of saturation or inundation. These processes result in distinctive characteristics that persist in the soil during both wet and dry periods.
3. **Wetland Hydrology:** Permanent or periodic inundation, or surface soil saturation, at least seasonally. Wetland hydrology indicators are used in combination with indicators of hydric soil and hydrophytic vegetation to define the area. Wetland hydrology indications provide evidence that the site has a continuing wetland hydrology regime. Where hydrology has not been altered vegetation and soils provide strong evidence that wetland hydrology is present.

**Fish and Wildlife Habitat Areas:** The City of Puyallup has defined "fish and wildlife habitat areas" to include those areas necessary for maintaining species in suitable habitats within their natural geographic distribution so that isolated subpopulations are not created as designated by WAC 365-190-080. These areas include:

- (a) Areas with which state or federally designated endangered, threatened, and sensitive species have a primary association;
- (b) Habitats of local importance, including but not limited to areas designated as priority habitat by the Department of Fish and Wildlife;
- (c) Streams and surface waters within the jurisdiction of the state of Washington; and
- (d) Land essential for preserving connections between habitats and open spaces.

## STUDY METHODS

Habitat Technologies completed a series of onsite assessments from May 2018 through December 2019 and then again during the summer and early fall of 2020. In addition, Habitat Technologies has completed similar critical areas assessments for the parcels associated with the project site as well as parcels located within the general area of the project site. The objective of this evaluation was to define and delineate potential critical areas (wetlands; drainage corridors; and fish and wildlife habitats) that may be present within or immediately adjacent to the project area. Onsite activities were completed in accordance with criteria and procedures established in the *Corps of Engineers Wetland Delineation Manual* (United States Army Corps of Engineers, 1987) with the *Regional Supplement to the Corps of Engineers Wetland Delineation Manual: Western Mountains, Valleys, and Coast Region* (United States Army Corps of Engineers, 2010); the *Washington State Wetland Rating System for Western Washington* (Hruby, 2014), the State of Washington Department of Natural Resources (WDNR) Forest Practice Rules (WAC 222-16-030), and the City of Puyallup Chapter 21.

## FIELD OBSERVATION

The project site was accessed via 43<sup>rd</sup> Avenue SW that formed the southern boundary of the project site. The southern portion of the project site appeared to contain a historic fill pad that was overgrown with blackberries and contained a small “tent city” during the onsite assessments period. The southern portion of the project site was also heavily littered with garbage and debris from the onsite campers. The majority of the central and northern portions of the project site were encumbered by a portion of a wetland complex that extended onto adjacent parcels. Representative field data are provided in Appendix A.

- **Plant Communities**

As noted above the southern project site had been modified by the placement of historic fill and had become overrun with primarily Himalayan blackberry (*Rubus armeniacus*).

The plant community located directly to the north of the historic fill placement was dominated by species typically associated with seasonal saturation or seasonal shallow ponding. Observed species included black cottonwood (*Populus trichocarpa*), red alder (*Alnus rubra*), Western red cedar (*Thuja plicata*), Oregon ash (*Fraxinus latifolia*), Pacific willow (*Salix lasiandra*), Sitka willow (*Salix sitchensis*), crabapple (*Pyrus fusca*), Douglas spiraea (*Spiraea douglasii*), salmonberry (*Rubus spectabilis*), Himalayan blackberry (*Rubus armeniacus*), Pacific ninebark (*Physocarpus capitatus*), black twinberry (*Lonicera involucrata*), red osier dogwood (*Cornus stolonifera*), Nootka rose (*Rosa nutkana*),

common lady fern (*Athyrium filix-femina*), deer fern (*Blechnum spicant*), maiden hair fern (*Adiantum pedatum*), cattail (*Typha latifolia*), skunk cabbage (*Lysichitum americanum*), small fruited bulrush (*Scirpus microcarpus*), slough sedge (*Carex obnupta*), water parsley (*Oenanthe sarmentosa*), speedwell (*Veronica scutellata*), buttercup (*Ranunculus repens*), curled dock (*Rumex crispus*), big leaf avens (*Geum macrophyllum*), reed canarygrass (*Phalaris arundinacea*), and reed mannagrass (*Glyceria grandis*). This plant community was identified as hydrophytic in character (i.e. typical of wetlands).

The eastern boundary the project site exhibited scattered areas of remnant upland forest community. Observed species included Douglas fir (*Pseudotsuga menziesii*), Western red cedar (*Thuja plicata*), Western hemlock (*Tsuga heterophylla*), red alder (*Alnus rubra*), big leaf maple (*Acer macrophyllum*), cherry (*Prunus* spp.), Himalayan blackberry, evergreen blackberry (*Rubus laciniatus*), salal (*Gaultheria shallon*), Oregon grape (*Berberis nervosa*), holly (*Ilex aquifolium*), rose (*Rosa* spp.), Indian plum (*Oemleria cerasiformis*), Pacific red elderberry (*Sambucus racemosa*), salmonberry (*Rubus spectabilis*), Oceanspray (*Holodiscus discolor*), foam flower (*Tiarella trifoliata*), sword fern (*Polystichum munitum*), bracken fern (*Pteridium aquilium*), nettle (*Urtica dioica*), bluegrass (*Poa* spp.), daisy (*Bellis perennis*), clover (*Trifolium* spp.), bleeding heart (*Dicentra Formosa*), and buttercup. This plant community was identified as non-hydrophytic in character (i.e. typical of uplands).

- **Hydrology Patterns**

Onsite hydrology appeared to be the result of seasonal stormwater runoff from onsite, seasonal stormwater runoff from adjacent parcels, public roadways, and onsite soils. The southern portion (prior fill area) of the project site appeared to drain moderately well and did not exhibit field indicators typically associated with wetland hydrology.

The majority of the project site appeared to drain somewhat poorly to poorly. A portion of a wetland complex within the area dominated the western portion of the project site to the north of the southern prior fill area. As noted during prior assessments this wetland was ditched along the western boundary of the wetland offsite to the northwest. Seasonal hydrology from the wetland then entered a culvert within the Willow Springs Apartment Complex. This hydrology continued through a series of ditch lines, pipes, and culverts to eventually enter a Pierce County Storm Pond adjacent to 89<sup>th</sup> Avenue Court East. This storm pond did not appear to exhibit an outflow.

- **Soils**

As noted above the project site had been modified by the historic prior placement of fill material in the southern portion of the project site. Within remnant upland areas the soil exhibited a gravelly sandy loam to gravelly loam texture and coloration typical of an Everett soil series. The surface soil typically exhibited a very dark grayish brown (10YR

3/2) coloration and a gravelly sandy loam to gravelly loam texture. The subsoil to a depth of approximately 20 inches also exhibited a dark brown (10YR 3/3) to brown (10YR 4/3) coloration, and gravelly sandy loam to gravelly loam texture. This soil was identified as non-hydric in character.

The soil identified within the northwestern portion of the project site exhibited a surface soil coloration of very dark grayish brown (10YR 3/2) to black (10YR 2/1). The subsoil varied from black (10YR 2/1) to dark grayish brown (10YR 4/2) and exhibited prominent redoximorphic features (i.e. depleted matrix and redox concentrations). Oxidized root channels were also very evident. The soil ranged from gravelly loam, silt loam, to muck in texture. The soils within the majority of the project site exhibited field characteristics typical of a hydric soil.

- **Fish and Wildlife**

Wildlife species observed or that would be reasonably expected to utilize the habitats provided within or adjacent to the project site would include red tailed hawk (*Buteo jamaicensis*), American crow (*Corvus brachynchos*), American robin (*Turdus migratorius*), black capped chickadee (*Parus atricapillus*), dark eyed junco (*Junco hyemalis*), rufous hummingbird (*Selasphorus rufus*), merlin (*Falco columbarius*), golden crowned sparrow (*Zonotrichia atricapilla*), mourning dove (*Zenaida macroura*), song sparrow (*Melospiza melodia*), white crowned sparrow (*Zonotrichia leucophrys*), house sparrow, house finch (*Carpodacus mexicanus*), starling (*Sturnus vulgaris*), American goldfinch (*Carduelis tristis*), purple finch (*Carpodacus purpureus*), violet green swallow (*Tachycineta thalassina*), tree swallow (*Tachycineta bicolor*), red winged blackbird (*Agelaius phoeniceus*), brewer blackbird (*Euphagus cyanocephalus*), marsh wren (*Cistothorus palustris*), great blue heron (*Ardea herodias*), common mallard (*Anas platyrhynchos*), Canada goose (*Branta canadensis*), northern flicker (*Colaptes auratus*), hairy woodpecker (*Picoides villosus*), black tailed deer (*Odocoileus hemionus*), raccoon (*Procyon lotor*), coyote (*Canis latrans*), striped skunk (*Mephitis mephitis*), opossum (*Didelphis virginianus*), deer mouse (*Peromyscus maniculatus*), shrew (*Sorex spp.*), Townsend mole (*Scapanus townsendii*), voles (*Microtus spp.*), Norway rat (*Rattus norvegicus*), bats (*Myotis spp.*), eastern gray squirrel (*Sciurus carolinensis*), common garter snake (*Thamnophis sirtalis*), Pacific treefrog (*Hyla regilla*), and red legged frog (*Rana aurora*).

The project site did not appear to provide and has not been documented to provide habitats for fish species. Surface water from the project site was also identified to enter an offsite, isolated Pierce County stormwater system.

**Wildlife Movement Corridors:** The project site was within a well urbanized area. As identified by onsite wildlife trials, small and medium sized mammals appeared to be moving throughout vacant parcels generally to the east and southeast of the project site.



The project site is also within the general area of the migratory movement of waterfowl and passerine birds.

**State Priority Species:** Several species identified by the State of Washington as “Priority Species” were observed onsite or potentially may utilize the project site. Priority species require protective measures for their survival due to their population status, sensitivity to habitat alteration, and/or recreational, commercial, or tribal importance.

**Game Species:** “Game species” are regulated by the State of Washington through recreational hunting bag limits, harvest seasons, and harvest area restrictions. Observed, documented, or reasonably expected “game species” within and adjacent to the project site included black tailed deer, mourning dove, common mallard, and Canada goose.

**State Monitored:** State Monitored species are native to Washington but require habitat that has limited availability, are indicators of environmental quality, require further assessment, have unresolved taxonomy, may be competing with other species of concern, or have significant popular appeal. Observed, documented, or reasonably expected “State Monitored” species within and adjacent to the project site included great blue heron.

**State Candidate:** State Candidate species are presently under review by the State of Washington Department of Fish and Wildlife (WDFW) for possible listing as endangered, threatened, or sensitive. No State Candidate species were observed or have been documented to use the habitats associated with the project site.

**State Sensitive:** State Sensitive species are native to Washington and is vulnerable to declining and is likely to become endangered or threatened throughout a significant portion of its range without cooperative management or removal of threats. No State Sensitive species were observed or have been documented to use the habitats associated with the project site.

**State Threatened:** State Threatened species means any wildlife species native to the state of Washington that is likely to become an endangered species within the foreseeable future throughout a significant portion of its range within the state without cooperative management or removal of threats. The project site did not appear and has not been documented to provide direct critical habitats for State Listed Threatened species.

**State Endangered:** State endangered species means any species native to the state of Washington that is seriously threatened with extinction throughout all or a significant portion of its range within the state. The project site did not appear and has not been documented to provide direct critical habitats for State Listed Endangered species.

**Federally Listed Species:** No federally listed endangered or threatened species were observed or have been documented to utilize the habitats provided by the project site. A single, federally listed “species of concern” – bald eagle – has been documented to utilize the habitats generally associated with the area lakes, ponds and the Puyallup River Corridor. However, the project site did not provide critical habitats for this species. This species may occasionally overfly the project site.

## CRITICAL AREAS DETERMINATION

### WETLANDS

Wetland determination was based on observations of hydrophytic vegetation, hydric soils, and wetland hydrology in accordance with the *Corps of Engineers Wetland Delineation Manual* (United States Army Corps of Engineers, 1987) with the *Regional Supplement to the Corps of Engineers Wetland Delineation Manual: Western Mountains, Valleys, and Coast Region* (United States Army Corps of Engineers, 2010). Based on these methods one (1) wetland area was identified to be associated with a topographic swale that dominated the northwestern portion of the project site.

WETLAND	CLASSIFICATION (USFWS)	CITY OF PUYALLUP CATEGORY	WDOE RATING SCORE	WDOE HABITAT SCORE
<b>A</b>	<b>PFOCd, PEMCd</b>	<b>III</b>	<b>18</b>	<b>5</b>

**Wetland A:** Wetland A was identified throughout the majority of the northwestern portion of the project site and to extend into adjacent parcels. Onsite Wetland A exhibited a mixed forest plant community. Offsite to the northwest this wetland also exhibited an emergent plant community. Seasonal hydrology from the wetland entered a culvert within the Willow Springs apartment complex offsite to the northwest. This hydrology continued through a series of ditch lines, pipes, and culverts then eventually entered a Pierce County storm pond adjacent to 89<sup>th</sup> Avenue Court East (Figure 8). This storm pond did not appear to exhibit an outflow. As such, Wetland A was identified within an isolated basin and not hydrologically connected by an above ground pathway to any downstream aquatic resources.

Wetland A met the U.S. Fish and Wildlife Service (USFWS) criteria for classification of palustrine, forested, seasonally flooded, ditched (PFOCd); and palustrine, emergent, seasonally flooded, ditched (PEMCd). Wetland A appeared to meet the criteria for designation as a City of Puyallup Category III Wetland and have an associated buffer of 60 feet in width for a moderate intensity land use. Wetland A achieved a total functions score of 18 points utilizing the Washington State Department of Ecology (WDOE) *Wetland Rating Form for Western Washington* (Appendix B).

## FISH AND WILDLIFE HABITAT AREAS

No areas were identified, or have been documented, with which state or federally designated endangered, threatened, and sensitive species have a primary association. In addition, no lands essential for preserving connections between habitats and open species were identified or previously documented. The City of Puyallup Category III Wetland identified within the project site appeared to meet the designation as a WDFW "priority habitat" and would be potentially subject to the jurisdiction of the State of Washington.

## SELECTED DEVELOPMENT ACTION

The *Selected Development Action* for the project site focuses on the development of a single duplex within the southern portion of the project site and the associated septic drainfield (primary and reserve) along the central-eastern boundary of the project site (Parcel 0419095022). The development of this duplex would be completed without direct adverse impacts to the identified onsite City of Puyallup Category III Wetland or any encroachment into the associated standard wetland buffer (see Site Plan).

## STANDARD OF CARE

This document has been completed by Habitat Technologies for use by **Mr. David Artz**. Prior to extensive site planning the findings documented in this document should be reviewed and verified by the City of Puyallup. Habitat Technologies has provided professional services that are in accordance with the degree of care and skill generally accepted in the nature of the work accomplished. No other warranties are expressed or implied. Habitat Technologies is not responsible for design costs incurred before this document is approved by the appropriate resource and permitting agencies.

*Bryan W. Peck*

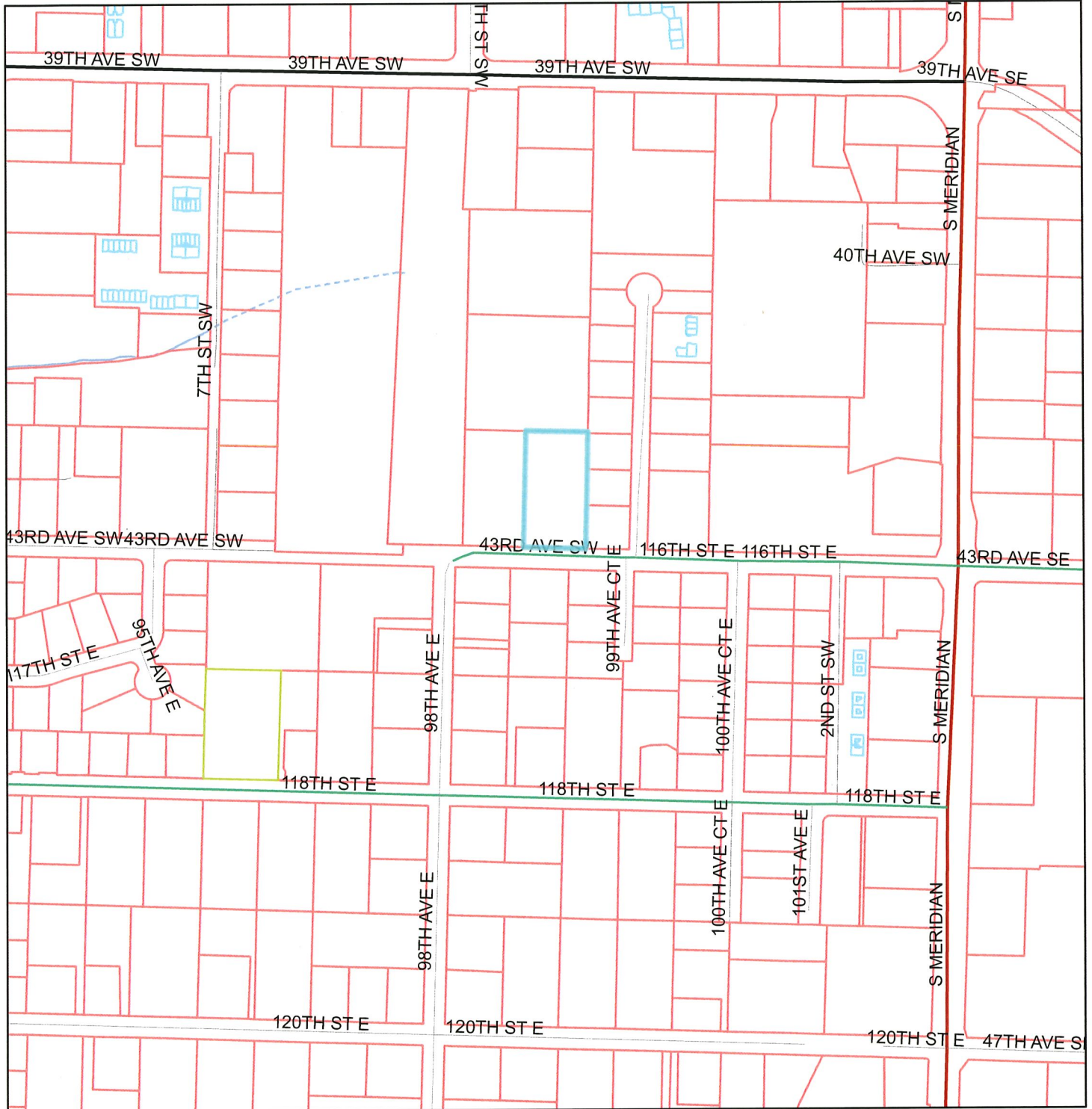
Bryan W. Peck  
Wetland Biologist

*Thomas D. Deming*

Thomas D. Deming, SPWS  
Habitat Technologies

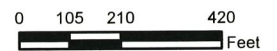
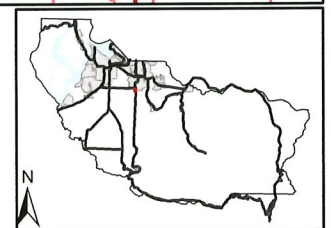
## FIGURES

# Figure 1 Site Vicinity



### Legend

- |                    |                              |                     |                            |
|--------------------|------------------------------|---------------------|----------------------------|
| <b>Tax Parcels</b> | <b>Roads</b>                 | Other State Highway | <b>Hydro - Centerlines</b> |
| Base Parcel        | Interstate Highway           | Major Road          | Pipe                       |
| Condominium        | Highway Ramp                 | Arterial            | Hydro Centerline           |
| Other              | Limited Access State Highway | Residential         |                            |
|                    |                              | Unknown             |                            |

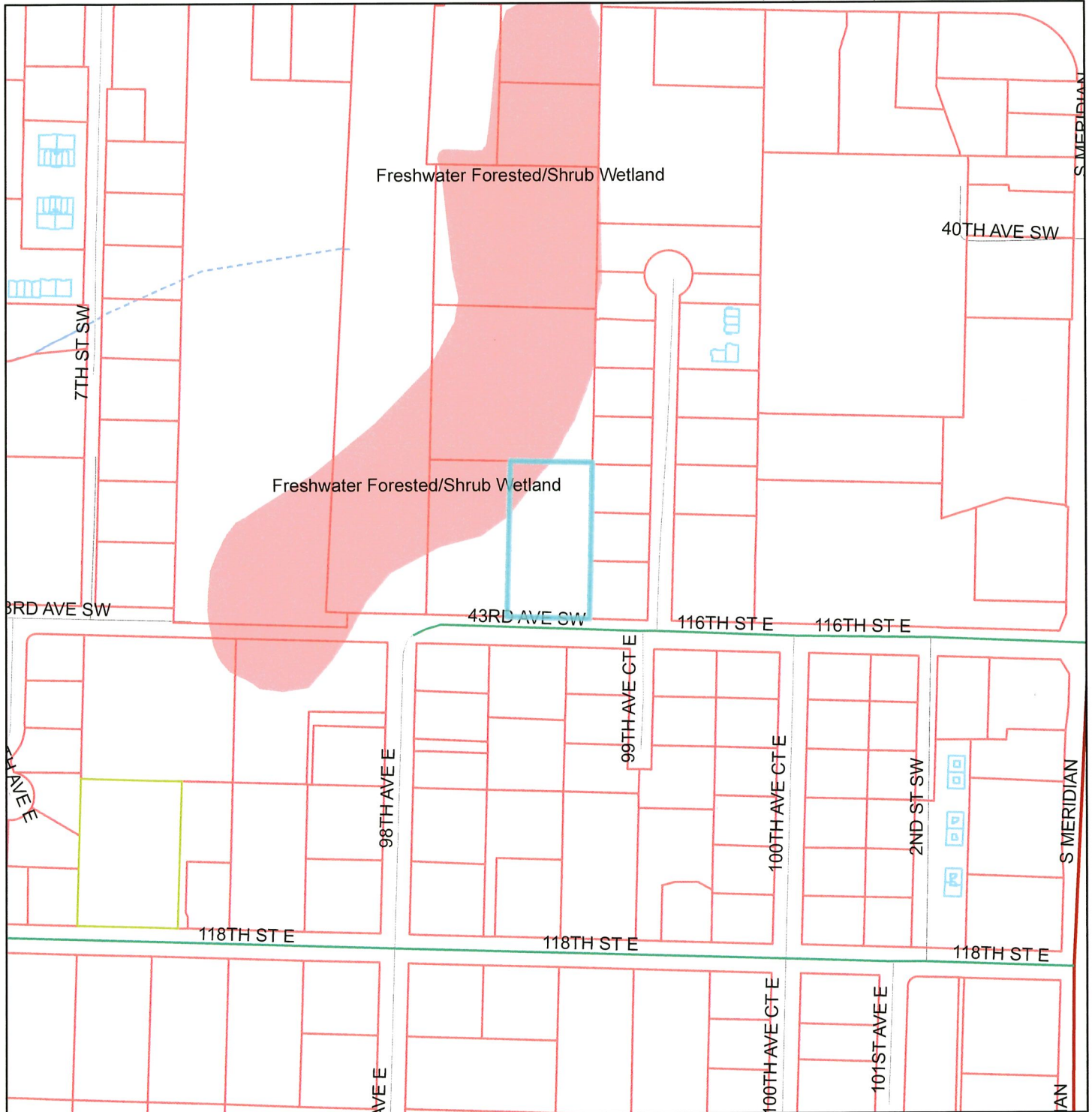


1:4,800

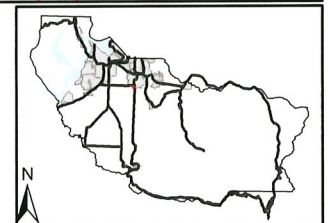
The map features are approximate and are intended only to provide an indication of said feature. Additional areas that have not been mapped may be present. This is not a survey. Orthophotos and other data may not align. The County assumes no liability for variations ascertained by actual survey. ALL DATA IS EXPRESSLY PROVIDED 'AS IS' AND 'WITH ALL FAULTS'. The County makes no warranty of fitness for a particular purpose.



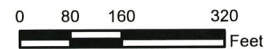
Figure 2 NWI Mapping



<b>Legend</b>		<ul style="list-style-type: none"> <li><span style="color: red;">—</span> Other State Highway</li> <li><span style="color: black;">—</span> Major Road</li> <li><span style="color: green;">—</span> Arterial</li> <li><span style="color: grey;">—</span> Residential</li> <li><span style="color: grey;">—</span> Unknown</li> <li><span style="color: blue;">—</span> Hydro Centerline</li> <li><span style="color: blue;">---</span> Pipe</li> </ul>	
<ul style="list-style-type: none"> <li><span style="border: 1px solid red; display: inline-block; width: 15px; height: 10px;"></span> Base Parcel</li> <li><span style="border: 1px solid blue; display: inline-block; width: 15px; height: 10px;"></span> Condominium</li> <li><span style="border: 1px solid green; display: inline-block; width: 15px; height: 10px;"></span> Other</li> </ul>	<ul style="list-style-type: none"> <li><span style="color: red;">—</span> Interstate Highway</li> <li><span style="color: red;">—</span> Highway Ramp</li> <li><span style="color: orange;">—</span> Limited Access State Highway</li> </ul>	<ul style="list-style-type: none"> <li><span style="background-color: lightred; display: inline-block; width: 15px; height: 10px;"></span> National Wetlands Inventory</li> </ul>	<p><b>Hydro - Centerlines</b></p>

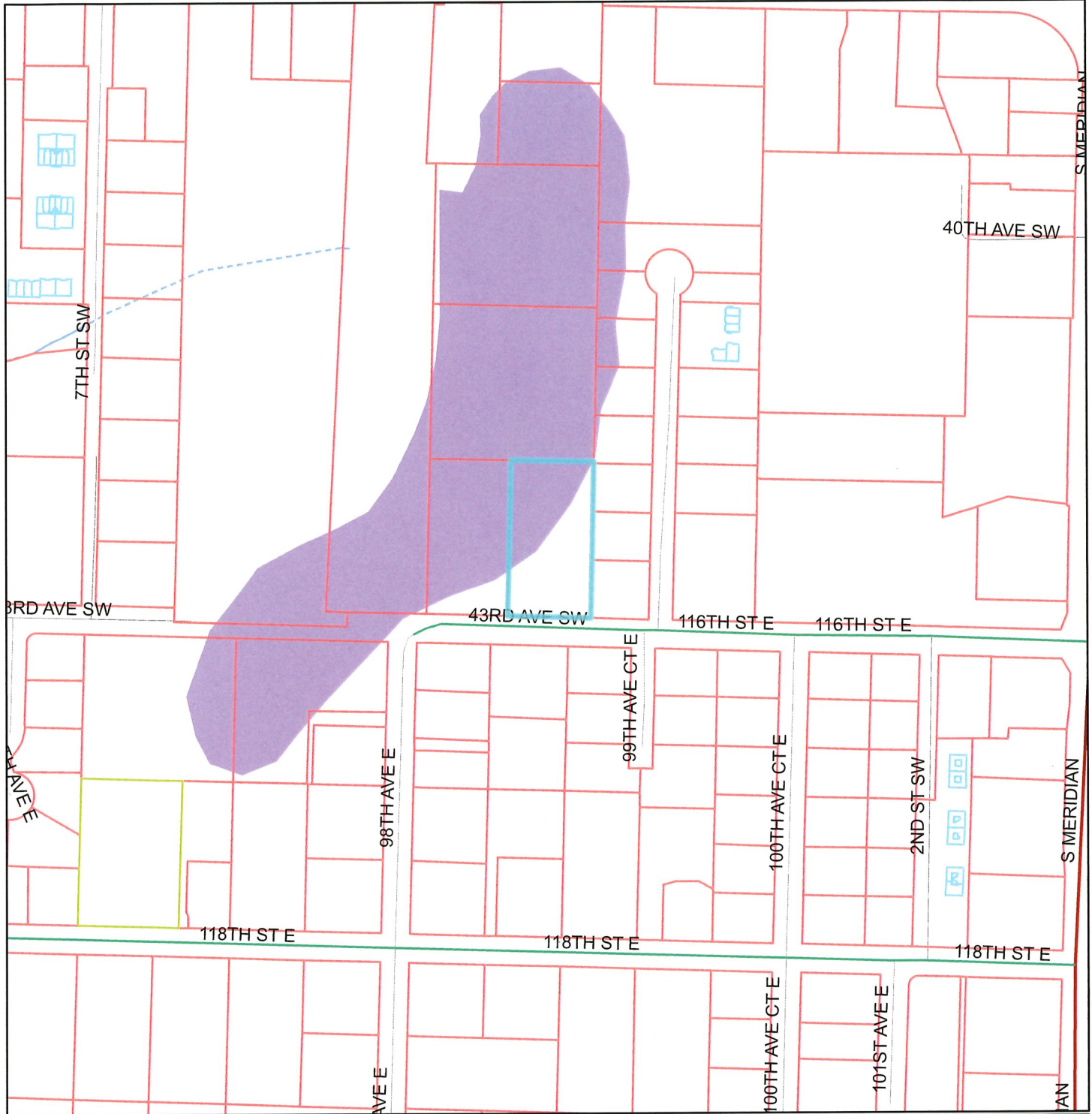


1:3,600

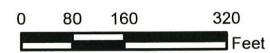
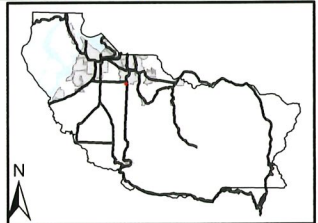


The map features are approximate and are intended only to provide an indication of said feature. Additional areas that have not been mapped may be present. This is not a survey. Orthophotos and other data may not align. The County assumes no liability for variations ascertained by actual survey. ALL DATA IS EXPRESSLY PROVIDED 'AS IS' AND 'WITH ALL FAULTS'. The County makes no warranty of fitness for a particular purpose.

Figure 3 PHS Mapping



<b>Legend</b>			
<b>Tax Parcels</b>	<b>Roads</b>	Other State Highway	Unknown
Base Parcel	Interstate Highway	Major Road	Hydro Centerline
Condominium	Highway Ramp	Arterial	Priority Habitat and Species
Other	Limited Access State Highway	Residential	Pipe

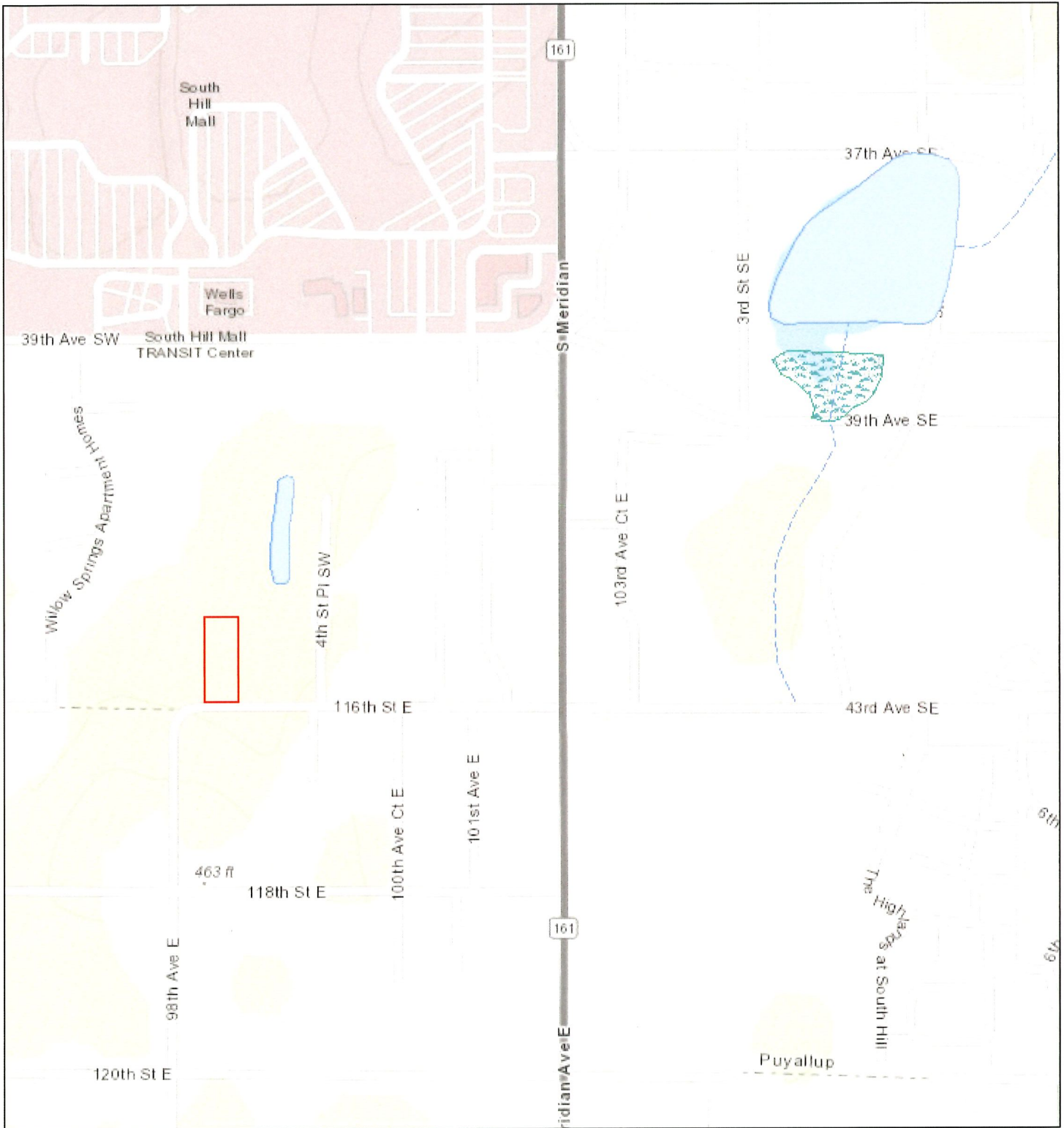


1:3,600

The map features are approximate and are intended only to provide an indication of said feature. Additional areas that have not been mapped may be present. This is not a survey. Orthophotos and other data may not align. The County assumes no liability for variations ascertained by actual survey. ALL DATA IS EXPRESSLY PROVIDED 'AS IS' AND 'WITH ALL FAULTS'. The County makes no warranty of fitness for a particular purpose.



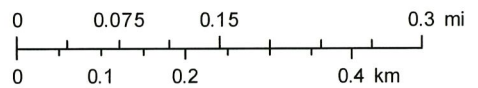
# Figure 4 WDFW Salmonscape Mapping



June 4, 2019

— All SalmonScape Species

1:9,028



USGS/NHD  
 Sources: Esri, HERE, Garmin, Intermap, increment P Corp., GEBCO, USGS, FAO, NPS, NRCAN, GeoBase, IGN, Kadaster NL, Ordnance Survey, Esri Japan, METI, Esri China (Hong Kong), (c) OpenStreetMap contributors, and the GIS User Community



# Figure 5 Forest Practice Water Type Map

S10 T19.0N R04.0E, S03 T19.0N R04.0E, S04 T19.0N R04.0E  
S09 T19.0N R04.0E

Application #: \_\_\_\_\_



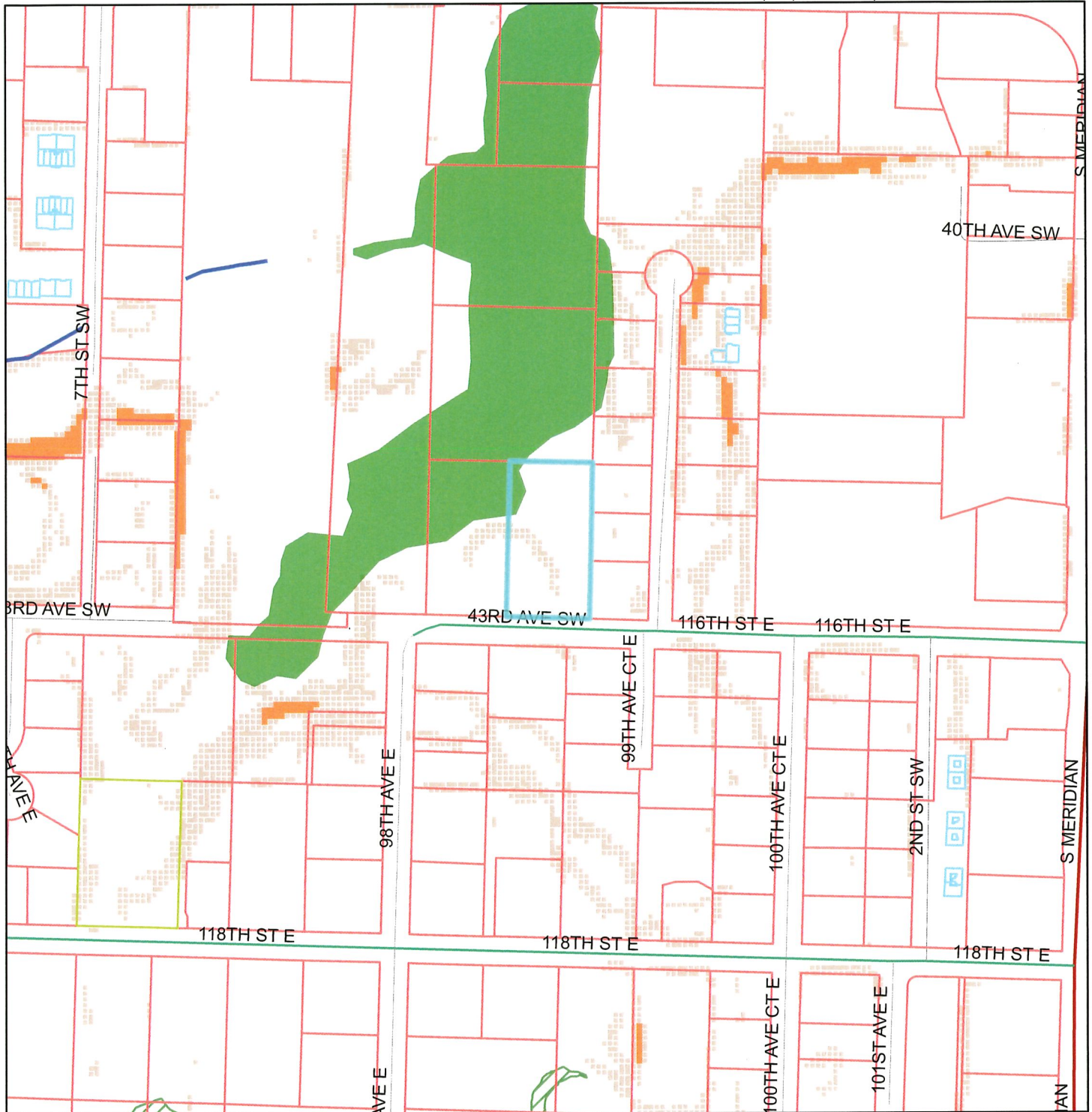
Date: 6/4/2019 Time: 3:20:46 PM

NAD 83 Scale: 1:4,800

Contour Interval: 40 Feet

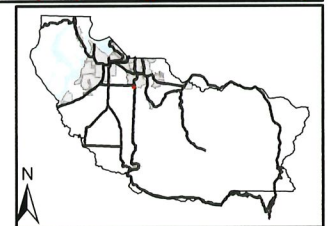


# Figure 6 City of Puyallup Mapping

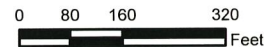


**Legend**

Streams - Puyallup	Limited Access State Highway	<b>Wetlands - Puyallup</b>	16% - 39%	16% - 39%	40% and Greater	40% and Greater	40% and Greater
Tax Parcels	Other State Highway	Field-verified Delineated	16% - 39%	16% - 39%	40% and Greater	40% and Greater	40% and Greater
Base Parcel	Major Road	Field-verified	16% - 39%	16% - 39%	40% and Greater	40% and Greater	40% and Greater
Condominium	Arterial	Unverified	16% - 39%	16% - 39%	40% and Greater	40% and Greater	40% and Greater
Other	Residential	Unverified	16% - 39%	16% - 39%	40% and Greater	40% and Greater	40% and Greater
<b>Roads</b>	Unknown	Buffer	16% - 39%	16% - 39%	40% and Greater	40% and Greater	40% and Greater
Interstate Highway		Mitigation Site	16% - 39%	16% - 39%	40% and Greater	40% and Greater	40% and Greater
Highway Ramp			16% - 39%	16% - 39%	40% and Greater	40% and Greater	40% and Greater



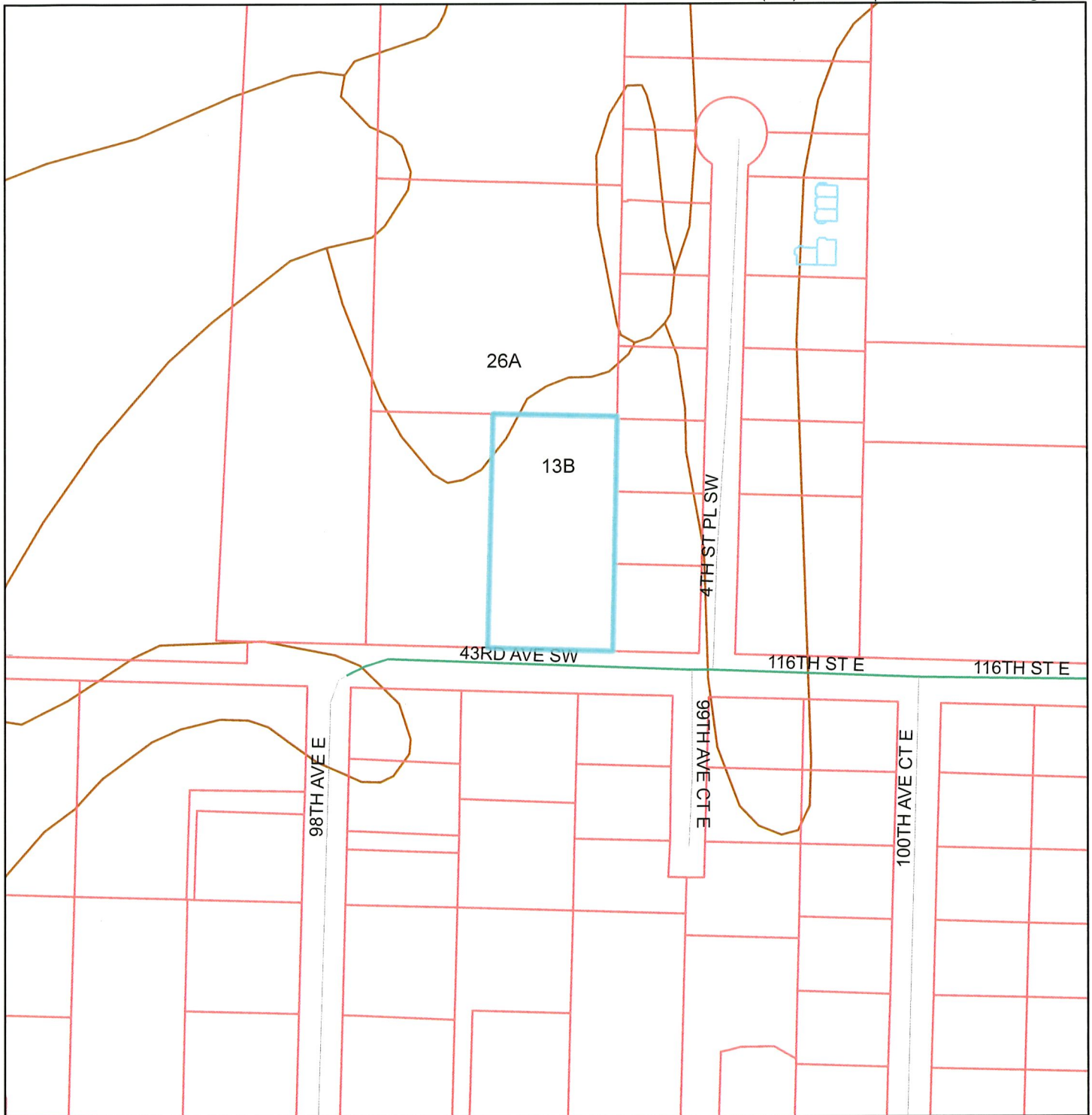
1:3,600



The map features are approximate and are intended only to provide an indication of said feature. Additional areas that have not been mapped may be present. This is not a survey. Orthophotos and other data may not align. The County assumes no liability for variations ascertained by actual survey. ALL DATA IS EXPRESSLY PROVIDED 'AS IS' AND 'WITH ALL FAULTS'. The County makes no warranty of fitness for a particular purpose.



# Figure 7 Soils Mapping



## Legend

### Tax Parcels

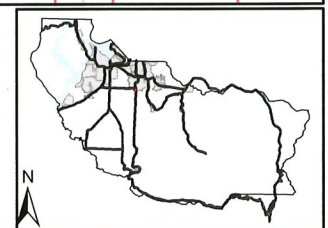
- Base Parcel
- Condominium
- Other

### Roads

- Interstate Highway
- Highway Ramp

- Limited Access State Highway
- Other State Highway
- Major Road

- Arterial
- Residential
- Unknown
- Soils



1:2,400

0 50 100 200 Feet

*The map features are approximate and are intended only to provide an indication of said feature. Additional areas that have not been mapped may be present. This is not a survey. Orthophotos and other data may not align. The County assumes no liability for variations ascertained by actual survey. ALL DATA IS EXPRESSLY PROVIDED 'AS IS' AND 'WITH ALL FAULTS'. The County makes no warranty of fitness for a particular purpose.*







## REFERENCE AND BACKGROUND LIST

Adamus, P.R., E.J. Clairain Jr., R.D. Smith, and R.E. Young. 1987. Wetland Evaluation Technique (WET); Volume II: Methodology, Operational Draft Technical Report Y-87, U.S. Army Engineer Waterways Experiment Station, Vicksburg, Mississippi.

Cowardin, Lewis M. et al, 1979. Classification of Wetlands and Deepwater Habitats of the United States. Office of Biological Services, U.S. Fish and Wildlife Service, U.S. Department of the Interior, FWS/OBS-79/31.

Hitchcock, C.L., A. Cronquist. 1977. Flora of the Pacific Northwest. University of Washington Press. Seattle, Washington.

Hruby, T. 2008. Washington State Wetland Rating System for Western Washington: 2008 Update. Publication #08-06-029. Olympia, WA: Washington Department of Ecology.

Hruby, T. 2014. Washington State Wetland Rating System for Western Washington: 2014 Update. Publication #14-06-029. Olympia, WA: Washington Department of Ecology.

Lichvar, R.W., D.L. Banks, W.N. Kirchner, and N.C. Melvin. 2016. The National Wetlands Plant List: 2016 wetland ratings. Phytoneuron 2016-30: 1-17. Published 28 April 2016. ISSN 2153 733X. <http://wetland-plands.usace.army.mil/>

Reppert, R.T., W. Sigleo, E. Stakhiv, L. Messman, and C. Meyers. 1979. Wetland Values - Concepts and Methods for Wetland Evaluation. Research Report 79-R1, U.S. Army Corps of Engineers, Institute for Water Resources, Fort Belvoir, Virginia.

United States Army Corps of Engineers, 1987. Wetlands Delineation Manual. Technical Report Y-87-1, US Army Engineer Waterways Experiment Station, Vicksburg, Mississippi. March 1987.

United States Army Corps of Engineers. 2010. Regional Supplement to the Corps of Engineers Wetland Delineation Manual: Western Mountains, Valleys, and Coast Region (Version 2.0), Environmental Laboratory ERDC/EL TR-08-13.

US Climate Data, 2015 <http://www.usclimatedata.com/climate/tacoma/washington/united-states/uswa0441/0441/2014/1>

USDA Natural Resource Conservation Service Plants Database, 2015 (for hydrophytic plan classification): <http://plants.usda.gov/>

United States Department of Agriculture, Natural Resources Conservation Service. Web Soil Survey. 2016 <http://vewsoilsurvey.nrcs.usda.gov/app/newfeatures.2.3.htm>.

US Fish and Wildlife Service National Wetland Inventory Mapper, 2016 (for NWI wetland mapping): <http://www.fws.gov/wetlands/Data/Mapper.html>.

Washington State Department of Ecology. 1997. Washington State Wetlands Identification and Delineation Manual. Publication Number 96-94.

Washington State Department of Fish and Wildlife Priority Habitats and Species Maps 2016 <http://wdfw.wa.gov/mapping/phs/>

Washington State Department of Fish and Wildlife SalmonScape Mapping System, 2016 (for fish presence): <http://apps.wdfw.wa.gov/salmonscape/map.html>

Washington State Department of Natural Resources FPARS Mapping System, 2016 (for stream typing): <http://fortess.wa.gov/dnr/app1/fpars/viewer.htm>

## **APPENDIX A – Representative Field Data**



Wetland name or number A

## WDFW Priority Habitats

Priority habitats listed by WDFW (see complete descriptions of WDFW priority habitats, and the counties in which they can be found, in: Washington Department of Fish and Wildlife. 2008. Priority Habitat and Species List. Olympia, Washington. 177 pp. <http://wdfw.wa.gov/publications/00165/wdfw00165.pdf> or access the list from here: <http://wdfw.wa.gov/conservation/phs/list/>)

Count how many of the following priority habitats are within 330 ft (100 m) of the wetland unit: **NOTE:** *This question is independent of the land use between the wetland unit and the priority habitat.*

- **Aspen Stands:** Pure or mixed stands of aspen greater than 1 ac (0.4 ha).
- **Biodiversity Areas and Corridors:** Areas of habitat that are relatively important to various species of native fish and wildlife (*full descriptions in WDFW PHS report*).
- **Herbaceous Balds:** Variable size patches of grass and forbs on shallow soils over bedrock.
- Old-growth/Mature forests:** Old-growth west of Cascade crest – Stands of at least 2 tree species, forming a multi-layered canopy with occasional small openings; with at least 8 trees/ac (20 trees/ha) > 32 in (81 cm) dbh or > 200 years of age. Mature forests – Stands with average diameters exceeding 21 in (53 cm) dbh; crown cover may be less than 100%; decay, decadence, numbers of snags, and quantity of large downed material is generally less than that found in old-growth; 80-200 years old west of the Cascade crest.
- **Oregon White Oak:** Woodland stands of pure oak or oak/conifer associations where canopy coverage of the oak component is important (*full descriptions in WDFW PHS report p. 158 – see web link above*).
- **Riparian:** The area adjacent to aquatic systems with flowing water that contains elements of both aquatic and terrestrial ecosystems which mutually influence each other.
- **Westside Prairies:** Herbaceous, non-forested plant communities that can either take the form of a dry prairie or a wet prairie (*full descriptions in WDFW PHS report p. 161 – see web link above*).
- **Instream:** The combination of physical, biological, and chemical processes and conditions that interact to provide functional life history requirements for instream fish and wildlife resources.
- **Nearshore:** Relatively undisturbed nearshore habitats. These include Coastal Nearshore, Open Coast Nearshore, and Puget Sound Nearshore. (*full descriptions of habitats and the definition of relatively undisturbed are in WDFW report – see web link on previous page*).
- **Caves:** A naturally occurring cavity, recess, void, or system of interconnected passages under the earth in soils, rock, ice, or other geological formations and is large enough to contain a human.
- **Cliffs:** Greater than 25 ft (7.6 m) high and occurring below 5000 ft elevation.
- **Talus:** Homogenous areas of rock rubble ranging in average size 0.5 - 6.5 ft (0.15 - 2.0 m), composed of basalt, andesite, and/or sedimentary rock, including riprap slides and mine tailings. May be associated with cliffs.
- **Snags and Logs:** Trees are considered snags if they are dead or dying and exhibit sufficient decay characteristics to enable cavity excavation/use by wildlife. Priority snags have a diameter at breast height of > 20 in (51 cm) in western Washington and are > 6.5 ft (2 m) in height. Priority logs are > 12 in (30 cm) in diameter at the largest end, and > 20 ft (6 m) long.

**Note:** All vegetated wetlands are by definition a priority habitat but are not included in this list because they are addressed elsewhere.

# WETLAND DETERMINATION DATA FORM – Western Mountains, Valleys, and Coast Region

Project/Site: Artz Parcels City/County: Puyallup / Pierce Sampling Date: 29 AUG 2018  
 Applicant/Owner: \_\_\_\_\_ State: Washington Sampling Point: SP-1  
 Investigator(s): Habitat Technologies Section, Township, Range: S09, T19, R04E  
 Landform (hillslope, terrace, etc.): \_\_\_\_\_ Local relief (concave, convex, none): \_\_\_\_\_ Slope (%): \_\_\_\_\_  
 Subregion (LRR): A Lat: \_\_\_\_\_ Long: \_\_\_\_\_ Datum: \_\_\_\_\_  
 Soil Map Unit Name: Everett very gravelly sandy loam NWI classification: \_\_\_\_\_

Are climatic / hydrologic conditions on the site typical for this time of year? Yes  No  (If no, explain in Remarks.)  
 Are Vegetation \_\_\_\_\_, Soil \_\_\_\_\_, or Hydrology \_\_\_\_\_ significantly disturbed? Are "Normal Circumstances" present? Yes  No   
 Are Vegetation \_\_\_\_\_, Soil \_\_\_\_\_, or Hydrology \_\_\_\_\_ naturally problematic? (If needed, explain any answers in Remarks.)

**SUMMARY OF FINDINGS – Attach site map showing sampling point locations, transects, important features, etc.**

Hydrophytic Vegetation Present? Yes <input checked="" type="checkbox"/> No <input type="checkbox"/> Hydric Soil Present? Yes <input checked="" type="checkbox"/> No <input type="checkbox"/> Wetland Hydrology Present? Yes <input checked="" type="checkbox"/> No <input type="checkbox"/>	<b>Is the Sampled Area within a Wetland?</b> Yes <input checked="" type="checkbox"/> No <input type="checkbox"/>
Remarks: Wetland	

**VEGETATION – Use scientific names of plants.**

Stratum	Absolute % Cover	Dominant Species?	Indicator Status	Notes
<b>Tree Stratum</b> (Plot size: 15ft radius)				
1. <u>Populus trichocarpai</u>	<u>30</u>	<u>YES</u>	<u>FAC</u>	
2. <u>Alnus rubra</u>	<u>40</u>	<u>YES</u>	<u>FAC</u>	
3. _____				
4. _____				
	<u>70</u>	= Total Cover		
<b>Sapling/Shrub Stratum</b> (Plot size: 15ft radius)				
1. <u>Lonicera involucrata</u>	<u>30</u>	<u>YES</u>	<u>FAC</u>	
2. <u>Rubus spectabilis</u>	<u>25</u>	<u>YES</u>	<u>FAC</u>	
3. <u>Spiraea douglasii</u>	<u>15</u>	<u>YES</u>	<u>FACW</u>	
4. _____				
5. _____				
	<u>70</u>	= Total Cover		
<b>Herb Stratum</b> (Plot size: 15ft radius)				
1. <u>Carex obnupta</u>	<u>90</u>	<u>YES</u>	<u>OBL</u>	
2. _____				
3. _____				
4. _____				
5. _____				
6. _____				
7. _____				
8. _____				
9. _____				
10. _____				
11. _____				
	<u>90</u>	= Total Cover		
<b>Woody Vine Stratum</b> (Plot size: 15ft radius)				
1. _____				
2. _____				
	<u>0</u>	= Total Cover		
<b>% Bare Ground in Herb Stratum</b> <u>0</u>				

**Dominance Test worksheet:**  
 Number of Dominant Species That Are OBL, FACW, or FAC: 6 (A)  
 Total Number of Dominant Species Across All Strata: 6 (B)  
 Percent of Dominant Species That Are OBL, FACW, or FAC: 100 (A/B)

**Prevalence Index worksheet:**  
 Total % Cover of: \_\_\_\_\_ Multiply by:  
 OBL species \_\_\_\_\_ x 1 = \_\_\_\_\_  
 FACW species \_\_\_\_\_ x 2 = \_\_\_\_\_  
 FAC species \_\_\_\_\_ x 3 = \_\_\_\_\_  
 FACU species \_\_\_\_\_ x 4 = \_\_\_\_\_  
 UPL species \_\_\_\_\_ x 5 = \_\_\_\_\_  
 Column Totals: \_\_\_\_\_ (A) \_\_\_\_\_ (B)  
 Prevalence Index = B/A = \_\_\_\_\_

**Hydrophytic Vegetation Indicators:**  
 Rapid Test for Hydrophytic Vegetation  
 Dominance Test is >50%  
 Prevalence Index is ≤3.0<sup>1</sup>  
 Morphological Adaptations<sup>1</sup> (Provide supporting data in Remarks or on a separate sheet)  
 Wetland Non-Vascular Plants<sup>1</sup>  
 Problematic Hydrophytic Vegetation<sup>1</sup> (Explain)  
<sup>1</sup>Indicators of hydric soil and wetland hydrology must be present, unless disturbed or problematic.

**Hydrophytic Vegetation Present?** Yes  No

Remarks: \_\_\_\_\_

**SOIL**

Sampling Point: SP-1

**Profile Description: (Describe to the depth needed to document the indicator or confirm the absence of indicators.)**

Depth (inches)	Matrix		Redox Features			Loc <sup>2</sup>	Texture	Remarks
	Color (moist)	%	Color (moist)	%	Type <sup>1</sup>			
0-18	10YR 3/1	100					L	

<sup>1</sup>Type: C=Concentration, D=Depletion, RM=Reduced Matrix, CS=Covered or Coated Sand Grains.    <sup>2</sup>Location: PL=Pore Lining, M=Matrix.

**Hydric Soil Indicators: (Applicable to all LRRs, unless otherwise noted.)**

<input type="checkbox"/> Histosol (A1)	<input type="checkbox"/> Sandy Redox (S5)	<b>Indicators for Problematic Hydric Soils<sup>3</sup>:</b> <input type="checkbox"/> 2 cm Muck (A10) <input type="checkbox"/> Red Parent Material (TF2) <input type="checkbox"/> Very Shallow Dark Surface (TF12) <input type="checkbox"/> Other (Explain in Remarks)
<input type="checkbox"/> Histic Epipedon (A2)	<input type="checkbox"/> Stripped Matrix (S6)	
<input type="checkbox"/> Black Histic (A3)	<input type="checkbox"/> Loamy Mucky Mineral (F1) (except MLRA 1)	
<input type="checkbox"/> Hydrogen Sulfide (A4)	<input type="checkbox"/> Loamy Gleyed Matrix (F2)	
<input type="checkbox"/> Depleted Below Dark Surface (A11)	<input type="checkbox"/> Depleted Matrix (F3)	
<input checked="" type="checkbox"/> Thick Dark Surface (A12)	<input type="checkbox"/> Redox Dark Surface (F6)	
<input type="checkbox"/> Sandy Mucky Mineral (S1)	<input type="checkbox"/> Depleted Dark Surface (F7)	
<input type="checkbox"/> Sandy Gleyed Matrix (S4)	<input type="checkbox"/> Redox Depressions (F8)	

<sup>3</sup>Indicators of hydrophytic vegetation and wetland hydrology must be present, unless disturbed or problematic.

**Restrictive Layer (if present):**  
Type: \_\_\_\_\_  
Depth (inches): \_\_\_\_\_

**Hydric Soil Present?**    Yes     No

Remarks:

**HYDROLOGY**

**Wetland Hydrology Indicators:**

<u>Primary Indicators (minimum of one required; check all that apply)</u>	<u>Secondary Indicators (2 or more required)</u>
<input type="checkbox"/> Surface Water (A1) <input type="checkbox"/> High Water Table (A2) <input checked="" type="checkbox"/> Saturation (A3) <input checked="" type="checkbox"/> Water Marks (B1) <input type="checkbox"/> Sediment Deposits (B2) <input type="checkbox"/> Drift Deposits (B3) <input type="checkbox"/> Algal Mat or Crust (B4) <input type="checkbox"/> Iron Deposits (B5) <input checked="" type="checkbox"/> Surface Soil Cracks (B6) <input type="checkbox"/> Inundation Visible on Aerial Imagery (B7) <input checked="" type="checkbox"/> Sparsely Vegetated Concave Surface (B8)	<input checked="" type="checkbox"/> Water-Stained Leaves (B9) (except MLRA 1, 2, 4A, and 4B) <input type="checkbox"/> Salt Crust (B11) <input type="checkbox"/> Aquatic Invertebrates (B13) <input type="checkbox"/> Hydrogen Sulfide Odor (C1) <input type="checkbox"/> Oxidized Rhizospheres along Living Roots (C3) <input type="checkbox"/> Presence of Reduced Iron (C4) <input type="checkbox"/> Recent Iron Reduction in Tilled Soils (C6) <input type="checkbox"/> Stunted or Stressed Plants (D1) (LRR A) <input type="checkbox"/> Other (Explain in Remarks)

<input checked="" type="checkbox"/> Water-Stained Leaves (B9) (MLRA 1, 2, 4A, and 4B) <input type="checkbox"/> Drainage Patterns (B10) <input type="checkbox"/> Dry-Season Water Table (C2) <input type="checkbox"/> Saturation Visible on Aerial Imagery (C9) <input type="checkbox"/> Geomorphic Position (D2) <input type="checkbox"/> Shallow Aquitard (D3) <input type="checkbox"/> FAC-Neutral Test (D5) <input type="checkbox"/> Raised Ant Mounds (D6) (LRR A) <input type="checkbox"/> Frost-Heave Hummocks (D7)	<b>Field Observations:</b> Surface Water Present?    Yes <input type="checkbox"/> No <input checked="" type="checkbox"/> Depth (inches): _____ Water Table Present?    Yes <input type="checkbox"/> No <input checked="" type="checkbox"/> Depth (inches): _____ Saturation Present?    Yes <input checked="" type="checkbox"/> No <input type="checkbox"/> Depth (inches): <u>0</u> (includes capillary fringe)
---	--

**Wetland Hydrology Present?**    Yes     No

Describe Recorded Data (stream gauge, monitoring well, aerial photos, previous inspections), if available:

Remarks:

# WETLAND DETERMINATION DATA FORM – Western Mountains, Valleys, and Coast Region

Project/Site: Artz Parcels City/County: Puyallup / Pierce Sampling Date: 29 AUG 2018  
 Applicant/Owner: \_\_\_\_\_ State: Washington Sampling Point: SP-2  
 Investigator(s): Habitat Technologies Section, Township, Range: S09, T19, R04E  
 Landform (hillslope, terrace, etc.): \_\_\_\_\_ Local relief (concave, convex, none): \_\_\_\_\_ Slope (%): \_\_\_\_\_  
 Subregion (LRR): A Lat: \_\_\_\_\_ Long: \_\_\_\_\_ Datum: \_\_\_\_\_  
 Soil Map Unit Name: Everett very gravelly sandy loam NWI classification: \_\_\_\_\_

Are climatic / hydrologic conditions on the site typical for this time of year? Yes  No  (If no, explain in Remarks.)  
 Are Vegetation \_\_\_\_\_, Soil \_\_\_\_\_, or Hydrology \_\_\_\_\_ significantly disturbed? Are "Normal Circumstances" present? Yes  No   
 Are Vegetation \_\_\_\_\_, Soil \_\_\_\_\_, or Hydrology \_\_\_\_\_ naturally problematic? (If needed, explain any answers in Remarks.)

## SUMMARY OF FINDINGS – Attach site map showing sampling point locations, transects, important features, etc.

Hydrophytic Vegetation Present? Yes <input type="checkbox"/> No <input checked="" type="checkbox"/> Hydric Soil Present? Yes <input type="checkbox"/> No <input checked="" type="checkbox"/> Wetland Hydrology Present? Yes <input type="checkbox"/> No <input checked="" type="checkbox"/>	<b>Is the Sampled Area within a Wetland?</b> Yes <input type="checkbox"/> No <input checked="" type="checkbox"/>
Remarks: Upland	

## VEGETATION – Use scientific names of plants.

Tree Stratum (Plot size: 15ft radius)	Absolute % Cover	Dominant Species?	Indicator Status	Dominance Test worksheet:
1. <u>Pseudotsuga menziesii</u>	40	YES	FACU	Number of Dominant Species That Are OBL, FACW, or FAC: <u>2</u> (A)
2. <u>Alnus rubra</u>	20	YES	FAC	
3. _____	_____	_____	_____	Total Number of Dominant Species Across All Strata: <u>6</u> (B)
4. _____	_____	_____	_____	
60 = Total Cover				Percent of Dominant Species That Are OBL, FACW, or FAC: <u>33</u> (A/B)
<b>Sapling/Shrub Stratum (Plot size: 15ft radius)</b>				
1. <u>Alnus rubra</u>	40	YES	FACU	<b>Prevalence Index worksheet:</b> Total % Cover of: _____ Multiply by: OBL species _____ x 1 = _____ FACW species _____ x 2 = _____ FAC species _____ x 3 = _____ FACU species _____ x 4 = _____ UPL species _____ x 5 = _____ Column Totals: _____ (A) _____ (B)  Prevalence Index = B/A = _____
2. <u>Gaultheria shallon</u>	10	YES	FACU	
3. <u>Rubus spectabilis</u>	30	YES	FAC	
4. _____	_____	_____	_____	
5. _____	_____	_____	_____	
80 = Total Cover				<b>Hydrophytic Vegetation Indicators:</b> <input type="checkbox"/> Rapid Test for Hydrophytic Vegetation <input type="checkbox"/> Dominance Test is >50% <input type="checkbox"/> Prevalence Index is ≤3.0 <sup>1</sup> <input type="checkbox"/> Morphological Adaptations <sup>1</sup> (Provide supporting data in Remarks or on a separate sheet) <input type="checkbox"/> Wetland Non-Vascular Plants <sup>1</sup> <input type="checkbox"/> Problematic Hydrophytic Vegetation <sup>1</sup> (Explain) <sup>1</sup> Indicators of hydric soil and wetland hydrology must be present, unless disturbed or problematic.
<b>Herb Stratum (Plot size: 15ft radius)</b>				
1. <u>Polystichum munitum</u>	30	YES	FACU	
2. _____	_____	_____	_____	
3. _____	_____	_____	_____	
4. _____	_____	_____	_____	
5. _____	_____	_____	_____	
6. _____	_____	_____	_____	
7. _____	_____	_____	_____	
8. _____	_____	_____	_____	
9. _____	_____	_____	_____	
10. _____	_____	_____	_____	
11. _____	_____	_____	_____	
30 = Total Cover				<b>Hydrophytic Vegetation Present?</b> Yes <input type="checkbox"/> No <input checked="" type="checkbox"/>
<b>Woody Vine Stratum (Plot size: 15ft radius)</b>				
1. _____	_____	_____	_____	
2. _____	_____	_____	_____	
0 = Total Cover				
<b>% Bare Ground in Herb Stratum</b> <u>0</u>				

Remarks:

**SOIL**

Sampling Point: SP-2

Profile Description: (Describe to the depth needed to document the indicator or confirm the absence of indicators.)								
Depth (inches)	Matrix		Redox Features			Loc <sup>2</sup>	Texture	Remarks
	Color (moist)	%	Color (moist)	%	Type <sup>1</sup>			
0-10	10YR 3/2	100					GSL	
10-18	10YR-4/3	100					GSL	
<sup>1</sup> Type: C=Concentration, D=Depletion, RM=Reduced Matrix, CS=Covered or Coated Sand Grains. <sup>2</sup> Location: PL=Pore Lining, M=Matrix.								
<b>Hydric Soil Indicators: (Applicable to all LRRs, unless otherwise noted.)</b>						<b>Indicators for Problematic Hydric Soils<sup>3</sup>:</b>		
<input type="checkbox"/> Histosol (A1)		<input type="checkbox"/> Sandy Redox (S5)		<input type="checkbox"/> 2 cm Muck (A10)		<input type="checkbox"/> Red Parent Material (TF2)		
<input type="checkbox"/> Histic Epipedon (A2)		<input type="checkbox"/> Stripped Matrix (S6)		<input type="checkbox"/> Loamy Mucky Mineral (F1) (except MLRA 1)		<input type="checkbox"/> Very Shallow Dark Surface (TF12)		
<input type="checkbox"/> Black Histic (A3)		<input type="checkbox"/> Loamy Gleyed Matrix (F2)		<input type="checkbox"/> Loamy Mucky Mineral (F1) (except MLRA 1)		<input type="checkbox"/> Other (Explain in Remarks)		
<input type="checkbox"/> Hydrogen Sulfide (A4)		<input type="checkbox"/> Depleted Matrix (F3)		<input type="checkbox"/> Depleted Matrix (F3)		<input type="checkbox"/> Other (Explain in Remarks)		
<input type="checkbox"/> Depleted Below Dark Surface (A11)		<input type="checkbox"/> Redox Dark Surface (F6)		<input type="checkbox"/> Redox Dark Surface (F6)		<input type="checkbox"/> Other (Explain in Remarks)		
<input type="checkbox"/> Thick Dark Surface (A12)		<input type="checkbox"/> Depleted Dark Surface (F7)		<input type="checkbox"/> Depleted Dark Surface (F7)		<input type="checkbox"/> Other (Explain in Remarks)		
<input type="checkbox"/> Sandy Mucky Mineral (S1)		<input type="checkbox"/> Redox Depressions (F8)		<input type="checkbox"/> Redox Depressions (F8)		<input type="checkbox"/> Other (Explain in Remarks)		
<input type="checkbox"/> Sandy Gleyed Matrix (S4)		<input type="checkbox"/> Redox Depressions (F8)		<input type="checkbox"/> Redox Depressions (F8)		<input type="checkbox"/> Other (Explain in Remarks)		
<b>Restrictive Layer (if present):</b> Type: _____ Depth (inches): _____						<b>Hydric Soil Present?</b> Yes <input type="checkbox"/> No <input checked="" type="checkbox"/>		
Remarks: _____								

**HYDROLOGY**

Wetland Hydrology Indicators:					
Primary Indicators (minimum of one required; check all that apply)			Secondary Indicators (2 or more required)		
<input type="checkbox"/> Surface Water (A1)	<input type="checkbox"/> High Water Table (A2)	<input type="checkbox"/> Saturation (A3)	<input type="checkbox"/> Water-Stained Leaves (B9) (except MLRA 1, 2, 4A, and 4B)	<input type="checkbox"/> Salt Crust (B11)	<input checked="" type="checkbox"/> Water-Stained Leaves (B9) (MLRA 1, 2, 4A, and 4B)
<input type="checkbox"/> Water Marks (B1)	<input type="checkbox"/> Sediment Deposits (B2)	<input type="checkbox"/> Drift Deposits (B3)	<input type="checkbox"/> Aquatic Invertebrates (B13)	<input type="checkbox"/> Hydrogen Sulfide Odor (C1)	<input type="checkbox"/> Drainage Patterns (B10)
<input type="checkbox"/> Algal Mat or Crust (B4)	<input type="checkbox"/> Iron Deposits (B5)	<input type="checkbox"/> Surface Soil Cracks (B6)	<input type="checkbox"/> Oxidized Rhizospheres along Living Roots (C3)	<input type="checkbox"/> Presence of Reduced Iron (C4)	<input type="checkbox"/> Dry-Season Water Table (C2)
<input type="checkbox"/> Inundation Visible on Aerial Imagery (B7)	<input type="checkbox"/> Sparsely Vegetated Concave Surface (B8)		<input type="checkbox"/> Recent Iron Reduction in Tilled Soils (C6)	<input type="checkbox"/> Stunted or Stressed Plants (D1) (LRR A)	<input type="checkbox"/> Saturation Visible on Aerial Imagery (C9)
			<input type="checkbox"/> Other (Explain in Remarks)		<input type="checkbox"/> Geomorphic Position (D2)
					<input type="checkbox"/> Shallow Aquitard (D3)
					<input type="checkbox"/> FAC-Neutral Test (D5)
					<input type="checkbox"/> Raised Ant Mounds (D6) (LRR A)
					<input type="checkbox"/> Frost-Heave Hummocks (D7)
<b>Field Observations:</b> Surface Water Present?    Yes <input type="checkbox"/> No <input checked="" type="checkbox"/> Depth (inches): _____ Water Table Present?    Yes <input type="checkbox"/> No <input checked="" type="checkbox"/> Depth (inches): _____ Saturation Present?    Yes <input type="checkbox"/> No <input checked="" type="checkbox"/> Depth (inches): _____ (includes capillary fringe)					
<b>Wetland Hydrology Present?</b> Yes <input type="checkbox"/> No <input checked="" type="checkbox"/>					
Describe Recorded Data (stream gauge, monitoring well, aerial photos, previous inspections), if available: _____					
Remarks: _____					



# WETLAND DETERMINATION DATA FORM – Western Mountains, Valleys, and Coast Region

Project/Site: Artz Parcels City/County: Puyallup / Pierce Sampling Date: 29 AUG 2018  
 Applicant/Owner: \_\_\_\_\_ State: Washington Sampling Point: SP-3  
 Investigator(s): Habitat Technologies Section, Township, Range: S09, T19, R04E  
 Landform (hillslope, terrace, etc.): \_\_\_\_\_ Local relief (concave, convex, none): \_\_\_\_\_ Slope (%): \_\_\_\_\_  
 Subregion (LRR): A Lat: \_\_\_\_\_ Long: \_\_\_\_\_ Datum: \_\_\_\_\_  
 Soil Map Unit Name: Everett very gravelly sandy loam NWI classification: \_\_\_\_\_

Are climatic / hydrologic conditions on the site typical for this time of year? Yes  No  (If no, explain in Remarks.)  
 Are Vegetation \_\_\_\_\_, Soil \_\_\_\_\_, or Hydrology \_\_\_\_\_ significantly disturbed? Are "Normal Circumstances" present? Yes  No   
 Are Vegetation \_\_\_\_\_, Soil \_\_\_\_\_, or Hydrology \_\_\_\_\_ naturally problematic? (If needed, explain any answers in Remarks.)

## SUMMARY OF FINDINGS – Attach site map showing sampling point locations, transects, important features, etc.

Hydrophytic Vegetation Present? Yes <input type="checkbox"/> No <input checked="" type="checkbox"/> Hydric Soil Present? Yes <input type="checkbox"/> No <input checked="" type="checkbox"/> Wetland Hydrology Present? Yes <input type="checkbox"/> No <input checked="" type="checkbox"/>	<b>Is the Sampled Area within a Wetland?</b> Yes <input type="checkbox"/> No <input checked="" type="checkbox"/>
Remarks: Upland	

## VEGETATION – Use scientific names of plants.

	Absolute % Cover	Dominant Species?	Indicator Status	
<b>Tree Stratum</b> (Plot size: 15ft radius)				
1. <u>Pseudotsuga menziesii</u>	<u>60</u>	<u>YES</u>	<u>FACU</u>	<b>Dominance Test worksheet:</b> Number of Dominant Species That Are OBL, FACW, or FAC: <u>1</u> (A)  Total Number of Dominant Species Across All Strata: <u>6</u> (B)  Percent of Dominant Species That Are OBL, FACW, or FAC: <u>17</u> (A/B)
2. _____	_____	_____	_____	
3. _____	_____	_____	_____	
4. _____	_____	_____	_____	
	<u>60</u>	= Total Cover		
<b>Sapling/Shrub Stratum</b> (Plot size: 15ft radius)				
1. <u>Acer circinatum</u>	<u>30</u>	<u>YES</u>	<u>FAC</u>	<b>Prevalence Index worksheet:</b> Total % Cover of: _____ Multiply by: OBL species _____ x 1 = _____ FACW species _____ x 2 = _____ FAC species _____ x 3 = _____ FACU species _____ x 4 = _____ UPL species _____ x 5 = _____ Column Totals: _____ (A) _____ (B)  Prevalence Index = B/A = _____
2. <u>Corylus cornuta</u>	<u>30</u>	<u>YES</u>	<u>FACU</u>	
3. <u>Cornus stolonifera</u>	<u>30</u>	<u>YES</u>	<u>FACU</u>	
4. <u>Kalmia latifolia</u>	<u>10</u>	<u>YES</u>	<u>FACU</u>	
5. _____	_____	_____	_____	
	<u>100</u>	= Total Cover		
<b>Herb Stratum</b> (Plot size: 15ft radius)				
1. <u>Hedera Helix</u>	<u>75</u>	<u>YES</u>	<u>FACU</u>	<b>Hydrophytic Vegetation Indicators:</b> <input type="checkbox"/> Rapid Test for Hydrophytic Vegetation <input type="checkbox"/> Dominance Test is >50% <input type="checkbox"/> Prevalence Index is ≤3.0 <sup>1</sup> <input type="checkbox"/> Morphological Adaptations <sup>1</sup> (Provide supporting data in Remarks or on a separate sheet) <input type="checkbox"/> Wetland Non-Vascular Plants <sup>1</sup> <input type="checkbox"/> Problematic Hydrophytic Vegetation <sup>1</sup> (Explain) <sup>1</sup> Indicators of hydric soil and wetland hydrology must be present, unless disturbed or problematic.
2. _____	_____	_____	_____	
3. _____	_____	_____	_____	
4. _____	_____	_____	_____	
5. _____	_____	_____	_____	
6. _____	_____	_____	_____	
7. _____	_____	_____	_____	
8. _____	_____	_____	_____	
9. _____	_____	_____	_____	
10. _____	_____	_____	_____	
11. _____	_____	_____	_____	
	<u>75</u>	= Total Cover		
<b>Woody Vine Stratum</b> (Plot size: 15ft radius)				
1. _____	_____	_____	_____	<b>Hydrophytic Vegetation Present?</b> Yes <input type="checkbox"/> No <input checked="" type="checkbox"/>
2. _____	_____	_____	_____	
	<u>0</u>	= Total Cover		
<b>% Bare Ground in Herb Stratum</b> <u>0</u>				

Remarks: \_\_\_\_\_

**SOIL**

Sampling Point: SP-3

Profile Description: (Describe to the depth needed to document the indicator or confirm the absence of indicators.)								
Depth (inches)	Matrix		Redox Features			Loc <sup>2</sup>	Texture	Remarks
	Color (moist)	%	Color (moist)	%	Type <sup>1</sup>			
0-18	10YR 4/3	100					GSL	

<sup>1</sup>Type: C=Concentration, D=Depletion, RM=Reduced Matrix, CS=Covered or Coated Sand Grains.      <sup>2</sup>Location: PL=Pore Lining, M=Matrix.

<b>Hydric Soil Indicators: (Applicable to all LRRs, unless otherwise noted.)</b> <input type="checkbox"/> Histosol (A1) <input type="checkbox"/> Histic Epipedon (A2) <input type="checkbox"/> Black Histic (A3) <input type="checkbox"/> Hydrogen Sulfide (A4) <input type="checkbox"/> Depleted Below Dark Surface (A11) <input type="checkbox"/> Thick Dark Surface (A12) <input type="checkbox"/> Sandy Mucky Mineral (S1) <input type="checkbox"/> Sandy Gleyed Matrix (S4)	<b>Indicators for Problematic Hydric Soils<sup>3</sup>:</b> <input type="checkbox"/> Sandy Redox (S5) <input type="checkbox"/> Stripped Matrix (S6) <input type="checkbox"/> Loamy Mucky Mineral (F1) (except MLRA 1) <input type="checkbox"/> Loamy Gleyed Matrix (F2) <input type="checkbox"/> Depleted Matrix (F3) <input type="checkbox"/> Redox Dark Surface (F6) <input type="checkbox"/> Depleted Dark Surface (F7) <input type="checkbox"/> Redox Depressions (F8)	<input type="checkbox"/> 2 cm Muck (A10) <input type="checkbox"/> Red Parent Material (TF2) <input type="checkbox"/> Very Shallow Dark Surface (TF12) <input type="checkbox"/> Other (Explain in Remarks)
--	--	--

<sup>3</sup>Indicators of hydrophytic vegetation and wetland hydrology must be present, unless disturbed or problematic.

<b>Restrictive Layer (if present):</b> Type: _____ Depth (inches): _____	<b>Hydric Soil Present?</b> Yes <input type="checkbox"/> No <input checked="" type="checkbox"/>
--	---

Remarks:

**HYDROLOGY**

<b>Wetland Hydrology Indicators:</b>	
<u>Primary Indicators (minimum of one required; check all that apply)</u> <input type="checkbox"/> Surface Water (A1) <input type="checkbox"/> High Water Table (A2) <input type="checkbox"/> Saturation (A3) <input type="checkbox"/> Water Marks (B1) <input type="checkbox"/> Sediment Deposits (B2) <input type="checkbox"/> Drift Deposits (B3) <input type="checkbox"/> Algal Mat or Crust (B4) <input type="checkbox"/> Iron Deposits (B5) <input type="checkbox"/> Surface Soil Cracks (B6) <input type="checkbox"/> Inundation Visible on Aerial Imagery (B7) <input type="checkbox"/> Sparsely Vegetated Concave Surface (B8)	<u>Secondary Indicators (2 or more required)</u> <input type="checkbox"/> Water-Stained Leaves (B9) (MLRA 1, 2, 4A, and 4B) <input type="checkbox"/> Salt Crust (B11) <input type="checkbox"/> Aquatic Invertebrates (B13) <input type="checkbox"/> Hydrogen Sulfide Odor (C1) <input type="checkbox"/> Oxidized Rhizospheres along Living Roots (C3) <input type="checkbox"/> Presence of Reduced Iron (C4) <input type="checkbox"/> Recent Iron Reduction in Tilled Soils (C6) <input type="checkbox"/> Stunted or Stressed Plants (D1) (LRR A) <input type="checkbox"/> Other (Explain in Remarks)

<b>Field Observations:</b> Surface Water Present?    Yes <input type="checkbox"/> No <input checked="" type="checkbox"/> Depth (inches): _____ Water Table Present?    Yes <input type="checkbox"/> No <input checked="" type="checkbox"/> Depth (inches): _____ Saturation Present?    Yes <input type="checkbox"/> No <input checked="" type="checkbox"/> Depth (inches): _____ (includes capillary fringe)	<b>Wetland Hydrology Present?</b> Yes <input type="checkbox"/> No <input checked="" type="checkbox"/>
---	---

Describe Recorded Data (stream gauge, monitoring well, aerial photos, previous inspections), if available:

Remarks:

# WETLAND DETERMINATION DATA FORM – Western Mountains, Valleys, and Coast Region

Project/Site: Artz Parcels City/County: Puyallup / Pierce Sampling Date: 29 AUG 2018  
 Applicant/Owner: \_\_\_\_\_ State: Washington Sampling Point: SP-6  
 Investigator(s): Habitat Technologies Section, Township, Range: S09, T19, R04E  
 Landform (hillslope, terrace, etc.): \_\_\_\_\_ Local relief (concave, convex, none): \_\_\_\_\_ Slope (%): \_\_\_\_\_  
 Subregion (LRR): A Lat: \_\_\_\_\_ Long: \_\_\_\_\_ Datum: \_\_\_\_\_  
 Soil Map Unit Name: Everett very gravelly sandy loam NWI classification: \_\_\_\_\_

Are climatic / hydrologic conditions on the site typical for this time of year? Yes  No  (If no, explain in Remarks.)  
 Are Vegetation \_\_\_\_\_, Soil \_\_\_\_\_, or Hydrology \_\_\_\_\_ significantly disturbed? Are "Normal Circumstances" present? Yes  No   
 Are Vegetation \_\_\_\_\_, Soil \_\_\_\_\_, or Hydrology \_\_\_\_\_ naturally problematic? (If needed, explain any answers in Remarks.)

## SUMMARY OF FINDINGS – Attach site map showing sampling point locations, transects, important features, etc.

Hydrophytic Vegetation Present? Yes <input checked="" type="checkbox"/> No <input type="checkbox"/> Hydric Soil Present? Yes <input checked="" type="checkbox"/> No <input type="checkbox"/> Wetland Hydrology Present? Yes <input checked="" type="checkbox"/> No <input type="checkbox"/>	<b>Is the Sampled Area within a Wetland?</b> Yes <input checked="" type="checkbox"/> No <input type="checkbox"/>
Remarks: Wetland	

## VEGETATION – Use scientific names of plants.

Tree Stratum (Plot size: 15ft radius)	Absolute % Cover	Dominant Species?	Indicator Status	Dominance Test worksheet:
1. <u>i</u>	_____	_____	_____	Number of Dominant Species That Are OBL, FACW, or FAC: <u>3</u> (A)  Total Number of Dominant Species Across All Strata: <u>4</u> (B)  Percent of Dominant Species That Are OBL, FACW, or FAC: <u>75</u> (A/B)
2. _____	_____	_____	_____	
3. _____	_____	_____	_____	
4. _____	_____	_____	_____	
	<u>0</u>	= Total Cover		
Sapling/Shrub Stratum (Plot size: 15ft radius)				<b>Prevalence Index worksheet:</b> Total % Cover of: _____ Multiply by: OBL species _____ x 1 = _____ FACW species _____ x 2 = _____ FAC species _____ x 3 = _____ FACU species _____ x 4 = _____ UPL species _____ x 5 = _____ Column Totals: _____ (A) _____ (B)  Prevalence Index = B/A = _____
1. <u>Cornus stolonifera</u>	<u>100</u>	<u>YES</u>	<u>FACW</u>	
2. <u>Rubus spectabilis</u>	<u>10</u>	<u>YES</u>	<u>FAC+</u>	
3. _____	_____	_____	_____	
4. _____	_____	_____	_____	
	<u>110</u>	= Total Cover		
Herb Stratum (Plot size: 15ft radius)				<b>Hydrophytic Vegetation Indicators:</b> <input type="checkbox"/> Rapid Test for Hydrophytic Vegetation <input checked="" type="checkbox"/> Dominance Test is >50% <input type="checkbox"/> Prevalence Index is ≤3.0 <sup>1</sup> <input type="checkbox"/> Morphological Adaptations <sup>1</sup> (Provide supporting data in Remarks or on a separate sheet) <input type="checkbox"/> Wetland Non-Vascular Plants <sup>1</sup> <input type="checkbox"/> Problematic Hydrophytic Vegetation <sup>1</sup> (Explain) <sup>1</sup> Indicators of hydric soil and wetland hydrology must be present, unless disturbed or problematic.
1. <u>Athyrium filix-femina</u>	<u>5</u>	<u>YES</u>	<u>FAC</u>	
2. <u>Lysichitum americanum</u>	<u>20</u>	<u>YES</u>	<u>OBL</u>	
3. _____	_____	_____	_____	
4. _____	_____	_____	_____	
5. _____	_____	_____	_____	
6. _____	_____	_____	_____	
7. _____	_____	_____	_____	
8. _____	_____	_____	_____	
9. _____	_____	_____	_____	
10. _____	_____	_____	_____	
11. _____	_____	_____	_____	
	<u>25</u>	= Total Cover		
Woody Vine Stratum (Plot size: 15ft radius)				<b>Hydrophytic Vegetation Present?</b> Yes <input checked="" type="checkbox"/> No <input type="checkbox"/>
1. _____	_____	_____	_____	
2. _____	_____	_____	_____	
	<u>0</u>	= Total Cover		
% Bare Ground in Herb Stratum <u>0</u>				
Remarks:				

**SOIL**

Sampling Point: SP-6

Profile Description: (Describe to the depth needed to document the indicator or confirm the absence of indicators.)							
Depth (inches)	Matrix		Redox Features			Texture	Remarks
	Color (moist)	%	Color (moist)	%	Type <sup>1</sup>		
0-20	10YR 2/1	100				SIL	

<sup>1</sup>Type: C=Concentration, D=Depletion, RM=Reduced Matrix, CS=Covered or Coated Sand Grains. <sup>2</sup>Location: PL=Pore Lining, M=Matrix.

**Hydric Soil Indicators: (Applicable to all LRRs, unless otherwise noted.)**

**Indicators for Problematic Hydric Soils<sup>3</sup>:**

- |  |   |
|--|---|
| <input type="checkbox"/> Histosol (A1)                       | <input type="checkbox"/> Sandy Redox (S5)                         |
| <input type="checkbox"/> Histic Epipedon (A2)                | <input type="checkbox"/> Stripped Matrix (S6)                     |
| <input type="checkbox"/> Black Histic (A3)                   | <input type="checkbox"/> Loamy Mucky Mineral (F1) (except MLRA 1) |
| <input type="checkbox"/> Hydrogen Sulfide (A4)               | <input type="checkbox"/> Loamy Gleyed Matrix (F2)                 |
| <input type="checkbox"/> Depleted Below Dark Surface (A11)   | <input type="checkbox"/> Depleted Matrix (F3)                     |
| <input checked="" type="checkbox"/> Thick Dark Surface (A12) | <input type="checkbox"/> Redox Dark Surface (F6)                  |
| <input type="checkbox"/> Sandy Mucky Mineral (S1)            | <input type="checkbox"/> Depleted Dark Surface (F7)               |
| <input type="checkbox"/> Sandy Gleyed Matrix (S4)            | <input type="checkbox"/> Redox Depressions (F8)                   |

- |   |
|---|
| <input type="checkbox"/> 2 cm Muck (A10)                  |
| <input type="checkbox"/> Red Parent Material (TF2)        |
| <input type="checkbox"/> Very Shallow Dark Surface (TF12) |
| <input type="checkbox"/> Other (Explain in Remarks)       |

<sup>3</sup>Indicators of hydrophytic vegetation and wetland hydrology must be present, unless disturbed or problematic.

**Restrictive Layer (if present):**

Type: \_\_\_\_\_  
Depth (inches): \_\_\_\_\_

Hydric Soil Present? Yes  No

Remarks:

**HYDROLOGY**

**Wetland Hydrology Indicators:**

Primary Indicators (minimum of one required; check all that apply)

Secondary Indicators (2 or more required)

- |   |  |   |
|---|--|---|
| <input type="checkbox"/> Surface Water (A1)                                 | <input checked="" type="checkbox"/> Water-Stained Leaves (B9) (except MLRA 1, 2, 4A, and 4B) | <input checked="" type="checkbox"/> Water-Stained Leaves (B9) (MLRA 1, 2, 4A, and 4B) |
| <input type="checkbox"/> High Water Table (A2)                              | <input type="checkbox"/> Salt Crust (B11)  | <input type="checkbox"/> Drainage Patterns (B10)                                      |
| <input checked="" type="checkbox"/> Saturation (A3)                         | <input type="checkbox"/> Aquatic Invertebrates (B13)   | <input type="checkbox"/> Dry-Season Water Table (C2)                                  |
| <input checked="" type="checkbox"/> Water Marks (B1)                        | <input type="checkbox"/> Hydrogen Sulfide Odor (C1)  | <input type="checkbox"/> Saturation Visible on Aerial Imagery (C9)                    |
| <input type="checkbox"/> Sediment Deposits (B2)                             | <input type="checkbox"/> Oxidized Rhizospheres along Living Roots (C3)                       | <input type="checkbox"/> Geomorphic Position (D2)                                     |
| <input type="checkbox"/> Drift Deposits (B3)                                | <input type="checkbox"/> Presence of Reduced Iron (C4)                                       | <input type="checkbox"/> Shallow Aquitard (D3)  |
| <input type="checkbox"/> Algal Mat or Crust (B4)                            | <input type="checkbox"/> Recent Iron Reduction in Tilled Soils (C6)                          | <input type="checkbox"/> FAC-Neutral Test (D5)  |
| <input type="checkbox"/> Iron Deposits (B5)                                 | <input type="checkbox"/> Stunted or Stressed Plants (D1) (LRR A)                             | <input type="checkbox"/> Raised Ant Mounds (D6) (LRR A)                               |
| <input checked="" type="checkbox"/> Surface Soil Cracks (B6)                | <input type="checkbox"/> Other (Explain in Remarks)  | <input type="checkbox"/> Frost-Heave Hummocks (D7)                                    |
| <input type="checkbox"/> Inundation Visible on Aerial Imagery (B7)          |  |   |
| <input checked="" type="checkbox"/> Sparsely Vegetated Concave Surface (B8) |  |   |

**Field Observations:**

Surface Water Present? Yes  No  Depth (inches): \_\_\_\_\_  
 Water Table Present? Yes  No  Depth (inches): \_\_\_\_\_  
 Saturation Present? Yes  No  Depth (inches): 0  
 (includes capillary fringe)

Wetland Hydrology Present? Yes  No

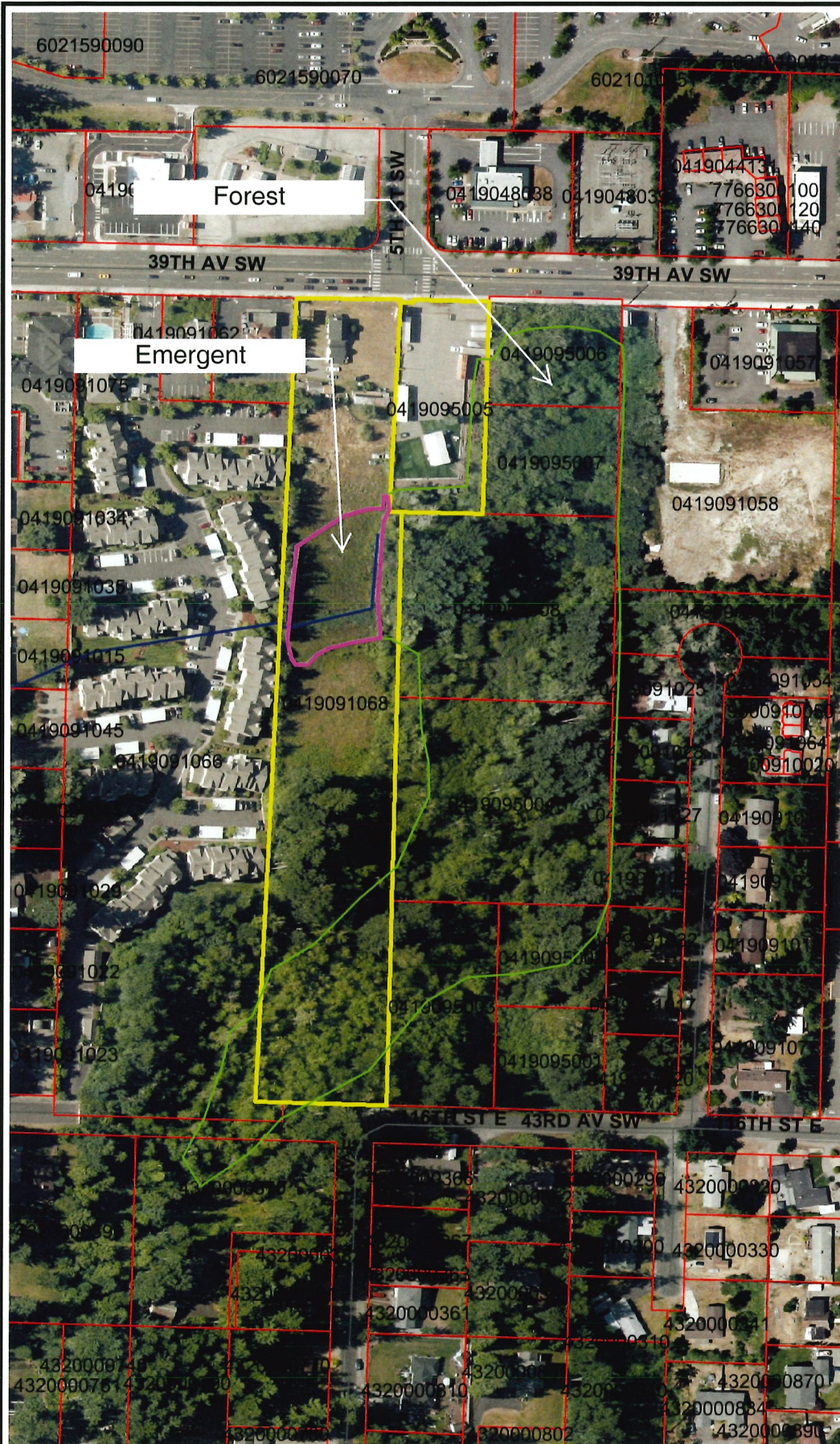
Describe Recorded Data (stream gauge, monitoring well, aerial photos, previous inspections), if available:

Remarks:

**SITE PLAN**



## **APPENDIX B – Wetland Rating Worksheet**



The map features are approximate and are intended only to provide an indication of said feature. Additional areas that have not been mapped may be present. This is not a survey. The orthophotos and other data may not align. Pierce County and Habitat Technologies assume no liability for variations ascertained by actual survey. All data is expressly provided AS IS and WITH ALL FAULTS. Pierce County and Habitat Technologies make no warranty of fitness for a particular purpose.

- ### Map Legend
- Highlighted Tax Parcels
  - Tax Parcels
  - Drainage - Main Lines
  - Hydro - Centerlines
  - Roads
  - County - 2014 - Ortho
  - Forested
  - Emergent

**Figure W1**



The map features are approximate and are intended only to provide an indication of said feature. Additional areas that have not been mapped may be present. This is not a survey. The orthophotos and other data may not align. Pierce County and Habitat Technologies assume no liability for variations ascertained by actual survey. All data is expressly provided AS IS and WITH ALL FAULTS. Pierce County and Habitat Technologies make no warranty of fitness for a particular purpose.

### Map Legend

- Highlighted Tax Parcels
- Tax Parcels
- Drainage - Main Lines
- Hydro - Centerlines
- Roads
- Hydro - Surface Boundaries
- County - 2014 - Ortho Permanent Ponding
- Seasonal Ponding
- Seasonal Saturation
- Area within 150 Feet of Wetland Boundary



**Figure W2**

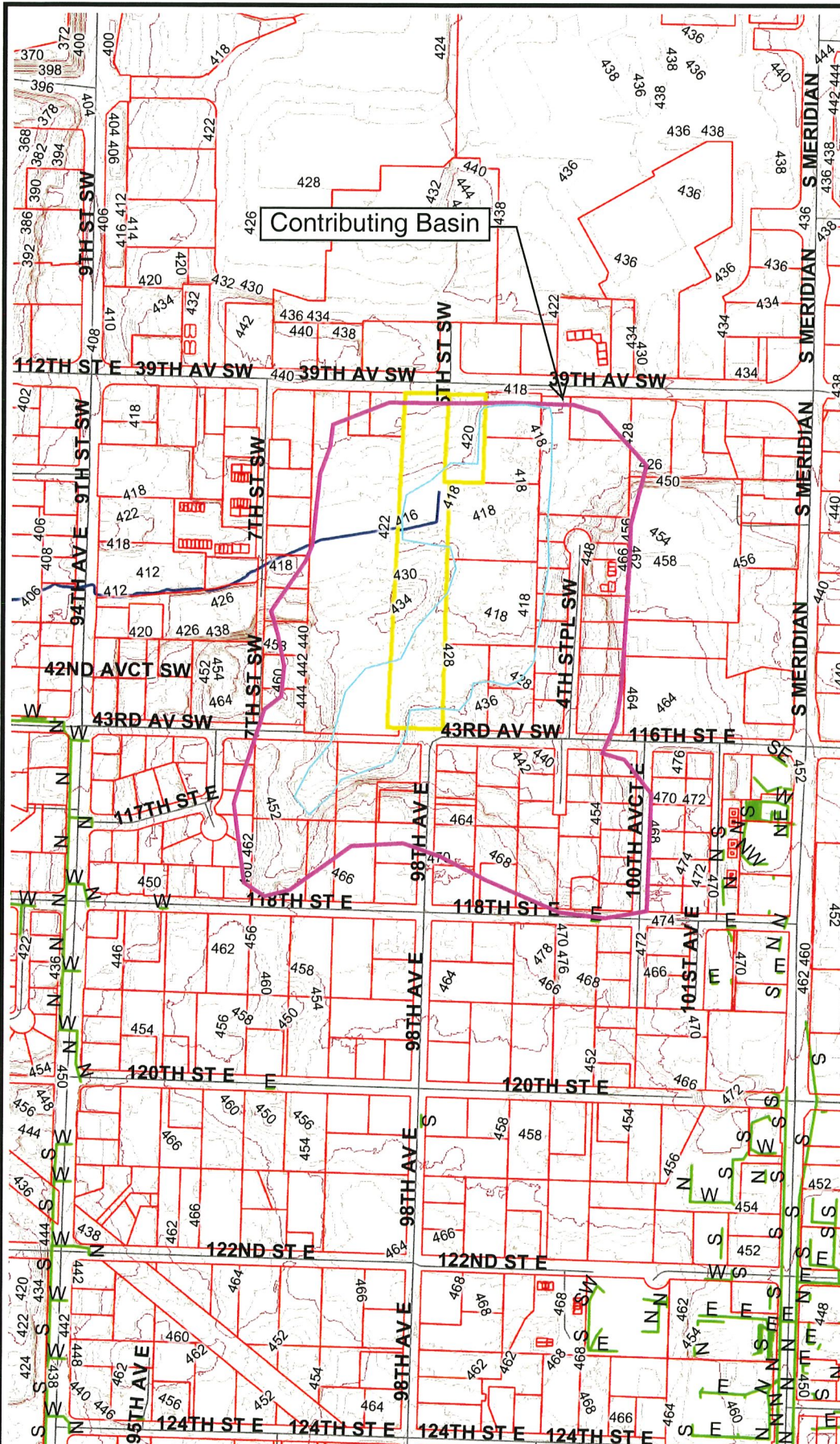




The map features are approximate and are intended only to provide an indication of said feature. Additional areas that have not been mapped may be present. This is not a survey. The orthophotos and other data may not align. Pierce County and Habitat Technologies assume no liability for variations ascertained by actual survey. All data is expressly provided AS IS and WITH ALL FAULTS. Pierce County and Habitat Technologies make no warranty of fitness for a particular purpose.

### Map Legend

- Highlighted Tax Parcels
- Tax Parcels
- Drainage - Main Lines
- Hydro - Centerlines
- Roads
- Contours - 2011
- 10' Contour Line
- 2' Contour Line
- Contributing Basin Area



**Figure W3**

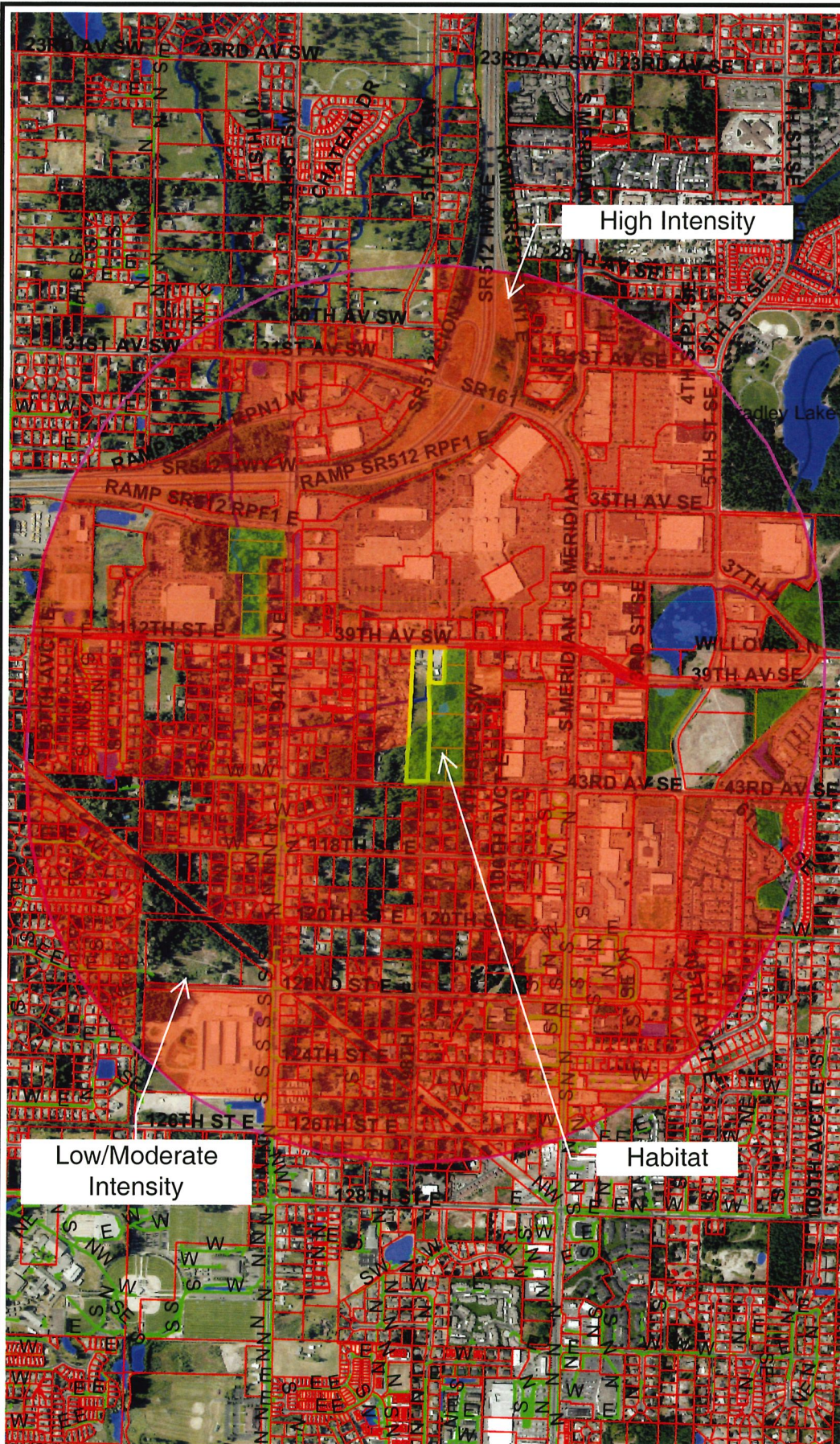




The map features are approximate and are intended only to provide an indication of said feature. Additional areas that have not been mapped may be present. This is not a survey. The orthophotos and other data may not align. Pierce County and Habitat Technologies assume no liability for variations ascertained by actual survey. All data is expressly provided AS IS and WITH ALL FAULTS. Pierce County and Habitat Technologies make no warranty of fitness for a particular purpose.

### Map Legend

- Highlighted Tax Parcels
- Tax Parcels
- Drainage - Main Lines
- Hydro - Centerlines
- Roads
- Hydro - Surface Boundaries
- County - 2014 - Ortho
  
- High Intensity Land Use
  
- Low/Moderate Intensity Land Use
  
- Habitat Area



High Intensity

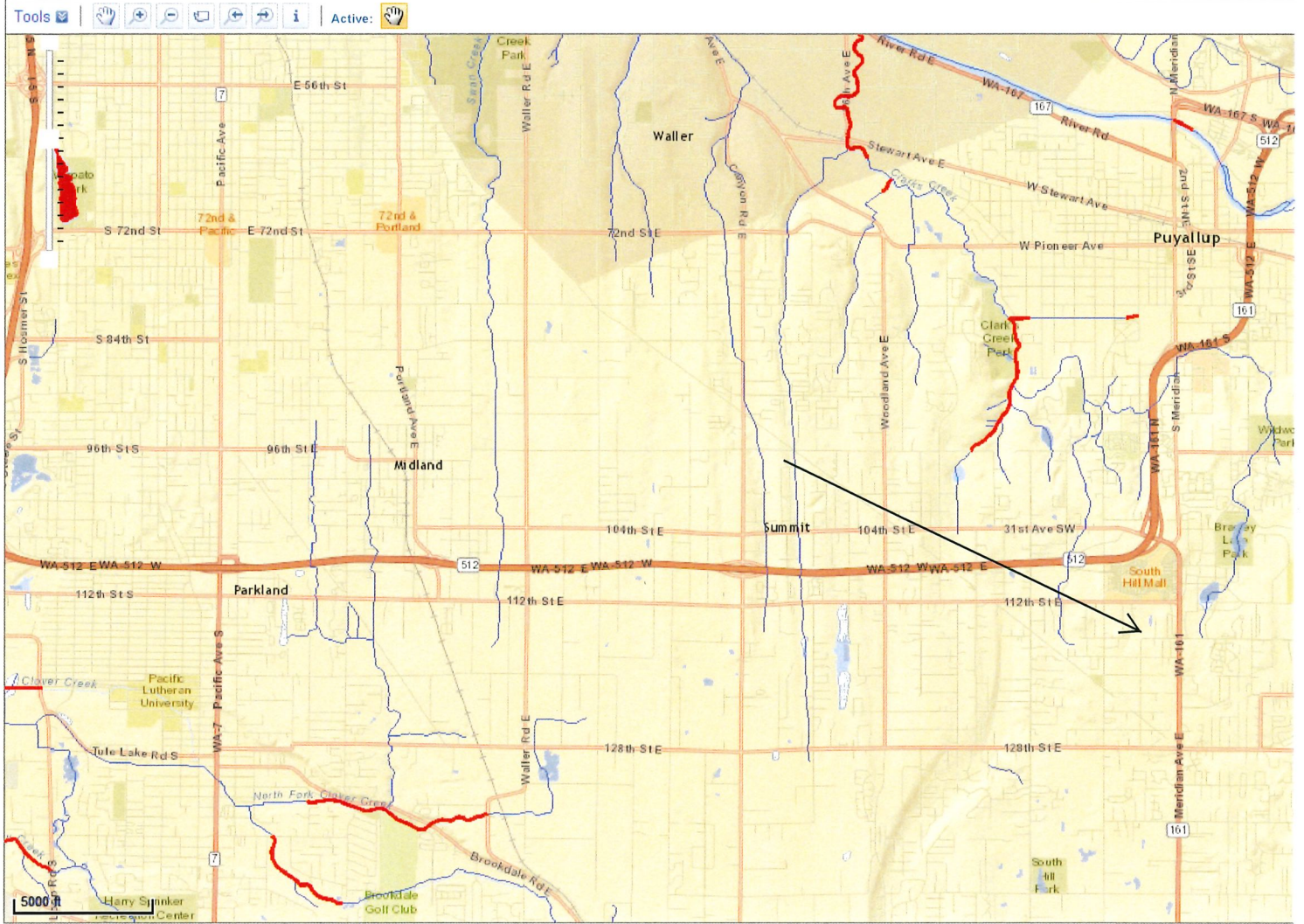
Low/Moderate Intensity

Habitat

**Figure W4**



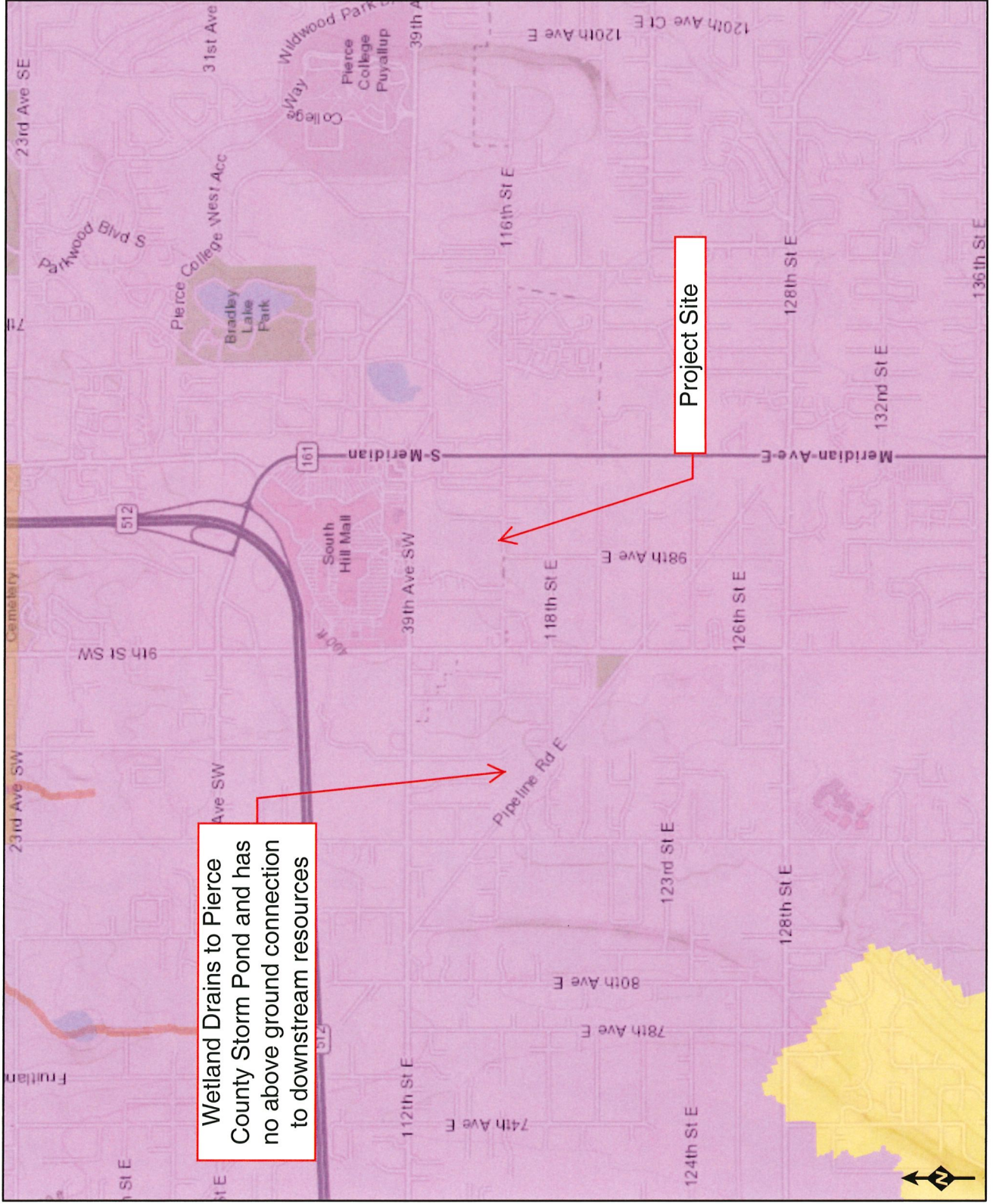




**Figure W5**



Figure W6



**Assessed Waters/Sediment**

- Water
  - Category 5 - 303d
  - Category 4C
  - Category 4B
  - Category 4A
  - Category 2
  - Category 1
- Sediment
  - Category 5 - 303d
  - Category 4C
  - Category 4B
  - Category 4A
  - Category 2
  - Category 1

**WQ Improvement Projects**

- Approved
- In Development

Miles 0 0.25 0.5 1

Sources: Esri, HERE, Garmin, Intermap, increment P Corp., GEBCO, USGS, FAO, NPS, NRCAN, Geobase, IGN, Kadaster NL, Ordnance Survey, Esri Japan, METI, Esri China (Hong Kong), (c) OpenStreetMap contributors, and

Wetland name or number A

## RATING SUMMARY – Western Washington

Name of wetland (or ID #): Wetland A Date of site visit: 27 APR 2015

Rated by Habitat Technologies Trained by Ecology?  Yes  No Date of training 2014

HGM Class used for rating Depressional Wetland has multiple HGM classes?  Y  N

**NOTE: Form is not complete without the figures requested (figures can be combined).**  
 Source of base aerial photo/map Pierce County GIS

**OVERALL WETLAND CATEGORY 3** (based on functions  or special characteristics )

### 1. Category of wetland based on FUNCTIONS

- Category I – Total score = 23 - 27
- Category II – Total score = 20 - 22
- Category III – Total score = 16 - 19
- Category IV – Total score = 9 - 15

FUNCTION	Improving Water Quality	Hydrologic	Habitat	
<i>Circle the appropriate ratings</i>				
Site Potential	H <input checked="" type="checkbox"/> M L	H <input checked="" type="checkbox"/> M L	H <input checked="" type="checkbox"/> M L	
Landscape Potential	<input checked="" type="checkbox"/> H M L	<input checked="" type="checkbox"/> H M L	H M <input checked="" type="checkbox"/> L	
Value	H M <input checked="" type="checkbox"/> L	H <input checked="" type="checkbox"/> M L	H <input checked="" type="checkbox"/> M L	<b>TOTAL</b>
<b>Score Based on Ratings</b>	6	7	5	18

**Score for each function based on three ratings (order of ratings is not important)**

- 9 = H,H,H
- 8 = H,H,M
- 7 = H,H,L
- 7 = H,M,M
- 6 = H,M,L
- 6 = M,M,M
- 5 = H,L,L
- 5 = M,M,L
- 4 = M,L,L
- 3 = L,L,L

### 2. Category based on SPECIAL CHARACTERISTICS of wetland

CHARACTERISTIC	CATEGORY
Estuarine	I    II
Wetland of High Conservation Value	I
Bog	I
Mature Forest	I
Old Growth Forest	I
Coastal Lagoon	I    II
Interdunal	I   II   III   IV
None of the above	<b>X</b>

Wetland name or number  A

## Maps and figures required to answer questions correctly for Western Washington

### Depressional Wetlands

Map of:	To answer questions:	Figure #
Cowardin plant classes	D 1.3, H 1.1, H 1.4	W1
Hydroperiods	D 1.4, H 1.2	W2
Location of outlet ( <i>can be added to map of hydroperiods</i> )	D 1.1, D 4.1	W2
Boundary of area within 150 ft of the wetland ( <i>can be added to another figure</i> )	D 2.2, D 5.2	W2
Map of the contributing basin	D 4.3, D 5.3	W3
1 km Polygon: Area that extends 1 km from entire wetland edge - including polygons for accessible habitat and undisturbed habitat	H 2.1, H 2.2, H 2.3	W4
Screen capture of map of 303(d) listed waters in basin (from Ecology website)	D 3.1, D 3.2	W5
Screen capture of list of TMDLs for WRIA in which unit is found (from web)	D 3.3	W6

### Riverine Wetlands

Map of:	To answer questions:	Figure #
Cowardin plant classes	H 1.1, H 1.4	↑
Hydroperiods	H 1.2	↑
Ponded depressions	R 1.1	↑
Boundary of area within 150 ft of the wetland ( <i>can be added to another figure</i> )	R 2.4	↑
Plant cover of trees, shrubs, and herbaceous plants	R 1.2, R 4.2	↑
Width of unit vs. width of stream ( <i>can be added to another figure</i> )	R 4.1	N/A
Map of the contributing basin	R 2.2, R 2.3, R 5.2	↑
1 km Polygon: Area that extends 1 km from entire wetland edge - including polygons for accessible habitat and undisturbed habitat	H 2.1, H 2.2, H 2.3	↑
Screen capture of map of 303(d) listed waters in basin (from Ecology website)	R 3.1	↓
Screen capture of list of TMDLs for WRIA in which unit is found (from web)	R 3.2, R 3.3	↓

### Lake Fringe Wetlands

Map of:	To answer questions:	Figure #
Cowardin plant classes	L 1.1, L 4.1, H 1.1, H 1.4	↑
Plant cover of trees, shrubs, and herbaceous plants	L 1.2	↑
Boundary of area within 150 ft of the wetland ( <i>can be added to another figure</i> )	L 2.2	↑
1 km Polygon: Area that extends 1 km from entire wetland edge - including polygons for accessible habitat and undisturbed habitat	H 2.1, H 2.2, H 2.3	N/A
Screen capture of map of 303(d) listed waters in basin (from Ecology website)	L 3.1, L 3.2	↓
Screen capture of list of TMDLs for WRIA in which unit is found (from web)	L 3.3	↓

### Slope Wetlands

Map of:	To answer questions:	Figure #
Cowardin plant classes	H 1.1, H 1.4	↑
Hydroperiods	H 1.2	↑
Plant cover of <b>dense</b> trees, shrubs, and herbaceous plants	S 1.3	↑
Plant cover of <b>dense, rigid</b> trees, shrubs, and herbaceous plants ( <i>can be added to figure above</i> )	S 4.1	N/A
Boundary of 150 ft buffer ( <i>can be added to another figure</i> )	S 2.1, S 5.1	↑
1 km Polygon: Area that extends 1 km from entire wetland edge - including polygons for accessible habitat and undisturbed habitat	H 2.1, H 2.2, H 2.3	↑
Screen capture of map of 303(d) listed waters in basin (from Ecology website)	S 3.1, S 3.2	↓
Screen capture of list of TMDLs for WRIA in which unit is found (from web)	S 3.3	↓



## HGM Classification of Wetlands in Western Washington

For questions 1-7, the criteria described must apply to the entire unit being rated.

If the hydrologic criteria listed in each question do not apply to the entire unit being rated, you probably have a unit with multiple HGM classes. In this case, identify which hydrologic criteria in questions 1-7 apply, and go to Question 8.

1. Are the water levels in the entire unit usually controlled by tides except during floods?

NO - go to 2

YES - the wetland class is **Tidal Fringe** - go to 1.1

- 1.1 Is the salinity of the water during periods of annual low flow below 0.5 ppt (parts per thousand)?

NO - **Saltwater Tidal Fringe (Estuarine)**

YES - **Freshwater Tidal Fringe**

*If your wetland can be classified as a Freshwater Tidal Fringe use the forms for **Riverine** wetlands. If it is Saltwater Tidal Fringe it is an **Estuarine** wetland and is not scored. This method **cannot** be used to score functions for estuarine wetlands.*

2. The entire wetland unit is flat and precipitation is the only source (>90%) of water to it. Groundwater and surface water runoff are NOT sources of water to the unit.

NO - go to 3

YES - The wetland class is **Flats**

*If your wetland can be classified as a Flats wetland, use the form for **Depressional** wetlands.*

3. Does the entire wetland unit **meet all** of the following criteria?

- The vegetated part of the wetland is on the shores of a body of permanent open water (without any plants on the surface at any time of the year) at least 20 ac (8 ha) in size;  
 At least 30% of the open water area is deeper than 6.6 ft (2 m).

NO - go to 4

YES - The wetland class is **Lake Fringe (Lacustrine Fringe)**

4. Does the entire wetland unit **meet all** of the following criteria?

- The wetland is on a slope (*slope can be very gradual*),  
 The water flows through the wetland in one direction (unidirectional) and usually comes from seeps. It may flow subsurface, as sheetflow, or in a swale without distinct banks,  
 The water leaves the wetland **without being impounded**.

NO - go to 5

YES - The wetland class is **Slope**

**NOTE:** Surface water does not pond in these type of wetlands except occasionally in very small and shallow depressions or behind hummocks (depressions are usually <3 ft diameter and less than 1 ft deep).

5. Does the entire wetland unit **meet all** of the following criteria?

- The unit is in a valley, or stream channel, where it gets inundated by overbank flooding from that stream or river,  
 The overbank flooding occurs at least once every 2 years.

Wetland name or number   A  

**NO – go to 6**

**YES – The wetland class is Riverine**

**NOTE:** The Riverine unit can contain depressions that are filled with water when the river is not flooding

6. Is the entire wetland unit in a topographic depression in which water ponds, or is saturated to the surface, at some time during the year? *This means that any outlet, if present, is higher than the interior of the wetland.*

NO – go to 7

**YES – The wetland class is Depressional**

7. Is the entire wetland unit located in a very flat area with no obvious depression and no overbank flooding? The unit does not pond surface water more than a few inches. The unit seems to be maintained by high groundwater in the area. The wetland may be ditched, but has no obvious natural outlet.

**NO – go to 8**

**YES – The wetland class is Depressional**

8. Your wetland unit seems to be difficult to classify and probably contains several different HGM classes. For example, seeps at the base of a slope may grade into a riverine floodplain, or a small stream within a Depressional wetland has a zone of flooding along its sides. **GO BACK AND IDENTIFY WHICH OF THE HYDROLOGIC REGIMES DESCRIBED IN QUESTIONS 1-7 APPLY TO DIFFERENT AREAS IN THE UNIT** (make a rough sketch to help you decide). Use the following table to identify the appropriate class to use for the rating system if you have several HGM classes present within the wetland unit being scored.

**NOTE:** Use this table only if the class that is recommended in the second column represents 10% or more of the total area of the wetland unit being rated. If the area of the HGM class listed in column 2 is less than 10% of the unit; classify the wetland using the class that represents more than 90% of the total area.

HGM classes within the wetland unit being rated	HGM class to use in rating
Slope + Riverine	Riverine
Slope + Depressional	Depressional
Slope + Lake Fringe	Lake Fringe
Depressional + Riverine along stream within boundary of depression	Depressional
Depressional + Lake Fringe	Depressional
Riverine + Lake Fringe	Riverine
Salt Water Tidal Fringe and any other class of freshwater wetland	Treat as ESTUARINE

*If you are still unable to determine which of the above criteria apply to your wetland, or if you have **more than 2 HGM classes** within a wetland boundary, classify the wetland as Depressional for the rating.*

Wetland name or number   A  

<b>DEPRESSIONAL AND FLATS WETLANDS</b>		
<b>Water Quality Functions - Indicators that the site functions to improve water quality</b>		
<b>D 1.0. Does the site have the potential to improve water quality?</b>		
D 1.1. <u>Characteristics of surface water outflows from the wetland:</u> Wetland is a depression or flat depression (QUESTION 7 on key) with no surface water leaving it (no outlet). Wetland has an intermittently flowing stream or ditch, OR highly constricted permanently flowing outlet. Wetland has an unconstricted, or slightly constricted, surface outlet that is permanently flowing Wetland is a flat depression (QUESTION 7 on key), whose outlet is a permanently flowing ditch.	points = 3 points = 2 points = 1 points = 1	<b>2</b>
D 1.2. <u>The soil 2 in below the surface (or duff layer) is true clay or true organic (use NRCS definitions).</u> Yes = 4 No = 0		<b>0</b>
D 1.3. <u>Characteristics and distribution of persistent plants (Emergent, Scrub-shrub, and/or Forested Cowardin classes):</u> Wetland has persistent, ungrazed, plants > 95% of area Wetland has persistent, ungrazed, plants > ½ of area Wetland has persistent, ungrazed plants > 1/10 of area Wetland has persistent, ungrazed plants < 1/10 of area	points = 5 points = 3 points = 1 points = 0	<b>3</b>
D 1.4. <u>Characteristics of seasonal ponding or inundation:</u> <i>This is the area that is ponded for at least 2 months. See description in manual.</i> Area seasonally ponded is > ½ total area of wetland Area seasonally ponded is > ¼ total area of wetland Area seasonally ponded is < ¼ total area of wetland	points = 4 points = 2 points = 0	<b>2</b>
<b>Total for D 1</b>	<b>Add the points in the boxes above</b>	<b>7</b>

**Rating of Site Potential** If score is:    12-16 = H   X   6-11 = M    0-5 = L *Record the rating on the first page*

<b>D 2.0. Does the landscape have the potential to support the water quality function of the site?</b>		
D 2.1. Does the wetland unit receive stormwater discharges?	Yes = 1 No = 0	<b>1</b>
D 2.2. Is > 10% of the area within 150 ft of the wetland in land uses that generate pollutants?	Yes = 1 No = 0	<b>1</b>
D 2.3. Are there septic systems within 250 ft of the wetland?	Yes = 1 No = 0	<b>1</b>
D 2.4. Are there other sources of pollutants coming into the wetland that are not listed in questions D 2.1-D 2.3? Source _____	Yes = 1 No = 0	<b>0</b>
<b>Total for D 2</b>	<b>Add the points in the boxes above</b>	<b>3</b>

**Rating of Landscape Potential** If score is:   X   3 or 4 = H    1 or 2 = M    0 = L *Record the rating on the first page*

<b>D 3.0. Is the water quality improvement provided by the site valuable to society?</b>		
D 3.1. Does the wetland discharge directly (i.e., within 1 mi) to a stream, river, lake, or marine water that is on the 303(d) list?	Yes = 1 No = 0	<b>0</b>
D 3.2. Is the wetland in a basin or sub-basin where an aquatic resource is on the 303(d) list?	Yes = 1 No = 0	<b>0</b>
D 3.3. Has the site been identified in a watershed or local plan as important for maintaining water quality (answer YES if there is a TMDL for the basin in which the unit is found)?	Yes = 2 No = 0	<b>0</b>
<b>Total for D 3</b>	<b>Add the points in the boxes above</b>	<b>0</b>

**Rating of Value** If score is:    2-4 = H    1 = M   X   0 = L *Record the rating on the first page*



Wetland name or number   A  

**DEPRESSIONAL AND FLATS WETLANDS**

**Hydrologic Functions - Indicators that the site functions to reduce flooding and stream degradation**

<b>D 4.0. Does the site have the potential to reduce flooding and erosion?</b>		
<b>D 4.1. Characteristics of surface water outflows from the wetland:</b>		
Wetland is a depression or flat depression with no surface water leaving it (no outlet)	points = 4	<b>2</b>
Wetland has an intermittently flowing stream or ditch, OR highly constricted permanently flowing outlet	points = 2	
Wetland is a flat depression (QUESTION 7 on key), whose outlet is a permanently flowing ditch	points = 1	
Wetland has an unconstricted, or slightly constricted, surface outlet that is permanently flowing	points = 0	
<b>D 4.2. Depth of storage during wet periods: Estimate the height of ponding above the bottom of the outlet. For wetlands with no outlet, measure from the surface of permanent water or if dry, the deepest part.</b>		
Marks of ponding are 3 ft or more above the surface or bottom of outlet	points = 7	<b>3</b>
Marks of ponding between 2 ft to < 3 ft from surface or bottom of outlet	points = 5	
Marks are at least 0.5 ft to < 2 ft from surface or bottom of outlet	points = 3	
The wetland is a "headwater" wetland	points = 3	
Wetland is flat but has small depressions on the surface that trap water	points = 1	
Marks of ponding less than 0.5 ft (6 in)	points = 0	
<b>D 4.3. Contribution of the wetland to storage in the watershed: Estimate the ratio of the area of upstream basin contributing surface water to the wetland to the area of the wetland unit itself.</b>		
The area of the basin is less than 10 times the area of the unit	points = 5	<b>5</b>
The area of the basin is 10 to 100 times the area of the unit	points = 3	
The area of the basin is more than 100 times the area of the unit	points = 0	
Entire wetland is in the Flats class	points = 5	
<b>Total for D 4</b>	<b>Add the points in the boxes above</b>	<b>10</b>

**Rating of Site Potential** If score is:    12-16 = H   X   6-11 = M    0-5 = L *Record the rating on the first page*

<b>D 5.0. Does the landscape have the potential to support hydrologic functions of the site?</b>		
<b>D 5.1. Does the wetland receive stormwater discharges?</b>	Yes = 1 No = 0	<b>1</b>
<b>D 5.2. Is &gt;10% of the area within 150 ft of the wetland in land uses that generate excess runoff?</b>	Yes = 1 No = 0	<b>1</b>
<b>D 5.3. Is more than 25% of the contributing basin of the wetland covered with intensive human land uses (residential at &gt;1 residence/ac, urban, commercial, agriculture, etc.)?</b>	Yes = 1 No = 0	<b>1</b>
<b>Total for D 5</b>	<b>Add the points in the boxes above</b>	<b>3</b>

**Rating of Landscape Potential** If score is:   X   3 = H    1 or 2 = M    0 = L *Record the rating on the first page*

<b>D 6.0. Are the hydrologic functions provided by the site valuable to society?</b>		
<b>D 6.1. The unit is in a landscape that has flooding problems. Choose the description that best matches conditions around the wetland unit being rated. Do not add points. Choose the highest score if more than one condition is met.</b>		
The wetland captures surface water that would otherwise flow down-gradient into areas where flooding has damaged human or natural resources (e.g., houses or salmon redds):		<b>1</b>
• Flooding occurs in a sub-basin that is immediately down-gradient of unit.	points = 2	
• Surface flooding problems are in a sub-basin farther down-gradient.	points = 1	
Flooding from groundwater is an issue in the sub-basin.	points = 1	
The existing or potential outflow from the wetland is so constrained by human or natural conditions that the water stored by the wetland cannot reach areas that flood. Explain why _____	points = 0	
There are no problems with flooding downstream of the wetland.	points = 0	
<b>D 6.2. Has the site been identified as important for flood storage or flood conveyance in a regional flood control plan?</b>	Yes = 2 No = 0	<b>0</b>
<b>Total for D 6</b>	<b>Add the points in the boxes above</b>	<b>1</b>

**Rating of Value** If score is:    2-4 = H   X   1 = M    0 = L *Record the rating on the first page*



Wetland name or number A

**These questions apply to wetlands of all HGM classes.**

**HABITAT FUNCTIONS** - Indicators that site functions to provide important habitat

H 1.0. Does the site have the potential to provide habitat?

H 1.1. Structure of plant community: *Indicators are Cowardin classes and strata within the Forested class. Check the Cowardin plant classes in the wetland. Up to 10 patches may be combined for each class to meet the threshold of ¼ ac or more than 10% of the unit if it is smaller than 2.5 ac. Add the number of structures checked.*

- |   |                                  |
|---|----------------------------------|
| <input type="checkbox"/> Aquatic bed  | 4 structures or more: points = 4 |
| <input checked="" type="checkbox"/> Emergent                                      | 3 structures: points = 2         |
| <input type="checkbox"/> Scrub-shrub (areas where shrubs have > 30% cover)        | 2 structures: points = 1         |
| <input checked="" type="checkbox"/> Forested (areas where trees have > 30% cover) | 1 structure: points = 0          |
- If the unit has a Forested class, check if:*
- The Forested class has 3 out of 5 strata (canopy, sub-canopy, shrubs, herbaceous, moss/ground-cover) that each cover 20% within the Forested polygon

2

H 1.2. Hydroperiods

Check the types of water regimes (hydroperiods) present within the wetland. The water regime has to cover more than 10% of the wetland or ¼ ac to count (*see text for descriptions of hydroperiods*).

- |  |                                     |
|--|-------------------------------------|
| <input checked="" type="checkbox"/> Permanently flooded or inundated | 4 or more types present: points = 3 |
| <input checked="" type="checkbox"/> Seasonally flooded or inundated  | 3 types present: points = 2         |
| <input type="checkbox"/> Occasionally flooded or inundated           | 2 types present: points = 1         |
| <input checked="" type="checkbox"/> Saturated only                   | 1 type present: points = 0          |
- Permanently flowing stream or river in, or adjacent to, the wetland
- Seasonally flowing stream in, or adjacent to, the wetland
- Lake Fringe wetland** **2 points**
- Freshwater tidal wetland** **2 points**

3

H 1.3. Richness of plant species

Count the number of plant species in the wetland that cover at least 10 ft<sup>2</sup>.

*Different patches of the same species can be combined to meet the size threshold and you do not have to name the species. Do not include Eurasian milfoil, reed canarygrass, purple loosestrife, Canadian thistle*

- |                              |            |
|------------------------------|------------|
| If you counted: > 19 species | points = 2 |
| 5 - 19 species               | points = 1 |
| < 5 species                  | points = 0 |

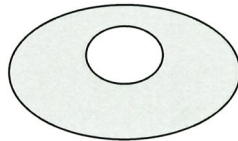
2

H 1.4. Interspersion of habitats

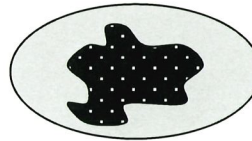
Decide from the diagrams below whether interspersion among Cowardin plants classes (described in H 1.1), or the classes and unvegetated areas (can include open water or mudflats) is high, moderate, low, or none. *If you have four or more plant classes or three classes and open water, the rating is always high.*



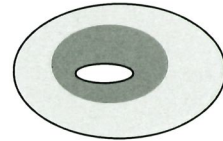
None = 0 points



Low = 1 point

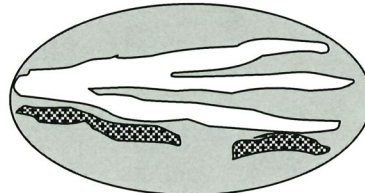
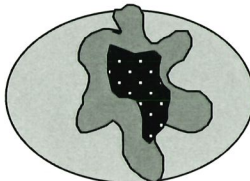
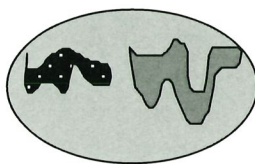


Moderate = 2 points



1

All three diagrams in this row are **HIGH** = 3points



Wetland name or number A

<p>H 1.5. Special habitat features:            Check the habitat features that are present in the wetland. <i>The number of checks is the number of points.</i>  <input checked="" type="checkbox"/> Large, downed, woody debris within the wetland (&gt; 4 in diameter and 6 ft long).  <input checked="" type="checkbox"/> Standing snags (dbh &gt; 4 in) within the wetland  <input type="checkbox"/> Undercut banks are present for at least 6.6 ft (2 m) <b>and/or</b> overhanging plants extends at least 3.3 ft (1 m) over a stream (or ditch) in, or contiguous with the wetland, for at least 33 ft (10 m)  <input type="checkbox"/> Stable steep banks of fine material that might be used by beaver or muskrat for denning (&gt; 30 degree slope) OR signs of recent beaver activity are present (<i>cut shrubs or trees that have not yet weathered where wood is exposed</i>)  <input checked="" type="checkbox"/> At least ¼ ac of thin-stemmed persistent plants or woody branches are present in areas that are permanently or seasonally inundated (<i>structures for egg-laying by amphibians</i>)  <input type="checkbox"/> Invasive plants cover less than 25% of the wetland area in every stratum of plants (<i>see H 1.1 for list of strata</i>)</p>	3	
Total for H 1	Add the points in the boxes above	11

**Rating of Site Potential** If score is: 15-18 = H  7-14 = M  0-6 = L *Record the rating on the first page*

<p>H 2.0. Does the landscape have the potential to support the habitat functions of the site?</p>		
<p>H 2.1. Accessible habitat (include <i>only habitat that directly abuts wetland unit</i>).  <i>Calculate:</i> % undisturbed habitat <u>0</u> + [(% moderate and low intensity land uses)/2] <u>2</u> = <u>2</u> %            If total accessible habitat is:            &gt; 1/3 (33.3%) of 1 km Polygon points = 3            20-33% of 1 km Polygon points = 2            10-19% of 1 km Polygon points = 1            &lt; 10% of 1 km Polygon points = 0</p>	0	
<p>H 2.2. Undisturbed habitat in 1 km Polygon around the wetland.  <i>Calculate:</i> % undisturbed habitat <u>0</u> + [(% moderate and low intensity land uses)/2] <u>10</u> = <u>10</u> %            Undisturbed habitat &gt; 50% of Polygon points = 3            Undisturbed habitat 10-50% and in 1-3 patches points = 2            Undisturbed habitat 10-50% and &gt; 3 patches points = 1            Undisturbed habitat &lt; 10% of 1 km Polygon points = 0</p>	0	
<p>H 2.3. Land use intensity in 1 km Polygon: If            &gt; 50% of 1 km Polygon is high intensity land use points = (- 2)            ≤ 50% of 1 km Polygon is high intensity points = 0</p>	(-2)	
Total for H 2	Add the points in the boxes above	(-2)

**Rating of Landscape Potential** If score is: 4-6 = H  1-3 = M  < 1 = L *Record the rating on the first page*

<p>H 3.0. Is the habitat provided by the site valuable to society?</p>		
<p>H 3.1. Does the site provide habitat for species valued in laws, regulations, or policies? <i>Choose only the highest score that applies to the wetland being rated.</i>            Site meets ANY of the following criteria: points = 2            — It has 3 or more priority habitats within 100 m (see next page)            — It provides habitat for Threatened or Endangered species (any plant or animal on the state or federal lists)            — It is mapped as a location for an individual WDFW priority species            — It is a Wetland of High Conservation Value as determined by the Department of Natural Resources            — It has been categorized as an important habitat site in a local or regional comprehensive plan, in a Shoreline Master Plan, or in a watershed plan            Site has 1 or 2 priority habitats (listed on next page) within 100 m points = 1            Site does not meet any of the criteria above points = 0</p>	1	

**Rating of Value** If score is: 2 = H  1 = M  0 = L *Record the rating on the first page*

# APPENDIX E

## Geotechnical Reports

Innovative GEO-Services, LLC - Artz Site and Soil Evaluation	E-1
Earth Solutions NW - Infiltration Eval. and Seasonal Groundwater Monitoring	E-8

January 29, 2020

DAVID ARTZ  
4807 51<sup>ST</sup> STCT E  
TACOMA, WA 98443  
253 307-1002

Artz Site and Soil Evaluation

Parcel No. 0419095003, 5004 & 5022  
Site Address 409, 427 and 433 43<sup>rd</sup> AV SW  
Site Observations January 20, 2020

Introduction

It is the intent of this letter to present site and soil characteristics with regard to potential critical areas which may exist on the above-mentioned property. Site conditions and evaluation are required to support on-site septic designs prepared for two of the three parcels. Site observations, subsurface soil observations and research conducted for the three lots and specifically the two southern parcels found no critical areas as defined by the City of Puyallup ordinance. The soil and site conditions are considered consistent with the development proposed.

Project Description

A landslide hazard report is necessary to satisfy the City of Puyallup's Municipal Code requirements relating to building activities in the area of qualifying slopes. Specifically, the applicant intends to complete a remodel and deck addition on an existing single-family home which is located near slopes meeting the criteria for report submission. We understand that these improvements are planned on the nearly level portion of the site, although all slopes will be evaluated relative to the City's ordinance.

Per Puyallup Municipal Code 21.06.1210(3)(ii); a geotechnical report is required if all three of the following characteristics are met:

- A. Slopes steeper than 15%
- B. Hillsides intersecting geologic contacts with a relatively permeable sediment overlying a relatively impermeable sediment or bedrock; and
- C. Springs or groundwater seepage

As part of this assessment we made observations of adjacent slopes for the presence of landslide hazard indicators. We also reviewed available published soil and geological records, aerial photography, topographical maps, and LiDAR terrain maps to help gain an understanding of the area morphology and establish an opinion on slope morphology and stability.

Information Sources

The regulatory standard for this assessment is outlined in the City of Puyallup Municipal Code, Chapter 21.06.1210-70. Soil identification and mapping for this assessment is supported by information from the Natural Resource Conservation Service (the Survey), and on-site soil evaluation performed during the wastewater system design phase as documented in the Tacoma-Pierce County Health Department records. Geologic information for this assessment is supported by information from the United States Geological Survey (USGS) *Draft* Geologic Map Geologic Map of the Puyallup 7.5 Minute Quadrangle. Our understanding of slope morphology is supported by the review of published topographic and relief map layers from the Pierce County Geographical Information System (GIS). Our slope stability opinions



are based on our interpretation of the cumulative information and the contemporary conditions of the geologic setting.

### **Published Information Accuracy**

It should be noted that the Survey, the USGS and/or DNR geologic maps, and the Pierce County GIS define general areas of soil deposits, geology, and landforms. Given the large areas to identify and limited sample points, the authors of the above sources had to infer boundaries, contacts, and other representations in some areas. Only through on site reconnaissance can we further detail and adjust information from the maps as they relate to each site. They are not (from our experience) accurate on a lot by lot basis in all cases. In this case, the Survey, the DNR unit identification, and the published soil logs are generally in concurrence.

### **Site Description**

#### **General**

The project involves of three parcels located north of 43<sup>rd</sup> AV SW (116<sup>th</sup> ST E) between 4<sup>th</sup> ST PL SW and 98<sup>th</sup> AV E on South Hill, Puyallup. The two southern lots are currently being developed; the northern lot will not be developed at this time. The two southern parcels are 54,450 sf each (1.25 ac.) and the



northern parcel is 109,336 sf (2.51 ac). The vacant land is covered with berry vines and a few hardwood and conifer trees. Topographically the surface of the three lots is best described as nearly level with a rolling surface descending gently to the northeast and northwest. There are isolated areas with short moderate slopes with grades measured in the field of less than 5%.

Development plans involve the southern portion of the two southern lots for residential housing. The development will be supported by on-site septic systems designed for the type of structure and soil textures, municipal water and on-site storm water control.

#### **Soil**

As discussed in the 'Published Information Accuracy' section above, on-site reconnaissance is necessary to verify soil conditions on specific properties. The NRCS identifies the soil on the two southern lots as Everett gravelly sandy loam (13B) In this case; test pits excavated north and east of the proposed structure as a

portion of the wastewater permitting phase confirmed soil typical of Everett gravelly sandy loamy.

**Everett 13B – Everett gravelly sandy loam, 0 – 6 percent slopes**

This rolling soil is somewhat excessively drained. It formed in gravelly glacial outwash under conifers. The typical elevation range for this soil is from 200 to 700 feet. Included with this soil in mapping are about eight percent Alderwood soils. Also included are some areas that are as much as five percent sandy Indianola soils and ten percent gravelly Neilton soils and less sloping Everett soils. In a typical profile the surface layer is very dark brown gravelly sandy loam about two inches thick. The subsoil, between depths of two and 19 inches, is dark yellowish brown gravelly sandy loam and dark brown very gravelly coarse sandy loam. The substratum, between depths of 19 and more than 60 inches, is clean, loose very gravelly sand.

Permeability is rapid. The available water capacity is low. Surface runoff is slow, and the erosion hazard is low. The effective rooting depth is more than four feet.

This nearly level to undulating soil is somewhat excessively drained. It formed in gravelly glacial outwash under conifers. Elevation ranges from 200 to 700 feet. The annual precipitation is 35 to 45 inches, and the mean annual air temperature is about 50 degrees F. The frost-free season is about 180 days. Most areas of this soil are gently sloping, but some places are broken by steep slopes 15 to 70 feet long.

Included with this soil in mapping are ten percent Neilton gravelly loamy sand and less than 10 percent Alderwood and sandy Indianola soils.

In a typical profile the surface layer is very dark brown gravelly sandy loam about two inches thick. The subsoil, between depths of two and 19 inches, is dark yellowish brown gravelly sandy loam and dark brown very gravelly coarse sandy loam. The substratum, between depths of 10 and more than 60 inches, is clean loose very gravelly sand. Reaction is medium acid.

Permeability is rapid. The available water capacity is low. Surface runoff is slow, and there is little or no erosion hazard. The effective rooting depth is more than four feet.

Large areas of this soil are under native vegetation, but they are being rapidly urbanized. This soil is among the least desirable in the area for farming, but it is one of the most desirable for and home sites and as a source of gravel for construction purposes. There are no limitations for urban development. However, septic waste from drain fields endanger ground water supplies because the soil is rapidly permeable.

NRCS Soil Map

**Map Unit Legend**

Map Unit Symbol	Map Unit Name	Acres in AOI	Percent of AOI
13B	Everett very gravelly sandy loam, 0 to 6 percent slopes	49.2	67.6%
13C	Everett very gravelly sandy loam, 8 to 15 percent slopes	16.3	22.3%
28A	Norma fine sandy loam	6.7	9.1%
W	Water	0.8	0.9%
Totals for Area of Interest		72.9	100.0%





## Geology

According to the USGS *Draft Geologic Map of the Puyallup 7.5 Minute Quadrangle* in Figure 2 below: this plateau region was formed by the gradual emplacement glacial drift stratigraphy; followed by the erosion of the previously emplaced glacial drift deposits by channelized glacial meltwater incision along the west side, and by ice lobe truncation within the Puyallup valley. The map shows that the slope section dipping to the northeast provides a depositional record of the pre-vashon mixed fine and coarse deposits, overlain by the Vashon advance outwash, overlain by the Vashon till, and finally overlain by the Vashon recessional outwash. The slope face represents the location where the much larger glacier within the valley truncated the slope face thus exposing a stratigraphic record of deposits. Figure 2 illustrates the site's position relative to the geology.

## Hydrology

The NRCS along with soil logs prepared from the Tacoma-Pierce County Health Department (TPCHD) on-site septic system design documented the soil profiles as medium sand with gravel (ie: Everett 13B). These well drained soils existing on a rolling plain would suggest any precipitation entering the area can readily evacuate given the slope and high soil permeability. Isolated areas of surface perched water were observed across the northwest corner of the western lot. We do not see the conditions existing where large scale ground water buildup (and thus de-stabilizing pore pressure) can occur.

**USGS Geologic Map of the Puyallup 7.5 Minute Quadrangle (Excerpt)**



**Troost, K.G. (In Review)**

Qvs	Steilacoom Gravel of Walters and Kimmel (1968)—Sandy gravel and cobbles; clean to silty; poorly to well sorted; horizontally to cross bedded; loose to dense. Deposits vary from veneer of 1 to 15 m (3 to ~ 50 ft) thick. Deposited by multiple outburst floods from subsequently lower elevations of Glacial Lake Puyallup. Locally subdivided first by channel affiliation (Clover Creek or Bradley) and secondarily by relative age in descending series of deposits; higher number denotes younger (lower) deposit. Clover Creek channel (Bretz, 1913) begins in section 8, T19N, R4E. Bradley channel; herein named for Lake Bradley in section 3, T19N, R4E; begins in section 2, T19N, R4E. Numbering system contiguous w/adjacent Tacoma South quadrangle where multiple Clover Creek deposits are mapped (Troost, 2006). Mapable deposits consist of:
Qvs 221	Clover Creek deposit at elevation ~380 ft
Qvs 24	Bradley deposit at elevation ~400 ft
Qvs 42	Bradley deposit at elevation 420 – 440 ft
Qvs 42	Bradley deposit at elevation 440 – 460 ft
Qvs 51	Bradley deposit at elevation 460 – 480 ft

**Critical Area Review**

On January 24<sup>th</sup>, 2020, site observations were made for the presence of indicators associated with landforms susceptible or undergoing mass movement due to a combination of geologic, seismic, topographic, hydrologic, or man-made factors. Per the **City of Puyallup Chapter 21.06 – “Critical Areas” (and specifically Section 21.06.1210)**;

*Geologically hazardous areas shall be classified as follows:*

- (a) Landslide and erosion hazard areas are areas of potential slope instability. Erosion hazard areas include those identified by the U.S. Department of Agriculture Natural Resources Conservation Service as having a moderate to severe, severe, or very severe erosion hazard because of natural characteristics, including vegetative cover, soil texture, slope, gradient, and*



*rainfall patterns, or human-induced changes to natural characteristics. Landslide and erosion hazard areas include areas with the following characteristics:*

- (i) Areas that have shown mass movement during the Holocene epoch (from 10,000 years ago to the present) or that are underlain or covered by mass wastage debris of that epoch;*
- (ii) Slopes that are parallel or subparallel to planes of weakness (such as bedding planes, joint systems, and fault planes) in subsurface materials;*
- (iii) Slopes having gradients steeper than 80 percent subject to rock fall during seismic shaking;*
- (iv) Areas potentially unstable because of stream incision or stream bank erosion;*
- (v) Areas located in a canyon, ravine, or on an active alluvial fan, presently or potentially subject to inundation by debris flows or flooding;*
- (vi) Any area with a slope of 40 percent or steeper and a vertical relief of 10 or more feet, except areas composed of consolidated rock and properly engineered manmade slopes/retained fill. A slope is delineated by establishing its toe and top and measured by averaging the inclination over at least 10 feet of vertical relief;*
- (vii) Areas with a severe limitation for building development because of slope conditions, according to the Natural Resource Conservations Service; and*
- (viii) Areas meeting all three of the following criteria: (A) slopes steeper than 15 percent, except that slopes of less than 15 percent may be considered erosion hazard areas if they have certain unstable soil and drainage characteristics; (B) hillsides intersecting geologic contacts with a relatively permeable sediment overlying a relatively impermeable sediment or bedrock; and (C) wet season springs or ground water seepage.*

### **Findings and Conclusions**

In addition to the list of indicators above (i through viii), we reviewed published geologic maps, topographic maps, shaded relief maps, and aerial photography to form an opinion on slope morphology. We did not observe any of the potential landslide hazard indicators from the list above, nor does the landform show the classic, morphologic signatures associated with mass movement. This would be expected given that the angle of repose (the maximum angle at which a material is stable) has not been exceeded per our measurements.

Based on our observations and review of the published geology, soils, and topography, it is our opinion areas proposed for application of the on-site septic systems are stable landforms resulting from the depositional mechanisms contemporary with glacial meltwater. In our opinion, the slopes appear to be globally stable and not at risk for mass movement. The application of the on-site waste water will be

designed in accordance with state and local design criteria based on the soil textures and application rate for the soil characteristics. The proposed drainfield areas are consistent with the design criteria and will not create an unstable condition.

**Closure**

The conclusions and recommendations presented in this letter are based, in part, on our interpretations and assumptions regarding subsurface conditions; therefore, if variations in the site conditions are observed at a later time, we may need to modify this letter to reflect those changes. We appreciate the opportunity to be of service on this project. If you have any questions regarding this letter or any aspects of the project, please feel free to contact our office.

Respectfully submitted,

*Innovative GEO-Services, LLC*



1/30/2020

**REX B. HUMPHREY**

Rex Humphrey, L.E.G.  
Engineering Geologist



March 30, 2023  
ES-8303

Earth Solutions NW LLC

Geotechnical Engineering, Construction  
Observation/Testing and Environmental Services

HC Homes, Inc.  
P.O. Box 7707  
Bonney Lake, Washington 98391

Attention: Mr. Roger Hebert

**Subject: Infiltration Evaluation and Seasonal Groundwater Monitoring  
Proposed Duplexes  
433 and 409 – 43<sup>rd</sup> Avenue Southwest  
Puyallup, Washington**

Reference: CES NW, Inc.  
Site Plan, dated January 20, 2022

J.E. Schuster et al.  
Geologic Map of the Tacoma 1:100,000-scale Quadrangle, Washington, 2015

United States Department of Agriculture (USDA)  
Natural Resources Conservation Service (NRCS)  
Online Web Soil Survey (WSS) resource

Puyallup Municipal Code (PMC) Chapter 21.06 – Critical Areas

Liquefaction Susceptibility Map of Pierce County, dated September 2004

Washington State Department of Ecology  
2014 Stormwater Management Manual for Western Washington (2014 SWMMWW)

Dear Mr. Hebert:

As requested, Earth Solutions NW, LLC (ESNW) has prepared this letter for the proposed project. The letter was prepared in general accordance with the scope of services outlined in our proposal dated November 15, 2021, which was authorized by you on November 19, 2021. A summary of the subsurface explorations on site and geotechnical recommendations to aid with site design are provided in this letter.

## **Project Description**

According to the referenced site plan, the currently unimproved site will be developed with two duplex structures, proposed within roughly the southern quarter of the site, along with associated improvements. Each duplex will be two stories. Four dispersion trenches (with 50-foot flowpaths toward the wetland) and an infiltration gallery are proposed. It is noted that, per discussion with the civil engineer, certain elements of design and/or the site layout (as shown on the referenced site plan) had not been finalized as of the date of this letter, including the driveway layout and the locations of the dispersion trenches and infiltration gallery. A 60-foot wetland buffer has been incorporated into the site plan.

## **Surface Conditions**

The subject site is located on the north side of 43<sup>rd</sup> Avenue Southwest, between 98<sup>th</sup> Avenue East and 99<sup>th</sup> Avenue Court East, in Puyallup, Washington. The approximate location of the property is illustrated on Plate 1 (Vicinity Map). The site consists of two adjacent tax parcels (Pierce County Parcel No. 041909-5003 and -5022), totaling roughly 2.5 acres. The existing topography descends generally from south to north, with an estimated 10 to 15 feet of elevation change across the parcels. A wetland and associated buffer encompass most of the site, with only the southern site area and eastern site margin located outside of the wetland and buffer. The site is moderately to heavily vegetated and undeveloped.

## **Subsurface Conditions**

An ESNW representative observed, logged, and sampled five test pits on December 8, 2021. Four additional test pits, three of which had standpipe piezometers installed for seasonal groundwater monitoring purposes, were excavated on January 13, 2022. The test pits were excavated within accessible site areas, using a mini trackhoe and operator retained by ESNW. The test pits were completed to evaluate and classify site soils, characterize groundwater conditions within accessible site areas, and perform in-situ infiltration testing.

The approximate locations of the test pits are depicted on Plate 2 (Test Pit Location Plan). Please refer to the attached test pit logs for a more detailed description of subsurface conditions. Representative soil samples collected at the test pit locations were analyzed in general accordance with both Unified Soil Classification System (USCS) and USDA methods and procedures.

## **Topsoil and Fill**

Where encountered at surface grades, the topsoil was about six to eight inches thick. The topsoil was characterized by the observed dark brown hue, the presence of fine organics, and small root intrusions.

Fill was encountered at test pit locations TP-2, TP-3, TP-4, TP-5, TP-8, and TP-9 to depths of about six to nine-and-one-half feet below the existing ground surface (bgs). The fill was characterized as silty sand with and without gravel, primarily in a loose to medium dense and damp to moist condition. Small pieces of asphalt, wood, and plastic were observed in the fill.



## **Native Soil**

Underlying the topsoil and fill, native soil consisted primarily of silty sands with gravel (USCS: SM), with well-graded gravels with sand (USCS: GW) present along the western end of the site. The in-situ density of the native soil was characterized primarily as medium dense to dense, and the in-situ moisture content was observed to be damp to wet at the time of exploration. The maximum exploration depth was approximately 11 feet bgs.

## **Geologic Setting**

The referenced geologic map resource identifies recessional outwash (Qgo) as the primary native soil unit underlying the subject site and proximate areas. As reported on the geologic map resource, recessional outwash is typically composed of silts, sands, and gravels deposited by glacial meltwater. The referenced WSS resource identifies Everett very gravelly sandy loam as the primary soil unit underlying the subject development area. The Everett series was formed in glacial drift plains. Based on our field observations, the on-site native soil is consistent with the local geologic mapping of recessional outwash.

## **Groundwater**

The groundwater table was encountered at test pits TP-1, TP-2, TP-4, and TP-7 during the December 2021 and January 2022 explorations. At the time of the explorations, the groundwater table was observed at depths of about 8 to 11 feet bgs. Shallow groundwater seepage was observed at TP-6 at a depth of roughly seven feet bgs during the January 2022 exploration.

To supplement the field observations, ESNW was contracted to complete a groundwater monitoring program through most of the 2021–2022 wet season. The program consisted of installing three standpipe piezometers (at TP-6, TP-8, and TP-9) for groundwater monitoring purposes. The piezometers were arranged in a triangular array across the proposed development area.

After the installation of the groundwater wells on January 13, 2022, ESNW personnel visited the site periodically (about twice per month), through the end of the wet season, to collect data and perform manual measurements at each monitoring location using a depth-to-water meter. Upon review of the data collected at the piezometers using dataloggers, it was determined the data was corrupt and unreliable, e.g., the dataloggers were indicating groundwater levels far shallower than those measured manually. As such, the manual measurements were relied upon for purposes of evaluating the seasonal high groundwater table. The tables below summarize the groundwater data collected during the monitoring program.

Test Pit	Depth of Test Pit (ft)	Ground Elevation* (ft)	Peak GWT Depth (ft bgs)	Peak GWT Elevation* (ft)	Peak Date
TP-6	8.0	434	6.75	427.25	03/17/2022
TP-8	7.5	435	N/A	N/A	N/A
TP-9	9.0	435	N/A	N/A	N/A

\* Ground elevations are approximate and based on readily available topographic survey data. The test pit locations were not surveyed.

Date of Manual Measurement	TP-6 GWT (ft bgs)	TP-8 GWT (ft bgs)	TP-9 GWT (ft bgs)
01/13/2022	(Dry)	(Dry)	(Dry)
02/04/2022	7.1	(Dry)	(Dry)
02/24/2022	7.0	(Dry)	(Dry)
03/17/2022	6.7	(Dry)	(Dry)
04/07/2022	6.9	(Dry)	(Dry)

Based on our field observations and monitoring, the following recommendations are offered:

- Groundwater was not observed within the monitored depths of the standpipe piezometers at TP-8 and TP-9. Therefore, it is our opinion the seasonal high groundwater table elevation occurs at a depth of not higher than 7.5 feet bgs in the south-central and southeast areas of the site.
- The recommended seasonal high groundwater table elevation within the southwest site area (near TP-6) is 6.7 feet bgs.

**Geologically Hazardous Areas**

ESNW reviewed the referenced Puyallup Municipal Code (PMC) chapter and the City of Puyallup interactive GIS resource to evaluate the presence of geologically hazardous areas on site. PMC 21.06.1210 recognizes erosion, landslide, seismic, and volcanic hazard areas as geologically hazardous. Based on our review, a small area of moderate (shallow) landslide hazard is mapped on site. The location of the mapped hazard area appears to coincide with the location of the wetland. No other geologically hazardous areas are recognized or mapped on site.

Landslide hazard areas are defined in PMC 21.06.1210(3)(b) as areas subject to landslides based on a combination of geologic, topographic, and hydrologic factors. The most relevant hazard criteria to the subject site include PMC 21.06.1210(3)(b)(ii) and 21.06.1210(3)(b)(ix), which characterize landslide hazard (in part) by slope gradient. Based on review of the referenced site plan, the site does not contain slopes steeper than 15 percent over a vertical relief of 10 feet. As such, it is our opinion the site does not meet the PMC definition of a landslide hazard area.

According to PMC 21.06.1210(3)(c), seismic hazard areas are defined as “areas subject to severe risk of damage as a result of earthquake-induced ground shaking, slope failure, settlement or subsidence, soil liquefaction, or tsunamis.” The referenced liquefaction susceptibility map indicates the site and surrounding areas possess very low liquefaction susceptibility. Based on our field observations, it is our opinion that the site is correctly mapped as not located within a seismic hazard area.

### **Geotechnical Recommendations**

Based on our investigation, the proposed residential development is feasible from a geotechnical standpoint. The primary geotechnical considerations for the proposal are associated with structural fill placement and compaction, earthwork and grading activities, foundation support, stormwater management, and drainage. Based on our field observations and understanding of the proposed development, pertinent geotechnical recommendations and design parameters are presented in the following sections.

#### **In-situ and Imported Soil**

From a geotechnical standpoint, in general, our field observations indicate on-site soils likely to be encountered during construction will not be suitable for use as structural fill unless the in-situ soil moisture content is at (or slightly above) the optimum level at the time of placement and compaction. Successful use of on-site soils as structural fill will largely be dictated by the moisture content at the time of placement and compaction. It should be noted that most of the on-site soil is moisture sensitive (silty sand). However, areas of well-drained gravels, where encountered, are not considered moisture sensitive.

As discussed in the *Topsoil and Fill* section above, artificial fill soils were encountered at several test locations. Various amounts of debris, including asphalt, wood, and plastic were observed in the fill. To be suitable for reuse as structural fill, the existing fill must be primarily free of debris (both organic and inorganic) and deleterious material; as such, efforts to screen and remove the observed debris should be incorporated into construction activities if the existing fill will be considered for reuse as structural fill. ESNW should be retained to observe earthwork, grading, and/or screening activities pertaining to the existing fill during construction, as necessary.

Performing grading activities during summer months of relatively low rainfall activity is recommended to minimize site degradation. In our opinion, a contingency should be provided in the project budget for the export of soil that cannot be successfully compacted as structural fill, particularly if grading activities take place during periods of extended rainfall activity. In general, soil with an appreciable fines content (greater than 5 percent) typically degrades rapidly when exposed to periods of rainfall.





Provided foundations will be supported as prescribed, the following parameters may be used for design:

- Allowable soil bearing capacity 2,500 psf
- Passive earth pressure 300 pcf (equivalent fluid)
- Coefficient of friction 0.40

A one-third increase in the allowable soil bearing capacity may be assumed for short-term wind and seismic loading conditions. The above passive pressure and friction values include a factor-of-safety of 1.5. With structural loading as expected, about one inch of total static settlement and about one-half inch of differential static settlement is anticipated. Most of the anticipated settlement should occur during construction when dead loads are applied.

### Seismic Design

The 2018 International Building Code (2018 IBC) recognizes the most recent edition of the Minimum Design Loads for Buildings and Other Structures manual (ASCE 7-16) for seismic design, specifically with respect to earthquake loads. Based on the soil conditions encountered at the test pit locations, the parameters and values provided below are recommended for seismic design per the 2018 IBC.

Parameter	Value
Site Class	D*
Mapped short period spectral response acceleration, $S_s (g)$	1.262
Mapped 1-second period spectral response acceleration, $S_1 (g)$	0.436
Short period site coefficient, $F_a$	1.0
Long period site coefficient, $F_v$	1.864 <sup>†</sup>
Adjusted short period spectral response acceleration, $S_{MS} (g)$	1.262
Adjusted 1-second period spectral response acceleration, $S_{M1} (g)$	0.813 <sup>†</sup>
Design short period spectral response acceleration, $S_{DS} (g)$	0.841
Design 1-second period spectral response acceleration, $S_{D1} (g)$	0.542 <sup>†</sup>

\* Assumes dense native soil conditions, encountered to a maximum depth of 11 feet bgs during the December 2021 and January 2022 field explorations, remain dense to at least 100 feet bgs.

† Values assume  $F_v$  may be determined using linear interpolation per Table 11.4-2 in ASCE 7-16.

As indicated in the table footnote, several of the seismic design values provided above are dependent on the assumption that site-specific ground motion analysis (per Section 11.4.8 of ASCE 7-16) will not be required for the subject project. ESNW recommends the validity of this assumption be confirmed at the earliest available opportunity during the planning and early design stages of the project. Further discussion between the project structural engineer, the project owner, and ESNW may be prudent to determine the possible impacts to the structural design due to increased earthquake load requirements under the 2018 IBC. ESNW can provide additional consulting services to aid with design efforts, including supplementary geotechnical and geophysical investigation, upon request.

Liquefaction is a phenomenon where saturated or loose soil suddenly loses internal strength and behaves as a fluid. This behavior is in response to increased pore water pressures resulting from an earthquake or another source of intense ground shaking. As mentioned in the *Geologically Hazardous Areas* section of this letter, it is our opinion site susceptibility to liquefaction is low. The relatively consistent density of the native soils was the primary basis for this opinion.

### **Slab-on-Grade Floors**

Slab-on-grade floors for the proposed residential structure should be supported on firm and unyielding subgrades comprised of competent native soil, compacted structural fill, or new structural fill. Unstable or yielding subgrade areas should be recompacted or overexcavated and replaced with suitable structural fill prior to slab construction.

A capillary break, consisting of at least four inches of free-draining crushed rock or gravel, should be placed below each slab. The free-draining material should have a fines content of 5 percent or less (where the fines content is defined as the percent passing the Number 200 sieve, based on the minus three-quarter-inch fraction). In areas where slab moisture is undesirable, installation of a vapor barrier below each slab should be considered. If a vapor barrier is to be utilized, it should be a material specifically designed for use as a vapor barrier and should be installed in accordance with the specifications of the manufacturer.

### **Retaining Walls**

Retaining walls must be designed to resist earth pressures and applicable surcharge loads. The following parameters may be used for design:

- Active earth pressure (unrestrained condition)                      35 pcf (equivalent fluid)
- At-rest earth pressure (restrained condition)                              55 pcf
- Traffic surcharge\* (passenger vehicles)                                      70 psf (rectangular distribution)
- Passive earth pressure    300 pcf (equivalent fluid)
- Coefficient of friction    0.40
- Seismic surcharge    8H psf<sup>†</sup>

\* Where applicable.

† Where H equals the retained height (in feet).

The above design parameters are based on a level backfill condition and level grade at the wall toe. Revised design values will be necessary if sloping grades are to be used above or below retaining walls. Additional surcharge loading from adjacent foundations, sloped backfill, or other relevant loads should be included in the retaining wall design.

Retaining walls should be backfilled with free-draining material that extends along the height of the wall and a distance of at least 18 inches behind the wall. The upper 12 inches of the wall backfill may consist of a less permeable soil, if desired. A perforated drainpipe should be placed along the base of the wall and connected to an approved discharge location. A typical retaining wall drainage detail is provided on Plate 3. If drainage is not provided, hydrostatic pressures should be included in the wall design.

### Drainage

Groundwater will likely be encountered in site excavations, especially those necessary to construct utility trenches. Temporary measures to control surface water runoff and groundwater during construction would likely involve interceptor trenches and sumps. ESNW should be consulted during preliminary grading to both identify areas of seepage and provide recommendations to reduce the potential for seepage-related instability.

Finish grades must be designed to direct surface drain water away from structures and slopes. Water must not be allowed to pond adjacent to structures. In our opinion, foundation drains should be installed along building perimeter footings. A typical foundation drain detail is provided on Plate 4.

### Infiltration Evaluation

In accordance with the requirements of the referenced 2014 SWMMWW, which is adopted by the City of Puyallup, one small-scale Pilot Infiltration Test (PIT) was completed during the January 2022 fieldwork. The PIT was completed at TP-7 at a depth of about four feet bgs. Per the 2014 SWMMWW, the measured infiltration rate must be reduced by correction factors that account for site variability and number of locations tested ( $CF_v$ ), test method ( $CF_t$ ), and the degree of influent control to prevent siltation and bio-buildup ( $CF_m$ ). The following is a summary of the measured rate, applicable correction factors, and the recommended design rate:

- |   |                             |
|---|-----------------------------|
| • $K_{sat}$ initial (measured rate at TP-7) | 600 inches per hour (in/hr) |
| • $CF_t$                                    | 0.5 (small-scale PIT)       |
| • $CF_v$                                    | 0.7                         |
| • $CF_m$                                    | 0.9                         |
| • $K_{sat}$ design (calculated rate)        | 30 in/hr*                   |

\* Recommended maximum (capped) design infiltration rate.

Based on the field investigations, the above infiltration rate is applicable only within the southwest site corner (in the area of TP-1, TP-6, and TP-7). Elsewhere on site, infiltration is not feasible from a geotechnical standpoint given the widespread existing fill and the presence of relatively impermeable native soil at depth.

ESNW should be contacted to review stormwater management plans if infiltration is used for design. Supplementary recommendations and/or testing may be necessary depending on the size, depth, and siting of infiltration facilities.

### **Dispersion Feasibility**

Based on our field observations of on-site conditions and the subsurface makeup, it is our opinion that dispersion is feasible from a geotechnical standpoint. The erosion potential of the vegetated flow paths can be considered low provided proper vegetation is maintained and/or reestablished (as needed). This opinion is based on the depicted siting of the dispersion trenches (per the referenced site plan) and the relatively stable nature of the native soils, which are not likely to be adversely affected from a dispersion scheme. Where fill will be present underlying dispersion systems, ESNW should be contacted to review the proposed layouts and provide recommendations, as necessary, to ensure adequate long-term performance. We anticipate a portion of the outflow will infiltrate into the substratum as interflow.

### **Limitations & Additional Services**

This letter has been prepared for the exclusive use of HC Homes, Inc., and its representatives. No warranty, express or implied, is made. The recommendations and conclusions provided in this letter are professional opinions consistent with the level of care and skill that is typical of other members in the profession currently practicing under similar conditions in this area. Variations in the soil and groundwater conditions encountered at the test pit locations may exist and may not become evident until construction. ESNW should reevaluate the contents of this letter if variations are encountered during construction, or if the design assumptions outlined herein either change or are incorrect.

ESNW should have an opportunity to review final project plans with respect to the geotechnical recommendations provided in this report. ESNW should also be retained to provide testing and consultation services during construction. Provided that ESNW is retained during construction, we can provide supplementary geotechnical recommendations, as necessary, where differing soil conditions are encountered.



We trust this letter meets your current needs. Please call if you have any questions about this letter or if we can be of further assistance.

Sincerely,

**EARTH SOLUTIONS NW, LLC**



Steven K. Hartwig, G.I.T.  
Staff Geologist

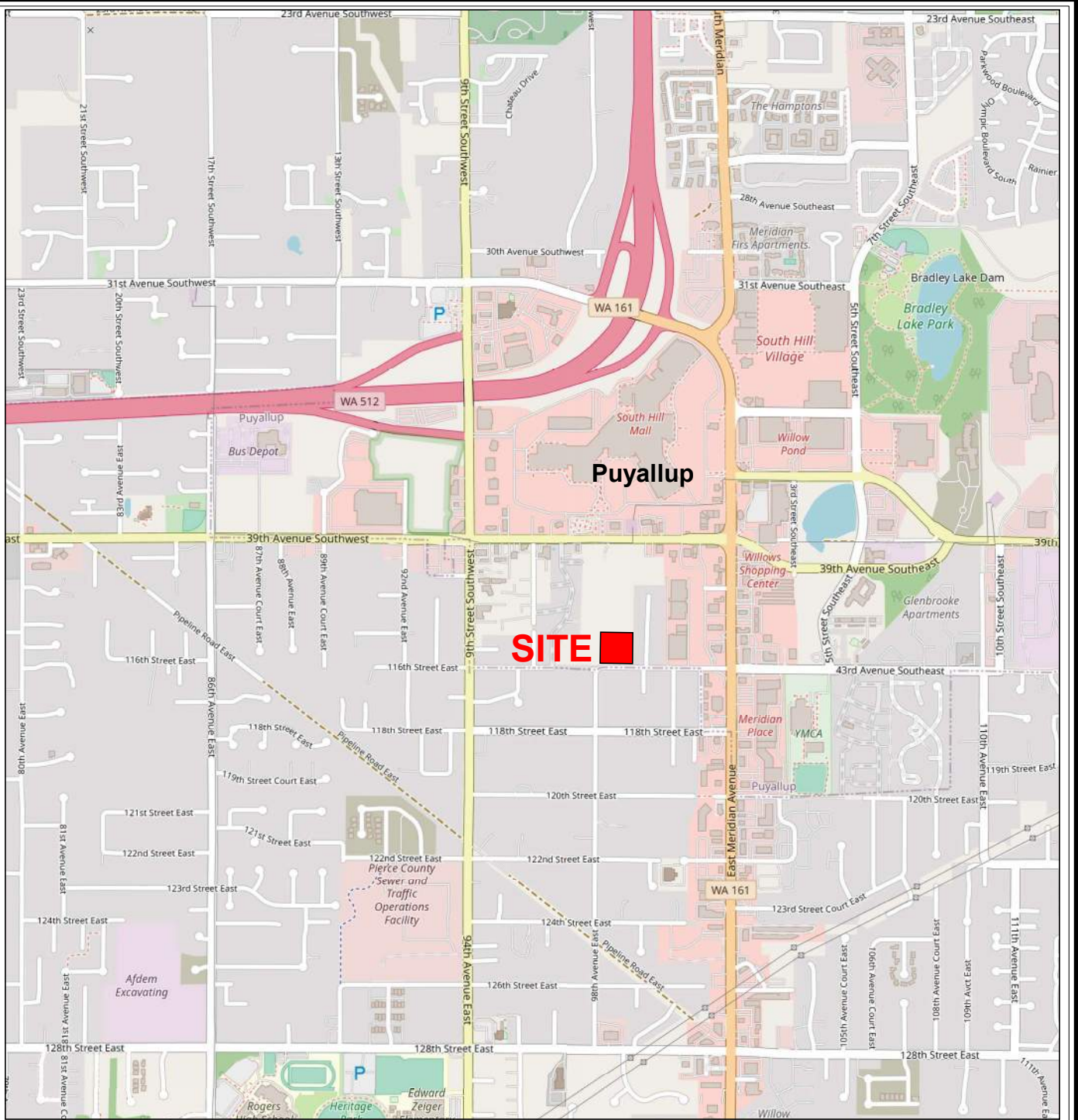


Keven D. Hoffmann, P.E.  
Associate Principal Engineer

Attachments: Plate 1 – Vicinity Map  
Plate 2 – Test Pit Location Plan  
Plate 3 – Retaining Wall Drainage Detail  
Plate 4 – Footing Drain Detail  
Test Pit Logs  
Grain Size Distribution

cc: CES NW, Inc.  
Attention: Mr. Craig Deaver (Email only)  
Mr. Eric Oehler, P.E. (Email only)  
Ms. Dawn Markakis (Email only)

HC Homes, Inc.  
Attention: Mr. Gregg Johnson (Email only)



Reference:  
Pierce County, Washington  
OpenStreetMap.org

NOTE: This plate may contain areas of color. ESNW cannot be responsible for any subsequent misinterpretation of the information resulting from black & white reproductions of this plate.

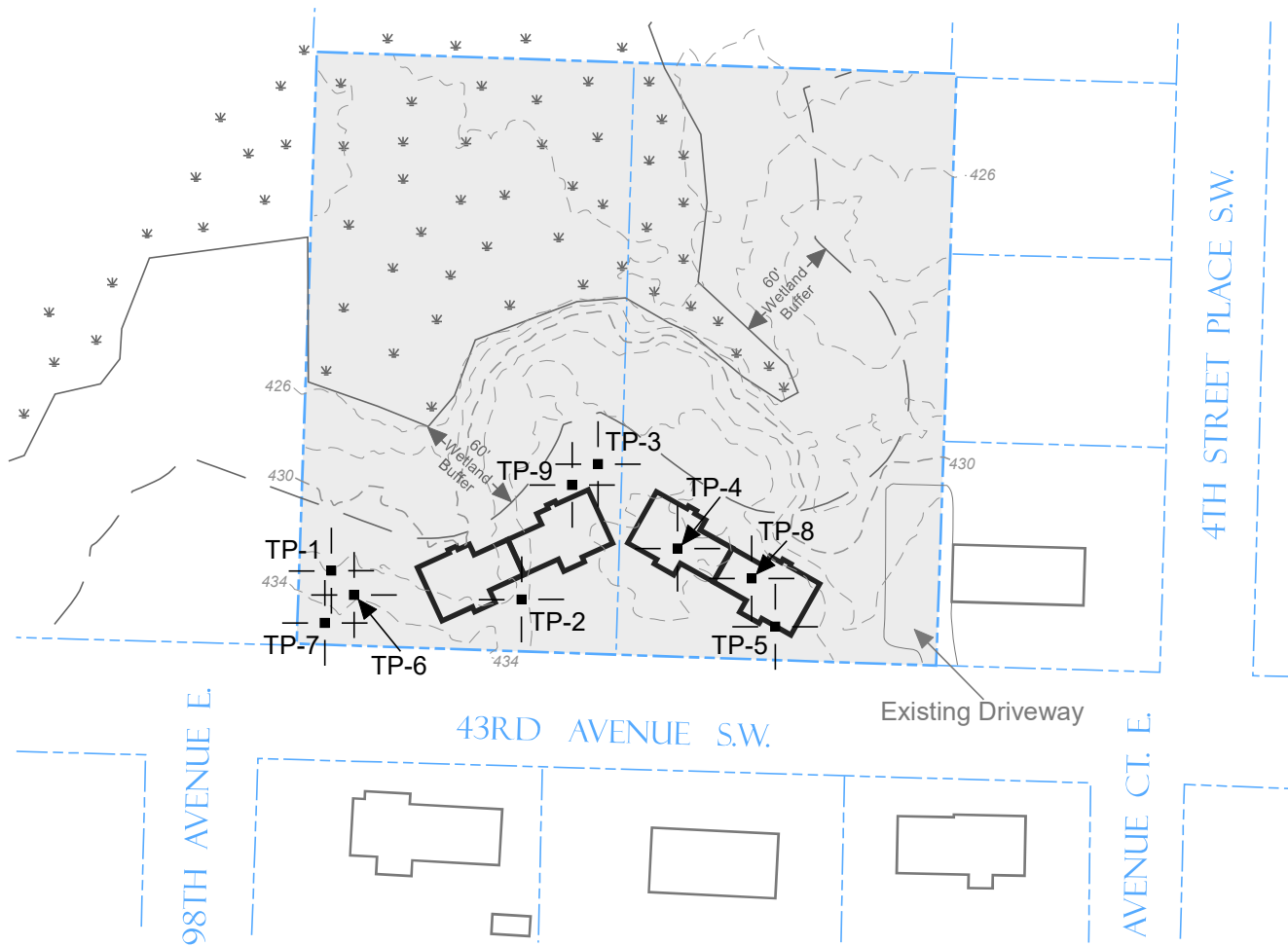


**Earth Solutions NW LLC**

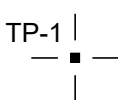




Geotechnical Engineering, Construction  
Observation/Testing and Environmental Services

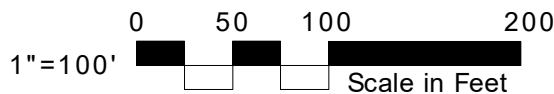
Vicinity Map  
Puyallup Duplex  
Puyallup, Washington

Drwn. CAM	Date 02/18/2022	Proj. No. 8303
Checked SKH	Date Feb. 2022	Plate 1




**LEGEND**

- 
 TP-1 | Approximate Location of ESNW Test Pit, Proj. No. ES-8303, Dec. 2021 & Jan. 2022
- 
 Subject Site
- 
 Proposed Building
- 
 Existing Building
- 
 Wetland (Delineated by Others)



NOTE: The graphics shown on this plate are not intended for design purposes or precise scale measurements, but only to illustrate the approximate test locations relative to the approximate locations of existing and / or proposed site features. The information illustrated is largely based on data provided by the client at the time of our study. ESNW cannot be responsible for subsequent design changes or interpretation of the data by others.

NOTE: This plate may contain areas of color. ESNW cannot be responsible for any subsequent misinterpretation of the information resulting from black & white reproductions of this plate.

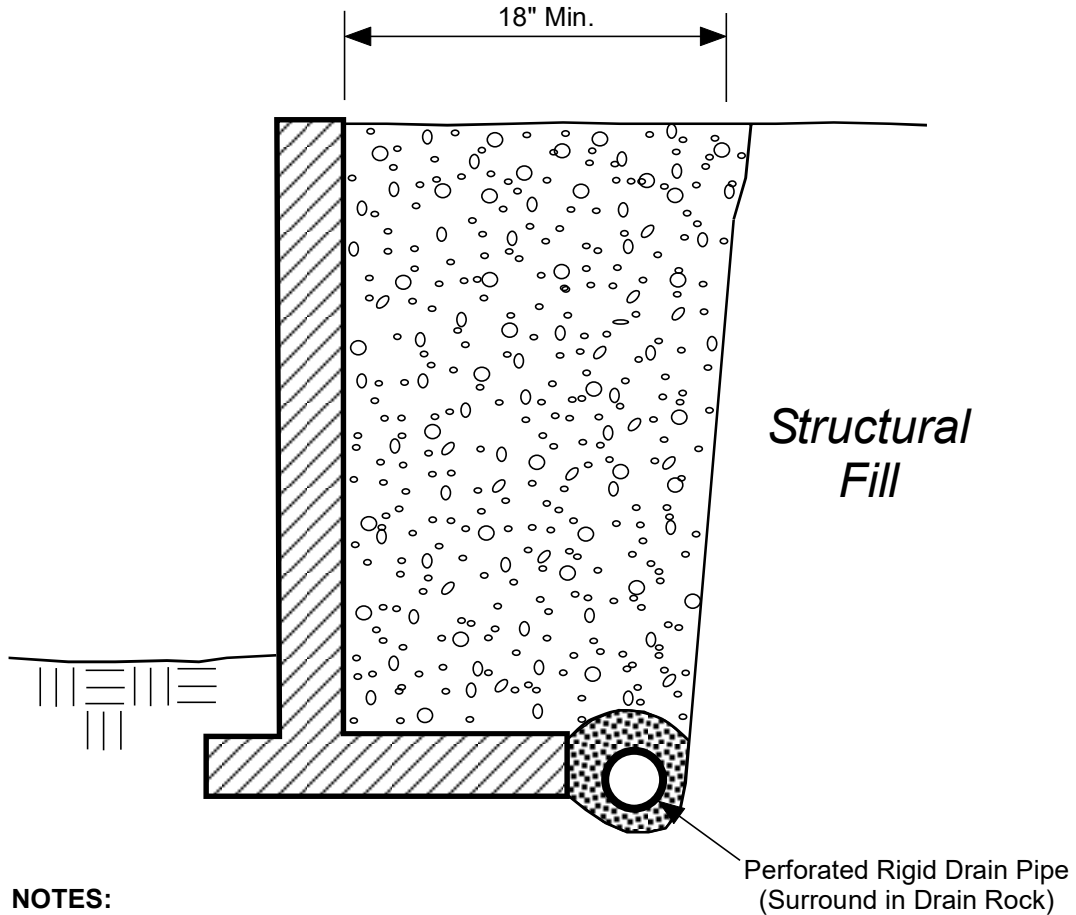


**Earth Solutions NW<sub>LLC</sub>**

Geotechnical Engineering, Construction  
Observation/Testing and Environmental Services

**Test Pit Location Plan**  
**Puyallup Duplex**  
**Puyallup, Washington**

Drwn. CAM	Date 03/27/2023	Proj. No. 8303
Checked SKH	Date Mar. 2023	Plate 2

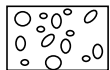


**NOTES:**

- Free-draining Backfill should consist of soil having less than 5 percent fines. Percent passing No. 4 sieve should be 25 to 75 percent.
- Sheet Drain may be feasible in lieu of Free-draining Backfill, per ESNW recommendations.
- Drain Pipe should consist of perforated, rigid PVC Pipe surrounded with 1-inch Drain Rock.

SCHEMATIC ONLY - NOT TO SCALE  
NOT A CONSTRUCTION DRAWING


**LEGEND:**



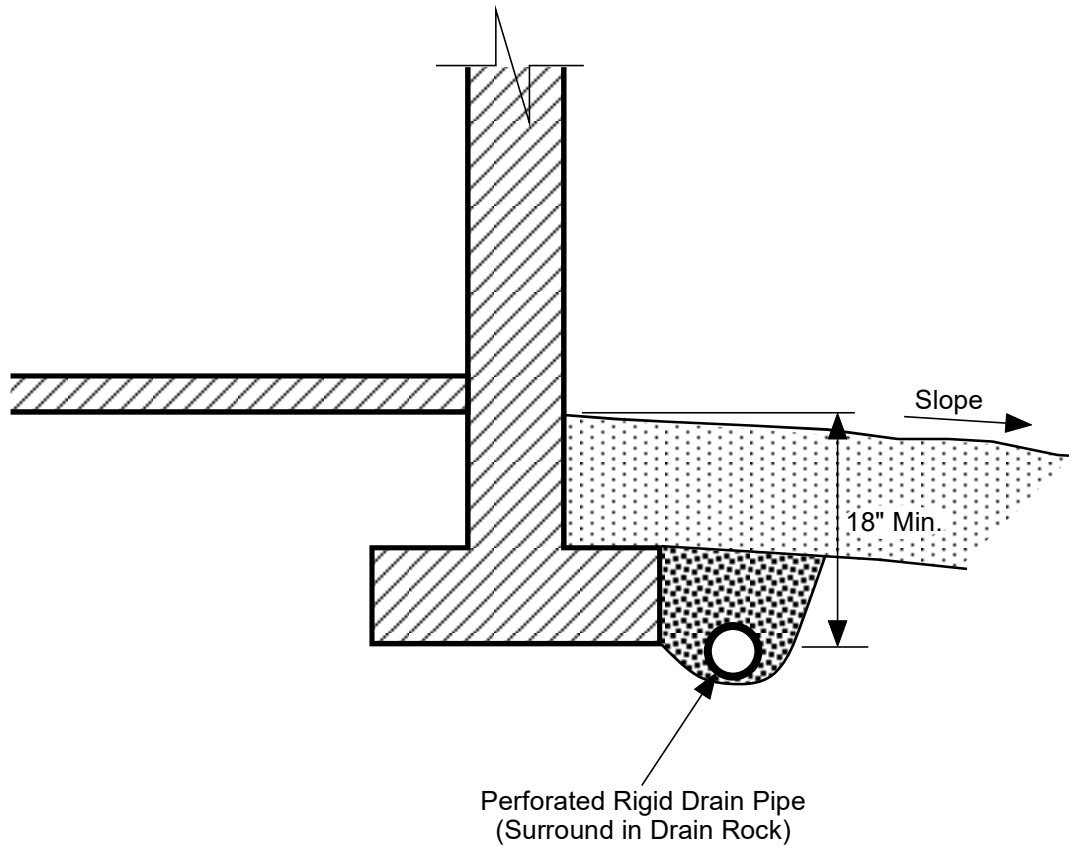
Free-draining Structural Backfill



1-inch Drain Rock

		<b>Earth Solutions NW<sub>LLC</sub></b> Geotechnical Engineering, Construction Observation/Testing and Environmental Services	
<b>Retaining Wall Drainage Detail</b> <b>Puyallup Duplex</b> <b>Puyallup, Washington</b>			
Drwn. CAM	Date 02/18/2022	Proj. No. 8303	
Checked SKH	Date Feb. 2022	Plate 3	



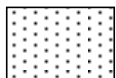


**NOTES:**

- Do NOT tie roof downspouts to Footing Drain.
- Surface Seal to consist of 12" of less permeable, suitable soil. Slope away from building.

SCHMATIC ONLY - NOT TO SCALE  
NOT A CONSTRUCTION DRAWING


**LEGEND:**



Surface Seal: native soil or other low-permeability material.



1-inch Drain Rock

		<b>Earth Solutions NW<sub>LLC</sub></b> Geotechnical Engineering, Construction Observation/Testing and Environmental Services	
<b>Footing Drain Detail</b> <b>Puyallup Duplex</b> <b>Puyallup, Washington</b>			
Drwn. CAM	Date 02/18/2022	Proj. No. 8303	
Checked SKH	Date Feb. 2022	Plate 4	

Coarse-Grained Soils - More Than 50% Retained on No. 200 Sieve		Moisture Content		Symbols	
Gravels - More Than 50% of Coarse Fraction Retained on No. 4 Sieve		<b>GW</b>	Well-graded gravel with or without sand, little to no fines	Dry - Absence of moisture, dusty, dry to the touch	
		<b>GP</b>	Poorly graded gravel with or without sand, little to no fines	Damp - Perceptible moisture, likely below optimum MC	
		<b>GM</b>	Silty gravel with or without sand	Moist - Damp but no visible water, likely at/near optimum MC	
		<b>GC</b>	Clayey gravel with or without sand	Wet - Water visible but not free draining, likely above optimum MC	
Sands - 50% or More of Coarse Fraction Passes No. 4 Sieve		<b>SW</b>	Well-graded sand with or without gravel, little to no fines	Saturated/Water Bearing - Visible free water, typically below groundwater table	
		<b>SP</b>	Poorly graded sand with or without gravel, little to no fines		
		<b>SM</b>	Silty sand with or without gravel		
		<b>SC</b>	Clayey sand with or without gravel		
Fine-Grained Soils - 50% or More Passes No. 200 Sieve		Terms Describing Relative Density and Consistency			
Silt and Clays Liquid Limit Less Than 50		<b>ML</b>	Silt with or without sand or gravel; sandy or gravelly silt	<b>Coarse-Grained Soils:</b> <u>Density</u> <u>SPT blows/foot</u> Very Loose                      < 4 Loose                              4 to 9 Medium Dense                    10 to 29 Dense                                30 to 49 Very Dense                        ≥ 50	
		<b>CL</b>	Clay of low to medium plasticity; lean clay with or without sand or gravel; sandy or gravelly lean clay	<b>Fine-Grained Soils:</b> <u>Consistency</u> <u>SPT blows/foot</u> Very Soft                              < 2 Soft                                        2 to 3 Medium Stiff                        4 to 7 Stiff                                        8 to 14 Very Stiff                              15 to 29 Hard                                        ≥ 30	
		<b>OL</b>	Organic clay or silt of low plasticity	<b>Test Symbols &amp; Units</b> Fines = Fines Content (%) MC = Moisture Content (%) DD = Dry Density (pcf) Str = Shear Strength (tsf) PID = Photoionization Detector (ppm) OC = Organic Content (%) CEC = Cation Exchange Capacity (meq/100 g) LL = Liquid Limit (%) PL = Plastic Limit (%) PI = Plasticity Index (%)	
		<b>MH</b>	Elastic silt with or without sand or gravel; sandy or gravelly elastic silt		
Silt and Clays Liquid Limit 50 or More		<b>CH</b>	Clay of high plasticity; fat clay with or without sand or gravel; sandy or gravelly fat clay	<b>Component Definitions</b> <u>Descriptive Term</u> <u>Size Range and Sieve Number</u> Boulders                                      Larger than 12" Cobbles                                        3" to 12" Gravel                                        3" to No. 4 (4.75 mm) Coarse Gravel                        3" to 3/4" Fine Gravel                              3/4" to No. 4 (4.75 mm) Sand                                        No. 4 (4.75 mm) to No. 200 (0.075 mm) Coarse Sand                            No. 4 (4.75 mm) to No. 10 (2.00 mm) Medium Sand                            No. 10 (2.00 mm) to No. 40 (0.425 mm) Fine Sand                                No. 40 (0.425 mm) to No. 200 (0.075 mm) Silt and Clay                                Smaller than No. 200 (0.075 mm)	
		<b>OH</b>	Organic clay or silt of medium to high plasticity		
Highly Organic Soils		<b>PT</b>	Peat, muck, and other highly organic soils	<b>Modifier Definitions</b> <u>Percentage by Weight (Approx.)</u> <u>Modifier</u> < 5    Trace (sand, silt, clay, gravel) 5 to 14    Slightly (sandy, silty, clayey, gravelly) 15 to 29    Sandy, silty, clayey, gravelly ≥ 30    Very (sandy, silty, clayey, gravelly)	
Fill		<b>FILL</b>	Made Ground	Classifications of soils in this geotechnical report and as shown on the exploration logs are based on visual field and/or laboratory observations, which include density/consistency, moisture condition, grain size, and plasticity estimates, and should not be construed to imply field or laboratory testing unless presented herein. Visual-manual and/or laboratory classification methods of ASTM D2487 and D2488 were used as an identification guide for the Unified Soil Classification System.	





Earth Solutions NW, LLC  
 15365 N.E. 90th Street, Suite 100  
 Redmond, Washington 98052  
 Telephone: 425-449-4704  
 Fax: 425-449-4711

PROJECT NUMBER ES-8303 PROJECT NAME Puyallup Duplex  
 DATE STARTED 12/8/21 COMPLETED 12/8/21 GROUND ELEVATION 432 ft  
 EXCAVATION CONTRACTOR NW Excavating LATITUDE 47.15143 LONGITUDE -122.2983  
 LOGGED BY SKH CHECKED BY KDH GROUND WATER LEVEL:  
 NOTES Depth of Topsoil & Sod 8": forest duff  $\nabla$  AT TIME OF EXCAVATION 8.0 ft  
 SURFACE CONDITIONS \_\_\_\_\_ AFTER EXCAVATION \_\_\_\_\_

DEPTH (ft)	SAMPLE TYPE NUMBER	TESTS	U.S.C.S.	GRAPHIC LOG	MATERIAL DESCRIPTION	
0						
		MC = 16.3 Fines = 12.8	TPSL		Dark brown TOPSOIL, roots to 1.5'	431.3
			SM		Brown silty SAND with gravel, loose to medium dense, damp -slight caving to BOH [USDA Classification: gravelly loamy SAND]	
				3.0		429.0
		MC = 4.5			Brown well-graded GRAVEL with sand, medium dense, damp (Qgo: recessional outwash)	
5						
		MC = 12.1 Fines = 0.7				
		MC = 11.7			-becomes moist [USDA Classification: extremely gravelly coarse SAND] -moderate groundwater at BOH	424.0
				8.0 $\nabla$		

Test pit terminated at 8.0 feet below existing grade. Groundwater table encountered at BOH during excavation. Caving observed from 1.0 foot to BOH.



Earth Solutions NW, LLC  
 15365 N.E. 90th Street, Suite 100  
 Redmond, Washington 98052  
 Telephone: 425-449-4704  
 Fax: 425-449-4711

# TEST PIT NUMBER TP-2

PROJECT NUMBER ES-8303 PROJECT NAME Puyallup Duplex  
 DATE STARTED 12/8/21 COMPLETED 12/8/21 GROUND ELEVATION 434 ft  
 EXCAVATION CONTRACTOR NW Excavating LATITUDE 47.15139 LONGITUDE -122.2979  
 LOGGED BY SKH CHECKED BY KDH GROUND WATER LEVEL:  
 NOTES Depth of Topsoil & Sod 6": forest duff  $\nabla$  AT TIME OF EXCAVATION 10.0 ft  
 SURFACE CONDITIONS \_\_\_\_\_ AFTER EXCAVATION \_\_\_\_\_

DEPTH (ft)	SAMPLE TYPE NUMBER	TESTS	U.S.C.S.	GRAPHIC LOG	MATERIAL DESCRIPTION	
0			TPSL		Dark brown TOPSOIL, roots to 18"	433.5
			SM		Brown silty SAND with gravel, medium dense, damp (Fill) -asphalt debris, slight caving to BOH  -wood debris  -wood/asphalt/concrete debris	
5		MC = 32.5	SM			426.0
			SM		Brown silty SAND with gravel, dense, moist to wet -becomes gray	
10			GP		-moderate groundwater at 10'	424.0
		MC = 17.5	GP		Gray poorly graded GRAVEL, medium dense, wet (Qgo: recessional outwash)	423.5

Test pit terminated at 10.5 feet below existing grade. Groundwater table encountered at 10.0 feet during excavation. Caving observed from 1.0 foot to BOH.





Earth Solutions NW, LLC  
 15365 N.E. 90th Street, Suite 100  
 Redmond, Washington 98052  
 Telephone: 425-449-4704  
 Fax: 425-449-4711

# TEST PIT NUMBER TP-3

PAGE 1 OF 1

PROJECT NUMBER ES-8303 PROJECT NAME Puyallup Duplex  
 DATE STARTED 12/8/21 COMPLETED 12/8/21 GROUND ELEVATION 435 ft  
 EXCAVATION CONTRACTOR NW Excavating LATITUDE 47.15159 LONGITUDE -122.29784  
 LOGGED BY SKH CHECKED BY KDH GROUND WATER LEVEL:  
 NOTES Depth of Topsoil & Sod 6": brush  AT TIME OF EXCAVATION \_\_\_\_\_  
 SURFACE CONDITIONS \_\_\_\_\_ AFTER EXCAVATION \_\_\_\_\_

DEPTH (ft)	SAMPLE TYPE NUMBER	TESTS	U.S.C.S.	GRAPHIC LOG	MATERIAL DESCRIPTION	
0			TPSL		Dark brown TOPSOIL, roots to 2'	434.5
		MC = 11.9	SM		Brown silty SAND, loose to medium dense, damp (Fill) -asphalt debris, slight to moderate caving to BOH	
5		MC = 17.4 Fines = 22.9	SM		-plastic debris	429.0
10		MC = 44.9	SM		Brown silty SAND with gravel, medium dense, damp [USDA Classification: gravelly sandy LOAM]	425.0

Test pit terminated at 10.0 feet below existing grade due to caving. No groundwater encountered during excavation. Caving observed from 1.0 foot to BOH.



Earth Solutions NW, LLC  
 15365 N.E. 90th Street, Suite 100  
 Redmond, Washington 98052  
 Telephone: 425-449-4704  
 Fax: 425-449-4711

# TEST PIT NUMBER TP-4

PROJECT NUMBER ES-8303 PROJECT NAME Puyallup Duplex  
 DATE STARTED 12/8/21 COMPLETED 12/8/21 GROUND ELEVATION 437 ft  
 EXCAVATION CONTRACTOR NW Excavating LATITUDE 47.1514 LONGITUDE -122.2977  
 LOGGED BY SKH CHECKED BY KDH GROUND WATER LEVEL:  
 NOTES Depth of Topsoil & Sod 6": brush  $\nabla$  AT TIME OF EXCAVATION 11.0 ft  
 SURFACE CONDITIONS \_\_\_\_\_ AFTER EXCAVATION \_\_\_\_\_

DEPTH (ft)	SAMPLE TYPE NUMBER	TESTS	U.S.C.S.	GRAPHIC LOG	MATERIAL DESCRIPTION	
0			TPSL		Dark brown TOPSOIL, roots to 2'	436.5
			SP		Brown poorly graded SAND, loose to medium dense, damp (Fill)	435.5
			GP-GM		Brown poorly graded GRAVEL with silt and sand, loose to medium dense, damp (Fill)  -wood and plastic debris  -slight caving to BOH  [USDA Classification: extremely gravelly loamy SAND]	
5		MC = 16.7 Fines = 9.4				
10		MC = 28.5	SM		Brown silty SAND with gravel, medium dense, moist to wet	427.5
		MC = 28.0			-moderate groundwater at BOH	426.0

Test pit terminated at 11.0 feet below existing grade due to caving. Groundwater table encountered at BOH during excavation. Caving observed from 4.0 feet to BOH.



Earth Solutions NW, LLC  
 15365 N.E. 90th Street, Suite 100  
 Redmond, Washington 98052  
 Telephone: 425-449-4704  
 Fax: 425-449-4711

# TEST PIT NUMBER TP-5

PAGE 1 OF 1

PROJECT NUMBER ES-8303 PROJECT NAME Puyallup Duplex  
 DATE STARTED 12/8/21 COMPLETED 12/8/21 GROUND ELEVATION 435 ft  
 EXCAVATION CONTRACTOR NW Excavating LATITUDE 47.1513 LONGITUDE -122.29755  
 LOGGED BY SKH CHECKED BY KDH GROUND WATER LEVEL:  
 NOTES Depth of Topsoil & Sod 6": brush  AT TIME OF EXCAVATION \_\_\_\_\_  
 SURFACE CONDITIONS \_\_\_\_\_ AFTER EXCAVATION \_\_\_\_\_

DEPTH (ft)	SAMPLE TYPE NUMBER	TESTS	U.S.C.S.	GRAPHIC LOG	MATERIAL DESCRIPTION	
0			TPSL		Dark brown TOPSOIL, roots to 1.5'	434.5
			SM		Brown silty SAND with gravel, loose to medium dense, moist (Fill)  -plastic debris  -slight caving to 5'  -moderate caving to BOH	
5		MC = 14.3				
			SP		Brown poorly graded SAND, medium dense, damp to moist [USDA Classification: slightly gravelly SAND]	428.0
		MC = 7.4 Fines = 0.5				427.0

Test pit terminated at 8.0 feet below existing grade due to caving. No groundwater encountered during excavation. Caving observed from 3.0 feet to BOH.



Earth Solutions NW, LLC  
 15365 N.E. 90th Street, Suite 100  
 Redmond, Washington 98052  
 Telephone: 425-449-4704  
 Fax: 425-449-4711

# TEST PIT NUMBER TP-6

PAGE 1 OF 1

PROJECT NUMBER ES-8303 PROJECT NAME Puyallup Duplex  
 DATE STARTED 1/13/22 COMPLETED 1/13/22 GROUND ELEVATION 434 ft  
 EXCAVATION CONTRACTOR NW Excavating LATITUDE 47.1514 LONGITUDE -122.29831  
 LOGGED BY SKH CHECKED BY KDH GROUND WATER LEVEL:  
 NOTES Depth of Topsoil & Sod 6": bare soil/light brush  AT TIME OF EXCAVATION \_\_\_\_\_  
 SURFACE CONDITIONS \_\_\_\_\_ AFTER EXCAVATION \_\_\_\_\_

DEPTH (ft)	SAMPLE TYPE NUMBER	TESTS	U.S.C.S.	GRAPHIC LOG	MATERIAL DESCRIPTION	
0			TPSL		Dark brown TOPSOIL, roots to 12"	433.5
		MC = 5.4 Fines = 2.5			Brown well-graded GRAVEL with sand, medium dense, damp (Qgo: recessional outwash)  [USDA Classification: extremely gravelly coarse SAND] -becomes gray, moist	
5		MC = 10.1	GW		-slight caving to BOH	
		MC = 7.0			-light to moderate groundwater seepage	426.0

Test pit terminated at 8.0 feet below existing grade. Groundwater seepage encountered at 7.0 feet during excavation. Caving observed from 4.0 feet to BOH.





Earth Solutions NW, LLC  
 15365 N.E. 90th Street, Suite 100  
 Redmond, Washington 98052  
 Telephone: 425-449-4704  
 Fax: 425-449-4711

# TEST PIT NUMBER TP-7

PROJECT NUMBER ES-8303 PROJECT NAME Puyallup Duplex  
 DATE STARTED 1/13/22 COMPLETED 1/13/22 GROUND ELEVATION 435 ft  
 EXCAVATION CONTRACTOR NW Excavating LATITUDE 47.15134 LONGITUDE -122.29838  
 LOGGED BY SKH CHECKED BY KDH GROUND WATER LEVEL:  
 NOTES Depth of Topsoil & Sod 6": light brush  $\nabla$  AT TIME OF EXCAVATION 8.0 ft  
 SURFACE CONDITIONS \_\_\_\_\_ AFTER EXCAVATION \_\_\_\_\_

DEPTH (ft)	SAMPLE TYPE NUMBER	TESTS	U.S.C.S.	GRAPHIC LOG	MATERIAL DESCRIPTION	
0			TPSL		Dark brown TOPSOIL, roots to 12"	434.5
		MC = 3.3  MC = 5.2 Fines = 1.5	GW		Brown well-graded GRAVEL with sand, loose to medium dense, damp (Qgo: recessional outwash)  -becomes gray -slight caving to 6'  [USDA Classification: extremely gravelly coarse SAND]  -moderate caving to BOH	428.0
5		MC = 10.1 Fines = 0.5	GP		Gray poorly graded GRAVEL with sand, medium dense, damp to moist  -becomes wet -groundwater table [USDA Classification: extremely gravelly coarse SAND]	426.5

Test pit terminated at 8.5 feet below existing grade. Groundwater table encountered at 8.0 feet during excavation. Caving observed from 2.0 feet to BOH.





Earth Solutions NW, LLC  
 15365 N.E. 90th Street, Suite 100  
 Redmond, Washington 98052  
 Telephone: 425-449-4704  
 Fax: 425-449-4711

# TEST PIT NUMBER TP-8

PAGE 1 OF 1

PROJECT NUMBER ES-8303 PROJECT NAME Puyallup Duplex  
 DATE STARTED 1/13/22 COMPLETED 1/13/22 GROUND ELEVATION 435 ft  
 EXCAVATION CONTRACTOR NW Excavating LATITUDE 47.15147 LONGITUDE -122.29737  
 LOGGED BY SKH CHECKED BY KDH GROUND WATER LEVEL:  
 NOTES Depth of Topsoil & Sod 6": brush  AT TIME OF EXCAVATION \_\_\_\_\_  
 SURFACE CONDITIONS \_\_\_\_\_ AFTER EXCAVATION \_\_\_\_\_

DEPTH (ft)	SAMPLE TYPE NUMBER	TESTS	U.S.C.S.	GRAPHIC LOG	MATERIAL DESCRIPTION	
0						
			TPSL		Dark brown TOPSOIL, roots to 12"	434.5
					Brown silty SAND, loose to medium dense, damp to moist (Fill)	
			SM		-wood debris throughout	
					-slight caving to BOH	
5					-becomes moist to wet	
		MC = 24.3				427.5

Test pit terminated at 7.5 feet below existing grade due to buried debris (large stump). No groundwater encountered during excavation. Caving observed from 3.5 feet to BOH.



Earth Solutions NW, LLC  
 15365 N.E. 90th Street, Suite 100  
 Redmond, Washington 98052  
 Telephone: 425-449-4704  
 Fax: 425-449-4711

# TEST PIT NUMBER TP-9

PAGE 1 OF 1

PROJECT NUMBER ES-8303 PROJECT NAME Puyallup Duplex  
 DATE STARTED 1/13/22 COMPLETED 1/13/22 GROUND ELEVATION 435 ft  
 EXCAVATION CONTRACTOR NW Excavating LATITUDE 47.15162 LONGITUDE -122.29777  
 LOGGED BY SKH CHECKED BY KDH GROUND WATER LEVEL:  
 NOTES Depth of Topsoil & Sod 6": brush  AT TIME OF EXCAVATION \_\_\_\_\_  
 SURFACE CONDITIONS \_\_\_\_\_ AFTER EXCAVATION \_\_\_\_\_

DEPTH (ft)	SAMPLE TYPE NUMBER	TESTS	U.S.C.S.	GRAPHIC LOG	MATERIAL DESCRIPTION	
0			TPSL		Dark brown TOPSOIL, roots to 12"	434.5
			SM		Brown silty SAND, loose to medium dense, damp (Fill)  -asphalt debris  -moderate caving to BOH	
5		MC = 10.7				429.0
			SP-SM		Brown poorly graded SAND with silt, medium dense, damp	
		MC = 21.2				426.0
					Test pit terminated at 9.0 feet below existing grade. No groundwater encountered during excavation. Caving observed from 2.5 feet to BOH.	

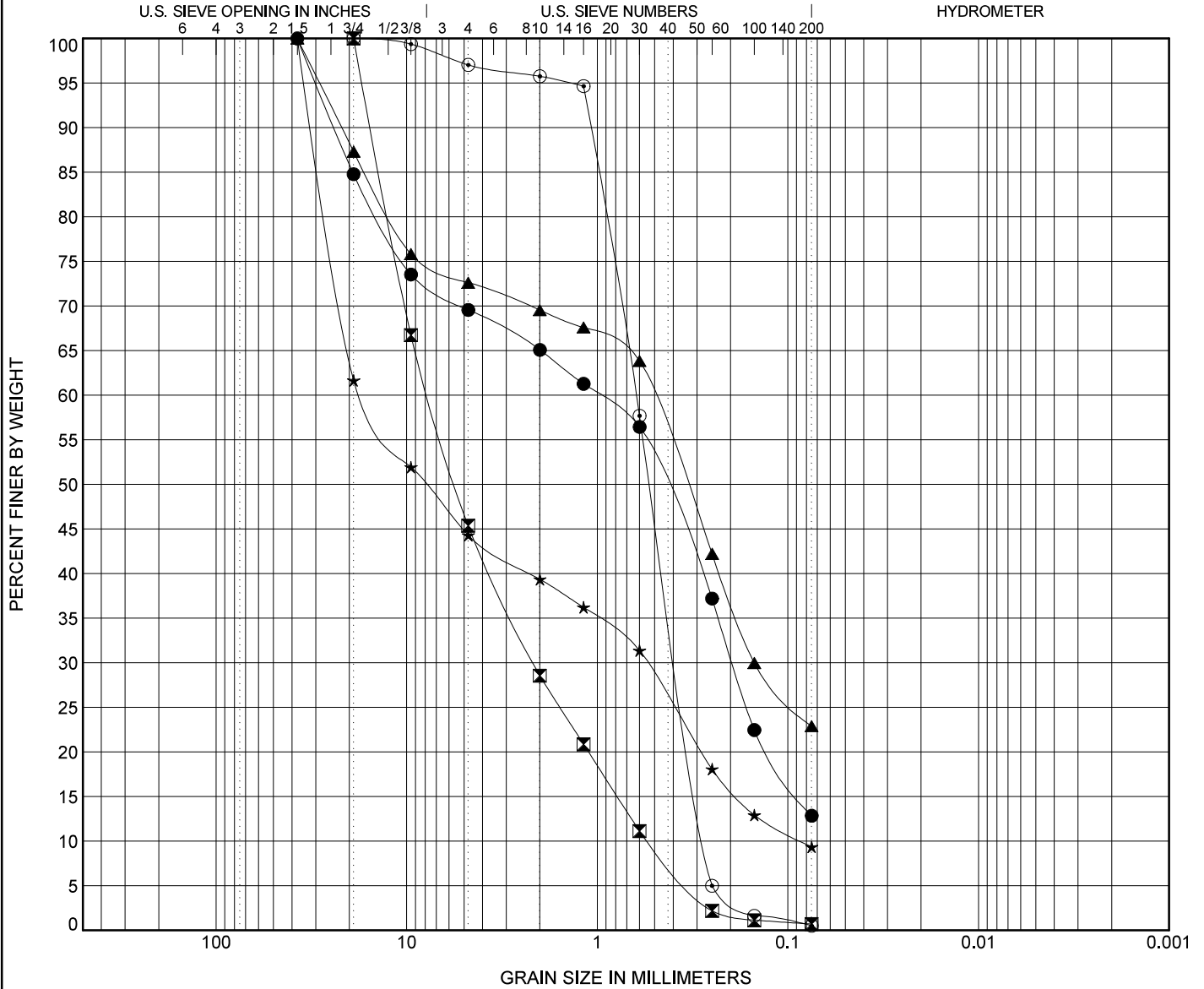


Earth Solutions NW, LLC  
 15365 N.E. 90th Street, Suite 100  
 Redmond, Washington 98052  
 Telephone: 425-449-4704  
 Fax: 425-449-4711

# GRAIN SIZE DISTRIBUTION

PROJECT NUMBER ES-8303

PROJECT NAME Puyallup Duplex



COBBLES	GRAVEL		SAND			SILT OR CLAY
	coarse	fine	coarse	medium	fine	

Specimen Identification			Classification							Cc	Cu
●	TP-01	1.00ft.	USDA: Brown Gravelly Loamy Sand. USCS: SM with Gravel.								
☒	TP-01	7.00ft.	USDA: Brown Extremely Gravelly Coarse Sand. USCS: GW with Sand.							1.13	14.21
▲	TP-03	6.50ft.	USDA: Brown Gravelly Sandy Loam. USCS: SM with Gravel.								
★	TP-04	6.00ft.	USDA: Brown Extremely Gravelly Loamy Sand. USCS: GP-GM with Sand.							0.21	198.62
◎	TP-05	8.00ft.	USDA: Brown Slightly Gravelly Sand. USCS: SP.							0.84	2.30
Specimen Identification			D100	D60	D30	D10	LL	PL	PI	%Silt	%Clay
●	TP-01	1.0ft.	37.5	0.988	0.195					12.8	
☒	TP-01	7.0ft.	19	7.637	2.154	0.537				0.7	
▲	TP-03	6.5ft.	37.5	0.514	0.15					22.9	
★	TP-04	6.0ft.	37.5	16.884	0.548	0.085				9.4	
◎	TP-05	8.0ft.	19	0.626	0.379	0.272				0.5	

GRAIN SIZE USDA ES-8303 PUYALLUP DUPLEX.GPJ GINT US LAB.GDT 12/16/21

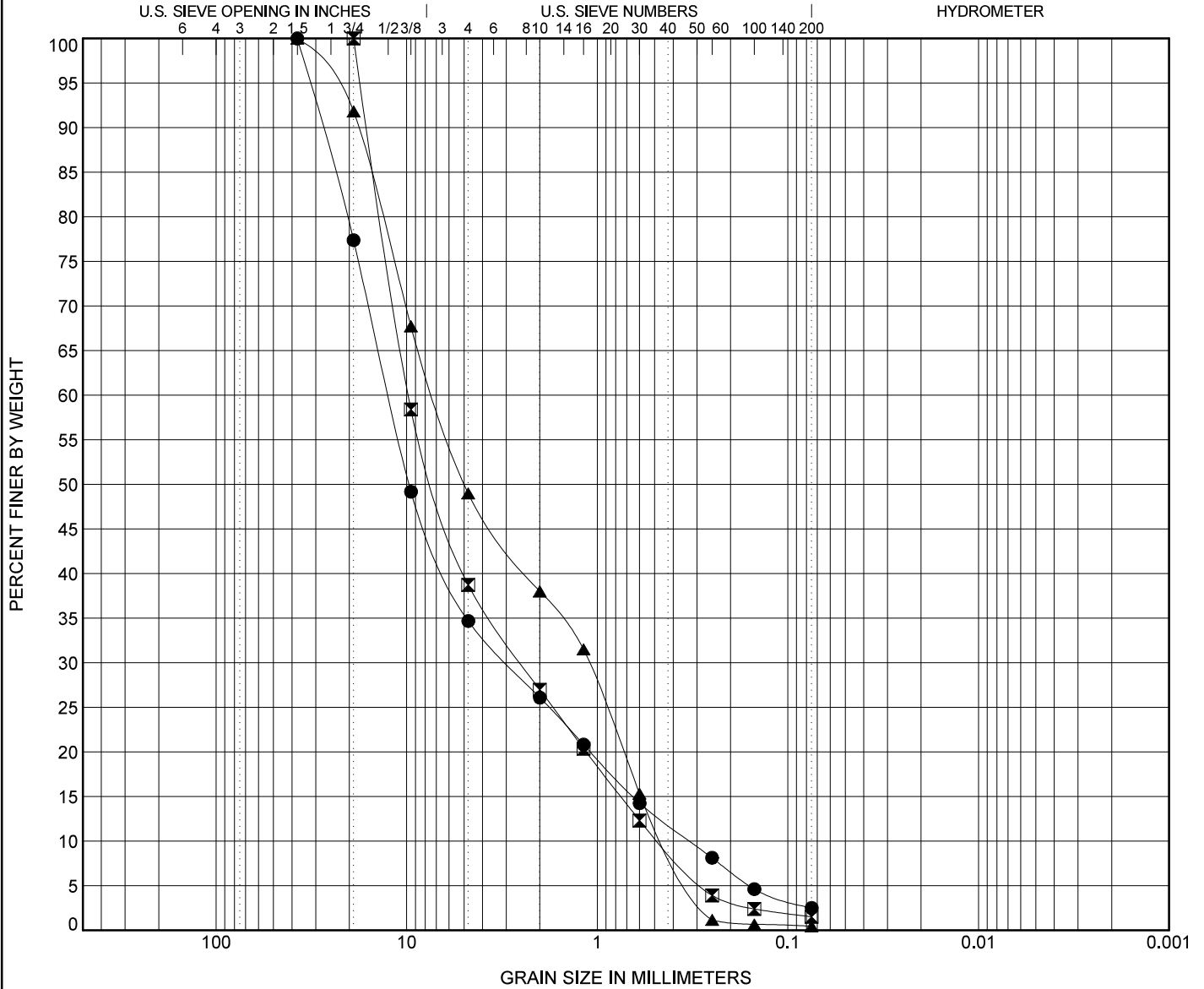


Earth Solutions NW, LLC  
 15365 N.E. 90th Street, Suite 100  
 Redmond, Washington 98052  
 Telephone: 425-449-4704  
 Fax: 425-449-4711

# GRAIN SIZE DISTRIBUTION

PROJECT NUMBER ES-8303

PROJECT NAME Puyallup Duplex



COBBLES	GRAVEL		SAND			SILT OR CLAY
	coarse	fine	coarse	medium	fine	

Specimen Identification	Classification				Cc	Cu
● TP-06 1.50ft.	USDA: Brown Extremely Gravelly Coarse Sand. USCS: GW with Sand.				2.17	37.93
☒ TP-07 4.00ft.	USDA: Gray Extremely Gravelly Coarse Sand. USCS: GW with Sand.				1.36	20.71
▲ TP-07 8.50ft.	USDA: Gray Extremely Gravelly Coarse Sand. USCS: GP with Sand.				0.40	16.54

Specimen Identification	D100	D60	D30	D10	LL	PL	PI	%Silt	%Clay
● TP-06 1.5ft.	37.5	12.396	2.966	0.327				2.5	
☒ TP-07 4.0ft.	19	9.76	2.501	0.471				1.5	
▲ TP-07 8.5ft.	37.5	7.139	1.108	0.432				0.5	

GRAIN SIZE USDA ES-8303 PUYALLUP DUPLEX.GPJ GINT US LAB.GDT 1/21/22