

Construction Stormwater General Permit (CSWGP)

Stormwater Pollution Prevention Plan (SWPPP)

for

Puyallup High School – New Portables

Prepared for:

**Department of Ecology
City of Puyallup**

Permittee / Owner	Developer	Operator / Contractor
Puyallup S.D.		TBD

105 7th St SW, Puyallup, WA 98371

Certified Erosion and Sediment Control Lead (CESCL)

Name	Organization	Contact Phone Number

SWPPP Prepared By

Name	Organization	Contact Phone Number
Pawarisa Onmun	JMJ Team	(206) 596-2020

SWPPP Preparation Date

05 / 29 / 2024

Project Construction Dates

Activity / Phase	Start Date	End Date
Begin Construction	October 2024	February 2025

GENERAL INSTRUCTIONS AND CAVEATS

This template presents the recommended structure and content for preparation of a Construction Stormwater General Permit (CSWGP) Stormwater Pollution Prevention Plan (SWPPP).

The Department of Ecology's (Ecology) CSWGP requirements inform the structure and content of this SWPPP template; however, **you must customize this template to reflect the conditions of your site.**

A Construction Stormwater Site Inspection Form can be found on Ecology's website.

<https://www.ecology.wa.gov/Regulations-Permits/Permits-certifications/Stormwater-general-permits/Construction-stormwater-permit>

Using the SWPPP Template

Each section will include instructions and space for information specific to your project. Please read the instructions for each section and provide the necessary information when prompted. This Word template can be modified electronically. You may add/delete text, copy and paste, edit tables, etc. Some sections may be completed with brief answers while others may require several pages of explanation.

Follow this link to a copy of the Construction Stormwater General Permit:

<https://www.ecology.wa.gov/Regulations-Permits/Permits-certifications/Stormwater-general-permits/Construction-stormwater-permit>

Table of Contents

List of Tables

List of Appendices

List of Acronyms and Abbreviations

Acronym / Abbreviation	Explanation
303(d)	Section of the Clean Water Act pertaining to Impaired Waterbodies
BFO	Bellingham Field Office of the Department of Ecology
BMP(s)	Best Management Practice(s)
CESCL	Certified Erosion and Sediment Control Lead
CO₂	Carbon Dioxide
CRO	Central Regional Office of the Department of Ecology
CSWGP	Construction Stormwater General Permit
CWA	Clean Water Act
DMR	Discharge Monitoring Report
DO	Dissolved Oxygen
Ecology	Washington State Department of Ecology
EPA	United States Environmental Protection Agency
ERO	Eastern Regional Office of the Department of Ecology
ERTS	Environmental Report Tracking System
ESC	Erosion and Sediment Control
GULD	General Use Level Designation
NPDES	National Pollutant Discharge Elimination System
NTU	Nephelometric Turbidity Units
NWRO	Northwest Regional Office of the Department of Ecology
pH	Power of Hydrogen
RCW	Revised Code of Washington
SPCC	Spill Prevention, Control, and Countermeasure
su	Standard Units
SWMMEW	Stormwater Management Manual for Eastern Washington
SWMMWW	Stormwater Management Manual for Western Washington
SWPPP	Stormwater Pollution Prevention Plan
TESC	Temporary Erosion and Sediment Control
SWRO	Southwest Regional Office of the Department of Ecology
TMDL	Total Maximum Daily Load
VFO	Vancouver Field Office of the Department of Ecology
WAC	Washington Administrative Code
WSDOT	Washington Department of Transportation
WWHM	Western Washington Hydrology Model

Project Information (1.0)

Project/Site Name: Puyallup HS – New Portables
Street/Location: 711 W main
City: Puyallup State: WA Zip code: 98371
Subdivision:
Receiving waterbody: Puyallup River

Existing Conditions (1.1)

Total acreage (including support activities such as off-site equipment staging yards, material storage areas, borrow areas).

Total acreage: 0.38 Acres

Disturbed acreage: 0.38 Acres

Existing structures: Existing asphalt parking lot, asphalt sidewalk, lawn, and portables.
Project site will occur on lawn area.

Landscape topography: Flat

Drainage patterns: Overland flow to existing catch basins

Existing Vegetation: Trees and grass

Critical Areas (wetlands, streams, high erosion risk, steep or difficult to stabilize slopes):
None

List of known impairments for 303(d) listed or Total Maximum Daily Load (TMDL) for the receiving waterbody: None

Table 1 includes a list of suspected and/or known contaminants associated with the construction activity.

Table 1 – Summary of Site Pollutant Constituents

Constituent (Pollutant)	Location	Depth	Concentration
None	N/A	N/A	N/A

Proposed Construction Activities (1.2)

Description of site development (example: subdivision):

This project proposes the construction of three (3) portable classroom buildings, open-graded gravel pad, and the construction of permeable asphalt walkway to the new portables. New portables will be constructed in the existing grass lawn area. The existing parking lot and portables shall be protected and maintained during construction. The site also includes the installation of stormwater infiltration gallery to manage roof runoff.

Description of construction activities (example: site preparation, demolition, excavation):

Construction activities include:

Clearing and grubbing, sawcutting, excavation and trenching, utility installation, asphalt paving, and installation of gravel pad and portables.

Description of site drainage including flow from and onto adjacent properties. Must be consistent with Site Map in Appendix A:

This project proposes to infiltrate 100% of stormwater runoff from the site. Runoff from walkway and gravel pad will infiltrate into native soils below. Roof runoff will be collected and infiltrated into downspout infiltration gallery. Overflow from the gallery will overland flow to the southwest portion of the site and be collected via the City's stormwater system along W Main. Stormwater will eventually discharge to the Puyallup River.

Description of final stabilization (example: extent of revegetation, paving, landscaping):

Final stabilization of the site includes the following:

On-site paving, revegetation, and landscaping.

Contaminated Site Information:

Proposed activities regarding contaminated soils or groundwater (example: on-site treatment system, authorized sanitary sewer discharge):

Construction activities are not anticipated to disturb contaminated soils or groundwater on-site, as none are known to exist in the vicinity of the project.

Construction Stormwater Best Management Practices (BMPs) (2.0)

The SWPPP is a living document reflecting current conditions and changes throughout the life of the project. These changes may be informal (i.e. hand-written notes and deletions). Update the SWPPP when the CESCL has noted a deficiency in BMPs or deviation from original design.

The 12 Elements (2.1)

Element 1: Preserve Vegetation / Mark Clearing Limits (2.1.1)

List and describe BMPs: BMP C101 – Preserve Natural Vegetation
 BMP C102 – Buffer Zones
 BMP C103 – High Visibility Plastic or Metal Fence

Lath & Flagging:

Prior to beginning land disturbing activities, including clearing and grading, all clearing limits and trees that are to be preserved within the construction area shall be clearly marked, both in the field and on the plans, to prevent damage and off-site impacts. Barrier fences shall be constructed as shown on the Temporary Erosion & Sediment Control Plans and in accordance with BMP C103.

Installation Schedules: See BMP Details in Appendix B.

Inspection and Maintenance plan: See BMP Details in Appendix B.

Responsible Staff: Contractor shall be responsible for maintaining TESC BMPs.

Element 2: Establish Construction Access (2.1.2)

List and describe BMPs: BMP C105 – Stabilized Construction Access

Adjacent roads and paved areas shall be cleaned thoroughly as needed. Sediment shall be removed from roads by shoveling or pickup sweeping and shall be transported to a controlled sediment disposal area.

Installation Schedules: See BMP Details in Appendix B.

Inspection and Maintenance plan: See BMP Details in Appendix B.

Responsible Staff: Contractor shall be responsible for maintaining TESC BMPs.

Element 3: Control Flow Rates (2.1.3)

Will you construct stormwater retention and/or detention facilities?

Yes

No

Will you use permanent infiltration ponds or other low impact development (example: rain gardens, bio-retention, porous pavement) to control flow during construction?

Yes

No

List and describe BMPs: Properties downstream from the development site shall be protected from erosion due to any increases in the volume, velocity, and peak flow rate stormwater runoff from the project site. If off-site discharges do occur, temporary basins shall be installed prior to the points of discharge.

Installation Schedules:

Inspection and Maintenance plan:

Responsible Staff:

Element 4: Install Sediment Controls (2.1.4)

List and describe BMPs: BMP C230 – Straw Bale Barrier: Straw bale barriers shall be installed as necessary to prevent sediment in construction stormwater from entering existing storm systems.

 BMP C233 – Silt Fence: A silt fence will be installed along the southern, western, and northern edges of the construction site along existing vegetation to prevent stormwater runoff from leaving the site.

 BMP C235 – Straw Wattles: Straw wattle barriers shall be installed as necessary to prevent sediment in construction stormwater from entering existing storm systems.

Installation Schedules: See BMP Details in Appendix B.

Inspection and Maintenance plan: See BMP Details in Appendix B.

Responsible Staff: Contractor shall be responsible for maintaining TESC BMPs.

Element 5: Stabilize Soils (2.1.5)

West of the Cascade Mountains Crest

Season	Dates	Number of Days Soils Can be Left Exposed
During the Dry Season	May 1 – September 30	7 days
During the Wet Season	October 1 – April 30	2 days

Anticipated project dates: Start date: October 2024 End date: February 2025

Will you construct during the wet season?

Yes No

List and describe BMPs: BMP C122 – Nets & Blankets: Nets and Blankets shall be installed to stabilize exposed soils/piles/slopes on site.
BMP C123 – Plastic Covering: Plastic Covering shall be installed to stabilize exposed soils/piles/slopes on site.
BMP C140 – Dust Control

All exposed and unworked soils shall be stabilized by application of effective BMPs, which protect the soil from the erosive forces of raindrop impact, flowing water, and wind erosion. From October 1 through April 30, no soils shall remain exposed and unworked for more than 2 days. From May 1 to September 30, no soils shall remain exposed and unworked for more than 7 days. This condition applies to all soils on site, whether at final grade or not. Additionally, except where approved chemical treatment, full dispersion, or infiltration is practiced, clearing, grading, and other soil disturbing activities are prohibited between November 1 and February 28.

In areas where the soils will remain unworked for more than 30 days or have reached final grade, the areas shall be graveled to stabilize exposed soils. If the slope is 2H:1V or greater with at least 10 feet of vertical relief, nets or blankets shall be used according to BMP C122. Sod shall be used in accordance with BMP C124 for disturbed areas that require immediate vegetative cover. Dust control shall be used as needed to prevent wind transport of dust from disturbed soil surfaces and in accordance with BMP C140.

Installation Schedules: See BMP Details in Appendix B.

Inspection and Maintenance plan: See BMP Details in Appendix B.

Responsible Staff: Contractor shall be responsible for maintaining TESC BMPs.

Element 6: Protect Slopes (2.1.6)

Will steep slopes be present at the site during construction?

Yes

No

List and describe BMPs: There are no steep slopes on-site; therefore, this element is not applicable.

Installation Schedules:

Inspection and Maintenance plan:

Responsible Staff:

Element 7: Protect Drain Inlets (2.1.7)

List and describe BMPs: BMP C220 – Storm Drain Inlet Protection: Storm drain inlet protection will be installed in all storm drain inlets made operable during construction, as well as the existing catch basins within the project vicinity.

All storm drain inlets made operable during construction—as well as existing structures downstream of the project—shall be protected so that stormwater runoff shall not enter the conveyance system without first being filtered or treated to remove sediment.

Inlets should be inspected weekly at a minimum and daily during storm events. Inlet protection devices should be cleaned or removed and replaced before six inches of sediment have accumulated.

Installation Schedules: See BMP Details in Appendix B.

Inspection and Maintenance plan: See BMP Details in Appendix B.

Responsible Staff: Contractor shall be responsible for maintaining TESC BMPs.

Element 8: Stabilize Channels and Outlets (2.1.8)

Provide stabilization, including armoring material, adequate to prevent erosion of outlets, adjacent stream banks, slopes, and downstream reaches, will be installed at the outlets of all conveyance systems.

List and describe BMPs: Stabilizing channel and outlets is not applicable as the project will continue to discharge stormwater to the existing stormwater conveyance system on-site.

Installation Schedules:

Inspection and Maintenance plan:

Responsible Staff:

Element 9: Control Pollutants (2.1.9)

The following pollutants are anticipated to be present on-site:

Table 2 – Pollutants

Pollutant (and source, if applicable)
N/A

List and describe BMPs: BMP C152 - Sawcutting and Surface Pollution Prevention
 BMP C153 – Material Delivery, Storage Containment

All pollutants, including waste materials and demolition debris, that occur on site during construction shall be handled and disposed of in a manner that does not cause contamination of stormwater.

Cover, containment, and protection from vandalism shall be provided for all chemicals, liquid products, petroleum products, and non-inert wastes present on the site (see Chapter 173 304 WAC for the definition of inert waste). On-site fueling tanks shall include secondary containment.

Maintenance and repair of heavy equipment and vehicles involving oil changes, hydraulic system drain down, solvent and de-greasing cleaning operations, fuel tank drain down and removal, and other activities that may result in discharge or spillage of pollutants to the ground or into stormwater runoff must be conducted using spill prevention measures, such as drip pans. Contaminated surfaces shall be cleaned immediately following any discharge or spill incident. Spills should be reported to 911. Emergency repairs may be performed on-site using temporary plastic placed beneath and, if raining, over the vehicle. Application of agricultural chemicals, including fertilizers and pesticides, shall be conducted in a manner and at application rates that will not result in loss of chemical to stormwater runoff. Manufacturers' recommendations shall be followed for application rates and procedures.

Installation Schedules: See BMP Details in Appendix B.

Inspection and Maintenance plan: See BMP Details in Appendix B.

Responsible Staff: Contractor shall be responsible for maintaining TESC BMPs.

Will maintenance, fueling, and/or repair of heavy equipment and vehicles occur on-site?

Yes

No

List and describe BMPs: BMP C152 - Sawcutting and Surface Pollution Prevention
 BMP C153 – Material Delivery, Storage Containment

All pollutants, including waste materials and demolition debris, that occur on site during construction shall be handled and disposed of in a manner that does not cause contamination of stormwater.

Cover, containment, and protection from vandalism shall be provided for all chemicals, liquid products, petroleum products, and non-inert wastes present on the site (see Chapter 173 304 WAC for the definition of inert waste). On-site fueling tanks shall include secondary containment.

Maintenance and repair of heavy equipment and vehicles involving oil changes, hydraulic system drain down, solvent and de-greasing cleaning operations, fuel tank drain down and removal, and other activities that may result in discharge or spillage of pollutants to the ground or into stormwater runoff must be conducted using spill prevention measures, such as drip pans. Contaminated surfaces shall be cleaned immediately following any discharge or spill incident. Spills should be reported to 911. Emergency repairs may be performed on-site using temporary plastic placed beneath and, if raining, over the vehicle. Application of agricultural chemicals, including fertilizers and pesticides, shall be conducted in a manner and at application rates that will not result in loss of chemical to stormwater runoff. Manufacturers' recommendations shall be followed for application rates and procedures.

Installation Schedules: See BMP Details in Appendix B.

Inspection and Maintenance plan: See BMP Details in Appendix B.

Responsible Staff: Contractor shall be responsible for maintaining TESC BMPs.

Will wheel wash or tire bath system BMPs be used during construction?

Yes

No

List and describe BMPs: BMP C106 – Wheel Wash: A wheel wash will be used, so the vehicles do not discharge pollutants off the site.

Installation Schedules: See BMP Details in Appendix B.

Inspection and Maintenance plan: See BMP Details in Appendix B.

Responsible Staff: Contractor shall be responsible for maintaining TESC BMPs.

Will pH-modifying sources be present on-site?

Yes	No	If yes, check the source(s).
-----	----	------------------------------

Table 3 – pH-Modifying Sources

	None
	Bulk cement
	Cement kiln dust
	Fly ash
	Other cementitious materials
X	New concrete washing or curing waters
X	Waste streams generated from concrete grinding and sawing
	Exposed aggregate processes
	Dewatering concrete vaults
X	Concrete pumping and mixer washout waters
	Recycled concrete
	Other (i.e. calcium lignosulfate) [please describe]

List and describe BMPs: BMP C152 - Sawcutting and Surface Pollution Prevention
 BMP C153 – Material Delivery, Storage Containment

All pollutants, including waste materials and demolition debris, that occur on site during construction shall be handled and disposed of in a manner that does not cause contamination of stormwater.

Cover, containment, and protection from vandalism shall be provided for all chemicals, liquid products, petroleum products, and non-inert wastes present on the site (see Chapter 173 304 WAC for the definition of inert waste). On-site fueling tanks shall include secondary containment.

Maintenance and repair of heavy equipment and vehicles involving oil changes, hydraulic system drain down, solvent and de-greasing cleaning operations, fuel tank drain down and removal, and other activities that may result in discharge or spillage of pollutants to the ground or into stormwater runoff must be conducted using spill prevention measures, such as drip pans. Contaminated surfaces shall be cleaned immediately following any discharge or spill incident. Spills should be reported to 911. Emergency repairs may be performed on-site using temporary plastic placed beneath and, if raining, over the vehicle. Application of agricultural chemicals, including fertilizers and pesticides, shall be conducted in a manner and at application rates that will not result in loss of chemical to stormwater runoff. Manufacturers' recommendations shall be followed for application rates and procedures.

Installation Schedules: See BMP Details in Appendix B.

Inspection and Maintenance plan: See BMP Details in Appendix B.

Responsible Staff: Contractor shall be responsible for maintaining TESC BMPs.

Concrete trucks must not be washed out onto the ground, or into storm drains, open ditches, streets, or streams. Excess concrete must not be dumped on-site, except in designated concrete washout areas with appropriate BMPs installed.

Element 10: Control Dewatering (2.1.10)

Table 4 – Dewatering BMPs

	Infiltration
	Transport off-site in a vehicle (vacuum truck for legal disposal)
X	Ecology-approved on-site chemical treatment or other suitable treatment technologies
	Sanitary or combined sewer discharge with local sewer district approval (last resort)
	Use of sedimentation bag with discharge to ditch or swale (small volumes of localized dewatering)

List and describe BMPs:

Installation Schedules:

Inspection and Maintenance plan:

Responsible Staff:

Element 11: Maintain BMPs (2.1.11)

All temporary and permanent Erosion and Sediment Control (ESC) BMPs shall be maintained and repaired as needed to ensure continued performance of their intended function.

Maintenance and repair shall be conducted in accordance with each particular BMP specification (see *Volume II of the SWMMWW* or *Chapter 7 of the SWMMEW*).

Visual monitoring of all BMPs installed at the site will be conducted at least once every calendar week and within 24 hours of any stormwater or non-stormwater discharge from the site. If the site becomes inactive and is temporarily stabilized, the inspection frequency may be reduced to once every calendar month.

All temporary ESC BMPs shall be removed within 30 days after final site stabilization is achieved or after the temporary BMPs are no longer needed.

Trapped sediment shall be stabilized on-site or removed. Disturbed soil resulting from removal of either BMPs or vegetation shall be permanently stabilized.

Additionally, protection must be provided for all BMPs installed for the permanent control of stormwater from sediment and compaction. BMPs that are to remain in place following completion of construction shall be examined and restored to full operating condition. If sediment enters these BMPs during construction, the sediment shall be removed and the facility shall be returned to conditions specified in the construction documents.

Element 12: Manage the Project (2.1.12)

Clearing and grading activities for developments shall be permitted only if conducted pursuant to an approved site development plan (e.g., subdivision approval) that establishes permitted areas of clearing, grading, cutting, and filling. These permitted clearing and grading areas and any other areas required to preserve critical or sensitive areas, buffers, native growth protection easements, or tree retention areas as may be required by local jurisdictions, shall be delineated on the site plans and the development site.

Turbidity: For storms up to the water quality design event, turbidity downstream of a construction site may not increase more than 5 NTU, if upstream turbidity is 50 NTU or less, and may not increase more than 10 percent, if upstream turbidity is over 50 NTU. To the extent practicable, samples should be taken far enough downstream so that the construction site discharge has been well-mixed with the surface water. Whenever inspection and/or monitoring reveals that the BMPs identified in the Construction SWPPP are inadequate, due to the actual discharge of or potential to discharge a significant amount of any pollutant, appropriate BMPs or design changes shall be implemented as soon as possible.

pH: shall be within the range of 6.5 to 8.5 (freshwater) or 7.0 to 8.5 (marine water) with a human-caused variation within a range of less than 0.2 units. For Class A and lower water classifications, the permissible induced increase is 0.5 units (Stormwater Management Manual for Western Washington, Department of Ecology, February 2005 Edition).

A Certified Erosion and Sediment Control Specialist be identified by the contractor at a later date. This information will be added to this CSWPPP.

Table 5 – Management

X	Design the project to fit the existing topography, soils, and drainage patterns
X	Emphasize erosion control rather than sediment control
X	Minimize the extent and duration of the area exposed
X	Keep runoff velocities low
X	Retain sediment on-site
X	Thoroughly monitor site and maintain all ESC measures
X	Schedule major earthwork during the dry season
	Other (please describe)

Table 6 – BMP Implementation Schedule

Phase of Construction Project	Stormwater BMPs	Date	Wet/Dry Season
[Insert construction activity]	[Insert BMP]	[MM/DD/YYYY]	[Insert Season]
Phase of Construction Project	Stormwater BMPs	Date	Wet/Dry Season

Element 13: Protect Low Impact Development (LID) BMPs (2.1.13)

Protect all permeable pavement BMPs from sedimentation through installation and maintenance of erosion

and sediment control BMPs on portions of the site that drain into the permeable pavement BMPs. Restore the BMPs to their fully functioning condition if they accumulate sediment during construction. Restoring the BMP must include removal of sediment and any sediment-laden permeable pavement soils, and replacing the removed soils with soils meeting the design specification.

Prevent compacting of soils in areas of new permeable pavement BMPs by excluding construction equipment and foot traffic. Protect completed lawn and landscaped areas from compaction due to construction equipment.

Control erosion and avoid introducing sediment from surrounding land uses onto permeable pavements. Do not allow muddy construction equipment on the base material or pavement. Do not allow sediment-laden runoff onto permeable pavements or base materials.

Pavement fouled with sediments or no longer passing an initial infiltration test must be cleaned using procedures in accordance with this manual or the manufacturer's procedures.

Keep all heavy equipment off existing soils under LID facilities that have been excavated to final grade to retain the infiltration rate of the soils.

Pollution Prevention Team (3.0)

Table 7 – Team Information

Title	Name(s)	Phone Number
Certified Erosion and Sediment Control Lead (CESCL)		
Resident Engineer		
Emergency Ecology Contact		
Emergency Permittee/ Owner Contact		
Non-Emergency Owner Contact		
Monitoring Personnel		
Ecology Regional Office	[Insert Regional Office]	[Insert General Number]

Monitoring and Sampling Requirements (4.0)

Monitoring includes visual inspection, sampling for water quality parameters of concern, and documentation of the inspection and sampling findings in a site log book. A site log book will be maintained for all on-site construction activities and will include:

- A record of the implementation of the SWPPP and other permit requirements
- Site inspections
- Stormwater sampling data

File a blank form under Appendix D.

The site log book must be maintained on-site within reasonable access to the site and be made available upon request to Ecology or the local jurisdiction.

Numeric effluent limits may be required for certain discharges to 303(d) listed waterbodies. See CSWGP Special Condition S8 and Section 5 of this template.

Complete the following paragraph for sites that discharge to impaired waterbodies for fine sediment, turbidity, phosphorus, or pH:

The receiving waterbody, Puyallup River, is impaired for: fine sediment and pH. All stormwater and dewatering discharges from the site are subject to an **effluent limit** of 8.5 su for pH and/or 25 NTU for turbidity.

Site Inspection (4.1)

Site inspections will be conducted at least once every calendar week and within 24 hours following any discharge from the site. For sites that are temporarily stabilized and inactive, the required frequency is reduced to once per calendar month.

The discharge point(s) are indicated on the Site Map (see Appendix A) and in accordance with the applicable requirements of the CSWGP.

Stormwater Quality Sampling (4.2)

Turbidity Sampling (4.2.1)

Requirements include calibrated turbidity meter or transparency tube to sample site discharges for compliance with the CSWGP. Sampling will be conducted at all discharge points at least once per calendar week.

Method for sampling turbidity:

Table 8 – Turbidity Sampling Method

	Turbidity Meter/Turbidimeter (required for disturbances 5 acres or greater in size)
X	Transparency Tube (option for disturbances less than 1 acre and up to 5 acres in size)

The benchmark for turbidity value is 25 nephelometric turbidity units (NTU) and a transparency less than 33 centimeters.

If the discharge's turbidity is 26 to 249 NTU or the transparency is less than 33 cm but equal to or greater than 6 cm, the following steps will be conducted:

1. Review the SWPPP for compliance with Special Condition S9. Make appropriate revisions within 7 days of the date the discharge exceeded the benchmark.
2. Immediately begin the process to fully implement and maintain appropriate source control and/or treatment BMPs as soon as possible. Address the problems within 10 days of the date the discharge exceeded the benchmark. If installation of necessary treatment BMPs is not feasible within 10 days, Ecology may approve additional time when the Permittee requests an extension within the initial 10-day response period.
3. Document BMP implementation and maintenance in the site log book.

If the turbidity exceeds 250 NTU or the transparency is 6 cm or less at any time, the following steps will be conducted:

1. Telephone or submit an electronic report to the applicable Ecology Region's Environmental Report Tracking System (ERTS) within 24 hours.
<https://www.ecology.wa.gov/About-us/Get-involved/Report-an-environmental-issue>
 - Central Region (Benton, Chelan, Douglas, Kittitas, Klickitat, Okanogan, Yakima): (509) 575-2490
 - Eastern Region (Adams, Asotin, Columbia, Ferry, Franklin, Garfield, Grant, Lincoln, Pend Oreille, Spokane, Stevens, Walla Walla, Whitman): (509) 329-3400
 - Northwest Region (King, Kitsap, Island, San Juan, Skagit, Snohomish, Whatcom): (425) 649-7000
 - Southwest Region (Clallam, Clark, Cowlitz, Grays Harbor, Jefferson, Lewis, Mason, Pacific, Pierce, Skamania, Thurston, Wahkiakum,): (360) 407-6300
2. Immediately begin the process to fully implement and maintain appropriate source control and/or treatment BMPs as soon as possible. Address the problems within 10 days of the date the discharge exceeded the benchmark. If installation of necessary treatment BMPs is not feasible within 10 days, Ecology may approve additional time when the Permittee requests an extension within the initial 10-day response period
3. Document BMP implementation and maintenance in the site log book.
4. Continue to sample discharges daily until one of the following is true:
 - Turbidity is 25 NTU (or lower).
 - Transparency is 33 cm (or greater).
 - Compliance with the water quality limit for turbidity is achieved.
 - 1 - 5 NTU over background turbidity, if background is less than 50 NTU
 - 1% - 10% over background turbidity, if background is 50 NTU or greater
 - The discharge stops or is eliminated.

pH Sampling (4.2.2)

pH monitoring is required for “Significant concrete work” (i.e. greater than 1000 cubic yards poured concrete or recycled concrete over the life of the project). The use of engineered soils (soil amendments including but not limited to Portland cement-treated base [CTB], cement kiln dust [CKD] or fly ash) also requires pH monitoring.

For significant concrete work, pH sampling will start the first day concrete is poured and continue until it is cured, typically three (3) weeks after the last pour.

For engineered soils and recycled concrete, pH sampling begins when engineered soils or recycled concrete are first exposed to precipitation and continues until the area is fully stabilized.

If the measured pH is 8.5 or greater, the following measures will be taken:

1. Prevent high pH water from entering storm sewer systems or surface water.
2. Adjust or neutralize the high pH water to the range of 6.5 to 8.5 su using appropriate technology such as carbon dioxide (CO₂) sparging (liquid or dry ice).
3. Written approval will be obtained from Ecology prior to the use of chemical treatment other than CO₂ sparging or dry ice.

Method for sampling pH:

Table 8 – pH Sampling Method

	pH meter
	pH test kit
	Wide range pH indicator paper

Discharges to 303(d) or Total Maximum Daily Load (TMDL) Waterbodies (5.0)

303(d) Listed Waterbodies (5.1)

Is the receiving water 303(d) (Category 5) listed for turbidity, fine sediment, phosphorus, or pH?

Yes No

List the impairment(s):

N/A since Puyallup River is not a Category 5 receiving water 303(d).

The receiving waterbody, Puyallup River, is impaired for: fine sediment and pH. All stormwater and dewatering discharges from the site are subject to an **effluent limit** of 8.5 su for pH and/or 25 NTU for turbidity.

List and describe BMPs:

[Insert text here]

TMDL Waterbodies (5.2)

Waste Load Allocation for CWSGP discharges:

[Insert text here]

List and describe BMPs:

[Insert text here]

Discharges to TMDL receiving waterbodies will meet in-stream water quality criteria at the point of discharge.
--

The Construction Stormwater General Permit Proposed New Discharge to an Impaired Water Body form is included in Appendix F.

Reporting and Record Keeping (6.0)

Record Keeping (6.1)

Site Log Book (6.1.1)

A site log book will be maintained for all on-site construction activities and will include:

- A record of the implementation of the SWPPP and other permit requirements
- Site inspections
- Sample logs

Records Retention (6.1.2)

Records will be retained during the life of the project and for a minimum of three (3) years following the termination of permit coverage in accordance with Special Condition S5.C of the CSWGP.

Permit documentation to be retained on-site:

- CSWGP
- Permit Coverage Letter
- SWPPP
- Site Log Book

Permit documentation will be provided within 14 days of receipt of a written request from Ecology. A copy of the SWPPP or access to the SWPPP will be provided to the public when requested in writing in accordance with Special Condition S5.G.2.b of the CSWGP.

Updating the SWPPP (6.1.3)

The SWPPP will be modified if:

- Found ineffective in eliminating or significantly minimizing pollutants in stormwater discharges from the site.
- There is a change in design, construction, operation, or maintenance at the construction site that has, or could have, a significant effect on the discharge of pollutants to waters of the State.

The SWPPP will be modified within seven (7) days if inspection(s) or investigation(s) determine additional or modified BMPs are necessary for compliance. An updated timeline for BMP implementation will be prepared.

Reporting (6.2)

Discharge Monitoring Reports (6.2.1)

Cumulative soil disturbance is less than one (1) acre; therefore, Discharge Monitoring Reports (DMRs) will not be submitted to Ecology because water quality sampling is not being conducted at the site.

Cumulative soil disturbance is one (1) acre or larger; therefore, Discharge Monitoring Reports (DMRs) will be submitted to Ecology monthly. If there was no discharge during a given monitoring period the DMR will be submitted as required, reporting “No Discharge”. The DMR due date is fifteen (15) days following the end of each calendar month.

DMRs will be reported online through Ecology’s WQWebDMR System.

<https://www.ecology.wa.gov/Regulations-Permits/Guidance-technical-assistance/Water-quality-permits-guidance/WQWebPortal-guidance>

Notification of Noncompliance (6.2.2)

If any of the terms and conditions of the permit is not met, and the resulting noncompliance may cause a threat to human health or the environment, the following actions will be taken:

1. Ecology will be notified within 24-hours of the failure to comply by calling the applicable Regional office ERTS phone number (Regional office numbers listed below).
2. Immediate action will be taken to prevent the discharge/pollution or otherwise stop or correct the noncompliance. If applicable, sampling and analysis of any noncompliance will be repeated immediately and the results submitted to Ecology within five (5) days of becoming aware of the violation.
3. A detailed written report describing the noncompliance will be submitted to Ecology within five (5) days, unless requested earlier by Ecology.

Anytime turbidity sampling indicates turbidity is 250 NTUs or greater, or water transparency is 6 cm or less, the Ecology Regional office will be notified by phone within 24 hours of analysis as required by Special Condition S5.A of the CSWGP.

- Central Region at (509) 575-2490 for Benton, Chelan, Douglas, Kittitas, Klickitat, Okanogan, or Yakima County

- Eastern Region at (509) 329-3400 for Adams, Asotin, Columbia, Ferry, Franklin, Garfield, Grant, Lincoln, Pend Oreille, Spokane, Stevens, Walla Walla, or Whitman County
- Northwest Region at (425) 649-7000 for Island, King, Kitsap, San Juan, Skagit, Snohomish, or Whatcom County
- Southwest Region at (360) 407-6300 for Clallam, Clark, Cowlitz, Grays Harbor, Jefferson, Lewis, Mason, Pacific, Pierce, Skamania, Thurston, or Wahkiakum

Include the following information:

1. Your name and / Phone number
2. Permit number
3. City / County of project
4. Sample results
5. Date / Time of call
6. Date / Time of sample
7. Project name

In accordance with Special Condition S4.D.5.b of the CSWGP, the Ecology Regional office will be notified if chemical treatment other than CO₂ sparging is planned for adjustment of high pH water.

Appendix/Glossary

A. Site Map

B. BMP Detail

Appendix A: Site Map

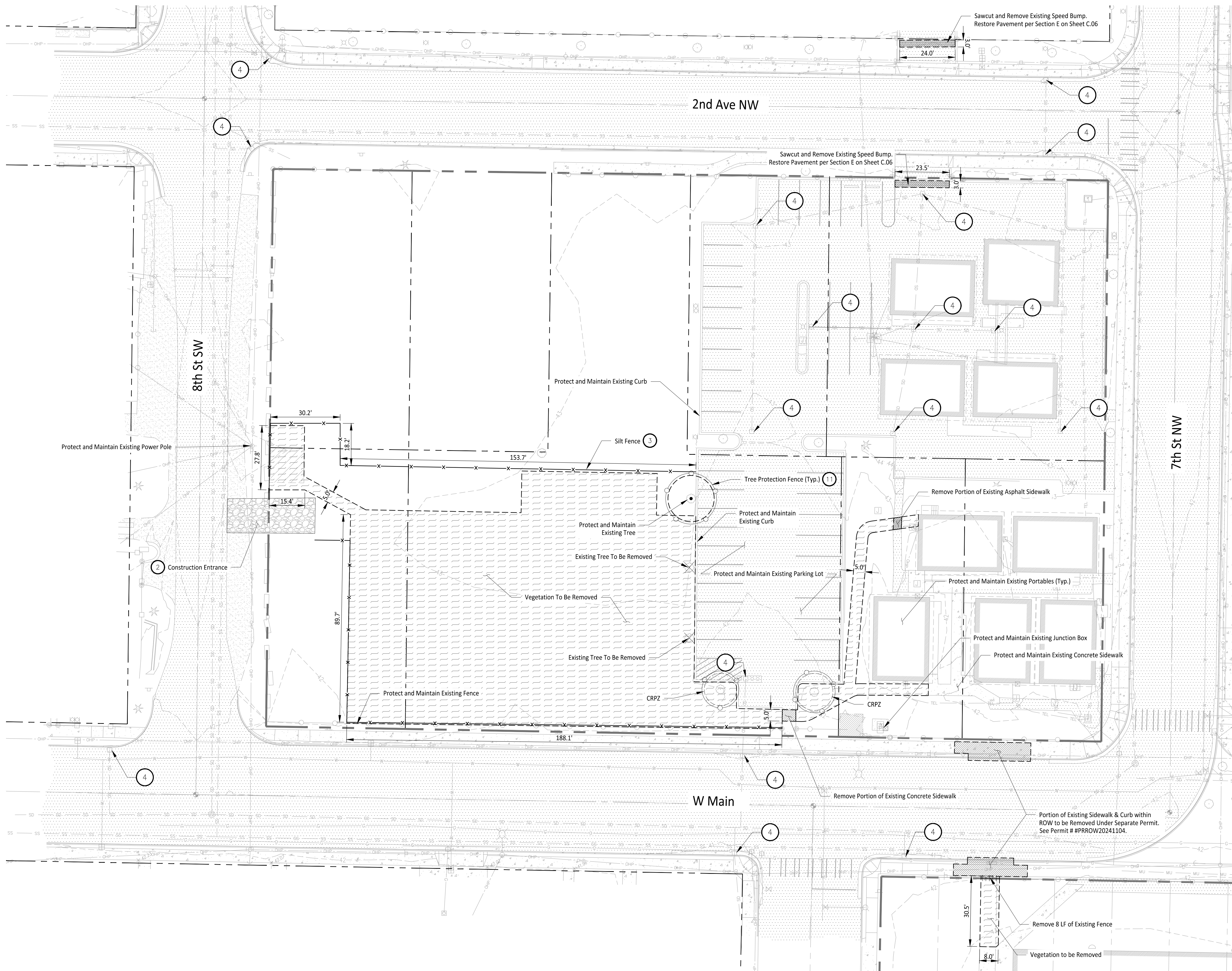

LEGEND

	Construction Entrance
	Vegetation To Be Removed
	Concrete To Be Removed
	Asphalt To Be Removed
	Existing Asphalt Pavement
	Existing Gravel Pavement
	Existing Concrete Pavement
	Property Line
	Parcel Line
	Silt Fence
	Existing Fence to be Removed
	Existing Overhead Power Line
	Existing Sewer Line
	Existing Storm Line
	Existing Water Line
	Existing Gas Line
	Existing Building Line
	Existing Chainlink Fence Line
	Tree Protection Fence Line
	Existing Tree
	Existing Type II Storm Manhole
	Existing Type I Storm Catch Basin
	Existing Sewer Manhole
	Existing Light Pole
	Existing Power Pole

TESC NOTES

- Contractor to install TESC measures as necessary to ensure stormwater leaving the site is free of settleable solids.
- Install and maintain construction entrance per City of Puyallup Standard Detail 05.01.01 and install wheel wash as needed per Washington DOE BMP C106.
- Install silt fence per City of Puyallup Standard Detail 02.03.02. Silt Fence to mark clearing limits in the field.
- Maintain and install storm drain inlet protection in all existing catch basins within the project vicinity per WSDOT Standard Plan 1-40.20-00 and storm drain barriers per City of Puyallup Standard Details 02.03.05 and 02.03.06. Catch Basins within drivable areas are only to use the storm drain inlet protection, and not City Standard 02.03.05 and 02.03.06.
- Roads shall be cleared thoroughly as needed to protect stormwater infrastructure and downstream water resources. Sediment shall be removed from roads by shoveling or pickup sweeping and be transported to a controlled sediment disposal area.
- Exposed soils shall be watered as necessary to prevent dust from leaving the site.
- Concrete handling and equipment washing in accordance with DOE BMP C151.
- Disturbed soils to be amended per DOE BMP T5.13
- If necessary, alternative sediment control methods shall be submitted by the contractor for review and approval prior to construction.
- A CESCL shall be present on-site or on-call for the duration of construction operations.
- Install tree protection fence per City of Puyallup Detail on Sheet C-03.

DEMOLITION NOTES

- Vegetation to be Removed: 15,950 SF
- Concrete to be Removed: 50 SF
- Disturbed Area On-site: 16,220 SF

ARCHITECT

studio MENG STRAZZARA

2001 WESTERN AVE. STE# 200, SEATTLE, WA 98121
www.studio.com | P. 206.687.3737

CONSULTANT

JM TEAM

JM Team
905 Main Street, Suite #200
Sumner, WA 98390
(206) 596-2020

CLIENT/OWNER

PUYALLUP SCHOOL DISTRICT
A Tradition of Excellence

TITLE

PUYALLUP HS NEW PORTABLES 2023

STAMP

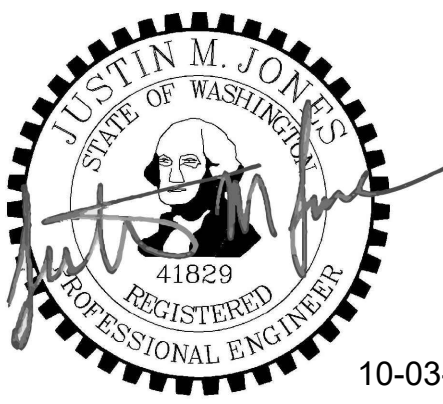

ISSUED:

DATE:

CONDITIONAL USE PERMIT OCT. 11 2023
CUP CC#1 RESPONSE APR. 5 2024
BUILDING PERMIT SET MAY 3 2024
ROW PERMIT SET JULY 10 2024
ROW PERMIT SET REV. 1 AUG 20 2024
ROW PERMIT SET REV. 2 OCT 02 2024
PERMIT CC#1 RESPONSE OCT 03 2024

TESC & DEMOLITION PLAN

APPROVED

BY CITY OF PUYALLUP
DEVELOPMENT ENGINEERING

DATE

NOTE: THIS APPROVAL IS VOID
AFTER 180 DAYS FROM APPROVAL
DATE.
THE CITY WILL NOT BE
RESPONSIBLE FOR ERRORS
AND/OR OMISSIONS ON THESE
PLANS.
FIELD CONDITIONS MAY DICTATE
CHANGES TO THESE PLANS AS
DETERMINED BY THE
DEVELOPMENT ENGINEERING
MANAGER.

CALL TWO BUSINESS DAYS
BEFORE YOU DIG

1-800-424-5555
UTILITIES UNDERGROUND LOCATION CENTER

Building Permit #:

CUP #: PLCUP20230109

Owner's Project #:

Architect's Project #: 2023106

Drawn By MO

Checked By JJ

C.02

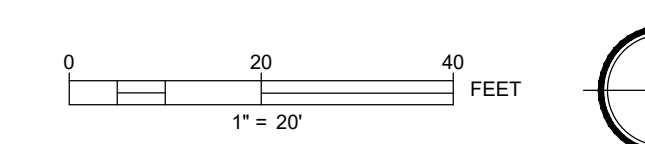



10-03-24

CONDITIONAL USE PERMIT OCT. 11 2023	
CUP CC#1 RESPONSE APR. 5 2024	
BUILDING PERMIT SET MAY 3 2024	
ROW PERMIT SET JULY 10 2024	
ROW PERMIT SET REV. 1 AUG 20 2024	
ROW PERMIT SET REV. 2 OCT 02 2024	
PERMIT CC#1 RESPONSE OCT 03 2024	

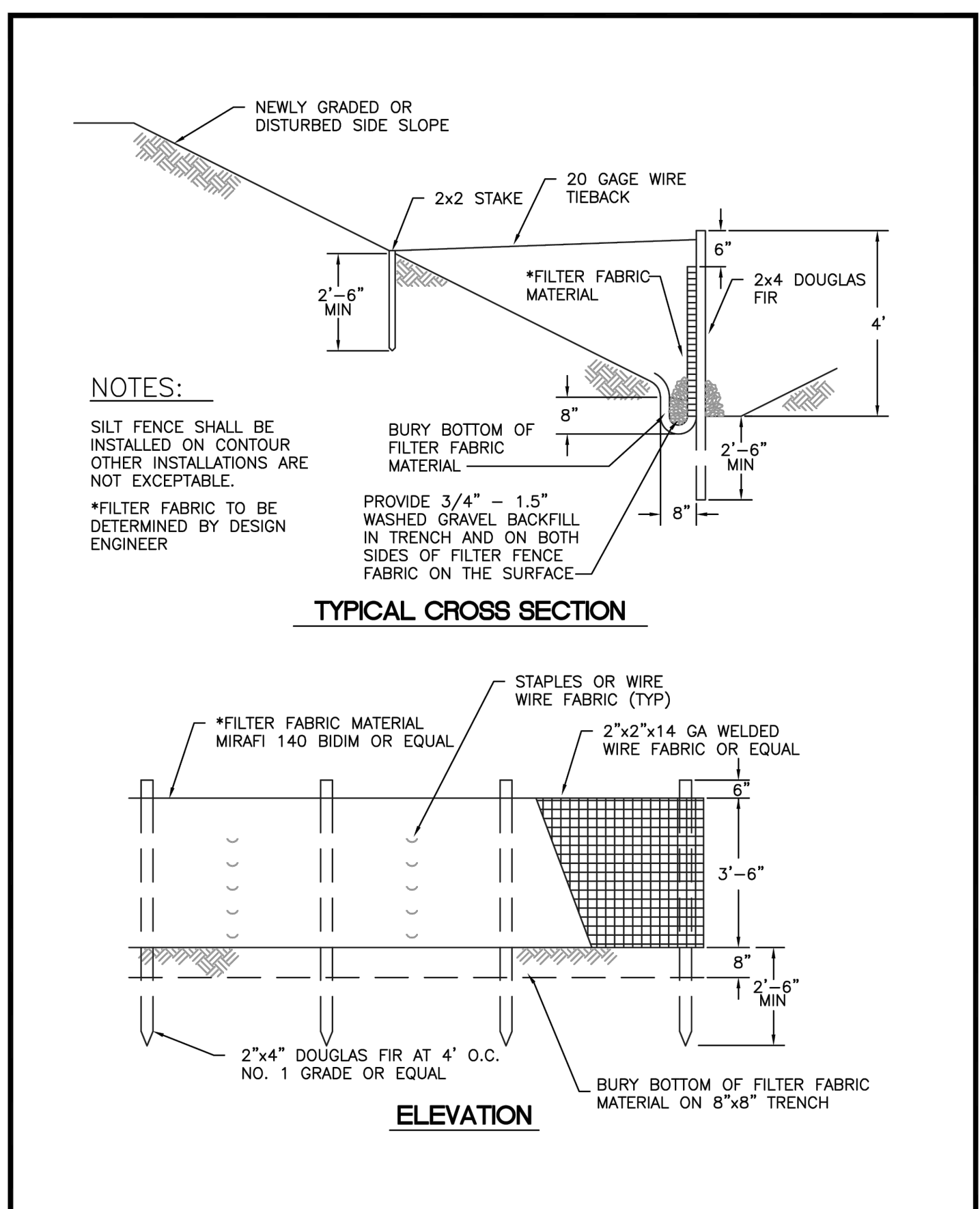

CITY OF PUYALLUP
DEVELOPMENT ENGINEERING and PUBLIC WORKS DEPARTMENTS

SILTATION FENCE

DESIGNED BY	CHECKED BY	APPROVED BY	DATE APPROVED	CITY APPROVAL
FILE NUMBER	DATE APPROVED	DATE APPROVED	SCALE	02.03.02

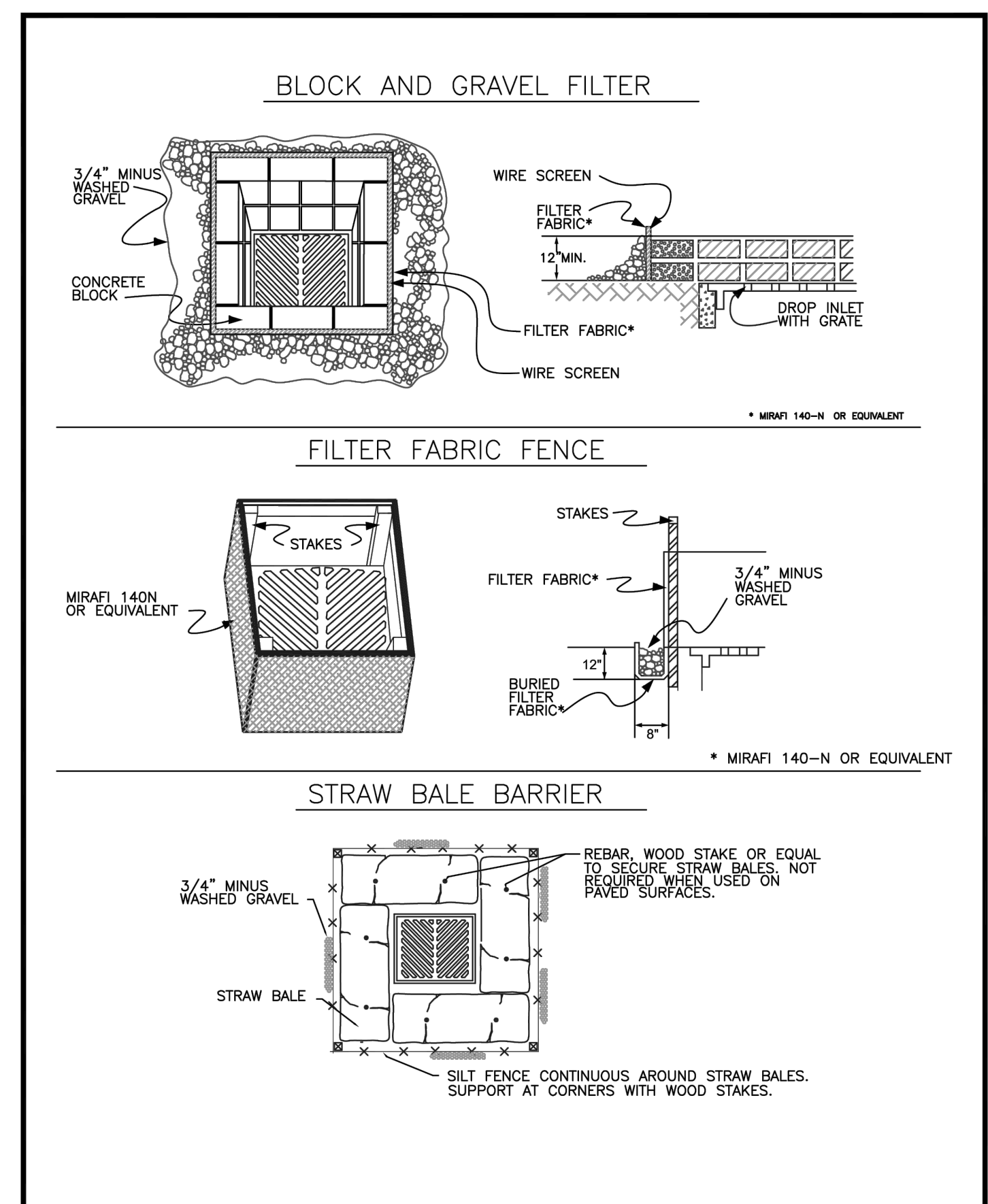

CITY OF PUYALLUP
DEVELOPMENT ENGINEERING and PUBLIC WORKS DEPARTMENTS

STORM DRAIN BARRIERS

DESIGNED BY	CHECKED BY	APPROVED BY	DATE APPROVED	CITY APPROVAL
FILE NUMBER	DATE APPROVED	DATE APPROVED	SCALE	02.03.05

CONDITIONS WHERE PRACTICE APPLIES

- BLOCK AND GRAVEL FILTER - APPLICABLE FOR AREAS GREATER THAN 5% SLOPE.
- FILTER FABRIC FENCE - APPLICABLE WHERE THE INLET DRAINS A RELATIVELY SMALL (ONE ACRE OR LESS) AND FLAT AREA (LESS THAN 5% SLOPE).
- STRAW BALE BARRIER - APPLICABLE WHERE INLET DRAINS A RELATIVELY FLAT DISTURBED AREA (LESS THAN 5% SLOPE) IN WHICH SHEET FLOW (NOT EXCEEDING 0.5 FT/SEC.) OCCURS. BARRIERS OF THIS TYPE SHOULD NOT BE PLACED AROUND INLETS RECEIVING CONCENTRATED FLOWS SUCH AS THOSE ALONG MAJOR STREETS AND HIGHWAYS.

1. BLOCK AND GRAVEL FILTER - INSTALLATION PROCEDURE

- PLACE WIRE MESH OVER THE DROP INLET SO THAT THE WIRE EXTENDS A MINIMUM OF ONE FOOT BEYOND EACH SIDE OF THE INLET STRUCTURE. USE WIRE SCREEN WITH 1/2-INCH OPENINGS. IF MORE THAN ONE STRIP OF MESH IS NECESSARY, OVERLAP THE STRIPS. PLACE FILTER FABRIC* OVER WIRE MESH.
- PLACE CONCRETE BLOCKS LENGTHWISE ON THEIR SIDES IN A SINGLE ROW AROUND THE PERIMETER OF THE INLET. SO THAT THE OPEN ENDS FACE OUTWARD, NOT UPWARD. THE ENDS OF ADJACENT BLOCKS SHOULD ABUT. THE HEIGHT OF THE BARRIER CAN BE VARIED, DEPENDING ON DESIGN NEEDS, BY STACKING COMBINATIONS OF BLOCKS THAT ARE 4-INCH, 8-INCH AND 12-INCH WIDE. THE ROW OF BLOCKS SHOULD BE AT LEAST 12-INCHES BUT NO GREATER THAN 24-INCHES HIGH.
- PLACE WIRE SCREEN OVER THE OVERSIDE VERTICAL FACE (OPEN END) OF THE CONCRETE BLOCKS TO PREVENT STONES FROM BEING WASHED THROUGH THE BLOCKS. USE WIRE SCREEN WITH 1/2-INCH OPENINGS.
- PILE STONES AGAINST THE WIRE MESH TO THE TOP OF THE BLOCKS. USE 3/4" MINUS WASHED GRAVEL.

2. FILTER FABRIC FENCE - INSTALLATION PROCEDURE

- PLACE 2-INCH BY 2-INCH WOODEN STAKES AROUND THE PERIMETER OF THE INLET A MAXIMUM OF 3 FEET APART AND DRIVE THEM AT LEAST 8-INCHES INTO THE GROUND. THE STAKES MUST BE AT LEAST 3 FEET LONG.
- EXCAVATE A TRENCH APPROXIMATELY 8-INCHES WIDE AND 12-INCHES DEEP AROUND THE OUTSIDE PERIMETER OF THE STAKES.
- STAPLE THE FILTER FABRIC* TO THE WOODEN STAKES SO THAT 32-INCHES OF THE FABRIC EXTENDS AND CAN BE FORMED INTO THE TRENCH, AND USE HEAVY-DUTY WIRE STAPLES AT LEAST 1/2-INCHES LONG.
- BACKFILL THE TRENCH WITH 3/4-INCH MINUS WASHED GRAVEL ALL THE WAY AROUND.

3. STRAW BALE BARRIER - INSTALLATION PROCEDURE

- EXCAVATE A 4-INCH DEEP TRENCH AROUND THE INLET. MAKE THE TRENCH AS WIDE AS A STRAW BALE.
- ORIENT STRAW BALES WITH THE BINDINGS AROUND THE SIDES OF THE BALES RATHER THAN OVER AND UNDER THE BALES.
- PLACE BALES LENGTHWISE AROUND THE INLET AND PRESS THE ENDS OF ADJACENT BALES SECURELY IN PLACE.
- DRIVE TWO 2-INCH BY 2-INCH STAKES THROUGH EACH BALE TO ANCHOR THE BALE SECURELY IN PLACE.
- BACKFILL THE EXCAVATED SOIL AND COMPACT IT AGAINST THE BALE.
- WEDGE LOOSE STRAW BETWEEN BALES TO PREVENT WATER FROM FLOWING BETWEEN BALES.

CITY OF PUYALLUP
DEVELOPMENT ENGINEERING and PUBLIC WORKS DEPARTMENTS

STORM DRAIN BARRIERS NOTES

DESIGNED BY	CHECKED BY	APPROVED BY	DATE APPROVED	CITY APPROVAL
FILE NUMBER	DATE APPROVED	DATE APPROVED	SCALE	02.03.06

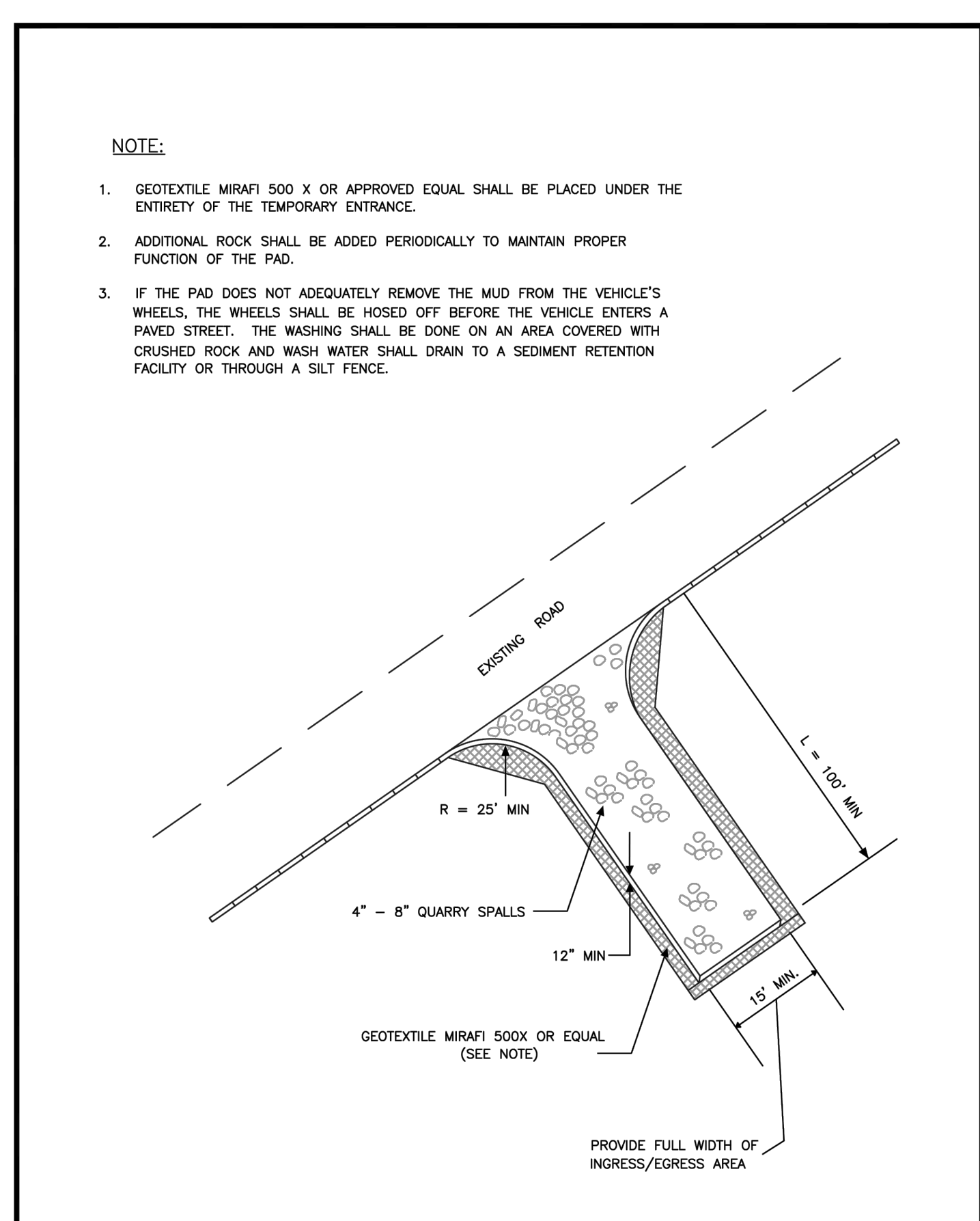
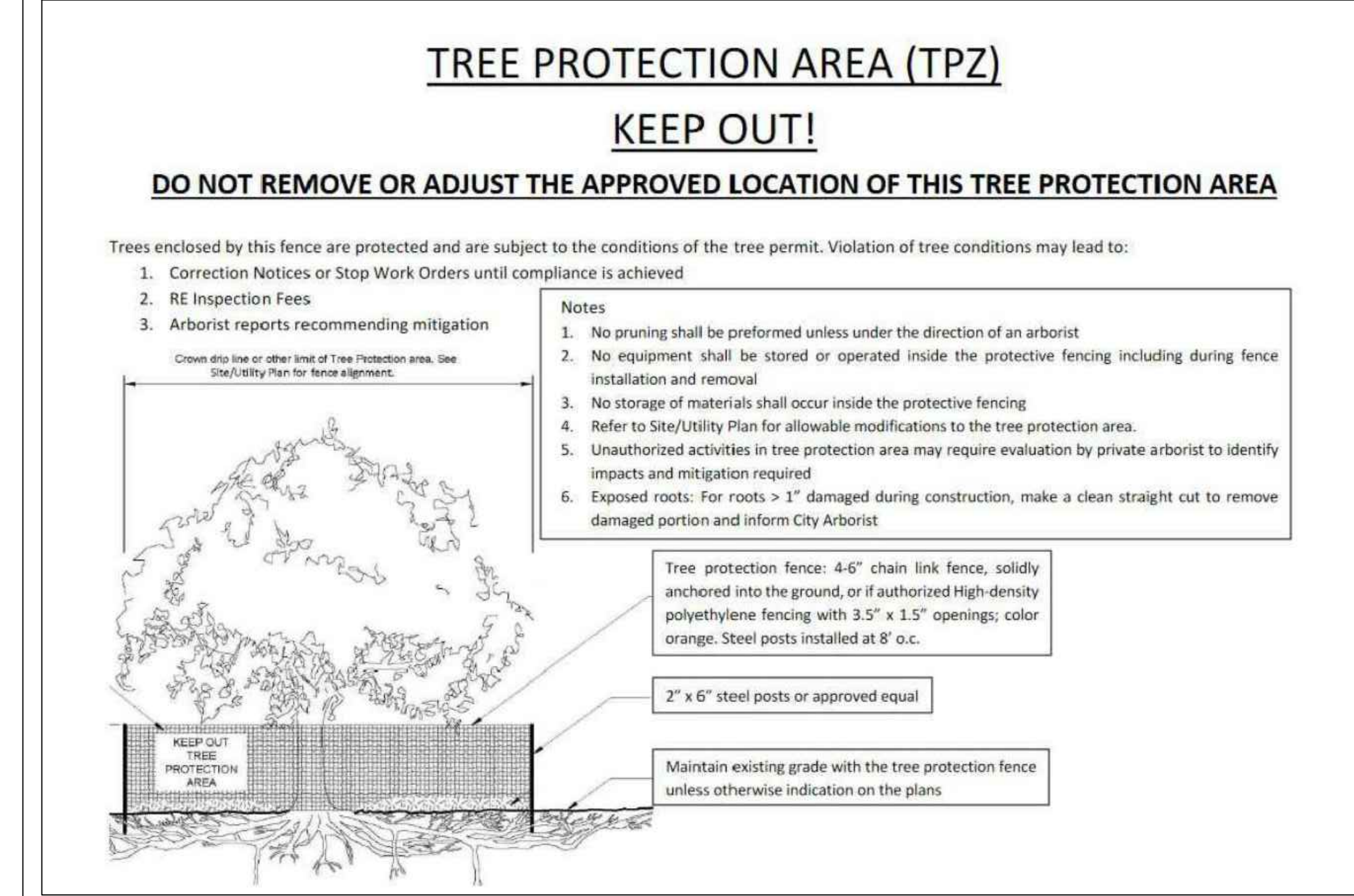

CITY OF PUYALLUP
DEVELOPMENT ENGINEERING and PUBLIC WORKS DEPARTMENTS

TEMPORARY CONSTRUCTION ENTRANCE

DESIGNED BY	CHECKED BY	APPROVED BY	DATE APPROVED	CITY APPROVAL
FILE NUMBER	DATE APPROVED	DATE APPROVED	SCALE	05.01.01

- ALL LIMITS OF CLEARING AND AREAS OF VEGETATION PRESERVATION AS PRESCRIBED ON THE PLANS SHALL BE CLEARLY FLAGGED IN THE FIELD AND OBSERVED DURING CONSTRUCTION.
- ALL REQUIRED SEDIMENTATION AND EROSION CONTROL FACILITIES MUST BE CONSTRUCTED AND IN OPERATION PRIOR TO ANY LAND CLEARING AND/OR OTHER CONSTRUCTION TO ENSURE THAT SEDIMENT LADEN WATER DOES NOT ENTER THE NATURAL DRAINAGE SYSTEM. THE CONTRACTOR SHALL SCHEDULE AN INSPECTION OF THE EROSION CONTROL FACILITIES PRIOR TO ANY LAND CLEARING AND/OR CONSTRUCTION. ALL EROSION AND SEDIMENT FACILITIES SHALL BE MAINTAINED IN A SATISFACTORY CONDITION AS DETERMINED BY THE CITY, UNTIL SUCH TIME THAT CLEARING AND/OR CONSTRUCTION IS COMPLETED AND THE POTENTIAL FOR ON-SITE EROSION HAS PASSED. THE IMPLEMENTATION, MAINTENANCE, REPLACEMENT, AND ADDITIONS TO THE EROSION AND SEDIMENTATION CONTROL SYSTEMS SHALL BE THE RESPONSIBILITY OF THE PERMITEE.
- THE EROSION AND SEDIMENTATION CONTROL SYSTEM FACILITIES DEPICTED ON THESE PLANS ARE INTENDED TO BE MINIMUM REQUIREMENTS TO MEET ANTICIPATED SITE CONDITIONS. AS CONSTRUCTION PROGRESSES AND UNEXPECTED OR SEASONAL CONDITIONS DICTATE, FACILITIES WILL BE NECESSARY TO ENSURE COMPLETE SILTATION CONTROL ON THE SITE. DURING THE COURSE OF CONSTRUCTION, IT SHALL BE THE OBLIGATION AND RESPONSIBILITY OF THE PERMITEE TO ADDRESS ANY NEW CONDITIONS THAT MAY BE CREATED BY HIS ACTIVITIES AND TO PROVIDE ADDITIONAL FACILITIES, OVER AND ABOVE THE MINIMUM REQUIREMENTS, AS MAY BE NEEDED TO PROTECT ADJACENT PROPERTIES, SENSITIVE AREAS, NATURAL WATER COURSES, AND/OR STORM DRAINAGE SYSTEMS.
- APPROVAL OF THESE PLANS IS FOR GRADING, TEMPORARY DRAINAGE, EROSION AND SEDIMENTATION CONTROL ONLY. IT DOES NOT CONSTITUTE AN APPROVAL OF PERMANENT STORM DRAINAGE DESIGN, SIZE OR LOCATION OF PIPES, RESTRICTORS, CHANNELS, OR RETENTION FACILITIES.
- ANY DISTURBED AREA WHICH HAS BEEN STRIPPED OF VEGETATION AND WHERE NO FURTHER WORK IS ANTICIPATED FOR A PERIOD OF 30 DAYS OR MORE, MUST BE IMMEDIATELY STABILIZED WITH MULCHING, GRASS PLANTING, OR OTHER APPROVED EROSION CONTROL TREATMENT APPLICABLE TO THE TIME OF YEAR IN QUESTION. GRASS SEEDING ALONE WILL BE ACCEPTABLE ONLY DURING THE MONTHS OF APRIL THROUGH SEPTEMBER INCLUSIVE. SEEDING MAY PROCEED OUTSIDE THE SPECIFIED TIME PERIOD WHENEVER IT IS IN THE INTEREST OF THE PERMITEE BUT MUST BE AUGMENTED WITH MULCHING, NETTING, OR OTHER TREATMENT APPROVED BY THE CITY.
- IN CASE EROSION OR SEDIMENTATION OCCURS TO ADJACENT PROPERTIES, ALL CONSTRUCTION WORK WITHIN THE DEVELOPMENT THAT WILL FURTHER AGGRAVATE THE SITUATION MUST CEASE, AND THE OWNER/CONTRACTOR WILL IMMEDIATELY COMMENCE RESTORATION METHODS. RESTORATION ACTIVITY WILL CONTINUE UNTIL SUCH TIME AS THE AFFECTED PROPERTY OWNER IS SATISFIED.
- NO TEMPORARY OR PERMANENT STOCKPILING OF MATERIALS OR EQUIPMENT SHALL OCCUR WITHIN CRITICAL AREAS OR ASSOCIATED BUFFERS, OR THE CRITICAL ROOT ZONE FOR VEGETATION PROPOSED FOR RETENTION.

CITY OF PUYALLUP
DEVELOPMENT ENGINEERING and PUBLIC WORKS DEPARTMENTS

GRADING, EROSION, AND SEDIMENTATION CONTROL NOTES

DESIGNED BY	CHECKED BY	APPROVED BY	DATE APPROVED	CITY APPROVAL
FILE NUMBER	DATE APPROVED	DATE APPROVED	SCALE	05.02.01

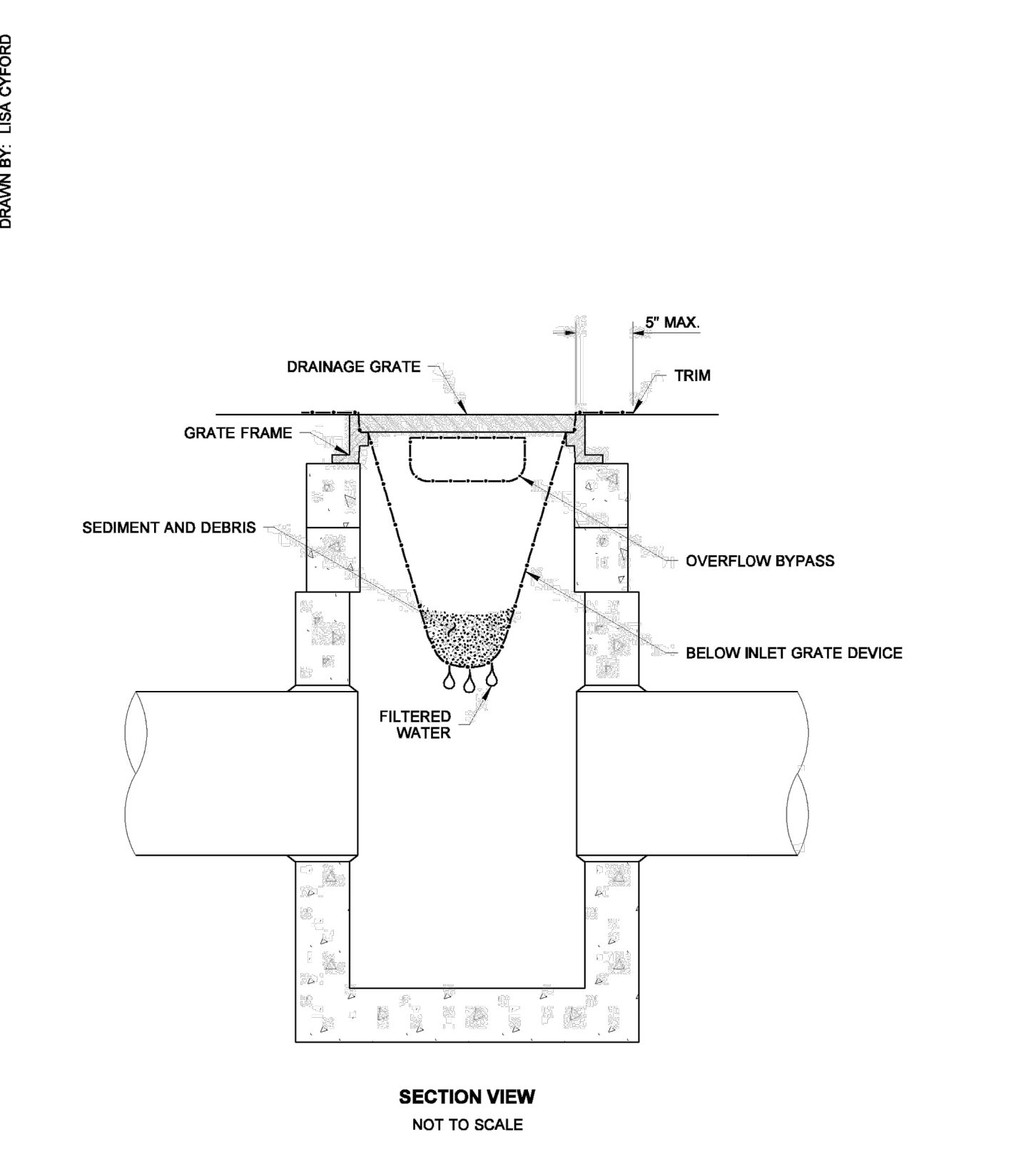

CITY OF PUYALLUP
DEVELOPMENT ENGINEERING and PUBLIC WORKS DEPARTMENTS

STORM DRAIN INLET PROTECTION
STANDARD PLAN I-40.20-00

SHEET 1 OF 1 SHEET

APPROVED FOR PUBLICATION
Pasco Bakoitch III 09-20-07
Washington State Department of Transportation

NOTES

- Size the Below Inlet Grate Device (BIGD) for the storm water structure it will service.
- The BIGD shall have a built-in high-flow relief system (overflow bypass).
- The retrieval system must allow removal of the BIGD without spilling the collected material.
- Perform maintenance in accordance with Standard Specification 8-01.3(15).

STATE OF WASHINGTON
REGISTERED
LANDSCAPE ARCHITECT
MARK W. MAURER
CERTIFICATE NO. 000598

STORM DRAIN INLET PROTECTION
STANDARD PLAN I-40.20-00

SHEET 1 OF 1 SHEET

APPROVED FOR PUBLICATION
Pasco Bakoitch III 09-20-07
Washington State Department of Transportation

APPROVED

BY _____
CITY OF PUYALLUP
DEVELOPMENT ENGINEERING

DATE _____

NOTE: THIS APPROVAL IS VOID AFTER 180 DAYS FROM APPROVAL DATE. THE CITY WILL NOT BE RESPONSIBLE FOR ERRORS AND/OR OMISSIONS ON THESE PLANS. FIELD CONDITIONS MAY DICTATE CHANGES TO THESE PLANS AS DETERMINED BY THE DEVELOPMENT ENGINEERING MANAGER.

Building Permit #: _____
CUP #: **PLCUP20230109**
Owner's Project #: _____
Architect's Project #: **2023106**
Drawn By **MO**
Checked By **JJ**

CALL TWO BUSINESS DAYS BEFORE YOU DIG
1-800-424-5555
UTILITIES UNDERGROUND LOCATION CENTER

C.03

Appendix B: BMP Detail

If tree roots have been exposed or injured, “prune” cleanly with an appropriate pruning saw or loppers directly above the damaged roots and recover with native soils. Treatment of sap flowing trees (fir, hemlock, pine, soft maples) is not advised as sap forms a natural healing barrier.

BMP C102: Buffer Zones

Purpose

Creation of an undisturbed area or strip of natural vegetation or an established suitable planting that will provide a living filter to reduce soil erosion and stormwater runoff velocities.

Conditions of Use

Buffer zones are used along streams, wetlands and other bodies of water that need protection from erosion and sedimentation. Contractors can use vegetative buffer zone BMPs to protect natural swales and they can incorporate them into the natural landscaping of an area.

Do not use critical-areas buffer zones as sediment treatment areas. These areas shall remain completely undisturbed. The local permitting authority may expand the buffer widths temporarily to allow the use of the expanded area for removal of sediment.

The types of buffer zones can change the level of protection required as shown below:

Designated Critical Area Buffers - buffers that protect Critical Areas, as defined by the Washington State Growth Management Act, and are established and managed by the local permitting authority. These should not be disturbed and must be protected with sediment control BMPs to prevent impacts. The local permitting authority may expand the buffer widths temporarily to allow the use of the expanded area for removal of sediment.

Vegetative Buffer Zones - areas that may be identified in undisturbed vegetation areas or managed vegetation areas that are outside any Designated Critical Area Buffer. They may be utilized to provide an additional sediment control area and/or reduce runoff velocities. If being used for preservation of natural vegetation, they should be arranged in clumps or strips. They can be used to protect natural swales and incorporated into the natural landscaping area.

Design and Installation Specifications

- Preserving natural vegetation or plantings in clumps, blocks, or strips is generally the easiest and most successful method.
- Leave all unstable steep slopes in natural vegetation.
- Mark clearing limits and keep all equipment and construction debris out of the natural areas and buffer zones. Steel construction fencing is the most effective method to protect sensitive areas and buffers. Alternatively, wire-backed silt fence on steel posts is marginally effective. Flagging alone is typically not effective.
- Keep all excavations outside the dripline of trees and shrubs.
- Do not push debris or extra soil into the buffer zone area because it will cause damage by

burying and smothering vegetation.

- Vegetative buffer zones for streams, lakes or other waterways shall be established by the local permitting authority or other state or federal permits or approvals.

Maintenance Standards

Inspect the area frequently to make sure flagging remains in place and the area remains undisturbed. Replace all damaged flagging immediately. Remove all materials located in the buffer area that may impede the ability of the vegetation to act as a filter.

BMP C103: High-Visibility Fence

Purpose

High-visibility fencing is intended to:

- Restrict clearing to approved limits.
- Prevent disturbance of sensitive areas, their buffers, and other areas required to be left undisturbed.
- Limit construction traffic to designated construction entrances, exits, or internal roads.
- Protect areas where marking with survey tape may not provide adequate protection.

Conditions of Use

To establish clearing limits plastic, fabric, or metal fence may be used:

- At the boundary of sensitive areas, their buffers, and other areas required to be left uncleared.
- As necessary to control vehicle access to and on the site.

Design and Installation Specifications

High-visibility plastic fence shall be composed of a high-density polyethylene material and shall be at least four feet in height. Posts for the fencing shall be steel or wood and placed every 6 feet on center (maximum) or as needed to ensure rigidity. The fencing shall be fastened to the post every six inches with a polyethylene tie. On long continuous lengths of fencing, a tension wire or rope shall be used as a top stringer to prevent sagging between posts. The fence color shall be high-visibility orange. The fence tensile strength shall be 360 lbs/ft using the ASTM D4595 testing method.

If appropriate install fabric silt fence in accordance with [BMP C233: Silt Fence](#) to act as high-visibility fence. Silt fence shall be at least 3 feet high and must be highly visible to meet the requirements of this BMP.

Metal fences shall be designed and installed according to the manufacturer's specifications.

Metal fences shall be at least 3 feet high and must be highly visible.

Fences shall not be wired or stapled to trees.

Maintenance Standards

If the fence has been damaged or visibility reduced, it shall be repaired or replaced immediately and visibility restored.

BMP C105: Stabilized Construction Access

Purpose

Stabilized construction accesses are established to reduce the amount of sediment transported onto paved roads outside the project site by vehicles or equipment. This is done by constructing a stabilized pad of quarry spalls at entrances and exits for project sites.

Conditions of Use

Construction accesses shall be stabilized wherever traffic will be entering or leaving a construction site if paved roads or other paved areas are within 1,000 feet of the site.

For residential subdivision construction sites, provide a stabilized construction access for each residence, rather than only at the main subdivision entrance. Stabilized surfaces shall be of sufficient length/width to provide vehicle access/parking, based on lot size and configuration.

On large commercial, highway, and road projects, the designer should include enough extra materials in the contract to allow for additional stabilized accesses not shown in the initial Construction SWPPP. It is difficult to determine exactly where access to these projects will take place; additional materials will enable the contractor to install them where needed.

Design and Installation Specifications

See [Figure II-3.1: Stabilized Construction Access](#) for details. Note: the 100' minimum length of the access shall be reduced to the maximum practicable size when the size or configuration of the site does not allow the full length (100').

Construct stabilized construction accesses with a 12-inch thick pad of 4-inch to 8-inch quarry spalls, a 4-inch course of asphalt treated base (ATB), or use existing pavement. Do not use crushed concrete, cement, or calcium chloride for construction access stabilization because these products raise pH levels in stormwater and concrete discharge to waters of the State is prohibited.

A separation geotextile shall be placed under the spalls to prevent fine sediment from pumping up into the rock pad. The geotextile shall meet the standards listed in [Table II-3.2: Stabilized Construction Access Geotextile Standards](#).

**Table II-3.2: Stabilized Construction Access
Geotextile Standards**

Geotextile Property	Required Value
Grab Tensile Strength (ASTM D4751)	200 psi min.

Approved as Functionally Equivalent

Ecology has approved products as able to meet the requirements of this BMP. The products did not pass through the Technology Assessment Protocol – Ecology (TAPE) process. Local jurisdictions may choose not to accept these products, or may require additional testing prior to consideration for local use. Products that Ecology has approved as functionally equivalent are available for review on Ecology’s website at:

<https://ecology.wa.gov/Regulations-Permits/Guidance-technical-assistance/Stormwater-permittee-guidance-resources/Emerging-stormwater-treatment-technologies>

BMP C106: Wheel Wash

Purpose

Wheel washes reduce the amount of sediment transported onto paved roads by washing dirt from the wheels of motor vehicles prior to the motor vehicles leaving the construction site.

Conditions of Use

- Use a wheel wash when [BMP C 105: Stabilized Construction Access](#) is not preventing sediment from being tracked off site.
- Wheel washing is generally an effective BMP when installed with careful attention to topography. For example, a wheel wash can be detrimental if installed at the top of a slope abutting a right-of-way where the water from the dripping truck can run unimpeded into the street.
- Pressure washing combined with an adequately sized and surfaced pad with direct drainage to a large 10-foot x 10-foot sump can be very effective.
- Wheel wash wastewater is not stormwater. It is commonly called process water, and must be discharged to a separate on-site treatment system that prevents discharge to waters of the State, or to the sanitary sewer with local sewer district approval.
- Wheel washes may use closed-loop recirculation systems to conserve water use.
- Wheel wash wastewater shall not include wastewater from concrete washout areas.
- When practical, the wheel wash should be placed in sequence with [BMP C 105: Stabilized Construction Access](#). Locate the wheel wash such that vehicles exiting the wheel wash will enter directly onto [BMP C 105: Stabilized Construction Access](#). In order to achieve this, [BMP C 105: Stabilized Construction Access](#) may need to be extended beyond the standard installation to meet the exit of the wheel wash.

Design and Installation Specifications

Suggested details are shown in [Figure II-3.2: Wheel Wash](#). The Local Permitting Authority may allow other designs. A minimum of 6 inches of asphalt treated base (ATB) over crushed base material or 8 inches over a good subgrade is recommended to pave the wheel wash.

Use a low clearance truck to test the wheel wash before paving. Either a belly dump or lowboy will work well to test clearance.

Keep the water level from 12 to 14 inches deep to avoid damage to truck hubs and filling the truck tongues with water.

Midpoint spray nozzles are only needed in extremely muddy conditions.

Wheel wash systems should be designed with a small grade change, 6- to 12-inches for a 10-foot-wide pond, to allow sediment to flow to the low side of pond to help prevent re-suspension of sediment. A drainpipe with a 2- to 3-foot riser should be installed on the low side of the pond to allow for easy cleaning and refilling. Polymers may be used to promote coagulation and flocculation in a closed-loop system. Polyacrylamide (PAM) added to the wheel wash water at a rate of 0.25 - 0.5 pounds per 1,000 gallons of water increases effectiveness and reduces cleanup time. If PAM is already being used for dust or erosion control and is being applied by a water truck, the same truck can be used to change the wash water.

Maintenance Standards

The wheel wash should start out each day with fresh water.

The wheel wash water should be changed a minimum of once per day. On large earthwork jobs where more than 10-20 trucks per hour are expected, the wheel wash water will need to be changed more often.

Approved as Functionally Equivalent

Ecology has approved products as able to meet the requirements of this BMP. The products did not pass through the Technology Assessment Protocol – Ecology (TAPE) process. Local jurisdictions may choose not to accept these products, or may require additional testing prior to consideration for local use. Products that Ecology has approved as functionally equivalent are available for review on Ecology's website at:

<https://ecology.wa.gov/Regulations-Permits/Guidance-technical-assistance/Stormwater-permittee-guidance-resources/Emerging-stormwater-treatment-technologies>

Figure II-3.2: Wheel Wash

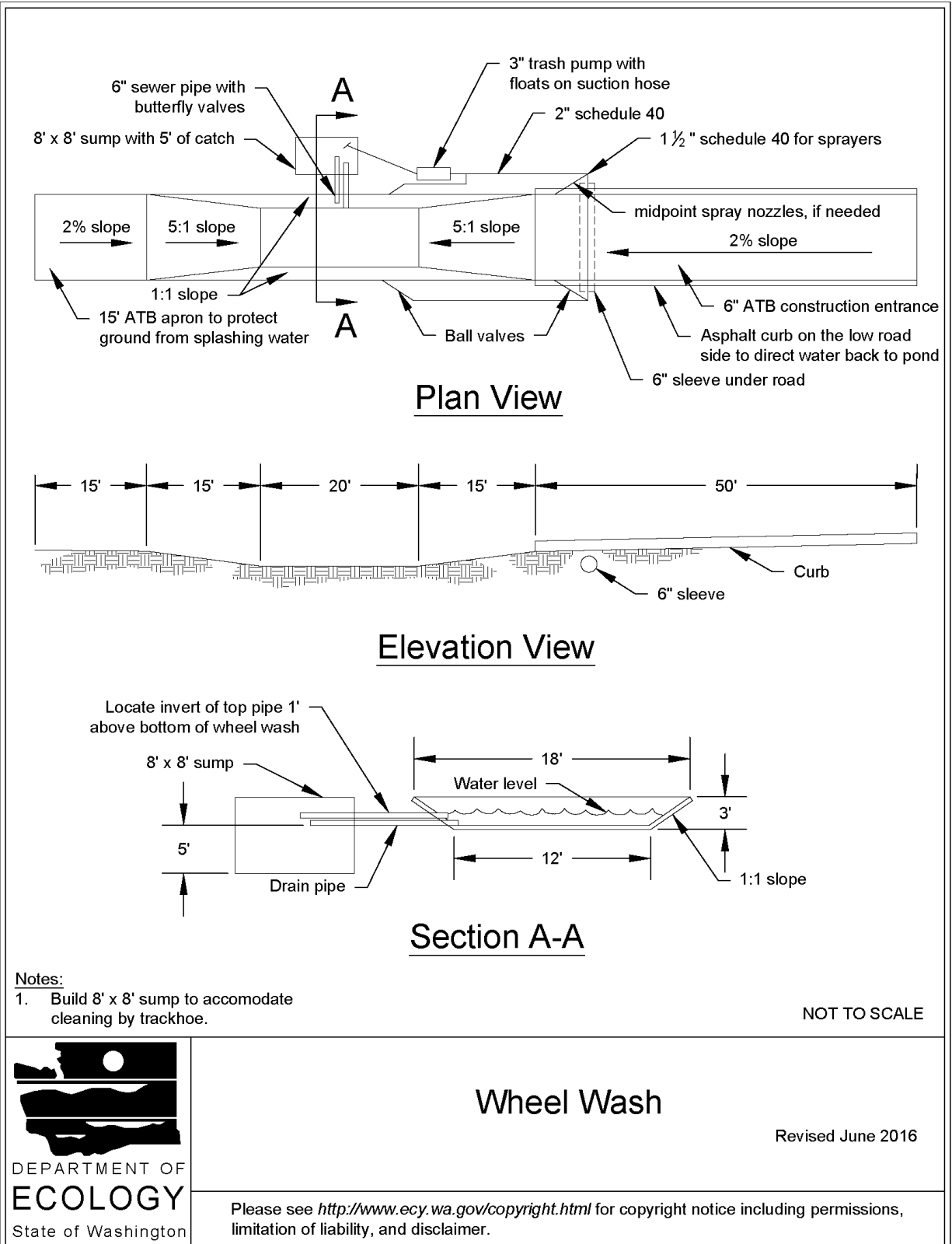

Wheel Wash

Revised June 2016

Please see <http://www.ecy.wa.gov/copyright.html> for copyright notice including permissions, limitation of liability, and disclaimer.

BMP C107: Construction Road / Parking Area Stabilization

Purpose

Stabilizing roads, parking areas, and other on-site vehicle transportation routes immediately after grading reduces erosion caused by construction traffic or stormwater runoff.

Conditions of Use

Roads and parking areas shall be stabilized wherever they are constructed, whether permanent or temporary, for use by construction traffic.

[BMP C103: High-Visibility Fence](#) shall be installed, if necessary, to limit the access of vehicles to only those roads and parking areas that are stabilized.

Design and Installation Specifications

- On areas that will receive asphalt as part of the project, install the first lift as soon as possible.
- A 6-inch depth of 2- to 4-inch crushed rock, gravel base, or crushed surfacing base course shall be applied immediately after grading or utility installation. A 4-inch course of asphalt treated base (ATB) may also be used, or the road/parking area may be paved. It may also be possible to use cement or calcium chloride for soil stabilization. If cement or cement kiln dust is used for roadbase stabilization, pH monitoring and [BMP C252: Treating and Disposing of High pH Water](#) is necessary to evaluate and minimize the effects on stormwater. If the area will not be used for permanent roads, parking areas, or structures, a 6-inch depth of hog fuel may also be used, but this is likely to require more maintenance. Whenever possible, construction roads and parking areas shall be placed on a firm, compacted subgrade.
- Temporary road gradients shall not exceed 15 percent. Roadways shall be carefully graded to drain. Drainage ditches shall be provided on each side of the roadway in the case of a crowned section, or on one side in the case of a super-elevated section. Drainage ditches shall be directed to a sediment control BMP.
- Rather than relying on ditches, it may also be possible to grade the road so that runoff sheetflows into a heavily vegetated area with a well-developed topsoil. Landscaped areas are not adequate. If this area has at least 50 feet of vegetation that water can flow through, then it is generally preferable to use the vegetation to treat runoff, rather than a sediment pond or trap. The 50 feet shall not include wetlands or their buffers. If runoff is allowed to sheetflow through adjacent vegetated areas, it is vital to design the roadways and parking areas so that no concentrated runoff is created.
- Storm drain inlets shall be protected to prevent sediment-laden water entering the drainage system (see [BMP C220: Inlet Protection](#)).

Maintenance Standards

Inspect stabilized areas regularly, especially after large storm events.

Crushed rock, gravel base, etc., shall be added as required to maintain a stable driving surface and to stabilize any areas that have eroded.

Following construction, these areas shall be restored to pre-construction condition or better to prevent future erosion.

Perform street cleaning at the end of each day or more often if necessary.

BMP C120: Temporary and Permanent Seeding

Purpose

Seeding reduces erosion by stabilizing exposed soils. A well-established vegetative cover is one of the most effective methods of reducing erosion.

Conditions of Use

Use seeding throughout the project on disturbed areas that have reached final grade or that will remain unworked for more than 30 days.

The optimum seeding windows for western Washington are April 1 through June 30 and September 1 through October 1.

Between July 1 and August 30 seeding requires irrigation until 75 percent grass cover is established.

Between October 1 and March 30 seeding requires a cover of mulch or an erosion control blanket until 75 percent grass cover is established.

Review all disturbed areas in late August to early September and complete all seeding by the end of September. Otherwise, vegetation will not establish itself enough to provide more than average protection.

Mulch is required at all times for seeding because it protects seeds from heat, moisture loss, and transport due to runoff. Mulch can be applied on top of the seed or simultaneously by hydroseeding. See [BMP C121: Mulching](#) for specifications.

Seed and mulch all disturbed areas not otherwise vegetated at final site stabilization. Final stabilization means the completion of all soil disturbing activities at the site and the establishment of a permanent vegetative cover, or equivalent permanent stabilization measures (such as pavement, riprap, gabions, or geotextiles) which will prevent erosion. See [BMP T5.13: Post-Construction Soil Quality and Depth](#).

Design and Installation Specifications

General

- Install channels intended for vegetation before starting major earthwork and hydroseed with a Bonded Fiber Matrix. For vegetated channels that will have high flows, install erosion control blankets over the top of hydroseed. Before allowing water to flow in vegetated channels, establish 75 percent vegetation cover. If vegetated channels cannot be established by seed

Table II-3.6: Mulch Standards and Guidelines (continued)

Mulch Material	Guideline	Description
	Remarks	<p>This is a cost-effective way to dispose of debris from clearing and grubbing, and it eliminates the problems associated with burning. Generally, it should not be used on slopes above approx. 10% because of its tendency to be transported by runoff. It is not recommended within 200 feet of surface waters. If permanent seeding or planting is expected shortly after mulch, the decomposition of the chipped vegetation may tie up nutrients important to grass establishment.</p> <p>Note: thick application of this material over existing grass, herbaceous species, and some groundcovers could smother and kill vegetation.</p>
Wood-Based Mulch	Quality Standards	No visible water or dust during handling. Must be purchased from a supplier with a Solid Waste Handling Permit or one exempt from solid waste regulations.
	Application Rates	2" thick min.; approx. 100 tons per acre (approx. 750 lbs. per cubic yard)
	Remarks	This material is often called "wood straw" or "hog fuel". The use of mulch ultimately improves the organic matter in the soil. Special caution is advised regarding the source and composition of wood-based mulches. Its preparation typically does not provide any weed seed control, so evidence of residual vegetation in its composition or known inclusion of weed plants or seeds should be monitored and prevented (or minimized).
Wood Strand Mulch	Quality Standards	A blend of loose, long, thin wood pieces derived from native conifer or deciduous trees with high length-to-width ratio.
	Application Rates	2" thick min.
	Remarks	Cost-effective protection when applied with adequate thickness. A minimum of 95-percent of the wood strand shall have lengths between 2 and 10-inches, with a width and thickness between 1/16 and 1/2-inches. The mulch shall not contain resin, tannin, or other compounds in quantities that would be detrimental to plant life. Sawdust or wood shavings shall not be used as mulch. [Specification 9-14.4(4) from the <i>Standard Specifications for Road, Bridge, and Municipal Construction</i> (WSDOT, 2016)

BMP C122: Nets and Blankets

Purpose

Erosion control nets and blankets are intended to prevent erosion and hold seed and mulch in place on steep slopes and in channels so that vegetation can become well established. In addition, some nets and blankets can be used to permanently reinforce turf to protect drainage ways during high flows.

Nets (commonly called matting) are strands of material woven into an open, but high-tensile strength net (for example, coconut fiber matting). Blankets are strands of material that are not tightly woven, but instead form a layer of interlocking fibers, typically held together by a biodegradable or photodegradable netting (for example, excelsior or straw blankets). They generally have lower tensile strength than nets, but cover the ground more completely. Coir (coconut fiber) fabric comes as both nets and blankets.

Conditions of Use

Erosion control netting and blankets shall be made of natural plant fibers unaltered by synthetic materials.

Erosion control nets and blankets should be used:

- To aid permanent vegetated stabilization of slopes 2H:1V or greater and with more than 10 feet of vertical relief.
- For drainage ditches and swales (highly recommended). The application of appropriate netting or blanket to drainage ditches and swales can protect bare soil from channelized runoff while vegetation is established. Nets and blankets also can capture a great deal of sediment due to their open, porous structure. Nets and blankets can be used to permanently stabilize channels and may provide a cost-effective, environmentally preferable alternative to riprap.

Disadvantages of nets and blankets include:

- Surface preparation is required.
- On slopes steeper than 2.5H:1V, net and blanket installers may need to be roped and harnessed for safety.
- They cost at least \$4,000-6,000 per acre installed.

Advantages of nets and blankets include:

- Installation without mobilizing special equipment.
- Installation by anyone with minimal training
- Installation in stages or phases as the project progresses.
- Installers can hand place seed and fertilizer as they progress down the slope.
- Installation in any weather.
- There are numerous types of nets and blankets that can be designed with various parameters in mind. Those parameters include: fiber blend, mesh strength, longevity, biodegradability, cost, and availability.

An alternative to nets and blankets in some limited conditions is [BMP C202: Riprap Channel Lining](#). Ensure that [BMP C202: Riprap Channel Lining](#) is appropriate before using it as a substitute for nets and blankets.

Design and Installation Specifications

- See [Figure II-3.3: Channel Installation \(Clackamas County et al., 2008\)](#) and [Figure II-3.4: Slope Installation](#) for typical orientation and installation of nets and blankets used in channels and as slope protection. Note: these are typical only; all nets and blankets must be installed per manufacturer's installation instructions.
- Installation is critical to the effectiveness of these products. If good ground contact is not achieved, runoff can concentrate under the product, resulting in significant erosion.
- Installation of nets and blankets on slopes:
 1. Complete final grade and track walk up and down the slope.
 2. Install hydromulch with seed and fertilizer.
 3. Dig a small trench, approximately 12 inches wide by 6 inches deep along the top of the slope.
 4. Install the leading edge of the net/blanket into the small trench and staple approximately every 18 inches. NOTE: Staples are metal, "U"-shaped, and a minimum of 6 inches long. Longer staples are used in sandy soils. Biodegradable stakes are also available.
 5. Roll the net/blanket slowly down the slope as the installer walks backward. NOTE: The net/blanket rests against the installer's legs. Staples are installed as the net/blanket is unrolled. It is critical that the proper staple pattern is used for the net/blanket being installed. The net/blanket is not to be allowed to roll down the slope on its own as this stretches the net/blanket, making it impossible to maintain soil contact. In addition, no one is allowed to walk on the net/blanket after it is in place.
 6. If the net/blanket is not long enough to cover the entire slope length, the trailing edge of the upper net/blanket should overlap the leading edge of the lower net/blanket and be stapled. On steeper slopes, this overlap should be installed in a small trench, stapled, and covered with soil.
- With the variety of products available, it is impossible to cover all the details of appropriate use and installation. Therefore, it is critical that the designer consult the manufacturer's information and that a site visit takes place in order to ensure that the product specified is appropriate. Information is also available in WSDOT's *Standard Specifications for Road, Bridge, and Municipal Construction* Division 8-01 and Division 9-14 ([WSDOT, 2016](#)).
- Use jute matting in conjunction with mulch ([BMP C121: Mulching](#)). Excelsior, woven straw blankets and coir (coconut fiber) blankets may be installed without mulch. There are many other types of erosion control nets and blankets on the market that may be appropriate in certain circumstances.
- In general, most nets (e.g., jute matting) require mulch in order to prevent erosion because they have a fairly open structure. Blankets typically do not require mulch because they usually provide complete protection of the surface.
- Extremely steep, unstable, wet, or rocky slopes are often appropriate candidates for use of synthetic blankets, as are riverbanks, beaches and other high-energy environments. If

synthetic blankets are used, the soil should be hydromulched first.

- 100-percent biodegradable blankets are available for use in sensitive areas. These organic blankets are usually held together with a paper or fiber mesh and stitching which may last up to a year.
- Most netting used with blankets is photodegradable, meaning it breaks down under sunlight (not UV stabilized). However, this process can take months or years even under bright sun. Once vegetation is established, sunlight does not reach the mesh. It is not uncommon to find non-degraded netting still in place several years after installation. This can be a problem if maintenance requires the use of mowers or ditch cleaning equipment. In addition, birds and small animals can become trapped in the netting.

Maintenance Standards

- Maintain good contact with the ground. Erosion must not occur beneath the net or blanket.
- Repair and staple any areas of the net or blanket that are damaged or not in close contact with the ground.
- Fix and protect eroded areas if erosion occurs due to poorly controlled drainage.

Figure II-3.3: Channel Installation

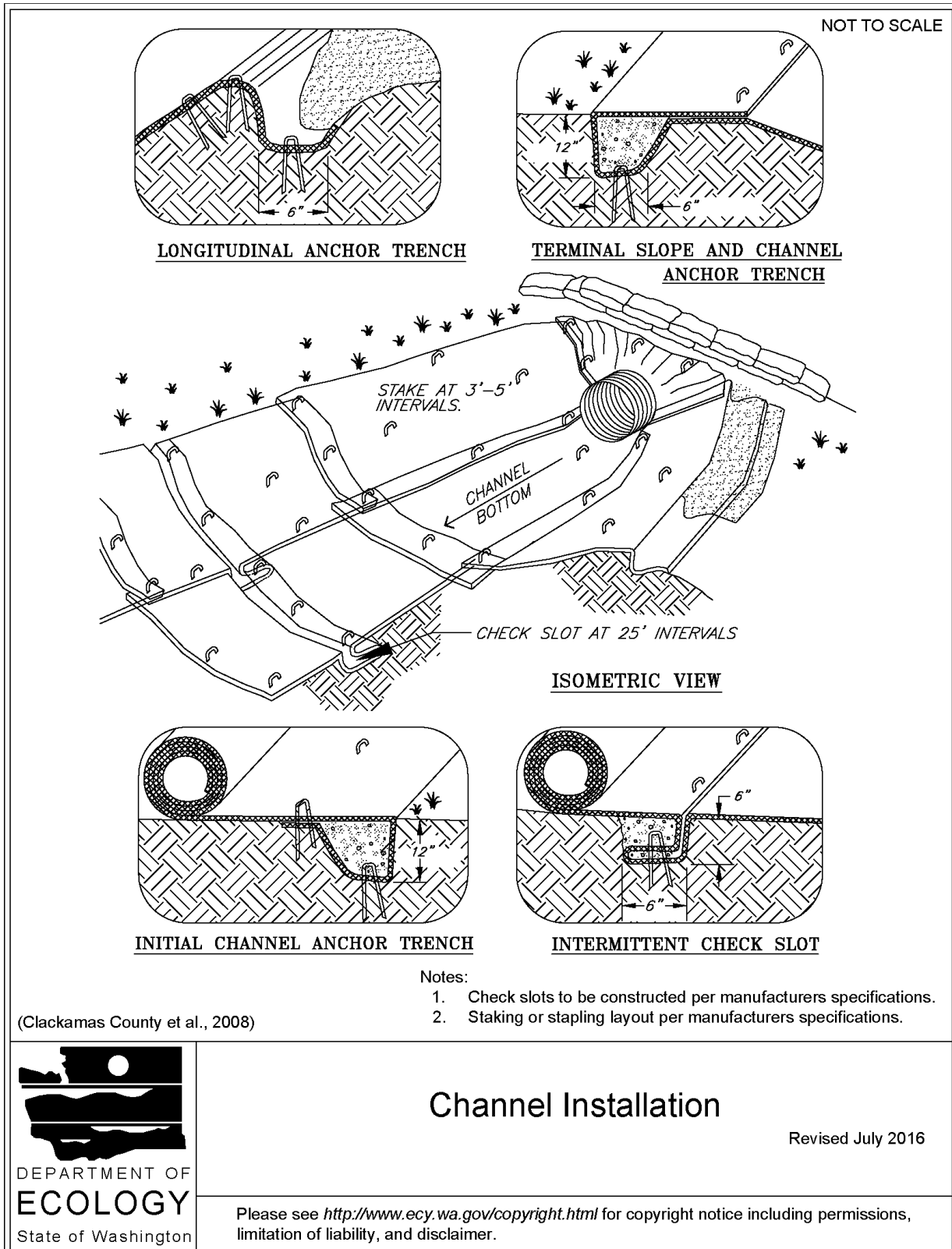
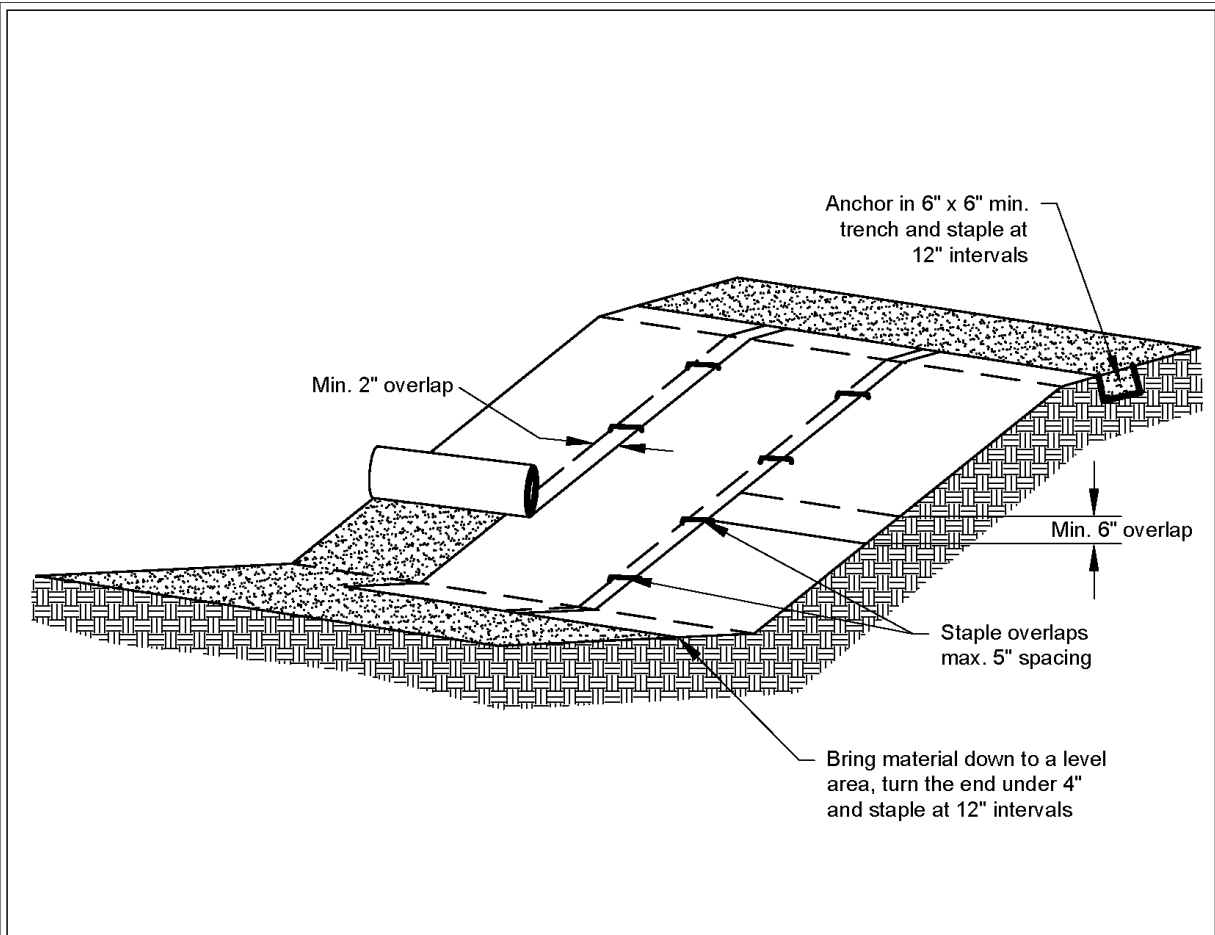

Figure II-3.4: Slope Installation



Notes:

1. Slope surface shall be smooth before placement for proper soil contact.
2. Stapling pattern as per manufacturer's recommendations.
3. Do not stretch blankets/matting tight - allow the rolls to mold to any irregularities.
4. For slopes less than 3H:1V, rolls may be placed in horizontal strips.
5. If there is a berm at the top of the slope, anchor upslope of the berm.
6. Lime, fertilize, and seed before installation. Planting of shrubs, trees, etc. should occur after installation.

NOT TO SCALE



Slope Installation

Revised June 2016

Please see <http://www.ecy.wa.gov/copyright.html> for copyright notice including permissions, limitation of liability, and disclaimer.

BMP C123: Plastic Covering

Purpose

Plastic covering provides immediate, short-term erosion protection to slopes and disturbed areas.

Conditions of Use

Plastic covering may be used on disturbed areas that require cover measures for less than 30 days, except as stated below.

- Plastic is particularly useful for protecting cut and fill slopes and stockpiles. Note: The relatively rapid breakdown of most polyethylene sheeting makes it unsuitable for long-term (greater than six months) applications.
- Due to rapid runoff caused by plastic covering, do not use this method upslope of areas that might be adversely impacted by concentrated runoff. Such areas include steep and/or unstable slopes.
- Plastic sheeting may result in increased runoff volumes and velocities, requiring additional on-site measures to counteract the increases. Creating a trough with wattles or other material can convey clean water away from these areas.
- To prevent undercutting, trench and backfill rolled plastic covering products.
- While plastic is inexpensive to purchase, the added cost of installation, maintenance, removal, and disposal make this an expensive material, up to \$1.50-2.00 per square yard.
- Whenever plastic is used to protect slopes install water collection measures at the base of the slope. These measures include plastic-covered berms, channels, and pipes used to convey clean rainwater away from bare soil and disturbed areas. Do not mix clean runoff from a plastic covered slope with dirty runoff from a project.
- Other uses for plastic include:
 1. Temporary ditch liner.
 2. Pond liner in temporary sediment pond.
 3. Liner for bermed temporary fuel storage area if plastic is not reactive to the type of fuel being stored.
 4. Emergency slope protection during heavy rains.
 5. Temporary drainpipe (“elephant trunk”) used to direct water.
- Plastic slope cover must be installed as follows:
 1. Run plastic up and down slope, not across slope.
 2. Plastic may be installed perpendicular to a slope if the slope length is less than 10 feet.
 3. Minimum of 8-inch overlap at seams.

Design and Installation Specifications

4. On long or wide slopes, or slopes subject to wind, tape all seams.
 5. Place plastic into a small (12-inch wide by 6-inch deep) slot trench at the top of the slope and backfill with soil to keep water from flowing underneath.
 6. Place sand filled burlap or geotextile bags every 3 to 6 feet along seams and tie them together with twine to hold them in place.
 7. Inspect plastic for rips, tears, and open seams regularly and repair immediately. This prevents high velocity runoff from contacting bare soil which causes extreme erosion.
 8. Sandbags may be lowered into place tied to ropes. However, all sandbags must be staked in place.
- Plastic sheeting shall have a minimum thickness of 0.06 millimeters.
 - If erosion at the toe of a slope is likely, a gravel berm, riprap, or other suitable protection shall be installed at the toe of the slope in order to reduce the velocity of runoff.
 - Torn sheets must be replaced and open seams repaired.
 - Completely remove and replace the plastic if it begins to deteriorate due to ultraviolet radiation.
 - Completely remove plastic when no longer needed.
 - Dispose of old tires used to weight down plastic sheeting appropriately.

Maintenance Standards

Approved as Equivalent

Ecology has approved products as able to meet the requirements of [BMP C123](#). The products did not pass through the Technology Assessment Protocol – Ecology (TAPE) process. Local jurisdictions may choose not to accept this product approved as equivalent, or may require additional testing prior to consideration for local use. The products are available for review on Ecology’s website at <http://www.ecy.wa.gov/programs/wq/stormwater/newtech/equivalent.html>

BMP C124: Sodding

Purpose

The purpose of sodding is to establish permanent turf for immediate erosion protection and to stabilize drainage ways where concentrated overland flow will occur.

Conditions of Use

Sodding may be used in the following areas:

- Disturbed areas that require short-term or long-term cover.
- Disturbed areas that require immediate vegetative cover.
- All waterways that require vegetative lining. Waterways may also be seeded rather than sodded, and protected with a net or blanket.

- PAM designated for these uses should be "water soluble" or "linear" or "non-crosslinked". Cross-linked or water absorbent PAM, polymerized in highly acidic (pH<2) conditions, are used to maintain soil moisture content.
- The PAM anionic charge density may vary from 2-30 percent; a value of 18 percent is typical. Studies conducted by the United States Department of Agriculture (USDA)/ARS demonstrated that soil stabilization was optimized by using very high molecular weight (12-15 mg/-mole), highly anionic (>20% hydrolysis) PAM.
- PAM tackifiers are available and being used in place of guar and alpha plantago. Typically, PAM tackifiers should be used at a mixing rate of no more than 0.5-1 lb. per 1000 gallons of water in a hydromulch machine. Some tackifier product instructions say to use at an application rate of 3 – 5 lbs per acre, which can be too much. In addition, pump problems can occur at higher application rates due to increased viscosity.

Maintenance Standards

- PAM may be reapplied on actively worked areas after a 48-hour period.
- Reapplication is not required unless PAM treated soil is disturbed or unless turbidity levels show the need for an additional application. If PAM treated soil is left undisturbed, a reapplication may be necessary after two months. More PAM applications may be required for steep slopes, silty and clayey soils (USDA Classification Type "C" and "D" soils), long grades, and high precipitation areas. When PAM is applied first to bare soil and then covered with straw, a reapplication may not be necessary for several months.
- Loss of sediment and PAM may be a basis for penalties per [RCW 90.48.080](#).
- PAM may affect the treatment efficiency of chitosan flocculent systems.

BMP C130: Surface Roughening

Purpose

Surface roughening aids in the establishment of vegetative cover, reduces runoff velocity, increases infiltration, and provides for sediment trapping through the provision of a rough soil surface. Horizontal depressions are created by operating a tiller or other suitable equipment on the contour or by leaving slopes in a roughened condition by not fine grading them.

Use this BMP in conjunction with other BMPs such as [BMP C120: Temporary and Permanent Seeding](#), [BMP C121: Mulching](#), or [BMP C124: Sodding](#).

Conditions for Use

- All slopes steeper than 3H:1V and greater than 5 vertical feet require surface roughening to a depth of 2 to 4 inches prior to seeding.
- Areas that will not be stabilized immediately may be roughened to reduce runoff velocity until seeding takes place.

- Slopes with a stable rock face do not require roughening.
- Slopes where mowing is planned should not be excessively roughened.

Design and Installation Specifications

There are different methods for achieving a roughened soil surface on a slope, and the selection of an appropriate method depends upon the type of slope. Roughening methods include stair-step grading, grooving, contour furrows, and tracking. See [Figure II-3.5: Surface Roughening by Tracking and Contour Furrows](#). Factors to be considered in choosing a roughening method are slope steepness, mowing requirements, and whether the slope is formed by cutting or filling.

- Disturbed areas that will not require mowing may be stair-step graded, grooved, or left rough after filling.
- Stair-step grading is particularly appropriate in soils containing large amounts of soft rock. Each "step" catches material that sloughs from above, and provides a level site where vegetation can become established. Stairs should be wide enough to work with standard earth moving equipment. Stair steps must be on contour or gullies will form on the slope.
- Areas that will be mowed (these areas should have slopes less steep than 3H:1V) may have small furrows left by disking, harrowing, raking, or seed-planting machinery operated on the contour.
- Graded areas with slopes steeper than 3H:1V but less than 2H:1V should be roughened before seeding. This can be accomplished in a variety of ways, including "track walking," or driving a crawler tractor up and down the slope, leaving a pattern of cleat imprints parallel to slope contours.
- Tracking is done by operating equipment up and down the slope to leave horizontal depressions in the soil.

Maintenance Standards

- Areas that are surface roughened should be seeded as quickly as possible.
- Regular inspections should be made of the area. If rills appear, they should be re-roughened and re-seeded immediately.

Figure II-3.5: Surface Roughening by Tracking and Contour Furrows

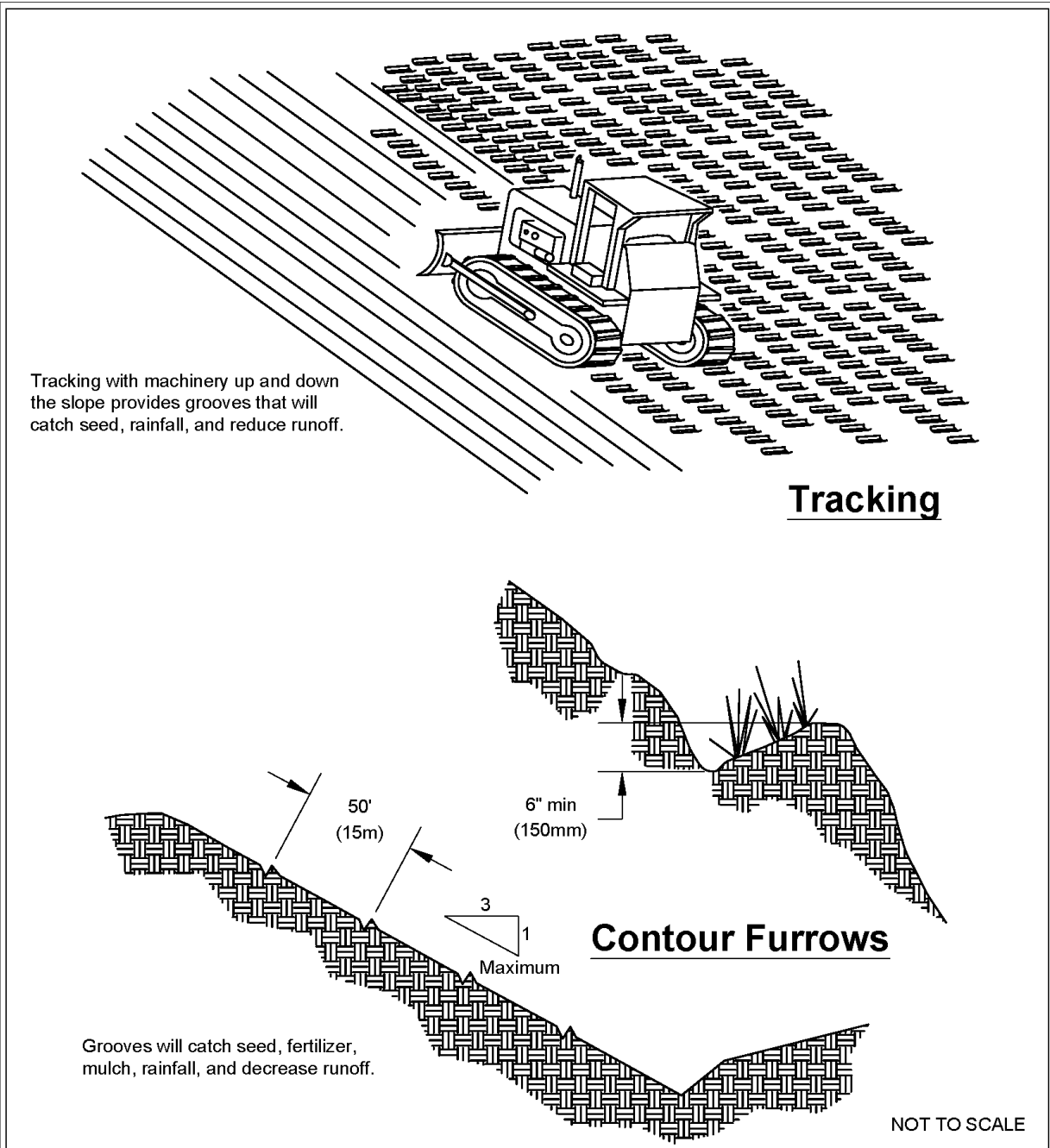

**Surface Roughening by Tracking
and Contour Furrows**

Revised June 2016

Please see <http://www.ecy.wa.gov/copyright.html> for copyright notice including permissions, limitation of liability, and disclaimer.

BMP C152: Sawcutting and Surfacing Pollution Prevention

Purpose Sawcutting and surfacing operations generate slurry and process water that contains fine particles and high pH (concrete cutting), both of which can violate the water quality standards in the receiving water. Concrete spillage or concrete discharge to surface waters of the State is prohibited. Use this BMP to minimize and eliminate process water and slurry created through sawcutting or surfacing from entering waters of the State.

Conditions of Use Utilize these management practices anytime sawcutting or surfacing operations take place. Sawcutting and surfacing operations include, but are not limited to, the following:

- Sawing
- Coring
- Grinding
- Roughening
- Hydro-demolition
- Bridge and road surfacing
- Vacuum slurry and cuttings during cutting and surfacing operations.
- Slurry and cuttings shall not remain on permanent concrete or asphalt pavement overnight.
- Slurry and cuttings shall not drain to any natural or constructed drainage conveyance including stormwater systems. This may require temporarily blocking catch basins.
- Dispose of collected slurry and cuttings in a manner that does not violate ground water or surface water quality standards.
- Do not allow process water generated during hydro-demolition, surface roughening or similar operations to drain to any natural or constructed drainage conveyance including stormwater systems. Dispose process water in a manner that does not violate ground water or surface water quality standards.
- Handle and dispose cleaning waste material and demolition debris in a manner that does not cause contamination of water. Dispose of sweeping material from a pick-up sweeper at an appropriate disposal site.

Maintenance Standards Continually monitor operations to determine whether slurry, cuttings, or process water could enter waters of the state. If inspections show that a violation of water quality standards could occur, stop operations and immediately implement preventive measures such as berms, barriers, secondary containment, and vacuum trucks.

BMP C153: Material Delivery, Storage and Containment

<i>Purpose</i>	Prevent, reduce, or eliminate the discharge of pollutants to the stormwater system or watercourses from material delivery and storage. Minimize the storage of hazardous materials on-site, store materials in a designated area, and install secondary containment.
<i>Conditions of Use</i>	<p>These procedures are suitable for use at all construction sites with delivery and storage of the following materials:</p> <ul style="list-style-type: none">• Petroleum products such as fuel, oil and grease• Soil stabilizers and binders (e.g., Polyacrylamide)• Fertilizers, pesticides and herbicides• Detergents• Asphalt and concrete compounds• Hazardous chemicals such as acids, lime, adhesives, paints, solvents, and curing compounds• Any other material that may be detrimental if released to the environment
<i>Design and Installation Specifications</i>	<p>The following steps should be taken to minimize risk:</p> <ul style="list-style-type: none">• Temporary storage area should be located away from vehicular traffic, near the construction entrance(s), and away from waterways or storm drains.• Material Safety Data Sheets (MSDS) should be supplied for all materials stored. Chemicals should be kept in their original labeled containers.• Hazardous material storage on-site should be minimized.• Hazardous materials should be handled as infrequently as possible.• During the wet weather season (Oct 1 – April 30), consider storing materials in a covered area.• Materials should be stored in secondary containments, such as earthen dike, horse trough, or even a children’s wading pool for non-reactive materials such as detergents, oil, grease, and paints. Small amounts of material may be secondarily contained in “bus boy” trays or concrete mixing trays.• Do not store chemicals, drums, or bagged materials directly on the ground. Place these items on a pallet and, when possible, and within secondary containment.• If drums must be kept uncovered, store them at a slight angle to reduce ponding of rainwater on the lids to reduce corrosion. Domed plastic covers are inexpensive and snap to the top of drums, preventing water from collecting.

Material Storage Areas and Secondary Containment Practices:

- Liquids, petroleum products, and substances listed in 40 CFR Parts 110, 117, or 302 shall be stored in approved containers and drums and shall not be overfilled. Containers and drums shall be stored in temporary secondary containment facilities.
- Temporary secondary containment facilities shall provide for a spill containment volume able to contain 10% of the total enclosed container volume of all containers, or 110% of the capacity of the largest container within its boundary, whichever is greater.
- Secondary containment facilities shall be impervious to the materials stored therein for a minimum contact time of 72 hours.
- Secondary containment facilities shall be maintained free of accumulated rainwater and spills. In the event of spills or leaks, accumulated rainwater and spills shall be collected and placed into drums. These liquids shall be handled as hazardous waste unless testing determines them to be non-hazardous.
- Sufficient separation should be provided between stored containers to allow for spill cleanup and emergency response access.
- During the wet weather season (Oct 1 – April 30), each secondary containment facility shall be covered during non-working days, prior to and during rain events.
- Keep material storage areas clean, organized and equipped with an ample supply of appropriate spill clean-up material (spill kit).
- The spill kit should include, at a minimum:
 - 1-Water Resistant Nylon Bag
 - 3-Oil Absorbent Socks 3”x 4’
 - 2-Oil Absorbent Socks 3”x 10’
 - 12-Oil Absorbent Pads 17”x19”
 - 1-Pair Splash Resistant Goggles
 - 3-Pair Nitrile Gloves
 - 10-Disposable Bags with Ties
 - Instructions

Conditions of Use

The construction sequence schedule is an orderly listing of all major land-disturbing activities together with the necessary erosion and sedimentation control measures planned for the project. This type of schedule guides the contractor on work to be done before other work is started so that serious erosion and sedimentation problems can be avoided.

Following a specified work schedule that coordinates the timing of land-disturbing activities and the installation of control measures is perhaps the most cost-effective way of controlling erosion during construction. The removal of ground cover leaves a site vulnerable to erosion. Construction sequencing that limits land clearing, provides timely installation of erosion and sedimentation controls, and restores protective cover quickly can significantly reduce the erosion potential of a site.

Design Considerations

- Minimize construction during rainy periods.
- Schedule projects to disturb only small portions of the site at any one time. Complete grading as soon as possible. Immediately stabilize the disturbed portion before grading the next portion. Practice staged seeding in order to revegetate cut and fill slopes as the work progresses.

II-3.3 Construction Runoff BMPs

BMP C200: Interceptor Dike and Swale

Purpose

Provide a dike of compacted soil or a swale at the top or base of a disturbed slope or along the perimeter of a disturbed construction area to convey stormwater. Use the dike and/or swale to intercept the runoff from unprotected areas and direct it to areas where erosion can be controlled. This can prevent storm runoff from entering the work area or sediment-laden runoff from leaving the construction site.

Conditions of Use

Use an interceptor dike or swale where runoff from an exposed site or disturbed slope must be conveyed to an erosion control BMP which can safely convey the stormwater.

- Locate upslope of a construction site to prevent runoff from entering the disturbed area.
- When placed horizontally across a disturbed slope, it reduces the amount and velocity of runoff flowing down the slope.
- Locate downslope to collect runoff from a disturbed area and direct it to a sediment BMP (e.g. [BMP C240: Sediment Trap](#) or [BMP C241: Sediment Pond \(Temporary\)](#)).

Design and Installation Specifications

- Dike and/or swale and channel must be stabilized with temporary or permanent vegetation or other channel protection during construction.
 - Steep grades require channel protection and check dams.
 - Review construction for areas where overtopping may occur.
 - Can be used at the top of new fill before vegetation is established.
 - May be used as a permanent diversion channel to carry the runoff.
 - Contributing area for an individual dike or swale should be one acre or less.
 - Design the dike and/or swale to contain flows calculated by one of the following methods:
 - Single Event Hydrograph Method: The peak volumetric flow rate calculated using a 10-minute time step from a Type 1A, 10-year, 24-hour frequency storm for the worst-case land cover condition.
- OR
- Continuous Simulation Method: The 10-year peak flow rate, as determined by an approved continuous runoff model with a 15-minute time step for the worst-case land cover condition.

Worst-case land cover conditions (i.e., producing the most runoff) should be used for analysis (in most cases, this would be the land cover conditions just prior to final landscaping).

Interceptor Dikes

Interceptor dikes shall meet the following criteria:

- Top Width: 2 feet minimum.
- Height: 1.5 feet minimum on berm.
- Side Slope: 2H:1V or flatter.
- Grade: Depends on topography, however, dike system minimum is 0.5%, and maximum is 1%.
- Compaction: Minimum of 90 percent ASTM D698 standard proctor.
- Stabilization: Depends on velocity and reach. Inspect regularly to ensure stability.
- Ground Slopes <5%: Seed and mulch applied within 5 days of dike construction (see [BMP C121: Mulching](#)).
- Ground Slopes 5 - 40%: Dependent on runoff velocities and dike materials. Stabilization should be done immediately using either sod or riprap, or other measures to avoid erosion.
- The upslope side of the dike shall provide positive drainage to the dike outlet. No erosion shall

occur at the outlet. Provide energy dissipation measures as necessary. Sediment-laden runoff must be released through a sediment trapping facility.

- Minimize construction traffic over temporary dikes. Use temporary cross culverts for channel crossing.
- See [Table II-3.8: Horizontal Spacing of Interceptor Dikes Along Ground Slope](#) for recommended horizontal spacing between dikes.

Table II-3.8: Horizontal Spacing of Interceptor Dikes Along Ground Slope

Average Slope	Slope Percent	Flowpath Length
20H:1V or less	3-5%	300 feet
(10 to 20)H:1V	5-10%	200 feet
(4 to 10)H:1V	10-25%	100 feet
(2 to 4)H:1V	25-50%	50 feet

Interceptor Swales

Interceptor swales shall meet the following criteria:

- Bottom Width: 2 feet minimum; the cross-section bottom shall be level.
- Depth: 1-foot minimum.
- Side Slope: 2H:1V or flatter.
- Grade: Maximum 5 percent, with positive drainage to a suitable outlet (such as [BMP C241: Sediment Pond \(Temporary\)](#)).
- Stabilization: Seed as per [BMP C120: Temporary and Permanent Seeding](#), or [BMP C202: Riprap Channel Lining](#), 12 inches thick riprap pressed into the bank and extending at least 8 inches vertical from the bottom.

Maintenance Standards

- Inspect diversion dikes and interceptor swales once a week and after every rainfall. Immediately remove sediment from the flow area.
- Damage caused by construction traffic or other activity must be repaired before the end of each working day.
- Check outlets and make timely repairs as needed to avoid gully formation. When the area below the temporary diversion dike is permanently stabilized, remove the dike and fill and stabilize the channel to blend with the natural surface.

BMP C205: Subsurface Drains

Purpose

The purpose of subsurface drains is to intercept, collect, and convey ground water to a satisfactory outlet, using a perforated pipe or other conduit below the ground surface. Subsurface drains are also known as “french drains.” The perforated pipe provides a dewatering mechanism to drain excessively wet soils, provide a stable base for construction, improve stability of structures with shallow foundations, or to reduce hydrostatic pressure to improve slope stability.

Conditions of Use

Use subsurface drains when excessive water must be removed from the soil. The soil permeability, depth to water table, and impervious layers are all factors which may govern the use of subsurface drains.

Design and Installation Specifications

Subsurface Drain Type: Relief Drains

Relief drains are used to lower the water table in large, relatively flat areas, improve the growth of vegetation, or to remove surface water.

Relief drains are installed along a slope and drain in the direction of the slope.

Relief drains can be installed in a grid pattern, a herringbone pattern, or a random pattern.

Subsurface Drain Type: Interceptor Drains

Interceptor drains are used to remove excess ground water from a slope, stabilize steep slopes, and lower the water table immediately below a slope to prevent the soil from becoming saturated.

Interceptor drains are installed perpendicular to a slope and drain to the side of the slope.

Interceptor drains usually consist of a single pipe or series of single pipes instead of a patterned layout.

Subsurface Drain Depth and Spacing

- The depth of a subsurface drain is determined primarily by the depth to which the water table is to be lowered or the depth to a confining layer. For practical reasons, the maximum depth is usually limited to 6 feet, with a minimum cover of 2 feet to protect the conduit.
- The soil should have depth and sufficient permeability to permit installation of an effective drainage system at a depth of 2 to 6 feet.

Subsurface Drain Sizing and Placement

- The quantity and quality of discharge needs to be accounted for in the receiving stream (additional detention may be required).
- The size of a subsurface drain is determined by first calculating the maximum rate of ground water flow to be intercepted, and then choosing a subsurface drain pipe (or pipes) with enough capacity to convey that flow. Therefore, it is good practice to make complete subsurface investigations, including hydraulic conductivity of the soil, before designing a subsurface drainage system.
- Size subsurface drains to carry the required capacity without pressure flow. Minimum diameter for a subsurface drain is 4 inches.
- The minimum velocity in the pipe required to prevent silting is 1.4 ft/sec. Grade the subsurface drain to achieve this velocity at a minimum. The maximum allowable velocity using a sand-gravel filter or envelope is 9 ft/sec.
- Filter material and fabric shall be used around all drains for proper bedding and filtration of fine materials. Envelopes and filters should surround the drain to a minimum of 3-inch thickness.
- The trench shall be constructed on a continuous grade with no reverse grades or low spots.
- Soft or yielding soils under the subsurface drain shall be stabilized with gravel or other suitable material.
- Backfilling shall be done immediately after placement of the pipe. No sections of pipe shall remain uncovered overnight or during a rainstorm. Backfill material shall be placed in the trench in such a manner that the drain pipe is not displaced or damaged.
- Do not install permanent drains near trees to avoid the tree roots that tend to clog the line. Use solid pipe with watertight connections where it is necessary to pass a subsurface drainage system through a stand of trees.

Subsurface Drain Outlets

- An adequate outlet for the subsurface drain must be available either by gravity or by pumping.
- The outlet of the subsurface drain shall empty into a sediment trapping BMP through a catch basin. If free of sediment, it can then empty into a receiving channel, swale, or stable vegetated area adequately protected from erosion and undermining.
- Ensure that the outlet of a subsurface drain empties into a channel or other watercourse above the normal water level.
- Secure an animal guard to the outlet end of the pipe to keep out rodents.
- Use outlet pipe of corrugated metal, cast iron, or heavy-duty plastic without perforations and at least 10 feet long. Do not use an envelope or filter material around the outlet pipe, and bury at least two-thirds of the pipe length.

- When outlet velocities exceed those allowable for the receiving stream, outlet protection must be provided.

Maintenance Standards

Subsurface drains shall be checked periodically to ensure that they are free-flowing and not clogged with sediment or roots.

- The outlet shall be kept clean and free of debris.
- Surface inlets shall be kept open and free of sediment and other debris.
- Trees located too close to a subsurface drain often clog the system with their roots. If a drain becomes clogged, relocate the drain or remove the trees as a last resort. Drain placement should be planned to minimize this problem.
- Where drains are crossed by heavy vehicles, the line shall be checked to ensure that it is not crushed.

BMP C206: Level Spreader

Purpose

The purpose of a level spreader as a Construction Stormwater BMP is to provide a temporary outlet for dikes and diversions and convert concentrated runoff to sheet flow prior to releasing it to stabilized areas.

Conditions of Use

Use level spreaders when a concentrated flow of water needs to be dispersed over a large area with existing stable vegetation.

Use only where the slopes are gentle, the water volume is relatively low, and the soil will adsorb most of the low flow events.

Items to consider are:

- What is the risk of erosion or damage if the flow becomes concentrated?
- Is an easement required if discharged to adjoining property?

Design and Installation Specifications

- Use above undisturbed areas that are stabilized by existing vegetation.
- Discharge area below the outlet must be uniform with a slope flatter than 5H:1V.
- Do not allow any low points in the level spreader. If the level spreader has any low points, flow will concentrate, create channels and may cause erosion.
- Ensure the outlet is level in a stable, undisturbed soil profile (not on fill).

BMP C207: Check Dams

Purpose

Construction of check dams across a swale or ditch reduces the velocity of concentrated flow and dissipates energy at the check dam.

Conditions of Use

Use check dams where temporary or permanent channels are not yet vegetated, channel lining is infeasible, and/or velocity checks are required.

- Check dams may not be placed in streams unless approved by the State Department of Fish and Wildlife.
- Check dams may not be placed in wetlands without approval from a permitting agency.
- Do not place check dams below the expected backwater from any salmonid bearing water between October 1 and May 31 to ensure that there is no loss of high flow refuge habitat for overwintering juvenile salmonids and emergent salmonid fry.

Design and Installation Specifications

- Construct rock check dams from appropriately sized rock. The rock used must be large enough to stay in place given the expected design flow through the channel. The rock must be placed by hand or by mechanical means (do not dump the rock to form the dam) to achieve complete coverage of the ditch or swale and to ensure that the center of the dam is lower than the edges.
- Check dams may also be constructed of either rock or pea-gravel filled bags. Numerous new products are also available for this purpose. They tend to be re-usable, quick and easy to install, effective, and cost efficient.
- Place check dams perpendicular to the flow of water.
- The check dam should form a triangle when viewed from the side. This prevents undercutting as water flows over the face of the check dam rather than falling directly onto the ditch bottom.
- Before installing check dams, impound and bypass upstream water flow away from the work area. Options for bypassing include pumps, siphons, or temporary channels.
- Check dams combined with sumps work more effectively at slowing flow and retaining sediment than a check dam alone. A deep sump should be provided immediately upstream of the check dam.
- In some cases, if carefully located and designed, check dams can remain as permanent installations with very minor regrading. They may be left as either spillways, in which case accumulated sediment would be graded and seeded, or as check dams to prevent further sediment from leaving the site.
- The maximum spacing between check dams shall be such that the downstream toe of the

upstream dam is at the same elevation as the top of the downstream dam.

- Keep the maximum height at 2 feet at the center of the check dam.
- Keep the center of the check dam at least 12 inches lower than the outer edges at natural ground elevation.
- Keep the side slopes of the check dam at 2H:1V or flatter.
- Key the stone into the ditch banks and extend it beyond the abutments a minimum of 18 inches to avoid washouts from overflow around the dam.
- Use filter fabric foundation under a rock or sand bag check dam. If a blanket ditch liner is used, filter fabric is not necessary. A piece of organic or synthetic blanket cut to fit will also work for this purpose.
- In the case of grass-lined ditches and swales, all check dams and accumulated sediment shall be removed when the grass has matured sufficiently to protect the ditch or swale - unless the slope of the swale is greater than 4 percent. The area beneath the check dams shall be seeded and mulched immediately after dam removal.
- Ensure that channel appurtenances, such as culvert entrances below check dams, are not subject to damage or blockage from displaced stones.
- See [Figure II-3.16: Rock Check Dam](#).

Maintenance Standards

Check dams shall be monitored for performance and sediment accumulation during and after each rainfall that produces runoff. Sediment shall be removed when it reaches one half the sump depth.

- Anticipate submergence and deposition above the check dam and erosion from high flows around the edges of the dam.
- If significant erosion occurs between dams, install a protective riprap liner in that portion of the channel. See [BMP C202: Riprap Channel Lining](#).

Approved as Functionally Equivalent

Ecology has approved products as able to meet the requirements of this BMP. The products did not pass through the Technology Assessment Protocol – Ecology (TAPE) process. Local jurisdictions may choose not to accept these products, or may require additional testing prior to consideration for local use. Products that Ecology has approved as functionally equivalent are available for review on Ecology's website at:

<https://ecology.wa.gov/Regulations-Permits/Guidance-technical-assistance/Stormwater-permittee-guidance-resources/Emerging-stormwater-treatment-technologies>

Figure II-3.16: Rock Check Dam

View Looking Upstream

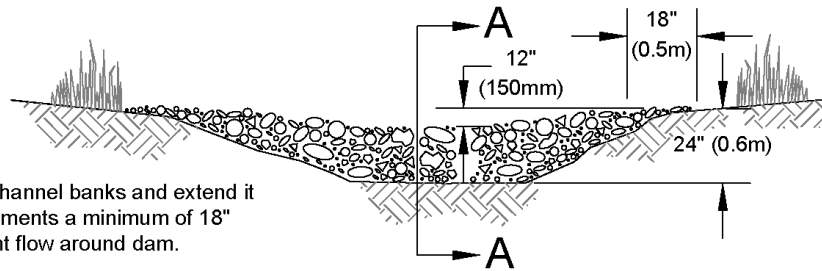

Note:
Key stone into channel banks and extend it beyond the abutments a minimum of 18" (0.5m) to prevent flow around dam.

Section A-A

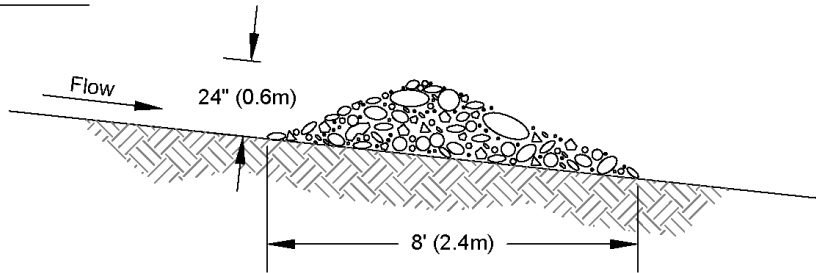

Spacing Between Check Dams

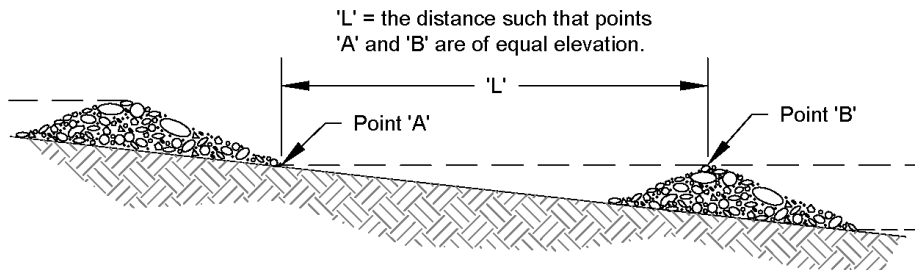

NOT TO SCALE



Rock Check Dam

Revised June 2016

Please see <http://www.ecy.wa.gov/copyright.html> for copyright notice including permissions, limitation of liability, and disclaimer.

and staples.

- In the case of grass-lined ditches and swales, check dams and accumulated sediment shall be removed when the grass has matured sufficiently to protect the ditch or swale unless the slope of the swale is greater than 4 percent. The area beneath the check dams shall be seeded and mulched immediately after dam removal.

Maintenance Standards

- Inspect TSDs for performance and sediment accumulation during and after each rainfall that produces runoff. Remove sediment when it reaches one half the height of the TSD.
- Anticipate submergence and deposition above the TSD and erosion from high flows around the edges of the TSD. Immediately repair any damage or any undercutting of the TSD.

BMP C209: Outlet Protection

Purpose

Outlet protection prevents scour at conveyance outlets and minimizes the potential for downstream erosion by reducing the velocity of concentrated stormwater flows.

Conditions of Use

Use outlet protection at the outlets of all ponds, pipes, ditches, or other conveyances that discharge to a natural or manmade drainage feature such as a stream, wetland, lake, or ditch.

Design and Installation Specifications

- The receiving channel at the outlet of a pipe shall be protected from erosion by lining a minimum of 6 feet downstream and extending up the channel sides a minimum of 1-foot above the maximum tailwater elevation, or 1-foot above the crown, whichever is higher. For pipes larger than 18 inches in diameter, the outlet protection lining of the channel shall be four times the diameter of the outlet pipe.
- Standard wingwalls, tapered outlets, and paved channels should also be considered when appropriate for permanent culvert outlet protection ([WSDOT, 2015](#)).
- [BMP C122: Nets and Blankets](#) or [BMP C202: Riprap Channel Lining](#) provide suitable options for lining materials.
- With low flows, [BMP C201: Grass-Lined Channels](#) can be an effective alternative for lining material.
- The following guidelines shall be used for outlet protection with riprap:
 - If the discharge velocity at the outlet is less than 5 fps, use 2-inch to 8-inch riprap. Minimum thickness is 1-foot.
 - For 5 to 10 fps discharge velocity at the outlet, use 24-inch to 48-inch riprap. Minimum

thickness is 2 feet.

- For outlets at the base of steep slope pipes (pipe slope greater than 10 percent), use an engineered energy dissipator.
- Filter fabric or erosion control blankets should always be used under riprap to prevent scour and channel erosion. See [BMP C122: Nets and Blankets](#).
- Bank stabilization, bioengineering, and habitat features may be required for disturbed areas. This work may require a Hydraulic Project Approval (HPA) from the Washington State Department of Fish and Wildlife. See [I-2.11 Hydraulic Project Approvals](#).

Maintenance Standards

- Inspect and repair as needed.
- Add rock as needed to maintain the intended function.
- Clean energy dissipator if sediment builds up.

BMP C220: Inlet Protection

Purpose

Inlet protection prevents coarse sediment from entering drainage systems prior to permanent stabilization of the disturbed area.

Conditions of Use

Use inlet protection at inlets that are operational before permanent stabilization of the disturbed areas that contribute runoff to the inlet. Provide protection for all storm drain inlets downslope and within 500 feet of a disturbed or construction area, unless those inlets are preceded by a sediment trapping BMP.

Also consider inlet protection for lawn and yard drains on new home construction. These small and numerous drains coupled with lack of gutters can add significant amounts of sediment into the roof drain system. If possible, delay installing lawn and yard drains until just before landscaping, or cap these drains to prevent sediment from entering the system until completion of landscaping. Provide 18-inches of sod around each finished lawn and yard drain.

[Table II-3.10: Storm Drain Inlet Protection](#) lists several options for inlet protection. All of the methods for inlet protection tend to plug and require a high frequency of maintenance. Limit contributing drainage areas for an individual inlet to one acre or less. If possible, provide emergency overflows with additional end-of-pipe treatment where stormwater ponding would cause a hazard.

Table II-3.10: Storm Drain Inlet Protection

Type of Inlet Protection	Emergency Overflow	Applicable for Paved/ Earthen Surfaces	Conditions of Use
Drop Inlet Protection			
Excavated drop inlet protection	Yes, temporary flooding may occur	Earthen	Applicable for heavy flows. Easy to maintain. Large area requirement: 30'x30'/acre
Block and gravel drop inlet protection	Yes	Paved or Earthen	Applicable for heavy concentrated flows. Will not pond.
Gravel and wire drop inlet protection	No	Paved or Earthen	Applicable for heavy concentrated flows. Will pond. Can withstand traffic.
Catch basin filters	Yes	Paved or Earthen	Frequent maintenance required.
Curb Inlet Protection			
Curb inlet protection with wooden weir	Small capacity overflow	Paved	Used for sturdy, more compact installation.
Block and gravel curb inlet protection	Yes	Paved	Sturdy, but limited filtration.
Culvert Inlet Protection			
Culvert inlet sediment trap	N/A	N/A	18 month expected life.

Design and Installation Specifications

Excavated Drop Inlet Protection

Excavated drop inlet protection consists of an excavated impoundment around the storm drain inlet. Sediment settles out of the stormwater prior to entering the storm drain. Design and installation specifications for excavated drop inlet protection include:

- Provide a depth of 1-2 ft as measured from the crest of the inlet structure.
- Slope sides of excavation should be no steeper than 2H:1V.
- Minimum volume of excavation is 35 cubic yards.
- Shape the excavation to fit the site, with the longest dimension oriented toward the longest inflow area.
- Install provisions for draining to prevent standing water.
- Clear the area of all debris.

- Grade the approach to the inlet uniformly.
- Drill weep holes into the side of the inlet.
- Protect weep holes with screen wire and washed aggregate.
- Seal weep holes when removing structure and stabilizing area.
- Build a temporary dike, if necessary, to the down slope side of the structure to prevent bypass flow.

Block and Gravel Filter

A block and gravel filter is a barrier formed around the inlet with standard concrete blocks and gravel. See [Figure II-3.17: Block and Gravel Filter](#). Design and installation specifications for block gravel filters include:

- Provide a height of 1 to 2 feet above the inlet.
- Recess the first row of blocks 2-inches into the ground for stability.
- Support subsequent courses by placing a pressure treated wood 2x4 through the block opening.
- Do not use mortar.
- Lay some blocks in the bottom row on their side to allow for dewatering the pool.
- Place hardware cloth or comparable wire mesh with ½-inch openings over all block openings.
- Place gravel to just below the top of blocks on slopes of 2H:1V or flatter.
- An alternative design is a gravel berm surrounding the inlet, as follows:
 - Provide a slope of 3H:1V on the upstream side of the berm.
 - Provide a slope of 2H:1V on the downstream side of the berm.
 - Provide a 1-foot wide level stone area between the gravel berm and the inlet.
 - Use stones 3 inches in diameter or larger on the upstream slope of the berm.
 - Use gravel ½- to ¾-inch at a minimum thickness of 1-foot on the downstream slope of the berm.

Figure II-3.17: Block and Gravel Filter

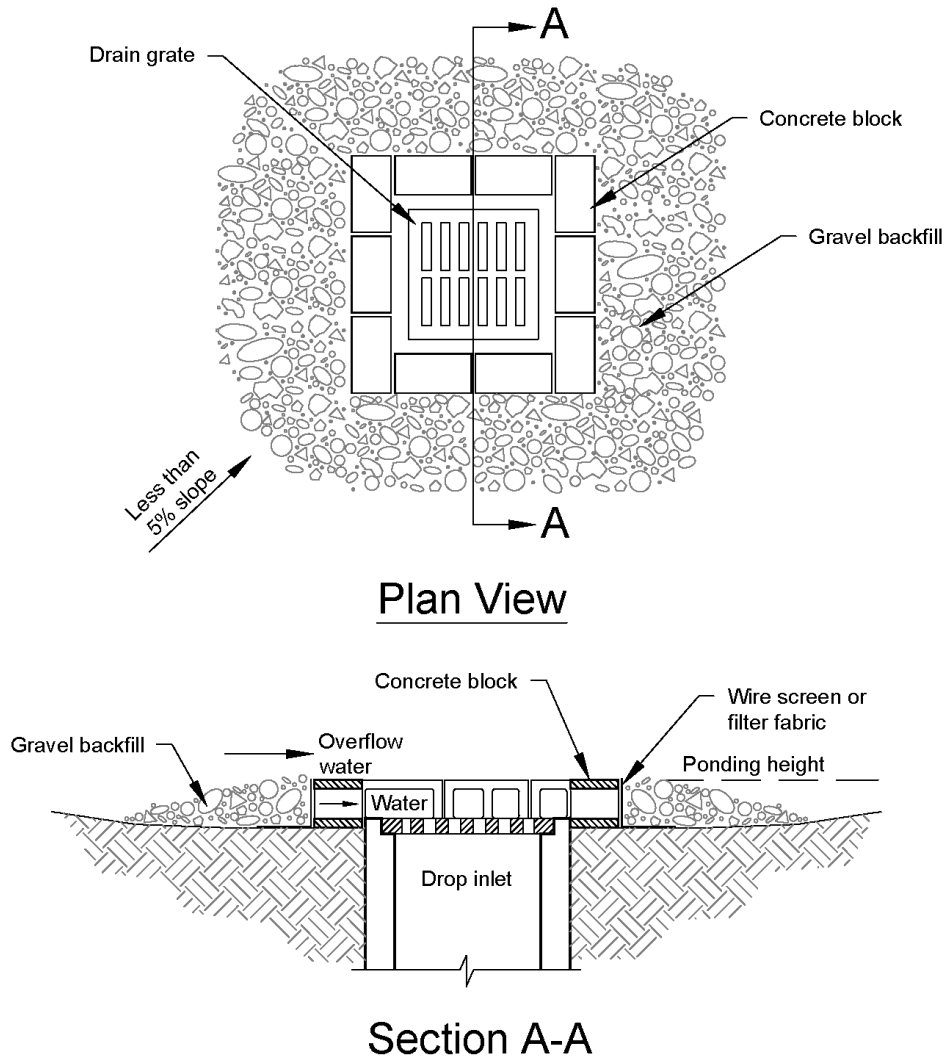

Notes:

1. Drop inlet sediment barriers are to be used for small, nearly level drainage areas. (less than 5%)
2. Excavate a basin of sufficient size adjacent to the drop inlet.
3. The top of the structure (ponding height) must be well below the ground elevation downslope to prevent runoff from bypassing the inlet. A temporary dike may be necessary on the downslope side of the structure.

NOT TO SCALE



Block and Gravel Filter

Revised June 2016

Please see <http://www.ecy.wa.gov/copyright.html> for copyright notice including permissions, limitation of liability, and disclaimer.

Gravel and Wire Mesh Filter

Gravel and wire mesh filters are gravel barriers placed over the top of the inlet. This method does not provide an overflow. Design and installation specifications for gravel and wire mesh filters include:

- Use a hardware cloth or comparable wire mesh with ½-inch openings.
 - Place wire mesh over the drop inlet so that the wire extends a minimum of 1-foot beyond each side of the inlet structure.
 - Overlap the strips if more than one strip of mesh is necessary.
- Place coarse aggregate over the wire mesh.
 - Provide at least a 12-inch depth of aggregate over the entire inlet opening and extend at least 18-inches on all sides.

Catch Basin Filters

Catch basin filters are designed by manufacturers for construction sites. The limited sediment storage capacity increases the amount of inspection and maintenance required, which may be daily for heavy sediment loads. To reduce maintenance requirements, combine a catch basin filter with another type of inlet protection. This type of inlet protection provides flow bypass without overflow and therefore may be a better method for inlets located along active rights-of-way. Design and installation specifications for catch basin filters include:

- Provides 5 cubic feet of storage.
- Requires dewatering provisions.
- Provides a high-flow bypass that will not clog under normal use at a construction site.
- Insert the catch basin filter in the catch basin just below the grating.

Curb Inlet Protection with Wooden Weir

Curb inlet protection with wooden weir is an option that consists of a barrier formed around a curb inlet with a wooden frame and gravel. Design and installation specifications for curb inlet protection with wooden weirs include:

- Use wire mesh with ½-inch openings.
- Use extra strength filter cloth.
- Construct a frame.
- Attach the wire and filter fabric to the frame.
- Pile coarse washed aggregate against the wire and fabric.
- Place weight on the frame anchors.

Block and Gravel Curb Inlet Protection

Block and gravel curb inlet protection is a barrier formed around a curb inlet with concrete blocks and gravel. See [Figure II-3.18: Block and Gravel Curb Inlet Protection](#). Design and installation specifications for block and gravel curb inlet protection include:

- Use wire mesh with ½-inch openings.
- Place two concrete blocks on their sides abutting the curb at either side of the inlet opening. These are spacer blocks.
- Place a 2x4 stud through the outer holes of each spacer block to align the front blocks.
- Place blocks on their sides across the front of the inlet and abutting the spacer blocks.
- Place wire mesh over the outside vertical face.
- Pile coarse aggregate against the wire to the top of the barrier.

Figure II-3.18: Block and Gravel Curb Inlet Protection

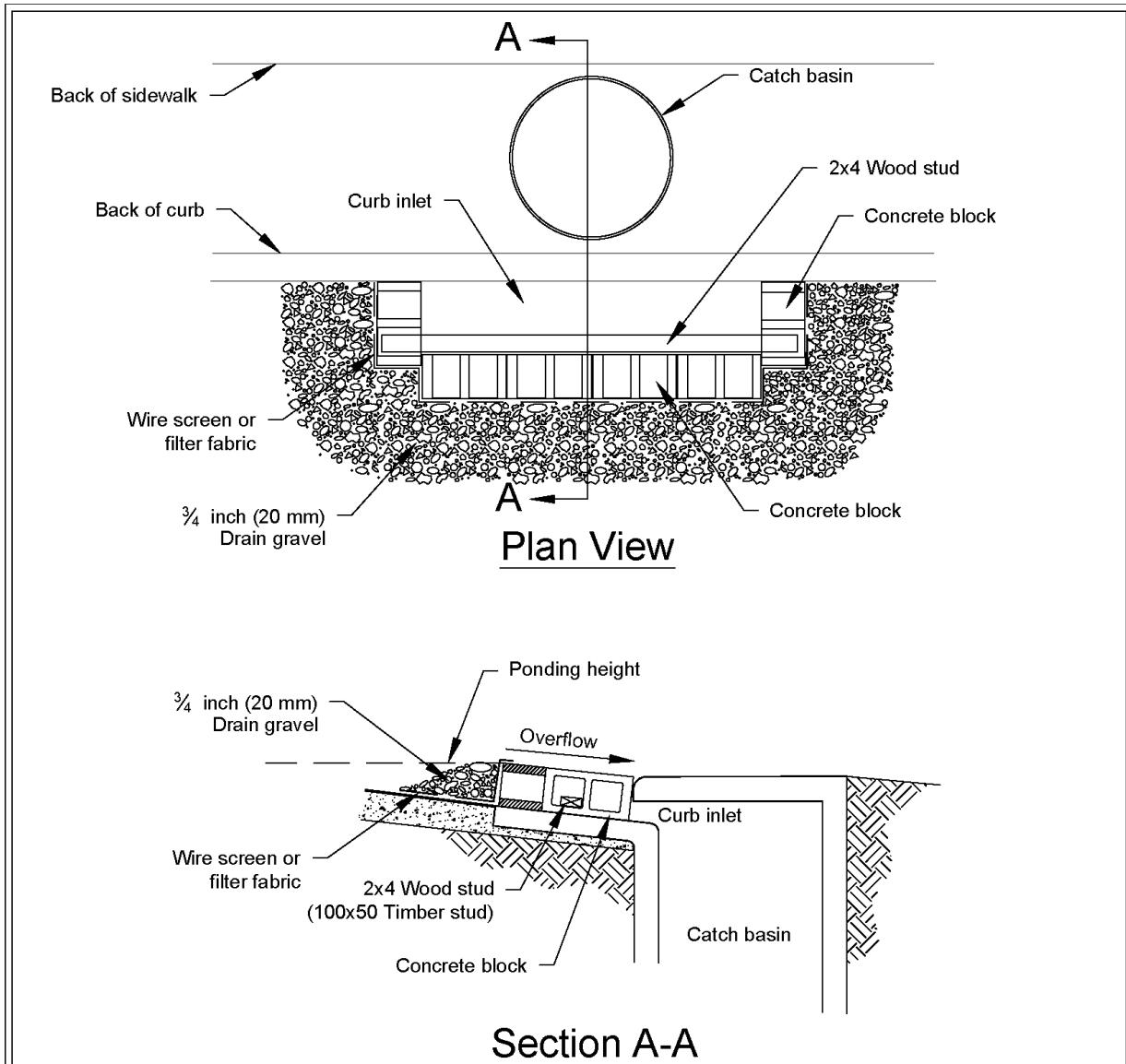

Notes:

1. Use block and gravel type sediment barrier when curb inlet is located in gently sloping street segment, where water can pond and allow sediment to separate from runoff.
2. Barrier shall allow for overflow from severe storm event.
3. Inspect barriers and remove sediment after each storm event. Sediment and gravel must be removed from the traveled way immediately.

NOT TO SCALE



Block and Gravel Curb Inlet Protection

Revised June 2016

Please see <http://www.ecy.wa.gov/copyright.html> for copyright notice including permissions, limitation of liability, and disclaimer.

Curb and Gutter Sediment Barrier

Curb and gutter sediment barrier is a sandbag or rock berm (riprap and aggregate) 3 feet high and 3 feet wide in a horseshoe shape. See [Figure II-3.19: Curb and Gutter Barrier](#). Design and installation specifications for curb and gutter sediment barrier include:

- Construct a horseshoe shaped berm, faced with coarse aggregate if using riprap, 3 feet high and 3 feet wide, at least 2 feet from the inlet.
- Construct a horseshoe shaped sedimentation trap on the upstream side of the berm. Size the trap to sediment trap standards for protecting a culvert inlet.

Figure II-3.19: Curb and Gutter Barrier

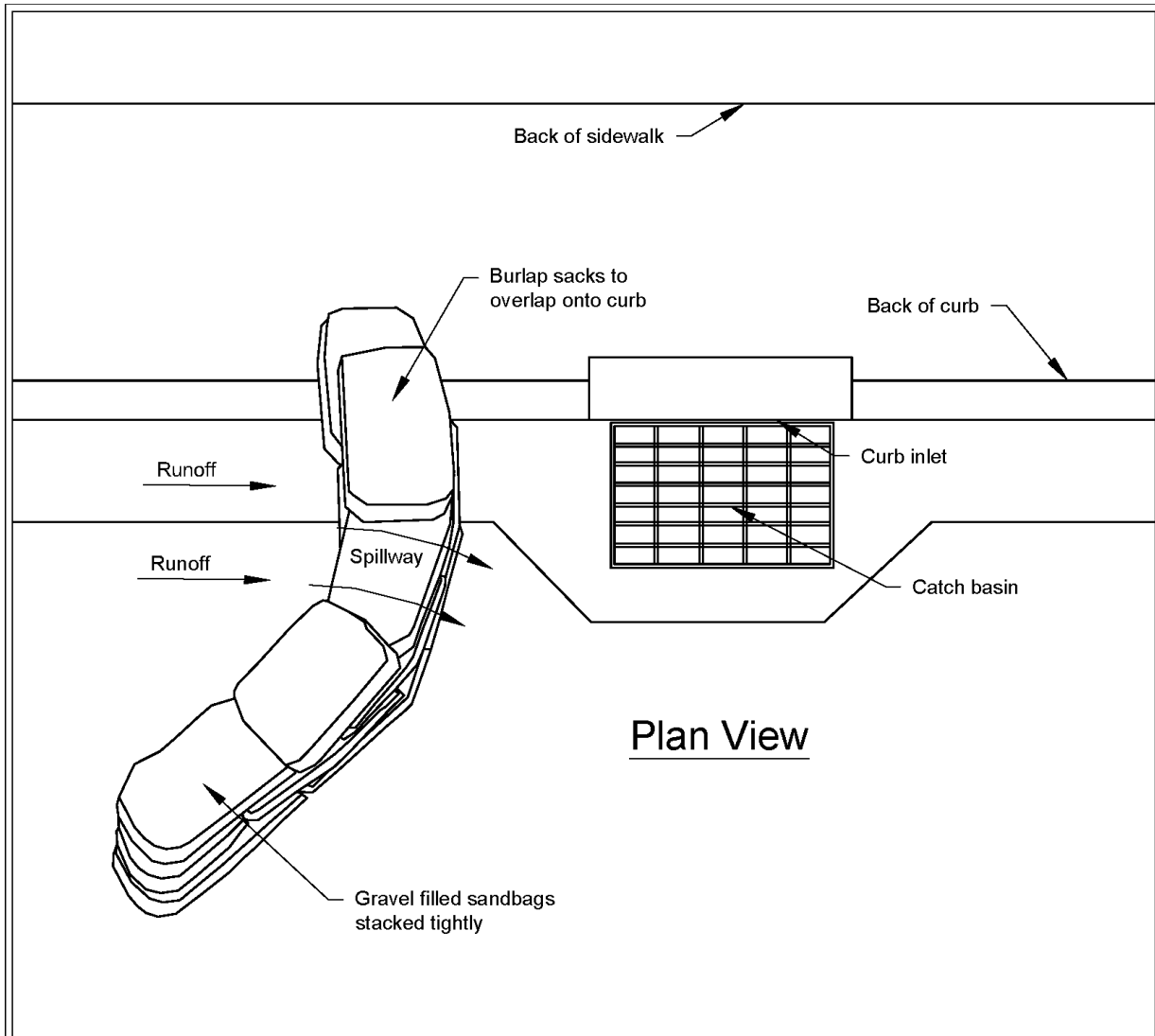

Plan View

Notes:

1. Place curb type sediment barriers on gently sloping street segments, where water can pond and allow sediment to separate from runoff.
2. Sandbags of either burlap or woven 'geotextile' fabric, are filled with gravel, layered and packed tightly.
3. Leave a one sandbag gap in the top row to provide a spillway for overflow.
4. Inspect barriers and remove sediment after each storm event. Sediment and gravel must be removed from the traveled way immediately.

NOT TO SCALE



Curb and Gutter Barrier

Revised June 2016

Please see <http://www.ecy.wa.gov/copyright.html> for copyright notice including permissions, limitation of liability, and disclaimer.

Maintenance Standards

- Inspect all forms of inlet protection frequently, especially after storm events. Clean and replace clogged catch basin filters. For rock and gravel filters, pull away the rocks from the inlet and clean or replace. An alternative approach would be to use the clogged rock as fill and put fresh rock around the inlet.
- Do not wash sediment into storm drains while cleaning. Spread all excavated material evenly over the surrounding land area or stockpile and stabilize as appropriate.

Approved as Functionally Equivalent

Ecology has approved products as able to meet the requirements of this BMP. The products did not pass through the Technology Assessment Protocol – Ecology (TAPE) process. Local jurisdictions may choose not to accept these products, or may require additional testing prior to consideration for local use. Products that Ecology has approved as functionally equivalent are available for review on Ecology's website at:

<https://ecology.wa.gov/Regulations-Permits/Guidance-technical-assistance/Stormwater-permittee-guidance-resources/Emerging-stormwater-treatment-technologies>

BMP C231: Brush Barrier

Purpose

The purpose of brush barriers is to reduce the transport of coarse sediment from a construction site by providing a temporary physical barrier to sediment and reducing the runoff velocities of overland flow.

Conditions of Use

- Brush barriers may be used downslope of disturbed areas that are less than one-quarter acre.
- Brush barriers are not intended to treat concentrated flows, nor are they intended to treat substantial amounts of overland flow. Any concentrated flows must be directed to a sediment trapping BMP. The only circumstance in which overland flow can be treated solely by a brush barrier, rather than by a sediment trapping BMP, is when the area draining to the barrier is small.
- Brush barriers should only be installed on contours.

Design and Installation Specifications

- Height: 2 feet (minimum) to 5 feet (maximum).
- Width: 5 feet at base (minimum) to 15 feet (maximum).
- Filter fabric (geotextile) may be anchored over the brush berm to enhance the filtration ability of the barrier. Ten-ounce burlap is an adequate alternative to filter fabric.

BMP C232: Gravel Filter Berm

<i>Purpose</i>	A gravel filter berm is constructed on rights-of-way or traffic areas within a construction site to retain sediment by using a filter berm of gravel or crushed rock.
<i>Conditions of Use</i>	Where a temporary measure is needed to retain sediment from rights-of-way or in traffic areas on construction sites.
<i>Design and Installation Specifications</i>	<ul style="list-style-type: none">• Berm material shall be $\frac{3}{4}$ to 3 inches in size, washed well-grade gravel or crushed rock with less than 5 percent fines.• Spacing of berms:<ul style="list-style-type: none">– Every 300 feet on slopes less than 5 percent– Every 200 feet on slopes between 5 percent and 10 percent– Every 100 feet on slopes greater than 10 percent• Berm dimensions:<ul style="list-style-type: none">– 1 foot high with 3H:1V side slopes– 8 linear feet per 1 cfs runoff based on the 10-year, 24-hour design storm
<i>Maintenance Standards</i>	<ul style="list-style-type: none">• Regular inspection is required. Sediment shall be removed and filter material replaced as needed.

BMP C233: Silt Fence

<i>Purpose</i>	Use of a silt fence reduces the transport of coarse sediment from a construction site by providing a temporary physical barrier to sediment and reducing the runoff velocities of overland flow. See Figure 4.2.12 for details on silt fence construction.
<i>Conditions of Use</i>	Silt fence may be used downslope of all disturbed areas. <ul style="list-style-type: none">• Silt fence shall prevent soil carried by runoff water from going beneath, through, or over the top of the silt fence, but shall allow the water to pass through the fence.• Silt fence is not intended to treat concentrated flows, nor is it intended to treat substantial amounts of overland flow. Convey any concentrated flows through the drainage system to a sediment pond.• Do not construct silt fences in streams or use in V-shaped ditches. Silt fences do not provide an adequate method of silt control for anything deeper than sheet or overland flow.

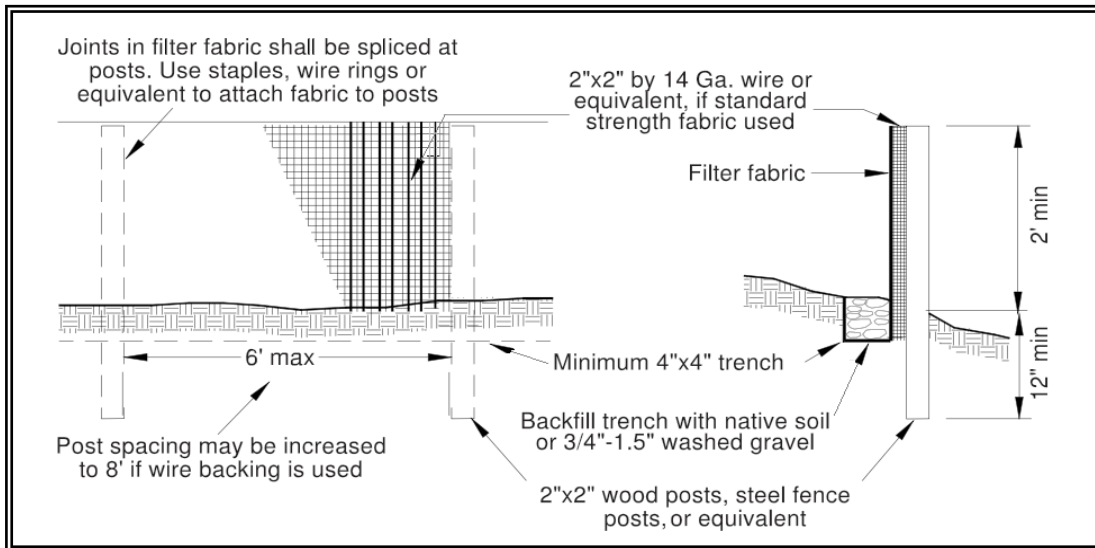

Figure 4.2.12 – Silt Fence

***Design and
Installation
Specifications***

- Use in combination with sediment basins or other BMPs.
- Maximum slope steepness (normal (perpendicular) to fence line) 1H:1V.
- Maximum sheet or overland flow path length to the fence of 100 feet.
- Do not allow flows greater than 0.5 cfs.
- The geotextile used shall meet the following standards. All geotextile properties listed below are minimum average roll values (i.e., the test result for any sampled roll in a lot shall meet or exceed the values shown in [Table 4.2.3](#)):

Table 4.2.3 Geotextile Standards	
Polymeric Mesh AOS (ASTM D4751)	0.60 mm maximum for slit film woven (#30 sieve). 0.30 mm maximum for all other geotextile types (#50 sieve). 0.15 mm minimum for all fabric types (#100 sieve).
Water Permittivity (ASTM D4491)	0.02 sec ⁻¹ minimum
Grab Tensile Strength (ASTM D4632)	180 lbs. Minimum for extra strength fabric. 100 lbs minimum for standard strength fabric.
Grab Tensile Strength (ASTM D4632)	30% maximum
Ultraviolet Resistance (ASTM D4355)	70% minimum

- Support standard strength fabrics with wire mesh, chicken wire, 2-inch x 2-inch wire, safety fence, or jute mesh to increase the strength of the fabric. Silt fence materials are available that have synthetic mesh backing attached.

- Filter fabric material shall contain ultraviolet ray inhibitors and stabilizers to provide a minimum of six months of expected usable construction life at a temperature range of 0°F. to 120°F.
- One-hundred percent biodegradable silt fence is available that is strong, long lasting, and can be left in place after the project is completed, if permitted by local regulations.
- Refer to [Figure 4.2.12](#) for standard silt fence details. Include the following standard Notes for silt fence on construction plans and specifications:
 1. The contractor shall install and maintain temporary silt fences at the locations shown in the Plans.
 2. Construct silt fences in areas of clearing, grading, or drainage prior to starting those activities.
 3. The silt fence shall have a 2-foot min. and a 2½-foot max. height above the original ground surface.
 4. The filter fabric shall be sewn together at the point of manufacture to form filter fabric lengths as required. Locate all sewn seams at support posts. Alternatively, two sections of silt fence can be overlapped, provided the Contractor can demonstrate, to the satisfaction of the Engineer, that the overlap is long enough and that the adjacent fence sections are close enough together to prevent silt laden water from escaping through the fence at the overlap.
 5. Attach the filter fabric on the up-slope side of the posts and secure with staples, wire, or in accordance with the manufacturer's recommendations. Attach the filter fabric to the posts in a manner that reduces the potential for tearing.
 6. Support the filter fabric with wire or plastic mesh, dependent on the properties of the geotextile selected for use. If wire or plastic mesh is used, fasten the mesh securely to the up-slope side of the posts with the filter fabric up-slope of the mesh.
 7. Mesh support, if used, shall consist of steel wire with a maximum mesh spacing of 2-inches, or a prefabricated polymeric mesh. The strength of the wire or polymeric mesh shall be equivalent to or greater than 180 lbs. grab tensile strength. The polymeric mesh must be as resistant to the same level of ultraviolet radiation as the filter fabric it supports.
 8. Bury the bottom of the filter fabric 4-inches min. below the ground surface. Backfill and tamp soil in place over the buried portion of the filter fabric, so that no flow can pass beneath the fence and scouring cannot occur. When wire or polymeric back-up support

mesh is used, the wire or polymeric mesh shall extend into the ground 3-inches min.

9. Drive or place the fence posts into the ground 18-inches min. A 12-inch min. depth is allowed if topsoil or other soft subgrade soil is not present and 18-inches cannot be reached. Increase fence post min. depths by 6 inches if the fence is located on slopes of 3H:1V or steeper and the slope is perpendicular to the fence. If required post depths cannot be obtained, the posts shall be adequately secured by bracing or guying to prevent overturning of the fence due to sediment loading.
 10. Use wood, steel or equivalent posts. The spacing of the support posts shall be a maximum of 6-feet. Posts shall consist of either:
 - Wood with dimensions of 2-inches by 2-inches wide min. and a 3-feet min. length. Wood posts shall be free of defects such as knots, splits, or gouges.
 - No. 6 steel rebar or larger.
 - ASTM A 120 steel pipe with a minimum diameter of 1-inch.
 - U, T, L, or C shape steel posts with a minimum weight of 1.35 lbs./ft.
 - Other steel posts having equivalent strength and bending resistance to the post sizes listed above.
 11. Locate silt fences on contour as much as possible, except at the ends of the fence, where the fence shall be turned uphill such that the silt fence captures the runoff water and prevents water from flowing around the end of the fence.
 12. If the fence must cross contours, with the exception of the ends of the fence, place gravel check dams perpendicular to the back of the fence to minimize concentrated flow and erosion. The slope of the fence line where contours must be crossed shall not be steeper than 3H:1V.
 - Gravel check dams shall be approximately 1-foot deep at the back of the fence. Gravel check dams shall be continued perpendicular to the fence at the same elevation until the top of the check dam intercepts the ground surface behind the fence.
 - Gravel check dams shall consist of crushed surfacing base course, gravel backfill for walls, or shoulder ballast. Gravel check dams shall be located every 10 feet along the fence where the fence must cross contours.
- Refer to [Figure 4.2.13](#) for slicing method details. Silt fence installation using the slicing method specifications:

1. The base of both end posts must be at least 2- to 4-inches above the top of the filter fabric on the middle posts for ditch checks to drain properly. Use a hand level or string level, if necessary, to mark base points before installation.
2. Install posts 3- to 4-feet apart in critical retention areas and 6- to 7-feet apart in standard applications.
3. Install posts 24-inches deep on the downstream side of the silt fence, and as close as possible to the filter fabric, enabling posts to support the filter fabric from upstream water pressure.
4. Install posts with the nipples facing away from the filter fabric.
5. Attach the filter fabric to each post with three ties, all spaced within the top 8-inches of the filter fabric. Attach each tie diagonally 45 degrees through the filter fabric, with each puncture at least 1-inch vertically apart. Each tie should be positioned to hang on a post nipple when tightening to prevent sagging.
6. Wrap approximately 6-inches of fabric around the end posts and secure with 3 ties.
7. No more than 24-inches of a 36-inch filter fabric is allowed above ground level.

Compact the soil immediately next to the filter fabric with the front wheel of the tractor, skid steer, or roller exerting at least 60 pounds per square inch. Compact the upstream side first and then each side twice for a total of four trips. Check and correct the silt fence installation for any deviation before compaction. Use a flat-bladed shovel to tuck fabric deeper into the ground if necessary.

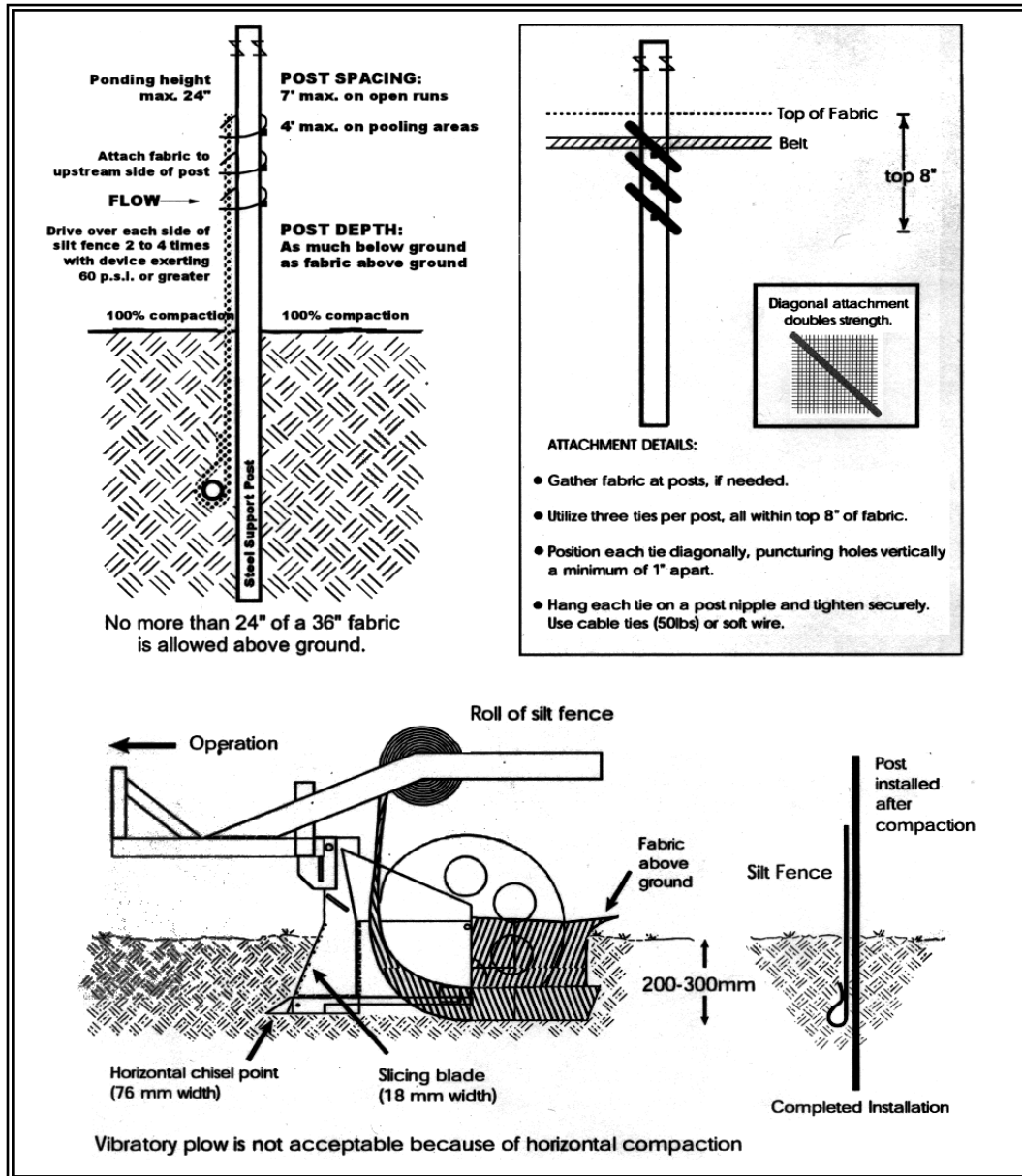

Figure 4.2.13 – Silt Fence Installation by Slicing Method

Maintenance Standards

- Repair any damage immediately.
- Intercept and convey all evident concentrated flows uphill of the silt fence to a sediment pond.
- Check the uphill side of the fence for signs of the fence clogging and acting as a barrier to flow and then causing channelization of flows parallel to the fence. If this occurs, replace the fence or remove the trapped sediment.

- Remove sediment deposits when the deposit reaches approximately one-third the height of the silt fence, or install a second silt fence.
- Replace filter fabric that has deteriorated due to ultraviolet breakdown.

BMP C234: Vegetated Strip

Purpose

Vegetated strips reduce the transport of coarse sediment from a construction site by providing a temporary physical barrier to sediment and reducing the runoff velocities of overland flow.

Conditions of Use

- Vegetated strips may be used downslope of all disturbed areas.
- Vegetated strips are not intended to treat concentrated flows, nor are they intended to treat substantial amounts of overland flow. Any concentrated flows must be conveyed through the drainage system to a sediment pond. The only circumstance in which overland flow can be treated solely by a strip, rather than by a sediment pond, is when the following criteria are met (see [Table 4.2.4](#)):

Table 4.2.4 Contributing Drainage Area for Vegetated Strips		
Average Contributing area Slope	Average Contributing area Percent Slope	Max Contributing area Flowpath Length
1.5H:1V or flatter	67% or flatter	100 feet
2H:1V or flatter	50% or flatter	115 feet
4H:1V or flatter	25% or flatter	150 feet
6H:1V or flatter	16.7% or flatter	200 feet
10H:1V or flatter	10% or flatter	250 feet

Design and Installation Specifications

- The vegetated strip shall consist of a minimum of a 25-foot flowpath length continuous strip of dense vegetation with topsoil. Grass-covered, landscaped areas are generally not adequate because the volume of sediment overwhelms the grass. Ideally, vegetated strips shall consist of undisturbed native growth with a well-developed soil that allows for infiltration of runoff.
- The slope within the strip shall not exceed 4H:1V.
- The uphill boundary of the vegetated strip shall be delineated with clearing limits.

Maintenance Standards

- Any areas damaged by erosion or construction activity shall be seeded immediately and protected by mulch.
- If more than 5 feet of the original vegetated strip width has had vegetation removed or is being eroded, sod must be installed.
- If there are indications that concentrated flows are traveling across the buffer, surface water controls must be installed to reduce the flows

entering the buffer, or additional perimeter protection must be installed.

BMP C235: Wattles

Purpose

Wattles are temporary erosion and sediment control barriers consisting of straw, compost, or other material that is wrapped in biodegradable tubular plastic or similar encasing material. They reduce the velocity and can spread the flow of rill and sheet runoff, and can capture and retain sediment. Wattles are typically 8 to 10 inches in diameter and 25 to 30 feet in length. Wattles are placed in shallow trenches and staked along the contour of disturbed or newly constructed slopes. See [Figure 4.2.14](#) for typical construction details. WSDOT Standard Plan I-30.30-00 also provides information on Wattles (<http://www.wsdot.wa.gov/Design/Standards/Plans.htm#SectionI>)

Conditions of Use

- Use wattles:
 - In disturbed areas that require immediate erosion protection.
 - On exposed soils during the period of short construction delays, or over winter months.
 - On slopes requiring stabilization until permanent vegetation can be established.
- The material used dictates the effectiveness period of the wattle. Generally, Wattles are typically effective for one to two seasons.
- Prevent rilling beneath wattles by properly entrenching and abutting wattles together to prevent water from passing between them.

Design Criteria

- Install wattles perpendicular to the flow direction and parallel to the slope contour.
- Narrow trenches should be dug across the slope on contour to a depth of 3- to 5-inches on clay soils and soils with gradual slopes. On loose soils, steep slopes, and areas with high rainfall, the trenches should be dug to a depth of 5- to 7- inches, or 1/2 to 2/3 of the thickness of the wattle.
- Start building trenches and installing wattles from the base of the slope and work up. Spread excavated material evenly along the uphill slope and compacted using hand tamping or other methods.
- Construct trenches at intervals of 10- to 25-feet depending on the steepness of the slope, soil type, and rainfall. The steeper the slope the closer together the trenches.
- Install the wattles snugly into the trenches and abut tightly end to end. Do not overlap the ends.
- Install stakes at each end of the wattle, and at 4-foot centers along entire length of wattle.

***Maintenance
Standards***

- If required, install pilot holes for the stakes using a straight bar to drive holes through the wattle and into the soil.
- Wooden stakes should be approximately 3/4 x 3/4 x 24 inches min. Willow cuttings or 3/8-inch rebar can also be used for stakes.
- Stakes should be driven through the middle of the wattle, leaving 2 to 3 inches of the stake protruding above the wattle.
- Wattles may require maintenance to ensure they are in contact with soil and thoroughly entrenched, especially after significant rainfall on steep sandy soils.

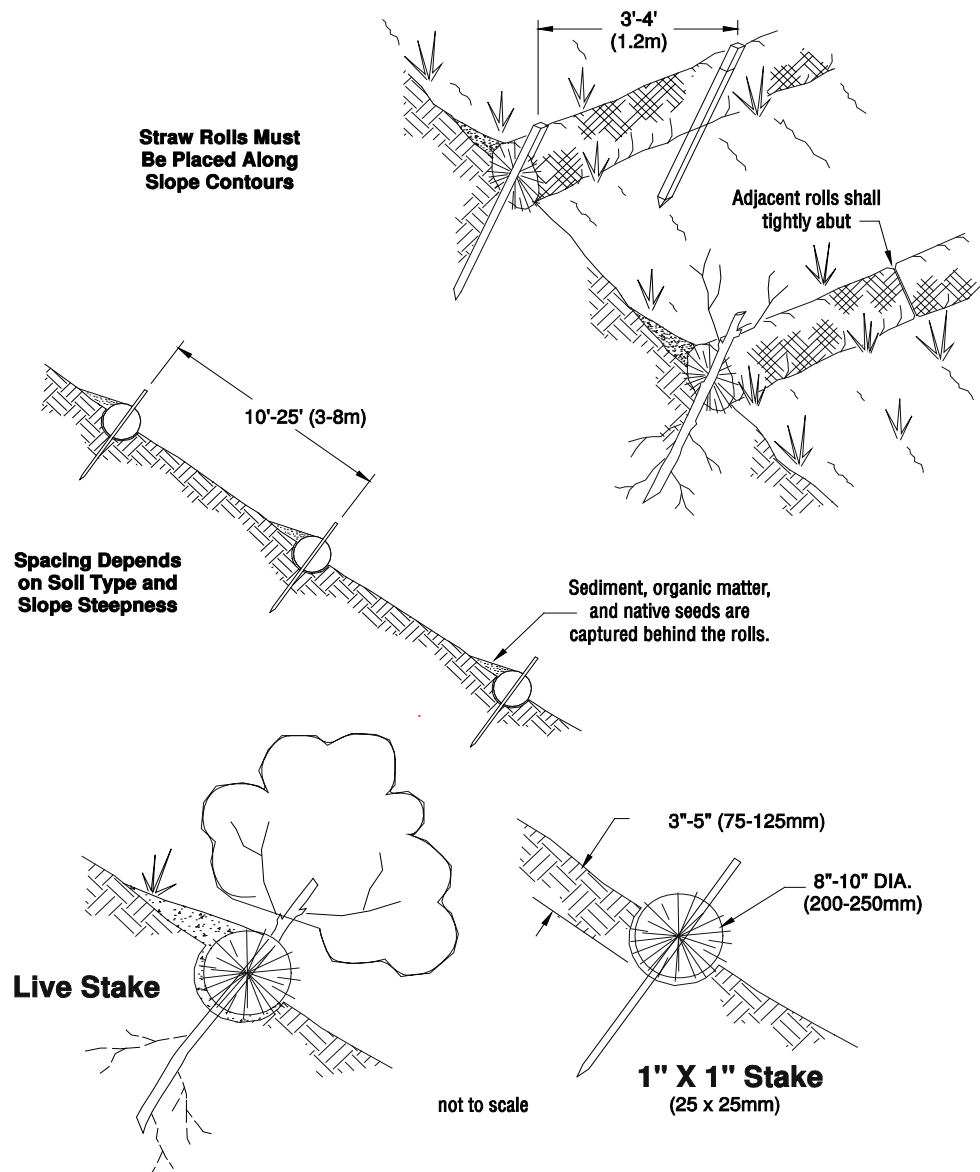

NOTE:
 1. Straw roll installation requires the placement and secure staking of the roll in a trench, 3"-5" (75-125mm) deep, dug on contour. runoff must not be allowed to run under or around roll.

Figure 4.2.14 – Wattles

- Inspect the slope after significant storms and repair any areas where wattles are not tightly abutted or water has scoured beneath the wattles.

Approved as Equivalent

Ecology has approved products as able to meet the requirements of [BMP C235](#). The products did not pass through the Technology Assessment Protocol – Ecology (TAPE) process. Local jurisdictions may choose not to accept this product approved as equivalent, or may require additional testing prior to consideration for local use. The products are available for review on Ecology’s website at <http://www.ecy.wa.gov/programs/wq/stormwater/newtech/equivalent.html>

BMP C236: Vegetative Filtration

Purpose

Vegetative Filtration may be used in conjunction with [BMP C241](#) Temporary Sediment Ponds, [BMP C206](#) Level Spreader and a pumping system with surface intake to improve turbidity levels of stormwater discharges by filtering through existing vegetation where undisturbed forest floor duff layer or established lawn with thatch layer are present. Vegetative Filtration can also be used to infiltrate dewatering waste from foundations, vaults, and trenches as long as runoff does not occur.

Conditions of Use

- For every five acre of disturbed soil use one acre of grass field, farm pasture, or wooded area. Reduce or increase this area depending on project size, ground water table height, and other site conditions.
- Wetlands shall not be used for filtration.
- Do not use this BMP in areas with a high ground water table, or in areas that will have a high seasonal ground water table during the use of this BMP.
- This BMP may be less effective on soils that prevent the infiltration of the water, such as hard till.
- Using other effective source control measures throughout a construction site will prevent the generation of additional highly turbid water and may reduce the time period or area need for this BMP.
- Stop distributing water into the vegetated area if standing water or erosion results.

Design Criteria

- Find land adjacent to the project that has a vegetated field, preferably a farm field, or wooded area.
- If the project site does not contain enough vegetated field area consider obtaining permission from adjacent landowners (especially for farm fields).
- Install a pump and downstream distribution manifold depending on the project size. Generally, the main distribution line should reach 100 to 200-feet long (many large projects, or projects on tight soil, will