

Structural Calculations for (3) Buried Detention Vault Structures

Project & Location:

Structural Calculations

Bradley Heights Detention Vaults
202 27th Avenue SE
Puyallup, WA 98373
(Lat 47.1652, Long -122.2921)

Client:

Timberlane Partners
Attn: Dave Enslow
dave@timberlanepartners.com

Professional Engineer:

Solutions 4 Structures, Inc
11605 135th St Ct E
Puyallup, WA 98374
Attn: Martin Oman, PE SE
martin@solutions4structures.com
253-514-5629

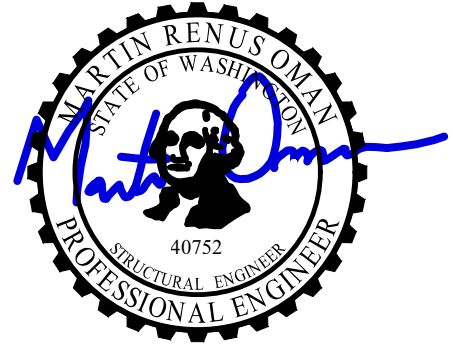

Project Number:

23.007.21

10-31-24

Code / Jurisdiction:

2021 IBC / City of Puyallup WA

Loads:

I. Vertical Loads:

Live	100 PSF
Fire Equipment	54 kips per axle

II. Soil Design Values:

Allowable Soil Bearing	= 5,500 PSF
At Rest Pressure	= 55 PCF (Above ground water)
	= 90 PCF (Below ground water)
Seismic Surcharge	= 12H

PRRWF20250237

Calculations required to be provided by
the Permittee on site for all Inspections

Bradley Heights Vaults
Puyallup, Washington
Solutions 4 Structures Job# 23.017.2.1

TABLE OF CONTENTS

Design Criteria & Loads	3 - 8
Buoyancy Checks	9 - 12
Typical Exterior Walls	13 - 36
Lid Design	37 - 41
Mat Foundation Design	42 - 54

February 10, 2022

Bradley Heights SS, LLC
1816C 11th avenue
Seattle, WA 98122

Attn: Jorden Mellergaard
(509) 899-0326
jorden@timberlanepartners.com

Geotechnical Engineering Report
Proposed Multi-Family Development
202 - 27th Avenue Southeast
Puyallup, Washington
PN: 0419036006
Doc ID: Timberlane.BradleyHeights.RG

INTRODUCTION

This *geotechnical engineering report* summarizes our site observations, subsurface explorations, laboratory testing and engineering analyses, and provides geotechnical recommendations and design criteria for the proposed multi-story, multi-family residential development to be located at 202 - 27th Avenue Southeast in the City of Puyallup within Pierce County, Washington. The development is proposed to be on one Pierce County tax parcel, numbered 0419036006. The site is currently in use as a trailer park with multiple single-family trailers and access road. The general location of the site is shown on the attached Site Location Map, Figure 1.

Our understanding of the project is based on our discussions with you, a review of the *Conceptual Site Plan* provided to us by Azure Green Consultants (attached as our Figure 2), our subsurface explorations, including those completed during our most recent December 22, 2021 site visit, and our experience in the general area.

We understand that the proposed development will include the construction of 12 multi-family residential structures and one clubhouse building. We anticipate the structures will range from one to three stories and will be supported by conventional spread footings. Additional development will include paved drive lanes and parking areas, a below-grade stormwater facility, and associated typical below grade utilities.

SCOPE

The purpose of our services was to evaluate the surface and subsurface conditions across the site as a basis for providing geotechnical recommendations and design criteria for the proposed development. Specifically, the scope of services for this project will include the following:

1. Reviewed available geological, hydrogeological, and geotechnical literature for the site area;

Complete Fill Removal

Uncontrolled fill soils and soft silt deposits encountered in the lower, western portion of the site are not a suitable bearing soil for the proposed footings. Any known locations of uncontrolled fill or uncontrolled fill encountered during grading should be removed from the building envelopes of the proposed structures. Soft silt soils in the western portion of the site can likely be mitigated through grading and placement of structural fill.

We recommend that all footing elements be supported by a minimum of 2 feet of properly placed structural fill. In areas where deeper fill removal is required the foundation elements may be deepened to extend to the base of the excavation, or the excavation may be backfilled with structural fill. After removal of the fill materials, the exposed surface should be evaluated prior to placing structural fill.

Spread Footing design

Footings should bear on properly placed and compacted structural fill as discussed in the "Complete Fill Removal" section, above. Removal of unsuitable soils below the footings should extend beyond the foundation edges 1-foot horizontally for every 1-foot of vertical excavation. Loose, soft, or other unsuitable material present at the base of the excavation should be removed prior to placement of structural fill. The soil at the base of the excavations should be protected against disturbance from weather, traffic, or other adverse conditions. The excavation should be backfilled with suitable materials as described in the "**Structural Fill**" section of this report. If Control Density Fill (CDF) is used as backfill, the horizontal extent of the excavation can be limited to 1H:2V on each side of the footing.

We recommend a minimum width of 24 inches for isolated footings and at least 18 inches for continuous wall footings. All footing elements should be embedded at least 18 inches below grade for frost protection. For footing bearing surfaces prepared as described in the "Complete Fill Removal" we recommend using an allowable soil bearing capacity of 2,000 psf (pounds per square foot) for design. These values are for combined dead and long-term live loads. The weight of the footing and any overlying backfill may be neglected. The allowable bearing value may be increased by one-third for transient loads such as those induced by seismic events or wind loads.

Lateral loads may be resisted by friction on the base of footings and floor slabs and as passive pressure on the sides of footings. We recommend that an allowable coefficient of friction of 0.35 be used to calculate friction between the concrete and the underlying structural fill. Passive pressure may be determined using an allowable equivalent fluid density of 300 pcf (pounds per cubic foot). Factors of safety have been applied to these values.

We estimate that settlements of footings designed and constructed as recommended will be less than 1 inch, for the anticipated load conditions, with differential settlements between comparably loaded footings of ½ inch or less. Most of the settlements should occur essentially as loads are being applied; however, disturbance of the foundation subgrade during construction could result in larger settlements than estimated.

Floor Slab Support

We anticipate that the lower level of the structures will consist of a slab-on-grade floor. Slab-on-grade floors should be supported on medium dense native soils or on structural fill prepared as

TABLE 2:
APPROXIMATE DEPTHS AND ELEVATIONS OF GROUNDWATER ENCOUNTERED IN EXPLORATIONS

Well ID	Depth to Seasonal High Groundwater (feet)	Seasonal High Elevation of Groundwater (feet)	Date Observed
MW-1	17	361	February 23, 21
MW-2	17	383	January 13, 21
MW-3	NE	NE	NA

Notes: NE = Not encountered NA = Not applicable

ENGINEERING CONCLUSIONS AND RECOMMENDATIONS

Based on the results of our data review, site reconnaissance, subsurface explorations and our experience in the area, it is our opinion that the site is suitable for the proposed multi-family development. Pertinent conclusions and geotechnical recommendations regarding the design and construction of the proposed multi-family development are presented below.

Seismic Design

The site is located in the Puget Sound region of western Washington, which is seismically active. Seismicity in this region is attributed primarily to the interaction between the Pacific, Juan de Fuca and North American plates. The Juan de Fuca plate is subducting beneath the North American plate at the Cascadia Subduction Zone (CSZ). This produces both intercrustal (between plates) and intracrustal (within a plate) earthquakes. In the following sections we discuss the design criteria and potential hazards associated with the regional seismicity.

Seismic Site Class

Based on our observations and the subsurface units mapped at the site, we interpret the structural site conditions to correspond to a seismic Site Class "C" in accordance with the 2018 IBC documents and American Society of Civil Engineers (ASCE) standard 7-16 Chapter 20 Table 20.3-1. This is based on the reviewed range of SPT (Standard Penetration Test) blow counts for the soil types in the site area. These conditions were assumed to be representative for the subsurface conditions for the site.

Design parameters

The U.S. Geological Survey (USGS) completed probabilistic seismic hazard analyses (PSHA) for the entire country in November 1996, which were updated and republished in 2002 and 2008. We used the *ATC Hazard by Location* website to estimate seismic design parameters at the site. Table 4, below, summarizes the recommended design parameters.

A soil drainage zone should extend horizontally at least 18 inches from the back of the wall. The drainage zone should also extend from the base of the wall to within 1 foot of the top of the wall. The soil drainage zone should be compacted to approximately 90 percent of the maximum dry density (MDD), as determined in accordance with ASTM D: 1557. Over-compaction should be avoided as this can lead to excessive lateral pressures on the wall. A geocomposite drain mat may also be used instead of free draining soils, provided it is installed in accordance with the manufacturer's instructions.

Below Grade Vaults

The proposed below grade vault should be designed to resist the static and dynamic lateral earth pressures presented in the **"Subgrade/Basement Walls"** section of this report. We recommend the proposed vault be completely waterproofed (exterior of foundation walls and underside of slab) to prevent water intrusion. The walls and floor slabs associated with these structures should be designed to resist the lateral and uplift forces associated with maximum estimated seasonal high groundwater levels. We recommend using a soil unit weight of 130 pcf to calculate vertical forces acting on the vault lid, base extensions, or anti-flotation slabs.

Temporary Excavations

All job site safety issues and precautions are the responsibility of the contractor providing services/work. The following cut/fill slope guidelines are provided for planning purposes only. Temporary cut slopes will likely be necessary during grading operations or utility installation. All excavations at the site associated with confined spaces, such as utility trenches and retaining walls, must be completed in accordance with local, state, or federal requirements including Washington Administrative Code (WAC) and Washington Industrial Safety and Health Administration (WISHA). Excavation, trenching, and shoring is covered under WAC 296-155 Part N.

Based on WAC 296-155-66401, it is our opinion that the glaciolacustrine recessional outwash soils on the site would be classified as Type C soils, while the underlying glacial till would be classified as Type A soils. For temporary excavations of less than 20 feet in depth, the side slopes in Type C soils should be sloped at a maximum inclination of 1½ H:1V or flatter from the toe to top of the slope; while side slopes in Type A soils should be sloped at a maximum inclination of ¾H:1V or flatter from the toe to top of the slope. All exposed slope faces should be covered with a durable reinforced plastic membrane during construction to prevent slope raveling and rutting during periods of precipitation. These guidelines assume that all surface loads are kept at a minimum distance of at least one half the depth of the cut away from the top of the slope and that significant seepage is not present on the slope face. Flatter cut slopes will be necessary where significant raveling or seepage occurs, if construction materials will be stockpiled along the slope crest, or if construction traffic will be routed along the slope crest.

Where it is not feasible to slope the site soils back at these inclinations, shoring will be required. All shoring for the project should incorporate applicable criteria presented in the **"Subgrade/Basement Walls"** section of this report into the design. Settlement of the ground surface can occur behind shoring during excavation. The amount of settlement depends heavily on the type of shoring system, the contractor's workmanship, and soil conditions. Accordingly, we recommend that structures in the vicinity of the planned shoring installation be reviewed with regard to foundation support and tolerance to settlement.

From: [Martin Oman](#)
To: [Martin Oman](#)
Subject: RE: Bradley Heights - groundwater
Date: Tuesday, September 17, 2024 9:00:49 AM
Attachments: [image002.png](#)

Martin-

While looking into other conditions, I came across this from the final DRT letter and just wanted to make sure you had these requirements for loading:

Submit With Civil Permit Application: At the time of civil application, provide supporting documentation that each vault located in a drive aisle can support the full weight of the fire truck apparatus (54,000lb axle load/77,000lb total weight); and a 23,000lb (includes 20% F.S.) outrigger point load anywhere on the storm facility. Provide any manufacturer's conditions/restrictions associated with the imposed loading.

Rob Trivitt, P.E.

Azure|Green Consultants, LLC
Off: 253.770.3144

From: Martin Oman <martin@solutions4structures.com>

Sent: Wednesday, September 11, 2024 8:47 AM

To: Rob Trivitt <rob@mailagc.com>; Seth Mattos <SethM@georesources.us>; Eric Heller <EricH@georesources.us>

Cc: Tom Chase <tom@solutions4structures.com>

Subject: RE: Bradley Heights - groundwater

Rob,

We're working away on the vaults from the lid down (= perimeter walls and foundations).

For the lid we have a few things to run past you:

1. We need to confirm that the spans vs. bury depths are feasible (see the attached pdf)
2. Let's have an early discussion about the manhole locations and 5'x10' access openings.

Can you give me a call at some point this week?

Martin Oman PE SE
Principal



(253) 514-5629 Cell
www.solutions4structures.com

From: [Eric Heller](#)
To: [Martin Oman](#); [Seth Mattos](#); [Rob Trivitt](#)
Cc: [Tom Chase](#)
Subject: RE: Bradley Heights - groundwater
Date: Friday, September 20, 2024 11:49:27 AM
Attachments: [image003.png](#)
[image004.png](#)

Martin

We can provide an allowable bearing pressure of up to 5,500psf at a depth of 20 feet for the vault mat. This value can be linearly interpolated.

For the submerged lateral earth pressure, we would recommend using a value of 90pcf for the at-rest condition.

Let us know if you need anything else
Eric

Eric W. Heller, PE, LG
Senior Geotechnical Engineer
Office: 253.896.1011
Mobile: 253.831.3611
4809 Pacific Hwy. E.
Fife, WA 98424
www.georesources.rocks



From: Martin Oman <martin@solutions4structures.com>
Sent: Thursday, September 19, 2024 8:46 AM
To: Seth Mattos <SethM@georesources.us>; Rob Trivitt <rob@mailagc.com>; Eric Heller <EricH@georesources.us>
Cc: Tom Chase <tom@solutions4structures.com>
Subject: RE: Bradley Heights - groundwater

CAUTION: This email originated from outside your organization. Exercise caution when opening attachments or clicking links, especially from unknown senders.

Checking in...

Any thoughts about the Qs below? We're trying to finalize our designs and move toward wrapping up our submittal docs.

JOB# 23.007.21

DESIGNED MRO DATE 10-24-24

PROJECT: BRADLEY HTS VAULTS

HYDROSTATIC DESIGN

$$\text{UPLIFT PRESSURE} = 62.4 \text{ PCF} \times \text{DISPLACED VOLUME}$$

- CHECK GLOBAL RESISTANCE TO BOUYANCY UPLIFT
- DESIGN PERIMETER WALLS WITH SUBMERGED PRESSURES
- DESIGN FOUNDATION INCLUDING UPLIFT PRESSURES

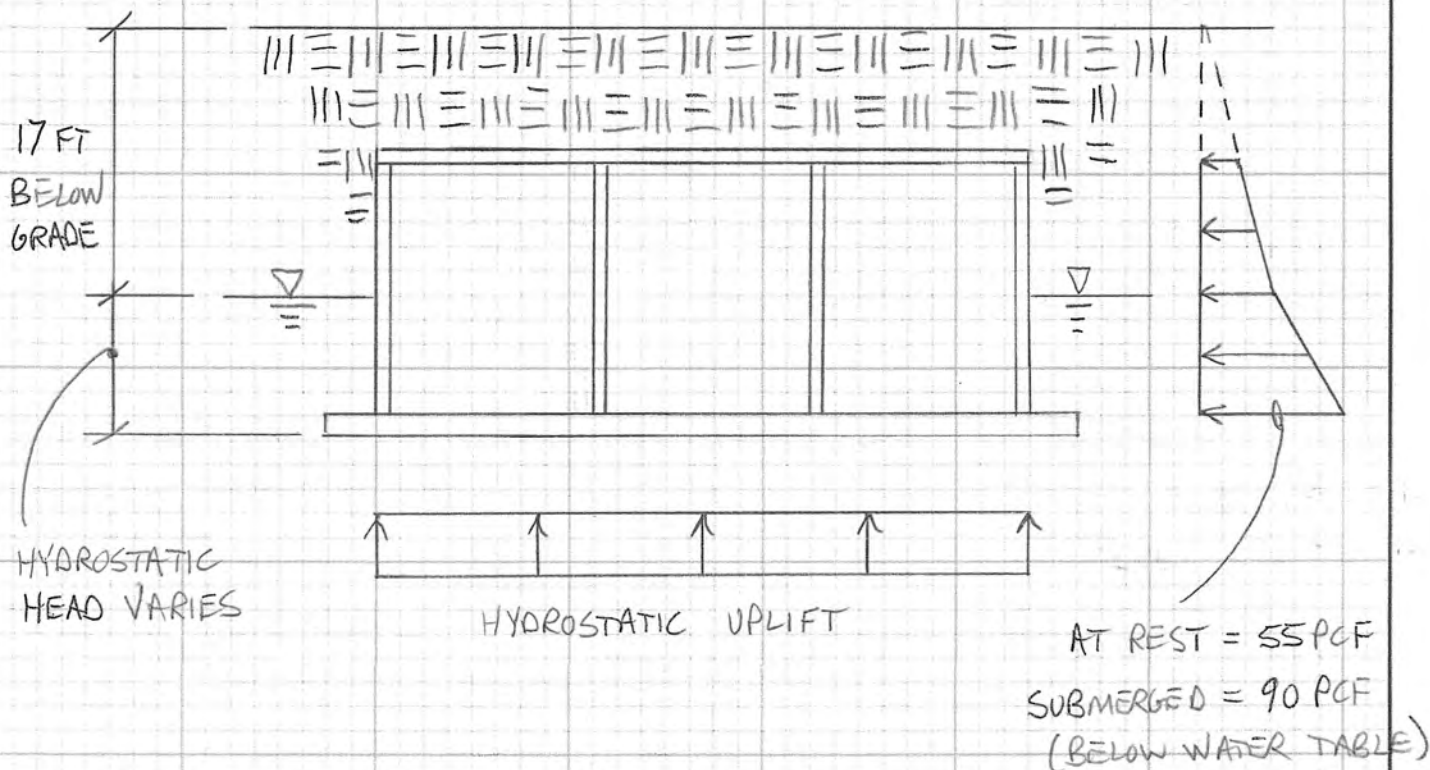

Vault Bouyancy Analysis

Project: Bradley Heights
 S4S Job# 23.007.1
 Vault ID #2

Plan Dimensions

Length **92.00** ft
 Cells **3**
 Width Ea **16.50** ft
 Width 52.83 ft

Elevations

GSE	Min Ground Surface	388.00 ft	Max Soil Cover	5.89 ft
TOW	Top of Walls	381.07 ft	Max Wall Ht	10.00 ft
GWE	Max Design Groundwater	379.50 ft	Max Bouyancy Ht	9.43 ft
TOF	Top of Footing	371.07 ft		

Th	Wall Thicknesses	12 in
T	Footing Thickness	12 in
TOE	Footing Toe	1.00 ft
DSD	Design Soil Density	130 pcf
SSD	Submerged Soil Density	67.6 pcf
FB	Foam Backfill	0.0 ft

Lid Area	4,966 ft ²
Ftg Area	5,264 ft ²
Toe Area	298 ft ²
Perimeter Lw	290 ft
Interior Lw	184 ft

Dead Loads

Soil Cover	3,801,645 lbs
HC Planks	417,172 lbs
Conc Walls	618,500 lbs
Footing	789,600 lbs
Backfill	498,552 lbs
	<hr/> 6,125,470 lbs

Bouyancy Loads

Displaced Volume	47,130 ft ³
Bouyancy Uplift	2,940,924 lbs

Factor of Safety = 2.08

Vault Bouyancy Analysis

Project: Bradley Heights
 S4S Job# 23.007.1
 Vault ID #3

Plan Dimensions

Length **140.00** ft
 Cells **2**
 Width Ea **16.00** ft
 Width 35.33 ft

Elevations

GSE	Max Ground Surface	397.00 ft	Max Soil Cover	9.12 ft
TOW	Top of Walls	384.34 ft	Avg Wall Ht	11.50 ft
GWE	Max Design Groundwater	383.00 ft	Avg Bouyancy Ht	11.16 ft
TOF	Top of Footing	372.84 ft		

Th	Wall Thicknesses	16 in
T	Footing Thickness	12 in
TOE	Footing Toe	1.00 ft
DSD	Design Soil Density	130 pcf
SSD	Submerged Soil Density	67.6 pcf
FB	Foam Backfill	2.5 ft

Lid Area	5,041 ft ²
Ftg Area	5,401 ft ²
Toe Area	360 ft ²
Perimeter Lw	351 ft
Interior Lw	140 ft

Dead Loads

Soil Cover	5,975,386 lbs
HC Planks	423,435 lbs
Conc Walls	967,533 lbs
Footing	810,133 lbs
Backfill	902,454 lbs
	<hr/>
	9,078,941 lbs

Bouyancy Loads

Displaced Volume	56,616 ft ³
Bouyancy Uplift	3,532,858 lbs

Factor of Safety = 2.57

Vault Bouyancy Analysis

Project: Bradley Heights
 S4S Job# 23.007.1
 Vault ID #4

Plan Dimensions

Length **140.00** ft
 Cells **3**
 Width Ea **18.50** ft
 Width 59.50 ft

Elevations

GSE	Max Ground Surface	408.50 ft	Max Soil Cover	6.46 ft
TOW	Top of Walls	398.50 ft	Avg Wall Ht	12.00 ft
GWE	Design Groundwater	396.50 ft	Avg Bouyancy Ht	11.00 ft
TOF	Top of Footing	386.50 ft		

Th	Wall Thicknesses	16 in
T	Footing Thickness	12 in
TOE	Footing Toe	1.00 ft
DSD	Design Soil Density	130 pcf
SSD	Submerged Soil Density	67.6 pcf
	Foam Backfill	2.5 ft

Lid Area	8,489 ft ²
Ftg Area	8,897 ft ²
Toe Area	408 ft ²
Perimeter Lw	399 ft
Interior Lw	280 ft

Dead Loads

Soil Cover	7,126,943 lbs
HC Planks	713,048 lbs
Conc Walls	1,293,600 lbs
Footing	1,334,550 lbs
Backfill	913,033 lbs
	<hr/> 11,381,174 lbs

Bouyancy Loads

Displaced Volume	93,784 ft ³
Bouyancy Uplift	5,852,101 lbs

Factor of Safety = 1.94

JOB # 23-007.21
 DESIGNED MRO DATE 10-24-24
 PROJECT: BRADLEY HTS - VAULTS

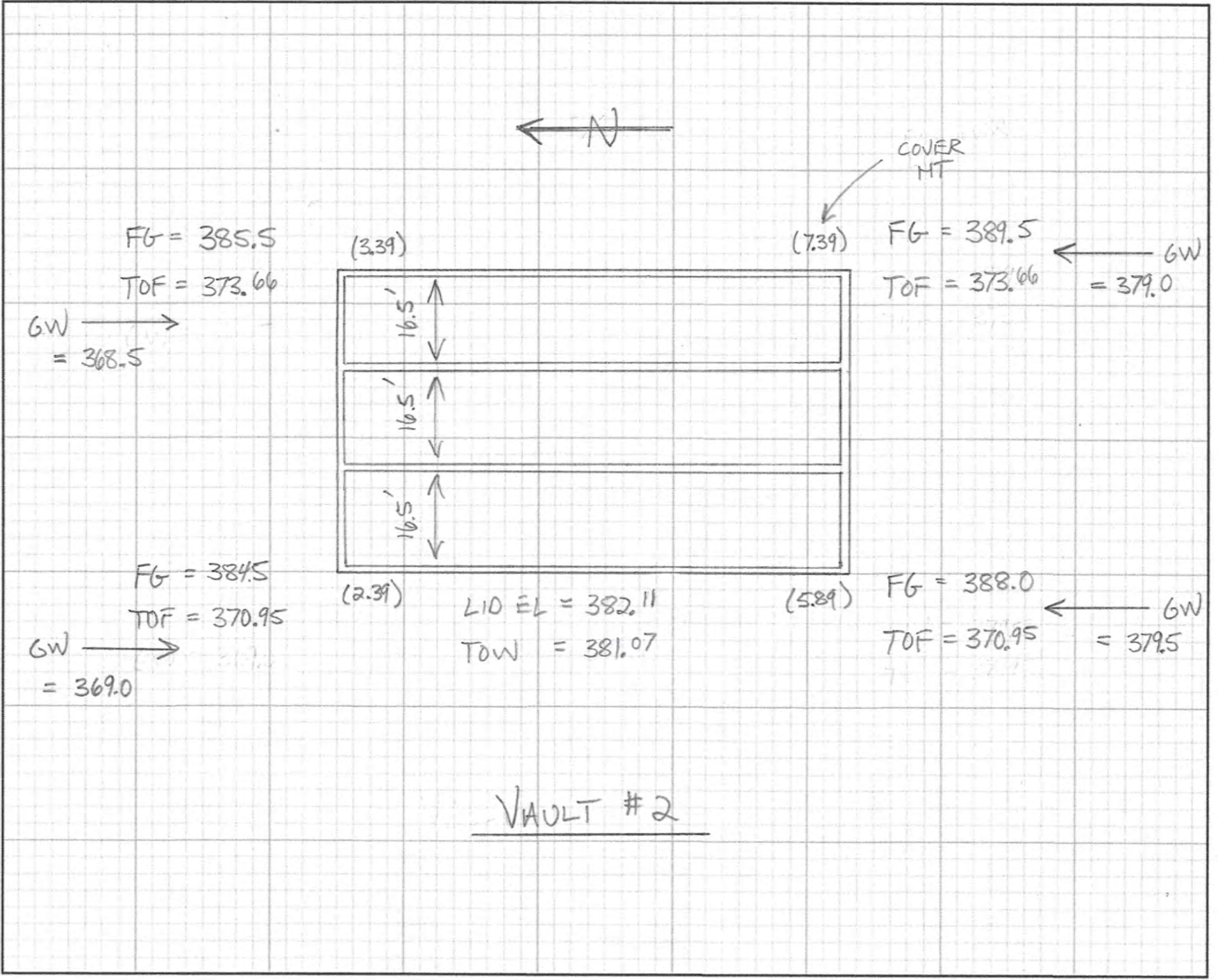

JOB # 23.007.21

DESIGNED MRO DATE 10-24-24

PROJECT: BRADLEY HTS VAULTS

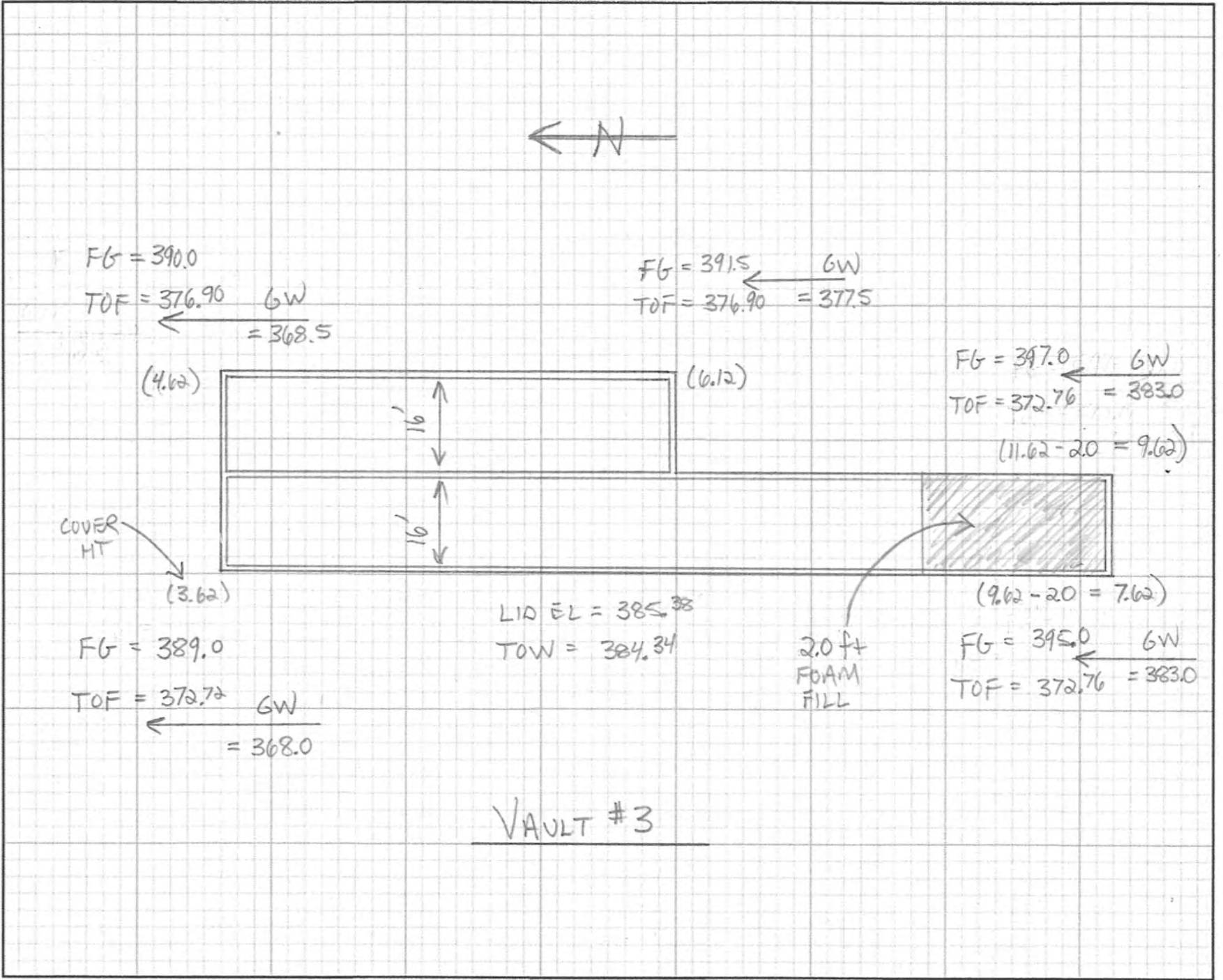

JOB # 23.007.21

DESIGNED MRO DATE 10-24-24

PROJECT: BRADLEY HTS - VAULTS

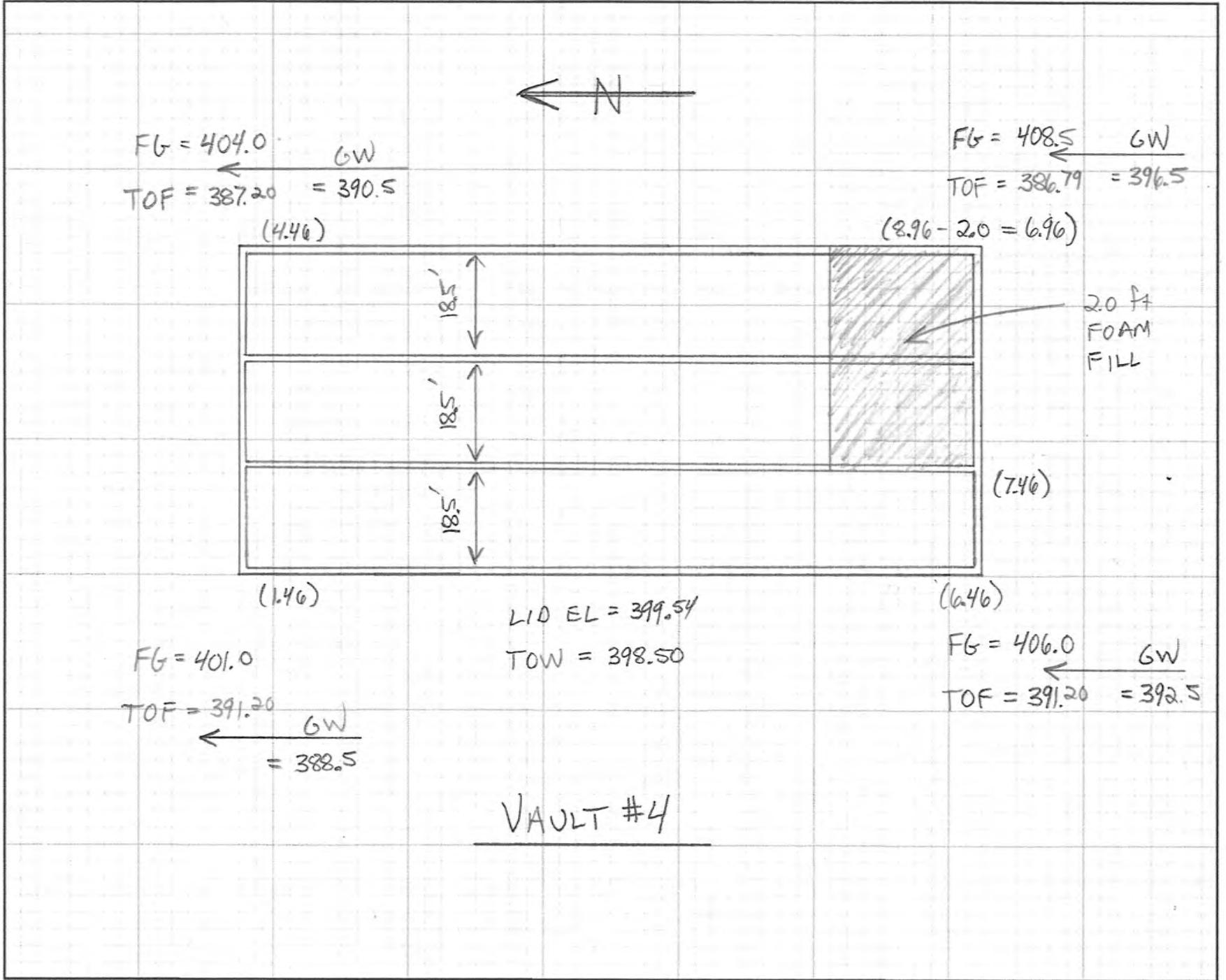

Bradley Heights Vaults

S4S Job# 23.007.21

Exterior Concrete Walls

Vault	Corner	Wall Ht	Plank Depth	Wall Thickness	FG	TOW	GW	TOF	
#2	NE	7.5	3.39	8"	385.5	381.07	368.5	373.57	
	SE	7.5	7.39	8"	389.5	381.07	379.0	373.57	<---
	NW	10.0	2.39	10"	384.5	381.07	369.0	371.07	
	SW	10.0	5.89	10"	388.0	381.07	379.5	371.07	<---
#3	NE	7.5	4.62	8"	390.0	384.34	368.5	376.84	
	SE	11.5	11.62	14"	397.0	384.34	383.0	372.84	<---
	NW	11.5	3.62	12"	389.0	384.34	368.0	372.84	
	SW	11.5	9.62	14"	395.0	384.34	383.0	372.84	
#4	NE	11.5	4.46	12"	404.0	398.50	390.5	387.00	<---
	SE	12.0	8.96	14"	408.5	398.50	396.5	386.50	
	NW	7.5	1.46	8"	401.0	398.50	388.5	391.00	
	SW	7.5	6.46	8"	406.0	398.50	392.5	391.00	

VAULT WALL DESIGN

8" WALLS

CONTROLLING LOCATION = VAULT #2 SE CORNER

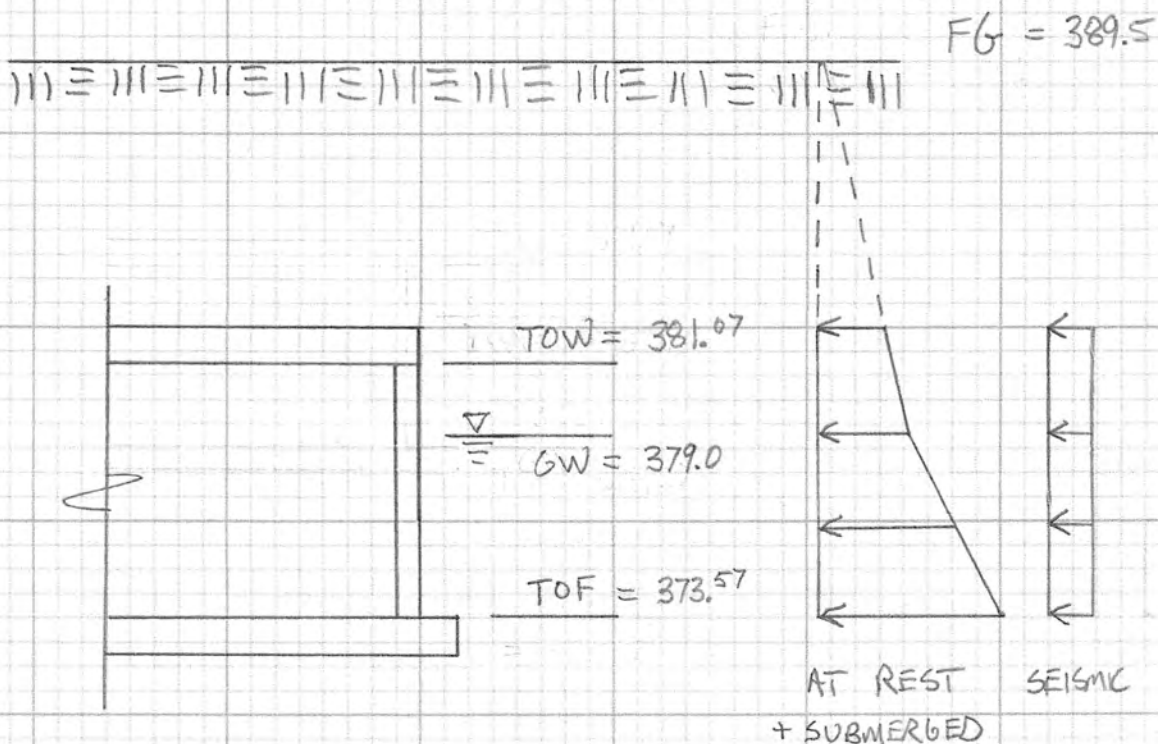

DESIGN SOIL PRESSURES

$$TOW = 1.6(55)(8.43) + 12(7.5) = 832 \text{ PSF}$$

$$GW = 832 + 1.6(55)(2.07) = 1,014 \text{ PSF}$$

$$TOF = 1,014 + 1.6(90)(5.43) = 1,796 \text{ PSF}$$

Description:

Bradley Heights Vaults
S4S Job# 21.007.21

8" Walls

Units: English

Properties - X = feet, E = ksi, I = in⁴
X = 0; E = 3605; I = 512;

Moment Releases - X = feet

Supports - X = feet, Displacement = inches, Rotation = radians
X = 0; Disp = 0;
X = 7.5; Disp = 0;

Springs - X = feet, VSpring = kip/inch, RSpring = kip in/rad

Point Loads - X = feet, PLoad = kips, Moment = kip ft

Uniform Loads - XStart & XEnd = feet, UStart & UEnd = kip/ft
XStart = 0; XEnd = 2.07; UStart = -0.832; UEnd = -1.014;
/At Rest + Seismic
XStart = 2.07; XEnd = 7.5; UStart = -1.014; UEnd = -1.796;
/At Rest + Submerged + Seismic

Reactions - kips, kip ft

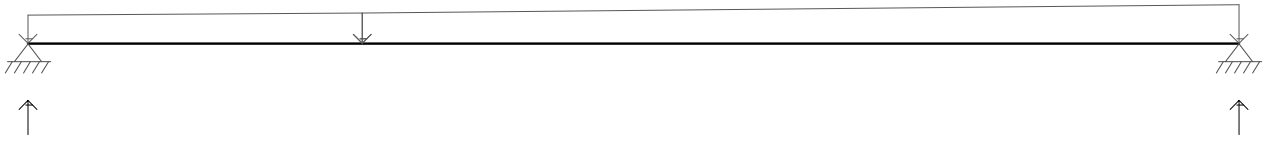

Shear - kips

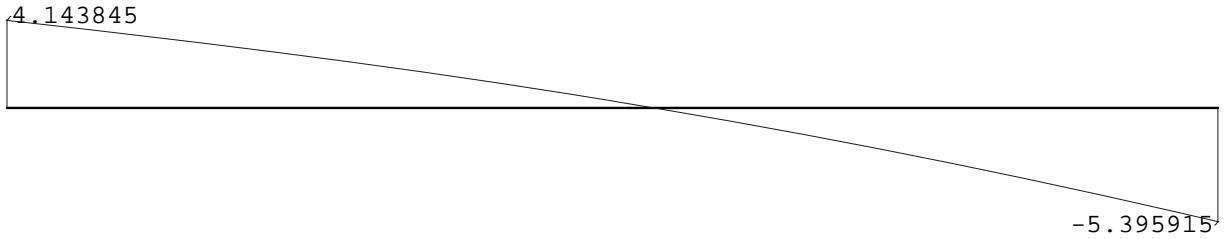

Moment - kip ft

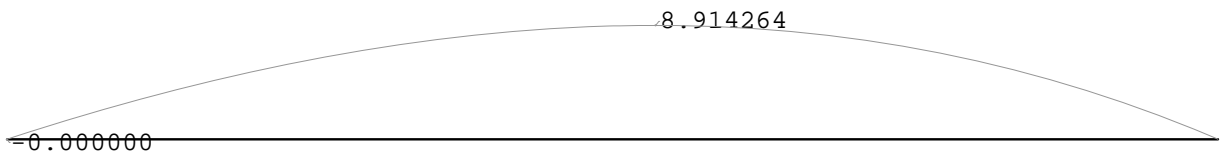

Rotation - radians

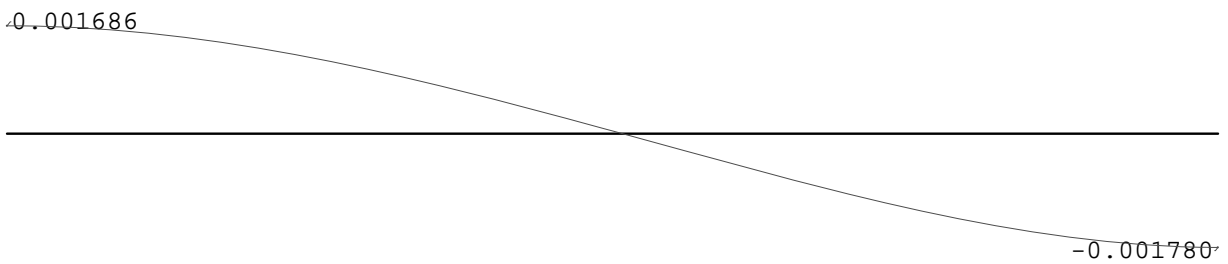

Deflection - inches

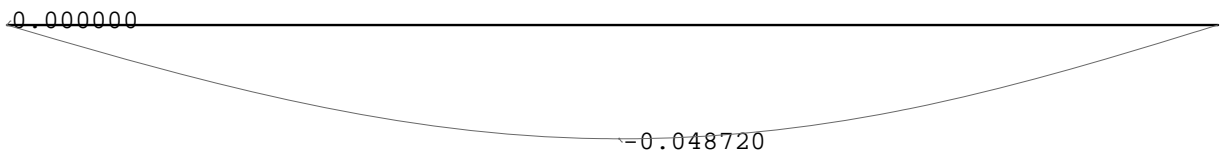

Analysis Data:

Beam Length = 7.5 feet
 Number of Nodes = 201
 Number of Elements = 200
 Number of Degrees of Freedom = 402

Reactions:

X feet	Vert kips	Rot kip ft
0	4.144	
7.500	5.396	

Equilibrium:

	Force	Reaction	Diff
Vert	-9.540	9.540	0.000 kips
Rot	40.469	-40.469	0.000 kip ft

Min & Max values:

Min Shear	=	-5.396 kips	at	7.500 feet
Max Shear	=	4.144 kips	at	0 feet
Min Moment	=	-1.396e-013 kip ft	at	0 feet
Max Moment	=	8.914 kip ft	at	4.017 feet
Min Rotation	=	-0.00178 radians	at	7.500 feet
Max Rotation	=	0.001686 radians	at	0 feet
Min Deflection	=	-0.048720 in	at	3.793 feet
Max Deflection	=	0 in	at	0 feet

JOB # 23.007.21DESIGNED MRO DATE 10-24-24PROJECT: BRADLEY HTS VAULTS

8" WALL DESIGN

$$H = 7.5 \text{ ft}$$

$$\text{MAX } V_u = 5.40 \text{ K (See Output)}$$

$$\phi V_c = 0.75(2) \sqrt{4000} (12) (5.6875) = 6.47 \text{ K } \checkmark$$

$$\phi V_s = 0.75(0.6)(60)(.31)(12/10) = 10.0 \text{ K } \checkmark$$

$$\text{MAX } M_u = 8.91 \text{ Kft (See Output)}$$

$$A_s = \#5 @ 10" = 0.372$$

$$a = \frac{.372(60)}{.85(4)(12)} = 0.547 \text{ in}$$

$$\phi M_n = 0.9 (.372)(60) \left(5.6875 - \frac{.547}{2} \right) / 12 = 9.06 \text{ Kft } \checkmark$$

VAULT WALL DESIGN

10" WALLS

CONTROLLING LOCATION = VAULT #2 SW CORNER

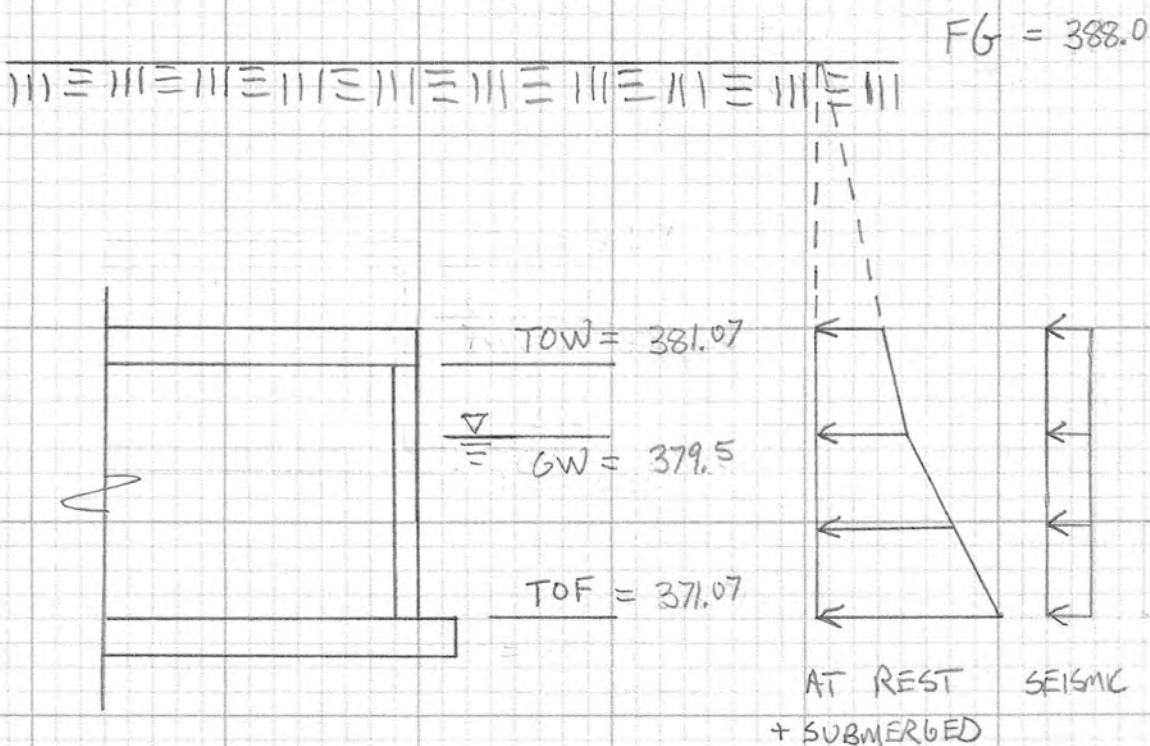

DESIGN SOIL PRESSURES

$$TOW = 1.6(55)(6.93) + 12(10.0) = 730 \text{ PSF}$$

$$GW = 730 + 1.6(55)(1.57) = 868 \text{ PSF}$$

$$TOF = 868 + 1.6(90)(8.43) = 2,082 \text{ PSF}$$

Description:

Bradley Heights Vaults
S4S Job# 21.007.21

10" Walls

Units: English

Properties - X = feet, E = ksi, I = in⁴
X = 0; E = 3605; I = 1000;

Moment Releases - X = feet

Supports - X = feet, Displacement = inches, Rotation = radians
X = 0; Disp = 0;
X = 10; Disp = 0;

Springs - X = feet, VSpring = kip/inch, RSpring = kip in/rad

Point Loads - X = feet, PLoad = kips, Moment = kip ft

Uniform Loads - XStart & XEnd = feet, UStart & UEnd = kip/ft
XStart = 0; XEnd = 1.57; UStart = -0.730; UEnd = -0.868;
/At Rest + Seismic
XStart = 1.57; XEnd = 10; UStart = -0.868; UEnd = -2.082;
/At Rest + Submerged + Seismic

Reactions - kips, kip ft

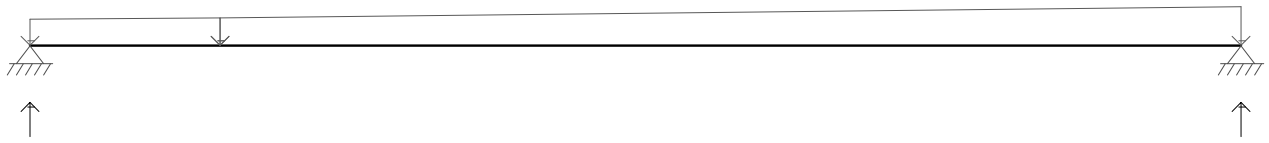

Shear - kips

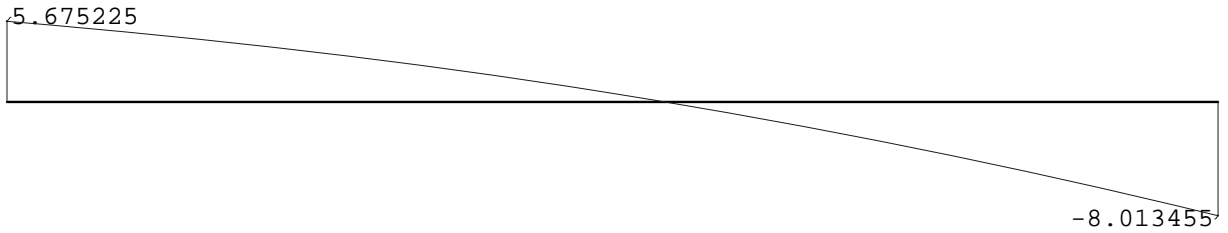

Moment - kip ft

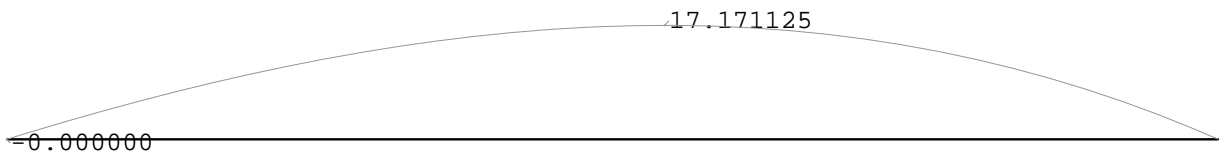

Rotation - radians

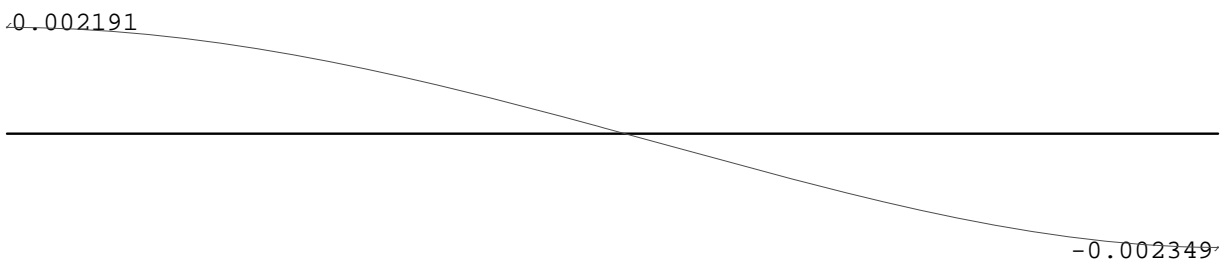

Deflection - inches

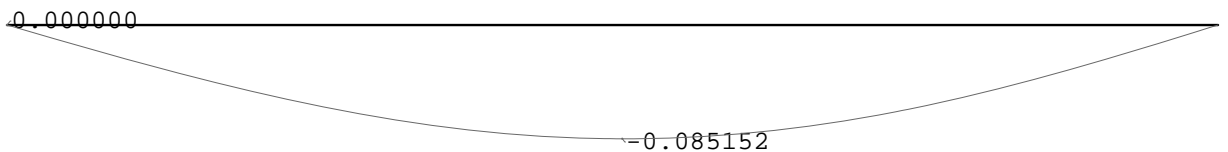

Analysis Data:

Beam Length = 10. feet
 Number of Nodes = 201
 Number of Elements = 200
 Number of Degrees of Freedom = 402

Reactions:

X feet	Vert kips	Rot kip ft
0	5.675	
10.000	8.013	

Equilibrium:

	Force	Reaction	Diff
Vert	-13.689	13.689	0.000 kips
Rot	80.135	-80.135	0.000 kip ft

Min & Max values:

Min Shear	=	-8.013 kips	at	10.000 feet
Max Shear	=	5.675 kips	at	0 feet
Min Moment	=	-9.675e-014 kip ft	at	0 feet
Max Moment	=	17.171 kip ft	at	5.434 feet
Min Rotation	=	-0.002349 radians	at	10.000 feet
Max Rotation	=	0.002191 radians	at	0 feet
Min Deflection	=	-0.085152 in	at	5.082 feet
Max Deflection	=	0 in	at	0 feet

JOB# 23.007.21DESIGNED MRO DATE 10-24-24PROJECT: BRADLEY HTS VAULTS

10" WALL DESIGN

$$H = 10.0 \text{ ft}$$

$$\text{MAX } V_u = 8.01 \text{ K} \text{ (See Output)}$$

$$\phi V_c = 0.75(2) \sqrt{4000} (12) (7.6875) = 8.75 \text{ K} \checkmark$$

$$\phi V_s = 0.75(0.6)(60)(.31)(12)(1+) = 8.37 \text{ K} \checkmark$$

$$\text{MAX } M_u = 17.2 \text{ Kft} \text{ (See Output)}$$

$$A_s = \begin{array}{l} \#5 @ 12" = 0.31 \\ + \#4 @ 12" = 0.20 \\ \hline 0.51 \text{ in}^2 \end{array}$$

$$a = \frac{.51(60)}{.85(4)(12)} = 0.750 \text{ in}$$

$$\phi M_n = 0.9(.51)(60) \left(7.6875 - \frac{.750}{2} \right) / 12 = 16.8 \text{ Kft}$$

WITHIN 2%

JOB # 23.007.021

DESIGNED MRO DATE 10-24-24

PROJECT: BRADLEY HTS VAULTS

VAULT WALL DESIGN

12" WALLS

CONTROLLING LOCATION = VAULT #4 NE CORNER

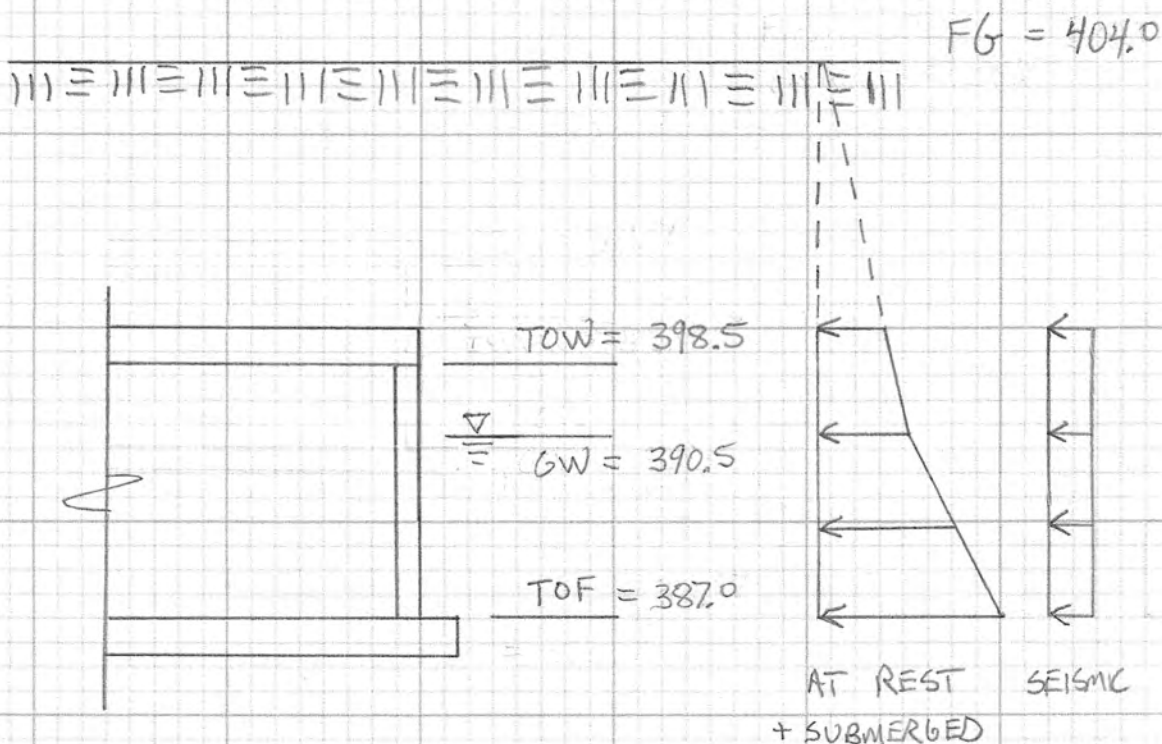

DESIGN SOIL PRESSURES

$$TOW = 1.6(55)(5.50) + 12(11.5) = 622 \text{ PSF}$$

$$GW = 622 + 1.6(55)(8.0) = 1,326 \text{ PSF}$$

$$TOF = 1,326 + 1.6(90)(3.5) = 1,830 \text{ PSF}$$

Description:

Bradley Heights Vaults
S4S Job# 21.007.21

12" Walls

Units: English

Properties - X = feet, E = ksi, I = in⁴
X = 0; E = 3605; I = 1728;

Moment Releases - X = feet

Supports - X = feet, Displacement = inches, Rotation = radians
X = 0; Disp = 0;
X = 11.5; Disp = 0;

Springs - X = feet, VSpring = kip/inch, RSpring = kip in/rad

Point Loads - X = feet, PLoad = kips, Moment = kip ft

Uniform Loads - XStart & XEnd = feet, UStart & UEnd = kip/ft
XStart = 0; XEnd = 8; UStart = -0.622; UEnd = -1.326;
/At Rest + Seismic
XStart = 8; XEnd = 11.5; UStart = -1.326; UEnd = -1.830;
/At Rest + Submerged + Seismic

Reactions - kips, kip ft

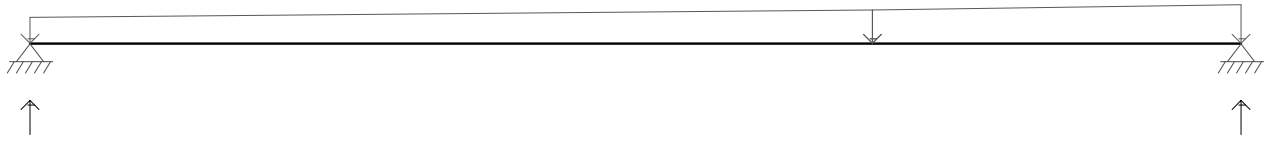

Shear - kips

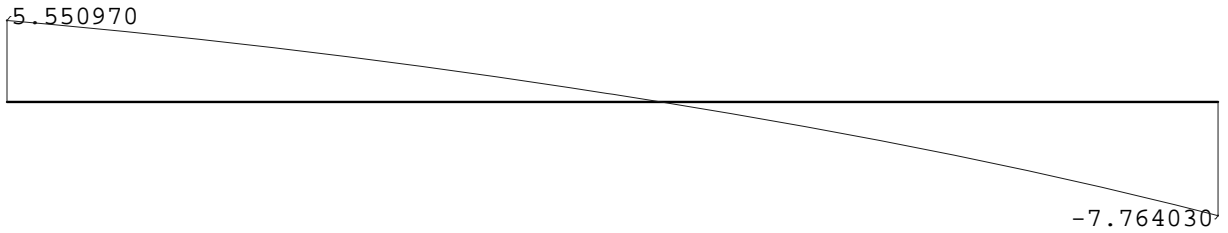

Moment - kip ft

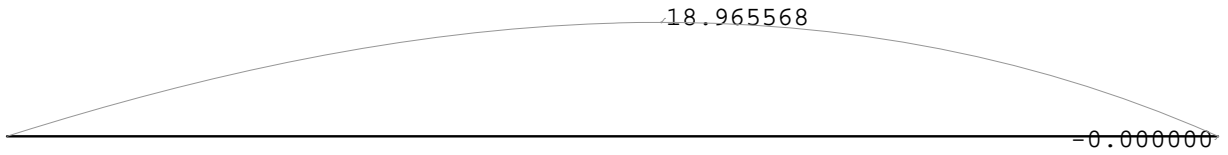

Rotation - radians

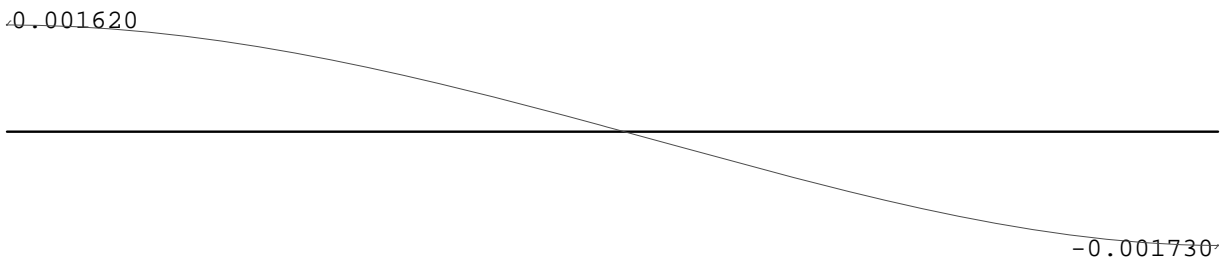

Deflection - inches

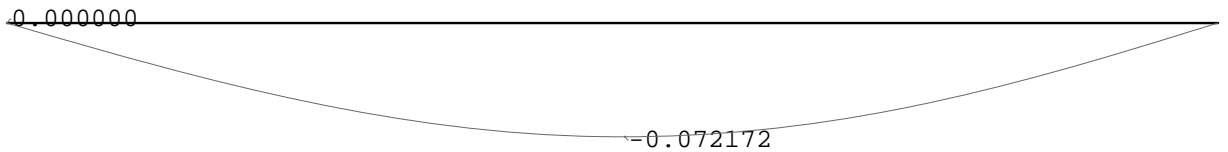

Analysis Data:

Beam Length = 11.5 feet
 Number of Nodes = 201
 Number of Elements = 200
 Number of Degrees of Freedom = 402

Reactions:

X feet	Vert kips	Rot kip ft
0	5.551	
11.500	7.764	

Equilibrium:

	Force	Reaction	Diff
Vert	-13.315	13.315	-0.000 kips
Rot	89.286	-89.286	0.000 kip ft

Min & Max values:

Min Shear	=	-7.764 kips	at	11.500 feet
Max Shear	=	5.551 kips	at	0 feet
Min Moment	=	-1.895e-012 kip ft	at	11.500 feet
Max Moment	=	18.966 kip ft	at	6.216 feet
Min Rotation	=	-0.00173 radians	at	11.500 feet
Max Rotation	=	0.001620 radians	at	0 feet
Min Deflection	=	-0.072172 in	at	5.871 feet
Max Deflection	=	0 in	at	0 feet

JOB# 23.007.21DESIGNED MRO DATE 10-24-24PROJECT: BRADLEY HTS VAULTS

12" WALL DESIGN

$$H = 11.5 \text{ ft}$$

$$\text{MAX } V_u = 7.76 \text{ K (See Output)}$$

$$\phi V_c = 0.75(2) \sqrt{4000} (12) (9.6875) = 11.0 \text{ K } \checkmark$$

$$\phi V_s = 0.75(0.6)(60)(.31)(12/12) = 8.37 \text{ K } \checkmark$$

$$\text{MAX } M_u = 19.0 \text{ Kft (See Output)}$$

$$\begin{aligned} A_s &= \#5 @ 12" = 0.31 \\ &+ \#4 @ 12" = 0.20 \\ &\quad \underline{\hspace{1.5cm}} \\ &\quad \quad \quad 0.51 \text{ in}^2 \end{aligned}$$

$$a = \frac{.51(60)}{.85(4)(12)} = 0.750 \text{ in}$$

$$\phi M_n = 0.9(.51)(60)(9.6875 - \frac{.750}{2})/12 = 21.4 \text{ Kft } \checkmark$$

JOB# 23.007.21

DESIGNED MRO DATE 10-24-24

PROJECT: BRADLEY HTS VAULTS

VAULT WALL DESIGN

14" WALLS

CONTROLLING LOCATION = VAULT #3 SE CORNER

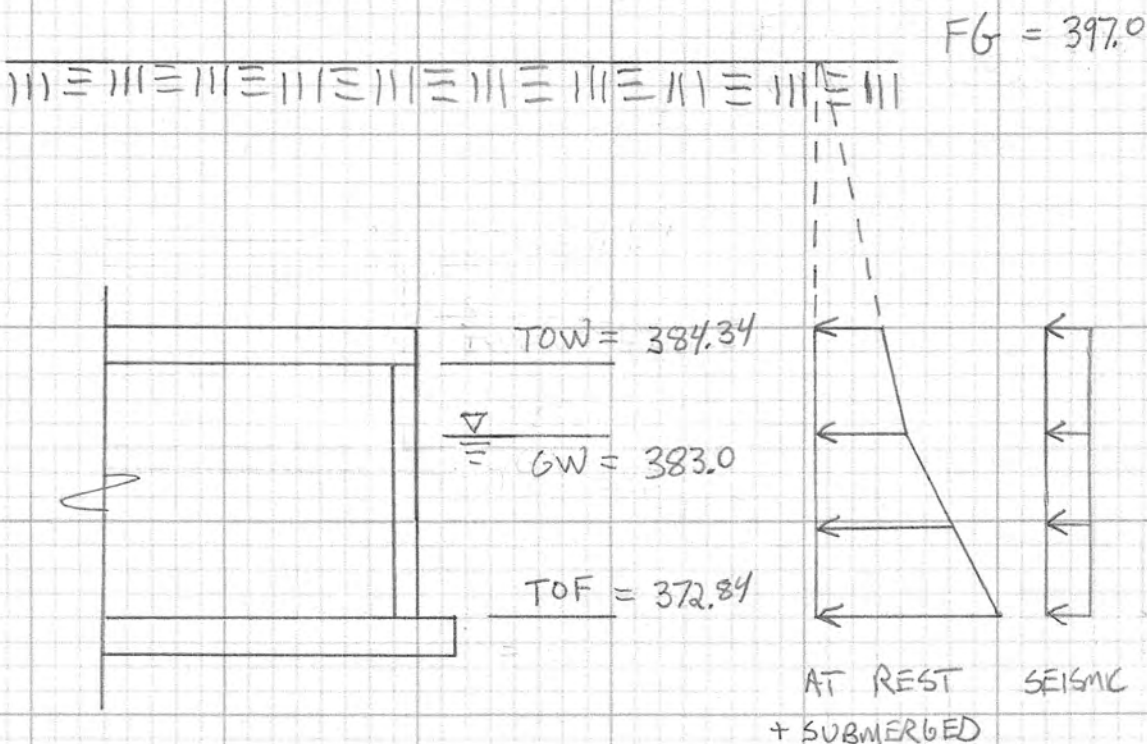

DESIGN SOIL PRESSURES

$$TOW = 1.6(55)(12.66) + 12(11.5) = 1,252 \text{ PSF}$$

$$GW = 1,252 + 1.6(55)(1.34) = 1,370 \text{ PSF}$$

$$TOF = 1,370 + 1.6(90)(10.16) = 2,833 \text{ PSF}$$

Description:

Bradley Heights Vaults
S4S Job# 21.007.21

14" Walls

Units: English

Properties - X = feet, E = ksi, I = in⁴
X = 0; E = 3605; I = 2744;

Moment Releases - X = feet

Supports - X = feet, Displacement = inches, Rotation = radians
X = 0; Disp = 0;
X = 11.5; Disp = 0;

Springs - X = feet, VSpring = kip/inch, RSpring = kip in/rad

Point Loads - X = feet, PLoad = kips, Moment = kip ft

Uniform Loads - XStart & XEnd = feet, UStart & UEnd = kip/ft
XStart = 0; XEnd = 1.34; UStart = -1.252; UEnd = -1.370;
/At Rest + Seismic
XStart = 1.34; XEnd = 11.5; UStart = -1.370; UEnd = -2.833;
/At Rest + Submerged + Seismic

Reactions - kips, kip ft

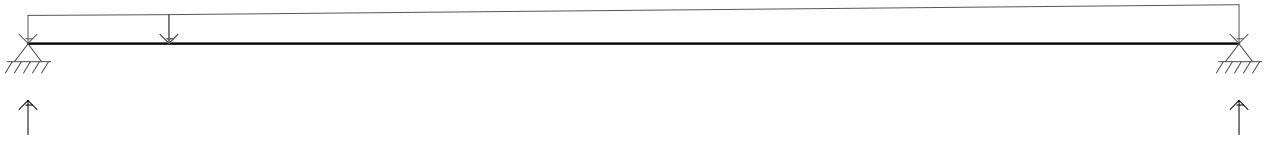

Shear - kips

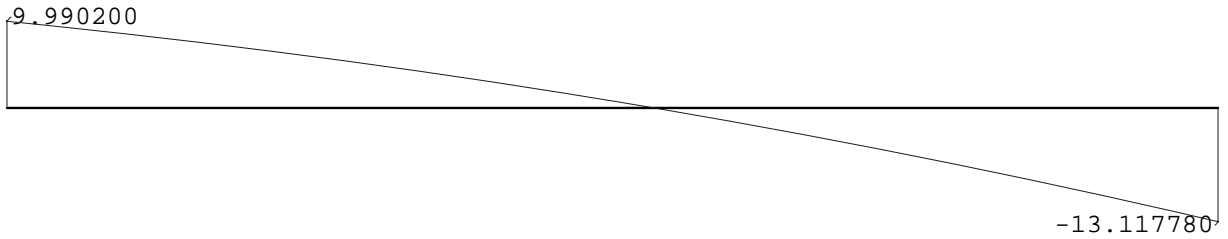

Moment - kip ft

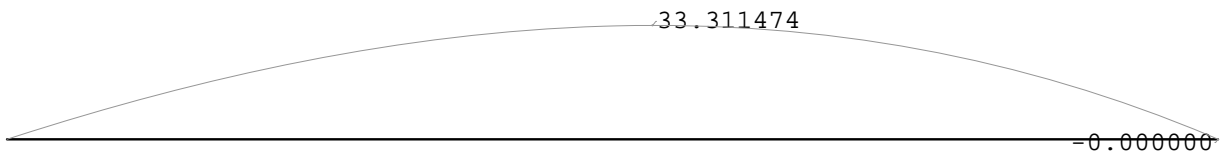

Rotation - radians

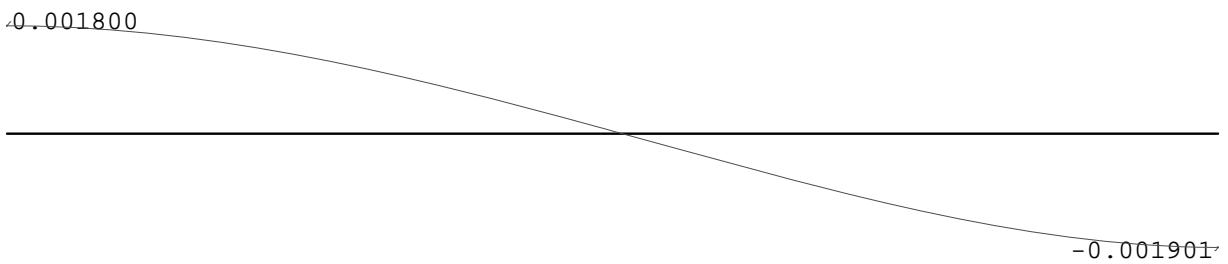

Deflection - inches

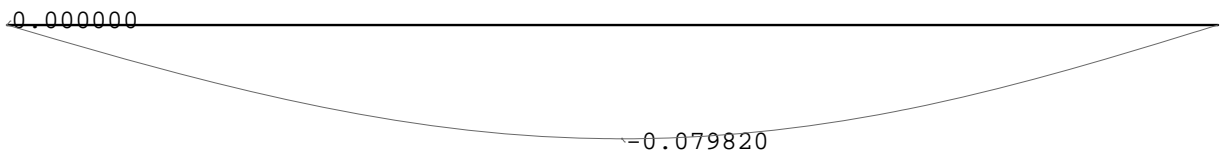

Analysis Data:

Beam Length = 11.5 feet
 Number of Nodes = 201
 Number of Elements = 200
 Number of Degrees of Freedom = 402

Reactions:

X feet	Vert kips	Rot kip ft
0	9.990	
11.500	13.118	

Equilibrium:

	Force	Reaction	Diff
Vert	-23.108	23.108	0.000 kips
Rot	150.855	-150.854	0.000 kip ft

Min & Max values:

Min Shear	=	-13.118 kips	at	11.500 feet
Max Shear	=	9.990 kips	at	0 feet
Min Moment	=	-8.506e-013 kip ft	at	11.500 feet
Max Moment	=	33.311 kip ft	at	6.131 feet
Min Rotation	=	-0.001901 radians	at	11.500 feet
Max Rotation	=	0.001800 radians	at	0 feet
Min Deflection	=	-0.079820 in	at	5.843 feet
Max Deflection	=	0 in	at	0 feet

JOB# 23.007.21DESIGNED MRO DATE 10-24-24PROJECT: BRADLEY HTS VAULTS

14" WALL DESIGN

$$H = 11.5 \text{ ft}$$

$$\text{MAX } V_u = 13.1 \text{ K (See Output)}$$

$$\phi V_c = 0.75(2) \sqrt{4000} (12) (11.6875) = 13.3 \text{ K } \checkmark$$

$$\begin{aligned} \phi V_s &= \frac{0.75(0.6)(60)(.31)(12/17)}{0.75(0.6)(60)(.31)(12/18)} = \frac{8.37}{5.58} \\ &= 14.0 \text{ K } \checkmark \end{aligned}$$

$$\text{MAX } M_u = 33.3 \text{ Kft (See Output)}$$

$$\begin{aligned} A_s &= \#5 @ 12" = 0.31 \\ &+ \#5 @ 12" = 0.31 \\ &\quad \quad \quad \underline{\quad \quad \quad} \\ &\quad \quad \quad 0.62 \text{ in}^2 \end{aligned}$$

$$a = \frac{.62(60)}{.85(4)(12)} = 0.912 \text{ in}$$

$$\phi M_n = 0.9(.62)(60)(11.6875 - \frac{.912}{2}) / 12 = 31.3 \text{ Kft}$$

WITHIN $6\frac{9}{16}$

JOB# 23,007.21DESIGNED MRO DATE 10-24-24PROJECT: BRADLEY HTS VAULTSVAULT LID DESIGN

LID = 12 1/2 HOLLOWCORE PLANKS

DESIGNED BY SUPPLIER

DEAD LOAD VARY W/ SOIL DEPTH

FROM 2'-0" x 130 = 260 PSF

TO 11'-0" x 130 = 1,430 PSF

LIVE LOAD = FIRE TRUCK LOADS
(PROVIDED BY JURISDICTION)

CONCRETE TECHNOLOGY CORPORATION



CROSS SECTION (DIMENSIONS FOR DETAILING)

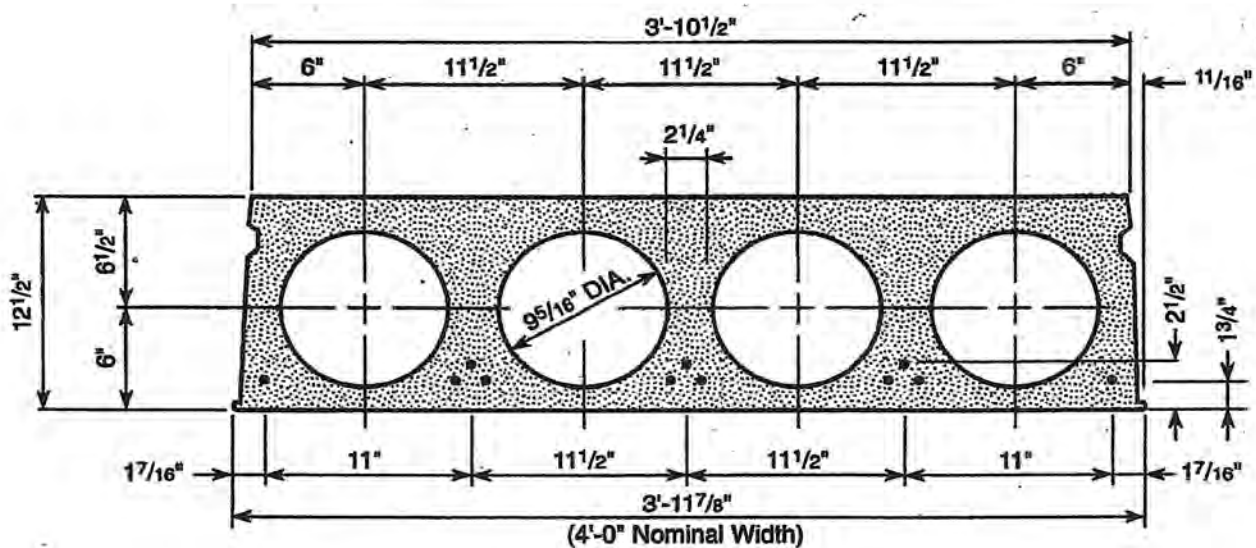

SECTION PROPERTIES (with shear keys grouted)

A:	313	in ²
I:	6,136	in ⁴
y _{top} :	6.02	in
y _{bot} :	6.48	in
S _{top} :	1,019	in ³
S _{bot} :	947	in ³
w:	84	psf

CONCRETE TECHNOLOGY CORPORATION

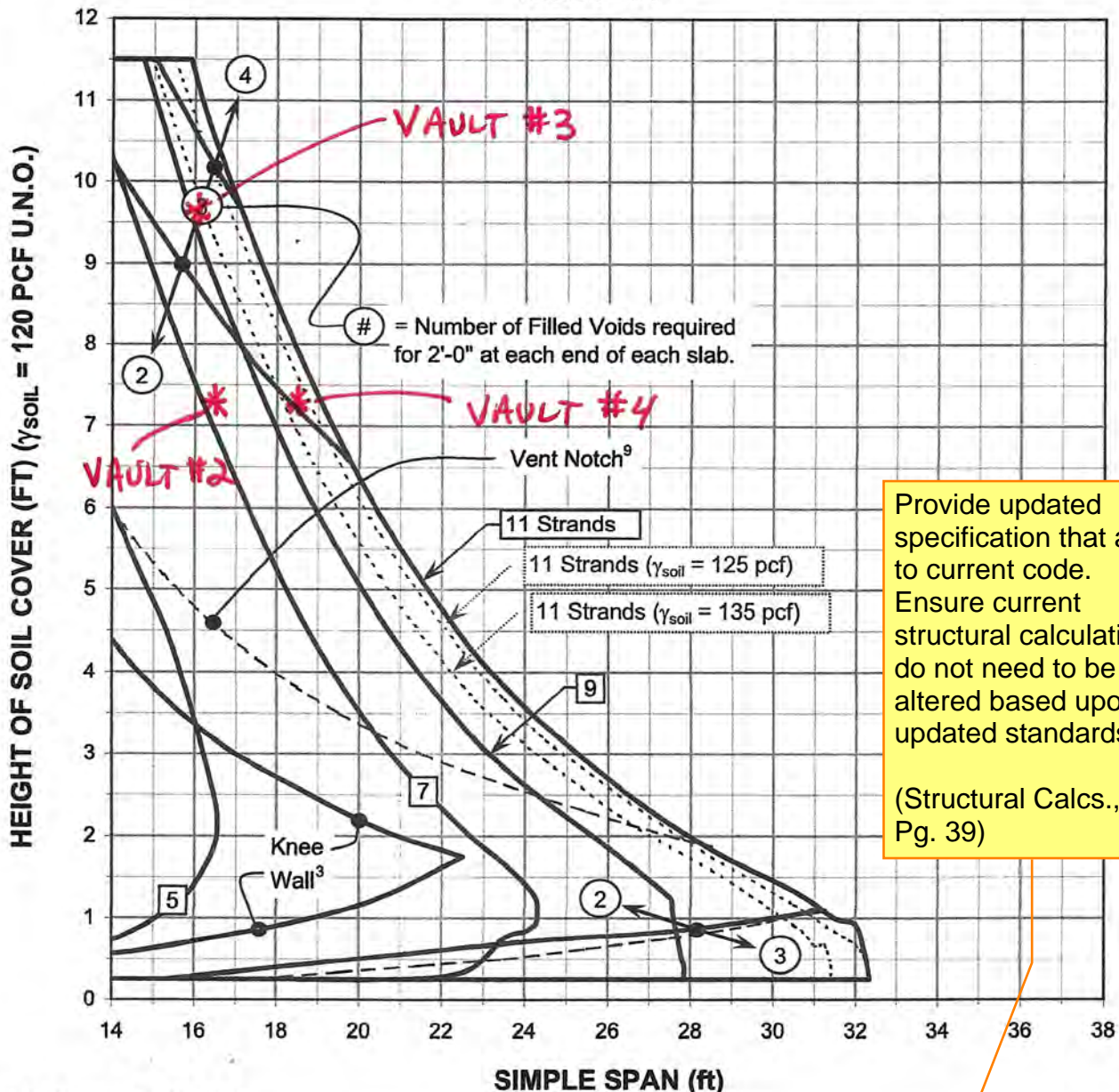

12½" HOLLOW CORE SLAB HS25-44

**GENERAL NOTES:**

- 1.) A minimum cover depth of six inches OR a three inch thick cast in place concrete topping slab is required.
- 2.) Simple Span is centerline of bearing to centerline of bearing.
- 3.) The Knee Wall envelope represents the maximum span and height of soil cover that can be supported by slabs with standard notches for manhole openings, assuming void fill concrete $f_c = 3,000$ psi. Points falling outside this envelope require knee walls to support the slabs at manhole openings.
- 4.) Interpolation between strand contours is acceptable. DO NOT extrapolate beyond the bounds of this chart.
- 5.) Soil cover is assumed to be uniform.
- 6.) Except as noted, soil cover unit weight is assumed to be 120 pcf.
- 7.) Minimum span length = 14'-0".
- 8.) The values shown on this chart are in compliance with IBC 2003 & ACI 318-05.
- 9.) The Vent Notch envelope represents the maximum span and minimum/maximum height of soil cover that can be supported by slabs with 6½" standard notches in adjacent slabs to accommodate 12" diameter vents, assuming void fill concrete $f_c = 3,000$ psi. Refer to Detail 3 on page 15 of this brochure for vent notch details.

JOB# 23.007.21

DESIGNED MRO DATE 10-24-24

PROJECT: BRADLEY HTS VAULTS

INTERIOR HEADERS

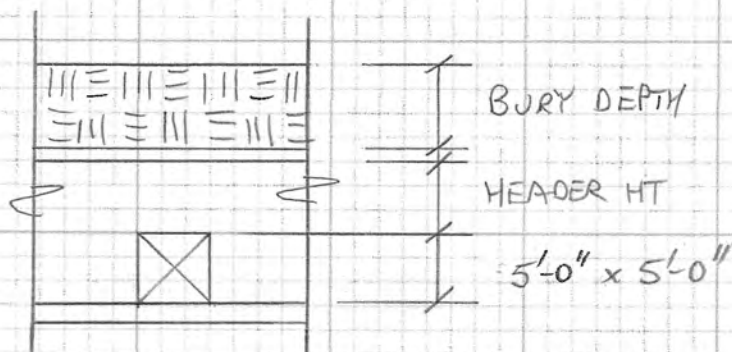

CHECK TWO CONDITIONS

MAX LOAD @ INTERIOR BEARING WALL

= 7'-0" BURY DEPTH & 2'-6" HEADER VAULT #2

= 7'-0" BURY DEPTH & 6'-6" HEADER VAULT #4

$w_D = 1.2(7.0)(.130)(17.17) = 18.7$	$= 1.2(7.0)(.130)(19.17) = 20.9$
$= 1.2(.084)(17.17) = 1.7$	$= 1.2(.084)(19.17) = 1.9$
$= 1.2(.100)(2.5) = 0.3$	$= 1.2(.100)(6.5) = 0.8$
$= 1.6(.100)(17.17) = 2.7$	$= 1.6(.100)(19.17) = 3.1$
<u>23.4</u>	<u>26.7</u>

$$V_U = 23.4 \left(\frac{5}{2} - \frac{27}{12} \right) = 5.9 \text{ k}$$

$$= 26.7 \left(\frac{5}{2} - \frac{75}{12} \right) = \text{---}$$

$$M_U = 23.4(5)^2/8 = 73.1 \text{ kft}$$

$$= 26.7(5)^2/8 = 83.4 \text{ kft}$$

JOB# 23.007.21DESIGNED MRO DATE 10-24-24PROJECT: BRADLEY HT VAULTS

INTERIOR HEADERS cont.

VAULT #2

$$\phi V_c = 0.75(2) \sqrt{4000} (8)(21.0) = 15.9$$

$$\phi V_s = 0.75(.20)(60)(27/12) = 20.3$$

36.2K ✓

$$A_s = (2) \#6 = 0.88 \text{ in}^2$$

$$a = \frac{.88(60)}{.85(4)(8)} = 1.941 \text{ in}$$

$$\phi M_n = 0.9(.88)(60)(27 - \frac{1.941}{2})/12 = 103 \text{ Kft} \checkmark$$

VAULT #4

$$\phi V_c = 0.75(2) \sqrt{4000} (8)(75.0) = 56.9$$

$$\phi V_s = 0.75(.20)(60)(75/12) = 56.3$$

113K ✓

$$\phi M_n = 0.9(.88)(60)(75 - \frac{1.941}{2})/12 = 293 \text{ Kft} \checkmark$$

VAULT FOUNDATIONS

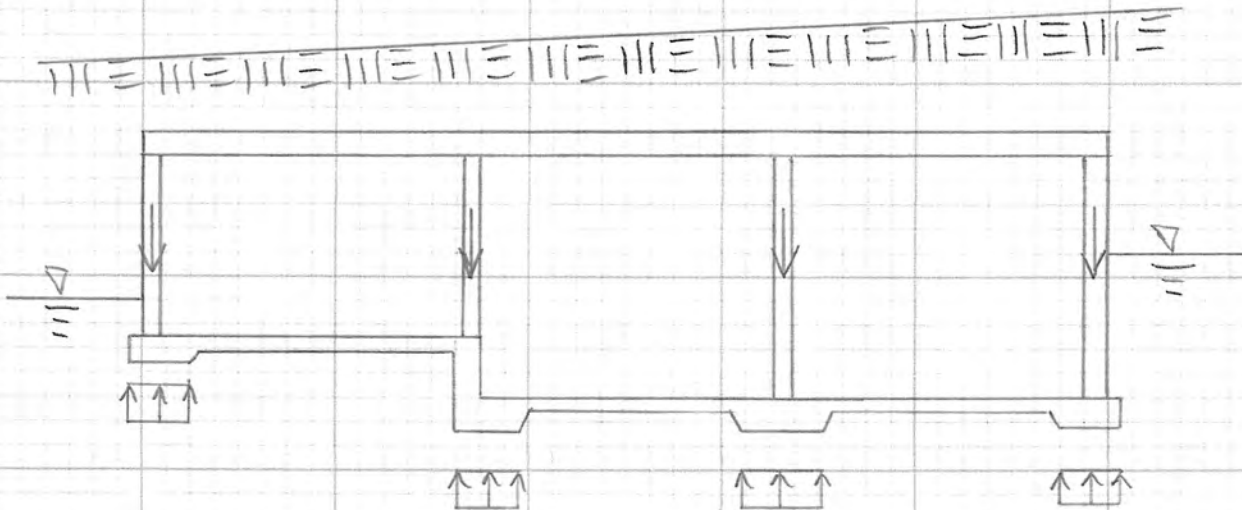

CONDITION #1

DESIGN THICKENED SLABS FOR 100% LOADING FROM BEARING WALLS ABOVE

CONDITION #2

DESIGN SLABS FOR NET BOUYANCY UPLIFT

Bradley Heights Detention Vaults
S4S Job# 23.007.2

Bearing Wall Loads

Vault	Wall	Avg Soil Depth	Plank Trib	Wall Ht	Dead	Live	D+L	1.2D + 1.6L	Width	Wu
2	Ext	7.14	8.92	7.5	9,775	892	10,667	13,157	3.00	4,386
2	Trans	6.89	17.17	7.5	17,568	1,717	19,285	23,828	3.33	7,156
2	Int	6.39	17.17	11.0	16,802	1,717	18,519	22,909	4.00	5,727
2	Ext	6.14	9.08	11.0	9,388	908	10,297	12,719	3.00	4,240
3	Ext	7.04	8.67	7.5	9,410	867	10,276	12,678	3.00	4,226
3	Trans	7.16	16.67	7.5	17,663	1,667	19,330	23,863	3.33	7,166
3	Ext	8.66	9.17	11.0	13,015	917	13,932	17,084	3.00	5,695 <---
4	Ext	6.55	10.42	11.0	11,670	1,042	12,711	15,670	3.00	5,223
4	Int	6.13	19.17	11.0	17,984	1,917	19,901	24,647	4.00	6,162 <---
4	Trans	6.30	19.17	7.5	18,058	1,917	19,974	24,736	3.33	7,428 <---
4	Ext	6.88	9.92	7.5	11,015	992	12,007	14,805	3.00	4,935

JOB # 23.007.2.1

DESIGNED MRO DATE 10-28-24

PROJECT: BRADLEY HTS VAULTS

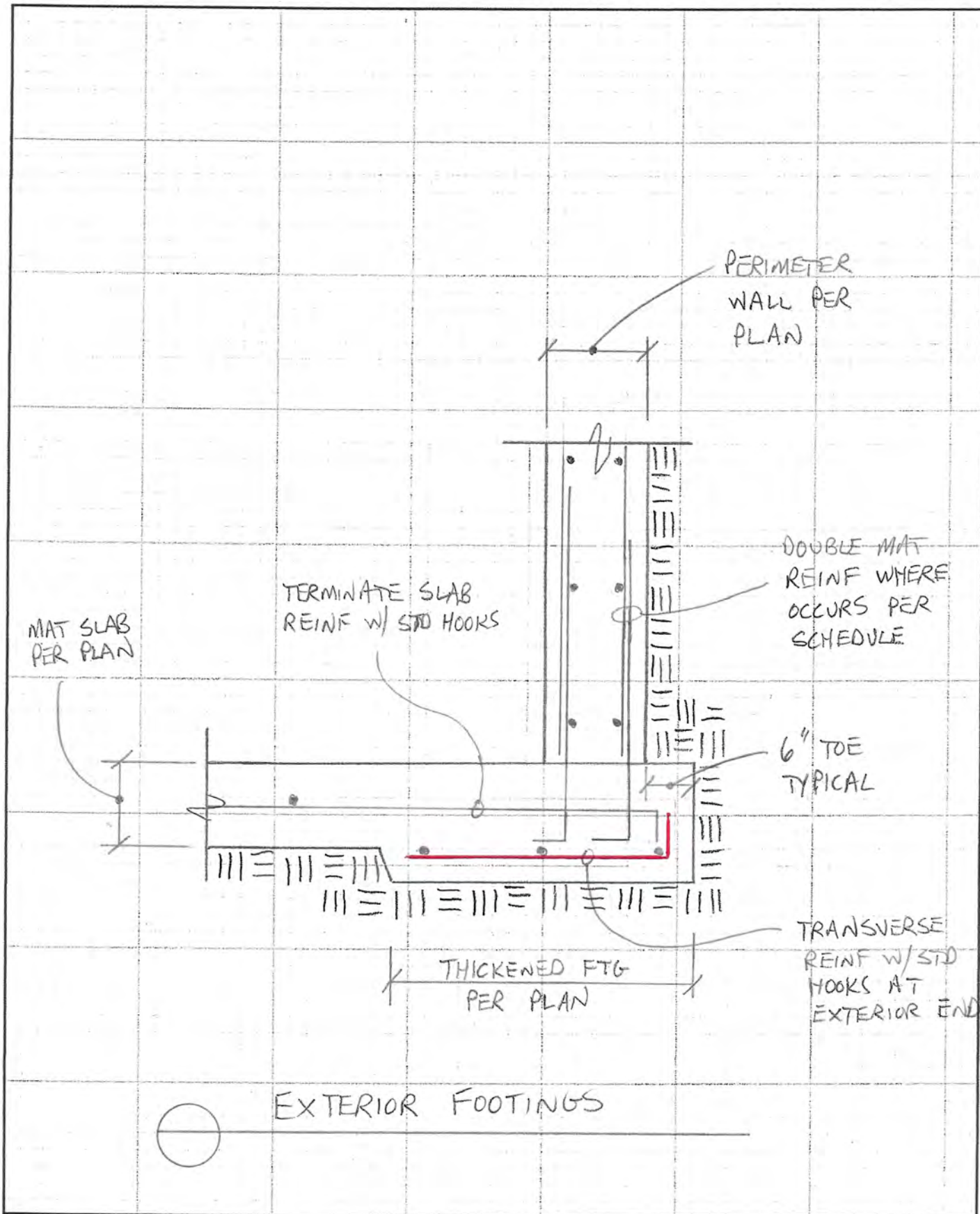

JOB # 23.007.2.1

DESIGNED MRO DATE 10-28-24

PROJECT: BRAOLEY HTS VAULTS

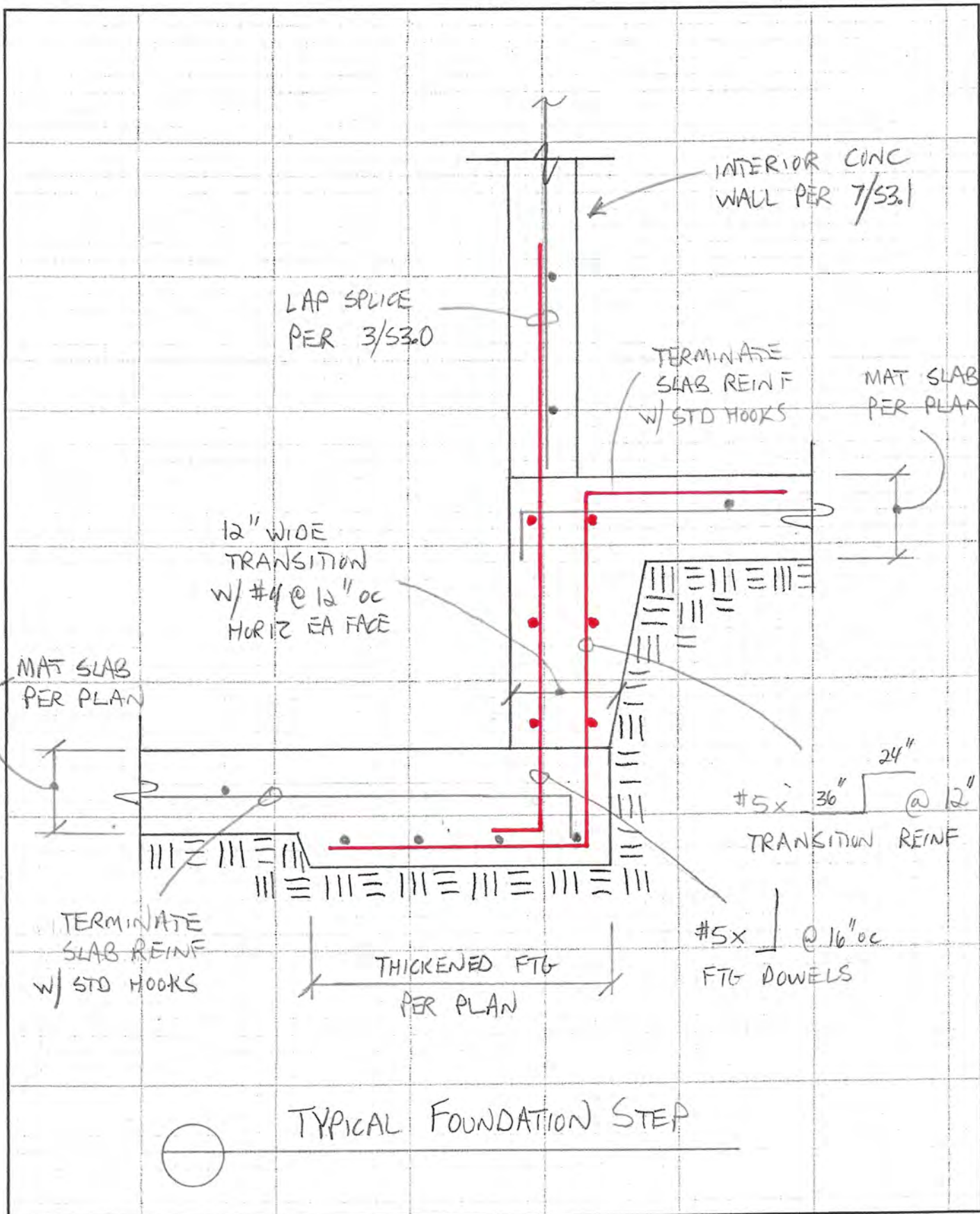

JOB# 23.007.2.1

DESIGNED MRO DATE 10-28-24

PROJECT: BRADLEY HTS VAULTS

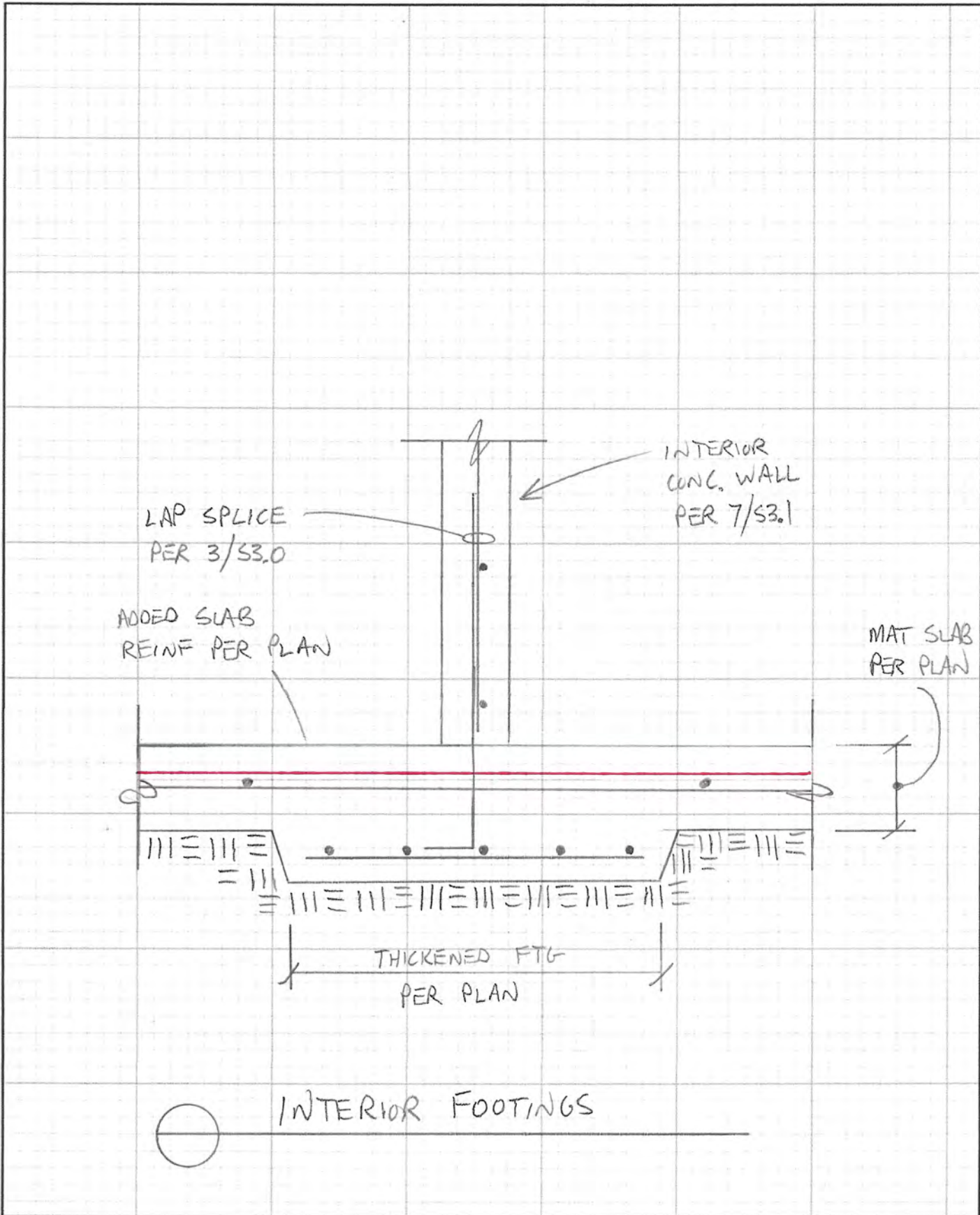

JOB# 23.007.2.1

DESIGNED MRO DATE 10-28-24

PROJECT: BRADLEY HTS VAULTS

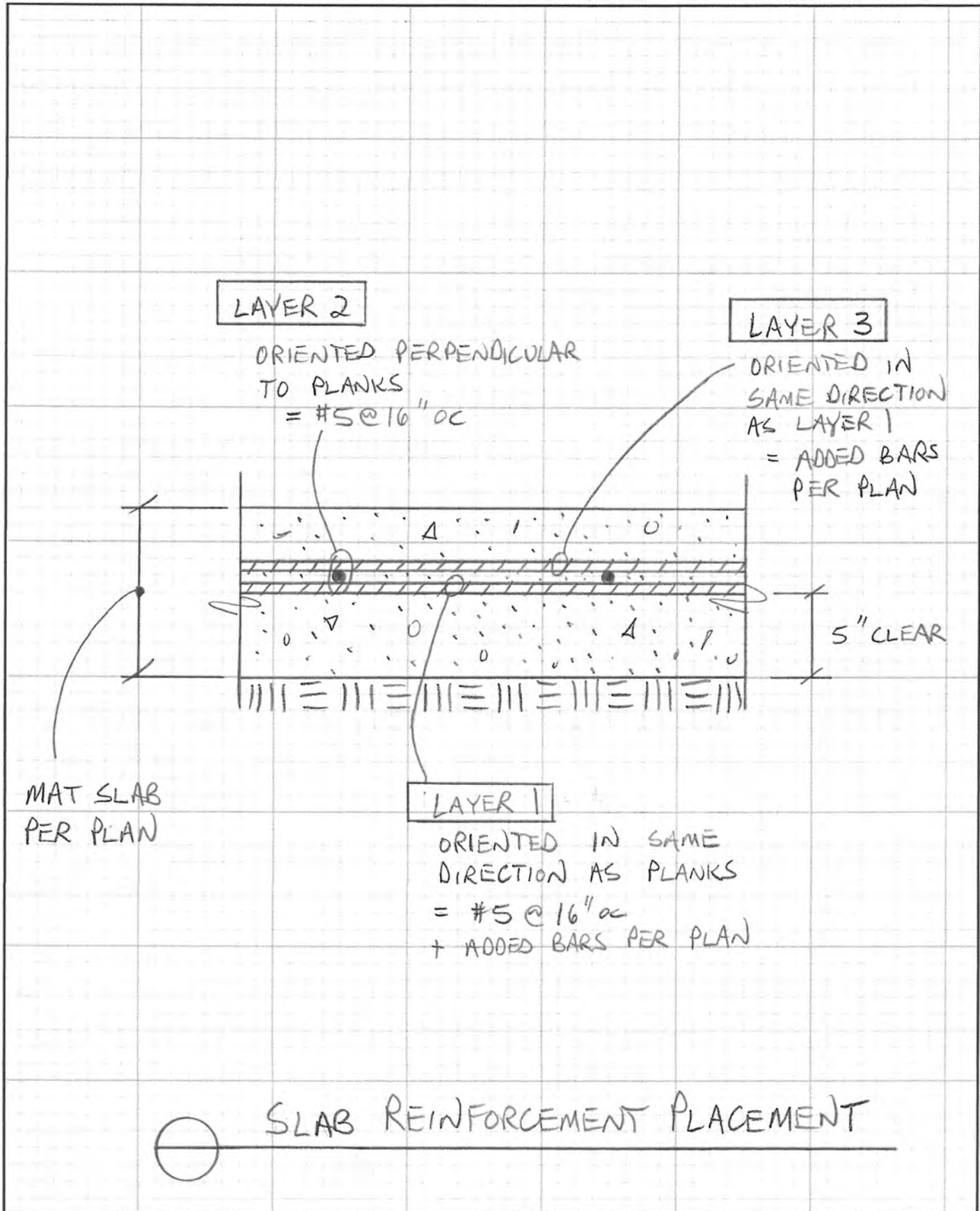

TYPICAL JOINT FIXITIES

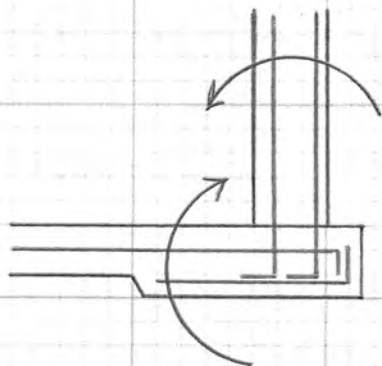

$\phi M_n = 8.5 \text{ kft}$

$$A_s = \#5 @ 16 = .2325$$

$$+ \#4 @ 16 = .150$$

$$\underline{\hspace{1.5cm}} .3825 \text{ in}^2$$

$$a = \frac{.3825(60)}{.85(3)(12)} = 0.563 \text{ in}$$

$\phi M_n \text{ FTG}$
 $= 13.8 \text{ kft}$

$$\phi M_n = 0.9(.2325)(60)\left(2.3125 - \frac{.563}{2}\right)/12 = 2.1$$

$$+ 0.9(.150)(60)\left(9.75 - \frac{.563}{2}\right)/12 = 6.4$$

8.5 kft

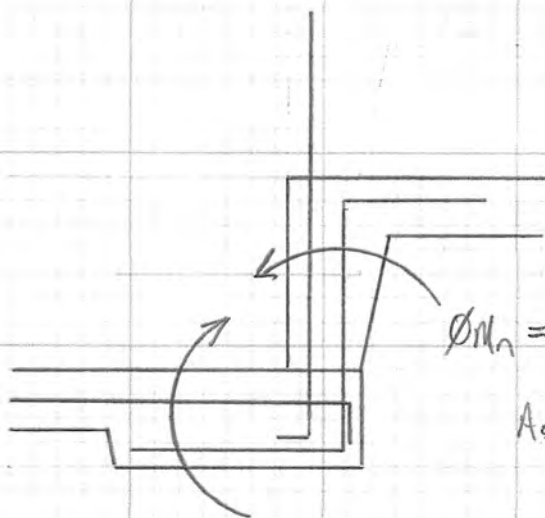

$\phi M_n = 11.8 \text{ kft}$

$$A_s = \#5 @ 16 = 0.2325$$

$$+ \#5 @ 16 = 0.2325$$

$$\underline{\hspace{1.5cm}} 0.465 \text{ in}^2$$

$$a = \frac{.465(60)}{.85(3)(12)} = 0.912 \text{ in}$$

$\phi M_n \text{ FTG}$
 $= 21.3 \text{ kft}$

$$\phi M_n = 0.9(.2325)(60)\left(9.6875 - \frac{.912}{2}\right)/12 = 9.7$$

$$0.9(.2325)(60)\left(2.3125 - \frac{.912}{2}\right)/12 = 2.1$$

11.8 kft

JOB # 23.007.2.1DESIGNED MRO DATE 1-0-28-24PROJECT: BRADLEY HTS VAULTS

FOOTING CAPACITY 3'-0" EXTERIOR

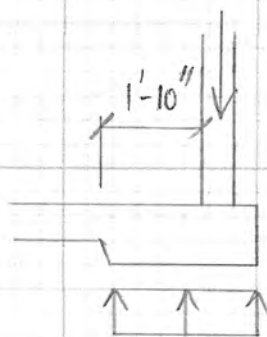

$$w_o = 5.48 \text{ KSF}$$

$$V_o = 5.70(1.83) = 10.5 \text{ K} \quad (5.4 \text{ K @ dist "d"})$$

$$\phi V_c = 0.75(2) \sqrt{3000}(12)(10.6875) = 10.5 \text{ K}$$

$$M_o = 5.70(1.83)^2 / 2 = 9.6 \text{ Kft}$$

$$A_s = \begin{array}{l} \#4 @ 12'' = 0.200 \\ + \#5 @ 16'' = 0.2325 \\ \hline 0.4325 \text{ in}^2 \end{array}$$

$$a = \frac{.4325(60)}{0.85(3)(12)} = 0.848 \text{ in}$$

$$\begin{aligned} \phi M_n &= 0.9(0.200)(60) \left(10.75 - \frac{.848}{2} \right) / 12 = 9.3 \\ & 0.9(0.2325)(60) \left(4.69 - \frac{.848}{2} \right) / 12 = 4.5 \\ & \hline & 13.8 \text{ Kft} \end{aligned}$$

JOB# 23.007.2.1

DESIGNED MRO DATE 10-28-24

PROJECT: BRADLEY HTS VAULTS

FOOTING CAPACITY 3'-4" TRANSITION

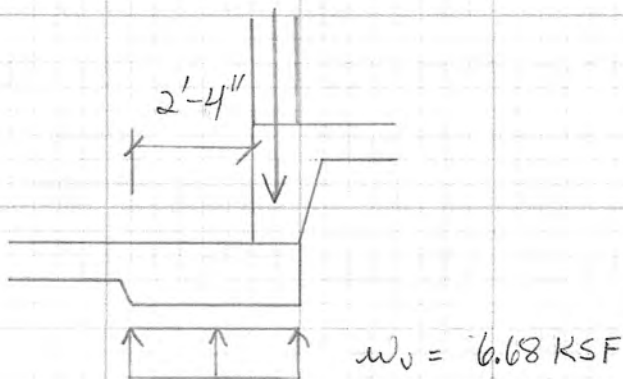

$$V_u = 7.43(2.33) = 17.3 \text{ K} \quad (9.4 \text{ K @ dist "d"})$$

$$\phi V_c = 0.75(2) \sqrt{3000} (12)(12.6875) = 12.5 \text{ K}$$

$$M_u = 7.43(2.33)^2 / 2 = 20.2 \text{ Kft}$$

$$A_s = \#5 @ 12'' = 0.310$$

$$+ \#5 @ 16'' = \frac{0.2325}{0.543}$$

$$a = \frac{.543(60)}{.85(3)(12)} = 1.064 \text{ in}$$

$$\phi M_n = 0.9(0.31)(60) \left(12.6875 - \frac{1.064}{2} \right) / 12 = 17.0$$

$$0.9(.2325)(60) \left(4.69 - \frac{1.064}{2} \right) / 12 = \frac{4.3}{21.3 \text{ Kft}}$$

JOB # 23.007.2.1DESIGNED MRO DATE 10-28-24PROJECT: BRADLEY HTS VAULTS

FOOTING CAPACITY 4'-0" INTERIOR

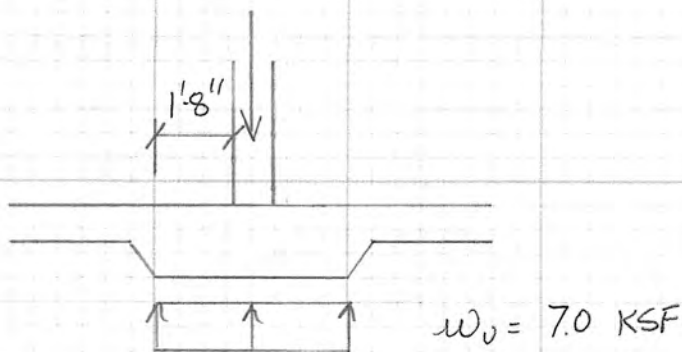

$$V_v = 6.16(1.67) = 10.3 \text{ K} \quad (3.8 \text{ K @ dist "d"})$$

$$\phi V_c = 0.75(2) \sqrt{3000}(12)(12.6875) = 12.5 \text{ K}$$

$$M_v = 6.16(1.67)^2/2 = 8.6 \text{ Kft}$$

$$A_s = \#5 @ 16'' = 0.2325$$

$$+ (2) \#5 @ 16'' = \underline{0.465}$$

$$0.6975$$

$$a = \frac{.6975(60)}{.85(3)(12)} = 1.367 \text{ in}$$

$$\phi M_n = 0.9(0.2325)(60)(12.6875 - \frac{1.367}{2})/12 = 12.6$$

$$0.9(0.465)(60)(4.6875 - \frac{1.367}{2})/12 = \underline{8.4}$$

$$21.0 \text{ Kft}$$

SLAB ANALYSIS (2-SPAN)

MAX BOUYANCY UPLIFT AT VAULT #4

HYDROSTATIC HEAD

$$H_1 = (396.5 - 386.79) + 10/12 = 10.54 \text{ ft}$$

$$H_2 = (393.83 - 386.79) + 10/12 = 7.87 \text{ ft}$$

$$w_{v1} = 1.2(10.54 \times 62.4) - 1.2(.125) = 639 \text{ PSF}$$

$$w_{v2} = 1.2(7.87 \times 62.4) - 1.2(.125) = 439 \text{ PSF}$$

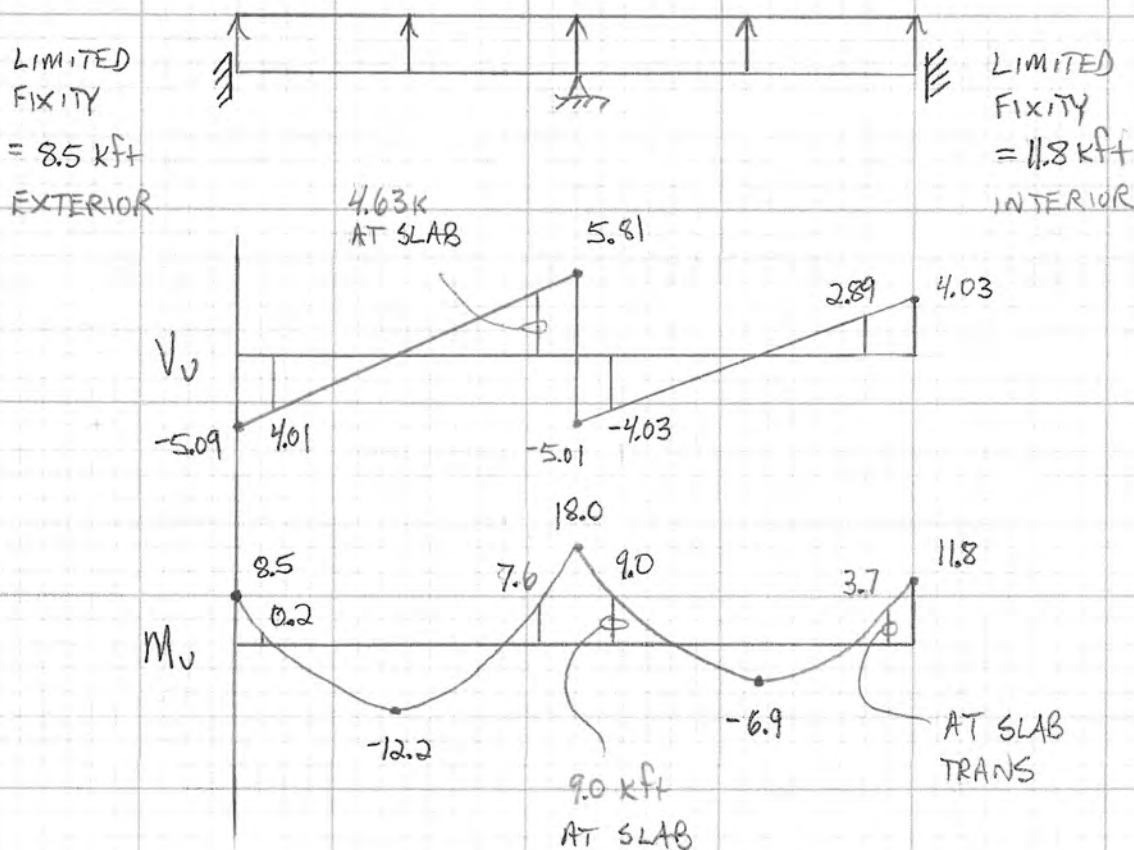

SLAB ANALYSIS (1-SPAN)

MAX BOUYANCY UPLIFT AT VAULT #2

HYDROSTATIC HEAD

$$H_1 = (379.0 - 373.66) + 10/12 = 6.17 \text{ ft}$$

$$H_2 = (379.17 - 373.66) + 10/12 = 6.34 \text{ ft}$$

$$w_{01} = 1.2(6.17 \times 62.4) - 1.2(.125) = 462 \text{ PSF}$$

$$w_{02} = 1.2(6.34 \times 62.4) - 1.2(.125) = 475 \text{ PSF}$$

LIMITED
FIXITY
= 4.7 kft
INTERIOR

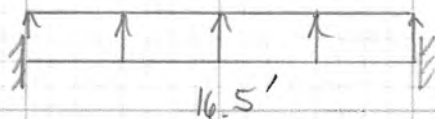

LIMITED
FIXITY
= 8.5 kft
EXTERIOR

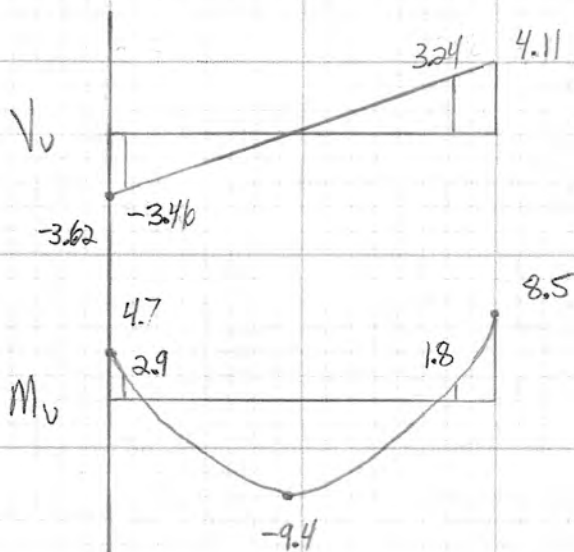

JOB# 23.007.2.1

DESIGNED MRO DATE 10-28-24

PROJECT:

BRADLEY HTS VAULTS

TYPICAL SLAB CAPACITIES

10" SLAB

$$d^+ = 4.69 \text{ in TYP \# ADDED}$$

$$d^- = 5.31 \text{ in TYP} \\ 6.56 \text{ in ADDED}$$

$$\phi V_c = 0.75(2) \sqrt{3000} (12)(5.31) = 5.2 \text{ k}$$

$$A_s^+ = \#5 @ 16" = 0.2325$$

$$A_s^+ = (2) \#5 @ 16" = 0.465$$

$$a = \frac{2325(60)}{85(3)(12)} = 0.456$$

$$a^+ = 0.912 \text{ in}$$

$$\phi M_n = 0.9(0.2325)(60) \left(4.6875 - \frac{0.456}{2} \right) / 12 \\ = 4.7 \text{ kft TYPICAL}$$

$$\phi M_n^+ = 0.9(0.465)(60) \left(4.6875 - \frac{0.912}{2} \right) / 12 \\ = 8.9 \text{ kft w/ ADDED BOT}$$

$$\phi M_n^- = 0.9(0.2325)(60) \left(5.3125 - \frac{0.456}{2} \right) / 12$$

$$\phi M_n^- = 0.9(0.2325)(60) \left(5.3125 - \frac{0.912}{2} \right) / 12 \\ = 0.9(0.2325)(60) \left(6.56 - \frac{0.912}{2} \right) / 12$$

$$= 5.3 \text{ kft TYPICAL}$$

$$= 11.5 \text{ kft w/ ADDED TOP}$$