



BARGHAUSEN
A DIVISION OF CORE STATES GROUP

**CORE
STATES**



Storm Drainage Report
Puyallup Public Safety Building

PREPARED BY
Kaleb Mapstead

PREPARED FOR

Benaroya Capital, LLC

CLIENT ADDRESS

9675 SE 36th Avenue, Suite 115
Mercer Island, WA 98040

SITE ADDRESS

1015 39th Avenue SE
Puyallup, Washington
98374

PROJECT NO.

23796

DATE

07/14/2025

JURISDICTION

City of Puyallup

TABLE OF CONTENTS

1.0	PROJECT OVERVIEW
2.0	CONDITIONS AND REQUIREMENTS SUMMARY
2.1	Analysis of the Minimum Requirements
3.0	EXISTING CONDITIONS SUMMARY
4.0	PERMANENT STORMWATER CONTROL PLAN
A.	Existing Site Hydrology
B.	Developed Site Hydrology
C.	Performance Standards
D.	Flow Control System
E.	Water Quality System
5.0	CONVEYANCE SYSTEM ANALYSIS AND DESIGN
6.0	OTHER PERMITS
7.0	BOND QUANTITIES
8.0	OPERATIONS AND MAINTENANCE MANUAL

1.0 PROJECT OVERVIEW

1.0 PROJECT OVERVIEW

The Puyallup Public Safety Building project is located on a 77-acre site and is part of a larger common plan of development. Other projects in the immediate vicinity include Centeris Voltage Park project (2024) and the Benaroya Parking Expansion project (2022). The site is located at 1015 39th Avenue SE within the City of Puyallup, Washington and encompasses one existing tax parcel (0419034038). This redevelopment project will consist of approximately 48,700 square feet of tenant improvements to the Benaroya South Hill Business and Technology Center for the proposed Puyallup Police Department and Emergency Operations Center. Limited building envelope improvements for two (2) new entries (one public, one secure), plus parking lot striping and security improvements. This storm drainage report accompanies the construction documents prepared for the project and provides site information and documentation in accordance with the 2019 Washington State Department of Ecology Stormwater Management Manual for Western Washington (SWMMWW) and the City of Puyallup standards. The project will utilize existing stormwater infrastructure and existing stormwater facilities and it has been determined that the project has no impact on existing stormwater facilities.

2.0 CONDITIONS AND REQUIREMENTS SUMMARY

2.0 CONDITIONS AND REQUIREMENTS SUMMARY

2.1 Analysis of the Minimum Requirements

Minimum Requirement No. 1: Preparation of a Stormwater Site Plan.

Response: The project creates more than 2,000 square feet of new and/or replaced impervious surfaces. A stormwater site plan has been prepared for this project.

Minimum Requirement No. 2: Construction Stormwater Pollution Prevention Plan (SWPPP).

Response: The project will consider all 13 elements of Construction Stormwater Pollution Prevention. The 13 elements are addressed in the SWPPP provided in Appendix C

Minimum Requirement No. 3: Source Control of Pollution.

Response: Permanent source control Best Management Practices (BMPs) are already in place for the facility's daily operations.

Minimum Requirement No. 4: Preservation of Natural Drainage Systems and Outfalls.

Response: The project will not alter any drainage patterns and preserves the existing storm drainage system and flow paths.

Minimum Requirement No. 5: Onsite Stormwater Management.

Response: The project triggers MRs #1 through #9, the project considers BMPs from List #2 of the SWMMWW.

Lawn and Landscape Areas:

Areas of landscape will be disturbed with this project, therefore soil amendments under BMP T5.13 are applicable

Roofs:

Downspout Infiltration:

According to the geotechnical study prepared by GeoEngineers, dated February 28, 2022, the nearest Pilot Infiltration Test (PIT-1-20) for an immediate adjacent project shows no infiltrative capacity for the soils. While no groundwater was discovered in this location, due to the soils, infiltration is not feasible.

Downspout Dispersion:

Adequate flow paths are not available and therefore dispersion is not feasible.

Other Hard Surfaces:

Dispersion:

Adequate flow paths are not available and therefore dispersion is not feasible.

Minimum Requirement No. 6: Runoff Treatment.

Response: The redevelopment project creates less than 5,000 square feet of new pollution generating hard surfaces, therefore runoff treatment is not required.

Minimum Requirement No. 7: Flow Control.

Response: While the project is part of a greater common plan of development and triggers Minimum Requirement 7, the TDA itself does not trigger the TDA thresholds for Flow Control BMPs. Per the 2019 SMMWW, the TDA does not create more than 10,000 square feet of effective impervious surfaces, does not convert more than $\frac{3}{4}$ acre of native vegetation to lawn or landscape, and does not increase the 100-year flow frequency by more than 0.15 cfs. Therefore, Flow Control BMPs are not required.

Minimum Requirement No. 8: Wetlands Protection.

Response: The project does not propose any changes to the natural drainage system. The existing wetlands on and/or adjacent to the site will continue to function as in the existing condition.

Minimum Requirement No. 9: Operation and Maintenance.

Response: An operations and maintenance manual is provided in Appendix D.

Does the Project result in 2,000 square feet, or more, of new plus replaced hard surface area?
OR
Does the land disturbing activity total 7,000 square feet or greater?

Yes

No

Minimum Requirements #1 through #5 apply to the new and replaced hard surfaces and the land disturbed.

Minimum Requirement #2 applies.

Next Question

Does the Project add 5,000 square feet or more of new hard surfaces?
OR
Convert $\frac{3}{4}$ acres or more of vegetation to lawn or landscaped areas?
OR
Convert 2.5 acres or more of native vegetation to pasture?

Yes

No

All Minimum Requirements apply to the new hard surfaces and the converted vegetation areas.

Next Question

Is this a road related project?

No

Yes

Does the Project add 5,000 square feet or more of new hard surfaces?

Yes

No

Do the new hard surfaces add 50% or more to the existing hard surfaces within the Site?

No

No

No additional requirements.

Is the total of new plus replaced hard surfaces 5,000 square feet or more,
AND
does the value of the proposed improvements - including interior improvements - exceed 50% of the assessed value (or replacement value) of the:

- existing Project Site improvements (for commercial or industrial projects) OR
- existing Site improvements (for all other projects)

Yes

All Minimum Requirements apply to the new and replaced hard surfaces and converted vegetation areas.

Yes



DEPARTMENT OF
ECOLOGY
State of Washington

Flow Chart for Determining Requirements for Redevelopment

Revised March 2019

Please see <http://www.ecy.wa.gov/copyright.html> for copyright notice including permissions, limitation of liability, and disclaimer.

Figure I-3.3: Flow Chart for Determining MR #5 Requirements

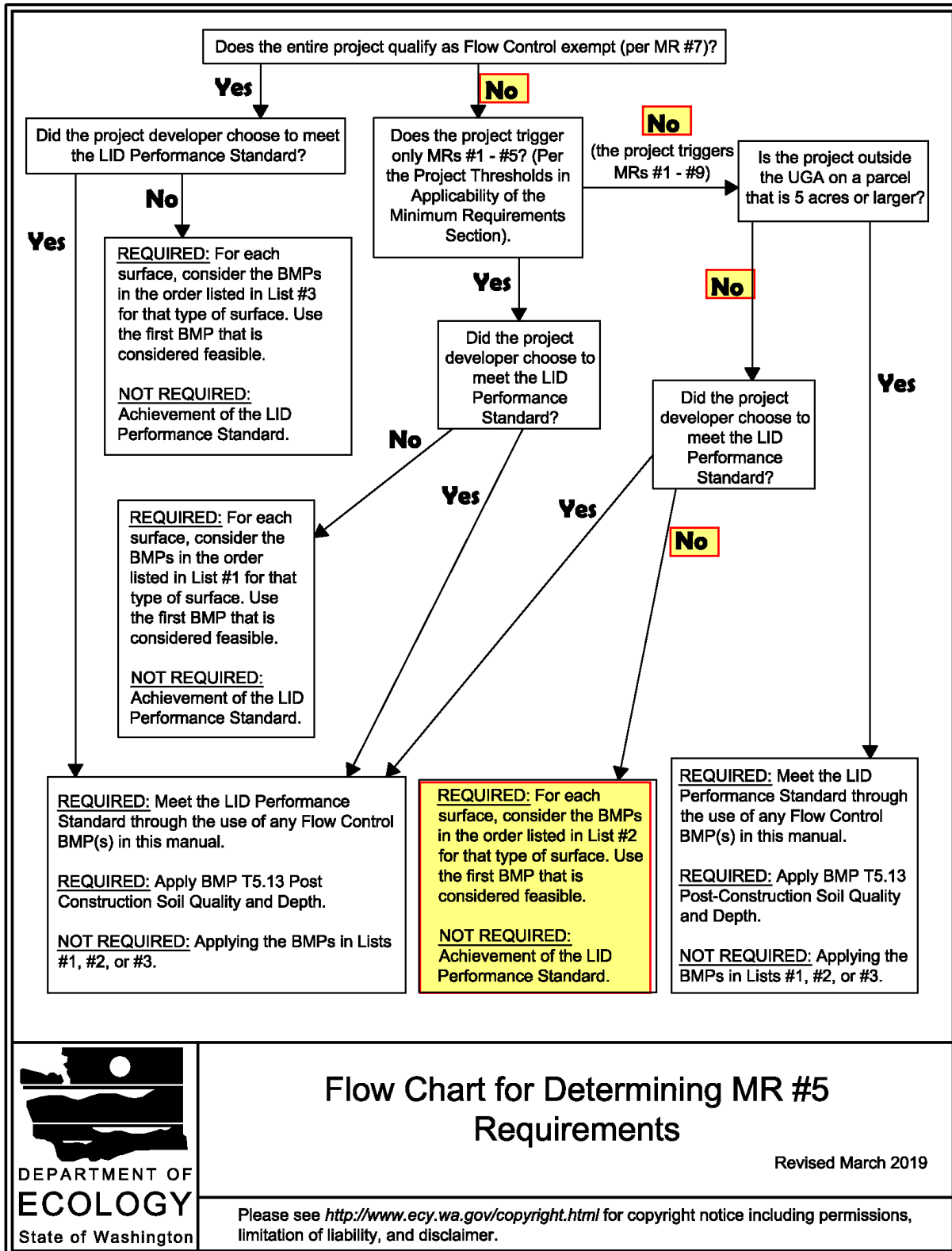

3.0 EXISTING CONDITIONS SUMMARY

3.0 EXISTING CONDITIONS SUMMARY

The overall facility encompasses approximately 77 acres. The overall site is irregular in shape and contains several buildings and existing data center facilities. The site was initially developed back in the 1980s. The majority of the subject property consists of impervious surfaces (buildings, sidewalks, asphalt pavement) surrounded by maintained lawn and ornamental non-native landscaping. The undeveloped forested portions of the site contain fir and maple trees. The site is bound on the north and east by parcels owned by Pierce College and City of Puyallup Right-of-Way, to the south by 39th Avenue SE and to the west by an existing senior living facility. Site soils in the area of redevelopment consist of primarily Kapowsin gravelly ashy loam, Indianola loamy sands and Everett very gravelly sandy loams. Previous wetland investigations identified potential wetlands on the site, none of which are affected by this project. The project site is not located in any mapped floodplain. Please refer to the exhibits within Appendix A for additional existing conditions.

The redevelopment project is part of larger common plan of development. Other projects in the immediate vicinity include Centeris Voltage Park project (2024) and the Benaroya Parking Expansion project (2022). The project area drains to the existing developed stormwater system consisting of catch basins and stormwater piping collect and convey flows from this area to an existing stormwater pond which infiltrates into surrounding soils. No drainage or erosion issues were reported or noted in our site reconnaissance.

There is no upstream basin contributing runoff to this project site as 39th Avenue SE forms the project site's southern boundary and has its own collection and conveyance system. To the east the, flows primarily travel to the north and around this property.

4.0 PERMANENT STORMWATER CONTROL PLAN

4.0 PERMANENT STORMWATER CONTROL PLAN

A. Existing Site Hydrology

The majority of the subject property consists of impervious surfaces building, sidewalks, and asphalt pavements surrounded by maintained lawn and ornamental non-native landscaping. The undeveloped forested portions of the site contain fir and maple trees. An existing developed stormwater system consisting of catch basins and stormwater piping collect and convey flows from this area to an existing stormwater pond which infiltrates into surrounding soils

B. Developed Site Hydrology

Limits of site disturbance will include installation of sediment and erosion control BMPs construction of a new public building entrance along the western side of the existing building, parking lot restriping, security fence/gate installation, and new secure building entrance along the southern side of the existing building. Additional features in the secure area will include an outdoor patio and recreation area. The total disturbed area will cover approximately 0.30 acre.

Approximately 9,888 square feet (0.226 acre) of new plus replaced hard surfaces are proposed with this redevelopment. Based on the flow chart for redevelopment, all minimum requirements are applicable to the new and replaced hard surfaces within the TDA, however the TDA does not meet the thresholds for providing Flow Control BMPs. Please refer to the developed basin map within Appendix B.

C. Performance Standards

The Western Washington Hydrology Model (WWHM) methodology was used to model the TDAs in conformance with the SWMMWW and the City of Puyallup standards.

D. Flow Control System

The redevelopment project will not increase the 100-year flow in the onsite TDA by more than 0.15 cfs and therefore, flow control BMPs are not required.

E. Water Quality System

The redevelopment project does not create greater than 5,000 square feet of new pollution generating hard surfaces therefore runoff treatment is not required.

5.0 CONVEYANCE SYSTEM ANALYSIS AND DESIGN

5.0 CONVEYANCE SYSTEM ANALYSIS AND DESIGN

The existing conveyance systems will remain and is comprised of 12-inch through 24-inch stormwater pipes and is assumed adequate for this development.

The conveyance system piping calculations for canopy roof drains proposed with this project is provided in Appendix B

6.0 OTHER PERMITS

6.0 OTHER PERMITS

Building Permit (City of Puyallup)

Fire Marshal / Fire Hydrant Locations Approval

Construction Stormwater General Permit (Department of Ecology)

7.0 BOND QUANTITIES

7.0 BOND QUANTITIES

A cost estimate for the stormwater system on the City of Puyallup Cost Estimate Form is provided in Appendix E.

8.0 OPERATIONS AND MAINTENANCE MANUAL

8.0 OPERATIONS AND MAINTENANCE MANUAL

The drainage facilities on this project will be private facilities owned and maintained by the underlying property owner. Therefore, an Operations and Maintenance manual is required. Refer to Appendix D

APPENDIX A

VICINITY MAP



REFERENCE: Rand McNally (2015)

Scale:

Horizontal: N.T.S.

Vertical: N/A

For:

Puyallup Public Safety Building
Puyallup, Washington

Job Number

23796

Title:

VICINITY MAP

DATE:



18215 72ND AVENUE SOUTH
KENT, WA 98032
(425) 251-6222
(425) 251-8782

CIVIL ENGINEERING, LAND PLANNING,
SURVEYING, ENVIRONMENTAL SERVICES

SOILS MAP



REFERENCE: USDA, Natural Resources Conservation Service

13B	Everett very gravelly sandy loam, 0 to 8 percent slopes
18C	Indianola loamy sand, 5 to 15 percent slopes
19B	Kapowsin gravelly ashy loam, 0 to 6 percent slopes
19C	Kapowsin gravelly ashy loam, 6 to 15 percent slopes
19E	Kapowsin gravelly ashy loam, 30 to 65 percent slopes
24D	Neilton gravelly loamy sand, 8 to 25 percent slopes

Scale:

Horizontal: N.T.S.

Vertical: N/A



18215 72ND AVENUE SOUTH
KENT, WA 98032
(425) 251-6222
(425) 251-8782

CIVIL ENGINEERING, LAND PLANNING,
SURVEYING, ENVIRONMENTAL SERVICES

For:

Puyallup Public Safety Building
Puyallup, Washington

Title:

SOIL SURVEY MAP

Job Number

23796

DATE:

FEMA MAP

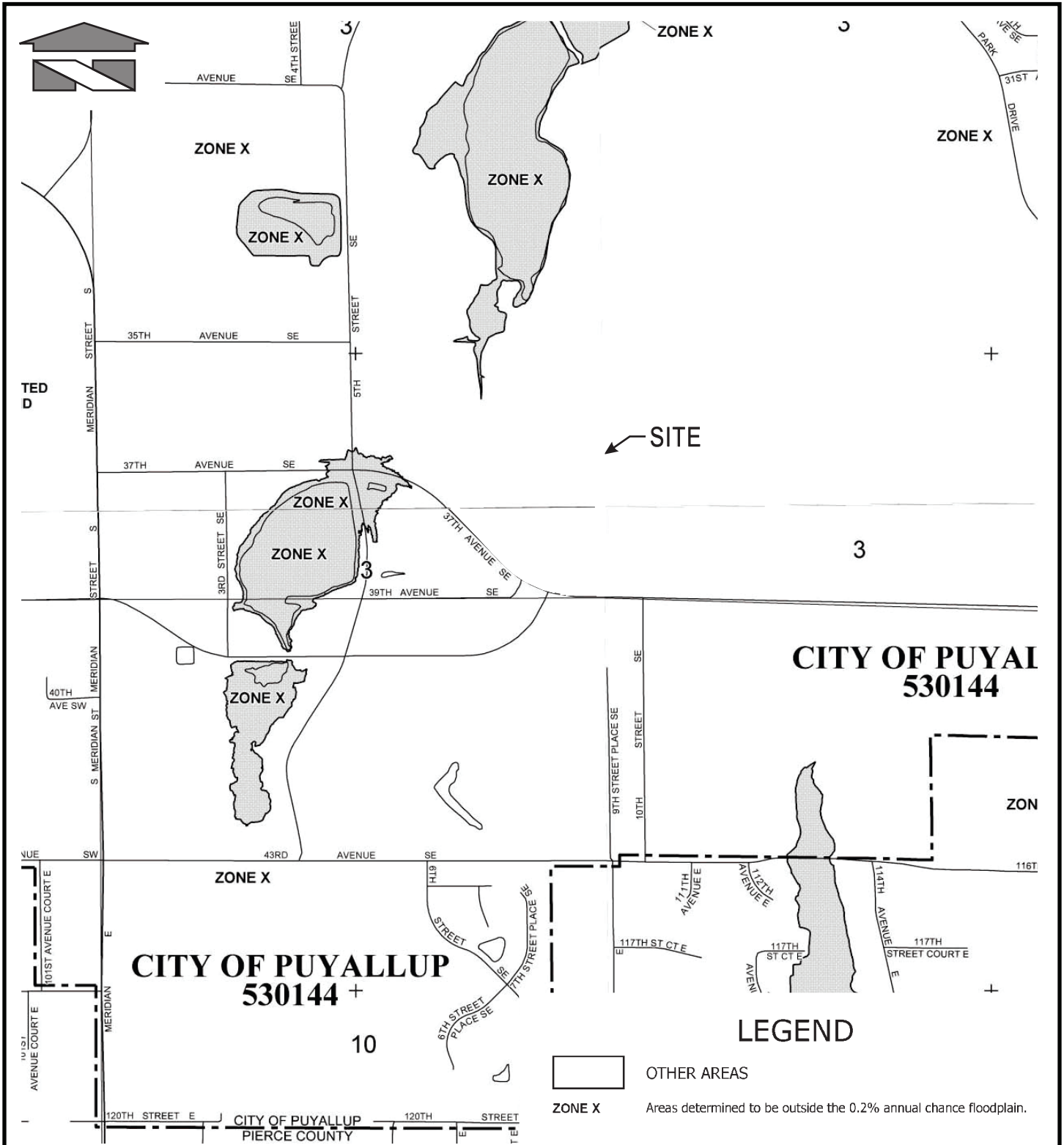

REFERENCE: Federal Emergency Management Agency (Portion of Maps 53053C0341E & 53053C0343E, Mar. 2017)

<p>Scale:</p> <p>Horizontal: N.T.S. Vertical: N/A</p>	<p>For:</p> <p>Puyallup Public Safety Building Puyallup, Washington</p>	<p>Job Number</p> <p>23796</p>
 <p>18215 72ND AVENUE SOUTH KENT, WA 98032 (425) 251-6222 (425) 251-8782</p> <p>CIVIL ENGINEERING, LAND PLANNING, SURVEYING, ENVIRONMENTAL SERVICES</p>	<p>Title:</p> <p>FEMA MAP</p>	<p>DATE:</p>

APPENDIX B

BASIN MAPS

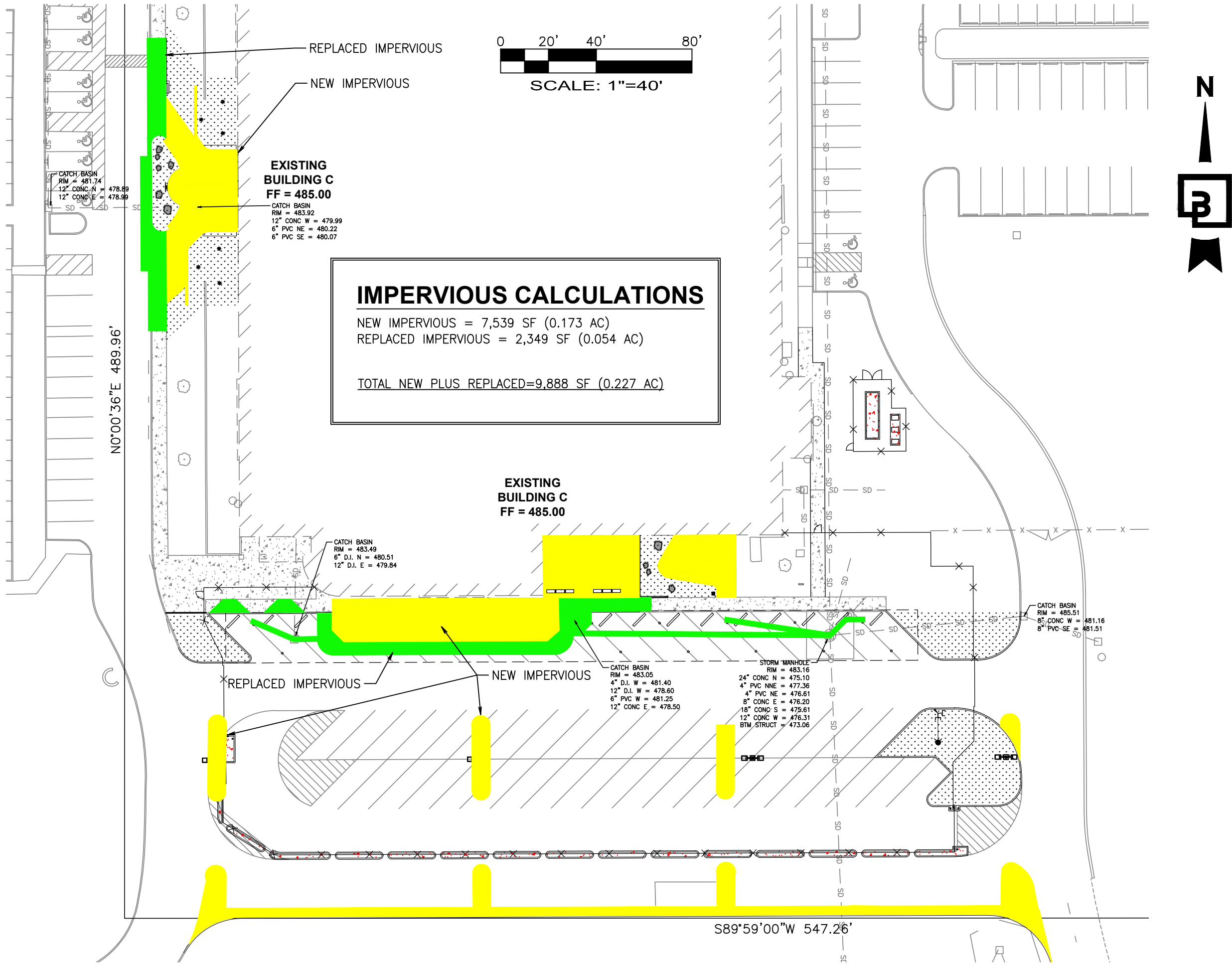

No.	Date	By	Ckd.	Appr.	Revision

Title: **DEVELOPED BASIN MAP**

For: -

Scale:

Horizontal: 1"=40'

Vertical: na

Designed: -

Drawn: -

Checked: -

Approved: -

Date: 07/07/25

Job Number: **23796**

Sheet: **1 of 1**

Barghausen Consulting Engineers, LLC.
18215 72nd Avenue South
Kent, WA 98032
425.251.6222 barghausen.com

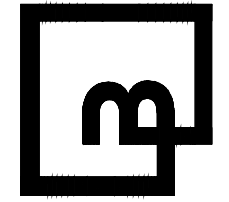

WWHM CALCULATIONS

WWHM2012
PROJECT REPORT

General Model Information

Project Name: 23796-SITE
Site Name:
Site Address:
City:
Report Date: 7/15/2025
Gage: 38 IN CENTRAL
Data Start: 10/01/1901
Data End: 09/30/2059
Timestep: 15 Minute
Precip Scale: 1.000
Version Date: 2021/08/18
Version: 4.2.18

POC Thresholds

Low Flow Threshold for POC1:	50 Percent of the 2 Year
High Flow Threshold for POC1:	50 Year

Landuse Basin Data

Predeveloped Land Use

Basin 1

Bypass:	No
GroundWater:	No
Pervious Land Use C, Lawn, Flat	acre 0.173
Pervious Total	0.173
Impervious Land Use PARKING FLAT	acre 0.054
Impervious Total	0.054
Basin Total	0.227

Element Flows To:		
Surface	Interflow	Groundwater

Mitigated Land Use

Basin 1

Bypass:	No
GroundWater:	No
Pervious Land Use	acre
Pervious Total	0
Impervious Land Use	acre
PARKING FLAT	0.227
Impervious Total	0.227
Basin Total	0.227

Element Flows To:		
Surface	Interflow	Groundwater

Routing Elements
Predeveloped Routing

Mitigated Routing

Analysis Results

POC 1

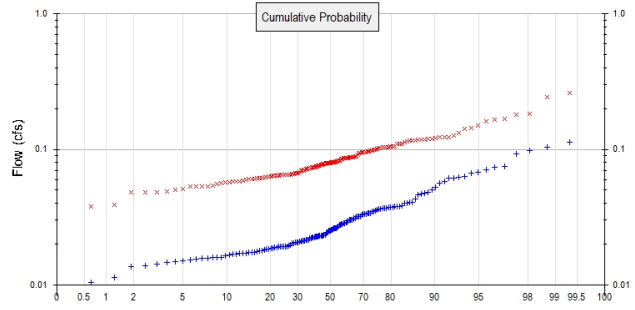
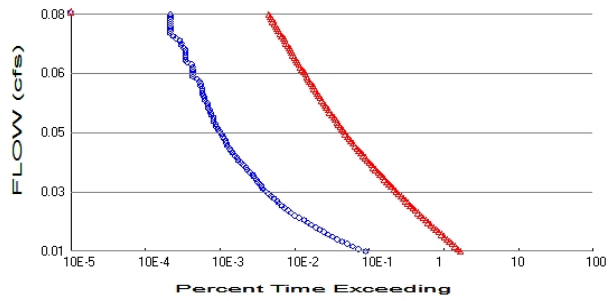

+ Predeveloped x Mitigated

Predeveloped Landuse Totals for POC #1

Total Pervious Area: 0.173
 Total Impervious Area: 0.054

Mitigated Landuse Totals for POC #1

Total Pervious Area: 0
 Total Impervious Area: 0.227

Flow Frequency Method: Log Pearson Type III 17B

Flow Frequency Return Periods for Predeveloped. POC #1

Return Period	Flow(cfs)
2 year	0.025817
5 year	0.039164
10 year	0.050048
25 year	0.066418
50 year	0.080706
100 year	0.096961

Flow Frequency Return Periods for Mitigated. POC #1

Return Period	Flow(cfs)
2 year	0.079552
5 year	0.106785
10 year	0.126578
25 year	0.153668
50 year	0.175409
100 year	0.198531

100 YR FLOW INCREASE = 0.10 CFS < 0.15 CFS

Annual Peaks

Annual Peaks for Predeveloped and Mitigated. POC #1

Year	Predeveloped	Mitigated
1902	0.023	0.094
1903	0.026	0.104
1904	0.058	0.118
1905	0.016	0.053
1906	0.015	0.059
1907	0.034	0.079
1908	0.021	0.065
1909	0.023	0.080
1910	0.035	0.077
1911	0.031	0.086

CONVEYANCE CALCULATIONS

23796-R-CALC-PPSB (Conveyance)-2025-02-26

BARGHAUSEN CONSULTING ENGINEERS - PIPE FLOW CALCULATOR
using the Rational Method & Mannings Equation for 25 year storm event

JOB NAME: PPSB
JOB#: 23796
FILE NO.:

Total Site Area
0.21

C= 0.9 n= 0.012
d= 12 Tc= 6.3

A= Contributing Area (Ac) Qd= Design Flow (cfs)
C= Runoff Coefficient Qf= Full Capacity Flow (cfs)
Tc= Time of Concentration (min) Vd= Velocity at Design Flow (fps)
I= Intensity at Tc (in/hr) Vf= Velocity at Full Flow (fps)
d= Diameter of Pipe (in) s= Slope of pipe (%)
L= Length of Pipe (ft) n= Manning Roughness Coefficient
D= Water Depth at Qd (in) Tt= Travel Time at Vd (min)

COEFFICIENTS FOR THE RATIONAL METHOD "I _r "-EQUATION				
STORM	Ar	Br	PRECIP=	
				3.5
2YR	1.58	0.58	Ar=	2.66
10YR	2.44	0.64	Br=	0.65
25YR	2.66	0.65		
50YR	2.75	0.65		
100YR	2.61	0.63		

	FROM	TO	A	s	L	d	Tc	n	C	SUM A	A*C	SUM A*C	I	Qd	Qf	Qd/Qf	D/d	D	Vf	Vd	Tt
TRUE	RD9	SD1	0.02	2.00	19	6	6.3	0.012	0.9	0.02	0.02	0.02	2.81	0.05	0.86	0.059	0.165	0.99	4.38	2.37	0.13
FALSE																					
TRUE																					
FALSE	RD8	RD7	0.03	1.80	57	6	6.3	0.012	0.9	0.03	0.03	0.03	2.81	0.08	0.82	0.093	0.204	1.23	4.16	2.55	0.37
FALSE	RD7	SD13	0.03	1.00	17	6	6.7	0.012	0.9	0.06	0.03	0.05	2.71	0.15	0.61	0.241	0.333	2.00	3.10	2.54	0.11
TRUE																					
FALSE	RD6	SD12	0.03	2.00	3	6	6.3	0.012	0.9	0.03	0.03	0.03	2.81	0.08	0.86	0.088	0.198	1.19	4.38	2.63	0.02
TRUE																					
FALSE	RD5	SD4	0.03	1.50	43	6	6.3	0.012	0.9	0.03	0.03	0.03	2.81	0.08	0.74	0.102	0.217	1.30	3.79	2.43	0.29
TRUE																					
FALSE	RD4	SD11	0.03	2.00	7	6	6.3	0.012	0.9	0.03	0.03	0.03	2.81	0.08	0.86	0.088	0.198	1.19	4.38	2.63	0.04
TRUE																					
FALSE	RD11	SD10	0.02	2.00	5	6	6.3	0.012	0.9	0.02	0.02	0.02	2.81	0.05	0.86	0.059	0.165	0.99	4.38	2.37	0.04
TRUE																					
FALSE	RD10	SD9	0.02	2.00	11	6	6.3	0.012	0.9	0.02	0.02	0.02	2.81	0.05	0.86	0.059	0.165	0.99	4.38	2.37	0.08
TRUE																					
TRUE																					

APPENDIX C



BARGHAUSEN
A DIVISION OF CORE STATES GROUP

**CORE
STATES**

Stormwater Pollution Prevention Plan (SWPPP)

Puyallup Public Safety Building

PREPARED BY

Kaleb Mapstead

PREPARED FOR

Benaroya Capital, LLC

CLIENT ADDRESS

9675 SE 36th Avenue, Suite 115
Mercer Island, WA 98040

SITE ADDRESS

1015 39th Avenue SE
Puyallup, Washington
98374

PROJECT NO.

23796

DATE

02/26/2025

JURISDICTION

City of Puyallup

Stormwater Pollution Prevention Plan

For
Puyallup Public Safety Building

Prepared For
Benaroya Capital, LLC
9675 SE 36th Avenue
Suite 115
Mercer Island, WA 9040

Owner	Developer	Operator/Contractor
Benaroya Capital, LLC 9675 SE 36 th Avenue Mercer Island, WA 98040	Benaroya Capital, LLC 9675 SE 36 th Avenue Mercer Island, WA 98040	TBD

Project Site Location
1015 39th Avenue SW
Puyallup, WA 98374

Certified Erosion and Sediment Control Lead
TBD

SWPPP Prepared By
Barghausen Consulting Engineers, LLC.
18215 - 72nd Avenue South
Kent, WA 98032
(425) 251-6222
Kaleb Mapstead, PE

SWPPP Preparation Date
February 25, 2025

Project Construction Dates
August 2025 – March 2026

Contents

1.0	Introduction.....	1
2.0	Site Description	3
2.1	Existing Conditions	3
2.2	Proposed Construction Activities	3
3.0	Construction Stormwater BMPs.....	5
3.1	The 14 BMP Elements.....	5
3.1.1	Element #1 – Mark Clearing Limits	5
3.1.2	Element #2 – Establish Construction Access.....	5
3.1.3	Element #3 – Control Flow Rates	6
3.1.4	Element #4 – Install Sediment Controls	6
3.1.5	Element #5 – Stabilize Soils.....	7
3.1.6	Element #6 – Protect Slopes.....	8
3.1.7	Element #7 – Protect Drain Inlets	8
3.1.8	Element #8 – Stabilize Channels and Outlets	9
3.1.9	Element #9 – Control Pollutants.....	10
3.1.10	Element #10 – Control Dewatering	10
3.1.11	Element #11 – Maintain BMPs.....	11
3.1.12	Element #12 – Manage the Project.....	11
3.1.13	Element #13 – Construction Stormwater Chemical Treatment.....	14
3.1.14	Element #14 – Construction Stormwater Filtration	19
3.2	Site Specific BMPs	21
4.0	Construction Phasing and BMP Implementation	22
5.0	Pollution Prevention Team	23
5.1	Roles and Responsibilities.....	23
5.2	Team Members.....	24
6.0	Site Inspections and Monitoring.....	25
6.1	Site Inspection	25
6.1.1	Site Inspection Frequency.....	25
6.1.2	Site Inspection Documentation	25
6.2	Stormwater Quality Monitoring.....	26
6.2.1	Turbidity Sampling	26
6.2.2	pH Sampling	27
7.0	Reporting and Recordkeeping	28
7.1	Recordkeeping.....	28
7.1.1	Site Log Book.....	28
7.1.2	Records Retention	28
7.1.3	Access to Plans and Records	28
7.1.4	Updating the SWPPP.....	28
7.2	Reporting	29
7.2.1	Discharge Monitoring Reports.....	29
7.2.2	Notification of Noncompliance.....	29

- Appendix A Site Plans**
- Appendix B Construction BMPs**
- Appendix C Alternative BMPs**
- Appendix D General Permit**
- Appendix E Site Inspection Forms (and Site Log)**
- Appendix F Engineering Calculations**

1.0 Introduction

This Stormwater Pollution Prevention Plan (SWPPP) has been prepared as part of the NPDES stormwater permit requirements for the Puyallup Public Safety Building project Puyallup, Washington. The proposed site is at 1015 39th Avenue SE Puyallup, Washington.

Construction activities will include installation of sediment and erosion control Best Management Practices (BMPs), construction of new tenant improvements, public and private entrances, secure parking area and mechanical, electrical infrastructure, and stormwater facilities.

The purpose of this SWPPP is to describe the proposed construction activities and all temporary and permanent erosion and sediment control (TESC) measures, pollution prevention measures, inspection/monitoring activities, and recordkeeping that will be implemented during the proposed construction project. The objectives of the SWPPP are to:

- 1. Implement Best Management Practices (BMPs) to prevent erosion and sedimentation, and to identify, reduce, eliminate or prevent stormwater contamination and water pollution from construction activity.**
- 2. Prevent violations of surface water quality, ground water quality, or sediment management standards.**
- 3. Prevent, during the construction phase, adverse water quality impacts including impacts on beneficial uses of the receiving water by controlling peak flow rates and volumes of stormwater runoff at the Permittee's outfalls and downstream of the outfalls.**

This SWPPP was prepared using the Ecology SWPPP Template downloaded from the Ecology website. This SWPPP was prepared based on the requirements set forth in the Construction Stormwater General Permit, *Stormwater Management Manual for Western Washington*. The report is divided into seven main sections with several appendices that include stormwater related reference materials. The topics presented in the each of the main sections are:

- **Section 1 – INTRODUCTION.** This section provides a summary description of the project, and the organization of the SWPPP document.
- **Section 2 – SITE DESCRIPTION.** This section provides a detailed description of the existing site conditions, proposed construction activities, and calculated stormwater flow rates for existing conditions and post-construction conditions.

- Section 3 – CONSTRUCTION BMPs. This section provides a detailed description of the BMPs to be implemented based on the 14 required elements of the SWPPP.
- Section 4 – CONSTRUCTION PHASING AND BMP IMPLEMENTATION. This section provides a description of the timing of the BMP implementation in relation to the project schedule.
- Section 5 – POLLUTION PREVENTION TEAM. This section identifies the appropriate contact names (emergency and non-emergency), monitoring personnel, and the onsite temporary erosion and sedimentation control inspector
- Section 6 – INSPECTION AND MONITORING. This section provides a description of the inspection and monitoring requirements such as the parameters of concern to be monitored, sample locations, sample frequencies, and sampling methods for all stormwater discharge locations from the site.
- Section 7 – RECORDKEEPING. This section describes the requirements for documentation of the BMP implementation, site inspections, monitoring results, and changes to the implementation of certain BMPs due to site factors experienced during construction.

Supporting documentation and standard forms are provided in the following Appendices:

- Appendix A – Site Plans
- Appendix B – Construction BMPs
- Appendix C – Alternative BMPs
- Appendix D – General Permit
- Appendix E – Site Inspection Forms (and Site Log)
- Appendix F – Engineering Calculations

2.0 Site Description

2.1 Existing Conditions

The site is approximately 77 acres in size and is currently developed with buildings, paving, parking areas, utilities, and landscaping. The existing site is irregular in shape and contains several buildings and existing data center facilities. The site was initially developed back in the 1980s. The majority of the subject property consists of impervious surfaces (buildings and asphalt pavement) surrounded by maintained lawn and ornamental, non-native landscaping. The undeveloped forested portions of the site contain fir and maple trees. The site is bound on the north and east by parcels owned by Pierce College, to the south by 39th Avenue SE and to the west by an existing senior living facility. Site soils in the area of redevelopment consist of primarily of Kapowsin gravelly ashy loam and Indianola loamy sand. Previous wetland investigations identified potential wetlands on the site, none of which are affected by the new mechanical or electrical infrastructure. The site is not located within any mapped floodplain. Please refer to the exhibits within Appendix A of this report.

The site is sloped to the northwest with elevations ranging from 545 along the eastern border to 450 at the northwest corner. A developed stormwater conveyance system exists consisting of ditches, catch basins, and stormwater pipes that collect and convey runoff from the parking areas and buildings. Stormwater flows to the northwest into a small onsite pond which flows into Bradley Lake. No drainage or erosion issues were reported or noted in our site reconnaissance.

2.2 Proposed Construction Activities

This project will install new tenant improvements with limited building envelope improvements for two (2) new entries (one public and one secure), parking lot striping, security improvements, mechanical and electrical infrastructure to support tenant loads, and stormwater facilities.

Stormwater runoff rates and volumes were calculated using WWHM hydrology model.

The following summarizes details regarding site areas:

▪ Total site area:	77.0 ± acres
▪ Percent impervious area before construction:	75%
▪ Percent impervious area after construction:	75%
▪ Percent pervious area after construction:	25%
▪ Native Vegetation to be retained:	19 acres (25%)
▪ Disturbed area during construction:	0.30± acres
▪ Disturbed area that is characterized as impervious (i.e., access roads, staging, parking):	0.23 acres
▪ Cut quantity:	170 cy
▪ Fill quantity:	120 cy
▪ Max Cut/Fill Depth	4 ± feet

All stormwater flow calculations are provided in Appendix F.

3.0 Construction Stormwater BMPs

3.1 The 14 BMP Elements

3.1.1 Element #1 – Preserve Vegetation/Mark Clearing Limits

To protect adjacent properties and to reduce the area of soil exposed to construction, the limits of construction will be clearly marked before land-disturbing activities begin. Areas that are to be preserved shall be clearly delineated, both in the field and on the plans. The BMPs relevant to marking the clearing limits that will be applied for this project include:

- Preserving Natural Vegetation (BMP C101)
- High Visibility Plastic or Metal Fence (BMP C103)

The clearing limits shall be as shown on the plans and all vegetation outside of the clearing limits preserved. Native topsoil will be preserved in the undisturbed areas of the site.

Alternate BMPs for marking clearing limits are included in Appendix C as a quick reference tool for the onsite inspector in the event the BMP(s) listed above are deemed ineffective or inappropriate during construction to satisfy the requirements set forth in the General NPDES Permit (Appendix D). To avoid potential erosion and sediment control issues that may cause a violation(s) of the NPDES Construction Stormwater permit (as provided in Appendix D), the Certified Erosion and Sediment Control Lead will promptly initiate the implementation of one or more of the alternative BMPs listed in Appendix C after the first sign that existing BMPs are ineffective or failing.

3.1.2 Element #2 – Establish Construction Access

Construction access or activities occurring on unpaved areas shall be minimized, yet where necessary, access points shall be stabilized to minimize the tracking of sediment onto public roads, and wheel washing, street sweeping, and street cleaning shall be employed to prevent sediment from entering state waters. All wash wastewater shall be controlled on site. The specific BMPs related to establishing construction access that will be used on this project include:

- Stabilized Construction Entrance (BMP C105)
- Construction Haul Road (BMP C107)
- The roads shall be swept daily should sediment collect on them. Wheel washing (BMP C106), if needed, shall occur at locations where the sediment will be retained on site.

Alternate construction access BMPs are included in Appendix C as a quick reference tool for the onsite inspector in the event the BMP(s) listed above are deemed ineffective or inappropriate during construction to satisfy the requirements set forth in the General NPDES Permit

(Appendix D). To avoid potential erosion and sediment control issues that may cause a violation(s) of the NPDES Construction Stormwater permit (as provided in Appendix D), the Certified Erosion and Sediment Control Lead will promptly initiate the implementation of one or more of the alternative BMPs listed in Appendix C after the first sign that existing BMPs are ineffective or failing.

3.1.3 Element #3 – Control Flow Rates

In order to protect the properties and waterways downstream of the project site, stormwater discharges from the site will be controlled and contained onsite.

The project site is located west of the Cascade Mountain Crest. As such, the project must comply with Minimum Requirement 7.

In general, discharge rates of stormwater from the site will be controlled where increases in impervious area or soil compaction during construction could lead to downstream erosion, or where necessary to meet local agency stormwater discharge requirements (e.g., discharge to combined sewer systems).

Alternate flow control BMPs are included in Appendix C as a quick reference tool for the onsite inspector in the event the BMP(s) listed above are deemed ineffective or inappropriate during construction to satisfy the requirements set forth in the General NPDES Permit (Appendix D). To avoid potential erosion and sediment control issues that may cause a violation(s) of the NPDES Construction Stormwater permit (as provided in Appendix D), the Certified Erosion and Sediment Control Lead will promptly initiate the implementation of one or more of the alternative BMPs listed in Appendix C after the first sign that existing BMPs are ineffective or failing.

3.1.4 Element #4 – Install Sediment Controls

All stormwater runoff from disturbed areas shall be captured by an interceptor swale and conveyed through an appropriate sediment removal BMP before leaving the construction site or prior to being discharged to the downstream drainage course. The specific BMPs to be used for controlling sediment on this project include:

- Silt Fence (BMP C233)

A silt fence shall be installed along the downstream perimeter of the proposed site.

In addition, sediment will be removed from paved areas in and adjacent to construction work areas manually or using mechanical sweepers, as needed, to minimize tracking of sediments on vehicle tires away from the site and to minimize washoff of sediments from adjacent streets in runoff.

Whenever possible, sediment-laden water shall be discharged into relatively level, vegetated areas onsite (BMP C240 paragraph 5, page 4-102). (Note: Vegetated wetlands shall not be used for this purpose).

In some cases, sediment discharge in concentrated runoff can be controlled using permanent stormwater BMPs (e.g., infiltration swales, ponds, trenches). Sediment loads can limit the effectiveness of some permanent stormwater BMPs, such as those used for infiltration or biofiltration; however, those BMPs designed to remove solids by settling (wet ponds or sediment ponds) can be used during the construction phase. When permanent stormwater BMPs will be used to control sediment discharge during construction, the structure will be protected from excessive sedimentation with adequate erosion and sediment control BMPs. Any accumulated sediment shall be removed after construction is complete and the remainder of the site has been stabilized.

The following BMPs will be implemented as end-of-pipe sediment controls as required to meet permitted turbidity limits in the site discharge(s). Prior to the implementation of these technologies, sediment sources and erosion control and soil stabilization BMP efforts will be maximized to reduce the need for end-of-pipe sedimentation controls.

- Construction Stormwater Filtration (BMP C251)
- Construction Stormwater Chemical Treatment (BMP C 250) (implemented only with prior written approval from Ecology).

Alternate sediment control BMPs are included in Appendix C as a quick reference tool for the onsite inspector in the event the BMP(s) listed above are deemed ineffective or inappropriate during construction to satisfy the requirements set forth in the General NPDES Permit (Appendix D). To avoid potential erosion and sediment control issues that may cause a violation(s) of the NPDES Construction Stormwater permit (as provided in Appendix D), the Certified Erosion and Sediment Control Lead will promptly initiate the implementation of one or more of the alternative BMPs listed in Appendix C after the first sign that existing BMPs are ineffective or failing.

3.1.5 Element #5 – Stabilize Soils

Exposed and unworked soils shall be stabilized with the application of effective BMPs to prevent erosion throughout the life of the project. The specific BMPs for soil stabilization that shall be used on this project include:

- Temporary and Permanent Seeding (BMP C120)
- Mulching (BMP C121)
- Plastic Covering (BMP C123)
- Dust Control (BMP C140)

Seeding shall occur on all areas to remain unworked pursuant to below. Dust shall be controlled if construction occurs during the summer. The project site is located west of the Cascade Mountain Crest. As such, no soils shall remain exposed and unworked for more than 7 days during the dry season (May 1 to September 30) and 2 days during the wet season (October 1 to April 30). Regardless of the time of year, all soils shall be stabilized at the end of the shift before a holiday or weekend if needed based on weather forecasts.

In general, cut and fill slopes will be stabilized as soon as possible and soil stockpiles will be temporarily covered with plastic sheeting. All stockpiled soils shall be stabilized from erosion, protected with sediment trapping measures, and where possible, be located away from storm drain inlets, waterways, and drainage channels.

Alternate soil stabilization BMPs are included in Appendix C as a quick reference tool for the onsite inspector in the event the BMP(s) listed above are deemed ineffective or inappropriate during construction to satisfy the requirements set forth in the General NPDES Permit (Appendix D). To avoid potential erosion and sediment control issues that may cause a violation(s) of the NPDES Construction Stormwater permit (as provided in Appendix D), the Certified Erosion and Sediment Control Lead will promptly initiate the implementation of one or more of the alternative BMPs listed in Appendix C after the first sign that existing BMPs are ineffective or failing.

3.1.6 Element #6 – Protect Slopes

All cut and fill slopes will be designed, constructed, and protected in a manner that minimizes erosion.

The following specific BMPs will be used to protect slopes for this project:

- Temporary and Permanent Seeding (BMP C120)
- Nets and Blankets (BMP C122)

Temporary and permanent seeding shall be used at all exposed areas pursuant to the prior mentioned schedule (seasonal restrictions). Swales shall be used to convey stormwater from the steep slopes to the east of the site into the northern sediment trap. Nets shall be used to stabilize slopes on the eastern portion of the site with steep slopes.

Alternate slope protection BMPs are included in Appendix C as a quick reference tool for the onsite inspector in the event the BMP(s) listed above are deemed ineffective or inappropriate during construction to satisfy the requirements set forth in the General NPDES Permit (Appendix D). To avoid potential erosion and sediment control issues that may cause a violation(s) of the NPDES Construction Stormwater permit (as provided in Appendix D), the Certified Erosion and Sediment Control Lead will promptly initiate the implementation of one or more of the alternative BMPs listed in Appendix C after the first sign that existing BMPs are ineffective or failing.

3.1.7 Element #7 – Protect Drain Inlets

All storm drain inlets and culverts made operable during construction shall be protected to prevent unfiltered or untreated water from entering the drainage conveyance system. However, the first priority is to keep all access roads clean of sediment and keep street wash water separate from entering storm drains until treatment can be provided. Storm Drain Inlet Protection (BMP C220) will be implemented for all drainage inlets and culverts that could

potentially be impacted by sediment-laden runoff on and near the project site. The following inlet protection measures will be applied on this project:

- Excavated Drop Inlet Protection
- Block and Gravel Drop Inlet Protection
- Gravel and Wire Drop Inlet Protection
- Catch Basin Filters
- Culvert Inlet Sediment Trap

Inlets shall be inspected weekly at a minimum and daily during storm events.

If the BMP options listed above are deemed ineffective or inappropriate during construction to satisfy the requirements set forth in the General NPDES Permit (Appendix D), or if no BMPs are listed above but deemed necessary during construction, the Certified Erosion and Sediment Control Lead shall implement one or more of the alternative BMP inlet protection options listed in Appendix C.

3.1.8 Element #8 – Stabilize Channels and Outlets

Where site runoff is to be conveyed in channels, or discharged to a stream or some other natural drainage point, efforts will be taken to prevent downstream erosion. The specific BMPs for channel and outlet stabilization that shall be used on this project include:

- Outlet protection (BMP C209)
- Grass-Lined Channels (BMP C201)

The site runoff shall be discharged into the pond area of the permanent detention pond on site. The pond discharges to the existing drainage system located onsite.

The project site is located west of the Cascade Mountain Crest. As such, any temporary on-site conveyance channels shall be designed, constructed, and stabilized following BMP C201 to prevent erosion from the expected peak 10 minute velocity of flow from a Type 1A, 10-year, 24-hour recurrence interval storm for the developed condition. Alternatively, the 10-year, 1-hour peak flow rate indicated by an approved continuous runoff simulation model, increased by a factor of 1.6, shall be used. Stabilization, including armoring material, adequate to prevent erosion of outlets, adjacent streambanks, slopes, and downstream reaches shall be provided at the outlets of all conveyance systems.

Alternate channel and outlet stabilization BMPs are included in Appendix C as a quick reference tool for the onsite inspector in the event the BMP(s) listed above are deemed ineffective or inappropriate during construction to satisfy the requirements set forth in the General NPDES Permit (Appendix D). To avoid potential erosion and sediment control issues that may cause a violation(s) of the NPDES Construction Stormwater permit (as provided in Appendix D), the Certified Erosion and Sediment Control Lead will promptly initiate the implementation of one or

more of the alternative BMPs listed in Appendix C after the first sign that existing BMPs are ineffective or failing.

3.1.9 Element #9 – Control Pollutants

All pollutants, including waste materials and demolition debris, that occur onsite shall be handled and disposed of in a manner that does not cause contamination of stormwater. Good housekeeping and preventative measures will be taken to ensure that the site will be kept clean, well organized, and free of debris. If required, BMPs to be implemented to control specific sources of pollutants are discussed below. Vehicles, construction equipment, and/or petroleum product storage/dispensing:

- All vehicles, equipment, and petroleum product storage/dispensing areas will be inspected regularly to detect any leaks or spills, and to identify maintenance needs to prevent leaks or spills.
- On-site fueling tanks and petroleum product storage containers shall include secondary containment.
- Spill prevention measures, such as drip pans, will be used when conducting maintenance and repair of vehicles or equipment.
- In order to perform emergency repairs on site, temporary plastic will be placed beneath and, if raining, over the vehicle.
- Contaminated surfaces shall be cleaned immediately following any discharge or spill incident.

Demolition:

- Storm drain inlets vulnerable to stormwater discharge carrying dust, soil, or debris will be protected using Storm Drain Inlet Protection (BMP C220 as described above for Element 7).

Concrete and grout:

- Concrete trucks shall not be washed out onto the ground.
- Process water and slurry resulting from concrete work will be prevented from entering the waters of the State by implementing Concrete Handling measures (BMP C151).

3.1.10 Element #10 – Control Dewatering

All dewatering water from open cut excavation, tunneling, foundation work, trench, or underground vaults shall be discharged into a controlled conveyance system prior to discharge to the downstream drainage course. Channels will be stabilized, per Element #8. Clean, non-turbid dewatering water will be discharged directly into systems tributary to the receiving waters of the State in a manner that does not cause erosion, flooding, or a violation of State water quality standards in the receiving water. Highly turbid dewatering water from soils known or

suspected to be contaminated, or from use of construction equipment, will require additional monitoring and treatment as required for the specific pollutants based on the receiving waters into which the discharge is occurring. Such monitoring is the responsibility of the contractor.

However, the dewatering of soils known to be free of contamination will trigger BMPs to trap sediment and reduce turbidity. At a minimum, geotextile fabric socks/bags/cells will be used to filter this material. At this time no dewatering is anticipated on this site.

If project dewatering is proposed to be discharged to the City sewer system, a "Construction Site Dewatering Permit" must be obtained by the contractor. Contact city of Puyallup source Control Specialist, Eric Rogers, at 253-847-5523 for permit application.

Alternate dewatering control BMPs are included in Appendix C as a quick reference tool for the onsite inspector in the event the BMP(s) listed above are deemed ineffective or inappropriate during construction to satisfy the requirements set forth in the General NPDES Permit (Appendix D). To avoid potential erosion and sediment control issues that may cause a violation(s) of the NPDES Construction Stormwater permit (as provided in Appendix D), the Certified Erosion and Sediment Control Lead will promptly initiate the implementation of one or more of the alternative BMPs listed in Appendix C after the first sign that existing BMPs are ineffective or failing.

3.1.11 Element #11 – Maintain BMPs

All temporary and permanent erosion and sediment control BMPs shall be maintained and repaired as needed to assure continued performance of their intended function. Maintenance and repair shall be conducted in accordance with each particular BMP's specifications (See 2005 SWMM WW, Vol II). Visual monitoring of the BMPs will be conducted at least once every calendar week and within 24 hours of any rainfall event that causes a discharge from the site. If the site becomes inactive, and is temporarily stabilized, the inspection frequency will be reduced to once every month.

All temporary erosion and sediment control BMPs shall be removed within 30 days after the final site stabilization is achieved or after the temporary BMPs are no longer needed. Trapped sediment shall be removed or stabilized on site. Disturbed soil resulting from removal of BMPs or vegetation shall be permanently stabilized.

3.1.12 Element #12 – Manage the Project

Erosion and sediment control BMPs for this project have been designed based on the following principles:

- Design the project to fit the existing topography, soils, and drainage patterns.
- Emphasize erosion control rather than sediment control.
- Minimize the extent and duration of the area exposed.
- Keep runoff velocities low.

- Retain sediment on site.
- Thoroughly monitor site and maintain all ESC measures.
- Schedule major earthwork during the dry season.

In addition, project management will incorporate the key components listed below:

As this project site is located west of the Cascade Mountain Crest, the project will be managed according to the following key project components:

Phasing of Construction

- Revegetation of exposed areas and maintenance of that vegetation shall be an integral part of the clearing activities during each phase of construction, per the Scheduling BMP (C 162).

Seasonal Work Limitations

- From October 1 through April 30, clearing, grading, and other soil disturbing activities shall only be permitted if shown to the satisfaction of the local permitting authority that silt-laden runoff will be prevented from leaving the site through a combination of the following:
 - Site conditions including existing vegetative coverage, slope, soil type, and proximity to receiving waters; and
 - Limitations on activities and the extent of disturbed areas; and
 - Proposed erosion and sediment control measures.
- Based on the information provided and/or local weather conditions, the local permitting authority may expand or restrict the seasonal limitation on site disturbance.
- The following activities are exempt from the seasonal clearing and grading limitations:
 - Routine maintenance and necessary repair of erosion and sediment control BMPs;
 - Routine maintenance of public facilities or existing utility structures that do not expose the soil or result in the removal of the vegetative cover to soil; and
 - Activities where there is 100 percent infiltration of surface water runoff within the site in approved and installed erosion and sediment control facilities.

Coordination with Utilities and Other Jurisdictions

- Care has been taken to coordinate with utilities, other construction projects, and the local jurisdiction in preparing this SWPPP and scheduling the construction work.

Inspection and Monitoring

- All BMPs shall be inspected, maintained, and repaired as needed to assure continued performance of their intended function. Site inspections shall be conducted by a person who is knowledgeable in the principles and practices of erosion and sediment control. This person has the necessary skills to:
 - Assess the site conditions and construction activities that could impact the quality of stormwater, and
 - Assess the effectiveness of erosion and sediment control measures used to control the quality of stormwater discharges.
- A Certified Erosion and Sediment Control Lead shall be on-site or on-call at all times.
- Whenever inspection and/or monitoring reveals that the BMPs identified in this SWPPP are inadequate, due to the actual discharge of or potential to discharge a significant amount of any pollutant, appropriate BMPs or design changes shall be implemented as soon as possible.

Maintaining an Updated Construction SWPPP

- This SWPPP shall be retained on-site or within reasonable access to the site.
- The SWPPP shall be modified whenever there is a change in the design, construction, operation, or maintenance at the construction site that has, or could have, a significant effect on the discharge of pollutants to waters of the state.
- The SWPPP shall be modified if, during inspections or investigations conducted by the owner/operator, or the applicable local or state regulatory authority, it is determined that the SWPPP is ineffective in eliminating or significantly minimizing pollutants in stormwater discharges from the site. The SWPPP shall be modified as necessary to include additional or modified BMPs designed to correct problems identified. Revisions to the SWPPP shall be completed within seven (7) days following the inspection.

3.1.13 Element #13 – Construction Stormwater Chemical Treatment

Turbidity is difficult to control once fine particles are suspended in stormwater runoff from a construction site. Sedimentation ponds are effective at removing larger particulate matter by gravity settling, but are ineffective at removing smaller particulates such as clay and fine silt. Sediment ponds are typically designed to remove sediment no smaller than medium silt (0.02 mm). Chemical treatment may be used to reduce the turbidity of stormwater runoff.

Chemical treatment can reliably provide exceptional reductions of turbidity and associated pollutants. Very high turbidities can be reduced to levels comparable to what is found in streams during dry weather. Traditional BMPs used to control soil erosion and sediment loss from sites under development may not be adequate to ensure compliance with the water quality standard for turbidity in the receiving water. Chemical treatment may be required to protect streams from the impact of turbid stormwater discharges, especially when construction is to proceed through the wet season.

Formal written approval from Ecology and the Local Permitting Authority is required for the use of chemical treatment regardless of site size. The intention to use Chemical Treatment shall be indicated on the Notice of Intent for coverage under the General Construction Permit. Chemical treatment systems should be designed as part of the Construction SWPPP, not after the fact. Chemical treatment may be used to correct problem sites in limited circumstances with formal written approval from Ecology and the Local Permitting Authority.

The SEPA review authority must be notified at the application phase of the project review (or the time that the SEPA determination on the project is performed) that chemical treatment is proposed. If it is added after this stage, an addendum will be necessary and may result in project approval delay.

See Appendix II-B Vol. II, Ecology 2019 SWMMWW for background information on chemical treatment.

Criteria for Chemical Treatment Product Use

Chemically treated stormwater discharged from construction sites must be nontoxic to aquatic organisms. The following protocol shall be used to evaluate chemicals proposed for stormwater treatment at construction sites. Authorization to use a chemical in the field based on this protocol does not relieve the applicant from responsibility for meeting all discharge and receiving water criteria applicable to a site.

- Treatment chemicals must be approved by EPA for potable water use.
- Petroleum-based polymers are prohibited.
- Prior to authorization for field use, jar tests shall be conducted to demonstrate that turbidity reduction necessary to meet the receiving

water criteria can be achieved. Test conditions, including but not limited to raw water quality and jar test procedures, should be indicative of field conditions. Although these small-scale tests cannot be expected to reproduce performance under field conditions, they are indicative of treatment capability.

- Prior to authorization for field use, the chemically treated stormwater shall be tested for aquatic toxicity. Applicable procedures defined in Chapter 173-205 WAC, Whole Effluent Toxicity Testing and Limits, shall be used. Testing shall use stormwater from the construction site at which the treatment chemical is proposed for use or a water solution using soil from the proposed site.
- The proposed maximum dosage shall be at least a factor of five lower than the no observed effects concentration (NOEC).
- The approval of a proposed treatment chemical shall be conditional, subject to full-scale bioassay monitoring of treated stormwater at the construction site where the proposed treatment chemical is to be used.
- Treatment chemicals that have already passed the above testing protocol do not need to be reevaluated. Contact the Department of Ecology Regional Office for a list of treatment chemicals that have been evaluated and are currently approved for use.

Treatment System Design Considerations

The design and operation of a chemical treatment system should take into consideration the factors that determine optimum, cost-effective performance. It may not be possible to fully incorporate all of the classic concepts into the design because of practical limitations at construction sites. Nonetheless, it is important to recognize the following:

- The right chemical must be used at the right dosage. A dosage that is either too low or too high will not produce the lowest turbidity. There is an optimum dosage rate. This is a situation where the adage "adding more is always better" is not the case.
- The coagulant must be mixed rapidly into the water to insure proper dispersion.
- A flocculation step is important to increase the rate of settling, to produce the lowest turbidity, and to keep the dosage rate as low as possible.
- Too little energy input into the water during the flocculation phase results in flocs that are too small and/or insufficiently dense. Too much energy can rapidly destroy floc as it is formed.

- Since the volume of the basin is a determinant in the amount of energy per unit volume, the size of the energy input system can be too small relative to the volume of the basin.
- Care must be taken in the design of the withdrawal system to minimize outflow velocities and to prevent floc discharge. The discharge should be directed through a physical filter such as a vegetated swale that would catch any unintended floc discharge.

Treatment System Design

Chemical treatment systems shall be designed as batch treatment systems using either ponds or portable trailer-mounted tanks. Flow-through continuous treatment systems are not allowed at this time.

A chemical treatment system consists of the stormwater collection system (either temporary diversion or the permanent site drainage system), a storage pond, pumps, a chemical feed system, treatment cells, and interconnecting piping.

The treatment system shall use a minimum of two lined treatment cells. Multiple treatment cells allow for clarification of treated water while other cells are being filled or emptied. Treatment cells may be ponds or tanks. Ponds with constructed earthen embankments greater than six feet high require special engineering analyses. Portable tanks may also be suitable for some sites.

The following equipment should be located in an operations shed:

- the chemical injector;
- secondary containment for acid, caustic, buffering compound, and treatment chemical;
- emergency shower and eyewash, and
- monitoring equipment which consists of a pH meter and a turbidimeter.

Sizing Criteria

The combination of the storage pond or other holding area and treatment capacity should be large enough to treat stormwater during multiple day storm events. It is recommended that at a minimum the storage pond or other holding area should be sized to hold 1.5 times the runoff volume of the 10-year, 24-hour storm event. Bypass should be provided around the chemical treatment system to accommodate extreme storm events. Runoff volume shall be calculated using the methods presented in Volume 3, Chapter 2. If no hydrologic analysis is required for the site, the Rational Method may be used.

Primary settling should be encouraged in the storage pond. A forebay with access for maintenance may be beneficial.

There are two opposing considerations in sizing the treatment cells. A larger cell is able to treat a larger volume of water each time a batch is processed. However, the larger the cell the longer the time required to empty the cell. A larger cell may also be less effective at flocculation and therefore require a longer settling time. The simplest approach to sizing the treatment cell is to multiply the allowable discharge flow rate times the desired drawdown time. A 4-hour drawdown time allows one batch per cell per 8-hour work period, given 1 hour of flocculation followed by two hours of settling.

The permissible discharge rate governed by potential downstream effect can be used to calculate the recommended size of the treatment cells. The following discharge flow rate limits shall apply:

- If the discharge is directly or indirectly to a stream, the discharge flow rate shall not exceed 50 percent of the peak flow rate of the 2-year, 24-hour event for all storm events up to the 10-year, 24-hour event.
- If discharge is occurring during a storm event equal to or greater than the 10-year, 24-hour event, the allowable discharge rate is the peak flow rate of the 10-year, 24-hour event.
- Discharge to a stream should not increase the stream flow rate by more than 10 percent.
- If the discharge is directly to a lake, a major receiving water listed in Appendix C of Volume I, or to an infiltration system, there is no discharge flow limit.
- If the discharge is to a municipal storm drainage system, the allowable discharge rate may be limited by the capacity of the public system. It may be necessary to clean the municipal storm drainage system prior to the start of the discharge to prevent scouring solids from the drainage system.
- Runoff rates shall be calculated using the methods presented in Volume 3, Chapter 2 for the pre-developed condition. If no hydrologic analysis is required for the site, the Rational Method may be used.

Monitoring

The following monitoring shall be conducted. Test results shall be recorded on a daily log kept on site:

Operational Monitoring

- pH, conductivity (as a surrogate for alkalinity), turbidity and temperature of the untreated stormwater
- Total volume treated and discharged
- Discharge time and flow rate
- Type and amount of chemical used for pH adjustment
- Amount of polymer used for treatment
- Settling time

Compliance Monitoring

- pH and turbidity of the treated stormwater
- pH and turbidity of the receiving water

Biomonitoring: Treated stormwater shall be tested for acute (lethal) toxicity. Bioassays shall be conducted by a laboratory accredited by Ecology, unless otherwise approved by Ecology. **The performance standard for acute toxicity is no statistically significant difference in survival between the control and 100 percent chemically treated stormwater.**

Acute toxicity tests shall be conducted with the following species and protocols:

- Fathead minnow, *Pimephales promelas* (96 hour static-renewal test, method: EPA/600/4-90/027F). Rainbow trout, *Oncorhynchus mykiss* (96 hour static-renewal test, method: EPA/600/4-90/027F) may be used as a substitute for fathead minnow.
- Daphnid, *Ceriodaphnia dubia*, *Daphnia pulex*, or *Daphnia magna* (48 hour static test, method: EPA/600/4-90/027F).

All toxicity tests shall meet quality assurance criteria and test conditions in the most recent versions of the EPA test method and Ecology Publication # WO-R-95-80, Laboratory Guidance and Whole Effluent Toxicity Test Review Criteria.

Bioassays shall be performed on the *first* five batches and on every tenth batch thereafter, or as otherwise approved by Ecology. Failure to meet the performance standard shall be immediately reported to Ecology.

Discharge Compliance: Prior to discharge, each batch of treated stormwater must be sampled and tested for compliance with pH and turbidity limits. These limits may be established by the water quality standards or a site-specific discharge permit. Sampling and testing for other pollutants may also be necessary at some sites. Turbidity must be within 5 NTUs of the background turbidity. Background is measured in the receiving water, upstream

from the treatment process discharge point. pH must be within the range of 6.5 to 8.5 standard units and not cause a change in the pH of the receiving water of more than 0.2 standard units. It is often possible to discharge treated stormwater that has a lower turbidity than the receiving water and that matches the pH.

Treated stormwater samples and measurements shall be taken from the discharge pipe or another location representative of the nature of the treated stormwater discharge. Samples used for determining compliance with the water quality standards in the receiving water shall not be taken from the treatment pond prior to decanting. Compliance with the water quality standards is determined in the receiving water.

Operator Training

Each contractor who intends to use chemical treatment shall be trained by an experienced contractor on an active site for at least 40 hours.

Standard BMPs

Surface stabilization BMPs should be implemented on site to prevent significant erosion. All sites shall use a truck wheel wash to prevent tracking of sediment off site.

Sediment Removal and Disposal

- Sediment shall be removed from the storage or treatment cells as necessary. Typically, sediment removal is required at least once during a wet season and at the decommissioning of the cells. Sediment remaining in the cells between batches may enhance the settling process and reduce the required chemical dosage.
- Sediment may be incorporated into the site away from drainages.

3.1.14 Element #14 – Construction Stormwater Filtration

Filtration removes sediment from runoff originating from disturbed areas of the site.

Traditional BMPs used to control soil erosion and sediment loss from sites under development may not be adequate to ensure compliance with the water quality standard for turbidity in the receiving water. Filtration may be used in conjunction with gravity settling to remove sediment as small as fine silt (0.5 µm). The reduction in turbidity will be dependent on the particle size distribution of the sediment in the stormwater. In some circumstances, sedimentation and filtration may achieve compliance with the water quality standard for turbidity.

Unlike chemical treatment, the use of construction stormwater filtration does not require approval from Ecology.

Filtration may also be used in conjunction with polymer treatment in a portable system to assure capture of the flocculated solids.

Design and Installation Specifications – Background Information

Filtration with sand media has been used for over a century to treat water and wastewater. The use of sand filtration for treatment of stormwater has developed recently, generally to treat runoff from streets, parking lots, and residential areas. The application of filtration to construction stormwater treatment is currently under development.

Two types of filtration systems may be applied to construction stormwater treatment: rapid and slow. Rapid sand filters are the typical system used for water and wastewater treatment. They can achieve relatively high hydraulic flow rates, on the order of 2 to 20 gpm/sf, because they have automatic backwash systems to remove accumulated solids. In contrast, slow sand filters have very low hydraulic rates, on the order of 0.02 gpm/sf, because they do not have backwash systems. To date, slow sand filtration has generally been used to treat stormwater. Slow sand filtration is mechanically simple in comparison to rapid sand filtration but requires a much larger filter area.

Filtration Equipment

Sand media filters are available with automatic backwashing features that can filter to 50 µm particle size. Screen or bag filters can filter down to 5 µm. Fiber wound filters can remove particles down to 0.5 µm. Filters should be sequenced from the largest to the smallest pore opening. Sediment removal efficiency will be related to particle size distribution in the stormwater.

Treatment Process Description

Stormwater is collected at interception point(s) on the site and is diverted to a sediment pond or tank for removal of large sediment and storage of the stormwater before it is treated by the filtration system. The stormwater is pumped from the trap, pond, or tank through the filtration system in a rapid sand filtration system. Slow sand filtration systems are designed as flow through systems using gravity.

If large volumes of concrete are being poured, pH adjustment may be necessary.

Maintenance Standards

Rapid sand filters typically have automatic backwash systems that are triggered by a pre-set pressure drop across the filter. If the backwash water volume is not large or substantially more turbid than the stormwater stored in the holding pond or tank, backwash return to the pond or tank may be appropriate. However, land application or another means of treatment and disposal may be necessary.

- Screen, bag, and fiber filters must be cleaned and/or replaced when they become clogged.

- Sediment shall be removed from the storage and/or treatment ponds as necessary. Typically, sediment removal is required once or twice during a wet season and at the decommissioning of the ponds.

3.2 Site Specific BMPs

Site specific BMPs are shown on the TESC Plan Sheets and Details in Appendix A. These site specific plan sheets will be updated annually.

4.0 Construction Phasing and BMP Implementation

The BMP implementation schedule will be driven by the construction schedule. The following provides a sequential list of the proposed construction schedule milestones and the corresponding BMP implementation schedule. The list contains key milestones such as wet season construction.

The BMP implementation schedule listed below is keyed to proposed phases of the construction project, and reflects differences in BMP installations and inspections that relate to wet season construction. The project site is located west of the Cascade Mountain Crest. As such, the dry season is considered to be from May 1 to September 30 and the wet season is considered to be from October 1 to April 30.

- Estimate of Construction start date: August 2025
- Estimate of Construction finish date: March 2026
- Mobilize equipment on site: _____
- Mobilize and store all ESC and soil stabilization products (store materials on hand BMP C150): _____
- Install ESC measures: _____
- Install stabilized construction entrance: _____
- Begin clearing and grubbing: _____
- Temporary erosion control measures (hydroseeding): _____
- Site inspections reduced to monthly: _____
- Begin concrete pour and implement BMP C151: _____
- Excavate and install new utilities and services (Phase 1): _____
- Complete utility construction: _____
- Begin implementing soil stabilization and sediment control BMPs throughout the site in preparation for wet season: _____
- **WET SEASON STARTS:** October 1, 2025

5.0 Pollution Prevention Team

5.1 Roles and Responsibilities

The pollution prevention team consists of personnel responsible for implementation of the SWPPP, including the following:

- Certified Erosion and Sediment Control Lead (CESCL) – primary contractor contact, responsible for site inspections (BMPs, visual monitoring, sampling, etc.); to be called upon in case of failure of any ESC measures.
- Resident Engineer – For projects with engineered structures only (sediment ponds/traps, sand filters, etc.): site representative for the owner that is the project's supervising engineer responsible for inspections and issuing instructions and drawings to the contractor's site supervisor or representative
- Emergency Ecology Contact – individual to be contacted at Ecology in case of emergency. Go to the following website to get the name and number for the Ecology contact information:
<http://www.ecy.wa.gov/org.html>.
- Emergency Owner Contact – individual that is the site owner or representative of the site owner to be contacted in the case of an emergency.
- Non-Emergency Ecology Contact – individual that is the site owner or representative of the site owner than can be contacted if required.
- Monitoring Personnel – personnel responsible for conducting water quality monitoring; for most sites this person is also the Certified Erosion and Sediment Control Lead.

5.2 Team Members

Names and contact information for those identified as members of the pollution prevention team are provided in the following table.

Title	Name(s)	Phone Number
Certified Erosion and Sediment Control Lead (CESCL)	TBD	
Resident Engineer	Cara Visintainer	(425) 251-6222
Emergency Ecology Contact	Clay Keown	(360) 407-6048
Emergency Owner Contact		
Non-Emergency Ecology Contact		
Monitoring Personnel	TBD	

6.0 Site Inspections and Monitoring

Monitoring includes visual inspection, monitoring for water quality parameters of concern, and documentation of the inspection and monitoring findings in a site log book. A site log book will be maintained for all on-site construction activities and will include:

- A record of the implementation of the SWPPP and other permit requirements;
- Site inspections; and,
- Stormwater quality monitoring.

For convenience, the inspection form and water quality monitoring forms included in this SWPPP include the required information for the site log book. This SWPPP may function as the site log book if desired, or the forms may be separated and included in a separate site log book. However, if separated, the site log book but must be maintained on-site or within reasonable access to the site and be made available upon request to Ecology or the local jurisdiction.

6.1 Site Inspection

All BMPs will be inspected, maintained, and repaired as needed to assure continued performance of their intended function. The inspector will be a Certified Erosion and Sediment Control Lead (CESCL) per BMP C160. The name and contact information for the CESCL is provided in Section 5 of this SWPPP.

Site inspection will occur in all areas disturbed by construction activities and at all stormwater discharge points. Stormwater will be examined for the presence of suspended sediment, turbidity, discoloration, and oily sheen. The site inspector will evaluate and document the effectiveness of the installed BMPs and determine if it is necessary to repair or replace any of the BMPs to improve the quality of stormwater discharges. All maintenance and repairs will be documented in the site log book or forms provided in this document. All new BMPs or design changes will be documented in the SWPPP as soon as possible.

6.1.1 Site Inspection Frequency

Site inspections will be conducted at least once a week and within 24 hours following any rainfall event which causes a discharge of stormwater from the site. For sites with temporary stabilization measures, the site inspection frequency can be reduced to once every month.

6.1.2 Site Inspection Documentation

The site inspector will record each site inspection using the site log inspection forms provided in Appendix E. The site inspection log forms may be separated from this SWPPP document, but will be maintained on-site or within reasonable access to the site and be made available upon request to Ecology or the local jurisdiction.

6.2 Stormwater Quality Monitoring

6.2.1 Turbidity Sampling

Monitoring requirements for the proposed project will include either turbidity or water transparency sampling to monitor site discharges for water quality compliance with the 2019 Construction Stormwater General Permit (Appendix D). Sampling will be conducted at all discharge points at least once per calendar week.

Turbidity or transparency monitoring will follow the analytical methodologies described in Section S4 of the 2005 Construction Stormwater General Permit (Appendix D). The key benchmark values that require action are 25 NTU for turbidity (equivalent to 32 cm transparency) and 250 NTU for turbidity (equivalent to 6 cm transparency). If the 25 NTU benchmark for turbidity (equivalent to 32 cm transparency) is exceeded, the following steps will be conducted:

1. Ensure all BMPs specified in this SWPPP are installed and functioning as intended.
2. Assess whether additional BMPs should be implemented, and document revisions to the SWPPP as necessary.
3. Sample discharge location daily until the analysis results are less than 25 NTU (turbidity) or greater than 32 cm (transparency).

If the turbidity is greater than 25 NTU (or transparency is less than 32 cm) but less than 250 NTU (transparency greater than 6 cm) for more than 3 days, additional treatment BMPs will be implemented within 24 hours of the third consecutive sample that exceeded the benchmark.

If the 250 NTU benchmark for turbidity (or less than 6 cm transparency) is exceeded at any time, the following steps will be conducted:

1. Notify Ecology by phone within 24 hours of analysis (see Section 5.0 of this SWPPP for contact information).
2. Continue daily sampling until the turbidity is less than 25 NTU (or transparency is greater than 32 cm).
3. Initiate additional treatment BMPs such as off-site treatment, infiltration, filtration, and chemical treatment within 24 hours of the first 250 NTU exceedance.
4. Implement additional treatment BMPs as soon as possible, but within 7 days of the first 250 NTU exceedance.
5. Describe inspection results and remedial actions taken in the site log book and in monthly discharge monitoring reports as described in Section 7.0 of this SWPPP.

6.2.2 pH Sampling

Stormwater runoff will be monitored for pH starting on the first day of any activity that includes more than 40 yards of poured or recycled concrete, or after the application of "Engineered Soils" such as Portland cement treated base, cement kiln dust, or fly ash. This does not include fertilizers. For concrete work, pH monitoring will start the first day concrete is poured and continue until 3 weeks after the last pour. For engineered soils, the pH monitoring period begins when engineered soils are first exposed to precipitation and continue until the area is fully stabilized.

Stormwater samples will be collected daily from all points of discharge from the site and measured for pH using a calibrated pH meter, pH test kit, or wide range pH indicator paper. If the measured pH is 8.5 or greater, the following steps will be conducted:

1. Prevent the high pH water from entering storm drains or surface water.
2. Adjust or neutralize the high pH water if necessary using appropriate technology such as CO₂ sparging (liquid or dry ice).
3. Contact Ecology if chemical treatment other than CO₂ sparging is planned.

7.0 Reporting and Recordkeeping

7.1 Recordkeeping

7.1.1 Site Log Book

A site log book will be maintained for all on-site construction activities and will include:

- A record of the implementation of the SWPPP and other permit requirements;
- Site inspections; and,
- Stormwater quality monitoring.

For convenience, the inspection form and water quality monitoring forms included in this SWPPP include the required information for the site logbook.

7.1.2 Records Retention

Records of all monitoring information (site log book, inspection reports/checklists, etc.), this Stormwater Pollution Prevention Plan, and any other documentation of compliance with permit requirements will be retained during the life of the construction project and for a minimum of three years following the termination of permit coverage in accordance with permit condition S5.C.

7.1.3 Access to Plans and Records

The SWPPP, General Permit, Notice of Authorization letter, and Site Log Book will be retained on site or within reasonable access to the site and will be made immediately available upon request to Ecology or the local jurisdiction. A copy of this SWPPP will be provided to Ecology within 14 days of receipt of a written request for the SWPPP from Ecology. Any other information requested by Ecology will be submitted within a reasonable time. A copy of the SWPPP or access to the SWPPP will be provided to the public when requested in writing in accordance with Permit Condition S5.G.

7.1.4 Updating the SWPPP

In accordance with Conditions S3, S4.B, and S9.B.3 of the General Permit, this SWPPP will be modified if the SWPPP is ineffective in eliminating or significantly minimizing pollutants in stormwater discharges from the site or there has been a change in design, construction, operation, or maintenance at the site that has a significant effect on the discharge, or potential for discharge, of pollutants to the waters of the State. The SWPPP will be modified within seven days of determination based on inspection(s) that additional or modified BMPs are necessary to correct problems identified, and an updated timeline for BMP implementation will be prepared.

7.2 Reporting

7.2.1 Discharge Monitoring Reports

Discharge Monitoring Reports (DMRs) will be submitted to Ecology monthly. If there was no discharge during a given monitoring period the DMR will be submitted as required, reporting "No Discharge". The DMR due date is fifteen (15) days following the end of each calendar month.

7.2.2 Notification of Noncompliance

If any of the terms and conditions of the permit are not met, and it causes a threat to human health or the environment, the following steps will be taken in accordance with permit section S5.F:

1. Ecology will be notified within 24 hours of the failure to comply.
2. Immediate action will be taken to stop or correct the noncompliance issue and to correct the problem. If applicable, sampling and analysis of any noncompliance will be repeated immediately and the results submitted to Ecology within five (5) days of becoming aware of the violation.
3. A detailed written report describing the noncompliance will be submitted to Ecology within five (5) days, unless requested earlier by Ecology.
4. Anytime turbidity sampling indicated turbidity is 250 NTUs or greater, or water transparency is 6cm or less, ecology will be notified by phone within 24 hours of analysis.

Appendix A – Site Plans

COVER SHEET FOR PUYALLUP PUBLIC SAFETY BUILDING

A PORTION OF THE NE 1/4, SE 1/4, NW 1/4 & SW 1/4, OF THE SE 1/4 OF SEC. 3, TWN. 19 N, RGE. 4 E, W.M. CITY OF PUYALLUP, PIERCE COUNTY, WASHINGTON

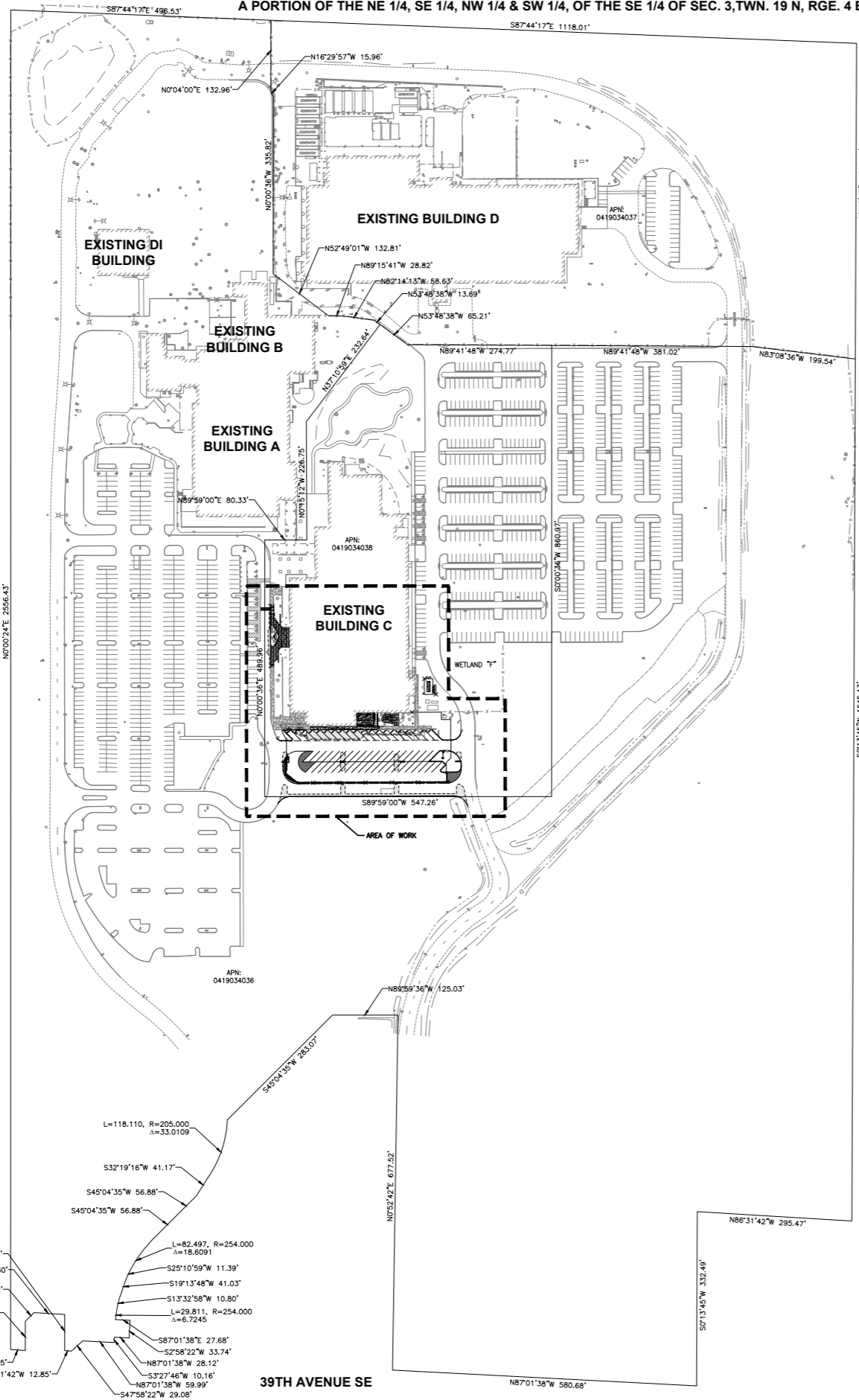

SITE INFORMATION

SITE ADDRESS: 1015 39TH AVENUE SE
PUYALLUP, WA 98374-2121

PARCEL NUMBER: 0419034036, 0419034038

PARCEL SIZE: 61.28 ACRES, 9.62 ACRES

EXISTING USE: BUSINESS PARK

ZONING DESIGNATION: BUSINESS PARK (MP)

FEMA FLOODPLAIN: ZONE X - AREAS DETERMINED TO BE OUTSIDE THE 0.2% ANNUAL CHANCE FLOODPLAIN

LEGAL DESCRIPTION: LOTS 1 THROUGH 3, CITY OF PUYALLUP BOUNDARY LINE REVISION NO. P-21-0138, RECORDED MARCH 22, 2022 UNDER RECORDING NO. 202203225003, IN PIERCE COUNTY, WASHINGTON.

ARCHITECT

MACKENZIE INC.
500 UNION STREET, SUITE 410
SEATTLE, WA 98101
(206) 749-9993
CONTACT: BRETT HANSON, ARCHITECT

CIVIL ENGINEER

BARGHAUSEN CONSULTING ENGINEERS, LLC.
18215 72ND AVE SOUTH
KENT, WA 98032
(425) 251-6222
CONTACT: CARA VISINTAINER, PE

LAND SURVEYOR

BARGHAUSEN CONSULTING ENGINEERS, LLC.
18215 72ND AVE SOUTH
KENT, WA 98032
(425) 251-6222
CONTACT: DAVE WILLIAMS

SURVEY INFORMATION

HORIZONTAL DATUM - NAD 83/91:
THE BASIS OF BEARINGS IS THE BEARING BETWEEN PIERCE COUNTY MON 2208 (WCCS 660) AND PIERCE COUNTY MON 2128 (WCCS 580), TAKEN AS NORTH 25°54'26" WEST, BASED UPON NORTH AMERICAN DATUM OF 1983 - NAD 83 (91) - WASHINGTON STATE PLANE COORDINATE SYSTEM, SOUTH ZONE.

VERTICAL DATUM - NAVD88:

REFERENCE SURVEYS:
1. PUYALLUP BOUNDARY LINE REVISION NO. P-12-0044, RECORDED UNDER RECORDING NO. 201211145004.
2. RECORD OF SURVEY RECORDING NO. 200704305001, AND AS CORRECTED BY AFFIDAVIT OF MINOR CORRECTION UNDER RECORDING NO. 200710260050.

ESTIMATED EARTHWORK QUANTITIES

CUT: 170 CY
FILL: 120 CY
NET: 50 CY (EXPORT)

OVERALL PROJECT NOTE

THIS PROJECT BEING PART OF AN ONGOING COMMON PLAN OF DEVELOPMENT WHICH IS GREATER THAN 1 ACRE SHALL OBTAIN A CONSTRUCTION STORMWATER GENERAL PERMIT ISSUED BY THE DEPARTMENT OF ECOLOGY.

INDEX OF SHEETS

C1	OF 9	COVER SHEET
C2	OF 9	GENERAL NOTES
C3	OF 9	EXISTING CONDITIONS
C4	OF 9	TEC & DEMOLITION PLAN
C5	OF 9	TEC NOTES & DETAILS
C6	OF 9	SITE PLAN
C7	OF 9	GRADING, DRAINAGE, & UTILITY PLAN
C8	OF 9	UTILITY DETAILS
C9	OF 9	UTILITY DETAILS

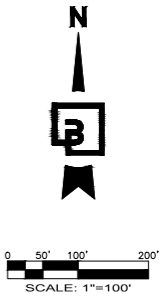

EXISTING:	PROPOSED:

**CALL BEFORE YOU DIG:
1-800-424-5555 OR "811"**

UTILITY CONFLICT NOTE
THE CONTRACTOR SHALL BE RESPONSIBLE FOR VERIFYING THE LOCATIONS, DIMENSION, AND DEPTH OF ALL EXISTING UTILITIES WHETHER SHOWN ON THESE PLANS NOR NOT BY POT-HOLING THE UTILITIES AND SURVEYING THE HORIZONTAL AND VERTICAL LOCATION PRIOR TO CONSTRUCTION. THIS SHALL INCLUDE CALLING UTILITY LOCATE @ 1-800-424-5555 AND THEN POT-HOLING ALL OF THE EXISTING UTILITIES AT LOCATION OF NEW UTILITY CROSSINGS TO PHYSICALLY VERIFY WHETHER OR NOT CONFLICTS EXIST. LOCATIONS OF SAID UTILITIES AS SHOWN ON THESE PLANS ARE BASED UPON THE UNVERIFIED PUBLIC INFORMATION AND ARE SUBJECT TO VARIATION. IF CONFLICTS SHOULD OCCUR, THE CONTRACTOR SHALL CONSULT BARGHAUSEN CONSULTING ENGINEERS, LLC TO RESOLVE ALL PROBLEMS PRIOR TO PROCEEDING WITH CONSTRUCTION.

MONUMENT PROTECTION NOTE
CONTRACTOR SHALL BE FULLY RESPONSIBLE FOR OBTAINING PERMITS FROM THE WASHINGTON STATE DEPARTMENT OF NATURAL RESOURCES FOR REMOVING AND REPLACING ALL SURVEY MONUMENTATION THAT MAY BE AFFECTED BY CONSTRUCTION ACTIVITY, PURSUANT TO WAC 332-120. APPLICATIONS MUST BE COMPLETED BY A REGISTERED LAND SURVEYOR. APPLICATIONS FOR PERMITS TO REMOVE MONUMENTS MAY BE OBTAINED FROM THE WASHINGTON STATE DEPARTMENT OF NATURAL RESOURCES, OR BY CONTACTING THEIR OFFICE BY TELEPHONE AT (206) 902-1190.

WASHINGTON STATE DEPARTMENT OF NATURAL RESOURCES
PUBLIC LAND SURVEY OFFICE
1111 WASHINGTON STREET S.E.
P.O. BOX 47060
OLYMPIA, WASHINGTON 98504-7060

HORIZONTAL CONTROL NOTE
THE CONTRACTOR SHALL HAVE ALL PROPERTY LINES, CURB, SIDEWALK, STRUCTURES, CONCRETE PADS AND ANY OTHER ABOVE GROUND PERMANENT STRUCTURE DEPICTED ON THESE PLANS STAKED FOR CONSTRUCTION BY A LICENSED SURVEYOR. THE LICENSED SURVEYOR SHALL STAKE ALL ITEMS USING COORDINATE GEOMETRY (RECTIFIED TO SITE CONTROL) CONTAINED IN CAD DRAWINGS PROVIDED BY BARGHAUSEN CONSULTING ENGINEERS, INC. IT IS THE CONTRACTOR'S RESPONSIBILITY TO RETRIEVE THE LATEST CAD FILES FROM BARGHAUSEN CONSULTING ENGINEERS, INC., REFLECTING ANY ISSUED PLAN REVISIONS. BARGHAUSEN CONSULTING ENGINEERS, LLC SHALL IMMEDIATELY BE NOTIFIED OF ANY DISCREPANCIES PRIOR TO THE START OF CONSTRUCTION.

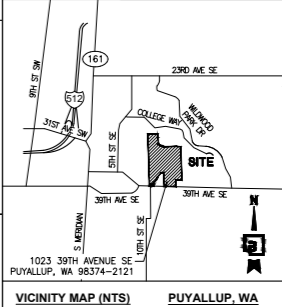

APPROVED

BY: CITY OF PUYALLUP
DEVELOPMENT ENGINEERING

DATE: _____

NOTE: THIS APPROVAL IS VOID AFTER 180 DAYS FROM APPROVAL DATE.
THE CITY WILL NOT BE RESPONSIBLE FOR ERRORS AND/OR OMISSIONS ON THESE PLANS.
FIELD CONDITIONS MAY DICTATE CHANGES TO THESE PLANS AS DETERMINED BY THE DEVELOPMENT ENGINEERING MANAGER.

Job Number: 23796

Sheet: 9

C1 of 9

Approved: 7/9/25

Scale: Horizontal 1"=100', Vertical N/A

Designed: [Signature]

Drawn: [Signature]

Checked: [Signature]

Approved: [Signature]

Date: 3/24/22

Revised: [Signature]

By: [Signature]

Date: [Signature]

No. [Signature]

FOR: MACKENZIE INC.
500 UNION STREET, SUITE 410
SEATTLE, WASHINGTON 98101

TITLE: COVER SHEET
FOR PUYALLUP PUBLIC
SAFETY BUILDING BENAROYA
TENANT IMPROVEMENT PERMIT/BID SET

FOI: [Signature]

Professional Engineer Seal: CARA VISINTAINER, PE, No. 4284

Project: 1023 39th Avenue SE
PUYALLUP, WA 98374-2121

Company: BARGHAUSEN CONSULTING ENGINEERS, LLC.
18215 72nd Avenue South
Kent, WA 98032
425-251-6222
barghausen.com

GENERAL NOTES FOR PUYALLUP PUBLIC SAFETY BUILDING

A PORTION OF THE NE 1/4, SE 1/4, NW 1/4 & SW 1/4, OF THE SE 1/4 OF SEC. 3, TWN. 19 N, RGE. 4 E, W.M. CITY OF PUYALLUP, PIERCE COUNTY, WASHINGTON

GENERAL SITE DEVELOPMENT NOTES

- 1. THE GENERAL CONTRACTOR SHALL OBTAIN AND HAVE AVAILABLE COPIES OF THE APPLICABLE GOVERNING AGENCY STANDARDS AT THE JOB SITE DURING THE RELATED CONSTRUCTION OPERATIONS.
2. THE GENERAL CONTRACTOR SHALL ASSURE THAT ALL NECESSARY PERMITS HAVE BEEN OBTAINED PRIOR TO COMMENCING WORK.
3. THE GENERAL CONTRACTOR SHALL BE RESPONSIBLE FOR VERIFYING THE LOCATION, DIMENSION, AND DEPTH OF ALL EXISTING UTILITIES PRIOR TO CONSTRUCTION...

CONSTRUCTION SEQUENCE

- 1. FLAGGING OF CLEARING LIMITS.
2. SCHEDULE AND ATTEND PRE-CONSTRUCTION MEETING WITH THE CITY OF PUYALLUP.
3. PROVIDE MISC. DEMOLITION AND CLEAR AND GRUB AREA WITHIN CLEARING LIMITS REQUIRED FOR INSTALLATION OF TEMPORARY EROSION AND SEDIMENTATION CONTROL FACILITIES...

TRENCH NOTE

IF WORKERS ENTER ANY TRENCH OR OTHER EXCAVATION FOUR (4) OR MORE FEET IN DEPTH THAT DOES NOT MEET THE OPEN PIT REQUIREMENTS OF WSDOT SECTION 2-09.3(3)(b), IT SHALL BE SHORED AND CRIBBED. THE CONTRACTOR ALONE SHALL BE RESPONSIBLE FOR WORKER SAFETY AND BARGHAUSEN CONSULTING ENGINEERS, LLC ASSUMES NO RESPONSIBILITY...

FILL SPECIFICATION

IMPORTED FILL MATERIAL SHALL NOT CONTAIN PETROLEUM PRODUCTS, OR SUBSTANCES WHICH ARE HAZARDOUS, DANGEROUS, TOXIC, OR WHICH OTHERWISE VIOLATE ANY STATE, FEDERAL, OR LOCAL LAW, ORDINANCE, CODE, REGULATION, RULE, ORDER, OR STANDARD.

CRITICAL AREA DELINEATION NOTES

PERMANENT CRITICAL AREA MARKERS ARE REQUIRED TO BE INSTALLED EVERY 50 FEET AROUND THE BOUNDARY OF CRITICAL AREA BUFFERS FOR THE FOLLOWING CRITICAL AREAS; WETLANDS, STREAMS, LANDSLIDE HAZARD AREAS.

CITY OF PUYALLUP STANDARD NOTES

- 1. ALL WORK IN CITY RIGHT-OF-WAY REQUIRES A PERMIT FROM THE CITY OF PUYALLUP. PRIOR TO ANY WORK COMMENCING, THE GENERAL CONTRACTOR SHALL ARRANGE FOR A PRECONSTRUCTION MEETING AT THE DEVELOPMENT SERVICES CENTER TO BE ATTENDED BY ALL CONTRACTORS THAT WILL PERFORM WORK SHOWN ON THE APPROVED ENGINEERING PLANS...
2. AFTER COMPLETION OF ALL ITEMS SHOWN ON THESE PLANS AND BEFORE ACCEPTANCE OF THE PROJECT, THE CONTRACTOR SHALL OBTAIN A 'PUNCH LIST' PREPARED BY THE CITY'S INSPECTOR DETAILING REMAINING ITEMS OF WORK TO BE COMPLETED...

CITY OF PUYALLUP SEWER NOTES

- 1. ALL WORK IN CITY RIGHT-OF-WAY REQUIRES A PERMIT FROM THE CITY OF PUYALLUP. PRIOR TO ANY WORK COMMENCING, THE GENERAL CONTRACTOR SHALL ARRANGE FOR A PRECONSTRUCTION MEETING AT THE DEVELOPMENT SERVICES CENTER TO BE ATTENDED BY ALL CONTRACTORS THAT WILL PERFORM WORK SHOWN ON THE APPROVED ENGINEERING PLANS...
2. AFTER COMPLETION OF ALL ITEMS SHOWN ON THESE PLANS AND BEFORE ACCEPTANCE OF THE PROJECT, THE CONTRACTOR SHALL OBTAIN A 'PUNCH LIST' PREPARED BY THE CITY'S INSPECTOR DETAILING REMAINING ITEMS OF WORK TO BE COMPLETED...

CITY OF PUYALLUP WATER NOTES

- 1. ALL WORK IN CITY RIGHT-OF-WAY REQUIRES A PERMIT FROM THE CITY OF PUYALLUP. PRIOR TO ANY WORK COMMENCING, THE GENERAL CONTRACTOR SHALL ARRANGE FOR A PRECONSTRUCTION MEETING AT THE DEVELOPMENT SERVICES CENTER TO BE ATTENDED BY ALL CONTRACTORS THAT WILL PERFORM WORK SHOWN ON THE APPROVED ENGINEERING PLANS...
2. AFTER COMPLETION OF ALL ITEMS SHOWN ON THESE PLANS AND BEFORE ACCEPTANCE OF THE PROJECT, THE CONTRACTOR SHALL OBTAIN A 'PUNCH LIST' PREPARED BY THE CITY'S INSPECTOR DETAILING REMAINING ITEMS OF WORK TO BE COMPLETED...

- 26.4. PRESSURE TESTING INCLUDES TESTING AGAINST NEW VALVES AND HYDRANTS. EACH VALVE SHALL BE TESTED BY CLOSING EACH IN TURN AND REDUCING THE PRESSURE BEYOND THE VALVE. THE PRESSURE ON THE BACK SIDE OF THE VALVE SHOULD NOT BE ELIMINATED. CARE MUST BE TAKEN THAT DURING THIS PROCESS, POSITIVE PRESSURE REMAINS THROUGHOUT THE SYSTEM BEING TESTED AT ALL TIMES...
26.5. AFTER SUCCESSFUL PRESSURE TESTING, THE WATER MAIN SHALL BE THOROUGHLY FLUSHED TO REMOVE ALL SUPER CHLORINATED WATER FROM THE NEW WATER MAIN. FLUSHING OF NEW OR EXTENDED WATER MAINS SHALL BE CONDUCTED PER WSDOT SPECIFICATION 7-09.3(2)(4) WITH A MINIMUM VELOCITY DEVELOPED WITHIN THE PIPE WHILE FLUSHING OF 2.5 FEET PER SECOND (FPS)...

CITY OF PUYALLUP STORMWATER NOTES

- 1. ALL WORK IN CITY RIGHT-OF-WAY REQUIRES A PERMIT FROM THE CITY OF PUYALLUP. PRIOR TO ANY WORK COMMENCING, THE GENERAL CONTRACTOR SHALL ARRANGE FOR A PRECONSTRUCTION MEETING AT THE DEVELOPMENT SERVICES CENTER TO BE ATTENDED BY ALL CONTRACTORS THAT WILL PERFORM WORK SHOWN ON THE APPROVED ENGINEERING PLANS...
2. AFTER COMPLETION OF ALL ITEMS SHOWN ON THESE PLANS AND BEFORE ACCEPTANCE OF THE PROJECT, THE CONTRACTOR SHALL OBTAIN A 'PUNCH LIST' PREPARED BY THE CITY'S INSPECTOR DETAILING REMAINING ITEMS OF WORK TO BE COMPLETED...

UTILITY CONFLICT NOTE:

THE CONTRACTOR SHALL BE RESPONSIBLE FOR VERIFYING THE LOCATION, DIMENSION, AND DEPTH OF ALL EXISTING UTILITIES WHETHER SHOWN ON THESE PLANS OR NOT BY POT-HOLING THE UTILITIES AND SURVEYING THE HORIZONTAL AND VERTICAL LOCATION PRIOR TO CONSTRUCTION. THIS SHALL INCLUDE CALLING UTILITY LOCATE @ 1-800-424-5555 AND THEN POT-HOLING ALL OF THE EXISTING UTILITIES AT LOCATIONS OF NEW UTILITY CROSSINGS TO PHYSICALLY VERIFY WHETHER OR NOT CONFLICTS EXIST...

CALL BEFORE YOU DIG: 1-800-424-5555 OR '811'

APPROVED

BY: CITY OF PUYALLUP DEVELOPMENT ENGINEERING DATE:

Project information and stamps including: Title: GENERAL NOTES FOR PUYALLUP PUBLIC SAFETY BUILDING BENAROYA TENANT IMPROVEMENT PERMIT/BID SET; Mackenzie Inc. address; City of Puyallup seal; Professional Engineer seal for Cory V. Siantino; Design/Draw/Check/Approved/Date table; Job Number 23796; Sheet 9 of 9; and various revision and approval stamps.

EXISTING CONDITIONS
FOR
PUYALLUP PUBLIC SAFETY BUILDING
A PORTION OF THE NE 1/4, SE 1/4, NW 1/4 & SW 1/4, OF THE SE 1/4 OF SEC. 3, TWN. 19 N, RGE. 4 E, W.M. CITY OF PUYALLUP, PIERCE COUNTY, WASHINGTON

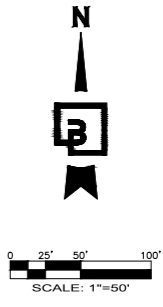
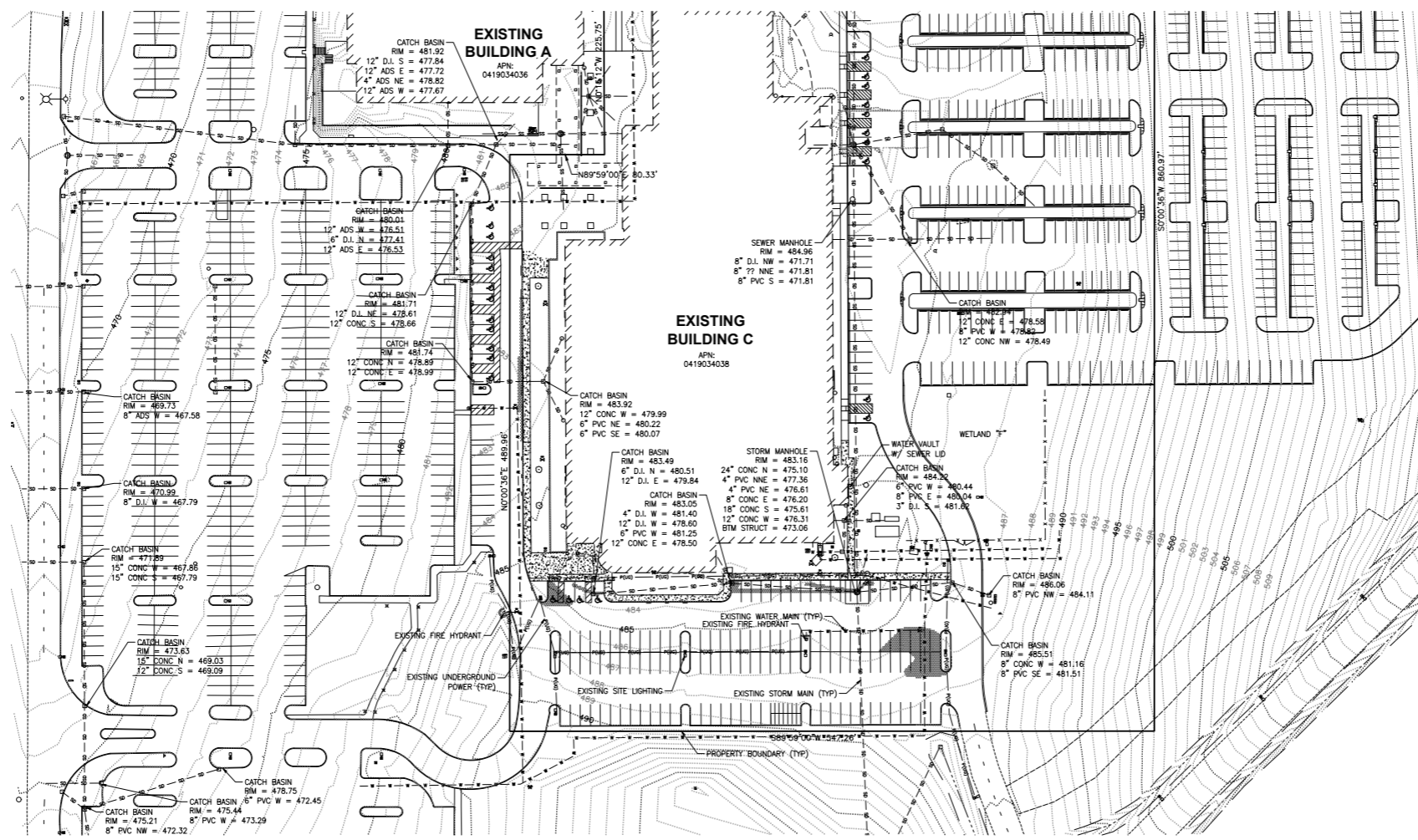

No.	Date	By	Chk.	Appr.	CIVIL REV	Revision
A	07/09/25	KDM	CMV	CMV		

Title: **EXISTING CONDITIONS FOR PUYALLUP PUBLIC SAFETY BUILDING BENAROYA TENANT IMPROVEMENT PERMIT/BID SET**

For: **MACKENZIE INC. 500 UNION STREET, SUITE 410 SEATTLE, WASHINGTON 98101**



Scale:	Horizontal 1" = 50'	Vertical N/A
Designed	Drawn	Checked
KDM	KDM	CMV
Approved	CMV	Date
		3/2/22

Borghausen Consulting Engineers, LLC
18215 72nd Avenue South
Kent, WA 98032
425.251.6222 borghausen.com

CALL BEFORE YOU DIG:
1-800-424-5555 OR "811"

APPROVED
BY: _____
CITY OF PUYALLUP
DEVELOPMENT ENGINEERING
DATE: _____

UTILITY CONFLICT NOTE:
THE CONTRACTOR SHALL BE RESPONSIBLE FOR VERIFYING THE LOCATION, DIMENSION, AND DEPTH OF ALL EXISTING UTILITIES WHETHER SHOWN ON THESE PLANS OR NOT BY POTHOLES THE UTILITIES AND SURVEYING THE HORIZONTAL AND VERTICAL LOCATION PRIOR TO CONSTRUCTION. THIS SHALL INCLUDE CALLING UTILITY LOCATE @ 1-800-424-5555 AND THEN POTHOLES ALL OF THE EXISTING UTILITIES AT LOCATIONS OF NEW UTILITY CROSSINGS TO PHYSICALLY VERIFY WHETHER OR NOT CONFLICTS EXIST. LOCATIONS OF SAID UTILITIES AS SHOWN ON THESE PLANS ARE BASED UPON THE UNVERIFIED PUBLIC INFORMATION AND ARE SUBJECT TO VARIATION. IF CONFLICTS SHOULD OCCUR, THE CONTRACTOR SHALL CONSULT BORGHAUSEN CONSULTING ENGINEERS, LLC TO RESOLVE ALL PROBLEMS PRIOR TO PROCEEDING WITH CONSTRUCTION.

NOTE: THIS APPROVAL IS VOID AFTER 180 DAYS FROM APPROVAL DATE.
THE CITY WILL NOT BE RESPONSIBLE FOR ERRORS AND/OR OMISSIONS ON THESE PLANS.
FIELD CONDITIONS MAY DICTATE CHANGES TO THESE PLANS AS DETERMINED BY THE DEVELOPMENT ENGINEERING MANAGER.

Job Number: **23796**
Sheet: _____
C3 of 9

SITE PLAN FOR PUYALLUP PUBLIC SAFETY BUILDING

A PORTION OF THE NE 1/4, SE 1/4, NW 1/4 & SW 1/4, OF THE SE 1/4 OF SEC. 3, TWN. 19 N, RGE. 4 E, W.M. CITY OF PUYALLUP, PIERCE COUNTY, WASHINGTON

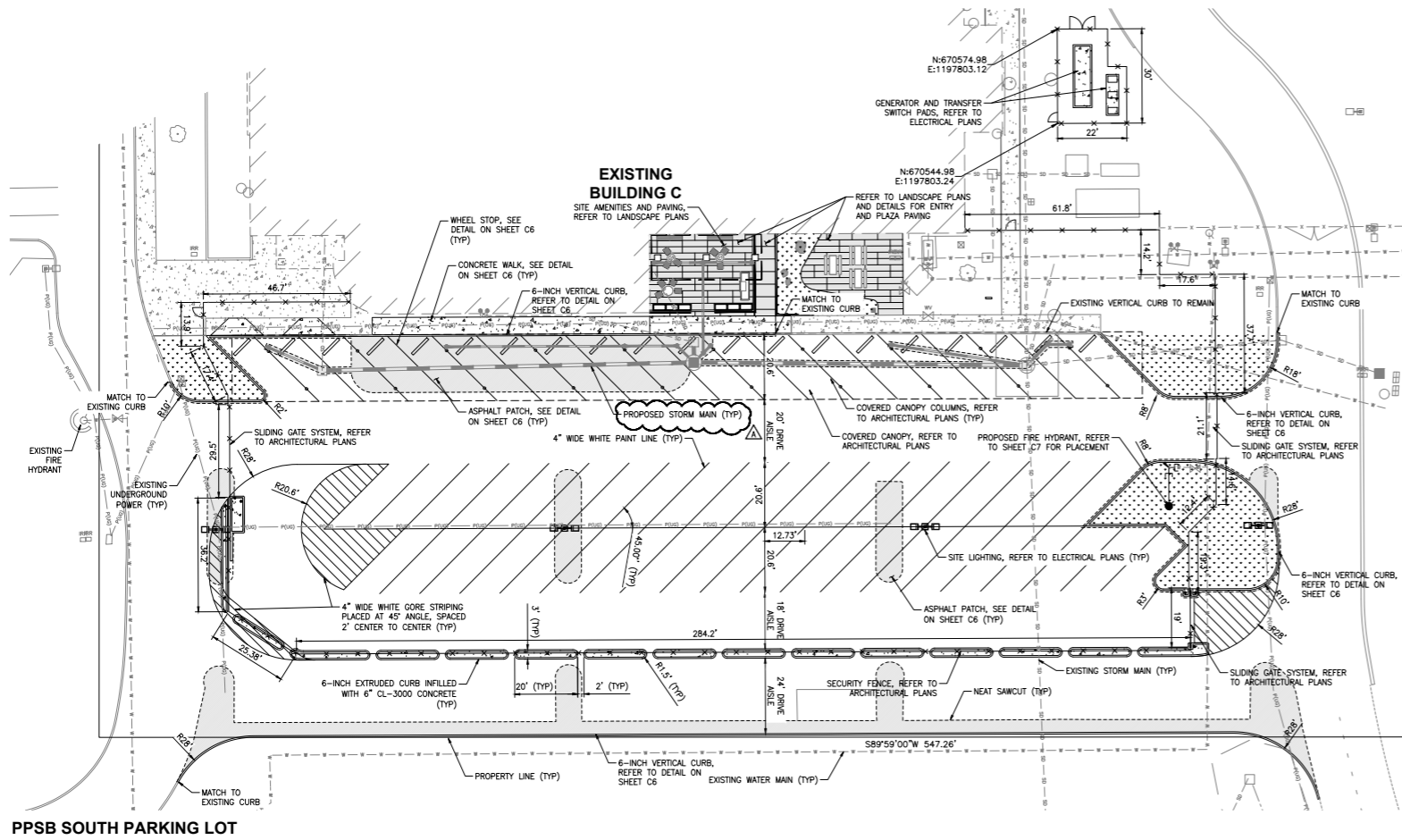

PPSB SOUTH PARKING LOT
SCALE: 1" = 20'

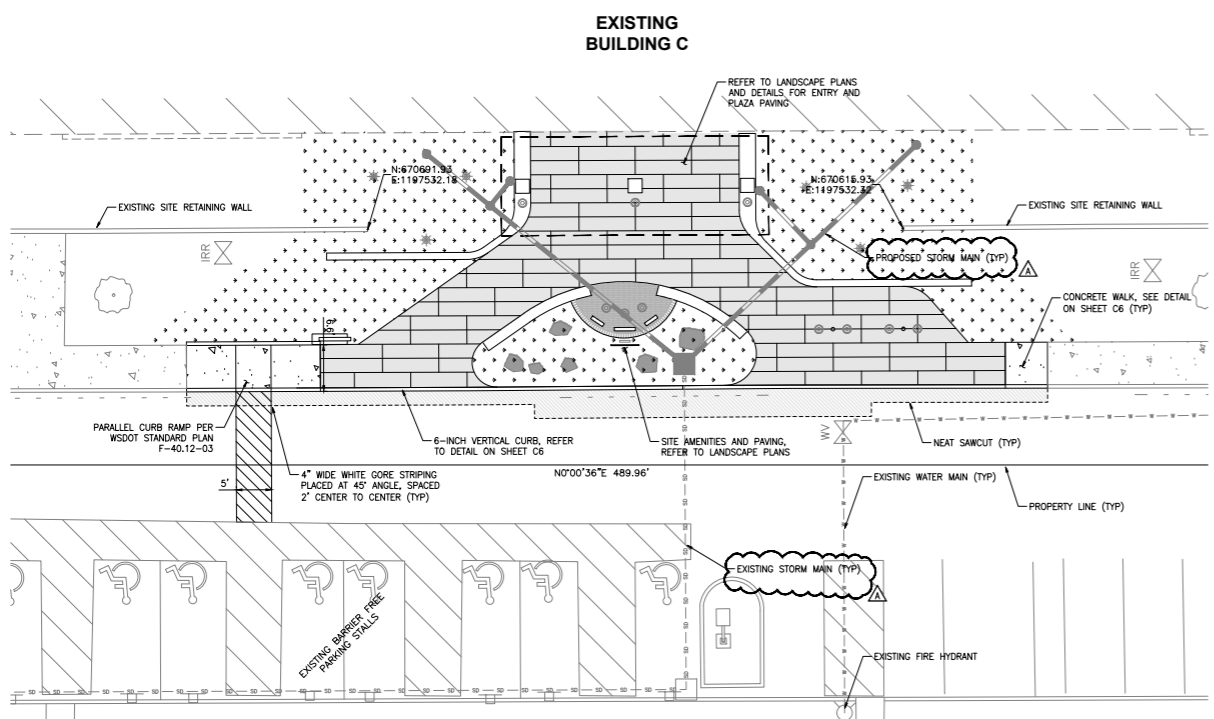

PPSB FRONT ENTRANCE
SCALE: 1" = 10'

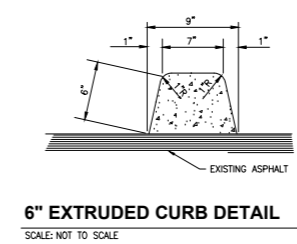
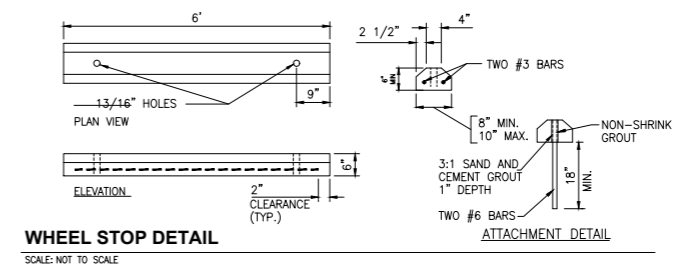
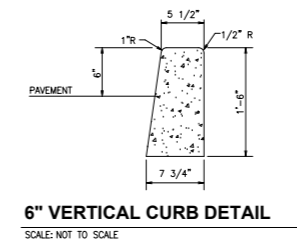
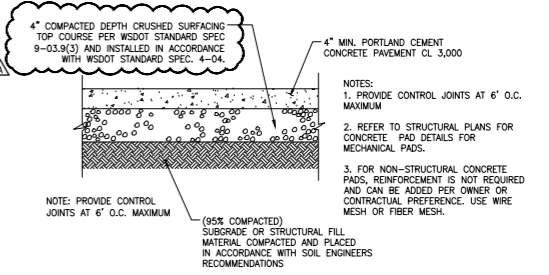
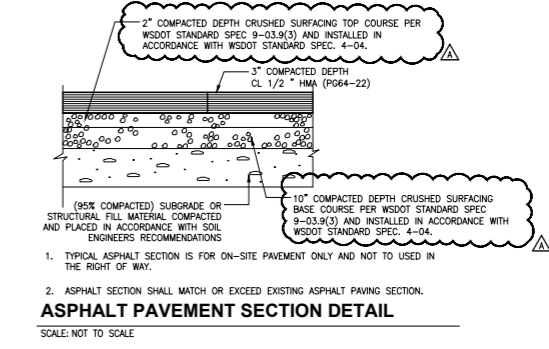
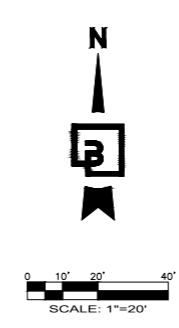

CALL BEFORE YOU DIG:
1-800-424-5555 OR "811"

UTILITY CONFLICT NOTE:
THE CONTRACTOR SHALL BE RESPONSIBLE FOR VERIFYING THE LOCATION, DIMENSION, AND DEPTH OF ALL EXISTING UTILITIES WHETHER SHOWN ON THESE PLANS OR NOT BY POT-HOLING THE UTILITIES AND SURVEYING THE HORIZONTAL AND VERTICAL LOCATION PRIOR TO CONSTRUCTION. THIS SHALL INCLUDE CALLING UTILITY LOCATE @ 1-800-424-5555 AND THEN POT-HOLING ALL OF THE EXISTING UTILITIES AT LOCATIONS OF NEW UTILITY CROSSINGS TO PHYSICALLY VERIFY WHETHER OR NOT CONFLICTS EXIST. LOCATIONS OF SAID UTILITIES AS SHOWN ON THESE PLANS ARE BASED UPON THE UNVERIFIED PUBLIC INFORMATION AND ARE SUBJECT TO VARIATION. IF CONFLICTS SHOULD OCCUR, THE CONTRACTOR SHALL CONSULT BARGHAUSEN CONSULTING ENGINEERS, LLC TO RESOLVE ALL PROBLEMS PRIOR TO PROCEEDING WITH CONSTRUCTION.

APPROVED
BY: _____
CITY OF PUYALLUP
DEVELOPMENT ENGINEERING
DATE: _____

	23796 Sheet	C6 of 9	Job Number 23796 Date 7/9/25 By CMV Checked CMV Approved CMV Date 3/2/22
Title: SITE PLAN FOR PUYALLUP PUBLIC SAFETY BUILDING BENAROYA TENANT IMPROVEMENT PERMIT/BID SET			
For: MACKENZIE INC. 500 UNION STREET, SUITE 410 SEATTLE, WASHINGTON 98101			
			
Scale: Horizontal: 1" = 20' Vertical: N/A			
Designed: _____ Drawn: _____ Checked: _____ Approved: _____ Date: _____			
Barghausen Consulting Engineers, LLC 18215 72nd Avenue South Kent, WA 98032 425-251-6222 barghausen.com			

GRADING, DRAINAGE, & UTILITY PLAN

FOR

PUYALLUP PUBLIC SAFETY BUILDING

A PORTION OF THE NE 1/4, SE 1/4, NW 1/4 & SW 1/4, OF THE SE 1/4 OF SEC. 3, TWN. 19 N, RGE. 4 E, W.M. CITY OF PUYALLUP, PIERCE COUNTY, WASHINGTON

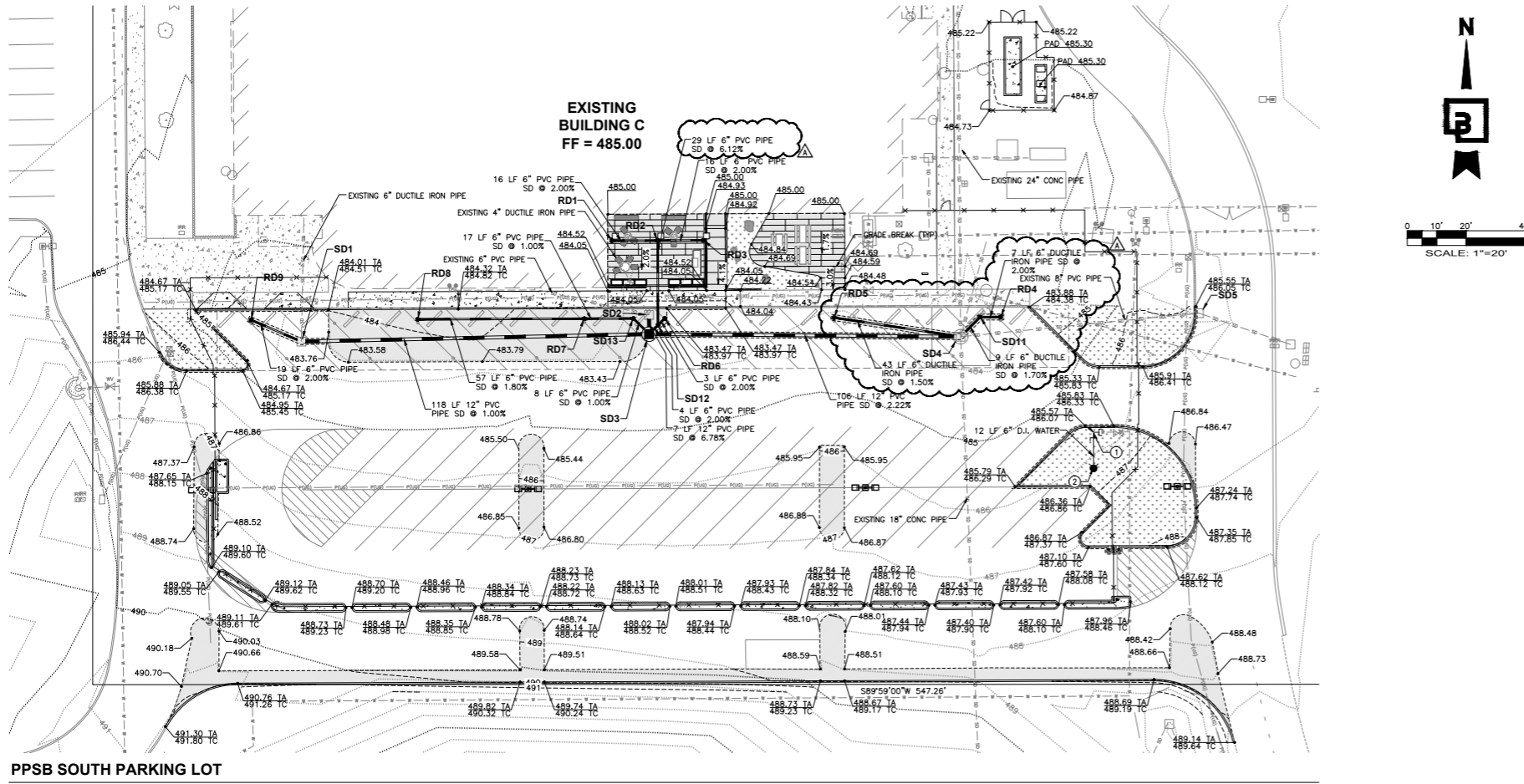

PPSB SOUTH PARKING LOT

SCALE: 1" = 20'

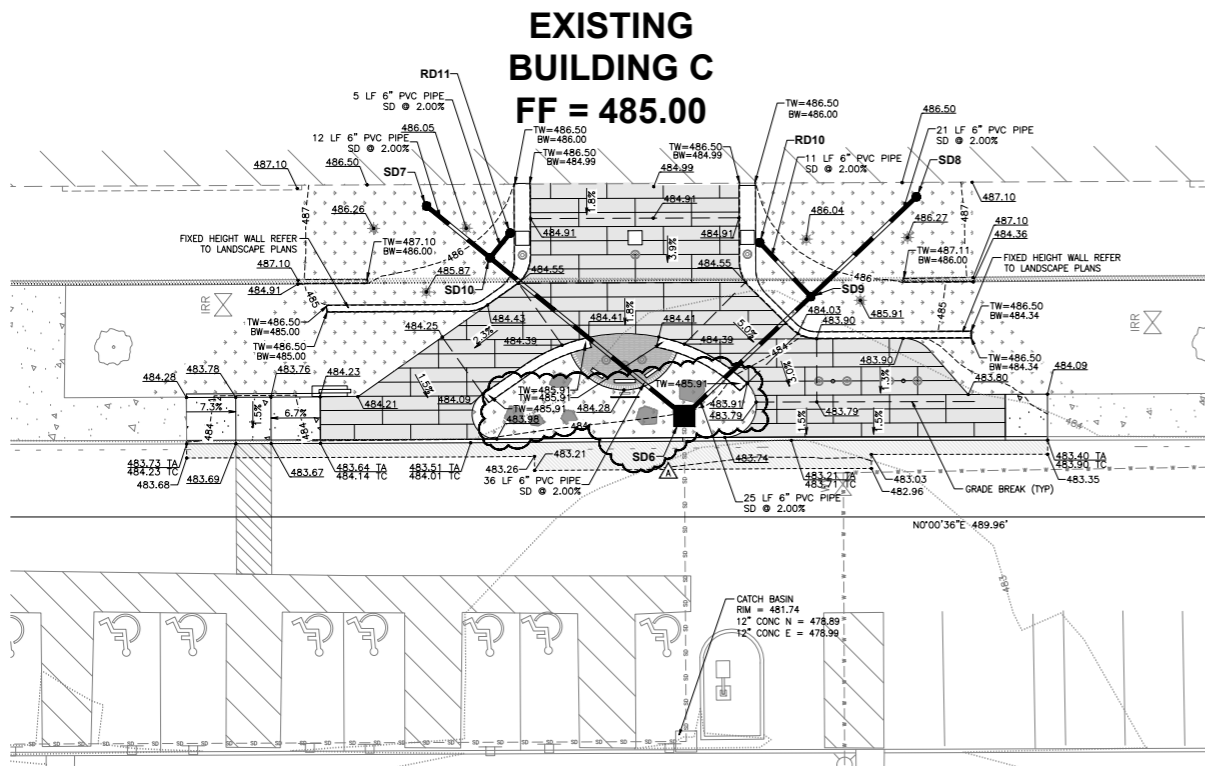

PPSB FRONT ENTRANCE

SCALE: 1" = 10'

GRADING GENERAL NOTES

1. ALL GRADING AND PUBLIC IMPROVEMENTS SHALL BE CONSTRUCTED IN ACCORDANCE WITH THE PROVISIONS OF THE CURRENT CITY ORDINANCE AND STANDARD PLANS. THE GRADING AND IMPROVEMENTS ARE SUBJECT TO THE OBSERVATION OF THE PUBLIC WORKS DEPARTMENT.
2. ALL EXISTING UTILITY STRUCTURE LIDS THAT FALL WITHIN THE AREA OF WORK SHALL BE ADJUSTED TO FINISHED GRADE ELEVATIONS. THE CONTRACTOR SHALL CONFIRM THE FEASIBILITY OF ADJUSTING EXISTING UTILITY STRUCTURE LIDS TO FINISHED GRADE PRIOR TO CONSTRUCTION AND NOTIFY THE ENGINEER OF ANY DISCREPANCIES.
3. ALL SPOT ELEVATIONS SHOWN ARE TO FINISHED SURFACE (TOP OF ASPHALT OR TOP OF CONCRETE PAVEMENT) UNLESS OTHERWISE NOTED.

TA - TOP OF ASPHALT
TC - TOP OF CURB
TW - TOP OF WALL
BW - BOTTOM OF WALL

WATER FITTING KEYNOTES

CONTRACTOR TO FIELD LOCATE AND VERIFY VERTICAL/HORIZONTAL LOCATION OF EXISTING WATER MAIN AND SIZE (ASSUMED 6"). SHOULD BE FOUND, REMOVE EXISTING MJ GLAND AND REPLACE WITH RESTRAINING MEGALUG AT GATE VALVE. CUT EXISTING 8" D.I. PIPE 2- FEET FROM EXISTING GATE VALVE AND INSTALL 8"x6" ADAPTER (MJM) AND RESTRAIN JOINT. CONTINUE WITH 6" RESTRAINED 90° BEND AND THRUST BLOCK.

① CONNECTION TO EXISTING
N: 670435.57
E: 1197838.59
1-6" 90° (MJ X MJ), RESTRAIN JOINT
THRUST BLOCK PER COP STANDARD DETAIL 03.02.01
NOTIFY ENGINEER OF ANY DISCREPANCIES
N: 670423.33
E: 1197838.64

② 1-HYDRANT ASSEMBLY PER COP STANDARD DETAIL 03.05.01

STORM STRUCTURES

RD1 6" SDCO N: 670500.68 E: 1197675.01 RM=484.52 IE=481.32 (6" E)	RD2 6" SDCO N: 670500.74 E: 1197690.56 RM=484.82 IE=481.01 (6" E) IE=481.01 (6" W) IE=481.01 (6" S)	RD3 6" SDCO N: 670500.80 E: 1197676.11 RM=484.52 IE=481.32 (6" W)	RD4 6" SDCO N: 670474.77 E: 1197807.06 RM=483.61 IE=481.12 (6" W)	RD5 6" SDCO N: 670474.55 E: 1197750.49 RM=484.05 IE=481.47 (6" E)	RD6 6" SDCO N: 670474.31 E: 1197692.98 RM=483.20 IE=479.32 (6" SW)	RD7 6" SDCO N: 670474.20 E: 1197665.64 RM=483.57 IE=479.41 (6" W) IE=479.41 (6" E)	RD8 6" SDCO N: 670473.98 E: 1197699.07 RM=484.12 IE=480.43 (6" E)	RD9 6" SDCO N: 670473.75 E: 1197552.50 RM=484.40 IE=480.71 (6" SE)	RD10 6" SDCO N: 670636.27 E: 1197537.67 RM=487.29 IE=480.96 (6" SW)	RD11 6" SDCO N: 670671.71 E: 1197539.03 RM=487.36 IE=481.06 (6" NW)
--	--	--	--	--	---	--	--	---	--	--

STORM STRUCTURES

SD1 EXISTING CB TYPE 1 N: 670466.41 E: 1197569.54 RM=483.49 IE=480.51 (6" N) (EXISTING IE) IE=480.34 (6" NW) (PROPOSED IE) IE=479.84 (12" E) (PROPOSED IE)	SD2 EXISTING CB TYPE 1 N: 670475.48 E: 1197687.61 RM=483.16 IE=481.25 (6" W) (EXISTING IE) IE=481.40 (4" NW) (EXISTING IE) IE=479.10 (12" S) (PROPOSED IE)	SD3 CB TYPE 2 - 48" SOLID COVER N: 670468.96 E: 1197687.67 RM=483.19 IE=478.66 (12" W) IE=478.66 (12" N) IE=479.16 (6" NW) IE=478.66 (12" E)	SD4 EXISTING CB TYPE 2 STD. GRATE N: 670468.07 E: 1197793.46 RM=483.16 IE=476.31 (12" W) (PROPOSED IE) IE=475.61 (18" S) (EXISTING IE) IE=476.20 (8" E) (EXISTING IE) IE=477.36 (4" N) (EXISTING IE) IE=476.61 (4" NE) (EXISTING IE) IE=480.82 (6" NE) (PROPOSED IE) IE=480.82 (6" W) (EXISTING IE) IE=475.10 (24" N) (EXISTING IE)	SD5 EXISTING CB TYPE 1 N: 670476.07 E: 1197874.41 RM=483.51 IE=481.80 (6" E) IE=481.16 (6" W)	SD6 CB TYPE 1 - 24" SOLID COVER N: 670461.00 E: 1197513.05 RM=483.99 IE=480.26 (6" SE) (PROPOSED IE) IE=480.26 (6" NE) (PROPOSED IE) IE=479.76 (12" W) (EXISTING IE)	SD7 -RECONNECT EXISTING 6" SDCO YARD/ROOF DRAINS N: 670683.57 E: 1197642.87 RM=487.49 IE=481.20 (6" SW)	SD8 -RECONNECT EXISTING 6" SDCO YARD/ROOF DRAINS N: 670614.03 E: 1197544.16 RM=487.60 IE=481.16 (6" NW)	SD9 6" SDCO N: 670629.03 E: 1197530.01 RM=484.03 IE=480.75 (6" SE) IE=480.75 (6" NE) IE=480.75 (6" NW)	SD10 6" SDCO N: 670474.57 E: 1197535.53 RM=487.23 IE=480.97 (6" NE) IE=480.97 (6" SE) IE=480.97 (6" SW)	SD11 6" SDCO N: 670474.75 E: 1197800.08 RM=483.38 IE=480.98 (6" E) IE=480.98 (6" SW)
---	---	---	--	---	--	---	---	---	--	--

No.	Date	By	Chk.	Appr.	CIVIL REV	Revision
A	07/09/25	DOM	CMV	CMV		

Title: GRADING, DRAINAGE, & UTILITY PLAN FOR PUYALLUP PUBLIC SAFETY BUILDING BENAROVA TENANT IMPROVEMENT PERMIT/BID SET

For: MACKENZIE INC. 500 UNION STREET, SUITE 410 SEATTLE, WASHINGTON 98101



7/9/25

Scale:	Horizontal	Vertical
	1" = 20'	N/A
Designed	Drawn	Checked
DOM	CMV	CMV
Approved	CMV	CMV
Date	3/17/22	

Barghausen Consulting Engineers, LLC. 18215 72nd Avenue South Kent, WA 98052 425-251-6222 barghausen.com



Job Number: 23796 Sheet: C7 of 9

CALL BEFORE YOU DIG:
1-800-424-5555 OR "811"

UTILITY CONFLICT NOTE:

THE CONTRACTOR SHALL BE RESPONSIBLE FOR VERIFYING THE LOCATION, DIMENSION, AND DEPTH OF ALL EXISTING UTILITIES WHETHER SHOWN OR NOT BY POT-HOLING THE UTILITIES AND SURVEYING THE HORIZONTAL AND VERTICAL LOCATION PRIOR TO CONSTRUCTION. THIS SHALL INCLUDE CALLING UTILITY LOCATE @ 1-800-424-5555 AND THEN POT-HOLING ALL OF THE EXISTING UTILITIES AT LOCATIONS OF NEW UTILITY CROSSINGS TO PHYSICALLY VERIFY WHETHER OR NOT CONFLICTS EXIST. LOCATIONS OF SAID UTILITIES AS SHOWN ON THESE PLANS ARE BASED UPON THE UNVERIFIED PUBLIC INFORMATION AND ARE SUBJECT TO VARIATION. IF CONFLICTS SHOULD OCCUR, THE CONTRACTOR SHALL CONSULT BARGHAUSEN CONSULTING ENGINEERS, LLC. TO RESOLVE ALL PROBLEMS PRIOR TO PROCEEDING WITH CONSTRUCTION.

APPROVED
BY: CITY OF PUYALLUP DEVELOPMENT ENGINEERING
DATE: _____
NOTE: THIS APPROVAL IS VOID AFTER 180 DAYS FROM APPROVAL DATE.
THE CITY WILL NOT BE RESPONSIBLE FOR ERRORS AND/OR OMISSIONS ON THESE PLANS.
FIELD CONDITIONS MAY DICTATE CHANGES TO THESE PLANS AS DETERMINED BY THE DEVELOPMENT ENGINEERING MANAGER.

**UTILITY DETAILS
FOR
PUYALLUP PUBLIC SAFETY BUILDING**
A PORTION OF THE NE 1/4, SE 1/4, NW 1/4 & SW 1/4, OF THE SE 1/4 OF SEC. 3, TWN. 19 N, RGE. 4 E, W.M. CITY OF PUYALLUP, PIERCE COUNTY, WASHINGTON

CATCH BASIN TYPE I (AREA DRAIN)

NOTES:

1. MAXIMUM LENGTH OF PIPE BETWEEN CATCH BASINS SHALL BE 400'.
2. TYPE I CATCH BASIN IS USED FOR DEPTHS LESS THAN 5'-0" FROM TOP OF GRATE TO I.E. (PIPE INVERT).
3. PRECAST BASE SECTION SHALL BE FURNISHED WITH CUTOUTS OR KNOCKOUTS. KNOCKOUTS SHALL HAVE A WALL THICKNESS OF 2" MIN. KNOCKOUTS SHALL BE ON 4 SIDES WITH A MAXIMUM DIAMETER OF 20" TO PROVIDE FOR A MINIMUM SUMP DEPTH OF 18".
4. THE TAPER ON THE SIDES OF THE PRECAST BASE SECTION SHALL NOT EXCEED 1/2" PER FOOT.
5. CATCH BASIN SHALL BE CONSTRUCTED IN ACCORDANCE WITH ASTM C 478 (ASHTO M 199) AND ASTM C 890 UNLESS OTHERWISE NOTED.
6. CATCH BASIN MARKER WILL BE AFFIXED WITH MANUFACTURER'S EPOXY IN DRY WEATHER. 40 DEGREES OR WARMER. IF CURB EXIST MARKER IS PLACED ON TOP OF CURB, IF A RAISED EDGE PLACE MARKER ON THE WEDGE. IF NO CURB PLACE ON PAVEMENT ON SIDE LEAST EXPOSED TO TRAFFIC

CITY OF PUYALLUP
DEVELOPMENT ENGINEERING and PUBLIC WORKS DEPARTMENTS

APPROVED
DATE: 02.01.02

CATCH BASIN TYPE II

NOTES:

1. MAXIMUM LENGTH OF PIPE BETWEEN CATCH BASINS SHALL BE 400'.
2. MAXIMUM OUTER LINE FLOW LENGTH SHALL BE 300'.
3. TYPE II CATCH BASIN IS USED FOR DEPTHS GREATER THAN 5'-0" FROM TOP OF GRATE TO I.E. (PIPE INVERT).
4. PRECAST BASE SECTION SHALL BE FURNISHED WITH CUTOUTS OR KNOCKOUTS. KNOCKOUTS SHALL HAVE A WALL THICKNESS OF 2" MIN. KNOCKOUT OR CUTOUT HOLE SIZE SHALL EQUAL THE PIPE OUTER DIAMETER PLUS THE MANHOLE WALL THICKNESS.
5. SEE CITY STANDARD DETAIL NO. 02.01.01 FOR ADDITIONAL INFORMATION REGARDING INSTALLATION OF MANHOLE SECTION.
6. CATCH BASIN SHALL BE CONSTRUCTED IN ACCORDANCE WITH ASTM C 478 (ASHTO M 199) AND ASTM C 890 UNLESS OTHERWISE NOTED.
7. CATCH BASIN MARKER WILL BE AFFIXED WITH MANUFACTURER'S EPOXY IN DRY WEATHER. 40 DEGREES OR WARMER. IF CURB EXIST MARKER IS PLACED ON TOP OF CURB, IF A RAISED EDGE PLACE MARKER ON THE WEDGE. IF NO CURB PLACE ON PAVEMENT ON SIDE LEAST EXPOSED TO TRAFFIC

CITY OF PUYALLUP
DEVELOPMENT ENGINEERING and PUBLIC WORKS DEPARTMENTS

APPROVED
DATE: 02.01.04

STORM DRAIN CLEANOUT

NOTES:

1. CAST IRON COVER MARKED "TODDY" FOR FOOTING DRAINS OR "TODDY" FOR STORM LINES.
2. CAST IRON FRAME AND COVER SHALL BE DRILLED AND TAPPED WITH #11 NC STAINLESS STEEL TYPE 304 ALLEN HEAD BOLTS, 2" LONG.
3. MULTI-LOCKING CAST IRON FRAME AND COVER SHALL BE 40-50 RATED IF USED IN RIGHT-OF-WAY OR EASEMENTS.
4. 1/4" BOLT-Locking CAST IRON FRAME AND COVER SHALL BE EQUAL TO OLYMPIC FOUNDRY PART # 88888.
5. CAST IRON FRAME AND COVER SHALL BE FLUSH WITH FINISHED GRADE.
6. CLEANOUTS REQUIRED FOR EACH PIPE LENGTH GREATER THAN 75' AND FOR EACH 90 DEGREE BEND.
7. STORM PIPE BEDDING AND BACKFILL SHALL CONFORM TO STD DETAIL 02.01.01.
8. STORM DRAIN STUB SHALL EXTEND 10' BEYOND THE PROPERTY LINE OR EASEMENT LINE TO PREVENT DAMAGE AND MINOR CONFLICT WITH FUTURE UTILITIES.
9. EACH CLEANOUT ASSEMBLY SHALL CONSIST OF: ONE CLEANOUT ADAPTOR, (FIRM & FEMALE INDORE PIPE THREAD, PVC SLIP END), AND ONE CLEANOUT PLUG. (MALE OUTSIDE THREAD WITH RAISED BUT, PVC).
10. FOR LANDSCAPED AREAS (OUTSIDE OF CITY ROW, EASEMENTS AND FACILITIES) A GREEN "TODDY" MODEL 910 YARD BOX MAY BE USED FOR C.I.D. PIPE DIA. LESS THAN OR EQUAL TO 4". YARD BOX SHALL BE FASTENED WITH #10 BOLTS. THE COVER MARKED "TODDY" AND FLUSH WITH FINISHED GRADE.

CITY OF PUYALLUP
PUBLIC WORKS AND DEVELOPMENT ENGINEERING

APPROVED
DATE: 02.01.09

CATCH BASIN FRAME AND GRATE/VANED GRATE

NOTES:

1. MATERIAL SHALL CONFORM TO SECTION 9-05.15 "METAL CASTINGS" OF THE "STANDARD SPECIFICATIONS FOR ROAD, BRIDGE, AND MUNICIPAL CONSTRUCTION" PUBLISHED BY THE STATE DEPARTMENT OF TRANSPORTATION AND AMERICAN PUBLIC WORKS ASSOCIATION, WASHINGTON STATE CHAPTER.
2. THE NAME OF THE MANUFACTURE AND DIRECTION OF FLOW SHALL BE EMBOSSED ON THE TOP SURFACE OF EACH GRATE. LETTERING TO BE RECESSED 1/16".
3. THE MATERIAL USED FOR THE GRATE SHALL BE DESIGNATED BY EMBOSING EITHER DI (FOR DUCTILE IRON) OR CS (FOR CAST STEEL) NEAR THE NAME OF THE MANUFACTURER.
4. DIMENSIONS SHALL HAVE A +/- 1/16" TOLERANCE, EXCEPT AS NOTED.
5. EDGES SHALL HAVE 1/8" RADIUS.
6. WELDING IS NOT PERMITTED.
7. AS AN ALTERNATE, 8 PADS 1 1/2" x 3/4" x 1/8", INTEGRALLY CAST WITH THE GRATE, MAY BE USED.

CITY OF PUYALLUP
DEVELOPMENT ENGINEERING and PUBLIC WORKS DEPARTMENTS

APPROVED
DATE: 02.01.05

MANHOLE FRAME AND COVER

NOTES:

1. EAST JORDAN IRON WORKS 24" "TODDY" and OLYMPIC FOUNDRY MH41 RING & HINGE PUYALLUP COVER ARE PRE-APPROVED PRODUCTS AND SHALL BE USED FOR PUBLICLY-OWNED INFRASTRUCTURE. ALL OTHERS REQUIRE WRITTEN APPROVAL OF THE ENGINEER PRIOR TO INSTALLATION.
2. MANHOLE FRAME AND COVERS SHOULD NOT BE LOCATED IN PEDESTRIAN PATHWAYS (E.G. SIDEWALKS, CROSSWALKS, ETC.) WHERE EXISTING OR PROPOSED CONDITIONS REQUIRE A MANHOLE FRAME AND COVER TO BE INSTALLED WITHIN A PEDESTRIAN PATHWAY, THE MANHOLE FRAME AND COVER SHALL BE ADA COMPLIANT.
3. NON-ROCKING FIT FOR MANHOLE COVERS.
4. CASTING TO BE SHOT BLASTED AND FREE FROM SURFACE SAND AND SCALE.
5. CASTING TO BE SMOOTH, TRUE TO PATTERN, FREE FROM BLOWHOLES, POROSITY HARD SPOTS, SHRINK HOLES, WARP, OR ANY OTHER DEFECTS WHICH COULD IMPAIR SERVICEABILITY.
6. CASTINGS SHALL BE UNCOATED.
7. FOR STORM APPLICATIONS CAST LETTERS SHALL READ "STORM".
8. INSTALL FRAME AND COVER IN ROADWAY WITH HINGED SIDE OF ASSEMBLY POINTED TOWARD ONCOMING TRAFFIC.
9. THE CITY SHALL HAVE THE RIGHT TO REQUIRE INSPECTION AND APPROVAL OF ALL CASTINGS PRIOR TO PAINTING.
10. REPAIR OR DEFECTS BY WELDING, OR BY THE USE OF "SMOOTH-ON" OR SIMILAR MATERIAL, WILL NOT BE PERMITTED.
11. MANHOLE RING AND COVER SHALL BE FREE OF POROSITY, SHRINK CAVITIES, COLD SHUTS OR CRACKS OR ANY SURFACE DEFECTS WHICH WOULD IMPAIR SERVICEABILITY.
12. FRAME HEIGHT MAY BE 4" FOR OVERLAYS AND PAVEMENT REHABILITATION PROJECTS, WITH WRITTEN APPROVAL BY THE CITY ENGINEER.

CITY OF PUYALLUP
OFFICE OF THE CITY ENGINEER

APPROVED
DATE: 06.01.02

CITY OF PUYALLUP
DEVELOPMENT ENGINEERING and PUBLIC WORKS DEPARTMENTS

APPROVED
DATE: 02.01.02

MANHOLE FRAME AND COVER

NOTES:

1. EAST JORDAN IRON WORKS 24" "TODDY" and OLYMPIC FOUNDRY MH41 RING & HINGE PUYALLUP COVER ARE PRE-APPROVED PRODUCTS AND SHALL BE USED FOR PUBLICLY-OWNED INFRASTRUCTURE. ALL OTHERS REQUIRE WRITTEN APPROVAL OF THE ENGINEER PRIOR TO INSTALLATION.
2. MANHOLE FRAME AND COVERS SHOULD NOT BE LOCATED IN PEDESTRIAN PATHWAYS (E.G. SIDEWALKS, CROSSWALKS, ETC.) WHERE EXISTING OR PROPOSED CONDITIONS REQUIRE A MANHOLE FRAME AND COVER TO BE INSTALLED WITHIN A PEDESTRIAN PATHWAY, THE MANHOLE FRAME AND COVER SHALL BE ADA COMPLIANT.
3. NON-ROCKING FIT FOR MANHOLE COVERS.
4. CASTING TO BE SHOT BLASTED AND FREE FROM SURFACE SAND AND SCALE.
5. CASTING TO BE SMOOTH, TRUE TO PATTERN, FREE FROM BLOWHOLES, POROSITY HARD SPOTS, SHRINK HOLES, WARP, OR ANY OTHER DEFECTS WHICH COULD IMPAIR SERVICEABILITY.
6. CASTINGS SHALL BE UNCOATED.
7. FOR STORM APPLICATIONS CAST LETTERS SHALL READ "STORM".
8. INSTALL FRAME AND COVER IN ROADWAY WITH HINGED SIDE OF ASSEMBLY POINTED TOWARD ONCOMING TRAFFIC.
9. THE CITY SHALL HAVE THE RIGHT TO REQUIRE INSPECTION AND APPROVAL OF ALL CASTINGS PRIOR TO PAINTING.
10. REPAIR OR DEFECTS BY WELDING, OR BY THE USE OF "SMOOTH-ON" OR SIMILAR MATERIAL, WILL NOT BE PERMITTED.
11. MANHOLE RING AND COVER SHALL BE FREE OF POROSITY, SHRINK CAVITIES, COLD SHUTS OR CRACKS OR ANY SURFACE DEFECTS WHICH WOULD IMPAIR SERVICEABILITY.
12. FRAME HEIGHT MAY BE 4" FOR OVERLAYS AND PAVEMENT REHABILITATION PROJECTS, WITH WRITTEN APPROVAL BY THE CITY ENGINEER.

CITY OF PUYALLUP
OFFICE OF THE CITY ENGINEER

APPROVED
DATE: 02.01.04

CITY OF PUYALLUP
DEVELOPMENT ENGINEERING and PUBLIC WORKS DEPARTMENTS

APPROVED
DATE: 02.01.04

STORM DRAIN CLEANOUT

NOTES:

1. CAST IRON COVER MARKED "TODDY" FOR FOOTING DRAINS OR "TODDY" FOR STORM LINES.
2. CAST IRON FRAME AND COVER SHALL BE DRILLED AND TAPPED WITH #11 NC STAINLESS STEEL TYPE 304 ALLEN HEAD BOLTS, 2" LONG.
3. MULTI-LOCKING CAST IRON FRAME AND COVER SHALL BE 40-50 RATED IF USED IN RIGHT-OF-WAY OR EASEMENTS.
4. 1/4" BOLT-Locking CAST IRON FRAME AND COVER SHALL BE EQUAL TO OLYMPIC FOUNDRY PART # 88888.
5. CAST IRON FRAME AND COVER SHALL BE FLUSH WITH FINISHED GRADE.
6. CLEANOUTS REQUIRED FOR EACH PIPE LENGTH GREATER THAN 75' AND FOR EACH 90 DEGREE BEND.
7. STORM PIPE BEDDING AND BACKFILL SHALL CONFORM TO STD DETAIL 02.01.01.
8. STORM DRAIN STUB SHALL EXTEND 10' BEYOND THE PROPERTY LINE OR EASEMENT LINE TO PREVENT DAMAGE AND MINOR CONFLICT WITH FUTURE UTILITIES.
9. EACH CLEANOUT ASSEMBLY SHALL CONSIST OF: ONE CLEANOUT ADAPTOR, (FIRM & FEMALE INDORE PIPE THREAD, PVC SLIP END), AND ONE CLEANOUT PLUG. (MALE OUTSIDE THREAD WITH RAISED BUT, PVC).
10. FOR LANDSCAPED AREAS (OUTSIDE OF CITY ROW, EASEMENTS AND FACILITIES) A GREEN "TODDY" MODEL 910 YARD BOX MAY BE USED FOR C.I.D. PIPE DIA. LESS THAN OR EQUAL TO 4". YARD BOX SHALL BE FASTENED WITH #10 BOLTS. THE COVER MARKED "TODDY" AND FLUSH WITH FINISHED GRADE.

CITY OF PUYALLUP
PUBLIC WORKS AND DEVELOPMENT ENGINEERING

APPROVED
DATE: 02.01.09

CITY OF PUYALLUP
DEVELOPMENT ENGINEERING and PUBLIC WORKS DEPARTMENTS

APPROVED
DATE: 02.01.09

CATCH BASIN FRAME AND GRATE/VANED GRATE

NOTES:

1. MATERIAL SHALL CONFORM TO SECTION 9-05.15 "METAL CASTINGS" OF THE "STANDARD SPECIFICATIONS FOR ROAD, BRIDGE, AND MUNICIPAL CONSTRUCTION" PUBLISHED BY THE STATE DEPARTMENT OF TRANSPORTATION AND AMERICAN PUBLIC WORKS ASSOCIATION, WASHINGTON STATE CHAPTER.
2. THE NAME OF THE MANUFACTURE AND DIRECTION OF FLOW SHALL BE EMBOSSED ON THE TOP SURFACE OF EACH GRATE. LETTERING TO BE RECESSED 1/16".
3. THE MATERIAL USED FOR THE GRATE SHALL BE DESIGNATED BY EMBOSING EITHER DI (FOR DUCTILE IRON) OR CS (FOR CAST STEEL) NEAR THE NAME OF THE MANUFACTURER.
4. DIMENSIONS SHALL HAVE A +/- 1/16" TOLERANCE, EXCEPT AS NOTED.
5. EDGES SHALL HAVE 1/8" RADIUS.
6. WELDING IS NOT PERMITTED.
7. AS AN ALTERNATE, 8 PADS 1 1/2" x 3/4" x 1/8", INTEGRALLY CAST WITH THE GRATE, MAY BE USED.

CITY OF PUYALLUP
DEVELOPMENT ENGINEERING and PUBLIC WORKS DEPARTMENTS

APPROVED
DATE: 02.01.05

CITY OF PUYALLUP
DEVELOPMENT ENGINEERING and PUBLIC WORKS DEPARTMENTS

APPROVED
DATE: 02.01.05

UTILITY DETAILS FOR PUYALLUP PUBLIC SAFETY BUILDING BENAROYA TENANT IMPROVEMENT PERMIT/BID SET

Title: Mackenzie Inc., 500 Union Street, Suite 410 Seattle, Washington 98101

For: [Signature]

Scale: Horizontal N/A, Vertical N/A

Designed: [Signature], Drawn: [Signature], Checked: [Signature], Approved: [Signature], Date: 3/24/22

Barghausen Consulting Engineers, LLC
18215 72nd Avenue South
Kent, WA 98032
425-251-6222
barghausen.com

CALL BEFORE YOU DIG:
1-800-424-5555 OR "811"

APPROVED BY: [Signature], DATE: [Date]

NOTE: THIS APPROVAL IS VOID AFTER 180 DAYS FROM APPROVAL DATE. THE CITY WILL NOT BE RESPONSIBLE FOR ERRORS AND/OR OMISSIONS ON THESE PLANS. FIELD CONDITIONS MAY DICTATE CHANGES TO THESE PLANS AS DETERMINED BY THE DEVELOPMENT ENGINEERING MANAGER.

UTILITY CONFLICT NOTE:
THE CONTRACTOR SHALL BE RESPONSIBLE FOR VERIFYING THE LOCATION, DIMENSION, AND DEPTH OF ALL EXISTING UTILITIES WHETHER SHOWN ON THESE PLANS OR NOT BY POT-HOLING THE UTILITIES AND SURVEYING THE HORIZONTAL AND VERTICAL LOCATION PRIOR TO CONSTRUCTION. THIS SHALL INCLUDE CALLING UTILITY LOCATE @ 1-800-424-5555 AND THEN POT-HOLING ALL OF THE EXISTING UTILITIES AT LOCATIONS OF NEW UTILITY CROSSINGS TO PHYSICALLY VERIFY WHETHER OR NOT CONFLICTS EXIST. LOCATIONS OF SAID UTILITIES AS SHOWN ON THESE PLANS ARE BASED UPON THE UNVERIFIED PUBLIC INFORMATION AND ARE SUBJECT TO VARIATION. IF CONFLICTS SHOULD OCCUR, THE CONTRACTOR SHALL CONSULT BARGHAUSEN CONSULTING ENGINEERS, LLC TO RESOLVE ALL PROBLEMS PRIOR TO PROCEEDING WITH CONSTRUCTION.

Appendix B – Construction BMPs

Preserving Natural Vegetation (BMP C101)
Buffer Zones (BMP C102)
High Visibility Fence (BMP C103)
Stabilized Construction Entrance (BMP C105)
Wheel Wash (BMP C106)
Construction Road/Parking Area Stabilization (BMP C107)
Temporary and Permanent Seeding (BMP C120)
Mulching (BMP C121)
Nets and Blankets (BMP C122)
Plastic Covering (BMP C123)
Dust Control (BMP C140)
Materials on Hand (BMP C150)
Concrete Handling (BMP C151)
Sawcutting and Surfacing Pollution Prevention (BMP C152)
Interceptor Swales (BMP C200)
Channel Lining (BMP C202)
Water Bars (BMP C203)
Pipe Slope Drains (BMP C204)
Grass-Lined Channels (BMP C201)
Check Dams (BMP C207)
Outlet Protection (BMP C209)
Strom Drain Inlet Protection (BMP C220)
Gravel Filter Berm (BMP C232)
Silt Fence (BMP C233)
Sediment trap (BMP C240)
Sediment pond (BMP C241)
Construction Stormwater Chemical Treatment (BMP C250)
Construction Stormwater Filtration (BMP C251)
High pH Neutralization Using CO₂ (BMP C252)

BMP C101: Preserving Natural Vegetation

<i>Purpose</i>	<p>The purpose of preserving natural vegetation is to reduce erosion wherever practicable. Limiting site disturbance is the single most effective method for reducing erosion. For example, conifers can hold up to about 50 percent of all rain that falls during a storm. Up to 20-30 percent of this rain may never reach the ground but is taken up by the tree or evaporates. Another benefit is that the rain held in the tree can be released slowly to the ground after the storm.</p>
<i>Conditions of Use</i>	<p>Natural vegetation should be preserved on steep slopes, near perennial and intermittent watercourses or swales, and on building sites in wooded areas.</p> <ul style="list-style-type: none">• As required by local governments.• Phase construction to preserve natural vegetation on the project site for as long as possible during the construction period.
<i>Design and Installation Specifications</i>	<p>Natural vegetation can be preserved in natural clumps or as individual trees, shrubs and vines.</p> <p>The preservation of individual plants is more difficult because heavy equipment is generally used to remove unwanted vegetation. The points to remember when attempting to save individual plants are:</p> <ul style="list-style-type: none">• Is the plant worth saving? Consider the location, species, size, age, vigor, and the work involved. Local governments may also have ordinances to save natural vegetation and trees.• Fence or clearly mark areas around trees that are to be saved. It is preferable to keep ground disturbance away from the trees at least as far out as the dripline. <p>Plants need protection from three kinds of injuries:</p> <ul style="list-style-type: none">• <i>Construction Equipment</i> - This injury can be above or below the ground level. Damage results from scarring, cutting of roots, and compaction of the soil. Placing a fenced buffer zone around plants to be saved prior to construction can prevent construction equipment injuries.• <i>Grade Changes</i> - Changing the natural ground level will alter grades, which affects the plant's ability to obtain the necessary air, water, and minerals. Minor fills usually do not cause problems although sensitivity between species does vary and should be checked. Trees can typically tolerate fill of 6 inches or less. For shrubs and other plants, the fill should be less. <p>When there are major changes in grade, it may become necessary to supply air to the roots of plants. This can be done by placing a layer of gravel and a tile system over the roots before the fill is made. A tile system protects a tree from a raised grade. The tile system should be</p>

laid out on the original grade leading from a dry well around the tree trunk. The system should then be covered with small stones to allow air to circulate over the root area.

Lowering the natural ground level can seriously damage trees and shrubs. The highest percentage of the plant roots are in the upper 12 inches of the soil and cuts of only 2-3 inches can cause serious injury. To protect the roots it may be necessary to terrace the immediate area around the plants to be saved. If roots are exposed, construction of retaining walls may be needed to keep the soil in place. Plants can also be preserved by leaving them on an undisturbed, gently sloping mound. To increase the chances for survival, it is best to limit grade changes and other soil disturbances to areas outside the dripline of the plant.

- *Excavations* - Protect trees and other plants when excavating for drainfields, power, water, and sewer lines. Where possible, the trenches should be routed around trees and large shrubs. When this is not possible, it is best to tunnel under them. This can be done with hand tools or with power augers. If it is not possible to route the trench around plants to be saved, then the following should be observed:

Cut as few roots as possible. When you have to cut, cut clean. Paint cut root ends with a wood dressing like asphalt base paint if roots will be exposed for more than 24-hours.

Backfill the trench as soon as possible.

Tunnel beneath root systems as close to the center of the main trunk to preserve most of the important feeder roots.

Some problems that can be encountered with a few specific trees are:

- Maple, Dogwood, Red alder, Western hemlock, Western red cedar, and Douglas fir do not readily adjust to changes in environment and special care should be taken to protect these trees.
- The windthrow hazard of Pacific silver fir and madrona is high, while that of Western hemlock is moderate. The danger of windthrow increases where dense stands have been thinned. Other species (unless they are on shallow, wet soils less than 20 inches deep) have a low windthrow hazard.
- Cottonwoods, maples, and willows have water-seeking roots. These can cause trouble in sewer lines and infiltration fields. On the other hand, they thrive in high moisture conditions that other trees would not.
- Thinning operations in pure or mixed stands of Grand fir, Pacific silver fir, Noble fir, Sitka spruce, Western red cedar, Western hemlock, Pacific dogwood, and Red alder can cause serious disease problems. Disease can become established through damaged limbs, trunks, roots,

and freshly cut stumps. Diseased and weakened trees are also susceptible to insect attack.

Maintenance Standards

Inspect flagged and/or fenced areas regularly to make sure flagging or fencing has not been removed or damaged. If the flagging or fencing has been damaged or visibility reduced, it shall be repaired or replaced immediately and visibility restored.

- If tree roots have been exposed or injured, “prune” cleanly with an appropriate pruning saw or loppers directly above the damaged roots and recover with native soils. Treatment of sap flowing trees (fir, hemlock, pine, soft maples) is not advised as sap forms a natural healing barrier.

BMP C102: Buffer Zones

Purpose

Creation of an undisturbed area or strip of natural vegetation or an established suitable planting that will provide a living filter to reduce soil erosion and runoff velocities.

Conditions of Use

Natural buffer zones are used along streams, wetlands and other bodies of water that need protection from erosion and sedimentation. Vegetative buffer zones can be used to protect natural swales and can be incorporated into the natural landscaping of an area.

Critical-areas buffer zones should not be used as sediment treatment areas. These areas shall remain completely undisturbed. The local permitting authority may expand the buffer widths temporarily to allow the use of the expanded area for removal of sediment.

Design and Installation Specifications

- Preserving natural vegetation or plantings in clumps, blocks, or strips is generally the easiest and most successful method.
- Leave all unstable steep slopes in natural vegetation.
- Mark clearing limits and keep all equipment and construction debris out of the natural areas and buffer zones. Steel construction fencing is the most effective method in protecting sensitive areas and buffers. Alternatively, wire-backed silt fence on steel posts is marginally effective. Flagging alone is typically not effective.
- Keep all excavations outside the dripline of trees and shrubs.
- Do not push debris or extra soil into the buffer zone area because it will cause damage from burying and smothering.
- Vegetative buffer zones for streams, lakes or other waterways shall be established by the local permitting authority or other state or federal permits or approvals.

Maintenance Standards

Inspect the area frequently to make sure flagging remains in place and the area remains undisturbed. Replace all damaged flagging immediately.

BMP C103: High Visibility Fence

Purpose

Fencing is intended to:

1. Restrict clearing to approved limits.
2. Prevent disturbance of sensitive areas, their buffers, and other areas required to be left undisturbed.
3. Limit construction traffic to designated construction entrances, exits, or internal roads.
4. Protect areas where marking with survey tape may not provide adequate protection.

Conditions of Use

To establish clearing limits plastic, fabric, or metal fence may be used:

- At the boundary of sensitive areas, their buffers, and other areas required to be left uncleared.
- As necessary to control vehicle access to and on the site.

Design and Installation Specifications

High visibility plastic fence shall be composed of a high-density polyethylene material and shall be at least four feet in height. Posts for the fencing shall be steel or wood and placed every 6 feet on center (maximum) or as needed to ensure rigidity. The fencing shall be fastened to the post every six inches with a polyethylene tie. On long continuous lengths of fencing, a tension wire or rope shall be used as a top stringer to prevent sagging between posts. The fence color shall be high visibility orange. The fence tensile strength shall be 360 lbs./ft. using the ASTM D4595 testing method.

If appropriate install fabric silt fence in accordance with [BMP C233](#) to act as high visibility fence. Silt fence shall be at least 3 feet high and must be highly visible to meet the requirements of this BMP.

Metal fences shall be designed and installed according to the manufacturer's specifications.

Metal fences shall be at least 3 feet high and must be highly visible.

Fences shall not be wired or stapled to trees.

Maintenance Standards

If the fence has been damaged or visibility reduced, it shall be repaired or replaced immediately and visibility restored.

BMP C105: Stabilized Construction Entrance / Exit

Purpose Stabilized Construction entrances are established to reduce the amount of sediment transported onto paved roads by vehicles or equipment. This is done by constructing a stabilized pad of quarry spalls at entrances and exits for construction sites.

Conditions of Use Construction entrances shall be stabilized wherever traffic will be entering or leaving a construction site if paved roads or other paved areas are within 1,000 feet of the site.

For residential construction provide stabilized construction entrances for each residence, rather than only at the main subdivision entrance. Stabilized surfaces shall be of sufficient length/width to provide vehicle access/parking, based on lot size/configuration.

On large commercial, highway, and road projects, the designer should include enough extra materials in the contract to allow for additional stabilized entrances not shown in the initial Construction SWPPP. It is difficult to determine exactly where access to these projects will take place; additional materials will enable the contractor to install them where needed.

Design and Installation Specifications

See [Figure 4.1.1](#) for details. Note: the 100' minimum length of the entrance shall be reduced to the maximum practicable size when the size or configuration of the site does not allow the full length (100').

Construct stabilized construction entrances with a 12-inch thick pad of 4-inch to 8-inch quarry spalls, a 4-inch course of asphalt treated base (ATB), or use existing pavement. Do not use crushed concrete, cement, or calcium chloride for construction entrance stabilization because these products raise pH levels in stormwater and concrete discharge to surface waters of the State is prohibited.

A separation geotextile shall be placed under the spalls to prevent fine sediment from pumping up into the rock pad. The geotextile shall meet the following standards:

Grab Tensile Strength (ASTM D4751)	200 psi min.
Grab Tensile Elongation (ASTM D4632)	30% max.
Mullen Burst Strength (ASTM D3786-80a)	400 psi min.
AOS (ASTM D4751)	20-45 (U.S. standard sieve size)

- Consider early installation of the first lift of asphalt in areas that will be paved; this can be used as a stabilized entrance. Also consider the installation of excess concrete as a stabilized entrance. During large concrete pours, excess concrete is often available for this purpose.

- Fencing (see [BMP C103](#)) shall be installed as necessary to restrict traffic to the construction entrance.
- Whenever possible, the entrance shall be constructed on a firm, compacted subgrade. This can substantially increase the effectiveness of the pad and reduce the need for maintenance.
- Construction entrances should avoid crossing existing sidewalks and back of walk drains if at all possible. If a construction entrance must cross a sidewalk or back of walk drain, the full length of the sidewalk and back of walk drain must be covered and protected from sediment leaving the site.

Maintenance Standards

Quarry spalls shall be added if the pad is no longer in accordance with the specifications.

- If the entrance is not preventing sediment from being tracked onto pavement, then alternative measures to keep the streets free of sediment shall be used. This may include replacement/cleaning of the existing quarry spalls, street sweeping, an increase in the dimensions of the entrance, or the installation of a wheel wash.
- Any sediment that is tracked onto pavement shall be removed by shoveling or street sweeping. The sediment collected by sweeping shall be removed or stabilized on site. The pavement shall not be cleaned by washing down the street, except when high efficiency sweeping is ineffective and there is a threat to public safety. If it is necessary to wash the streets, the construction of a small sump to contain the wash water shall be considered. The sediment would then be washed into the sump where it can be controlled.
- Perform street sweeping by hand or with a high efficiency sweeper. Do not use a non-high efficiency mechanical sweeper because this creates dust and throws soils into storm systems or conveyance ditches.
- Any quarry spalls that are loosened from the pad, which end up on the roadway shall be removed immediately.
- If vehicles are entering or exiting the site at points other than the construction entrance(s), fencing (see [BMP C103](#)) shall be installed to control traffic.
- Upon project completion and site stabilization, all construction accesses intended as permanent access for maintenance shall be permanently stabilized.

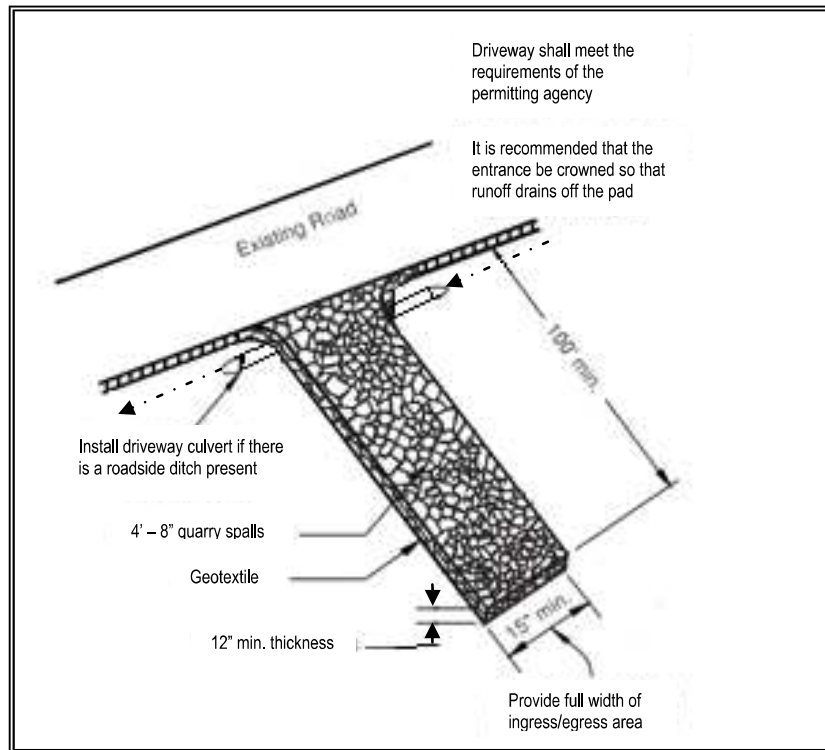

Figure 4.1.1 – Stabilized Construction Entrance

Approved as Equivalent

Ecology has approved products as able to meet the requirements of [BMP C105](#). The products did not pass through the Technology Assessment Protocol – Ecology (TAPE) process. Local jurisdictions may choose not to accept this product approved as equivalent, or may require additional testing prior to consideration for local use. The products are available for review on Ecology’s website at <http://www.ecy.wa.gov/programs/wq/stormwater/newtech/equivalent.html>

BMP C106: Wheel Wash

Purpose

Wheel washes reduce the amount of sediment transported onto paved roads by motor vehicles.

Conditions of Use

When a stabilized construction entrance (see [BMP C105](#)) is not preventing sediment from being tracked onto pavement.

- Wheel washing is generally an effective BMP when installed with careful attention to topography. For example, a wheel wash can be detrimental if installed at the top of a slope abutting a right-of-way where the water from the dripping truck can run unimpeded into the street.

- Pressure washing combined with an adequately sized and surfaced pad with direct drainage to a large 10-foot x 10-foot sump can be very effective.
- Discharge wheel wash or tire bath wastewater to a separate on-site treatment system that prevents discharge to surface water, such as closed-loop recirculation or upland land application, or to the sanitary sewer with local sewer district approval.
- Wheel wash or tire bath wastewater should not include wastewater from concrete washout areas.

***Design and
Installation
Specifications***

Suggested details are shown in [Figure 4.1.2](#). The Local Permitting Authority may allow other designs. A minimum of 6 inches of asphalt treated base (ATB) over crushed base material or 8 inches over a good subgrade is recommended to pave the wheel wash.

Use a low clearance truck to test the wheel wash before paving. Either a belly dump or lowboy will work well to test clearance.

Keep the water level from 12 to 14 inches deep to avoid damage to truck hubs and filling the truck tongues with water.

Midpoint spray nozzles are only needed in extremely muddy conditions.

Wheel wash systems should be designed with a small grade change, 6- to 1-inches for a 10-foot-wide pond, to allow sediment to flow to the low side of pond to help prevent re-suspension of sediment. A drainpipe with a 2- to 3-foot riser should be installed on the low side of the pond to allow for easy cleaning and refilling. Polymers may be used to promote coagulation and flocculation in a closed-loop system. Polyacrylamide (PAM) added to the wheel wash water at a rate of 0.25 - 0.5 pounds per 1,000 gallons of water increases effectiveness and reduces cleanup time. If PAM is already being used for dust or erosion control and is being applied by a water truck, the same truck can be used to change the wash water.

***Maintenance
Standards***

The wheel wash should start out the day with fresh water.

The wash water should be changed a minimum of once per day. On large earthwork jobs where more than 10-20 trucks per hour are expected, the wash water will need to be changed more often.

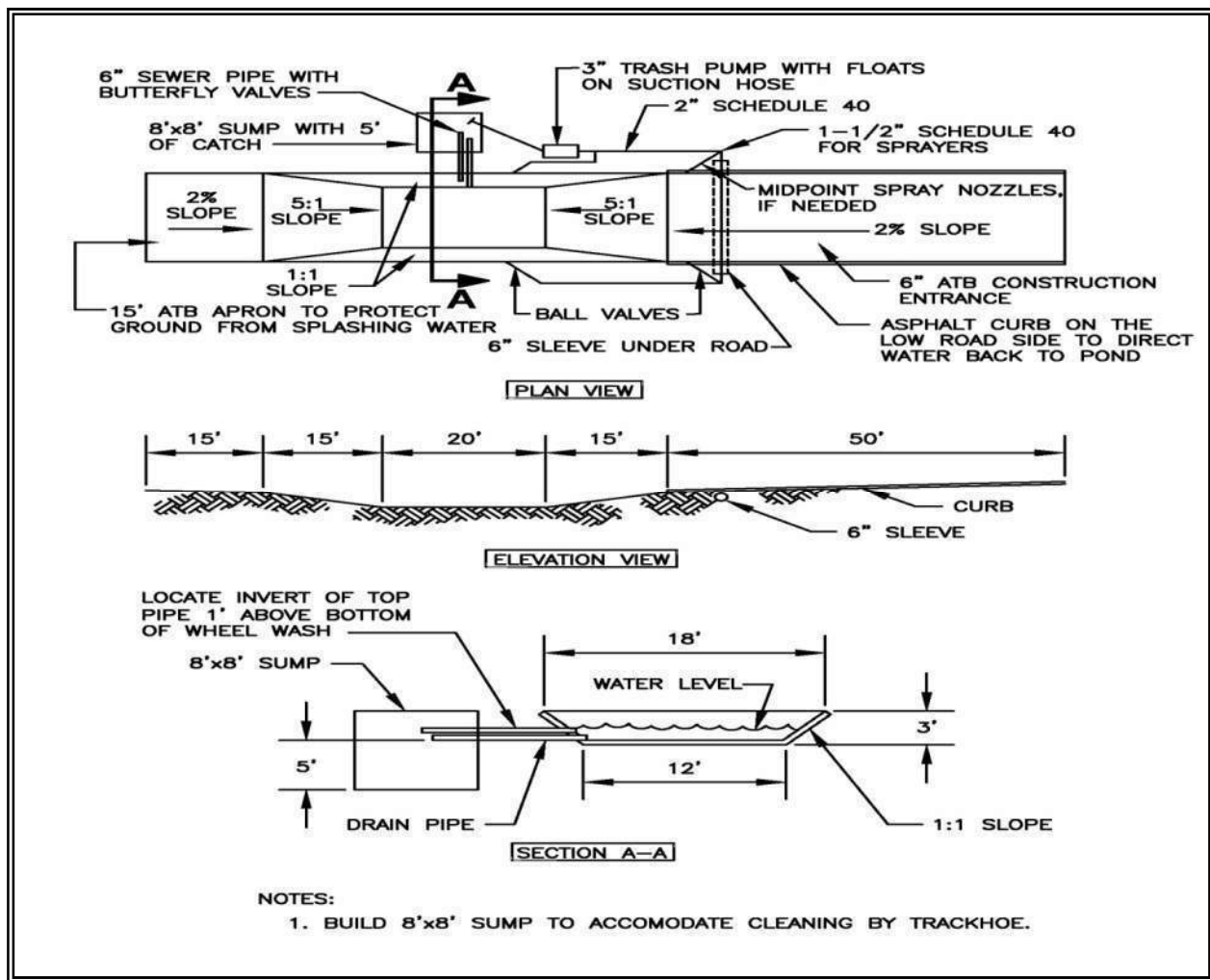

Figure 4.1.2 – Wheel Wash

Notes:

1. Asphalt construction entrance 6 in. asphalt treated base (ATB).
2. 3-inch trash pump with floats on the suction hose.
3. Midpoint spray nozzles, if needed.
4. 6-inch sewer pipe with butterfly valves. Bottom one is a drain. Locate top pipe's invert 1 foot above bottom of wheel wash.
5. 8 foot x 8 foot sump with 5 feet of catch. Build so the sump can be cleaned with a trackhoe.
6. Asphalt curb on the low road side to direct water back to pond.
7. 6-inch sleeve under road.
8. Ball valves.
9. 15 foot. ATB apron to protect ground from splashing water.

BMP C107: Construction Road/Parking Area Stabilization

<i>Purpose</i>	Stabilizing subdivision roads, parking areas, and other on-site vehicle transportation routes immediately after grading reduces erosion caused by construction traffic or runoff.
<i>Conditions of Use</i>	Roads or parking areas shall be stabilized wherever they are constructed, whether permanent or temporary, for use by construction traffic. <ul style="list-style-type: none">• High Visibility Fencing (see BMP C103) shall be installed, if necessary, to limit the access of vehicles to only those roads and parking areas that are stabilized.
<i>Design and Installation Specifications</i>	<ul style="list-style-type: none">• On areas that will receive asphalt as part of the project, install the first lift as soon as possible.• A 6-inch depth of 2- to 4-inch crushed rock, gravel base, or crushed surfacing base course shall be applied immediately after grading or utility installation. A 4-inch course of asphalt treated base (ATB) may also be used, or the road/parking area may be paved. It may also be possible to use cement or calcium chloride for soil stabilization. If cement or cement kiln dust is used for roadbase stabilization, pH monitoring and BMPs (BMPs C252 and C253) are necessary to evaluate and minimize the effects on stormwater. If the area will not be used for permanent roads, parking areas, or structures, a 6-inch depth of hog fuel may also be used, but this is likely to require more maintenance. Whenever possible, construction roads and parking areas shall be placed on a firm, compacted subgrade.• Temporary road gradients shall not exceed 15 percent. Roadways shall be carefully graded to drain. Drainage ditches shall be provided on each side of the roadway in the case of a crowned section, or on one side in the case of a super-elevated section. Drainage ditches shall be directed to a sediment control BMP.• Rather than relying on ditches, it may also be possible to grade the road so that runoff sheet-flows into a heavily vegetated area with a well-developed topsoil. Landscaped areas are not adequate. If this area has at least 50 feet of vegetation that water can flow through, then it is generally preferable to use the vegetation to treat runoff, rather than a sediment pond or trap. The 50 feet shall not include wetlands or their buffers. If runoff is allowed to sheetflow through adjacent vegetated areas, it is vital to design the roadways and parking areas so that no concentrated runoff is created.• Storm drain inlets shall be protected to prevent sediment-laden water entering the storm drain system (see BMP C220).
<i>Maintenance Standards</i>	Inspect stabilized areas regularly, especially after large storm events. Crushed rock, gravel base, etc. shall be added as required to maintain a

stable driving surface and to stabilize any areas that have eroded.

Following construction, these areas shall be restored to pre-construction condition or better to prevent future erosion.

Perform street cleaning at the end of each day or more often if necessary.

BMP C120: Temporary and Permanent Seeding

Purpose

Seeding reduces erosion by stabilizing exposed soils. A well-established vegetative cover is one of the most effective methods of reducing erosion.

Conditions of Use

Use seeding throughout the project on disturbed areas that have reached final grade or that will remain unworked for more than 30 days.

The optimum seeding windows for western Washington are April 1 through June 30 and September 1 through October 1.

Between July 1 and August 30 seeding requires irrigation until 75 percent grass cover is established.

Between October 1 and March 30 seeding requires a cover of mulch with straw or an erosion control blanket until 75 percent grass cover is established.

Review all disturbed areas in late August to early September and complete all seeding by the end of September. Otherwise, vegetation will not establish itself enough to provide more than average protection.

- Mulch is required at all times for seeding because it protects seeds from heat, moisture loss, and transport due to runoff. Mulch can be applied on top of the seed or simultaneously by hydroseeding. See [BMP C121: Mulching](#) for specifications.
- Seed and mulch, all disturbed areas not otherwise vegetated at final site stabilization. Final stabilization means the completion of all soil disturbing activities at the site and the establishment of a permanent vegetative cover, or equivalent permanent stabilization measures (such as pavement, riprap, gabions or geotextiles) which will prevent erosion.

Design and Installation Specifications

Seed retention/detention ponds as required.

Install channels intended for vegetation before starting major earthwork and hydroseed with a Bonded Fiber Matrix. For vegetated channels that will have high flows, install erosion control blankets over hydroseed. Before allowing water to flow in vegetated channels, establish 75 percent vegetation cover. If vegetated channels cannot be established by seed before water flow; install sod in the channel bottom—over hydromulch and erosion control blankets.

- Confirm the installation of all required surface water control measures to prevent seed from washing away.
- Hydroseed applications shall include a minimum of 1,500 pounds per acre of mulch with 3 percent tackifier. See [BMP C121: Mulching](#) for specifications.
- Areas that will have seeding only and not landscaping may need compost or meal-based mulch included in the hydroseed in order to establish vegetation. Re-install native topsoil on the disturbed soil surface before application.
- When installing seed via hydroseeding operations, only about 1/3 of the seed actually ends up in contact with the soil surface. This reduces the ability to establish a good stand of grass quickly. To overcome this, consider increasing seed quantities by up to 50 percent.
- Enhance vegetation establishment by dividing the hydromulch operation into two phases:
 1. Phase 1- Install all seed and fertilizer with 25-30 percent mulch and tackifier onto soil in the first lift.
 2. Phase 2- Install the rest of the mulch and tackifier over the first lift.

Or, enhance vegetation by:

1. Installing the mulch, seed, fertilizer, and tackifier in one lift.
2. Spread or blow straw over the top of the hydromulch at a rate of 800-1000 pounds per acre.
3. Hold straw in place with a standard tackifier.

Both of these approaches will increase cost moderately but will greatly improve and enhance vegetative establishment. The increased cost may be offset by the reduced need for:

- Irrigation.
- Reapplication of mulch.
- Repair of failed slope surfaces.

This technique works with standard hydromulch (1,500 pounds per acre minimum) and BFM/MBFMs (3,000 pounds per acre minimum).

- Seed may be installed by hand if:
 - Temporary and covered by straw, mulch, or topsoil.
 - Permanent in small areas (usually less than 1 acre) and covered with mulch, topsoil, or erosion blankets.
- The seed mixes listed in the tables below include recommended mixes for both temporary and permanent seeding.

- Apply these mixes, with the exception of the wetland mix, at a rate of 120 pounds per acre. This rate can be reduced if soil amendments or slow-release fertilizers are used.
- Consult the local suppliers or the local conservation district for their recommendations because the appropriate mix depends on a variety of factors, including location, exposure, soil type, slope, and expected foot traffic. Alternative seed mixes approved by the local authority may be used.
- Other mixes may be appropriate, depending on the soil type and hydrology of the area.
- [Table 4.1.2](#) lists the standard mix for areas requiring a temporary vegetative cover.

Table 4.1.2 Temporary Erosion Control Seed Mix			
	% Weight	% Purity	% Germination
Chewings or annual blue grass <i>Festuca rubra var. commutata</i> or <i>Poa anna</i>	40	98	90
Perennial rye - <i>Lolium perenne</i>	50	98	90
Redtop or colonial bentgrass <i>Agrostis alba</i> or <i>Agrostis tenuis</i>	5	92	85
White dutch clover <i>Trifolium repens</i>	5	98	90

- [Table 4.1.3](#) lists a recommended mix for landscaping seed.

Table 4.1.3 Landscaping Seed Mix			
	% Weight	% Purity	% Germination
Perennial rye blend <i>Lolium perenne</i>	70	98	90
Chewings and red fescue blend <i>Festuca rubra var. commutata</i> or <i>Festuca rubra</i>	30	98	90

- [Table 4.1.4](#) lists a turf seed mix for dry situations where there is no need for watering. This mix requires very little maintenance.

Table 4.1.4 Low-Growing Turf Seed Mix			
	% Weight	% Purity	% Germination
Dwarf tall fescue (several varieties) <i>Festuca arundinacea</i> var.	45	98	90
Dwarf perennial rye (Barclay) <i>Lolium perenne</i> var. <i>barclay</i>	30	98	90
Red fescue <i>Festuca rubra</i>	20	98	90
Colonial bentgrass <i>Agrostis tenuis</i>	5	98	90

- [Table 4.1.5](#) lists a mix for bioswales and other intermittently wet areas.

Table 4.1.5 Bioswale Seed Mix*			
	% Weight	% Purity	% Germination
Tall or meadow fescue <i>Festuca arundinacea</i> or <i>Festuca elatior</i>	75-80	98	90
Seaside/Creeping bentgrass <i>Agrostis palustris</i>	10-15	92	85
Redtop bentgrass <i>Agrostis alba</i> or <i>Agrostis gigantea</i>	5-10	90	80

* Modified Briargreen, Inc. Hydroseeding Guide Wetlands Seed Mix

- [Table 4.1.6](#) lists a low-growing, relatively non-invasive seed mix appropriate for very wet areas that are not regulated wetlands. Apply this mixture at a rate of 60 pounds per acre. Consult Hydraulic Permit Authority (HPA) for seed mixes if applicable.

Table 4.1.6 Wet Area Seed Mix*			
	% Weight	% Purity	% Germination
Tall or meadow fescue <i>Festuca arundinacea</i> or <i>Festuca elatior</i>	60-70	98	90
Seaside/Creeping bentgrass <i>Agrostis palustris</i>	10-15	98	85
Meadow foxtail <i>Alephocurus pratensis</i>	10-15	90	80
Alsike clover <i>Trifolium hybridum</i>	1-6	98	90
Redtop bentgrass <i>Agrostis alba</i>	1-6	92	85

* Modified Briargreen, Inc. Hydroseeding Guide Wetlands Seed Mix

- Table 4.1.7 lists a recommended meadow seed mix for infrequently maintained areas or non-maintained areas where colonization by native plants is desirable. Likely applications include rural road and utility right-of-way. Seeding should take place in September or very early October in order to obtain adequate establishment prior to the winter months. Consider the appropriateness of clover, a fairly invasive species, in the mix. Amending the soil can reduce the need for clover.

Table 4.1.7 Meadow Seed Mix			
	% Weight	% Purity	% Germination
Redtop or Oregon bentgrass <i>Agrostis alba</i> or <i>Agrostis oregonensis</i>	20	92	85
Red fescue <i>Festuca rubra</i>	70	98	90
White dutch clover <i>Trifolium repens</i>	10	98	90

- **Roughening and Rototilling:**
 - The seedbed should be firm and rough. Roughen all soil no matter what the slope. Track walk slopes before seeding if engineering purposes require compaction. Backblading or smoothing of slopes greater than 4H:1V is not allowed if they are to be seeded.
 - Restoration-based landscape practices require deeper incorporation than that provided by a simple single-pass rototilling treatment. Wherever practical, initially rip the subgrade to improve long-term permeability, infiltration, and water inflow qualities. At a minimum, permanent areas shall use soil amendments to achieve organic matter and permeability performance defined in engineered soil/landscape systems. For systems that are deeper than 8 inches complete the rototilling process in multiple lifts, or prepare the engineered soil system per specifications and place to achieve the specified depth.
- **Fertilizers:**
 - Conducting soil tests to determine the exact type and quantity of fertilizer is recommended. This will prevent the over-application of fertilizer.
 - Organic matter is the most appropriate form of fertilizer because it provides nutrients (including nitrogen, phosphorus, and potassium) in the least water-soluble form.
 - In general, use 10-4-6 N-P-K (nitrogen-phosphorus-potassium) fertilizer at a rate of 90 pounds per acre. Always use slow-release fertilizers because they are more efficient and have fewer environmental impacts. Do not add fertilizer to the hydromulch machine, or agitate, more than 20 minutes before use. Too much agitation destroys the slow-release coating.
 - There are numerous products available that take the place of chemical fertilizers. These include several with seaweed extracts that are beneficial to soil microbes and organisms. If 100 percent cottonseed meal is used as the mulch in hydroseed, chemical fertilizer may not be necessary. Cottonseed meal provides a good source of long-term, slow-release, available nitrogen.
- **Bonded Fiber Matrix and Mechanically Bonded Fiber Matrix:**
 - On steep slopes use Bonded Fiber Matrix (BFM) or Mechanically Bonded Fiber Matrix (MBFM) products. Apply BFM/MBFM products at a minimum rate of 3,000 pounds per acre of mulch with approximately 10 percent tackifier. Achieve a minimum of 95 percent soil coverage during application. Numerous products are available commercially. Installed products per manufacturer's instructions. Most products require 24-36 hours to cure before rainfall and cannot be installed on wet or saturated soils.

Generally, products come in 40-50 pound bags and include all necessary ingredients except for seed and fertilizer.

- BFM and MBFMs provide good alternatives to blankets in most areas requiring vegetation establishment. Advantages over blankets include:
 - BFM and MBFMs do not require surface preparation.
 - Helicopters can assist in installing BFM and MBFMs in remote areas.
 - On slopes steeper than 2.5H:1V, blanket installers may require ropes and harnesses for safety.
 - Installing BFM and MBFMs can save at least \$1,000 per acre compared to blankets.

Maintenance Standards

Reseed any seeded areas that fail to establish at least 80 percent cover (100 percent cover for areas that receive sheet or concentrated flows). If reseeding is ineffective, use an alternate method such as sodding, mulching, or nets/blankets. If winter weather prevents adequate grass growth, this time limit may be relaxed at the discretion of the local authority when sensitive areas would otherwise be protected.

- Reseed and protect by mulch any areas that experience erosion after achieving adequate cover. Reseed and protect by mulch any eroded area.
- Supply seeded areas with adequate moisture, but do not water to the extent that it causes runoff.

Approved as Equivalent

Ecology has approved products as able to meet the requirements of [BMP C120](#). The products did not pass through the Technology Assessment Protocol – Ecology (TAPE) process. Local jurisdictions may choose not to accept this product approved as equivalent, or may require additional testing prior to consideration for local use. The products are available for review on Ecology’s website at

<http://www.ecy.wa.gov/programs/wq/stormwater/newtech/equivalent.html>

BMP C121: Mulching

Purpose

Mulching soils provides immediate temporary protection from erosion. Mulch also enhances plant establishment by conserving moisture, holding fertilizer, seed, and topsoil in place, and moderating soil temperatures. There is an enormous variety of mulches that can be used. This section discusses only the most common types of mulch.

Conditions of Use

As a temporary cover measure, mulch should be used:

- For less than 30 days on disturbed areas that require cover.
- At all times for seeded areas, especially during the wet season and

during the hot summer months.

- During the wet season on slopes steeper than 3H:1V with more than 10 feet of vertical relief.

Mulch may be applied at any time of the year and must be refreshed periodically.

- For seeded areas mulch may be made up of 100 percent: cottonseed meal; fibers made of wood, recycled cellulose, hemp, kenaf; compost; or blends of these. Tackifier shall be plant-based, such as guar or alpha plantago, or chemical-based such as polyacrylamide or polymers. Any mulch or tackifier product used shall be installed per manufacturer's instructions. Generally, mulches come in 40-50 pound bags. Seed and fertilizer are added at time of application.

***Design and
Installation
Specifications***

For mulch materials, application rates, and specifications, see [Table 4.1.8](#). Always use a 2-inch minimum mulch thickness; increase the thickness until the ground is 95% covered (i.e. not visible under the mulch layer). Note: Thickness may be increased for disturbed areas in or near sensitive areas or other areas highly susceptible to erosion.

Mulch used within the ordinary high-water mark of surface waters should be selected to minimize potential flotation of organic matter. Composted organic materials have higher specific gravities (densities) than straw, wood, or chipped material. Consult Hydraulic Permit Authority (HPA) for mulch mixes if applicable.

***Maintenance
Standards***

- The thickness of the cover must be maintained.
- Any areas that experience erosion shall be remulched and/or protected with a net or blanket. If the erosion problem is drainage related, then the problem shall be fixed and the eroded area remulched.

**Table 4.1.8
Mulch Standards and Guidelines**

Mulch Material	Quality Standards	Application Rates	Remarks
Straw	Air-dried; free from undesirable seed and coarse material.	2"-3" thick; 5 bales per 1,000 sf or 2-3 tons per acre	Cost-effective protection when applied with adequate thickness. Hand-application generally requires greater thickness than blown straw. The thickness of straw may be reduced by half when used in conjunction with seeding. In windy areas straw must be held in place by crimping, using a tackifier, or covering with netting. Blown straw always has to be held in place with a tackifier as even light winds will blow it away. Straw, however, has several deficiencies that should be considered when selecting mulch materials. It often introduces and/or encourages the propagation of weed species and it has no significant long-term benefits. It should also not be used within the ordinary high-water elevation of surface waters (due to flotation).
Hydromulch	No growth inhibiting factors.	Approx. 25-30 lbs per 1,000 sf or 1,500 - 2,000 lbs per acre	Shall be applied with hydromulcher. Shall not be used without seed and tackifier unless the application rate is at least doubled. Fibers longer than about ¾-1 inch clog hydromulch equipment. Fibers should be kept to less than ¾ inch.
Composted Mulch and Compost	No visible water or dust during handling. Must be produced in accordance with WAC 173-350 , Solid Waste Handling Standards.	2" thick min.; approx. 100 tons per acre (approx. 800 lbs per yard)	More effective control can be obtained by increasing thickness to 3". Excellent mulch for protecting final grades until landscaping because it can be directly seeded or tilled into soil as an amendment. Composted mulch has a coarser size gradation than compost. It is more stable and practical to use in wet areas and during rainy weather conditions. Do not use composted mulch near wetlands or near phosphorous impaired water bodies.
Chipped Site Vegetation	Average size shall be several inches. Gradations from fines to 6 inches in length for texture, variation, and interlocking properties.	2" thick min.;	This is a cost-effective way to dispose of debris from clearing and grubbing, and it eliminates the problems associated with burning. Generally, it should not be used on slopes above approx. 10% because of its tendency to be transported by runoff. It is not recommended within 200 feet of surface waters. If seeding is expected shortly after mulch, the decomposition of the chipped vegetation may tie up nutrients important to grass establishment.
Wood-based Mulch or Wood Straw	No visible water or dust during handling. Must be purchased from a supplier with a Solid Waste Handling Permit or one exempt from solid waste regulations.	2" thick min.; approx. 100 tons per acre (approx. 800 lbs. per cubic yard)	This material is often called "hog or hogged fuel." The use of mulch ultimately improves the organic matter in the soil. Special caution is advised regarding the source and composition of wood-based mulches. Its preparation typically does not provide any weed seed control, so evidence of residual vegetation in its composition or known inclusion of weed plants or seeds should be monitored and prevented (or minimized).
Wood Strand Mulch	A blend of loose, long, thin wood pieces derived from native conifer or deciduous trees with high length-to-width ratio.	2" thick min.	Cost-effective protection when applied with adequate thickness. A minimum of 95-percent of the wood strand shall have lengths between 2 and 10-inches, with a width and thickness between 1/16 and ¾-inches. The mulch shall not contain resin, tannin, or other compounds in quantities that would be detrimental to plant life. Sawdust or wood shavings shall not be used as mulch. (WSDOT specification (9-14.4(4))

BMP C122: Nets and Blankets

Purpose

Erosion control nets and blankets are intended to prevent erosion and hold seed and mulch in place on steep slopes and in channels so that vegetation can become well established. In addition, some nets and blankets can be used to permanently reinforce turf to protect drainage ways during high flows. Nets (commonly called matting) are strands of material woven into an open, but high-tensile strength net (for example, coconut fiber matting). Blankets are strands of material that are not tightly woven, but instead form a layer of interlocking fibers, typically held together by a biodegradable or photodegradable netting (for example, excelsior or straw blankets). They generally have lower tensile strength than nets, but cover the ground more completely. Coir (coconut fiber) fabric comes as both nets and blankets.

Conditions of Use

Erosion control nets and blankets should be used:

- To aid permanent vegetated stabilization of slopes 2H:1V or greater and with more than 10 feet of vertical relief.
- For drainage ditches and swales (highly recommended). The application of appropriate netting or blanket to drainage ditches and swales can protect bare soil from channelized runoff while vegetation is established. Nets and blankets also can capture a great deal of sediment due to their open, porous structure. Nets and blankets can be used to permanently stabilize channels and may provide a cost-effective, environmentally preferable alternative to riprap. 100 percent synthetic blankets manufactured for use in ditches may be easily reused as temporary ditch liners.

Disadvantages of blankets include:

- Surface preparation required.
- On slopes steeper than 2.5H:1V, blanket installers may need to be roped and harnessed for safety.
- They cost at least \$4,000-6,000 per acre installed.

Advantages of blankets include:

- Installation without mobilizing special equipment.
- Installation by anyone with minimal training
- Installation in stages or phases as the project progresses.
- Installers can hand place seed and fertilizer as they progress down the slope.
- Installation in any weather.
- There are numerous types of blankets that can be designed with various parameters in mind. Those parameters include: fiber blend, mesh strength, longevity, biodegradability, cost, and availability.

Design and Installation Specifications

- See [Figure 4.1.3](#) and [Figure 4.1.4](#) for typical orientation and installation of blankets used in channels and as slope protection. Note: these are typical only; all blankets must be installed per manufacturer's installation instructions.
- Installation is critical to the effectiveness of these products. If good ground contact is not achieved, runoff can concentrate under the product, resulting in significant erosion.
- Installation of Blankets on Slopes:
 1. Complete final grade and track walk up and down the slope.
 2. Install hydromulch with seed and fertilizer.
 3. Dig a small trench, approximately 12 inches wide by 6 inches deep along the top of the slope.
 4. Install the leading edge of the blanket into the small trench and staple approximately every 18 inches. NOTE: Staples are metal, "U"-shaped, and a minimum of 6 inches long. Longer staples are used in sandy soils. Biodegradable stakes are also available.
 5. Roll the blanket slowly down the slope as installer walks backwards. NOTE: The blanket rests against the installer's legs. Staples are installed as the blanket is unrolled. It is critical that the proper staple pattern is used for the blanket being installed. The blanket is not to be allowed to roll down the slope on its own as this stretches the blanket making it impossible to maintain soil contact. In addition, no one is allowed to walk on the blanket after it is in place.
 6. If the blanket is not long enough to cover the entire slope length, the trailing edge of the upper blanket should overlap the leading edge of the lower blanket and be stapled. On steeper slopes, this overlap should be installed in a small trench, stapled, and covered with soil.
- With the variety of products available, it is impossible to cover all the details of appropriate use and installation. Therefore, it is critical that the design engineer consult the manufacturer's information and that a site visit takes place in order to ensure that the product specified is appropriate. Information is also available at the following web sites:
 1. WSDOT (Section 3.2.4):
<http://www.wsdot.wa.gov/NR/rdonlyres/3B41E087-FA86-4717-932D-D7A8556CCD57/0/ErosionTrainingManual.pdf>
 2. Texas Transportation Institute:
http://www.txdot.gov/business/doing_business/product_evaluation/erosion_control.htm

- Use jute matting in conjunction with mulch ([BMP C121](#)). Excelsior, woven straw blankets and coir (coconut fiber) blankets may be installed without mulch. There are many other types of erosion control nets and blankets on the market that may be appropriate in certain circumstances.
 - In general, most nets (e.g., jute matting) require mulch in order to prevent erosion because they have a fairly open structure. Blankets typically do not require mulch because they usually provide complete protection of the surface.
 - Extremely steep, unstable, wet, or rocky slopes are often appropriate candidates for use of synthetic blankets, as are riverbanks, beaches and other high-energy environments. If synthetic blankets are used, the soil should be hydromulched first.
 - 100-percent biodegradable blankets are available for use in sensitive areas. These organic blankets are usually held together with a paper or fiber mesh and stitching which may last up to a year.
 - Most netting used with blankets is photodegradable, meaning they break down under sunlight (not UV stabilized). However, this process can take months or years even under bright sun. Once vegetation is established, sunlight does not reach the mesh. It is not uncommon to find non-degraded netting still in place several years after installation. This can be a problem if maintenance requires the use of mowers or ditch cleaning equipment. In addition, birds and small animals can become trapped in the netting.
- Maintenance Standards***
- Maintain good contact with the ground. Erosion must not occur beneath the net or blanket.
 - Repair and staple any areas of the net or blanket that are damaged or not in close contact with the ground.
 - Fix and protect eroded areas if erosion occurs due to poorly controlled drainage.

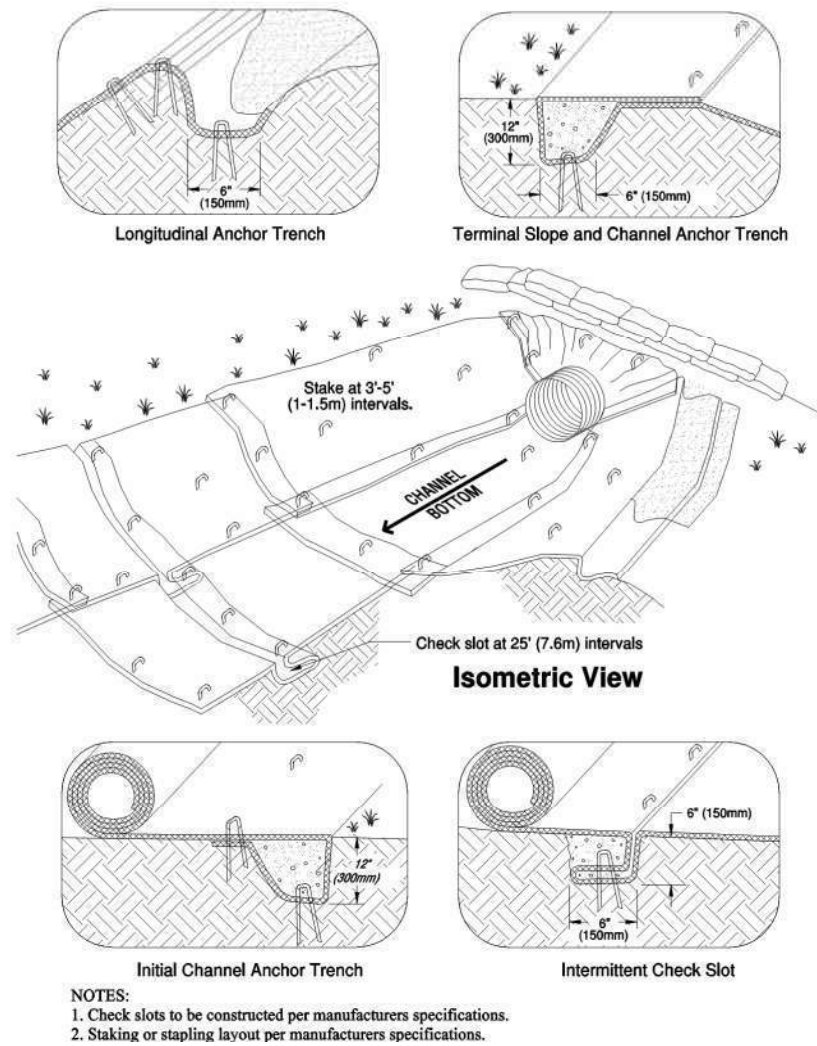

Figure 4.1.3 – Channel Installation

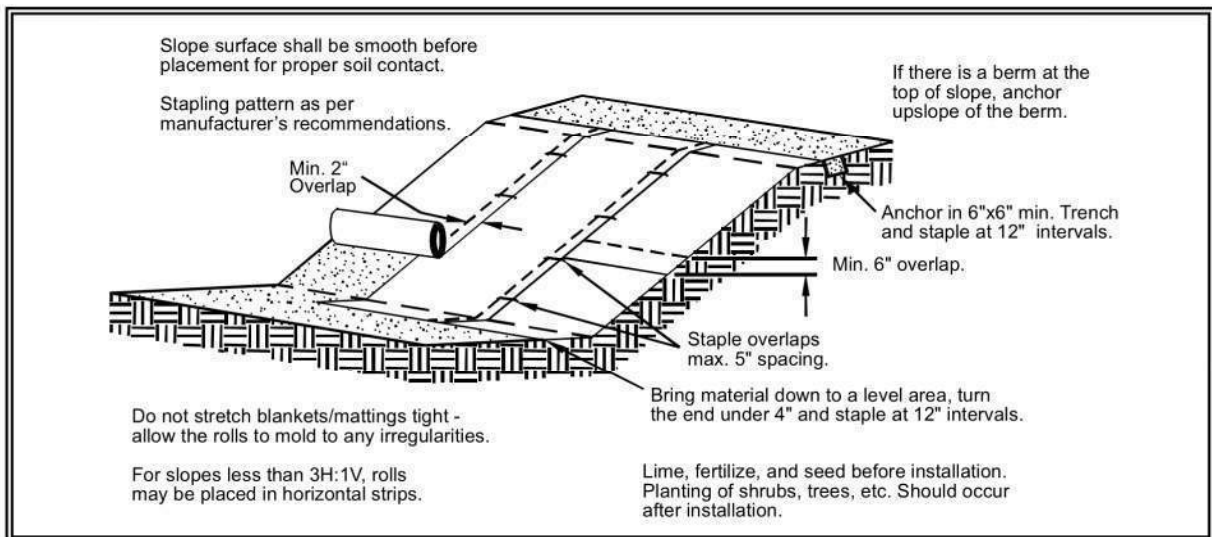

Figure 4.1.4 – Slope Installation

BMP C123: Plastic Covering

Purpose

Plastic covering provides immediate, short-term erosion protection to slopes and disturbed areas.

Conditions of Use

Plastic covering may be used on disturbed areas that require cover measures for less than 30 days, except as stated below.

- Plastic is particularly useful for protecting cut and fill slopes and stockpiles. Note: The relatively rapid breakdown of most polyethylene sheeting makes it unsuitable for long-term (greater than six months) applications.
- Due to rapid runoff caused by plastic covering, do not use this method upslope of areas that might be adversely impacted by concentrated runoff. Such areas include steep and/or unstable slopes.
- Plastic sheeting may result in increased runoff volumes and velocities, requiring additional on-site measures to counteract the increases. Creating a trough with wattles or other material can convey clean water away from these areas.
- To prevent undercutting, trench and backfill rolled plastic covering products.
- While plastic is inexpensive to purchase, the added cost of installation, maintenance, removal, and disposal make this an expensive material, up to \$1.50-2.00 per square yard.
- Whenever plastic is used to protect slopes install water collection measures at the base of the slope. These measures include plastic-covered berms, channels, and pipes used to convey clean rainwater away from bare soil and disturbed areas. Do not mix clean runoff from a plastic covered slope with dirty runoff from a project.
- Other uses for plastic include:
 1. Temporary ditch liner.
 2. Pond liner in temporary sediment pond.
 3. Liner for bermed temporary fuel storage area if plastic is not reactive to the type of fuel being stored.
 4. Emergency slope protection during heavy rains.
 5. Temporary drainpipe (“elephant trunk”) used to direct water.
- Plastic slope cover must be installed as follows:
 1. Run plastic up and down slope, not across slope.
 2. Plastic may be installed perpendicular to a slope if the slope length is less than 10 feet.
 3. Minimum of 8-inch overlap at seams.

Design and Installation Specifications

4. On long or wide slopes, or slopes subject to wind, tape all seams.
 5. Place plastic into a small (12-inch wide by 6-inch deep) slot trench at the top of the slope and backfill with soil to keep water from flowing underneath.
 6. Place sand filled burlap or geotextile bags every 3 to 6 feet along seams and tie them together with twine to hold them in place.
 7. Inspect plastic for rips, tears, and open seams regularly and repair immediately. This prevents high velocity runoff from contacting bare soil which causes extreme erosion.
 8. Sandbags may be lowered into place tied to ropes. However, all sandbags must be staked in place.
- Plastic sheeting shall have a minimum thickness of 0.06 millimeters.
 - If erosion at the toe of a slope is likely, a gravel berm, riprap, or other suitable protection shall be installed at the toe of the slope in order to reduce the velocity of runoff.
 - Torn sheets must be replaced and open seams repaired.
 - Completely remove and replace the plastic if it begins to deteriorate due to ultraviolet radiation.
 - Completely remove plastic when no longer needed.
 - Dispose of old tires used to weight down plastic sheeting appropriately.

Maintenance Standards

Approved as Equivalent

Ecology has approved products as able to meet the requirements of [BMP C123](#). The products did not pass through the Technology Assessment Protocol – Ecology (TAPE) process. Local jurisdictions may choose not to accept this product approved as equivalent, or may require additional testing prior to consideration for local use. The products are available for review on Ecology’s website at <http://www.ecy.wa.gov/programs/wq/stormwater/newtech/equivalent.html>

BMP C124: Sodding

Purpose

The purpose of sodding is to establish permanent turf for immediate erosion protection and to stabilize drainage ways where concentrated overland flow will occur.

Conditions of Use

Sodding may be used in the following areas:

- Disturbed areas that require short-term or long-term cover.
- Disturbed areas that require immediate vegetative cover.
- All waterways that require vegetative lining. Waterways may also be seeded rather than sodded, and protected with a net or blanket.

BMP C140: Dust Control

Purpose

Dust control prevents wind transport of dust from disturbed soil surfaces onto roadways, drainage ways, and surface waters.

Conditions of Use

- In areas (including roadways) subject to surface and air movement of dust where on-site and off-site impacts to roadways, drainage ways, or surface waters are likely.

Design and Installation Specifications

- Vegetate or mulch areas that will not receive vehicle traffic. In areas where planting, mulching, or paving is impractical, apply gravel or landscaping rock.
- Limit dust generation by clearing only those areas where immediate activity will take place, leaving the remaining area(s) in the original condition. Maintain the original ground cover as long as practical.
- Construct natural or artificial windbreaks or windscreens. These may be designed as enclosures for small dust sources.
- Sprinkle the site with water until surface is wet. Repeat as needed. To prevent carryout of mud onto street, refer to Stabilized Construction Entrance ([BMP C105](#)).
- Irrigation water can be used for dust control. Irrigation systems should be installed as a first step on sites where dust control is a concern.
- Spray exposed soil areas with a dust palliative, following the manufacturer's instructions and cautions regarding handling and application. Used oil is prohibited from use as a dust suppressant. Local governments may approve other dust palliatives such as calcium chloride or PAM.
- PAM ([BMP C126](#)) added to water at a rate of 0.5 lbs. per 1,000 gallons of water per acre and applied from a water truck is more effective than water alone. This is due to increased infiltration of water into the soil and reduced evaporation. In addition, small soil particles are bonded together and are not as easily transported by wind. Adding PAM may actually reduce the quantity of water needed for dust control. Use of PAM could be a cost-effective dust control method.

Techniques that can be used for unpaved roads and lots include:

- Lower speed limits. High vehicle speed increases the amount of dust stirred up from unpaved roads and lots.
- Upgrade the road surface strength by improving particle size, shape, and mineral types that make up the surface and base materials.
- Add surface gravel to reduce the source of dust emission. Limit the amount of fine particles (those smaller than .075 mm) to 10 to 20 percent.

- Use geotextile fabrics to increase the strength of new roads or roads undergoing reconstruction.
- Encourage the use of alternate, paved routes, if available.
- Restrict use of paved roadways by tracked vehicles and heavy trucks to prevent damage to road surface and base.
- Apply chemical dust suppressants using the admix method, blending the product with the top few inches of surface material. Suppressants may also be applied as surface treatments.
- Pave unpaved permanent roads and other trafficked areas.
- Use vacuum street sweepers.
- Remove mud and other dirt promptly so it does not dry and then turn into dust.
- Limit dust-causing work on windy days.
- Contact your local Air Pollution Control Authority for guidance and training on other dust control measures. Compliance with the local Air Pollution Control Authority constitutes compliance with this BMP.

Maintenance Standards

Respray area as necessary to keep dust to a minimum.

BMP C150: Materials on Hand

Purpose

Keep quantities of erosion prevention and sediment control materials on the project site at all times to be used for regular maintenance and emergency situations such as unexpected heavy summer rains. Having these materials on-site reduces the time needed to implement BMPs when inspections indicate that existing BMPs are not meeting the Construction SWPPP requirements. In addition, contractors can save money by buying some materials in bulk and storing them at their office or yard.

Conditions of Use

- Construction projects of any size or type can benefit from having materials on hand. A small commercial development project could have a roll of plastic and some gravel available for immediate protection of bare soil and temporary berm construction. A large earthwork project, such as highway construction, might have several tons of straw, several rolls of plastic, flexible pipe, sandbags, geotextile fabric and steel “T” posts.
- Materials are stockpiled and readily available before any site clearing, grubbing, or earthwork begins. A large contractor or developer could keep a stockpile of materials that are available for use on several projects.
- If storage space at the project site is at a premium, the contractor could maintain the materials at their office or yard. The office or yard must be less than an hour from the project site.

Design and Installation Specifications

Depending on project type, size, complexity, and length, materials and quantities will vary. A good minimum list of items that will cover numerous situations includes:

Material
Clear Plastic, 6 mil
Drainpipe, 6 or 8 inch diameter
Sandbags, filled
Straw Bales for mulching,
Quarry Spalls
Washed Gravel
Geotextile Fabric
Catch Basin Inserts
Steel “T” Posts
Silt fence material
Straw Wattles

Maintenance Standards

- All materials with the exception of the quarry spalls, steel “T” posts, and gravel should be kept covered and out of both sun and rain.
- Re-stock materials used as needed.

BMP C151: Concrete Handling

Purpose

Concrete work can generate process water and slurry that contain fine particles and high pH, both of which can violate water quality standards in the receiving water. Concrete spillage or concrete discharge to surface waters of the State is prohibited. Use this BMP to minimize and eliminate concrete, concrete process water, and concrete slurry from entering waters of the state.

Conditions of Use

Any time concrete is used, utilize these management practices. Concrete construction projects include, but are not limited to, the following:

- Curbs
- Sidewalks
- Roads
- Bridges
- Foundations
- Floors
- Runways

Design and Installation

- Wash out concrete truck chutes, pumps, and internals into formed areas only. Assure that washout of concrete trucks is performed off-

Specifications

site or in designated concrete washout areas. Do not wash out concrete trucks onto the ground, or into storm drains, open ditches, streets, or streams. Refer to [BMP C154](#) for information on concrete washout areas.

- Return unused concrete remaining in the truck and pump to the originating batch plant for recycling. Do not dump excess concrete on site, except in designated concrete washout areas.
- Wash off hand tools including, but not limited to, screeds, shovels, rakes, floats, and trowels into formed areas only.
- Wash equipment difficult to move, such as concrete pavers in areas that do not directly drain to natural or constructed stormwater conveyances.
- Do not allow washdown from areas, such as concrete aggregate driveways, to drain directly to natural or constructed stormwater conveyances.
- Contain washwater and leftover product in a lined container when no formed areas are available,. Dispose of contained concrete in a manner that does not violate ground water or surface water quality standards.
- Always use forms or solid barriers for concrete pours, such as pilings, within 15-feet of surface waters.
- Refer to [BMPs C252](#) and [C253](#) for pH adjustment requirements.
- Refer to the Construction Stormwater General Permit for pH monitoring requirements if the project involves one of the following activities:
 - Significant concrete work (greater than 1,000 cubic yards poured concrete or recycled concrete used over the life of a project).
 - The use of engineered soils amended with (but not limited to) Portland cement-treated base, cement kiln dust or fly ash.
 - Discharging stormwater to segments of water bodies on the 303(d) list (Category 5) for high pH.

Maintenance Standards

Check containers for holes in the liner daily during concrete pours and repair the same day.

BMP C152: Sawcutting and Surfacing Pollution Prevention

Purpose Sawcutting and surfacing operations generate slurry and process water that contains fine particles and high pH (concrete cutting), both of which can violate the water quality standards in the receiving water. Concrete spillage or concrete discharge to surface waters of the State is prohibited. Use this BMP to minimize and eliminate process water and slurry created through sawcutting or surfacing from entering waters of the State.

Conditions of Use Utilize these management practices anytime sawcutting or surfacing operations take place. Sawcutting and surfacing operations include, but are not limited to, the following:

- Sawing
- Coring
- Grinding
- Roughening
- Hydro-demolition
- Bridge and road surfacing
- Vacuum slurry and cuttings during cutting and surfacing operations.
- Slurry and cuttings shall not remain on permanent concrete or asphalt pavement overnight.
- Slurry and cuttings shall not drain to any natural or constructed drainage conveyance including stormwater systems. This may require temporarily blocking catch basins.
- Dispose of collected slurry and cuttings in a manner that does not violate ground water or surface water quality standards.
- Do not allow process water generated during hydro-demolition, surface roughening or similar operations to drain to any natural or constructed drainage conveyance including stormwater systems. Dispose process water in a manner that does not violate ground water or surface water quality standards.
- Handle and dispose cleaning waste material and demolition debris in a manner that does not cause contamination of water. Dispose of sweeping material from a pick-up sweeper at an appropriate disposal site.

Maintenance Standards Continually monitor operations to determine whether slurry, cuttings, or process water could enter waters of the state. If inspections show that a violation of water quality standards could occur, stop operations and immediately implement preventive measures such as berms, barriers, secondary containment, and vacuum trucks.

BMP C200: Interceptor Dike and Swale

Purpose

Provide a ridge of compacted soil, or a ridge with an upslope swale, at the top or base of a disturbed slope or along the perimeter of a disturbed construction area to convey stormwater. Use the dike and/or swale to intercept the runoff from unprotected areas and direct it to areas where erosion can be controlled. This can prevent storm runoff from entering the work area or sediment-laden runoff from leaving the construction site.

Conditions of Use

Where the runoff from an exposed site or disturbed slope must be conveyed to an erosion control facility which can safely convey the stormwater.

- Locate upslope of a construction site to prevent runoff from entering disturbed area.
- When placed horizontally across a disturbed slope, it reduces the amount and velocity of runoff flowing down the slope.
- Locate downslope to collect runoff from a disturbed area and direct water to a sediment basin.

Design and Installation Specifications

- Dike and/or swale and channel must be stabilized with temporary or permanent vegetation or other channel protection during construction.
- Channel requires a positive grade for drainage; steeper grades require channel protection and check dams.
- Review construction for areas where overtopping may occur.
- Can be used at top of new fill before vegetation is established.
- May be used as a permanent diversion channel to carry the runoff.
- Sub-basin tributary area should be one acre or less.
- Design capacity for the peak flow from a 10-year, 24-hour storm, assuming a Type 1A rainfall distribution, for temporary facilities. Alternatively, use 1.6 times the 10-year, 1-hour flow indicated by an approved continuous runoff model. For facilities that will also serve on a permanent basis, consult the local government's drainage requirements.

Interceptor dikes shall meet the following criteria:

Top Width	2 feet minimum.
Height	1.5 feet minimum on berm.
Side Slope	2H:1V or flatter.
Grade	Depends on topography, however, dike system minimum is 0.5%, and maximum is 1%.
Compaction	Minimum of 90 percent ASTM D698 standard proctor.

Horizontal Spacing of Interceptor Dikes:

Average Slope	Slope Percent	Flowpath Length
20H:1V or less	3-5%	300 feet
(10 to 20)H:1V	5-10%	200 feet
(4 to 10)H:1V	10-25%	100 feet
(2 to 4)H:1V	25-50%	50 feet

Stabilization depends on velocity and reach

Slopes <5% Seed and mulch applied within 5 days of dike construction (see [BMP C121, Mulching](#)).

Slopes 5 - 40% Dependent on runoff velocities and dike materials. Stabilization should be done immediately using either sod or riprap or other measures to avoid erosion.

- The upslope side of the dike shall provide positive drainage to the dike outlet. No erosion shall occur at the outlet. Provide energy dissipation measures as necessary. Sediment-laden runoff must be released through a sediment trapping facility.
- Minimize construction traffic over temporary dikes. Use temporary cross culverts for channel crossing.

Interceptor swales shall meet the following criteria:

Bottom Width 2 feet minimum; the cross-section bottom shall be level.

Depth 1-foot minimum.

Side Slope 2H:1V or flatter.

Grade Maximum 5 percent, with positive drainage to a suitable outlet (such as a sediment pond).

Stabilization Seed as per [BMP C120, Temporary and Permanent Seeding](#), or [BMP C202, Channel Lining](#), 12 inches thick riprap pressed into the bank and extending at least 8 inches vertical from the bottom.

- Inspect diversion dikes and interceptor swales once a week and after every rainfall. Immediately remove sediment from the flow area.
- Damage caused by construction traffic or other activity must be repaired before the end of each working day.

Check outlets and make timely repairs as needed to avoid gully formation. When the area below the temporary diversion dike is permanently stabilized, remove the dike and fill and stabilize the channel to blend with the natural surface.

BMP C201: Grass-Lined Channels

Purpose To provide a channel with a vegetative lining for conveyance of runoff. See [Figure 4.2.1](#) for typical grass-lined channels.

Conditions of Use This practice applies to construction sites where concentrated runoff needs to be contained to prevent erosion or flooding.

- When a vegetative lining can provide sufficient stability for the channel cross section and at lower velocities of water (normally dependent on grade). This means that the channel slopes are generally less than 5 percent and space is available for a relatively large cross section.
- Typical uses include roadside ditches, channels at property boundaries, outlets for diversions, and other channels and drainage ditches in low areas.
- Channels that will be vegetated should be installed before major earthwork and hydroseeded with a bonded fiber matrix (BFM). The vegetation should be well established (i.e., 75 percent cover) before water is allowed to flow in the ditch. With channels that will have high flows, erosion control blankets should be installed over the hydroseed. If vegetation cannot be established from seed before water is allowed in the ditch, sod should be installed in the bottom of the ditch in lieu of hydromulch and blankets.

Design and Installation Specifications

Locate the channel where it can conform to the topography and other features such as roads.

- Locate them to use natural drainage systems to the greatest extent possible.
- Avoid sharp changes in alignment or bends and changes in grade.
- Do not reshape the landscape to fit the drainage channel.
- The maximum design velocity shall be based on soil conditions, type of vegetation, and method of revegetation, but at no times shall velocity exceed 5 feet/second. The channel shall not be overtopped by the peak runoff from a 10-year, 24-hour storm, assuming a Type 1A rainfall distribution." Alternatively, use 1.6 times the 10-year, 1-hour flow indicated by an approved continuous runoff model to determine a flow rate which the channel must contain.
- Where the grass-lined channel will also function as a permanent stormwater conveyance facility, consult the drainage conveyance requirements of the local government with jurisdiction.

- An established grass or vegetated lining is required before the channel can be used to convey stormwater, unless stabilized with nets or blankets.
- If design velocity of a channel to be vegetated by seeding exceeds 2 ft/sec, a temporary channel liner is required. Geotextile or special mulch protection such as fiberglass roving or straw and netting provides stability until the vegetation is fully established. See [Figure 4.2.2](#).
- Check dams shall be removed when the grass has matured sufficiently to protect the ditch or swale unless the slope of the swale is greater than 4 percent. The area beneath the check dams shall be seeded and mulched immediately after dam removal.
- If vegetation is established by sodding, the permissible velocity for established vegetation may be used and no temporary liner is needed.
- Do not subject grass-lined channel to sedimentation from disturbed areas. Use sediment-trapping BMPs upstream of the channel.
- V-shaped grass channels generally apply where the quantity of water is small, such as in short reaches along roadsides. The V-shaped cross section is least desirable because it is difficult to stabilize the bottom where velocities may be high.
- Trapezoidal grass channels are used where runoff volumes are large and slope is low so that velocities are nonerosive to vegetated linings. (Note: it is difficult to construct small parabolic shaped channels.)
- Subsurface drainage, or riprap channel bottoms, may be necessary on sites that are subject to prolonged wet conditions due to long duration flows or a high water table.
- Provide outlet protection at culvert ends and at channel intersections.
- Grass channels, at a minimum, should carry peak runoff for temporary construction drainage facilities from the 10-year, 24-hour storm without eroding. Where flood hazard exists, increase the capacity according to the potential damage.
- Grassed channel side slopes generally are constructed 3H:1V or flatter to aid in the establishment of vegetation and for maintenance.
- Construct channels a minimum of 0.2 foot larger around the periphery to allow for soil bulking during seedbed preparations and sod buildup.

Maintenance Standards

During the establishment period, check grass-lined channels after every rainfall.

- After grass is established, periodically check the channel; check it after every heavy rainfall event. Immediately make repairs.
- It is particularly important to check the channel outlet and all road crossings for bank stability and evidence of piping or scour holes.

- Remove all significant sediment accumulations to maintain the designed carrying capacity. Keep the grass in a healthy, vigorous condition at all times, since it is the primary erosion protection for the channel.

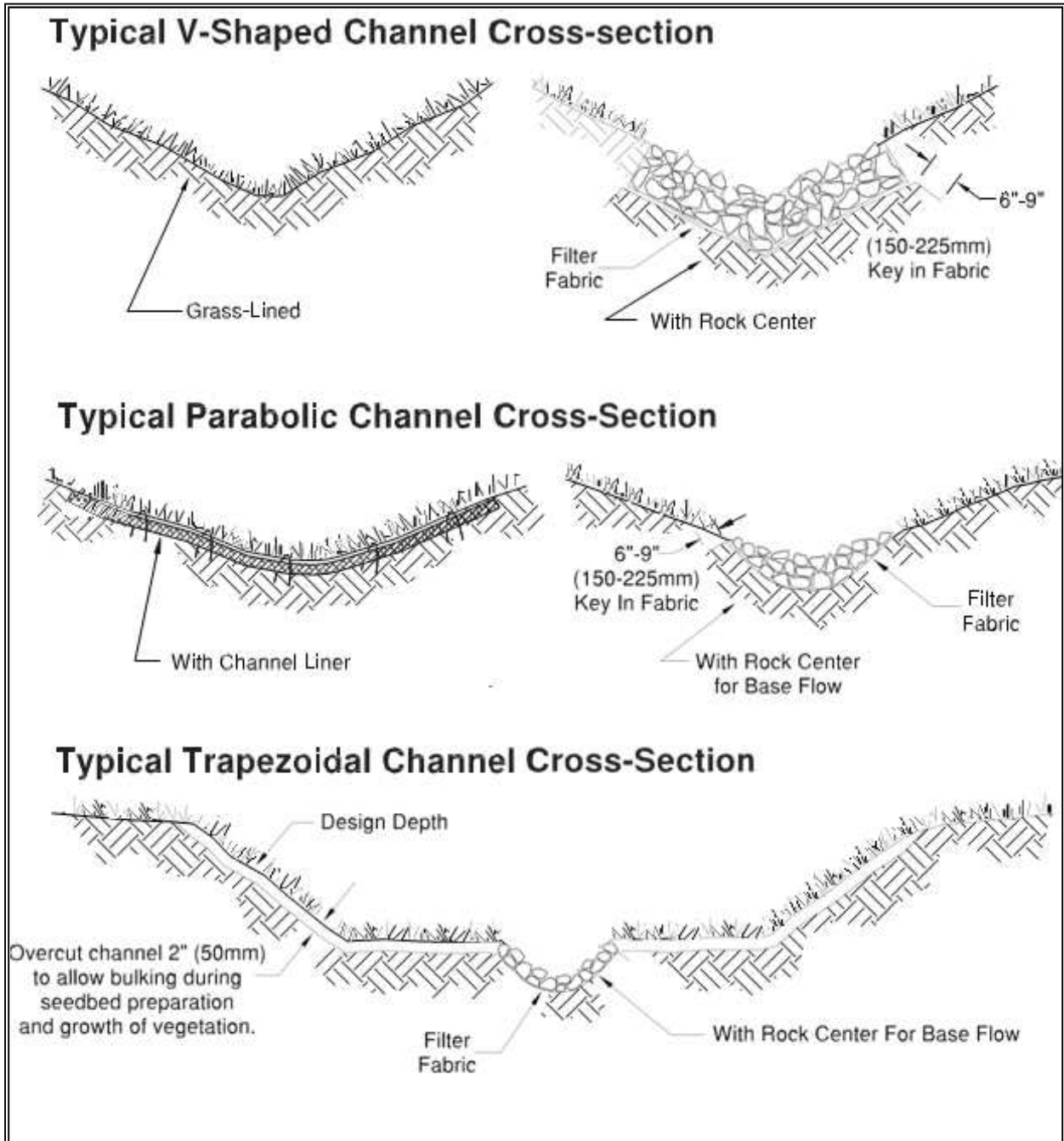
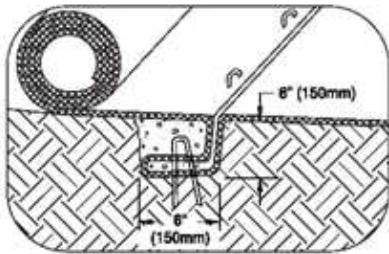
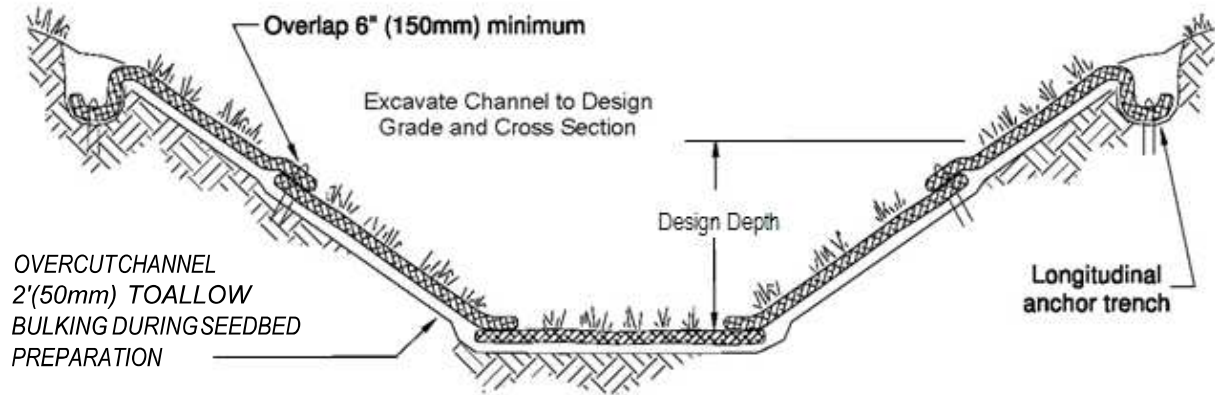
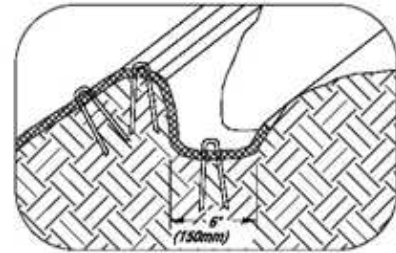

Figure 4.2.1 – Typical Grass-Lined Channels



Intermittent Check Slot

TYPICAL INSTALLATION WITH EROSION CONTROL BLANKETS OR TURF REINFORCEMENT MATS



Longitudinal Anchor Trench

Shingle-lap spliced ends or begin new roll in an intermittent check slot

Prepare soil and apply seed before installing blankets, mats or other temporary channel liner system

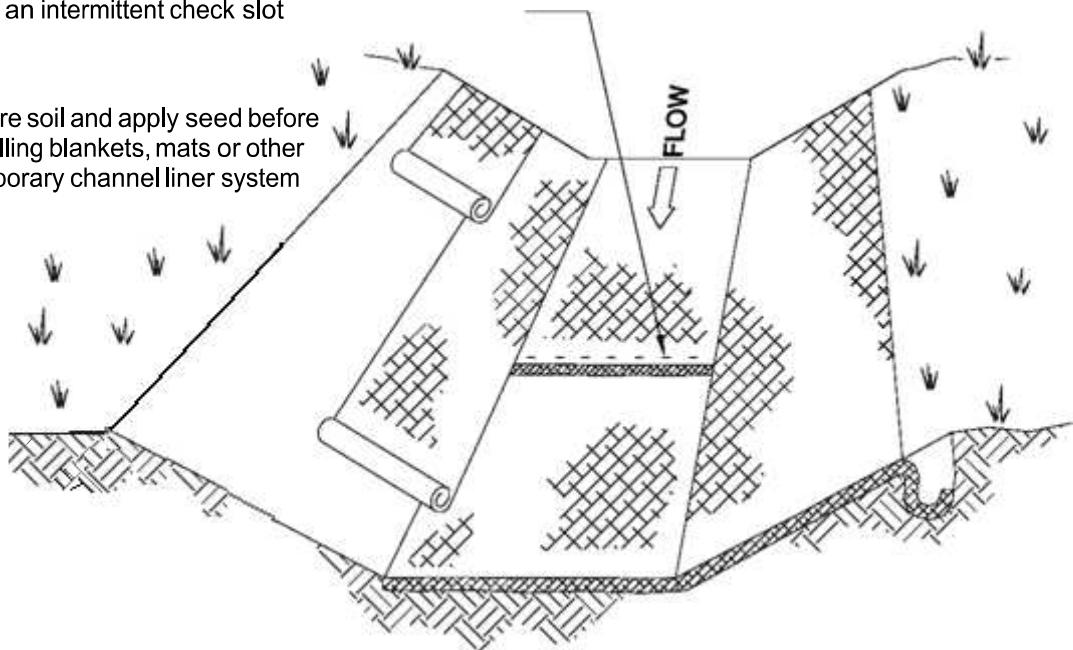

NOTES:

- 1 Design velocities exceeding 2 ft/sec (0.5m/sec) require temporary blankets, mats or similar liners to protect seed and soil until vegetation becomes established.
- 2 Grass-lined channels with design velocities exceeding 6 ft/sec (2m/sec) should include turf reinforcement mats.

Figure 4.2.2 – Temporary Channel Liners

BMP C202: Channel Lining

Purpose

To protect channels by providing a channel liner using either blankets or riprap.

Conditions of Use

When natural soils or vegetated stabilized soils in a channel are not adequate to prevent channel erosion.

- When a permanent ditch or pipe system is to be installed and a temporary measure is needed.
- In almost all cases, synthetic and organic coconut blankets are more effective than riprap for protecting channels from erosion. Blankets can be used with and without vegetation. Blanketed channels can be designed to handle any expected flow and longevity requirement. Some synthetic blankets have a predicted life span of 50 years or more, even in sunlight.
- Other reasons why blankets are better than rock include the availability of blankets over rock. In many areas of the state, rock is not easily obtainable or is very expensive to haul to a site. Blankets can be delivered anywhere. Rock requires the use of dump trucks to haul and heavy equipment to place. Blankets usually only require laborers with hand tools, and sometimes a backhoe.
- The Federal Highway Administration recommends not using flexible liners whenever the slope exceeds 10 percent or the shear stress exceeds 8 lbs/ft².

Design and Installation Specifications

See [BMP C122](#) for information on blankets.

Since riprap is used where erosion potential is high, construction must be sequenced so that the riprap is put in place with the minimum possible delay.

- Disturbance of areas where riprap is to be placed should be undertaken only when final preparation and placement of the riprap can follow immediately behind the initial disturbance. Where riprap is used for outlet protection, the riprap should be placed before or in conjunction with the construction of the pipe or channel so that it is in place when the pipe or channel begins to operate.
- The designer, after determining the riprap size that will be stable under the flow conditions, shall consider that size to be a minimum size and then, based on riprap gradations actually available in the area, select the size or sizes that equal or exceed the minimum size. The possibility of drainage structure damage by children shall be considered in selecting a riprap size, especially if there is nearby water or a gully in which to toss the stones.
- Stone for riprap shall consist of field stone or quarry stone of approximately rectangular shape. The stone shall be hard and angular

and of such quality that it will not disintegrate on exposure to water or weathering and it shall be suitable in all respects for the purpose intended.

- A lining of engineering filter fabric (geotextile) shall be placed between the riprap and the underlying soil surface to prevent soil movement into or through the riprap. The geotextile should be keyed in at the top of the bank.
- Filter fabric shall not be used on slopes greater than 1-1/2H:1V as slippage may occur. It should be used in conjunction with a layer of coarse aggregate (granular filter blanket) when the riprap to be placed is 12 inches and larger.

BMP C203: Water Bars

Purpose

A small ditch or ridge of material is constructed diagonally across a road or right-of-way to divert stormwater runoff from the road surface, wheel tracks, or a shallow road ditch. See [Figure 4.2.3](#).

Conditions of use

Clearing right-of-way and construction of access for power lines, pipelines, and other similar installations often require long narrow right-of-ways over sloping terrain. Disturbance and compaction promotes gully formation in these cleared strips by increasing the volume and velocity of runoff. Gully formation may be especially severe in tire tracks and ruts. To prevent gulying, runoff can often be diverted across the width of the right-of-way to undisturbed areas by using small predesigned diversions.

- Give special consideration to each individual outlet area, as well as to the cumulative effect of added diversions. Use gravel to stabilize the diversion where significant vehicular traffic is anticipated.

Design and Installation Specifications

Height: 8-inch minimum measured from the channel bottom to the ridge top.

- Side slope of channel: 2H:1V maximum; 3H:1V or flatter when vehicles will cross.
- Base width of ridge: 6-inch minimum.
- Locate them to use natural drainage systems and to discharge into well vegetated stable areas.
- Guideline for Spacing:

Slope %	Spacing (ft)
< 5	125
5 - 10	100
10 - 20	75
20 - 35	50
> 35	Use rock lined ditch

BMP C204: Pipe Slope Drains

Purpose To use a pipe to convey stormwater anytime water needs to be diverted away from or over bare soil to prevent gullies, channel erosion, and saturation of slide-prone soils.

Conditions of Use Pipe slope drains should be used when a temporary or permanent stormwater conveyance is needed to move the water down a steep slope to avoid erosion ([Figure 4.2.4](#)).

On highway projects, pipe slope drains should be used at bridge ends to collect runoff and pipe it to the base of the fill slopes along bridge approaches. These can be designed into a project and included as bid items. Another use on road projects is to collect runoff from pavement and pipe it away from side slopes. These are useful because there is generally a time lag between having the first lift of asphalt installed and the curbs, gutters, and permanent drainage installed. Used in conjunction with sand bags, or other temporary diversion devices, these will prevent massive amounts of sediment from leaving a project.

Water can be collected, channeled with sand bags, Triangular Silt Dikes, berms, or other material, and piped to temporary sediment ponds.

Pipe slope drains can be:

- Connected to new catch basins and used temporarily until all permanent piping is installed;
- Used to drain water collected from aquifers exposed on cut slopes and take it to the base of the slope;
- Used to collect clean runoff from plastic sheeting and direct it away from exposed soil;
- Installed in conjunction with silt fence to drain collected water to a controlled area;
- Used to divert small seasonal streams away from construction. They have been used successfully on culvert replacement and extension jobs. Large flex pipe can be used on larger streams during culvert removal, repair, or replacement; and,
- Connected to existing down spouts and roof drains and used to divert water away from work areas during building renovation, demolition, and construction projects.

There are now several commercially available collectors that are attached to the pipe inlet and help prevent erosion at the inlet.

***Design and
Installation
Specifications***

Size the pipe to convey the flow. The capacity for temporary drains shall be sufficient to handle the peak flow from a 10-year, 24-hour storm event, assuming a Type 1A rainfall distribution. Alternatively, use 1.6 times the 10-year, 1-hour flow indicated by an approved continuous runoff model.

Consult local drainage requirements for sizing permanent pipe slope drains.

- Use care in clearing vegetated slopes for installation.
- Re-establish cover immediately on areas disturbed by installation.
- Use temporary drains on new cut or fill slopes.
- Use diversion dikes or swales to collect water at the top of the slope.
- Ensure that the entrance area is stable and large enough to direct flow into the pipe.
- Piping of water through the berm at the entrance area is a common failure mode.
- The entrance shall consist of a standard flared end section for culverts 12 inches and larger with a minimum 6-inch metal toe plate to prevent runoff from undercutting the pipe inlet. The slope of the entrance shall be at least 3 percent. Sand bags may also be used at pipe entrances as a temporary measure.
- The soil around and under the pipe and entrance section shall be thoroughly compacted to prevent undercutting.
- The flared inlet section shall be securely connected to the slope drain and have watertight connecting bands.
- Slope drain sections shall be securely fastened together, fused or have gasketed watertight fittings, and shall be securely anchored into the soil.
- Thrust blocks should be installed anytime 90 degree bends are utilized. Depending on size of pipe and flow, these can be constructed with sand bags, straw bales staked in place, “t” posts and wire, or ecology blocks.
- Pipe needs to be secured along its full length to prevent movement. This can be done with steel “t” posts and wire. A post is installed on each side of the pipe and the pipe is wired to them. This should be done every 10-20 feet of pipe length or so, depending on the size of the pipe and quantity of water to divert.
- Interceptor dikes shall be used to direct runoff into a slope drain. The height of the dike shall be at least 1 foot higher at all points than the top of the inlet pipe.
- The area below the outlet must be stabilized with a riprap apron (see [BMP C209](#) Outlet Protection, for the appropriate outlet material).

- If the pipe slope drain is conveying sediment-laden water, direct all flows into the sediment trapping facility.
- Materials specifications for any permanent piped system shall be set by the local government.

Maintenance Standards

Check inlet and outlet points regularly, especially after storms.

The inlet should be free of undercutting, and no water should be going around the point of entry. If there are problems, the headwall should be reinforced with compacted earth or sand bags.

- The outlet point should be free of erosion and installed with appropriate outlet protection.
- For permanent installations, inspect pipe periodically for vandalism and physical distress such as slides and wind-throw.
- Normally the pipe slope is so steep that clogging is not a problem with smooth wall pipe, however, debris may become lodged in the pipe.

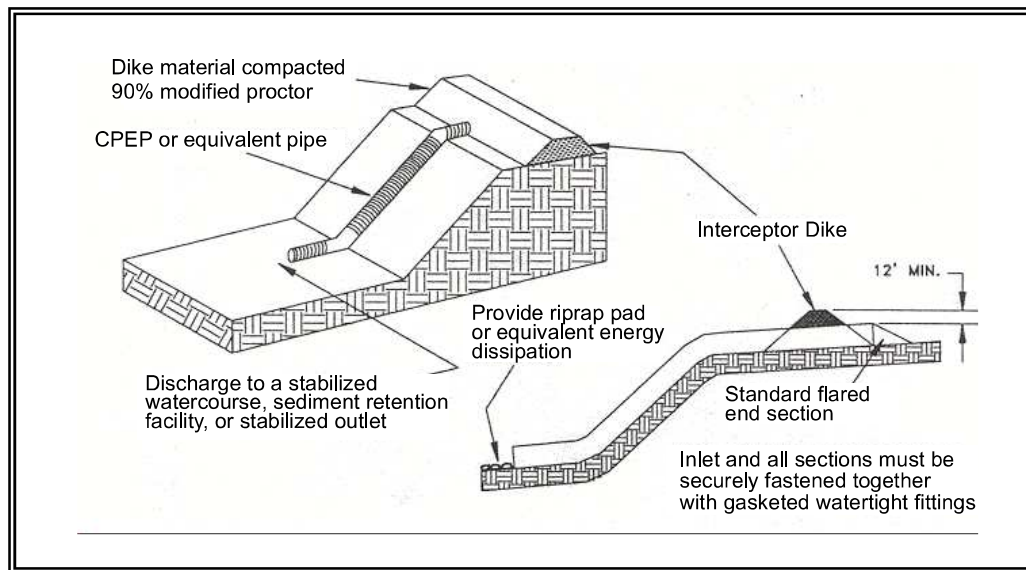
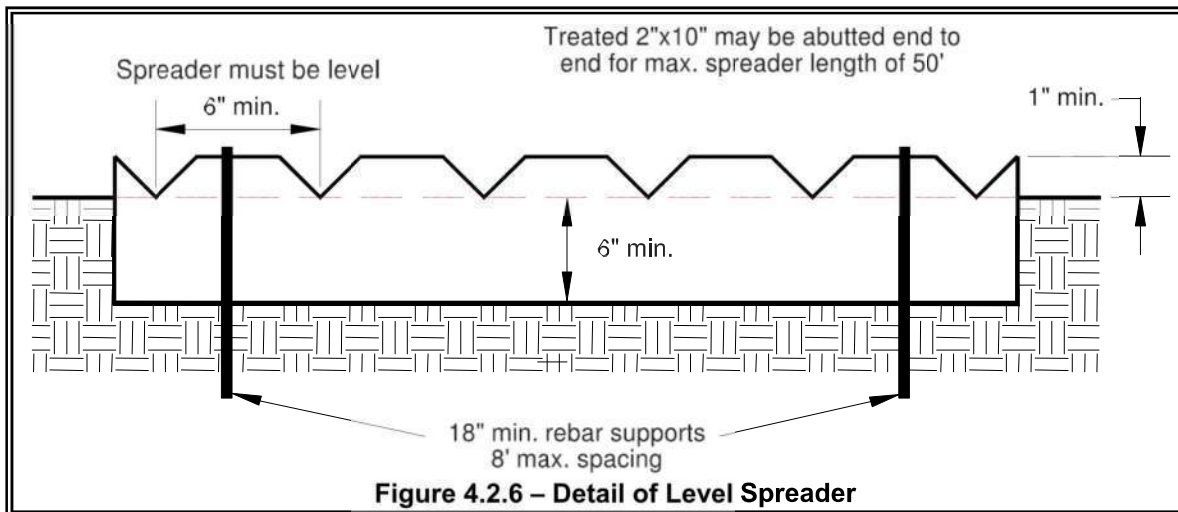

Figure 4.2.4 – Pipe Slope Drain



BMP C207: Check Dams

Purpose

Construction of small dams across a swale or ditch reduces the velocity of concentrated flow and dissipates energy at the check dam.

Conditions of Use

Where temporary channels or permanent channels are not yet vegetated, channel lining is infeasible, and/or velocity checks are required.

- Check dams may not be placed in streams unless approved by the State Department of Fish and Wildlife. Check dams may not be placed in wetlands without approval from a permitting agency.
- Do not place check dams below the expected backwater from any salmonid bearing water between October 1 and May 31 to ensure that there is no loss of high flow refuge habitat for overwintering juvenile salmonids and emergent salmonid fry.
- Construct rock check dams from appropriately sized rock. The rock used must be large enough to stay in place given the expected design flow through the channel. The rock must be placed by hand or by mechanical means (no dumping of rock to form dam) to achieve complete coverage of the ditch or swale and to ensure that the center of the dam is lower than the edges.
- Check dams may also be constructed of either rock or pea-gravel filled bags. Numerous new products are also available for this purpose. They tend to be re-usable, quick and easy to install, effective, and cost efficient.
- Place check dams perpendicular to the flow of water.
- The dam should form a triangle when viewed from the side. This prevents undercutting as water flows over the face of the dam rather than falling directly onto the ditch bottom.

- Before installing check dams impound and bypass upstream water flow away from the work area. Options for bypassing include pumps, siphons, or temporary channels.
- Check dams in association with sumps work more effectively at slowing flow and retaining sediment than just a check dam alone. A deep sump should be provided immediately upstream of the check dam.
- In some cases, if carefully located and designed, check dams can remain as permanent installations with very minor regrading. They may be left as either spillways, in which case accumulated sediment would be graded and seeded, or as check dams to prevent further sediment from leaving the site.
- The maximum spacing between the dams shall be such that the toe of the upstream dam is at the same elevation as the top of the downstream dam.
- Keep the maximum height at 2 feet at the center of the dam.
- Keep the center of the check dam at least 12 inches lower than the outer edges at natural ground elevation.
- Keep the side slopes of the check dam at 2H:1V or flatter.
- Key the stone into the ditch banks and extend it beyond the abutments a minimum of 18 inches to avoid washouts from overflow around the dam.
- Use filter fabric foundation under a rock or sand bag check dam. If a blanket ditch liner is used, filter fabric is not necessary. A piece of organic or synthetic blanket cut to fit will also work for this purpose.
- In the case of grass-lined ditches and swales, all check dams and accumulated sediment shall be removed when the grass has matured sufficiently to protect the ditch or swale - unless the slope of the swale is greater than 4 percent. The area beneath the check dams shall be seeded and mulched immediately after dam removal.
- Ensure that channel appurtenances, such as culvert entrances below check dams, are not subject to damage or blockage from displaced stones. [Figure 4.2.7](#) depicts a typical rock check dam.

Maintenance Standards

Check dams shall be monitored for performance and sediment accumulation during and after each runoff producing rainfall. Sediment shall be removed when it reaches one half the sump depth.

- Anticipate submergence and deposition above the check dam and erosion from high flows around the edges of the dam.
- If significant erosion occurs between dams, install a protective riprap liner in that portion of the channel.

***Approved as
Equivalent***

Ecology has approved products as able to meet the requirements of [BMP C207](#). The products did not pass through the Technology Assessment Protocol – Ecology (TAPE) process. Local jurisdictions may choose not to accept this product approved as equivalent, or may require additional testing prior to consideration for local use. The products are available for review on Ecology’s website at <http://www.ecy.wa.gov/programs/wq/stormwater/newtech/equivalent.html>

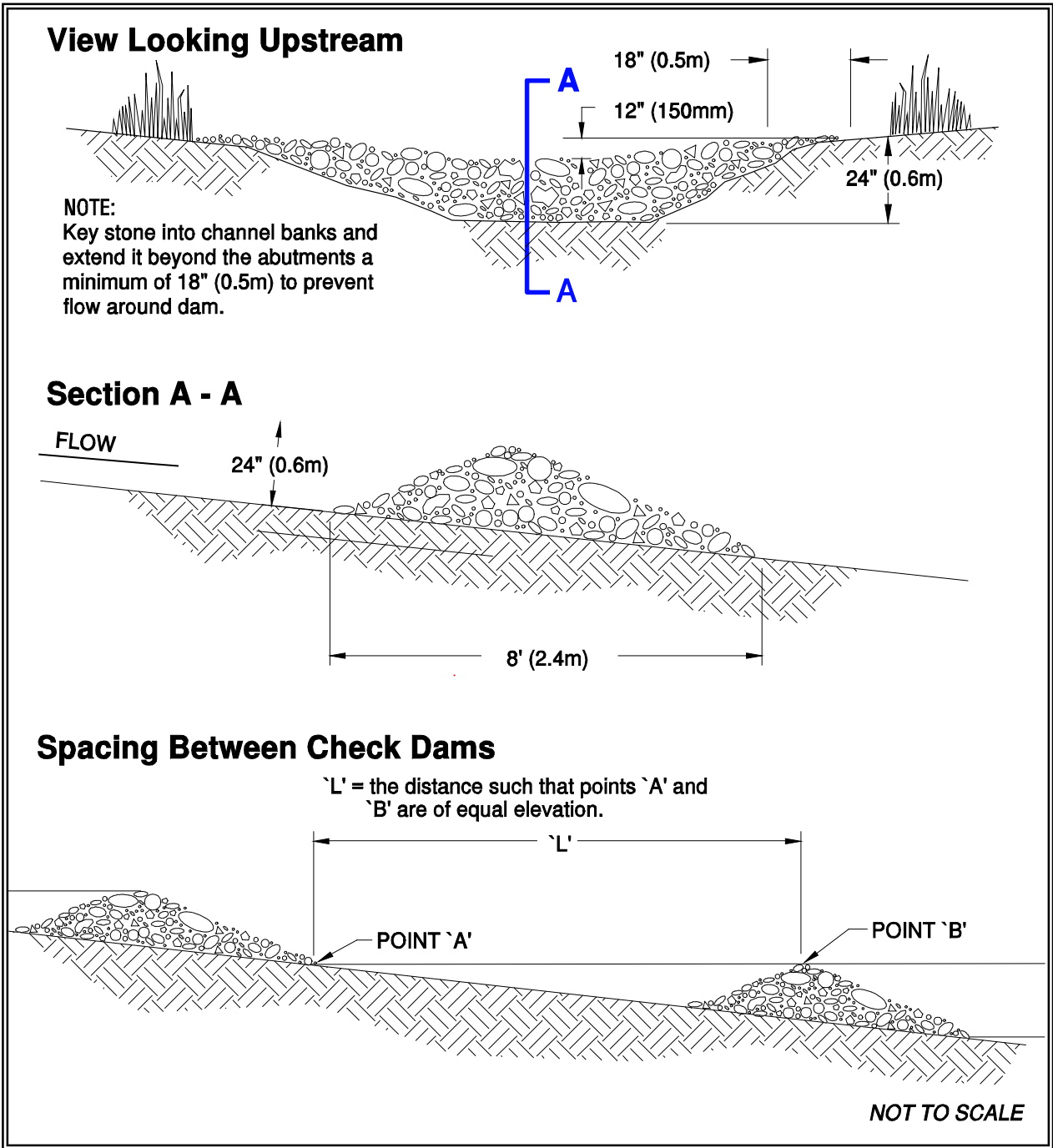

Figure 4.2.7 – Rock Check Dam

Standards

accumulation during and after each runoff producing rainfall. Sediment shall be removed when it reaches one half the height of the dam.

- Anticipate submergence and deposition above the triangular silt dam and erosion from high flows around the edges of the dam. Immediately repair any damage or any undercutting of the dam.

BMP C209: Outlet Protection

Purpose

Outlet protection prevents scour at conveyance outlets and minimizes the potential for downstream erosion by reducing the velocity of concentrated stormwater flows.

Conditions of use

Outlet protection is required at the outlets of all ponds, pipes, ditches, or other conveyances, and where runoff is conveyed to a natural or manmade drainage feature such as a stream, wetland, lake, or ditch.

Design and Installation Specifications

The receiving channel at the outlet of a culvert shall be protected from erosion by rock lining a minimum of 6 feet downstream and extending up the channel sides a minimum of 1-foot above the maximum tailwater elevation or 1-foot above the crown, whichever is higher. For large pipes (more than 18 inches in diameter), the outlet protection lining of the channel is lengthened to four times the diameter of the culvert.

- Standard wingwalls, and tapered outlets and paved channels should also be considered when appropriate for permanent culvert outlet protection. (See WSDOT Hydraulic Manual, available through WSDOT Engineering Publications).
- Organic or synthetic erosion blankets, with or without vegetation, are usually more effective than rock, cheaper, and easier to install. Materials can be chosen using manufacturer product specifications. ASTM test results are available for most products and the designer can choose the correct material for the expected flow.
- With low flows, vegetation (including sod) can be effective.
- The following guidelines shall be used for riprap outlet protection:
 1. If the discharge velocity at the outlet is less than 5 fps (pipe slope less than 1 percent), use 2-inch to 8-inch riprap. Minimum thickness is 1-foot.
 2. For 5 to 10 fps discharge velocity at the outlet (pipe slope less than 3 percent), use 24-inch to 48-inch riprap. Minimum thickness is 2 feet.
 3. For outlets at the base of steep slope pipes (pipe slope greater than 10 percent), an engineered energy dissipater shall be used.
- Filter fabric or erosion control blankets should always be used under riprap to prevent scour and channel erosion.

- New pipe outfalls can provide an opportunity for low-cost fish habitat improvements. For example, an alcove of low-velocity water can be created by constructing the pipe outfall and associated energy dissipater back from the stream edge and digging a channel, over-widened to the upstream side, from the outfall. Overwintering juvenile and migrating adult salmonids may use the alcove as shelter during high flows. Bank stabilization, bioengineering, and habitat features may be required for disturbed areas. This work may require a HPA. See Volume V for more information on outfall system design.

Maintenance Standards

- Inspect and repair as needed.
- Add rock as needed to maintain the intended function.
- Clean energy dissipater if sediment builds up.

BMP C220: Storm Drain Inlet Protection

Purpose

Storm drain inlet protection prevents coarse sediment from entering drainage systems prior to permanent stabilization of the disturbed area.

Conditions of Use

Use storm drain inlet protection at inlets that are operational before permanent stabilization of the disturbed drainage area. Provide protection for all storm drain inlets downslope and within 500 feet of a disturbed or construction area, unless conveying runoff entering catch basins to a sediment pond or trap.

Also consider inlet protection for lawn and yard drains on new home construction. These small and numerous drains coupled with lack of gutters in new home construction can add significant amounts of sediment into the roof drain system. If possible delay installing lawn and yard drains until just before landscaping or cap these drains to prevent sediment from entering the system until completion of landscaping. Provide 18-inches of sod around each finished lawn and yard drain.

[Table 4.2.2](#) lists several options for inlet protection. All of the methods for storm drain inlet protection tend to plug and require a high frequency of maintenance. Limit drainage areas to one acre or less. Possibly provide emergency overflows with additional end-of-pipe treatment where stormwater ponding would cause a hazard.

**Table 4.2.2
Storm Drain Inlet Protection**

Type of Inlet Protection	Emergency Overflow	Applicable for Paved/ Earthen Surfaces	Conditions of Use
Drop Inlet Protection			
Excavated drop inlet protection	Yes, temporary flooding will occur	Earthen	Applicable for heavy flows. Easy to maintain. Large area Requirement: 30' X 30'/acre
Block and gravel drop inlet protection	Yes	Paved or Earthen	Applicable for heavy concentrated flows. Will not pond.
Gravel and wire drop inlet protection	No		Applicable for heavy concentrated flows. Will pond. Can withstand traffic.
Catch basin filters	Yes	Paved or Earthen	Frequent maintenance required.
Curb Inlet Protection			
Curb inlet protection with a wooden weir	Small capacity overflow	Paved	Used for sturdy, more compact installation.
Block and gravel curb inlet protection	Yes	Paved	Sturdy, but limited filtration.
Culvert Inlet Protection			
Culvert inlet sediment trap			18 month expected life.

Design and Installation Specifications

Excavated Drop Inlet Protection - An excavated impoundment around the storm drain. Sediment settles out of the stormwater prior to entering the storm drain.

- Provide a depth of 1-2 ft as measured from the crest of the inlet structure.
- Slope sides of excavation no steeper than 2H:1V.
- Minimum volume of excavation 35 cubic yards.
- Shape basin to fit site with longest dimension oriented toward the longest inflow area.
- Install provisions for draining to prevent standing water problems.
- Clear the area of all debris.
- Grade the approach to the inlet uniformly.
- Drill weep holes into the side of the inlet.
- Protect weep holes with screen wire and washed aggregate.
- Seal weep holes when removing structure and stabilizing area.

- Build a temporary dike, if necessary, to the down slope side of the structure to prevent bypass flow.

Block and Gravel Filter - A barrier formed around the storm drain inlet with standard concrete blocks and gravel. See [Figure 4.2.8](#).

- Provide a height of 1 to 2 feet above inlet.
- Recess the first row 2-inches into the ground for stability.
- Support subsequent courses by placing a 2x4 through the block opening.
- Do not use mortar.
- Lay some blocks in the bottom row on their side for dewatering the pool.
- Place hardware cloth or comparable wire mesh with ½-inch openings over all block openings.
- Place gravel just below the top of blocks on slopes of 2H:1V or flatter.
- An alternative design is a gravel donut.
- Provide an inlet slope of 3H:1V.
- Provide an outlet slope of 2H:1V.
- Provide a 1-foot wide level stone area between the structure and the inlet.
- Use inlet slope stones 3 inches in diameter or larger.
- Use gravel ½- to ¾-inch at a minimum thickness of 1-foot for the outlet slope.

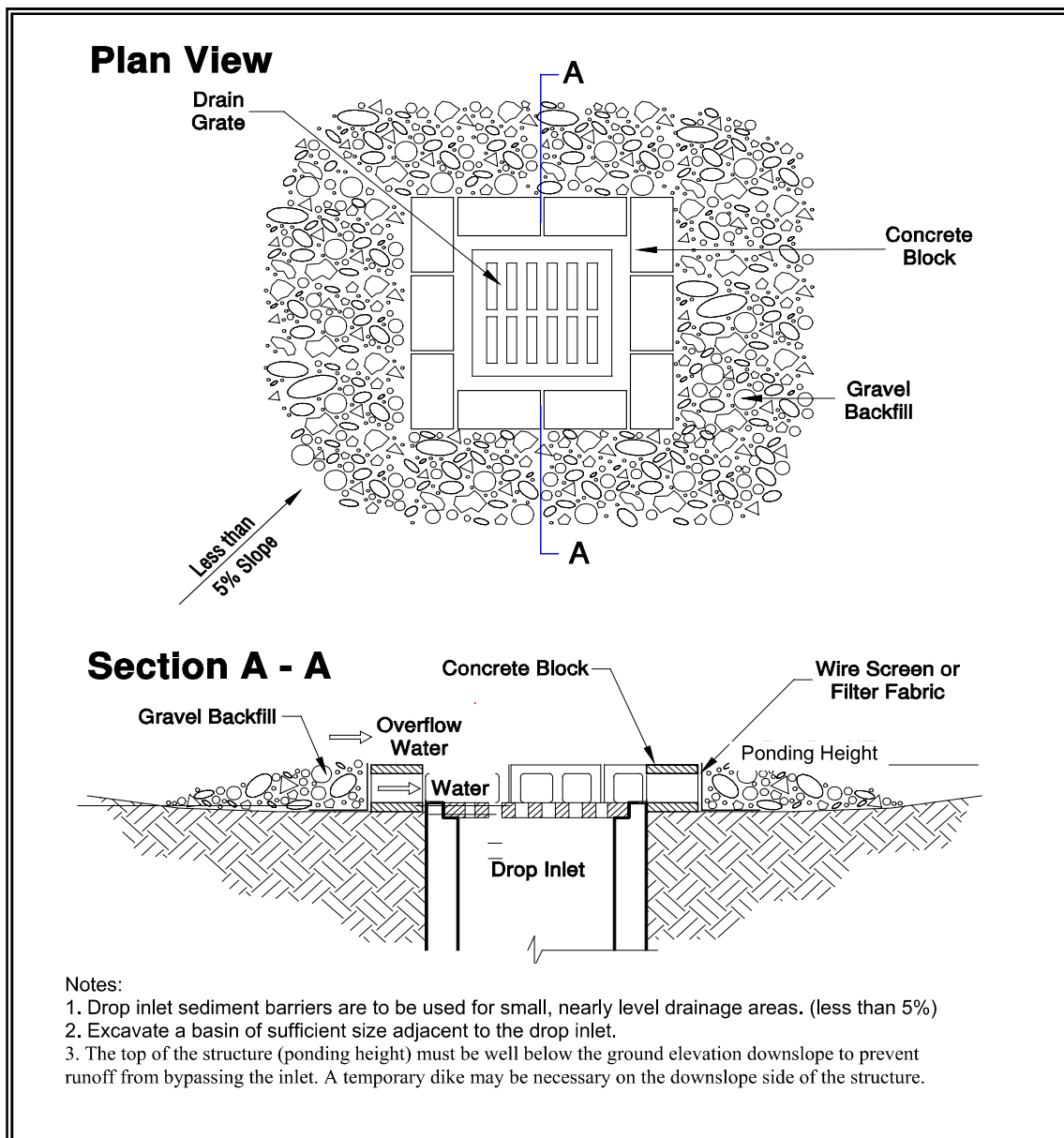

Figure 4.2.8 – Block and Gravel Filter

Gravel and Wire Mesh Filter - A gravel barrier placed over the top of the inlet. This structure does not provide an overflow.

- Use a hardware cloth or comparable wire mesh with ½-inch openings.
- Use coarse aggregate.
- Provide a height 1-foot or more, 18-inches wider than inlet on all sides.
- Place wire mesh over the drop inlet so that the wire extends a minimum of 1-foot beyond each side of the inlet structure.
- Overlap the strips if more than one strip of mesh is necessary.

- Place coarse aggregate over the wire mesh.
- Provide at least a 12-inch depth of gravel over the entire inlet opening and extend at least 18-inches on all sides.

Catchbasin Filters – Use inserts designed by manufacturers for construction sites. The limited sediment storage capacity increases the amount of inspection and maintenance required, which may be daily for heavy sediment loads. To reduce maintenance requirements combine a catchbasin filter with another type of inlet protection. This type of inlet protection provides flow bypass without overflow and therefore may be a better method for inlets located along active rights-of-way.

- Provides 5 cubic feet of storage.
- Requires dewatering provisions.
- Provides a high-flow bypass that will not clog under normal use at a construction site.
- Insert the catchbasin filter in the catchbasin just below the grating.

Curb Inlet Protection with Wooden Weir – Barrier formed around a curb inlet with a wooden frame and gravel.

- Use wire mesh with ½-inch openings.
- Use extra strength filter cloth.
- Construct a frame.
- Attach the wire and filter fabric to the frame.
- Pile coarse washed aggregate against wire/fabric.
- Place weight on frame anchors.

Block and Gravel Curb Inlet Protection – Barrier formed around a curb inlet with concrete blocks and gravel. See [Figure 4.2.9](#).

- Use wire mesh with ½-inch openings.
- Place two concrete blocks on their sides abutting the curb at either side of the inlet opening. These are spacer blocks.
- Place a 2x4 stud through the outer holes of each spacer block to align the front blocks.
- Place blocks on their sides across the front of the inlet and abutting the spacer blocks.
- Place wire mesh over the outside vertical face.
- Pile coarse aggregate against the wire to the top of the barrier.

Curb and Gutter Sediment Barrier – Sandbag or rock berm (riprap and aggregate) 3 feet high and 3 feet wide in a horseshoe shape. See [Figure 4.2.10](#).

***Maintenance
Standards***

- Construct a horseshoe shaped berm, faced with coarse aggregate if using riprap, 3 feet high and 3 feet wide, at least 2 feet from the inlet.
- Construct a horseshoe shaped sedimentation trap on the outside of the berm sized to sediment trap standards for protecting a culvert inlet.
- Inspect catch basin filters frequently, especially after storm events. Clean and replace clogged inserts. For systems with clogged stone filters: pull away the stones from the inlet and clean or replace. An alternative approach would be to use the clogged stone as fill and put fresh stone around the inlet.
- Do not wash sediment into storm drains while cleaning. Spread all excavated material evenly over the surrounding land area or stockpile and stabilize as appropriate.

***Approved as
Equivalent***

Ecology has approved products as able to meet the requirements of [BMP C220](#). The products did not pass through the Technology Assessment Protocol – Ecology (TAPE) process. Local jurisdictions may choose not to accept this product approved as equivalent, or may require additional testing prior to consideration for local use. The products are available for review on Ecology’s website at <http://www.ecy.wa.gov/programs/wq/stormwater/newtech/equivalent.html>

Plan View

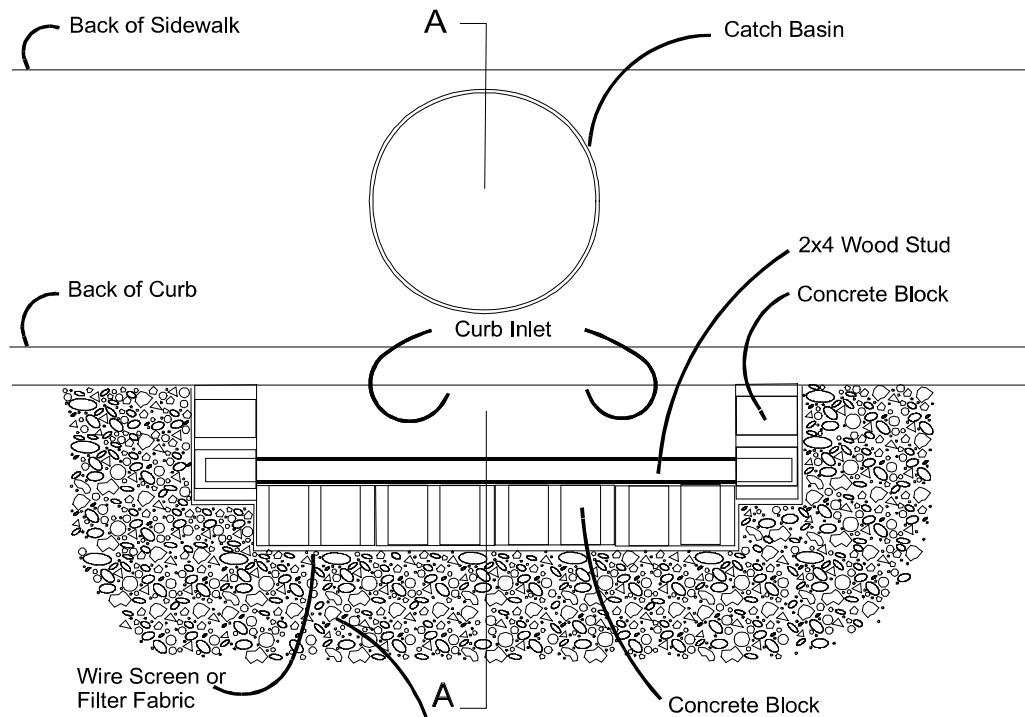

Section A - A

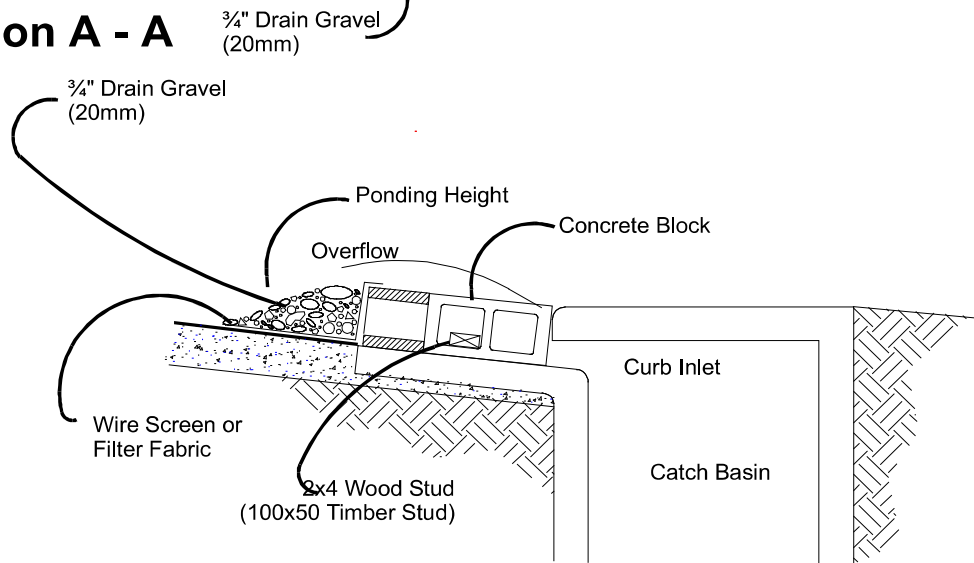

NOTES:

1. Use block and gravel type sediment barrier when curb inlet is located in gently sloping street segment, where water can pond and allow sediment to separate from runoff.
2. Barrier shall allow for overflow from severe storm event.
3. Inspect barriers and remove sediment after each storm event. Sediment and gravel must be removed from the traveled way immediately.

Figure 4.2.9 – Block and Gravel Curb Inlet Protection

Plan View

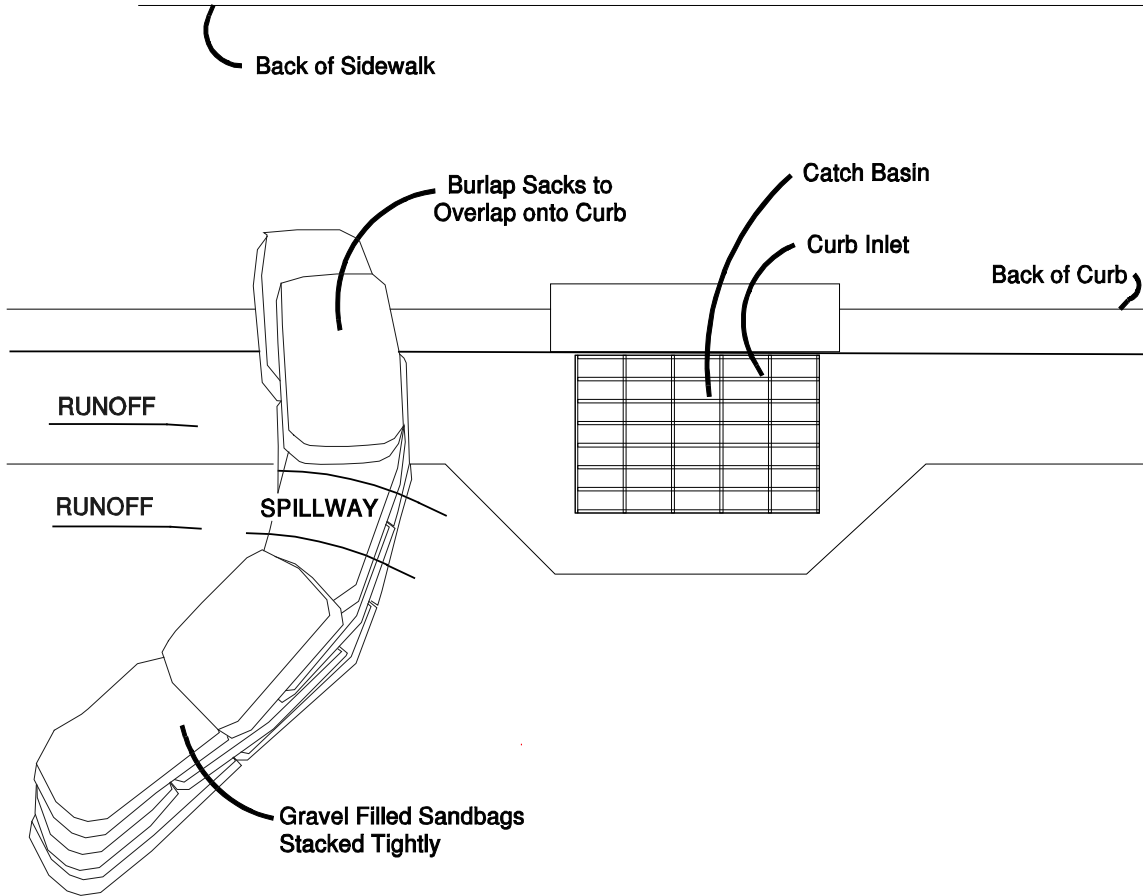

NOTES:

1. Place curb type sediment barriers on gently sloping street segments, where water can pond and allow sediment to separate from runoff.
2. Sandbags of either burlap or woven 'geotextile' fabric, are filled with gravel, layered and packed tightly.
3. Leave a one sandbag gap in the top row to provide a spillway for overflow.
4. Inspect barriers and remove sediment after each storm event. Sediment and gravel must be removed from the traveled way immediately.

Figure 4.2.10 – Curb and Gutter Barrier

BMP C232: Gravel Filter Berm

- Purpose** A gravel filter berm is constructed on rights-of-way or traffic areas within a construction site to retain sediment by using a filter berm of gravel or crushed rock.
- Conditions of Use** Where a temporary measure is needed to retain sediment from rights-of-way or in traffic areas on construction sites.
- Design and Installation Specifications**
- Berm material shall be $\frac{3}{4}$ to 3 inches in size, washed well-grade gravel or crushed rock with less than 5 percent fines.
 - Spacing of berms:
 - Every 300 feet on slopes less than 5 percent
 - Every 200 feet on slopes between 5 percent and 10 percent
 - Every 100 feet on slopes greater than 10 percent
 - Berm dimensions:
 - 1 foot high with 3H:1V side slopes
 - 8 linear feet per 1 cfs runoff based on the 10-year, 24-hour design storm
- Maintenance Standards**
- Regular inspection is required. Sediment shall be removed and filter material replaced as needed.

BMP C233: Silt Fence

- Purpose** Use of a silt fence reduces the transport of coarse sediment from a construction site by providing a temporary physical barrier to sediment and reducing the runoff velocities of overland flow. See [Figure 4.2.12](#) for details on silt fence construction.
- Conditions of Use** Silt fence may be used downslope of all disturbed areas.
- Silt fence shall prevent soil carried by runoff water from going beneath, through, or over the top of the silt fence, but shall allow the water to pass through the fence.
 - Silt fence is not intended to treat concentrated flows, nor is it intended to treat substantial amounts of overland flow. Convey any concentrated flows through the drainage system to a sediment pond.
 - Do not construct silt fences in streams or use in V-shaped ditches. Silt fences do not provide an adequate method of silt control for anything deeper than sheet or overland flow.

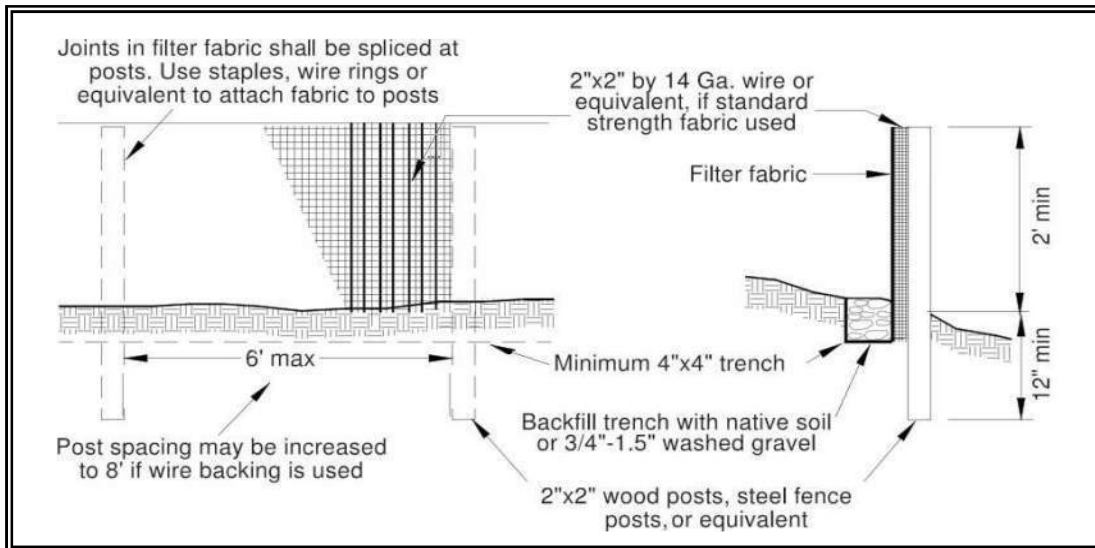

Figure 4.2.12 – Silt Fence

Design and Installation Specifications

- Use in combination with sediment basins or other BMPs.
- Maximum slope steepness (normal (perpendicular) to fence line) 1H:1V.
- Maximum sheet or overland flow path length to the fence of 100 feet.
- Do not allow flows greater than 0.5 cfs.
- The geotextile used shall meet the following standards. All geotextile properties listed below are minimum average roll values (i.e., the test result for any sampled roll in a lot shall meet or exceed the values shown in [Table 4.2.3](#)):

Table 4.2.3 Geotextile Standards	
Polymeric Mesh AOS (ASTM D4751)	0.60 mm maximum for slit film woven (#30 sieve). 0.30 mm maximum for all other geotextile types (#50 sieve). 0.15 mm minimum for all fabric types (#100 sieve).
Water Permittivity (ASTM D4491)	0.02 sec ⁻¹ minimum
Grab Tensile Strength (ASTM D4632)	180 lbs. Minimum for extra strength fabric. 100 lbs minimum for standard strength fabric.
Grab Tensile Strength (ASTM D4632)	30% maximum
Ultraviolet Resistance (ASTM D4355)	70% minimum

- Support standard strength fabrics with wire mesh, chicken wire, 2-inch x 2-inch wire, safety fence, or jute mesh to increase the strength of the

fabric. Silt fence materials are available that have synthetic mesh backing attached.

- Filter fabric material shall contain ultraviolet ray inhibitors and stabilizers to provide a minimum of six months of expected usable construction life at a temperature range of 0°F. to 120°F.
- One-hundred percent biodegradable silt fence is available that is strong, long lasting, and can be left in place after the project is completed, if permitted by local regulations.
- Refer to [Figure 4.2.12](#) for standard silt fence details. Include the following standard Notes for silt fence on construction plans and specifications:
 1. The contractor shall install and maintain temporary silt fences at the locations shown in the Plans.
 2. Construct silt fences in areas of clearing, grading, or drainage prior to starting those activities.
 3. The silt fence shall have a 2-foot min. and a 2½-foot max. height above the original ground surface.
 4. The filter fabric shall be sewn together at the point of manufacture to form filter fabric lengths as required. Locate all sewn seams at support posts. Alternatively, two sections of silt fence can be overlapped, provided the Contractor can demonstrate, to the satisfaction of the Engineer, that the overlap is long enough and that the adjacent fence sections are close enough together to prevent silt laden water from escaping through the fence at the overlap.
 5. Attach the filter fabric on the up-slope side of the posts and secure with staples, wire, or in accordance with the manufacturer's recommendations. Attach the filter fabric to the posts in a manner that reduces the potential for tearing.
 6. Support the filter fabric with wire or plastic mesh, dependent on the properties of the geotextile selected for use. If wire or plastic mesh is used, fasten the mesh securely to the up-slope side of the posts with the filter fabric up-slope of the mesh.
 7. Mesh support, if used, shall consist of steel wire with a maximum mesh spacing of 2-inches, or a prefabricated polymeric mesh. The strength of the wire or polymeric mesh shall be equivalent to or greater than 180 lbs. grab tensile strength. The polymeric mesh must be as resistant to the same level of ultraviolet radiation as the filter fabric it supports.
 8. Bury the bottom of the filter fabric 4-inches min. below the ground surface. Backfill and tamp soil in place over the buried portion of the filter fabric, so that no flow can pass beneath the fence and

scouring cannot occur. When wire or polymeric back-up support mesh is used, the wire or polymeric mesh shall extend into the ground 3-inches min.

9. Drive or place the fence posts into the ground 18-inches min. A 12-inch min. depth is allowed if topsoil or other soft subgrade soil is not present and 18-inches cannot be reached. Increase fence post min. depths by 6 inches if the fence is located on slopes of 3H:1V or steeper and the slope is perpendicular to the fence. If required post depths cannot be obtained, the posts shall be adequately secured by bracing or guying to prevent overturning of the fence due to sediment loading.
 10. Use wood, steel or equivalent posts. The spacing of the support posts shall be a maximum of 6-feet. Posts shall consist of either:
 - Wood with dimensions of 2-inches by 2-inches wide min. and a 3-feet min. length. Wood posts shall be free of defects such as knots, splits, or gouges.
 - No. 6 steel rebar or larger.
 - ASTM A 120 steel pipe with a minimum diameter of 1-inch.
 - U, T, L, or C shape steel posts with a minimum weight of 1.35 lbs./ft.
 - Other steel posts having equivalent strength and bending resistance to the post sizes listed above.
 11. Locate silt fences on contour as much as possible, except at the ends of the fence, where the fence shall be turned uphill such that the silt fence captures the runoff water and prevents water from flowing around the end of the fence.
 12. If the fence must cross contours, with the exception of the ends of the fence, place gravel check dams perpendicular to the back of the fence to minimize concentrated flow and erosion. The slope of the fence line where contours must be crossed shall not be steeper than 3H:1V.
 - Gravel check dams shall be approximately 1-foot deep at the back of the fence. Gravel check dams shall be continued perpendicular to the fence at the same elevation until the top of the check dam intercepts the ground surface behind the fence.
 - Gravel check dams shall consist of crushed surfacing base course, gravel backfill for walls, or shoulder ballast. Gravel check dams shall be located every 10 feet along the fence where the fence must cross contours.
- Refer to [Figure 4.2.13](#) for slicing method details. Silt fence installation using the slicing method specifications:

1. The base of both end posts must be at least 2- to 4-inches above the top of the filter fabric on the middle posts for ditch checks to drain properly. Use a hand level or string level, if necessary, to mark base points before installation.
2. Install posts 3- to 4-feet apart in critical retention areas and 6- to 7-feet apart in standard applications.
3. Install posts 24-inches deep on the downstream side of the silt fence, and as close as possible to the filter fabric, enabling posts to support the filter fabric from upstream water pressure.
4. Install posts with the nipples facing away from the filter fabric.
5. Attach the filter fabric to each post with three ties, all spaced within the top 8-inches of the filter fabric. Attach each tie diagonally 45 degrees through the filter fabric, with each puncture at least 1-inch vertically apart. Each tie should be positioned to hang on a post nipple when tightening to prevent sagging.
6. Wrap approximately 6-inches of fabric around the end posts and secure with 3 ties.
7. No more than 24-inches of a 36-inch filter fabric is allowed above ground level.

Compact the soil immediately next to the filter fabric with the front wheel of the tractor, skid steer, or roller exerting at least 60 pounds per square inch. Compact the upstream side first and then each side twice for a total of four trips. Check and correct the silt fence installation for any deviation before compaction. Use a flat-bladed shovel to tuck fabric deeper into the ground if necessary.

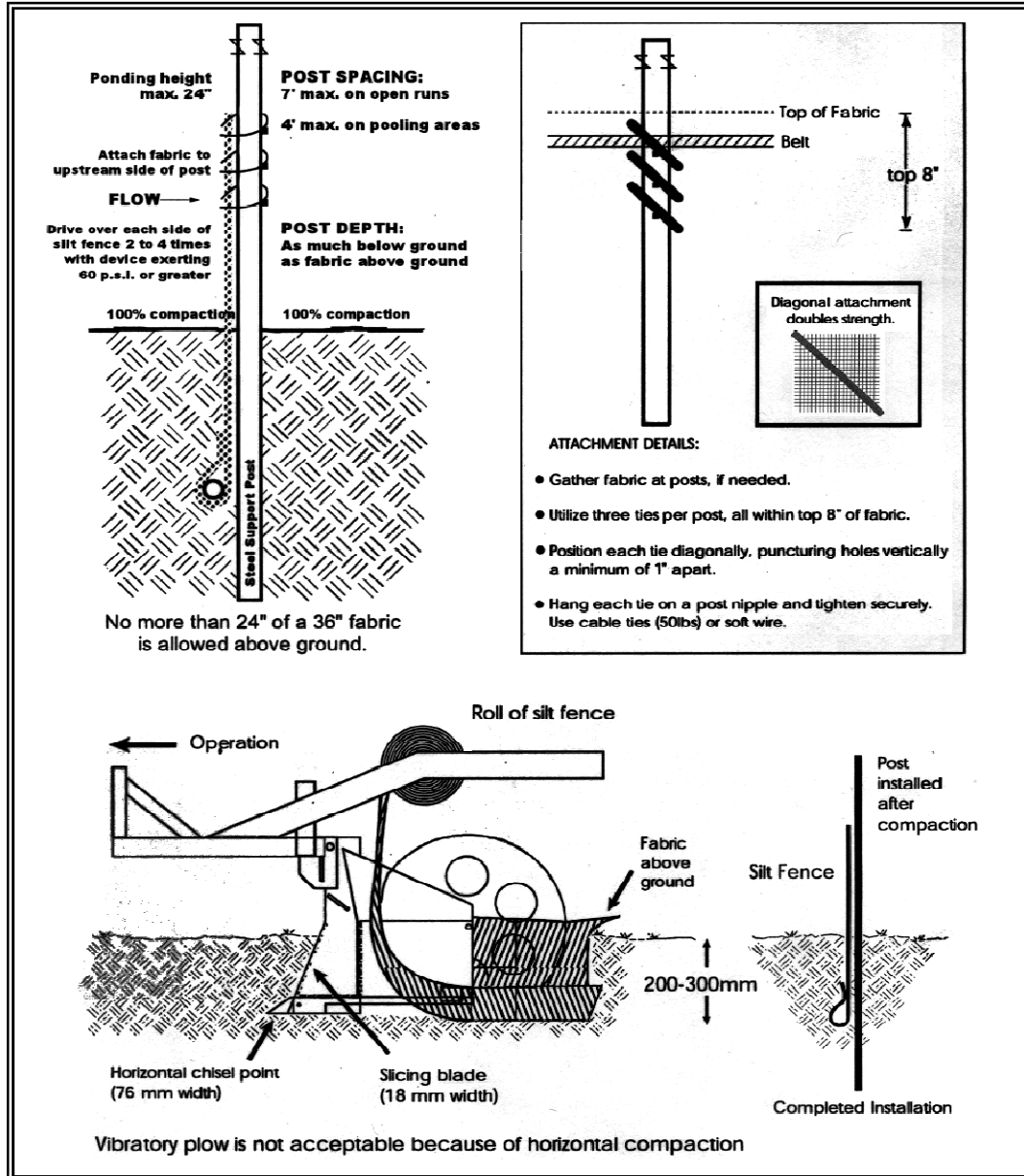

Figure 4.2.13 – Silt Fence Installation by Slicing Method

Maintenance Standards

- Repair any damage immediately.
- Intercept and convey all evident concentrated flows uphill of the silt fence to a sediment pond.
- Check the uphill side of the fence for signs of the fence clogging and acting as a barrier to flow and then causing channelization of flows parallel to the fence. If this occurs, replace the fence or remove the trapped sediment.

BMP C240: Sediment Trap

Purpose A sediment trap is a small temporary ponding area with a gravel outlet used to collect and store sediment from sites cleared and/or graded during construction. Sediment traps, along with other perimeter controls, shall be installed before any land disturbance takes place in the drainage area.

Conditions of Use Prior to leaving a construction site, stormwater runoff must pass through a sediment pond or trap or other appropriate sediment removal best management practice. Non-engineered sediment traps may be used on-site prior to an engineered sediment trap or sediment pond to provide additional sediment removal capacity.

It is intended for use on sites where the tributary drainage area is less than 3 acres, with no unusual drainage features, and a projected build-out time of six months or less. The sediment trap is a temporary measure (with a design life of approximately 6 months) and shall be maintained until the site area is permanently protected against erosion by vegetation and/or structures.

Sediment traps and ponds are only effective in removing sediment down to about the medium silt size fraction. Runoff with sediment of finer grades (fine silt and clay) will pass through untreated, emphasizing the need to control erosion to the maximum extent first.

Whenever possible, sediment-laden water shall be discharged into on-site, relatively level, vegetated areas (see [BMP C234 – Vegetated Strip](#)). This is the only way to effectively remove fine particles from runoff unless chemical treatment or filtration is used. This can be particularly useful after initial treatment in a sediment trap or pond. The areas of release must be evaluated on a site-by-site basis in order to determine appropriate locations for and methods of releasing runoff. Vegetated wetlands shall not be used for this purpose. Frequently, it may be possible to pump water from the collection point at the downhill end of the site to an upslope vegetated area. Pumping shall only augment the treatment system, not replace it, because of the possibility of pump failure or runoff volume in excess of pump capacity.

All projects that are constructing permanent facilities for runoff quantity control should use the rough-graded or final-graded permanent facilities for traps and ponds. This includes combined facilities and infiltration facilities. When permanent facilities are used as temporary sedimentation facilities, the surface area requirement of a sediment trap or pond must be met. If the surface area requirements are larger than the surface area of the permanent facility, then the trap or pond shall be enlarged to comply with the surface area requirement. The permanent pond shall also be divided into two cells as required for sediment ponds.

Either a permanent control structure or the temporary control structure (described in [BMP C241](#), Temporary Sediment Pond) can be used. If a permanent control structure is used, it may be advisable to partially restrict the lower orifice with gravel to increase residence time while still allowing dewatering of the pond. A shut-off valve may be added to the control structure to allow complete retention of stormwater in emergency situations. In this case, an emergency overflow weir must be added.

A skimmer may be used for the sediment trap outlet if approved by the Local Permitting Authority.

***Design and
Installation
Specifications***

- See [Figures 4.2.16](#) and [4.2.17](#) for details.
- If permanent runoff control facilities are part of the project, they should be used for sediment retention.
- To determine the sediment trap geometry, first calculate the design surface area (SA) of the trap, measured at the invert of the weir. Use the following equation:

$$SA = FS(Q_2/V_s)$$

where

Q_2 = Design inflow based on the peak discharge from the developed 2-year runoff event from the contributing drainage area as computed in the hydrologic analysis. The 10-year peak flow shall be used if the project size, expected timing and duration of construction, or downstream conditions warrant a higher level of protection. If no hydrologic analysis is required, the Rational Method may be used.

V_s = The settling velocity of the soil particle of interest. The 0.02 mm (medium silt) particle with an assumed density of 2.65 g/cm³ has been selected as the particle of interest and has a settling velocity (V_s) of 0.00096 ft/sec.

FS = A safety factor of 2 to account for non-ideal settling.

Therefore, the equation for computing surface area becomes:

$$SA = 2 \times Q_2 / 0.00096 \text{ or}$$

2080 square feet per cfs of inflow

Note: Even if permanent facilities are used, they must still have a surface area that is at least as large as that derived from the above formula. If they do not, the pond must be enlarged.

- To aid in determining sediment depth, all sediment traps shall have a staff gauge with a prominent mark 1-foot above the bottom of the trap.

- Sediment traps may not be feasible on utility projects due to the limited work space or the short-term nature of the work. Portable tanks may be used in place of sediment traps for utility projects.
- Sediment shall be removed from the trap when it reaches 1-foot in depth.
- Any damage to the pond embankments or slopes shall be repaired.

Maintenance Standards

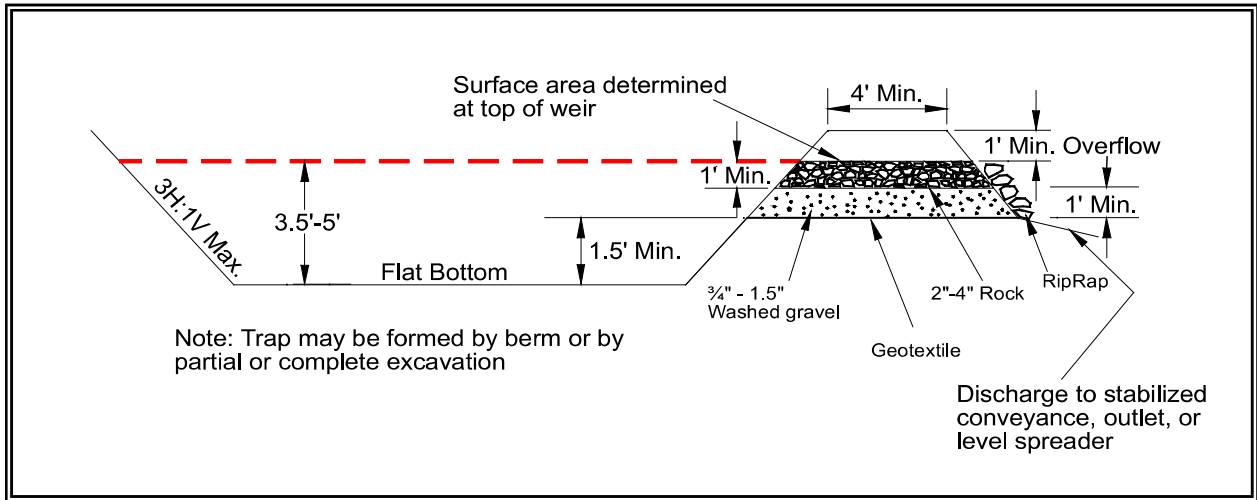

Figure 4.2.16 – Cross Section of Sediment Trap

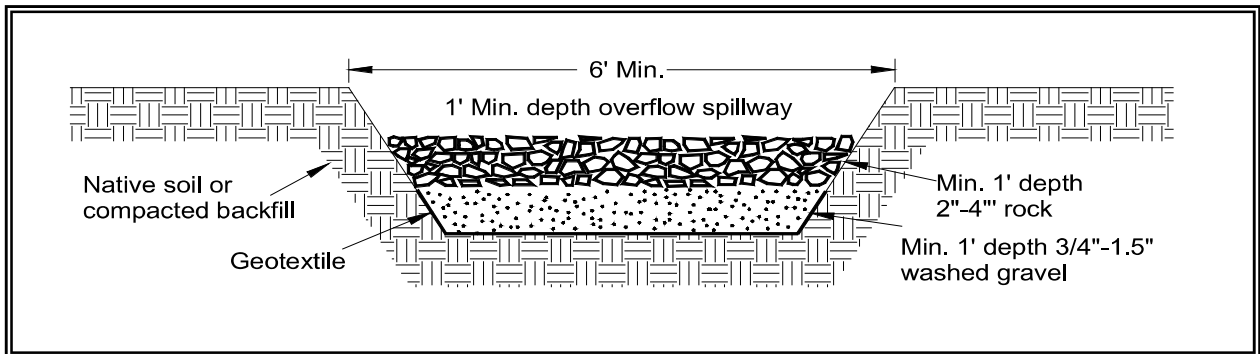

Figure 4.2.17 – Sediment Trap Outlet

BMP C241: Temporary Sediment Pond

- Purpose** Sediment ponds remove sediment from runoff originating from disturbed areas of the site. Sediment ponds are typically designed to remove sediment no smaller than medium silt (0.02 mm). Consequently, they usually reduce turbidity only slightly.
- Conditions of Use** Prior to leaving a construction site, stormwater runoff must pass through a sediment pond or other appropriate sediment removal best management practice.
- A sediment pond shall be used where the contributing drainage area is 3 acres or more. Ponds must be used in conjunction with erosion control practices to reduce the amount of sediment flowing into the basin.
- Design and Installation Specifications**
- Sediment basins must be installed only on sites where failure of the structure would not result in loss of life, damage to homes or buildings, or interruption of use or service of public roads or utilities. Also, sediment traps and ponds are attractive to children and can be very dangerous. Compliance with local ordinances regarding health and safety must be addressed. If fencing of the pond is required, the type of fence and its location shall be shown on the ESC plan.
 - Structures having a maximum storage capacity at the top of the dam of 10 acre-ft (435,600 ft³) or more are subject to the Washington Dam Safety Regulations ([Chapter 173-175 WAC](#)).
 - See [Figures 4.2.18](#), [4.2.19](#), and [4.2.20](#) for details.
 - If permanent runoff control facilities are part of the project, they should be used for sediment retention. The surface area requirements of the sediment basin must be met. This may require temporarily enlarging the permanent basin to comply with the surface area requirements. The permanent control structure must be temporarily replaced with a control structure that only allows water to leave the pond from the surface or by pumping. The permanent control structure must be installed after the site is fully stabilized. .
 - Use of infiltration facilities for sedimentation basins during construction tends to clog the soils and reduce their capacity to infiltrate. If infiltration facilities are to be used, the sides and bottom of the facility must only be rough excavated to a minimum of 2 feet above final grade. Final grading of the infiltration facility shall occur only when all contributing drainage areas are fully stabilized. The infiltration pretreatment facility should be fully constructed and used with the sedimentation basin to help prevent clogging.
 - Determining Pond Geometry
Obtain the discharge from the hydrologic calculations of the peak flow for the 2-year runoff event (Q_2). The 10-year peak flow shall be used if

the project size, expected timing and duration of construction, or downstream conditions warrant a higher level of protection. If no hydrologic analysis is required, the Rational Method may be used.

Determine the required surface area at the top of the riser pipe with the equation:

$$SA = 2 \times Q_2 / 0.00096 \quad \text{or} \\ 2080 \text{ square feet per cfs of inflow}$$

See [BMP C240](#) for more information on the derivation of the surface area calculation.

The basic geometry of the pond can now be determined using the following design criteria:

- Required surface area SA (from Step 2 above) at top of riser.
- Minimum 3.5-foot depth from top of riser to bottom of pond.
- Maximum 3H:1V interior side slopes and maximum 2H:1V exterior slopes. The interior slopes can be increased to a maximum of 2H:1V if fencing is provided at or above the maximum water surface.
- One foot of freeboard between the top of the riser and the crest of the emergency spillway.
- Flat bottom.
- Minimum 1-foot deep spillway.
- Length-to-width ratio between 3:1 and 6:1.
- Sizing of Discharge Mechanisms.

The outlet for the basin consists of a combination of principal and emergency spillways. These outlets must pass the peak runoff expected from the contributing drainage area for a 100-year storm. If, due to site conditions and basin geometry, a separate emergency spillway is not feasible, the principal spillway must pass the entire peak runoff expected from the 100-year storm. However, an attempt to provide a separate emergency spillway should always be made. The runoff calculations should be based on the site conditions during construction. The flow through the dewatering orifice cannot be utilized when calculating the 100-year storm elevation because of its potential to become clogged; therefore, available spillway storage must begin at the principal spillway riser crest.

The principal spillway designed by the procedures contained in this standard will result in some reduction in the peak rate of runoff. However, the riser outlet design will not adequately control the basin discharge to the predevelopment discharge limitations as stated in Minimum Requirement #7: Flow Control. However, if the basin for a permanent stormwater detention pond is used for a temporary

sedimentation basin, the control structure for the permanent pond can be used to maintain predevelopment discharge limitations. The size of the basin, the expected life of the construction project, the anticipated downstream effects and the anticipated weather conditions during construction, should be considered to determine the need of additional discharge control. See [Figure 4.2.21](#) for riser inflow curves.

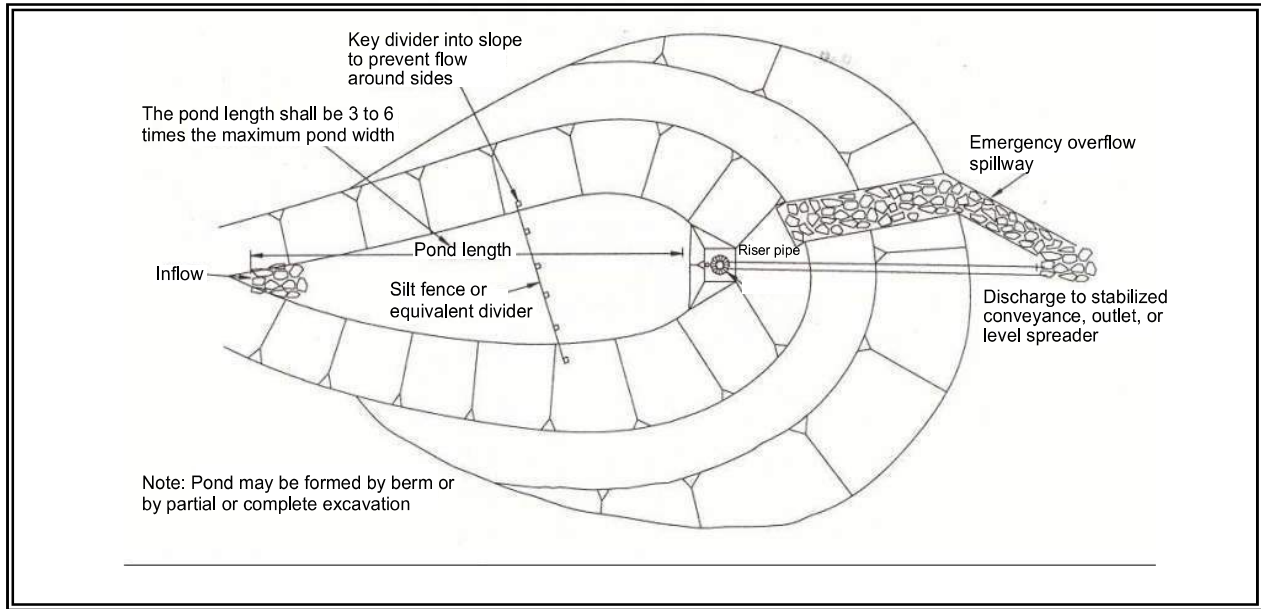

Figure 4.2.18 – Sediment Pond Plan View

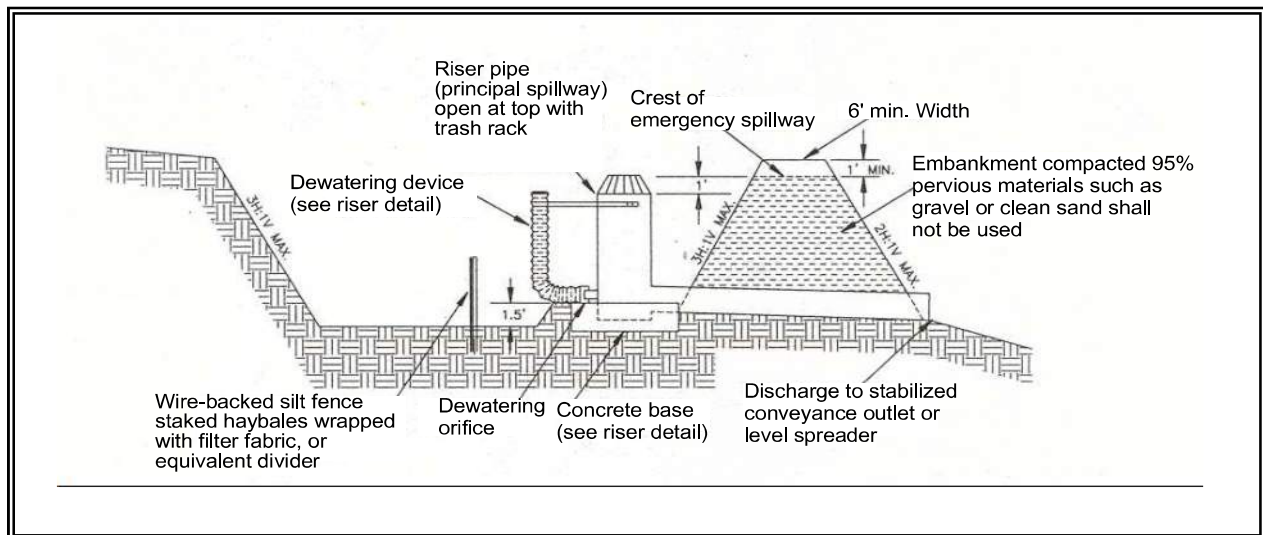

Figure 4.2.19 – Sediment Pond Cross Section

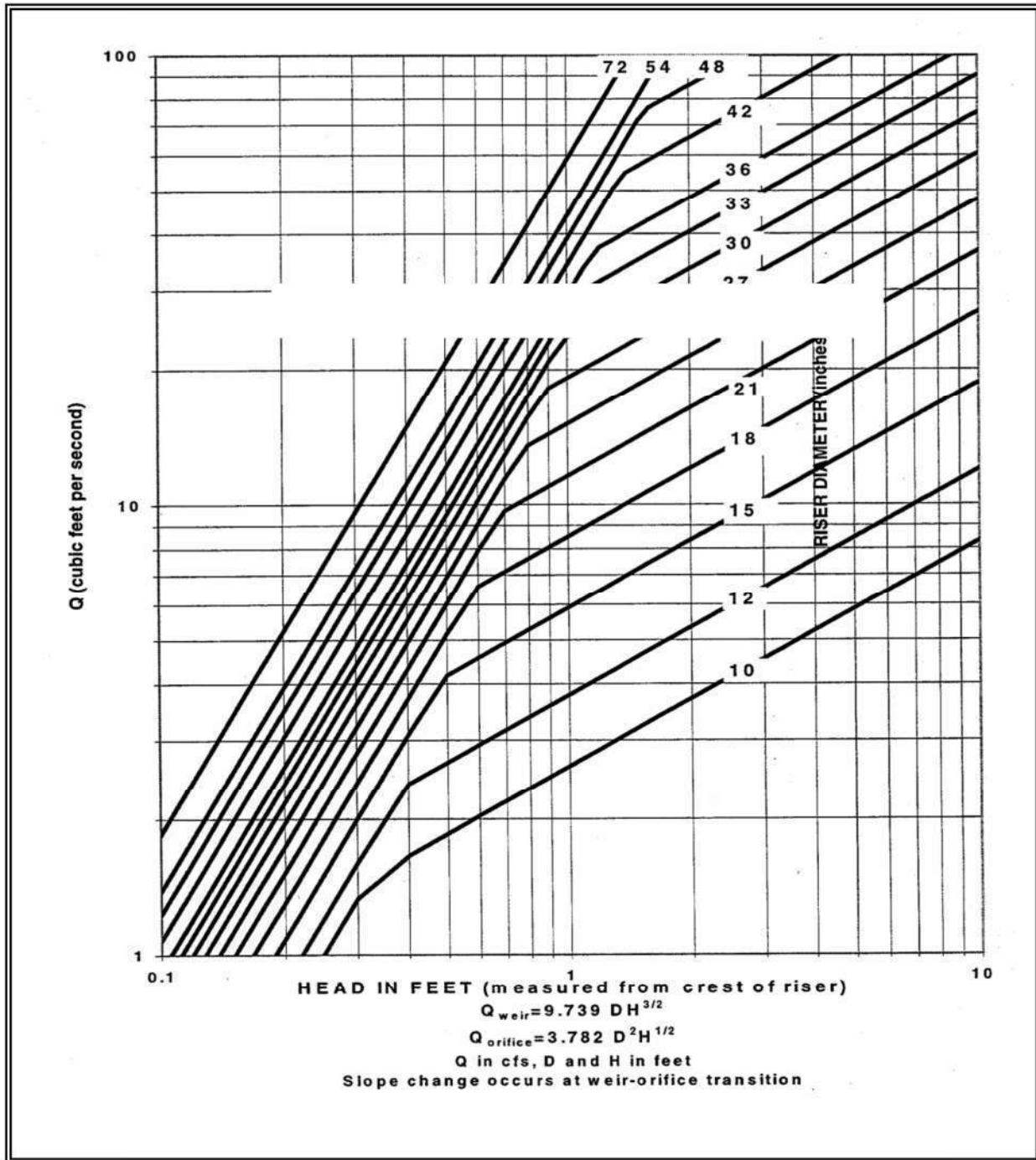

Figure 4.2.21 – Riser Inflow Curves

Principal Spillway: Determine the required diameter for the principal spillway (riser pipe). The diameter shall be the minimum necessary to pass the site's 15-minute, 10-year flowrate. If using the Western Washington Hydrology Model (WWHM), Version 2 or 3, design flow is the 10-year (1 hour) flow for the developed (unmitigated) site, multiplied by a factor of 1.6. Use Figure 4.2.21 to determine this diameter ($h = 1$ -foot). *Note: A permanent control structure may be used instead of a temporary riser.*

Emergency Overflow Spillway: Determine the required size and design of the emergency overflow spillway for the developed 100-year peak flow using the method contained in Volume III.

Dewatering Orifice: Determine the size of the dewatering orifice(s) (minimum 1-inch diameter) using a modified version of the discharge equation for a vertical orifice and a basic equation for the area of a circular orifice. Determine the required area of the orifice with the following equation:

$$A_o = \frac{A_s (2h)^{0.5}}{0.6 \times 3600 T g^{0.5}}$$

where A_o = orifice area (square feet)
 A_s = pond surface area (square feet)
 h = head of water above orifice (height of riser in feet)
 T = dewatering time (24 hours)
 g = acceleration of gravity (32.2 feet/second²)

Convert the required surface area to the required diameter D of the orifice:

$$D = 24 \times \sqrt{\frac{A_o}{\pi}} = 13.54 \times \sqrt{A_o}$$

The vertical, perforated tubing connected to the dewatering orifice must be at least 2 inches larger in diameter than the orifice to improve flow characteristics. The size and number of perforations in the tubing should be large enough so that the tubing does not restrict flow. The orifice should control the flow rate.

- **Additional Design Specifications**

The pond shall be divided into two roughly equal volume cells by a permeable divider that will reduce turbulence while allowing movement of water between cells. The divider shall be at least one-half the height of the riser and a minimum of one foot below the top of the riser. Wire-backed, 2- to 3-foot high, extra strength filter fabric supported by treated 4"x4"s can be used as a divider. Alternatively, staked straw bales wrapped with filter fabric (geotextile) may be used. If the pond is more than 6 feet deep, a different mechanism must be proposed. A riprap embankment is one acceptable method of

separation for deeper ponds. Other designs that satisfy the intent of this provision are allowed as long as the divider is permeable, structurally sound, and designed to prevent erosion under or around the barrier.

To aid in determining sediment depth, one-foot intervals shall be prominently marked on the riser.

If an embankment of more than 6 feet is proposed, the pond must comply with the criteria contained in Volume III regarding dam safety for detention BMPs.

- The most common structural failure of sedimentation basins is caused by piping. Piping refers to two phenomena: (1) water seeping through fine-grained soil, eroding the soil grain by grain and forming pipes or tunnels; and, (2) water under pressure flowing upward through a granular soil with a head of sufficient magnitude to cause soil grains to lose contact and capability for support.

The most critical construction sequences to prevent piping will be:

1. Tight connections between riser and barrel and other pipe connections.
2. Adequate anchoring of riser.
3. Proper soil compaction of the embankment and riser footing.
4. Proper construction of anti-seep devices.

Maintenance Standards

- Sediment shall be removed from the pond when it reaches 1-foot in depth.
- Any damage to the pond embankments or slopes shall be repaired.

BMP C250: Construction Stormwater Chemical Treatment

Purpose

This BMP applies when using stormwater chemicals in batch treatment or flow-through treatment.

Turbidity is difficult to control once fine particles are suspended in stormwater runoff from a construction site. Sedimentation ponds are effective at removing larger particulate matter by gravity settling, but are ineffective at removing smaller particulates such as clay and fine silt. Traditional erosion and sediment control BMPs may not be adequate to ensure compliance with the water quality standards for turbidity in receiving water.

Chemical treatment can reliably provide exceptional reductions of turbidity and associated pollutants. Chemical treatment may be required to meet turbidity stormwater discharge requirements, especially when construction is to proceed through the wet season.

Conditions of Use

Formal written approval from Ecology is required for the use of chemical treatment regardless of site size. The Local Permitting Authority may also

***Design and
Installation
Specifications***

require review and approval. When approved, the chemical treatment systems must be included in the Construction Stormwater Pollution Prevention Plan (SWPPP).

See [Appendix II-B](#) for background information on chemical treatment.

Criteria for Chemical Treatment Product Use: Chemically treated stormwater discharged from construction sites must be nontoxic to aquatic organisms. The Chemical Technology Assessment Protocol (CTAPE) must be used to evaluate chemicals proposed for stormwater treatment. Only chemicals approved by Ecology under the CTAPE may be used for stormwater treatment. The approved chemicals, their allowable application techniques (batch treatment or flow-through treatment), allowable application rates, and conditions of use can be found at the Department of Ecology Emerging Technologies website: <http://www.ecy.wa.gov/programs/wq/stormwater/newtech/technologies.html>.

Treatment System Design Considerations: The design and operation of a chemical treatment system should take into consideration the factors that determine optimum, cost-effective performance. It is important to recognize the following:

- Only Ecology approved chemicals may be used and must follow approved dose rate.
- The pH of the stormwater must be in the proper range for the polymers to be effective, which is typically 6.5 to 8.5
- The coagulant must be mixed rapidly into the water to ensure proper dispersion.
- A flocculation step is important to increase the rate of settling, to produce the lowest turbidity, and to keep the dosage rate as low as possible.
- Too little energy input into the water during the flocculation phase results in flocs that are too small and/or insufficiently dense. Too much energy can rapidly destroy floc as it is formed.
- Care must be taken in the design of the withdrawal system to minimize outflow velocities and to prevent floc discharge. Discharge from a batch treatment system should be directed through a physical filter such as a vegetated swale that would catch any unintended floc discharge. Currently, flow-through systems always discharge through the chemically enhanced sand filtration system.
- System discharge rates must take into account downstream conveyance integrity.

Polymer Batch Treatment Process Description:

A batch chemical treatment system consists of the stormwater collection system (either temporary diversion or the permanent site drainage system), a storage pond, pumps, a chemical feed system, treatment cells, and interconnecting piping.

The batch treatment system shall use a minimum of two lined treatment cells in addition to an untreated stormwater storage pond. Multiple treatment cells allow for clarification of treated water while other cells are being filled or emptied. Treatment cells may be ponds or tanks. Ponds with constructed earthen embankments greater than six feet high or which impound more than 10 acre-feet require special engineering analyses. The Ecology Dam Safety Section has specific design criteria for dams in Washington State (see <http://www.ecy.wa.gov/programs/wr/dams/GuidanceDocs.html>).

Stormwater is collected at interception point(s) on the site and is diverted by gravity or by pumping to an untreated stormwater storage pond or other untreated stormwater holding area. The stormwater is stored until treatment occurs. It is important that the holding pond be large enough to provide adequate storage.

The first step in the treatment sequence is to check the pH of the stormwater in the untreated stormwater storage pond. The pH is adjusted by the application of carbon dioxide or a base until the stormwater in the storage pond is within the desired pH range, 6.5 to 8.5. When used, carbon dioxide is added immediately downstream of the transfer pump. Typically sodium bicarbonate (baking soda) is used as a base, although other bases may be used. When needed, base is added directly to the untreated stormwater storage pond. The stormwater is recirculated with the treatment pump to provide mixing in the storage pond. Initial pH adjustments should be based on daily bench tests. Further pH adjustments can be made at any point in the process.

Once the stormwater is within the desired pH range (dependant on polymer being used), the stormwater is pumped from the untreated stormwater storage pond to a treatment cell as polymer is added. The polymer is added upstream of the pump to facilitate rapid mixing.

After polymer addition, the water is kept in a lined treatment cell for clarification of the sediment-floc. In a batch mode process, clarification typically takes from 30 minutes to several hours. Prior to discharge samples are withdrawn for analysis of pH, flocculent chemical concentration, and turbidity. If both are acceptable, the treated water is discharged.

Several configurations have been developed to withdraw treated water from the treatment cell. The original configuration is a device that withdraws the treated water from just beneath the water surface using a

float with adjustable struts that prevent the float from settling on the cell bottom. This reduces the possibility of picking up sediment-floc from the bottom of the pond. The struts are usually set at a minimum clearance of about 12 inches; that is, the float will come within 12 inches of the bottom of the cell. Other systems have used vertical guides or cables which constrain the float, allowing it to drift up and down with the water level. More recent designs have an H-shaped array of pipes, set on the horizontal.

This scheme provides for withdrawal from four points rather than one. This configuration reduces the likelihood of sucking settled solids from the bottom. It also reduces the tendency for a vortex to form. Inlet diffusers, a long floating or fixed pipe with many small holes in it, are also an option.

Safety is a primary concern. Design should consider the hazards associated with operations, such as sampling. Facilities should be designed to reduce slip hazards and drowning. Tanks and ponds should have life rings, ladders, or steps extending from the bottom to the top.

Polymer Batch Treatment Process Description:

At a minimum, a flow-through chemical treatment system consists of the stormwater collection system (either temporary diversion or the permanent site drainage system), an untreated stormwater storage pond, and the chemically enhanced sand filtration system.

Stormwater is collected at interception point(s) on the site and is diverted by gravity or by pumping to an untreated stormwater storage pond or other untreated stormwater holding area. The stormwater is stored until treatment occurs. It is important that the holding pond be large enough to provide adequate storage.

Stormwater is then pumped from the untreated stormwater storage pond to the chemically enhanced sand filtration system where polymer is added. Adjustments to pH may be necessary before chemical addition. The sand filtration system continually monitors the stormwater for turbidity and pH. If the discharge water is ever out of an acceptable range for turbidity or pH, the water is recycled to the untreated stormwater pond where it can be retreated.

For batch treatment and flow-through treatment, the following equipment should be located in a lockable shed:

- The chemical injector.
- Secondary containment for acid, caustic, buffering compound, and treatment chemical.
- Emergency shower and eyewash.
- Monitoring equipment which consists of a pH meter and a turbidimeter.

System Sizing:

Certain sites are required to implement flow control for the developed sites. These sites must also control stormwater release rates during construction. Generally, these are sites that discharge stormwater directly, or indirectly, through a conveyance system, into a fresh water. System sizing is dependent on flow control requirements.

Sizing Criteria for Batch Treatment Systems for Flow Control Exempt Water Bodies:

The total volume of the untreated stormwater storage pond and treatment ponds or tanks must be large enough to treat stormwater that is produced during multiple day storm events. It is recommended that at a minimum the untreated stormwater storage pond be sized to hold 1.5 times the runoff volume of the 10-year, 24-hour storm event. Bypass should be provided around the chemical treatment system to accommodate extreme storm events. Runoff volume shall be calculated using the methods presented in Volume 3, Chapter 2. Worst-case land cover conditions (i.e., producing the most runoff) should be used for analyses (in most cases, this would be the land cover conditions just prior to final landscaping).

Primary settling should be encouraged in the untreated stormwater storage pond. A forebay with access for maintenance may be beneficial.

There are two opposing considerations in sizing the treatment cells. A larger cell is able to treat a larger volume of water each time a batch is processed. However, the larger the cell the longer the time required to empty the cell. A larger cell may also be less effective at flocculation and therefore require a longer settling time. The simplest approach to sizing the treatment cell is to multiply the allowable discharge flow rate times the desired drawdown time. A 4-hour drawdown time allows one batch per cell per 8-hour work period, given 1 hour of flocculation followed by two hours of settling.

If the discharge is directly to a flow control exempt receiving water listed in Appendix I-E of Volume I or to an infiltration system, there is no discharge flow limit.

Ponds sized for flow control water bodies must at a minimum meet the sizing criteria for flow control exempt waters.

Sizing Criteria for Flow-Through Treatment Systems for Flow Control Exempt Water Bodies:

When sizing storage ponds or tanks for flow-through systems for flow control exempt water bodies, the treatment system capacity should be a factor. The untreated stormwater storage pond or tank should be sized to hold 1.5 times the runoff volume of the 10-year, 24-hour storm event minus the treatment system flowrate for an 8-hour period. For a chitosan-enhanced sand filtration system, the treatment system flowrate should be sized using a hydraulic loading rate between 6-8 gpm/ft². Other hydraulic

loading rates may be more appropriate for other systems. Bypass should be provided around the chemical treatment system to accommodate extreme storms. Runoff volume shall be calculated using the methods presented in Volume 3, Chapter 2. Worst-case land cover conditions (i.e., producing the most runoff) should be used for analyses (in most cases, this would be the land cover conditions just prior to final landscaping).

Sizing Criteria for Flow Control Water Bodies:

Sites that must implement flow control for the developed site condition must also control stormwater release rates during construction. Construction site stormwater discharges shall not exceed the discharge durations of the pre-developed condition for the range of pre-developed discharge rates from ½ of the 2-year flow through the 10-year flow as predicted by an approved continuous runoff model. The pre-developed condition to be matched shall be the land cover condition immediately prior to the development project. This restriction on release rates can affect the size of the storage pond and treatment cells.

The following is how WWHM can be used to determine the release rates from the chemical treatment systems:

1. Determine the pre-developed flow durations to be matched by entering the existing land use area under the “Pre-developed” scenario in WWHM. The default flow range is from ½ of the 2-year flow through the 10-year flow.
2. Enter the post developed land use area in the “Developed Unmitigated” scenario in WWHM.
3. Copy the land use information from the “Developed Unmitigated” to “Developed Mitigated” scenario.
4. While in the “Developed Mitigated” scenario, add a pond element under the basin element containing the post-developed land use areas. This pond element represents information on the available untreated stormwater storage and discharge from the chemical treatment system. In cases where the discharge from the chemical treatment system is controlled by a pump, a stage/storage/discharge (SSD) table representing the pond must be generated outside WWHM and imported into WWHM. WWHM can route the runoff from the post-developed condition through this SSD table (the pond) and determine compliance with the flow duration standard. This would be an iterative design procedure where if the initial SSD table proved to be inadequate, the designer would have to modify the SSD table outside WWHM and re-import in WWHM and route the runoff through it again. The iteration will continue until a pond that complies with the flow duration standard is correctly sized.

Notes on SSD table characteristics:

- The pump discharge rate would likely be initially set at just below $\frac{1}{2}$ of the 2-year flow from the pre-developed condition. As runoff coming into the untreated stormwater storage pond increases and the available untreated stormwater storage volume gets used up, it would be necessary to increase the pump discharge rate above $\frac{1}{2}$ of the 2-year. The increase(s) above $\frac{1}{2}$ of the 2-year must be such that they provide some relief to the untreated stormwater storage needs but at the same time will not cause violations of the flow duration standard at the higher flows. The final design SSD table will identify the appropriate pumping rates and the corresponding stage and storages.
 - When building such a flow control system, the design must ensure that any automatic adjustments to the pumping rates will be as a result of changes to the available storage in accordance with the final design SSD table.
5. It should be noted that the above procedures would be used to meet the flow control requirements. The chemical treatment system must be able to meet the runoff treatment requirements. It is likely that the discharge flow rate of $\frac{1}{2}$ of the 2-year or more may exceed the treatment capacity of the system. If that is the case, the untreated stormwater discharge rate(s) (i.e., influent to the treatment system) must be reduced to allow proper treatment. Any reduction in the flows would likely result in the need for a larger untreated stormwater storage volume.

If the discharge is to a municipal storm drainage system, the allowable discharge rate may be limited by the capacity of the public system. It may be necessary to clean the municipal storm drainage system prior to the start of the discharge to prevent scouring solids from the drainage system. If the municipal storm drainage system discharges to a water body not on the flow control exempt list, the project site is subject to flow control requirements. Obtain permission from the owner of the collection system before discharging to it.

If system design does not allow you to discharge at the slower rates as described above and if the site has a retention or detention pond that will serve the planned development, the discharge from the treatment system may be directed to the permanent retention/detention pond to comply with the flow control requirement. In this case, the untreated stormwater storage pond and treatment system will be sized according to the sizing criteria for flow-through treatment systems for flow control exempt water bodies described earlier except all discharge (water passing through the treatment system and stormwater bypassing the treatment system) will be directed into the permanent retention/detention pond. If site constraints make locating the untreated stormwater storage pond difficult, the permanent retention/detention pond may be divided to serve as the untreated stormwater storage pond and the post-treatment flow control pond. A berm or barrier must be used in this case so the untreated water does not mix with the treated

Maintenance Standards

water. Both untreated stormwater storage requirements, and adequate post-treatment flow control must be achieved. The post-treatment flow control pond's revised dimensions must be entered into the WWHM and the WWHM must be run to confirm compliance with the flow control requirement.

Monitoring: At a minimum, the following monitoring shall be conducted. Test results shall be recorded on a daily log kept on site. Additional testing may be required by the NPDES permit based on site conditions.

Operational Monitoring:

- Total volume treated and discharged.
- Flow must be continuously monitored and recorded at not greater than 15-minute intervals.
- Type and amount of chemical used for pH adjustment.
- Amount of polymer used for treatment.
- Settling time.

Compliance Monitoring:

- Influent and effluent pH, flocculent chemical concentration, and turbidity must be continuously monitored and recorded at not greater than 15-minute intervals. pH and turbidity of the receiving water.

Biomonitoring:

Treated stormwater must be non-toxic to aquatic organisms. Treated stormwater must be tested for aquatic toxicity or residual chemicals. Frequency of biomonitoring will be determined by Ecology.

Residual chemical tests must be approved by Ecology prior to their use.

If testing treated stormwater for aquatic toxicity, you must test for acute (lethal) toxicity. Bioassays shall be conducted by a laboratory accredited by Ecology, unless otherwise approved by Ecology. Acute toxicity tests shall be conducted per the CTAPE protocol.

Discharge Compliance: Prior to discharge, treated stormwater must be sampled and tested for compliance with pH, flocculent chemical concentration, and turbidity limits. These limits may be established by the Construction Stormwater General Permit or a site-specific discharge permit. Sampling and testing for other pollutants may also be necessary at some sites. pH must be within the range of 6.5 to 8.5 standard units and not cause a change in the pH of the receiving water of more than 0.2 standard units. Treated stormwater samples and measurements shall be taken from the discharge pipe or another location representative of the nature of the treated stormwater discharge. Samples used for determining compliance with the water quality standards in the receiving water shall not be taken from the treatment pond prior to decanting. Compliance with the water quality standards is determined in the receiving water.

Operator Training: Each contractor who intends to use chemical treatment shall be trained by an experienced contractor . Each site using chemical treatment must have an operator trained and certified by an organization approved by Ecology.

Standard BMPs: Surface stabilization BMPs should be implemented on site to prevent significant erosion. All sites shall use a truck wheel wash to prevent tracking of sediment off site.

Sediment Removal and Disposal:

- Sediment shall be removed from the storage or treatment cells as necessary. Typically, sediment removal is required at least once during a wet season and at the decommissioning of the cells. Sediment remaining in the cells between batches may enhance the settling process and reduce the required chemical dosage.
- Sediment that is known to be non-toxic may be incorporated into the site away from drainages.

BMP C251: Construction Stormwater Filtration

Purpose

Filtration removes sediment from runoff originating from disturbed areas of the site.

Background Information:

Filtration with sand media has been used for over a century to treat water and wastewater. The use of sand filtration for treatment of stormwater has developed recently, generally to treat runoff from streets, parking lots, and residential areas. The application of filtration to construction stormwater treatment is currently under development.

Conditions of Use

Traditional BMPs used to control soil erosion and sediment loss from sites under development may not be adequate to ensure compliance with the water quality standard for turbidity in the receiving water. Filtration may be used in conjunction with gravity settling to remove sediment as small as fine silt (0.5 µm). The reduction in turbidity will be dependent on the particle size distribution of the sediment in the stormwater. In some circumstances, sedimentation and filtration may achieve compliance with the water quality standard for turbidity.

The use of construction stormwater filtration does not require approval from Ecology as long as treatment chemicals are not used. Filtration in conjunction with polymer treatment requires testing under the Chemical Technology Assessment Protocol – Ecology (CTAPE) before it can be initiated. Approval from the appropriate regional Ecology office must be obtained at each site where polymers use is proposed prior to use. For more guidance on stormwater chemical treatment see [BMP C250](#).

Design and Installation Specifications

Two types of filtration systems may be applied to construction stormwater treatment: rapid and slow. Rapid sand filters are the typical system used for water and wastewater treatment. They can achieve relatively high hydraulic flow rates, on the order of 2 to 20 gpm/sf, because they have automatic backwash systems to remove accumulated solids. In contrast, slow sand filters have very low hydraulic rates, on the order of 0.02 gpm/sf, because they do not have backwash systems. Slow sand filtration has generally been used to treat stormwater. Slow sand filtration is mechanically simple in comparison to rapid sand filtration but requires a much larger filter area.

Filtration Equipment. Sand media filters are available with automatic backwashing features that can filter to 50 μm particle size. Screen or bag filters can filter down to 5 μm . Fiber wound filters can remove particles down to 0.5 μm . Filters should be sequenced from the largest to the smallest pore opening. Sediment removal efficiency will be related to particle size distribution in the stormwater.

Treatment Process Description. Stormwater is collected at interception point(s) on the site and is diverted to an untreated stormwater sediment pond or tank for removal of large sediment and storage of the stormwater before it is treated by the filtration system. The untreated stormwater is pumped from the trap, pond, or tank through the filtration system in a rapid sand filtration system. Slow sand filtration systems are designed as flow through systems using gravity.

Maintenance Standards

Rapid sand filters typically have automatic backwash systems that are triggered by a pre-set pressure drop across the filter. If the backwash water volume is not large or substantially more turbid than the untreated stormwater stored in the holding pond or tank, backwash return to the untreated stormwater pond or tank may be appropriate. However, other means of treatment and disposal may be necessary.

- Screen, bag, and fiber filters must be cleaned and/or replaced when they become clogged.
- Sediment shall be removed from the storage and/or treatment ponds as necessary. Typically, sediment removal is required once or twice during a wet season and at the decommissioning of the ponds.

Sizing Criteria for Flow-Through Treatment Systems for Flow Control Exempt Water Bodies:

When sizing storage ponds or tanks for flow-through systems for flow control exempt water bodies the treatment system capacity should be a factor. The untreated stormwater storage pond or tank should be sized to hold 1.5 times the runoff volume of the 10-year, 24-hour storm event minus the treatment system flowrate for an 8-hour period. For a chitosan-enhanced sand filtration system, the treatment system flowrate should be sized using a hydraulic loading rate between 6-8 gpm/ft². Other hydraulic

loading rates may be more appropriate for other systems. Bypass should be provided around the chemical treatment system to accommodate extreme storms. Runoff volume shall be calculated using the methods presented in Volume 3, Chapter 2. Worst-case conditions (i.e., producing the most runoff) should be used for analyses (most likely conditions present prior to final landscaping).

Sizing Criteria for Flow Control Water Bodies:

Sites that must implement flow control for the developed site condition must also control stormwater release rates during construction. Construction site stormwater discharges shall not exceed the discharge durations of the pre-developed condition for the range of pre-developed discharge rates from 1/2 of the 2-year flow through the 10-year flow as predicted by an approved continuous runoff model. The pre-developed condition to be matched shall be the land cover condition immediately prior to the development project. This restriction on release rates can affect the size of the storage pond, the filtration system, and the flow rate through the filter system.

The following is how WWHM can be used to determine the release rates from the filtration systems:

1. Determine the pre-developed flow durations to be matched by entering the land use area under the “Pre-developed” scenario in WWHM. The default flow range is from 1/2 of the 2-year flow through the 10-year flow.
2. Enter the post developed land use area in the “Developed Unmitigated” scenario in WWHM.
3. Copy the land use information from the “Developed Unmitigated” to “Developed Mitigated” scenario.
4. There are two possible ways to model stormwater filtration systems:
 - a. The stormwater filtration system uses an untreated stormwater storage pond/tank and the discharge from this pond/tank is pumped to one or more filters. In-line filtration chemicals would be added to the flow right after the pond/tank and before the filter(s). Because the discharge is pumped, WWHM can't generate a stage/storage /discharge (SSD) table for this system. This system is modeled the same way as described in [BMP C250](#) and is as follows:

While in the “Developed Mitigated” scenario, add a pond element under the basin element containing the post-developed land use areas. This pond element represents information on the available untreated stormwater storage and discharge from the filtration system. In cases where the discharge from the filtration system is controlled by a pump, a stage/storage/discharge (SSD) table representing the pond must be generated outside WWHM and

imported into WWHM. WWHM can route the runoff from the post-developed condition through this SSD table (the pond) and determine compliance with the flow duration standard. This would be an iterative design procedure where if the initial SSD table proved to be out of compliance, the designer would have to modify the SSD table outside WWHM and re-import in WWHM and route the runoff through it again. The iteration will continue until a pond that enables compliance with the flow duration standard is designed.

Notes on SSD table characteristics:

- The pump discharge rate would likely be initially set at just below $\frac{1}{2}$ of the 2-year flow from the pre-developed condition. As runoff coming into the untreated stormwater storage pond increases and the available untreated stormwater storage volume gets used up, it would be necessary to increase the pump discharge rate above $\frac{1}{2}$ of the 2-year. The increase(s) above $\frac{1}{2}$ of the 2-year must be such that they provide some relief to the untreated stormwater storage needs but at the same time they will not cause violations of the flow duration standard at the higher flows. The final design SSD table will identify the appropriate pumping rates and the corresponding stage and storages.
 - When building such a flow control system, the design must ensure that any automatic adjustments to the pumping rates will be as a result of changes to the available storage in accordance with the final design SSD table.
- b. The stormwater filtration system uses a storage pond/tank and the discharge from this pond/tank gravity flows to the filter. This is usually a slow sand filter system and it is possible to model it in WWHM as a Filter element or as a combination of Pond and Filter element placed in series. The stage/storage/discharge table(s) may then be generated within WWHM as follows:
- (i) While in the “Developed Mitigated” scenario, add a Filter element under the basin element containing the post-developed land use areas. The length and width of this filter element would have to be the same as the bottom length and width of the upstream untreated stormwater storage pond/tank.
 - (ii) In cases where the length and width of the filter is not the same as those for the bottom of the upstream untreated stormwater storage tank/pond, the treatment system may be modeled as a Pond element followed by a Filter element. By having these two elements, WWHM would then generate a SSD table for the storage pond which then gravity flows to the Filter element. The Filter element downstream of the untreated stormwater

storage pond would have a storage component through the media, and an overflow component for when the filtration capacity is exceeded.

WVHM can route the runoff from the post-developed condition through the treatment systems in 4b and determine compliance with the flow duration standard. This would be an iterative design procedure where if the initial sizing estimates for the treatment system proved to be inadequate, the designer would have to modify the system and route the runoff through it again. The iteration would continue until compliance with the flow duration standard is achieved.

5. It should be noted that the above procedures would be used to meet the flow control requirements. The filtration system must be able to meet the runoff treatment requirements. It is likely that the discharge flow rate of $\frac{1}{2}$ of the 2-year or more may exceed the treatment capacity of the system. If that is the case, the untreated stormwater discharge rate(s) (i.e., influent to the treatment system) must be reduced to allow proper treatment. Any reduction in the flows would likely result in the need for a larger untreated stormwater storage volume.

If system design does not allow you to discharge at the slower rates as described above and if the site has a retention or detention pond that will serve the planned development, the discharge from the treatment system may be directed to the permanent retention/detention pond to comply with the flow control requirements. In this case, the untreated stormwater storage pond and treatment system will be sized according to the sizing criteria for flow-through treatment systems for flow control exempt waterbodies described earlier except all discharges (water passing through the treatment system and stormwater bypassing the treatment system) will be directed into the permanent retention/detention pond. If site constraints make locating the untreated stormwater storage pond difficult, the permanent retention/detention pond may be divided to serve as the untreated stormwater discharge pond and the post-treatment flow control pond. A berm or barrier must be used in this case so the untreated water does not mix with the treated water. Both untreated stormwater storage requirements, and adequate post-treatment flow control must be achieved. The post-treatment flow control pond's revised dimensions must be entered into the WVHM and the WVHM must be run to confirm compliance with the flow control requirement.

BMP C252: High pH Neutralization Using CO₂

Purpose

When pH levels in stormwater rise above 8.5 it is necessary to lower the pH levels to the acceptable range of 6.5 to 8.5, this process is called pH neutralization. pH neutralization involves the use of solid or compressed carbon dioxide gas in water requiring neutralization. Neutralized stormwater may be discharged to surface waters under the General Construction NPDES permit.

Neutralized process water such as concrete truck wash-out, hydro-demolition, or saw-cutting slurry must be managed to prevent discharge to surface waters. Any stormwater contaminated during concrete work is considered process wastewater and must not be discharged to surface waters.

Reason for pH Neutralization:

A pH level range of 6.5 to 8.5 is typical for most natural watercourses, and this neutral pH is required for the survival of aquatic organisms. Should the pH rise or drop out of this range, fish and other aquatic organisms may become stressed and may die.

Calcium hardness can contribute to high pH values and cause toxicity that is associated with high pH conditions. A high level of calcium hardness in waters of the state is not allowed.

The water quality standard for pH in Washington State is in the range of 6.5 to 8.5. Ground water standard for calcium and other dissolved solids in Washington State is less than 500 mg/l.

Conditions of Use

Causes of High pH:

High pH at construction sites is most commonly caused by the contact of stormwater with poured or recycled concrete, cement, mortars, and other Portland cement or lime containing construction materials. (See [BMP C151: Concrete Handling](#) for more information on concrete handling procedures). The principal caustic agent in cement is calcium hydroxide (free lime).

Advantages of CO₂ Sparging:

- Rapidly neutralizes high pH water.
- Cost effective and safer to handle than acid compounds.
- CO₂ is self-buffering. It is difficult to overdose and create harmfully low pH levels.
- Material is readily available.

***Design and
Installation
Specifications***

The Chemical Process:

When carbon dioxide (CO₂) is added to water (H₂O), carbonic acid (H₂CO₃) is formed which can further dissociate into a proton (H⁺) and a bicarbonate anion (HCO₃⁻) as shown below:



The free proton is a weak acid that can lower the pH. Water temperature has an effect on the reaction as well. The colder the water temperature is the slower the reaction occurs and the warmer the water temperature is the quicker the reaction occurs. Most construction applications in Washington State have water temperatures in the 50°F or higher range so the reaction is almost simultaneous.

Treatment Process:

High pH water may be treated using continuous treatment, continuous discharge systems. These manufactured systems continuously monitor influent and effluent pH to ensure that pH values are within an acceptable range before being discharged. All systems must have fail safe automatic shut off switches in the event that pH is not within the acceptable discharge range. Only trained operators may operate manufactured systems. System manufacturers often provide trained operators or training on their devices.

The following procedure may be used when not using a continuous discharge system:

1. Prior to treatment, the appropriate jurisdiction should be notified in accordance with the regulations set by the jurisdiction.
2. Every effort should be made to isolate the potential high pH water in order to treat it separately from other stormwater on-site.
3. Water should be stored in an acceptable storage facility, detention pond, or containment cell prior to treatment.
4. Transfer water to be treated to the treatment structure. Ensure that treatment structure size is sufficient to hold the amount of water that is to be treated. Do not fill tank completely, allow at least 2 feet of freeboard.
5. The operator samples the water for pH and notes the clarity of the water. As a rule of thumb, less CO₂ is necessary for clearer water. This information should be recorded.
6. In the pH adjustment structure, add CO₂ until the pH falls in the range of 6.9-7.1. Remember that pH water quality standards apply so adjusting pH to within 0.2 pH units of receiving water (background pH) is recommended. It is unlikely that pH can be adjusted to within 0.2 pH units using dry ice. Compressed carbon dioxide gas should be introduced to the water using a carbon dioxide diffuser located near

the bottom of the tank, this will allow carbon dioxide to bubble up through the water and diffuse more evenly.

7. Slowly discharge the water making sure water does not get stirred up in the process. Release about 80% of the water from the structure leaving any sludge behind.
8. Discharge treated water through a pond or drainage system.
9. Excess sludge needs to be disposed of properly as concrete waste. If several batches of water are undergoing pH treatment, sludge can be left in treatment structure for the next batch treatment. Dispose of sludge when it fills 50% of tank volume.

Sites that must implement flow control for the developed site must also control stormwater release rates during construction. All treated stormwater must go through a flow control facility before being released to surface waters which require flow control.

Maintenance Standards

Safety and Materials Handling:

- All equipment should be handled in accordance with OSHA rules and regulations.
- Follow manufacturer guidelines for materials handling.

Operator Records:

Each operator should provide:

- A diagram of the monitoring and treatment equipment.
- A description of the pumping rates and capacity the treatment equipment is capable of treating.

Each operator should keep a written record of the following:

- Client name and phone number.
- Date of treatment.
- Weather conditions.
- Project name and location.
- Volume of water treated.
- pH of untreated water.
- Amount of CO₂ needed to adjust water to a pH range of 6.9-7.1.
- pH of treated water.
- Discharge point location and description.

A copy of this record should be given to the client/contractor who should retain the record for three years.

Appendix C – Alternative BMPs

The following includes a list of possible alternative BMPs for each of the 14 elements not described in the main SWPPP text. This list can be referenced in the event a BMP for a specific element is not functioning as designed and an alternative BMP needs to be implemented.

Element #3 - Control Flow Rates

BMP C235: Wattles

Element #4 - Install Sediment Controls

BMP C231: Brush Barrier

BMP C232: Gravel Filter Berm

BMP C234: Vegetated Strip

BMP C235: Wattles

Advanced BMPs:

Element #5 - Stabilize Soils

BMP C122: Nets and Blankets

BMP C124: Sodding

BMP C125: Topsoiling/Composting

BMP C126: Polyacrylamide for Soil Erosion Protecting

BMP C130: Surface Roughening

BMP C131: Gradient Terraces

Element #6 - Protect Slopes

BMP C130: Surface Roughening

BMP C131: Gradient Terraces

BMP C203: Water Bars

BMP C204: Pipe Slope Drains

BMP C205: Subsurface Drains

BMP C206: Level Spreader

BMP C208: Triangular Silt Dike (Geotextile-Encased Check Dam)

Element #8 - Stabilize Channels and Outlets

BMP C122: Nets and Blankets

Element #10 - Control Dewatering

BMP C203: Water Bars

BMP C236: Vegetative Filtration

Appendix D – General Permit

To be added by contractor prior to construction.

Appendix E – Site Inspection Forms (and Site Log)

The results of each inspection shall be summarized in an inspection report or checklist that is entered into or attached to the site log book. It is suggested that the inspection report or checklist be included in this appendix to keep monitoring and inspection information in one document, but this is optional; however, it is mandatory that this SWPPP and the site inspection forms be kept onsite at all times during construction, and that inspections be performed and documented as outlined below.

At a minimum, each inspection report or checklist shall include:

- a. Inspection date/times
- b. Weather information: general conditions during inspection, approximate amount of precipitation since the last inspection, and approximate amount of precipitation within the last 24 hours.
- c. A summary or list of all BMPs that have been implemented, including observations of all erosion/sediment control structures or practices.
- d. The following shall be noted:
 - i. locations of BMPs inspected,
 - ii. locations of BMPs that need maintenance,
 - iii. the reason maintenance is needed,
 - iv. locations of BMPs that failed to operate as designed or intended, and
 - v. locations where additional or different BMPs are needed, and the reason(s) why
- e. A description of stormwater discharged from the site. The presence of suspended sediment, turbid water, discoloration, and/or oil sheen shall be noted, as applicable.
- f. A description of any water quality monitoring performed during inspection, and the results of that monitoring.
- g. General comments and notes, including a brief description of any BMP repairs, maintenance, or installations made as a result of the inspection.
- h. A statement that, in the judgment of the person conducting the site inspection, the site is either in compliance or out of compliance with the terms and conditions of the SWPPP and the NPDES permit. If the site inspection indicates that the site is out of compliance, the inspection report shall include a summary of the remedial actions required to bring the site back into compliance, as well as a schedule of implementation.
- i. Name, title, and signature of person conducting the site inspection; and the following statement: "I certify under penalty of law that this report is true, accurate, and complete, to the best of my knowledge and belief".

When the site inspection indicates that the site is not in compliance with any terms and conditions of the NPDES permit, the Permittee shall take immediate action(s) to: stop, contain, and clean up the unauthorized discharges, or otherwise stop the noncompliance; correct the

problem(s); implement appropriate Best Management Practices (BMPs), and/or conduct maintenance of existing BMPs; and achieve compliance with all applicable standards and permit conditions. In addition, if the noncompliance causes a threat to human health or the environment, the Permittee shall comply with the Noncompliance Notification requirements in Special Condition S5.F of the permit.

Site Inspection Form

General Information

Project Name:	PPSB	Title:	
Inspector Name:	TBD	CESCL # :	
Date:		Time:	
Inspection Type:	<input type="checkbox"/> After a rain event <input type="checkbox"/> Weekly <input type="checkbox"/> Turbidity/transparency benchmark exceedance <input type="checkbox"/> Other		

Weather

Precipitation	Since last inspection	In last 24 hours
Description of General Site Conditions:		

Inspection of BMPs

Element 1: Mark Clearing Limits

BMP:

Location	Inspected		Functioning			Problem/Corrective Action
	Y	N	Y	N	NIP	

BMP:

Location	Inspected		Functioning			Problem/Corrective Action
	Y	N	Y	N	NIP	

Element 2: Establish Construction Access

BMP:

Location	Inspected		Functioning			Problem/Corrective Action
	Y	N	Y	N	NIP	

BMP:

Location	Inspected		Functioning			Problem/Corrective Action
	Y	N	Y	N	NIP	

Element 3: Control Flow Rates

BMP:

Location	Inspected		Functioning			Problem/Corrective Action
	Y	N	Y	N	NIP	

BMP:

Location	Inspected		Functioning			Problem/Corrective Action
	Y	N	Y	N	NIP	

Element 4: Install Sediment Controls

BMP:

Location	Inspected		Functioning			Problem/Corrective Action
	Y	N	Y	N	NIP	

BMP:

Location	Inspected		Functioning			Problem/Corrective Action
	Y	N	Y	N	NIP	

BMP:

Location	Inspected		Functioning			Problem/Corrective Action
	Y	N	Y	N	NIP	

BMP:

Location	Inspected		Functioning			Problem/Corrective Action
	Y	N	Y	N	NIP	

BMP:

Location	Inspected		Functioning			Problem/Corrective Action
	Y	N	Y	N	NIP	

Element 5: Stabilize Soils

BMP:

Location	Inspected		Functioning			Problem/Corrective Action
	Y	N	Y	N	NIP	

BMP:

Location	Inspected		Functioning			Problem/Corrective Action
	Y	N	Y	N	NIP	

BMP:

Location	Inspected		Functioning			Problem/Corrective Action
	Y	N	Y	N	NIP	

BMP:

Location	Inspected		Functioning			Problem/Corrective Action
	Y	N	Y	N	NIP	

Element 6: Protect Slopes

BMP:

Location	Inspected		Functioning			Problem/Corrective Action
	Y	N	Y	N	NIP	

BMP:

Location	Inspected		Functioning			Problem/Corrective Action
	Y	N	Y	N	NIP	

BMP:

Location	Inspected		Functioning			Problem/Corrective Action
	Y	N	Y	N	NIP	

Element 7: Protect Drain Inlets

BMP:

Location	Inspected		Functioning			Problem/Corrective Action
	Y	N	Y	N	NIP	

BMP:

Location	Inspected		Functioning			Problem/Corrective Action
	Y	N	Y	N	NIP	

BMP:

Location	Inspected		Functioning			Problem/Corrective Action
	Y	N	Y	N	NIP	

Element 8: Stabilize Channels and Outlets

BMP:

Location	Inspected		Functioning			Problem/Corrective Action
	Y	N	Y	N	NIP	

BMP:

Location	Inspected		Functioning			Problem/Corrective Action
	Y	N	Y	N	NIP	

BMP:

Location	Inspected		Functioning			Problem/Corrective Action
	Y	N	Y	N	NIP	

BMP:

Location	Inspected		Functioning			Problem/Corrective Action
	Y	N	Y	N	NIP	

Element 9: Control Pollutants

BMP:

Location	Inspected			Functioning			Problem/Corrective Action
	Y	N		Y	N	NIP	

BMP:

Location	Inspected			Functioning			Problem/Corrective Action
	Y	N		Y	N	NIP	

Element 10: Control Dewatering

BMP:

Location	Inspected			Functioning			Problem/Corrective Action
	Y	N		Y	N	NIP	

BMP:

Location	Inspected			Functioning			Problem/Corrective Action
	Y	N		Y	N	NIP	

BMP:

Location	Inspected			Functioning			Problem/Corrective Action
	Y	N		Y	N	NIP	

Stormwater Discharges From the Site			
Location	Observed?	Problem/Corrective Action	
		Y	N
Turbidity			
Discoloration			
Sheen			
Location			
Turbidity			
Discoloration			
Sheen			

Water Quality Monitoring

Was any water quality monitoring conducted? Yes No

If water quality monitoring was conducted, record results here:

If water quality monitoring indicated turbidity 250 NTU or greater; or transparency 6 cm or less, was Ecology notified by phone within 24 hrs?

Yes No

If Ecology was notified, indicate the date, time, contact name and phone number below:

Date:

Time:

Contact Name:

Phone #:

General Comments and Notes

Include BMP repairs, maintenance, or installations made as a result of the inspection.

Were Photos Taken? Yes No

If photos taken, describe photos below:

Appendix F – Engineering Calculations

To be updated as required

APPENDIX D



BARGHAUSEN
A DIVISION OF CORE STATES GROUP

**CORE
STATES**

Operations & Maintenance Manual

Puyallup Public Safety Building

PREPARED BY
Kaleb Mapstead

PREPARED FOR

Benaroya Capital, LLC

CLIENT ADDRESS

9675 SE 36th Avenue, Suite 115
Mercer Island, WA 98040

SITE ADDRESS

1015 39th Avenue SE
Puyallup, Washington
98374

PROJECT NO.

23796

DATE

02/26/2025

JURISDICTION

City of Puyallup

1.0 SITE ADDRESS

The site is located at 1015 39th Avenue SE within the City of Puyallup, Washington and encompasses tax parcel 0419034038.

2.0 INTRODUCTION

The site has a drainage system that needs periodic maintenance in order to function properly. This report describes the storm drainage system and delineates operation and maintenance responsibilities and requirements for the site.

The design of the drainage facilities discussed in this manual can be found in the Puyallup Public Safety Building project construction drawings and stormwater site plan on file with the City of Puyallup.

The entire site is approximately 77 acres in size. The purpose of this manual is to address maintenance of stormwater facilities installed with the construction of the project. These facilities are intended to retain stormwater runoff from the redeveloped portion of the site of approximately 0.23 acres in size. Runoff on the project site is sent to the existing storm water retention pond via underground pipes.

3.0 PLAN GOAL

The specific purpose of the stormwater facilities present on this project is to collect and retain runoff on the site.

4.0 MAINTENANCE AND OPERATIONAL RESPONSIBILITIES

Owners/Tenants have the following Operations and Maintenance responsibilities, which include:

- I. Inspection and maintenance of all on-site drainage facility components (storm manholes, pipes, detention vault) at least twice annually:
 - A. Remove accumulated sediment and debris from all pipes, structures, and retention pondt (any debris and/or sediment collected shall be disposed of in accordance with applicable State and Federal requirements).
 - B. Inspect and repair any damage, including; cracks, unsealed joints and pipes that deviate from their design shape
 - C. Maintain access points including manhole hole lids, grates and ladders
 - D. Debris and leaves shall be removed from catch basin grates
 - E. General site surroundings:
 - 1) Maintaining good housekeeping practices on the site will reduce the amount of trash, debris, and sediment that reaches the storm system.
 - 2) The owner, tenants and anyone doing landscaping on the property must be careful to avoid introducing landscape fertilizer to receiving waters or groundwater.

5.0 REPORTING

The above maintenance activities will be documented each year and kept in a log book. Maintenance logs shall be made available to the City of Puyallup upon request. This manual and the logs should be kept on-site, preferably in an office belonging to the person tasked with ensuring the system is function as intended.

6.0 RESPONSIBLE PARTY/ORGANIZATION

Benaroya Capital LLC
9675 36th Street, Suite 115
Bellevue, WA 98040

Access Road/Easement			
Drainage System Feature	Potential Defect	Conditions When Maintenance Is Needed	Minimum Performance Standard
General	Erosion	Soils are bare or eroded.	Erosion repaired and soils have been protected (through seeding/matting/etc.).
	Road Surface	Condition of road surface may lead to erosion of the facility or limit access.	Road repaired, repaved, or resurfaced to restore access.
	Erosion of Ground Surface	Noticeable rills are seen in landscaped areas.	Eroded areas are filled, contoured, and seeded. Affected areas regraded as necessary. Steps have been taken to eliminate source of erosion (dispersing flows, energy dissipation, etc.).
	Trash & Debris / Litter	Litter accumulation exceeds 1 cubic foot per 1,000 square feet.	No trash or debris present.
	Poisonous Plants and Noxious weeds	Any poisonous plants or nuisance vegetation which may constitute a hazard to maintenance personnel or the public. Any evidence of noxious weeds as defined by State or local regulations.	Eradication of Class A weeds as required by State law. Control of other listed weeds as directed by local policy. Apply requirements of adopted IMP plan for use of herbicides.
	Tree Growth and Hazard Trees		Tree growth does not allow maintenance access or interferes with maintenance activity (i.e., slope mowing, silt removal, vacuuming, or equipment movements). If trees are not interfering with access or maintenance, do not remove. If dead, diseased, or dying trees are identified. (Use a certified Arborist to determine health of tree or removal requirements.)
Trees or shrubs that have been blown down or knocked over.			Tree and shrub debris has been removed and disposed of.
	Weeds (Nonpoisonous)	Weeds growing in more than 20% of the landscaped area (trees and shrubs only).	Weeds present in less than 5% of the landscaped area.
	Insects	When insects such as wasps and hornets interfere with maintenance activities.	Insects destroyed or removed from site. Apply insecticides in compliance with adopted IPM Plan.

Catch Basin			
Drainage System Feature	Potential Defect	Conditions When Maintenance Is Needed	Minimum Performance Standard
Note: table spans multiple pages.			
General	Trash and Debris	Trash or debris which is located immediately in front of the catch basin opening or is blocking inletting capacity of the basin by more than 10%.	No trash or debris located immediately in front of catch basin or on grate opening.
		Trash or debris (in the basin) that exceeds 60 percent of the sump depth as measured from the bottom of basin to invert of the lowest pipe into or out of the basin, but in no case less than a minimum of six inches clearance from the debris surface to the invert of the lowest pipe.	No trash or debris in the catch basin.
		Trash or debris in any inlet or outlet pipe blocking more than 1/3 of its height.	Inlet and outlet pipes free of trash or debris.
		Dead animals or vegetation that could generate odors that could cause complaints or dangerous gases (e.g., methane).	No dead animals or vegetation present within the catch basin.
	Sediment	Sediment (in the basin) that exceeds 60 percent of the sump depth as measured from the bottom of basin to invert of the lowest pipe into or out of the basin, but in no case less than a minimum of 6 inches clearance from the sediment surface to the invert of the lowest pipe.	No sediment in the catch basin.
	Structure Damage to Frame and/or Top Slab	Top slab has holes larger than 2 square inches or cracks wider than 1/4 inch. (Intent is to make sure no material is running into basin.)	Top slab is free of holes and cracks.
		Frame not sitting flush on top slab, i.e., separation of more than 3/4 inch of the frame from the top slab. Frame not securely attached.	Frame is sitting flush on the riser rings or top slab and firmly attached.
	Fractures or Cracks in	Maintenance person judges that structure is unsound.	Basin replaced or repaired to design standards.

Catch Basin			
Drainage System Feature	Potential Defect	Conditions When Maintenance Is Needed	Minimum Performance Standard
	Basin Walls/ Bottom	Grout fillet has separated or cracked wider than 1/2 inch and longer than 1 foot at the joint of any inlet/outlet pipe or any evidence of soil particles entering catch basin through cracks.	Pipe is regouted and secure at basin wall.
	Settlement/ Misalignment	Catch basin has settled more than 1 inch or has rotated more than 2 inches out of alignment.	Basin replaced or repaired to design standards.
	Vegetation Inhibiting System	Vegetation growing across and blocking more than 10% of the basin opening.	No vegetation blocking opening to basin.
		Vegetation growing in inlet/outlet pipe joints that is more than six inches tall and less than six inches apart.	No vegetation or root growth present.
	Contaminants and Pollution	Any evidence of oil, gasoline, contaminants, or other pollutants. Sheen, obvious oil, or other contaminants present. • Identify and remove source	No contaminants or pollutants present.
Catch Basin Cover	Cover Not in Place	Cover is missing or only partially in place. Any open catch basin requires maintenance.	Catch basin cover is closed.
	Locking Mechanism Not Working	Mechanism cannot be opened by one maintenance person with proper tools. Bolts into frame have less than 1/2 inch of thread. One or more bolts are missing.	Mechanism opens with proper tools. All bolts are seated and no bolts are missing. Cover is secure.
	Cover Difficult to Remove	One maintenance person cannot remove lid after applying normal lifting pressure (Intent is to keep cover from sealing off access to maintenance).	Cover can be removed by one maintenance person.
Metal Grates (If Applicable)	Grate Opening Unsafe	Grate with opening wider than 7/8 inch.	Grate opening meets design standards.
	Trash and Debris	Trash and debris that is blocking more than 20% of grate surface inletting capacity.	Grate free of trash and debris.
	Damaged or Missing	Grate missing or broken member(s) of the grate.	Grate is in place and meets design standards.
Oil/Debris Trap (If Applicable)	Dislodged	Oil or debris trap is misaligned with or dislodged from the outlet pipe.	Trap is connected to and aligned with outlet pipe.

Compost-Amended Soil			
Drainage System Feature	Potential Defect	Conditions When Maintenance Is Needed	Minimum Performance Standard
Soil Media	Soils Waterlogged or Not Infiltrating	Soils become waterlogged, or otherwise do not appear to be infiltrating.	Soils have been aerated or amended such that infiltration occurs and soils to not remain completely saturated, per design specifications.
	Erosion/Scouring	Areas of potential erosion are visible, such as gullies or scouring.	Any eroded areas have been repaired, and sources of erosion addressed to prevent further soil erosion.
Vegetation	Vegetation in Poor Health	Less than 75% of planted vegetation is healthy with a generally good appearance.	At least 75% of planted vegetation is healthy with generally good appearance. Any conditions found that were deleterious to plant health have been corrected where possible. Routine maintenance schedule has been updated as necessary to ensure continued plant health and satisfactory appearance.
	Poisonous Plants and Noxious Weeds	Any poisonous plants or nuisance vegetation which may constitute a hazard to maintenance personnel or the public. Any evidence of noxious weeds as defined by State or local regulations.	No danger of poisonous vegetation where maintenance personnel or the public might normally be. Eradication of Class A weeds as required by State law. Control of other listed weeds as directed by local policies. Apply requirements of adopted IPM policy for the use of herbicides.
	Other Weeds Present	Other weeds (not listed on City/State noxious weed lists) are present on site.	Weeds have been removed per the routine maintenance schedule, following IPM protocols.

Conveyance Pipe

Drainage System Feature	Potential Defect	Conditions When Maintenance Is Needed	Minimum Performance Standard
General	Contaminants and Pollution	Any evidence of oil, gasoline, contaminants, or other pollutants. Sheen, obvious oil, or other contaminants present. <ul style="list-style-type: none"> Identify and remove source. 	No contaminants or pollutants present.
	Obstructions, Including Roots	Root enters or deforms pipe, reducing flow.	Roots have been removed from pipe (using mechanical methods; do not put root-dissolving chemicals in storm sewer pipes). If necessary, vegetation over the line removed.
	Sediment and Debris	Sediment depth is greater than 20% of pipe diameter.	Pipe has been cleaned and is free of sediment/ debris. (Upstream debris traps installed where applicable.)
	Debris Barrier or Trash Rack Missing	Stormwater pipes > than 18 inches need debris barrier.	Debris barrier present on all stormwater pipes 18 inches and greater.
	Damage to protective coating or corrosion	Protective coating is damaged; rust or corrosion is weakening the structural integrity of any part of pipe.	Pipe repaired or replaced.
	Damaged	Any dent that decreases the cross section area of pipe by more than 20% or is determined to have weakened structural integrity of the pipe.	Pipe repaired or replaced.

Debris Barrier			
Drainage System Feature	Potential Defect	Conditions When Maintenance Is Needed	Minimum Performance Standard
General	Trash and Debris	Trash or debris that is plugging more than 20% of the openings in the barrier.	Barrier cleared to design flow capacity.
	Damaged/ Missing Bars	Bars are bent out of shape more than 3 inches.	Bars in place with no bends more than 3/4 inch.
		Bars are missing or entire barrier missing.	Bars in place according to design specifications.
		Bars are loose and rust is causing 50% deterioration to any part of barrier.	Barrier replaced or repaired to design specifications.
	Missing or Damaged Debris Barrier	Debris barrier missing or not attached to inlet/ outlet pipe.	Barrier is in place and firmly attached to pipe.

Downspout Splash Block			
Drainage System Feature	Potential Defect	Conditions When Maintenance Is Needed	Minimum Performance Standard
Note: table spans multiple pages.			
General	Pests	Signs of pest infestations (IPM protocol threshold(s) are exceeded), including rodent holes or mounds that disturb dispersion flow paths.	Pests are not present or engaged in activities that present a significant public health risk or compromise to the intended design function of the facility. Pests that have exceeded acceptable thresholds have been addressed using appropriate IPM measures.
	Inspection Frequency	Annually and after large storms.	Rain harvesting equipment is functioning normally.
Splash Block	Water Directed Towards Building	Water is being directed towards building structure.	Water is directed away from foundations and other building structures.
	Downspout water misdirected	Water coming from the downspout is not discharging to the dispersal area.	Water is discharging normally to the dispersal area.
	Dislodged	Splash block moved from outlet of downspout.	Splash block correctly positioned to catch discharge from downspout.
	Trash and Debris	Trash and debris accumulated on the splash block.	Splash block site free of any trash or debris.
	Erosion	Water coming off the splash block causing erosion.	
Water disrupts soil media.			Water is dispersed into soil/mulch/plantings in a manner that does not create erosion or other issues due to concentrated flows.

Energy Dissipaters			
Drainage System Feature	Potential Defect	Conditions When Maintenance Is Needed	Minimum Performance Standard
	Collapsed or Deformed Baskets	Gabion basket shape deformed due to any cause.	All gabion baskets intact, structure stands as designed.
	Missing Rock	Any rock missing that could cause gabion to lose structural integrity.	No rock missing.
Internal:			
Manhole/ Chamber	Worn or Damaged Post, Baffles, Side of Chamber	Structure dissipating flow deteriorates to 1/2 of original size or any concentrated worn spot exceeding one square foot which would make structure unsound.	Structure replaced to design standards.

Fencing/Gates/Bollards/Water Quality Sign			
Drainage System Feature	Potential Defect	Conditions When Maintenance Is Needed	Minimum Performance Standard
Fencing (Site)	Site erosion or holes under fence	Erosion or holes more than 4 inches high and 12-18 inches wide permitting access through an opening under a fence.	No access under the fence.
Fencing (Wood Posts, Boards, and Cross Members)	Missing or damaged parts	Missing or broken boards, post out of plumb by more than 6 inches or cross members broken	No gaps on fence due to missing or broken boards, post plumb to within 1½ inches, cross members sound.
	Weakened by rotting or insects	Any part showing structural deterioration due to rotting or insect damage	All parts of fence are structurally sound.
	Damaged or failed post foundation	Concrete or metal attachments deteriorated or unable to support posts.	Post foundation capable of supporting posts even in strong wind.
Fencing (Metal Posts, Rails, and Fabric)	Damaged parts	Post out of plumb more than 6 inches.	Post plumb to within 1½ inches.
		Top rails bent more than 6 inches.	Top rail free of bends greater than 1 inch.
		Any part of fence (including post, top rails, and fabric) more than 1 foot out of design alignment.	Fence is aligned and meets design standards.
		Missing or loose tension wire.	Tension wire in place and holding fabric.
	Deteriorated paint or protective coating	Part or parts that have a rusting or scaling condition that has affected structural adequacy.	Structurally adequate posts or parts with a uniform protective coating.
	Openings in fabric	Openings in fabric are such that an 8-inch diameter ball could fit through.	Fabric mesh openings within 50% of grid size.
Chain Link Fencing Gate	Damaged or missing members	Missing gate.	Gates in place.
		Broken or missing hinges such that gate cannot be easily opened and closed by a maintenance person.	Hinges intact and lubed. Gate is working freely.
		Gate is out of plumb more than 6 inches and more than 1 foot out of design alignment.	Gate is aligned and vertical.
		Missing stretcher bar, stretcher bands, and ties.	Stretcher bar, bands, and ties in place.
	Locking mechanism does not lock gate	Locking device missing, non-functioning or does not link to all parts.	Locking mechanism prevents opening of gate.
	Openings in fabric	Openings in fabric are such that an 8-inch diameter ball could fit through.	Fabric mesh openings within 50% of grid size.

Fencing/Gates/Bollards/Water Quality Sign			
Drainage System Feature	Potential Defect	Conditions When Maintenance Is Needed	Minimum Performance Standard
Bollards	Damaged or missing	Bollard broken, missing, does not fit into support hole or hinge broken or missing.	No access for motorized vehicles to get into facility.
	Does not lock	Locking assembly or lock missing or cannot be attached to lock bollard in place.	No access for motorized vehicles to get into facility.
Water Quality Sign	Sign is Damaged or Missing	Water quality sign is leaning more than 8 inches off vertical.	Sign reset to plumb.
		Water quality sign is missing or 20% of the surface is unreadable.	Sign replaced.

Grounds (Landscaping)			
Drainage System Feature	Potential Defect	Conditions When Maintenance Is Needed	Minimum Performance Standard
Site	Trash or litter	Any trash and debris which exceed 1 cubic foot per 1,000 square feet (this is about equal to the amount of trash it would take to fill up one standard size office garbage can). In general, there should be no visual evidence of dumping.	Trash and debris cleared from site.
	Noxious weeds	Any noxious or nuisance vegetation which may constitute a hazard to County personnel or the public.	Noxious and nuisance vegetation removed according to applicable regulations. No danger of noxious vegetation where County personnel or the public might normally be.
	Contaminants and pollution	Any evidence of contaminants or pollution such as oil, gasoline, concrete slurries or paint.	Materials removed and disposed of according to applicable regulations. Source control BMPs implemented if appropriate. No contaminants present other than a surface oil film.
	Grass/groundcover	Grass or groundcover exceeds 18 inches in height.	Grass or groundcover mowed to a height no greater than 6 inches.
Trees and Shrubs	Hazard	Any tree or limb of a tree identified as having a potential to fall and cause property damage or threaten human life. A hazard tree identified by a qualified arborist must be removed as soon as possible.	No hazard trees in facility.
	Damaged	Limbs or parts of trees or shrubs that are split or broken which affect more than 25% of the total foliage of the tree or shrub.	Trees and shrubs with less than 5% of total foliage with split or broken limbs.
		Trees or shrubs that have been blown down or knocked over.	No blown down vegetation or knocked over vegetation. Trees or shrubs free of injury.
	Trees or shrubs which are not adequately supported or are leaning over, causing exposure of the roots.	Tree or shrub in place and adequately supported; dead or diseased trees removed.	

Infiltration Basin			
Drainage System Feature	Potential Defect	Conditions When Maintenance Is Needed	Minimum Performance Standard
Note: table spans multiple pages.			
General	Trash and Debris	<p>Any trash and debris which exceed 1 cubic foot per 1,000 square feet. In general, there should be no visual evidence of dumping.</p> <p>If less than threshold all trash and debris will be removed as part of next scheduled maintenance.</p>	Site is free of trash and debris.
	Poisonous Plants and Noxious Weeds	<p>Any poisonous or nuisance vegetation which may constitute a hazard to maintenance personnel or the public.</p> <p>Any evidence of noxious weeds as defined by State or local regulations.</p> <p>(Apply requirements of adopted IPM policies for the use of herbicides.)</p>	<p>No danger of poisonous vegetation where maintenance personnel or the public might normally be.</p> <p>Complete eradication of noxious weeds may not be possible. Compliance with State or local eradication policies required.</p>
	Contaminants and Pollution	<p>Any evidence of oil, gasoline, contaminants, or other pollutants.</p> <p>(Coordinate removal/cleanup with local water quality response agency.)</p>	No contaminants or pollutants present.
	Rodent Holes	Any evidence of rodent holes if facility is acting as a dam or berm, or any evidence of water piping through dam or berm via rodent holes.	Rodents destroyed and dam or berm repaired.
Storage Area	Sediment Reducing Infiltration Rate	<p>Water ponding in infiltration pond after rainfall ceases and appropriate time allowed for infiltration. Treatment basins should infiltrate Water Quality Design Storm Volume within 48 hours, and empty within 24 hours after cessation of most rain events.</p> <p>(A percolation test pit or test of facility indicates facility is only working at 90% of its designed capabilities. Test every 2 to 5 years. If two inches or more sediment is present, remove.)</p>	Sediment is removed and/or facility is cleaned so that infiltration system works according design standards.
Filter Bags (If Applicable)	Filled with Sediment and Debris	Sediment and debris fill bag more than 1/2 full.	Filter bag has been replaced or system is redesigned.
Rock Filters	Sediment and Debris	By visual inspection, little or no water flows through filter during heavy rain storms.	Gravel in rock filter is replaced.

Infiltration Basin			
Drainage System Feature	Potential Defect	Conditions When Maintenance Is Needed	Minimum Performance Standard
Note: table spans multiple pages.			
Side Slopes of Pond	Erosion	<p>Eroded damage over 2 inches deep where cause of damage is still present or where there is potential for continued erosion.</p> <p>Any erosion observed on a compacted berm embankment.</p>	<p>Slopes have been stabilized using appropriate erosion control measure(s), e.g., rock reinforcement, planting of grass, compaction.</p> <p>If erosion is occurring on compacted berms a licensed civil engineer should be consulted to resolve source of erosion.</p>
Pond Berms (Dikes)	Settlement	Any part of berm which has settled 4 inches lower than the design elevation.	Dike has been built back to the design elevation.
		If settlement is apparent, measure berm to determine amount of settlement.	
		Settling can be an indication of more severe problems with the berm or outlet works. A licensed civil engineer should be consulted to determine the source of the settlement.	
	Tree Growth	Tree growth on berms over 4 feet in height may lead to piping through the berm which could lead to failure of the berm.	
Piping	Discernible water flow through pond berm. Ongoing erosion with potential for erosion to continue.	(Recommend a Geotechnical engineer be called in to inspect and evaluate condition and recommend repair of condition.)	Piping eliminated. Erosion potential resolved.

Infiltration Basin			
Drainage System Feature	Potential Defect	Conditions When Maintenance Is Needed	Minimum Performance Standard
Emergency Overflow/ Spillway	Tree Growth	Tree growth on emergency spillways creates blockage problems and may cause failure of the berm due to uncontrolled overtopping.	Trees removed. If root system is small (base less than 4 inches) the root system may be left in place. Otherwise the roots should be removed and the berm restored. A licensed civil engineer should be consulted for proper berm/spillway restoration.
	Rock Missing	Only one layer of rock exists above native soil in area five square feet or larger, or any exposure of native soil at the top of flow path of spillway. (Rip-rap on inside slopes need not be replaced.)	Rocks and pad depth are restored to design standards.
	Erosion	Eroded damage over 2 inches deep where cause of damage is still present or where there is potential for continued erosion. Any erosion observed on a compacted berm embankment.	Slopes have been stabilized using appropriate erosion control measure(s), e.g., rock reinforcement, planting of grass, compaction. If erosion is occurring on compacted berms a licensed civil engineer should be consulted to resolve source of erosion.
Presettling Ponds and Vaults	Facility or Sump Filled With Sediment and/or Debris	6" or designed sediment trap depth of sediment.	Sediment is removed.

APPENDIX E

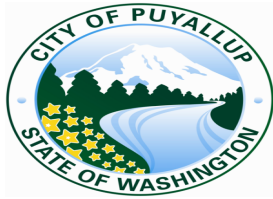

**CITY OF PUYALLUP
ENGINEERING SERVICES
ESTIMATE OF COST**

ON-SITE

DATE: 2/26/2025 **ESTIMATOR:** Kaleb Mapstead
PROJECT NAME & LOCATION: Puyallup Public Safety Building **TELEPHONE #:** 425-251-6222
1015 39TH AVENUE SE, PUYALLUP, WA 98374-2121

STREET	UNIT	UNIT COST	PLAN QUANTITY	TOTAL
6" CURB & 18" GUTTER	LF	\$19.00	0	0.00
DRIVE APPROACH	SY	\$55.00	0	0.00
SIDEWALK	SY	\$35.00	0	0.00
WHEEL CHAIR RAMP	LS	\$2,800.00	0	0.00
MONUMENT	EA	\$650.00	0	0.00
STREET SIGN	EA	\$280.00	0	0.00
WARNING SIGN	EA	\$230.00	0	0.00
PERMANENT BARRICADE	EA	\$850.00	0	0.00
STREET LIGHT	EA	\$5,500.00	0	0.00
METER BASE AND PANEL FOR ST LT	EA	\$13,200.00	0	0.00
ROADWAY EXCAVATION / HAUL	CY	\$35.00	0	0.00
GRAVEL BASE	TON	\$25.00	0	0.00
TOP COURSE	TON	\$30.00	0	0.00
CLASS B ASPHALT CONCRETE	TON	\$95.00	0	0.00
RAISE M.H. / VALVE BOX TO GRAD	EA	\$425.00	0	0.00
ROUGH GRADING	CY	\$3.00	0	0.00
RIP RAP	TON	\$20.00	0	0.00
MISC. ITEMS				0.00
MISC. ITEMS				0.00
STORM DRAINAGE				0.00
48" STORM SEWER MANHOLE	EA	\$3,605.00	0	0.00
54" STORM SEWER MANHOLE	EA	\$4,265.00	0	0.00
60" STORM SEWER MANHOLE	EA	\$5,075.00	0	0.00
72" STORM SEWER MANHOLE	EA	\$7,615.00	0	0.00
84" STORM SEWER MANHOLE	EA	\$10,150.00	0	0.00
96" STORM SEWER MANHOLE	EA	\$14,720.00	0	0.00
FLOW CONTROL MANHOLE	EA	\$4,900.00	0	0.00
CATCH BASIN TYPE I	EA	\$1,800.00	1	1,800.00
CATCH BASIN TYPE II	EA	\$3,550.00	1	3,550.00
12" PVC	LF	\$65.00	231	15,015.00
18" PVC	LF	\$85.00	0	0.00
21" PVC	LF	\$100.00	0	0.00
24" PVC	LF	\$125.00	0	0.00
30" PVC	LF	\$150.00	0	0.00
36" RCP	LF	\$275.00	0	0.00
42" RCP	LF	\$350.00	0	0.00
48" RCP	LF	\$440.00	0	0.00
BIOSWALE / DETENTION POND	CF	\$2.00	0	0.00
COMPOST / COALESCE FILTER	LF	\$7.70	0	0.00
EROSION CONTROL	SF	\$0.50	13100	6,550.00
SITE STABILIZATION	SF	\$1.70	13100	22,270.00
8" D.I.P.	LF	\$85.00	0	0.00
MISC. ITEMS				0.00

WATER	UNIT	UNIT COST	PLAN QUANTITY	TOTAL
3/4" WATER SERVICE / METER	EA	\$850.00	0	0.00
1" WATER SERVICE / METER	EA	\$1,000.00	0	0.00
1 1/2" WATER SERVICE / METER	EA	\$1,430.00	0	0.00
2" WATER SERVICE / METER	EA	\$2,000.00	0	0.00
FIRE HYDRANT ASSEMBLY	EA	\$3,400.00	0	0.00
2' BLOW OFF ASSEMBLY	EA	\$2,080.00	0	0.00
8" GATE VALVE	EA	\$820.00	0	0.00
10" BUTTERFLY VALVE	EA	\$1,300.00	0	0.00
12" BUTTERFLY VALVE	EA	\$1,500.00	0	0.00
AIR RELIEF VALVE	EA	\$2,400.00	0	0.00
8" D.I.P.	LF	\$85.00	0	0.00
10" D.I.P.	LF	\$100.00	0	0.00
12" D.I.P.	LF	\$115.00	0	0.00
16" D.I.P.	LF	\$145.00	0	0.00
2" DOUBLE CHECK ASSEMBLY	EA	\$1,950.00	0	0.00
2" REDUCED PRESSURE ASSEMBLY	EA	\$1,625.00	0	0.00
2" DOUBLE DETECTOR CHECK	EA	\$1,625.00	0	0.00
ADJUST WM TO GRADE	EA	\$500.00	0	0.00
MISC. ITEMS			0	0.00
SANITARY				0.00
SANITARY SEWER MANHOLE	EA	\$4,000.00	0	0.00
DROP MANHOLE	EA	\$5,000.00	0	0.00
TERMINAL CLEAN OUT	EA	\$425.00	0	0.00
SIDE SEWER	LF	\$60.00	0	0.00
8" SANITARY PVC	LF	\$70.00	0	0.00
10" SANITARY PVC	LF	\$75.00	0	0.00
12" SANITARY PVC	LF	\$90.00	0	0.00
18" SANITARY PVC	LF	\$100.00	0	0.00
GREASE INTERCEPTOR	GALLON	\$6.90	0	0.00
MISC. ITEMS			0	0.00
RETAINING WALLS				0.00
ROCK RETAINING WALL	S.Y./FACE	\$250.00	0	0.00
POURED IN PLACE RETAINING WALL	S.Y./FACE	\$250.00	0	0.00
KEYSTONE WALL	S.F./FACE	\$35.00	0	0.00
ECOLOGY BLOCK WALL	S.F./FACE	\$120.00	0	0.00
MISCELLANEOUS				0.00
RELOCATE POWER POLE/TRANSFORMER			0	0.00
PRIVATE UTILITY TRENCHING	FT	\$3.00	0	0.00
MISC. ITEMS			0	0.00
MISC. ITEMS			0	0.00
MISC. ITEMS			0	0.00
MISC. ITEMS			0	0.00
			TOTAL	49,185.00
			20%CONTINGENCY	9,837.00
			GRAND TOTAL	59,022.00