



Construction Stormwater Pollution Prevention Plan

PREPARED FOR:

Integrus Architecture
Contact: Sarah Wilder
117 South Main Street, Suite 100
Seattle, WA 98104

PROJECT:

Pierce College Puyallup
New STEM Building
Puyallup, WA
2210810.10

PREPARED BY:

Claire Hovde
Project Engineer

REVIEWED BY:

William J. Fierst, PE
Principal

DATE:

May 2022
Revised August 2022

Construction Stormwater Pollution Prevention Plan

PREPARED FOR:

Integrus Architecture
Contact: Sarah Wilder
117 South Main Street, Suite 100
Seattle, WA 98104

PROJECT:

Pierce College Puyallup
New STEM Building
Puyallup, WA
2210810.10

PREPARED BY:

Claire Hovde
Project Engineer

REVIEWED BY:

William J. Fierst, PE
Principal

DATE:

May 2022
Revised August 2022

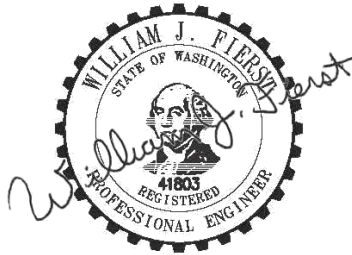

08/18/2022

I hereby state that this [Construction Stormwater Pollution Prevention Plan](#) for the [Pierce College Puyallup New STEM Building](#) project has been prepared by me or under my supervision and meets the standard of care and expertise that is usual and customary in this community for professional engineers. I understand that [City of Puyallup](#) does not and will not assume liability for the sufficiency, suitability, or performance of drainage facilities prepared by me.

Table of Contents

Section	Page
1.0 Introduction.....	1
2.0 Project Description	2
3.0 Existing Site Conditions	2
4.0 Adjacent Areas and Drainage.....	2
5.0 Critical Areas.....	3
6.0 Soils.....	3
7.0 Potential Erosion Problems.....	3
8.0 Construction Stormwater Pollution Prevention Elements	3
8.1 Mark Clearing Limits.....	3
8.2 Establish Construction Access.....	3
8.3 Control Flow Rates	3
8.4 Install Sediment Controls.....	4
8.5 Stabilize Soils	4
8.6 Protect Slopes.....	4
8.7 Protect Drain Inlets	4
8.8 Stabilize Channels and Outlets.....	4
8.9 Control Pollutants	4
8.9.1 Required BMPs.....	6
8.10 Control Dewatering.....	6
8.11 Maintain BMPs	6
8.12 Manage the Project	7
9.0 Construction Sequence and Phasing	7
9.1 Construction Sequence	7
9.2 Construction Phasing.....	8
10.0 Construction Schedule.....	8
11.0 Financial/Ownership Responsibilities.....	8
12.0 Certified Erosion and Sediment Control Lead (CESCL).....	8



Appendix

Appendix A

Exhibits

- A-1 Vicinity Map
- A-2 NRCS Soils Map
- A-3 FEMA Flood Map

Appendix B

Inspection Logs

Appendix C

Best Management Practices (BMPs)

- BMP C103..... High Visibility Fence
- BMP C105..... Stabilized Construction Entrance
- BMP C120..... Temporary and Permanent Seeding
- BMP C121..... Mulching
- BMP C123..... Plastic Covering
- BMP C140..... Dust Control
- BMP C151..... Concrete Handling
- BMP C152..... Sawcutting and Surface Pollution Prevention
- BMP C160..... Certified Erosion and Sediment Control Lead
- BMP C200..... Interceptor Dike and Swale
- BMP C201..... Grass-Lined Channels
- BMP C207..... Check Dams
- BMP C209..... Outlet Protection
- BMP C220..... Storm Drain Inlet Protection
- BMP C233..... Silt Fence
- BMP C241..... Temporary Sediment Pond

Appendix D

TESC Calculations

1.0 Introduction

In 1972, Congress passed the Federal Water Pollution Control Act (FWPCA), also known as the Clean Water Act (CWA), to restore and maintain the quality of the nation's waterways. The ultimate goal was to ensure rivers and streams were fishable, swimmable, and drinkable. In 1987, the Water Quality Act (WQA) added provisions to the CWA that allowed the Environmental Protection Agency to govern stormwater discharges from construction sites. The National Pollutant Discharge Elimination System (NPDES) General Permit includes provisions for development of a Stormwater Pollution Prevention Plan (SWPPP) to maximize the potential benefits of pollution prevention and sediment and erosion control measures at construction sites.

The proposed project will disturb more than 1 acre of area, and therefore is required to obtain an NPDES General Permit for Stormwater Associated with Construction Activities.

The 2019 Department of Ecology (DOE) *Stormwater Management Manual for Western Washington (SWMMWW)* requires a Construction SWPPP for projects that add or replace more than 2,000 square feet of impervious surfaces. The proposed project will exceed this threshold; therefore, a Construction SWPPP is required.

Development, implementation, and maintenance of the Construction SWPPP will provide the selected General Contractor with the framework for reducing soil erosion and minimizing pollutants in stormwater during construction of the proposed project. The Construction SWPPP will:

- Define the characteristics of the site and the type of construction that will occur.
- Describe the practices that will be implemented to control erosion and the release of pollutants in stormwater.
- Create an implementation schedule to ensure that the practices described in this Construction SWPPP are in fact implemented, and to evaluate the plan's effectiveness in reducing erosion, sediment, and pollutant levels in stormwater discharged from the site.
- Describe the final stabilization/termination design to minimize erosion and prevent stormwater impacts after construction is complete.

This Construction SWPPP:

- Identifies the Certified Erosion and Sedimentation Control Lead (CESCL) with a description of this person's duties.
- Identifies the Stormwater Pollution Prevention Team (SWPP Team) that will assist in implementation of the Construction SWPPP during construction.
- Describes the existing site conditions, including existing land use for the site, the soil types at the site, as well as the location of surface waters that are located on or next to the site.
- Identifies the body or bodies of water that will receive runoff from the construction site, including the ultimate body of water that receives the stormwater.
- Identifies the drainage areas and potential stormwater contaminants.
- Describes the stormwater management controls and various Best Management Practices (BMPs) necessary to reduce erosion, sediment, and pollutants in stormwater discharge.
- Describes the facility monitoring plan and how controls will be coordinated with construction activities.
- Describes the implementation schedule and provisions for amendment of the plan.

2.0 Project Description

This Construction Stormwater Pollution Prevention Plan (CSWPPP) describes proposed stormwater mitigation for the STEM classroom building project at Pierce College Puyallup (PCP). PCP is bounded by 39th Avenue SE to the south, Wildwood Park Drive to the north and east, and Bradley Lake and commercial properties to the west in Puyallup, Washington. The total campus area is approximately 122.3 acres and is situated on eight separate parcels.

The project proposes a new STEM classroom building and a new 108-stall parking lot. Refer to Section 1.2 for proposed basin areas. Improvements include asphalt paving, concrete paving, a new building, utilities services for the new building, and stormwater management. A belowground detention facility using StormTech MC-7200 chambers is proposed for stormwater flow control. A bioretention facility will be used upstream of the proposed flow control facility to provide stormwater quality treatment for pollution generating impervious surfaces (PGIS).

The Stormwater Site Plan (under separate cover) describes the stormwater facilities designed for this project. The drainage plans and report have been prepared to satisfy all requirements of the Department of Ecology (DOE) 2019 *Stormwater Management Manual for Western Washington (SWMMWW)*. This report accompanies the final site plan submitted for the proposed new STEM building at PCP.

3.0 Existing Site Conditions

The 122.30-acre campus is partially developed and located on the north side of 39th Avenue SE. Refer to Appendix A-1 – Vicinity Map for more information. The campus consists of several buildings, parking lots, detention ponds, forested areas, wetlands, and an access drive loop that is routed around the perimeter of the developed portion of the campus.

PCP is bounded by 39th Avenue SE to the south, Wildwood Park Drive to the north and east, and Bradley Lake and commercial properties to the west in Puyallup, Washington. The main entrance driveway to the campus is located on the south side of the property along 39th Avenue SE. An additional driveway connection to the campus is located at the northwest of the site and connects to 7th Street SE. All adjacent properties are downgradient of the site and do not appear to discharge stormwater onto the campus.

The campus straddles two drainage basins, as outlined by the City of Puyallup Drainage Basin Map. The basin delineation line runs approximately north/south down the middle of the campus. The west side of the campus is within the State Highway Basin and the east side of the campus is within the Pothole Basin. The proposed improvements are located within the Pothole Basin.

The existing conditions at the project site include native vegetation and forested area that are undeveloped. Topography generally slopes from southwest to northeast. The project site drains to an existing conveyance system that is routed north and east before outfalling to an existing detention pond located at the far eastern edge of the campus. The existing detention pond outfalls to a biofiltration swale, where it eventually disperses into an existing unnamed wetland located approximately 320 feet southeast of the detention pond. Additionally, the parking lot portion of the project is adjacent to existing Wetland A. A small portion of the existing project basin drains to Wetland A in the existing condition.

4.0 Adjacent Areas and Drainage

The project discharges at the northeast end of the campus along the College Way. Stormwater is then collected and conveyed via catch basins and 12-inch storm pipes. Stormwater is routed north for approximately 150 feet along College Way. Stormwater is then routed east through

18-inch storm pipes for approximately 100 feet, where it outfalls to a riprap ditch. Stormwater then flows south for approximately 500 feet before outfalling to the existing detention pond located at the eastern extent of the campus. The existing detention pond outfalls to a riprap pad, where it eventually disperses into an existing unnamed wetland located approximately 320 feet southeast of the detention pond.

Stormwater from proposed improvements will outfall to the same waterbodies in the existing and proposed conditions within their respective sub-basins. Therefore, all proposed improvements shall maintain onsite natural drainage courses.

5.0 Critical Areas

The site contains five wetlands onsite, per the City of Puyallup GIS Critical Areas Map. PCP maps indicate 11 wetlands are located onsite. The project site is located adjacent to wetlands.

6.0 Soils

Soils at the site are mapped by the Natural Resources Conservation Service (NRCS) as predominantly gravelly sandy loam underlain by glacial till. Refer to Appendix A-2 for the NRCS Soils Map.

7.0 Potential Erosion Problems

The soils found onsite all have a slight erosion hazard. Soils that are exposed during construction will be stabilized per Section 8.5.

8.0 Construction Stormwater Pollution Prevention Elements

The purpose of this section is to describe how each of the 12 Construction Stormwater Pollution Prevention Elements has been addressed and to identify the type and location of BMPs used to satisfy the required element. If an element is not applicable to the project, a reason is provided.



8.1 Mark Clearing Limits

Prior to beginning land-disturbing activities, clearing limits will be marked with high visibility plastic or metal fence (BMP C103). Significant vegetation to remain will be marked and protected by fencing.



8.2 Establish Construction Access

A stabilized construction entrance (BMP C105) will be constructed off College Way where the proposed parking lot will be constructed. The stabilized construction entrance shall be maintained during all phases of work where land disturbing activities are conducted. Construction vehicle ingress and egress will be limited to the access road. As construction proceeds, the contractor may move the entrance(s) as needed. If sediment is tracked off site, the contractor will be required to sweep the road thoroughly at the end of each day, or more frequently, as necessary.

8.3 Control Flow Rates

The existing site contains a previously sized stormwater conveyance system that will be protected during construction. The contractor shall install measures that will slow stormwater flows, such as interceptor dikes and swales (BMP C200), check dams (BMP C207), and Baker tanks.

Make mention in the CSWPP that a sediment trap is proposed. Additionally size the trap per the contributing areas [CSWPP, pg 3]

Provide a discussion as to how temporary stormwater will be addressed. The civil plans show multiple swales leading to a temporary sediment pond to be pumped into baker tanks. How will the stormwater be disposed from the baker tanks? [CSWPP, pg 3]

During construction, temporary swales will be provided to intercept stormwater and discharge to a collection point at the northeast corner of the work area. The stormwater will be pumped from this collection point into the Baker tanks. The Baker tanks will be used to control flow rates and sediment during construction. The clean stormwater will be discharged from the Baker tanks to the existing stormwater pipe system in College Way.

8.4 Install Sediment Update element 5 to state the 2019 Ecology manual's requirements for soils to be stabilized. [drainage report, pg 8]

As part of the in-stream sediment control, silt fences will be installed onsite. The identified BMPs include Silt Fencing (BMP C233) and use of Inlet Protection (BMP C220) for existing catch basins and proposed catch basins within the project area and in adjacent streets that may receive runoff. Baker tanks will also be used to remove sediment from runoff. The Baker tanks were sized using the online water quality facility volume in WWHM (Western Washington Hydrology Model). Refer to Appendix D for calculations.

8.5 Stabilize Soils

Exposed areas and soil stockpiles must be stabilized according to the following schedule:

- From May 1 to September 30, all exposed soils at final grade and all exposed soils that are scheduled to remain unworked shall be stabilized within seven days.
- From October 1 to April 30, all exposed soils at final grade and all exposed soils that are scheduled to remain unworked shall be stabilized within two days.

Disturbed areas are to be stabilized with seeding (BMP 120), mulching (BMP 121), plastic covering (BMP 123), or an equivalent method approved by the engineer.

8.6 Protect Slopes

The existing site is developed and is relatively flat. Soil stabilization BMPs shown in Section 8.5 will be adequate to protect exposed slopes.

8.7 Protect Drain Inlets

Storm drain inlets shall be protected so that surface water runoff does not enter the conveyance system without first being filtered. Inlets shall be inspected weekly, at a minimum, and daily during storm events. Storm Drain Inlet Protection (BMP C220) will be provided.

8.8 Stabilize Channels and Outlets

Outlet Protection (BMP C209) is required at the outlets of all ponds, pipes, ditches, or other approved conveyances, and where runoff is conveyed to a natural or manmade drainage feature such as a stream, wetland, lake, or ditch.

8.9 Control Pollutants

All waste materials will be collected and stored in a securely closed metal dumpster. All trash and construction debris from the site will be deposited in the dumpster. The dumpster will be emptied a minimum of once per week, and the trash will be hauled to the local landfill. No construction materials will be buried onsite. All personnel will be instructed regarding the correct procedure for waste disposal. All sanitary waste will be collected from the portable units a minimum of three times per week. Good housekeeping and spill control practices will be followed during construction to minimize stormwater contamination from petroleum products, fertilizers, and concrete.

Table 1 below lists several pollutants that are commonly found on construction sites that have the potential to contaminate storm runoff. These pollutants will be present, mainly in areas of building and pavement construction. The Contractor and the CESCL will be responsible for identifying areas where these pollutants are being used and monitor runoff coming from these areas. Pollutant sources will be covered with plastic if contaminated runoff is observed from these areas. If contaminated runoff is found in the sediment trap or soils, the CESCL will direct the Contractor to remove the polluted water/soil and dispose of it in an approved area offsite.

Table 1 – Potential Construction Site Stormwater Pollutants

Trade Name Material	Chemical/Physical Description ⁽¹⁾	Stormwater Pollutants ⁽¹⁾
Pesticides (insecticides, fungicides, herbicide, rodenticides)	Various colored to colorless liquid, powder, pellets, or grains	Chlorinated hydrocarbons, organophosphates, carbamates, arsenic
Fertilizer	Liquid or solid grains	Nitrogen, phosphorous
Plaster	White granules or powder	Calcium sulphate, calcium carbonate, sulfuric acid
Cleaning solvents	Colorless, blue, or yellow-green liquid	Perchloroethylene, methylene chloride, trichloroethylene, petroleum distillates
Asphalt	Black solid	Oil, petroleum distillates
Concrete	White solid	Limestone, sand
Glue, adhesives	White or yellow liquid	Polymers, epoxies
Paints	Various colored liquid	Metal oxides, Stoddard solvent, talc, calcium carbonate, arsenic
Curing compounds	Creamy white liquid	Naphtha
Wastewater from construction equipment washing	Water	Soil, oil & grease, solids
Wood preservatives	Clear amber or dark brown liquid	Stoddard solvent, petroleum distillates, arsenic, copper, chromium
Hydraulic oil/fluids	Brown oily petroleum hydrocarbon	Mineral oil
Gasoline	Colorless, pale brown or pink petroleum hydrocarbon	Benzene, ethyl benzene, toluene, xylene, MTBE
Diesel fuel	Clear, blue-green to yellow liquid	Petroleum distillate, oil & grease, naphthalene, xylenes
Kerosene	Pale yellow liquid petroleum hydrocarbon	Coal oil, petroleum distillates
Antifreeze/coolant	Clear green/yellow liquid	Ethylene glycol, propylene glycol, heavy metals (copper, lead, zinc)
Erosion	Solid Particles	Soil, Sediment

⁽¹⁾ Data obtained from MSDS when available

8.9.1 Required BMPs

The following BMPs or equivalent measures are required of all businesses and agencies during concrete pouring and asphalt application at temporary sites:

- Employees must be educated on the pollution hazards of concrete and asphalt application and cutting.
- Loose aggregate chunks and dust must be swept or shoveled and collected (not hosed down a storm drain) for recycling or proper disposal at the end of each work day, especially at work sites such as streets, driveways, parking lots, sidewalks, curbs, and gutters where rain can readily pick up the loose material and carry it to the nearest stormwater conveyance. Small amounts of excess concrete, grout, and mortar can be disposed of in the trash.
- Storm drain covers or similarly effective containment devices must be placed over all nearby drains at the beginning of each day. Shovel or vacuum slurry and remove from the site. All accumulated runoff and solids must be collected and properly disposed at the end of each workday, or more often if necessary.
- Exposed aggregate washing, where the top layer of unhardened concrete is hosed or scraped off to leave a rough finish, must be done with a mechanism for containment and collection of the discarded concrete slurry (such as the storm drain covers mentioned above). The easiest way to contain the wash water will be to direct the washings to a hole in the ground where the water can percolate into the ground and the solids later covered with soil.
- If directed to a drain, a catch basin filter insert must be used to remove the solids. This is especially useful if the activity must proceed on rainy days.
- Cleaning of concrete application and mixing equipment or concrete vehicles on the work site must be done in a designated area where the rinse water is controlled. The rinse water must either be collected for proper disposal or put into a hole in the ground where the water can percolate away and the solids later covered with soil or recovered and disposed or recycled.

The use of any treatment BMP must not result in the violation of groundwater, surface water, or drinking water quality standards.

8.10 Control Dewatering

Large volumes of dewatering of construction areas or utilities are not anticipated because groundwater is not likely to be encountered at elevations of proposed utility construction.

8.11 Maintain BMPs

Temporary and permanent erosion and sediment control BMPs shall be maintained and repaired as needed to assure performance of their intended functions.

Sediment control BMPs such as silt fencing and drain inlet protection shall be inspected weekly or after a runoff-producing event. Temporary erosion and sediment control BMPs will be removed within 30 days after final site stabilization is achieved. The following inspection and maintenance practices will be used to maintain erosion and sediment controls:

- Built-up sediment will be removed from silt fencing when it has reached one-third the height of the fence.

- Silt fences will be inspected for depth of sediment, tears in the fabric, and attachment to the fence posts, and to ensure that fence posts are firmly in the ground. Accumulated sediment will be removed from behind the fence.
- Temporary and permanent seeding will be inspected for bare spots, washouts, and healthy growth.
- The Contractor CESCL will provide erosion control inspection services and stormwater disposal monitoring through construction. The City Inspector will be notified of daily construction activities and scheduled meetings between the CESCL and the Contractor.

The maintenance inspection report will be made after each inspection. Copies of the report forms to be completed by the CESCL are attached as Appendix B of this Construction SWPPP. Completed forms will be provided to the City Inspector and will also be maintained onsite during the entire construction project. If construction activities or design modifications are made to the site plan that could impact stormwater, or if AHBL determines that the measures are not adequate to prevent erosion and the discharge of sediment from the site (based on turbidity measurements), this Construction SWPPP will be amended appropriately. The amended Construction SWPPP will have a description of the new activities that contribute to the increased pollutant loading and the planned source control activities.

8.12 Manage the Project

The following practices will be required during construction to properly manage activities:

- Comply with seasonal work limitations.
- Inspect, maintain, and repair BMPs.
- Identify a CESCL.
- Maintain the Construction SWPPP onsite at all times, including narrative and plans.

9.0 Construction Sequence and Phasing

9.1 Construction Sequence

The construction sequence is described below:

1. Arrange and attend a pre-construction meeting with City of Puyallup and obtain required permits.
2. Stake/flag clearing and construction limits.
3. Install construction entrance.
4. Construct all temporary erosion control BMPs according to the Temporary Erosion and Sedimentation Control (TESC) plan. Install inlet sediment protection in existing catch basins.
5. Construct protection devices for critical areas and significant trees proposed for retention.
6. Schedule an erosion control inspection with the City of Puyallup.
7. Demolish existing site features indicated for removal.

8. Maintain erosion control measures in accordance with City of Puyallup standards and manufacturer recommendations.
9. Rough grade and fill site. All grading shall be done in conformance with the grading plan.
10. Construct storm system and install inlet sediment protection to new basins.
11. Install all remaining site utilities and associated infrastructure.
12. Apply erosion control mulch and seeding, straw mulch, or equal, to areas that will not be brought to final grade or permanently vegetated within seven days of exposure during the dry season, and two days of exposure during the wet season (November 1 to March 31).
13. Relocate erosion control measures or install new measures so that, as the site conditions change, the erosion and sediment control is always in accordance with City of Puyallup Construction SWPPP minimum requirements.
14. Final grade site and install final surface treatments. Ensure that surface water is positively directed toward proposed storm collection facilities.
15. Remove remaining temporary erosion control items once site has been stabilized and upon approval of the City of Puyallup.

9.2 Construction Phasing

Work under this permit will be constructed in a single phase.

10.0 Construction Schedule

Construction is scheduled to begin in summer 2022 and is expected to be completed in fall 2022. The majority of earth moving activities will be scheduled during the dry season. During construction, measures will be taken to prevent the transportation of sediment from the site to receiving waters. These measures include the use of:

- Stabilized Construction Entrance (BMP C105)
- Temporary and Permanent Seeding (BMP C120)
- Mulching (BMP C121)
- Plastic Covering (BMP C123)
- Dust Control (BMP C140)
- Storm Drain Inlet Protection (BMP C220)
- Silt Fence (BMP C233)

11.0 Financial/Ownership Responsibilities

The contractor is responsible for obtaining performance and maintenance bonds in accordance with City of Puyallup requirements.

12.0 Certified Erosion and Sediment Control Lead (CESCL)

The General Contractor shall be required to provide a CESCL prior to construction. Once this individual is identified, the City Inspector will be notified.

The Contractor will designate their CESCL here:

Name: _____

Address: _____

Phone: _____

Fax Number: _____

The CESCL is required to meet DOE certification requirements. The City Inspector will be provided with CESCL information.

The duties of the CESCL include:

- Implement the Construction SWPPP/TESC plan with the aid of the SWPP Team.
- Oversee maintenance practices identified as BMPs in the Construction SWPPP.
- Conduct or provide for inspection and monitoring activities.
- Sample stormwater for turbidity using a turbidity meter.
- Identify other potential pollutant sources and make sure they are added to the plan.
- Identify any deficiencies in the Construction SWPPP and make sure they are corrected.
- Ensure that any changes in construction plans are addressed in the Construction SWPPP.

To aid in the implementation of the Construction SWPPP, the members of the SWPP Team include the following: General Contractor, CESCL, City of Puyallup Inspector, the geotechnical engineering consultant, and AHBL.

The General Contractor will ensure that all housekeeping and monitoring procedures are implemented, while the CESCL will ensure the integrity of the structural BMPs. The SWPP Team will observe construction and erosion control practices and recommend revisions or additions to the Construction SWPPP and drawings.

This analysis is based on data and records either supplied to or obtained by AHBL, Inc. These documents are referenced within the text of the analysis. The analysis has been prepared using procedures and practices within the standard accepted practices of the industry. We conclude that this project, as proposed, will not create any new problems within the existing downstream drainage system. This project will not noticeably aggravate any existing downstream problems due to either water quality or quantity.

AHBL, Inc.



Claire Hovde
Project Engineer

ACP/CFH/lsk

May 2022
Revised August 2022

Q:\2021\2210810\WORDPROC\Reports\20220818 Rpt (CSWPPP) 2210810.10.docx

Appendix A

Exhibits

- A-1 Vicinity Map
- A-2 NRCS Soils Map
- A-3 FEMA Flood Map

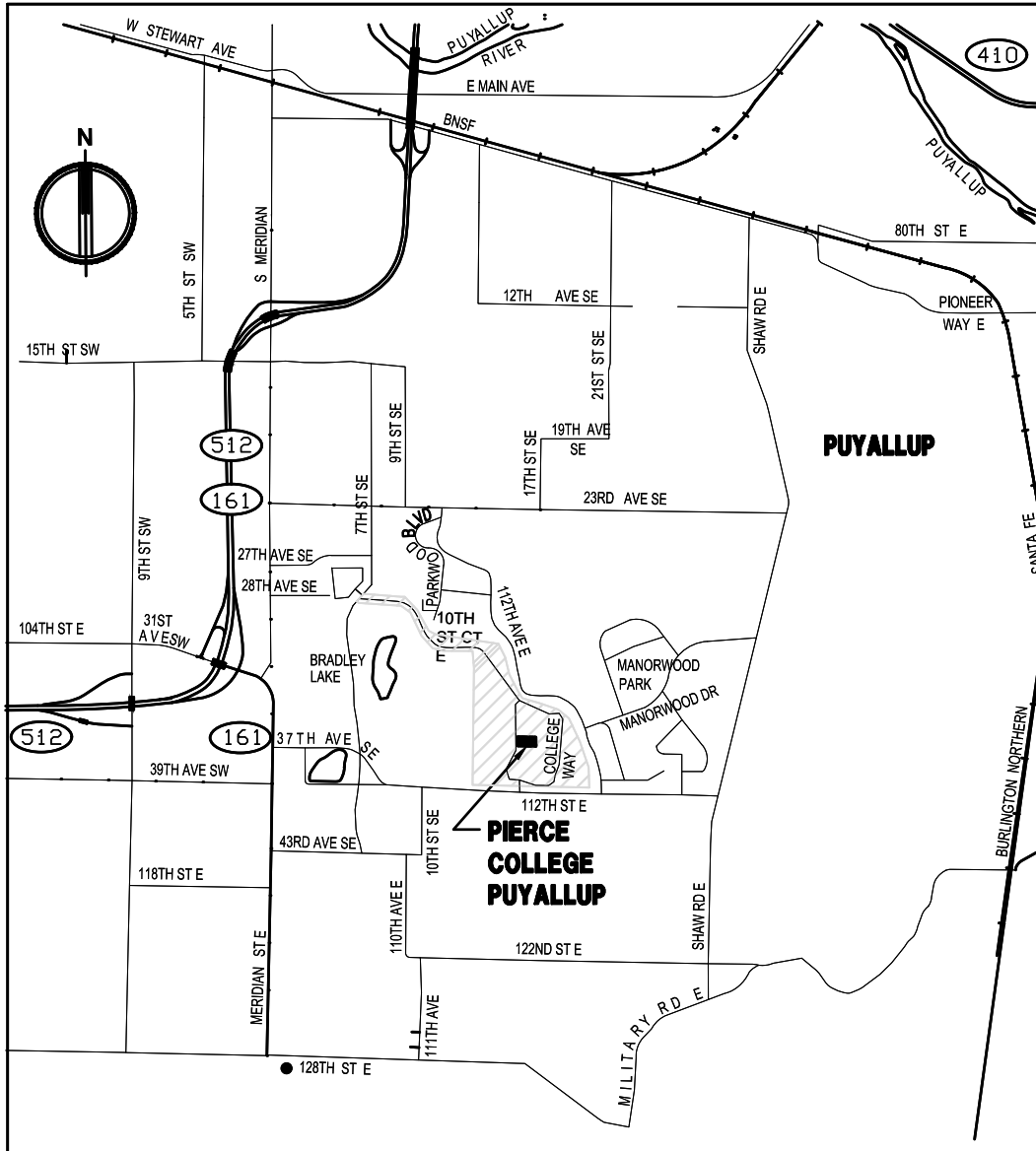

Pierce College Puyallup

2215 North 30th Street, Suite 300
 Tacoma, WA 98403
 253.383.2422 TEL 253.383.2572 FAX

Vicinity Map

DRAWN BY: ACP

DATE: 6/29/2021

JOB NO.: 2190297.10

EX A-1

Soil Map—Pierce County Area, Washington

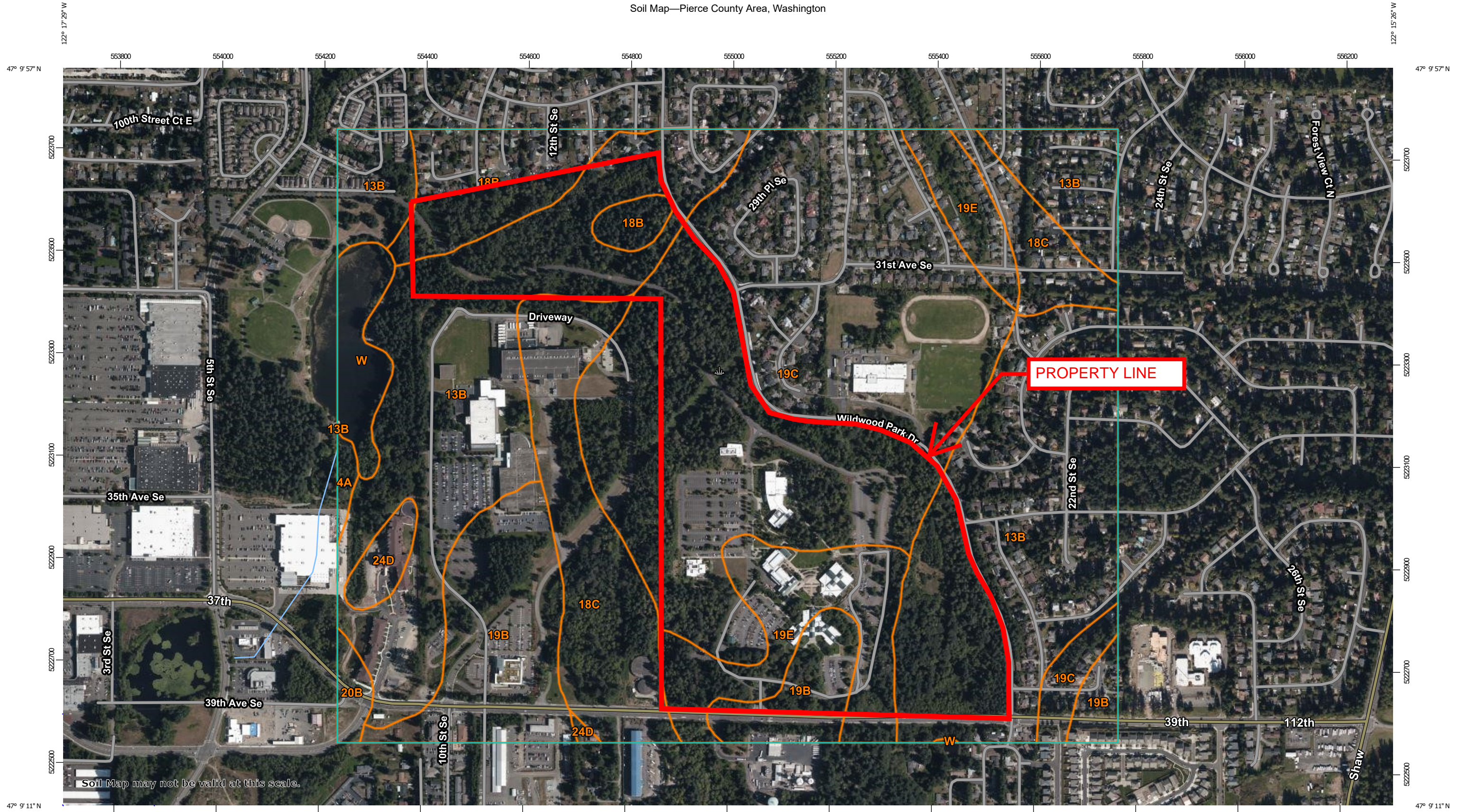

Soil Map may not be valid at this scale.

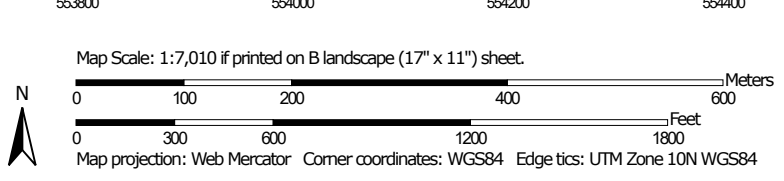

MAP LEGEND

Area of Interest (AOI)

 Area of Interest (AOI)

Soils

 Soil Map Unit Polygons

 Soil Map Unit Lines

 Soil Map Unit Points

Special Point Features



Blowout



Borrow Pit



Clay Spot



Closed Depression



Gravel Pit



Gravelly Spot



Landfill



Lava Flow



Marsh or swamp



Mine or Quarry



Miscellaneous Water



Perennial Water



Rock Outcrop



Saline Spot



Sandy Spot



Severely Eroded Spot



Sinkhole



Slide or Slip



Sodic Spot



Spoil Area



Stony Spot



Very Stony Spot



Wet Spot



Other



Special Line Features

Water Features



Streams and Canals

Transportation



Rails



Interstate Highways



US Routes



Major Roads



Local Roads

Background



Aerial Photography

MAP INFORMATION

The soil surveys that comprise your AOI were mapped at 1:24,000.

Warning: Soil Map may not be valid at this scale.

Enlargement of maps beyond the scale of mapping can cause misunderstanding of the detail of mapping and accuracy of soil line placement. The maps do not show the small areas of contrasting soils that could have been shown at a more detailed scale.

Please rely on the bar scale on each map sheet for map measurements.

Source of Map: Natural Resources Conservation Service
 Web Soil Survey URL:
 Coordinate System: Web Mercator (EPSG:3857)

Maps from the Web Soil Survey are based on the Web Mercator projection, which preserves direction and shape but distorts distance and area. A projection that preserves area, such as the Albers equal-area conic projection, should be used if more accurate calculations of distance or area are required.

This product is generated from the USDA-NRCS certified data as of the version date(s) listed below.

Soil Survey Area: Pierce County Area, Washington
 Survey Area Data: Version 16, Jun 4, 2020

Soil map units are labeled (as space allows) for map scales 1:50,000 or larger.

Date(s) aerial images were photographed: Jul 29, 2018—Jul 22, 2019

The orthophoto or other base map on which the soil lines were compiled and digitized probably differs from the background imagery displayed on these maps. As a result, some minor shifting of map unit boundaries may be evident.

Map Unit Legend

Map Unit Symbol	Map Unit Name	Acres in AOI	Percent of AOI
4A	Bellingham silty clay loam	1.4	0.3%
13B	Everett very gravelly sandy loam, 0 to 8 percent slopes	157.9	34.8%
18B	Indianola loamy sand, 0 to 5 percent slopes	20.3	4.5%
18C	Indianola loamy sand, 5 to 15 percent slopes	41.7	9.2%
19B	Kapowsin gravelly ashy loam, 0 to 6 percent slopes	42.1	9.3%
19C	Kapowsin gravelly ashy loam, 6 to 15 percent slopes	141.4	31.2%
19E	Kapowsin gravelly ashy loam, 30 to 65 percent slopes	32.9	7.3%
20B	Kitsap silt loam, 2 to 8 percent slopes	2.8	0.6%
24D	Neilton gravelly loamy sand, 8 to 25 percent slopes	4.4	1.0%
W	Water	8.8	1.9%
Totals for Area of Interest		453.7	100.0%

Pierce County Area, Washington

13B—Everett very gravelly sandy loam, 0 to 8 percent slopes

Map Unit Setting

National map unit symbol: 2t629

Elevation: 30 to 900 feet

Mean annual precipitation: 35 to 91 inches

Mean annual air temperature: 48 to 52 degrees F

Frost-free period: 180 to 240 days

Farmland classification: Farmland of statewide importance

Map Unit Composition

Everett and similar soils: 80 percent

Minor components: 20 percent

Estimates are based on observations, descriptions, and transects of the mapunit.

Description of Everett

Setting

Landform: Eskers, moraines, kames

Landform position (two-dimensional): Summit, shoulder

Landform position (three-dimensional): Crest, interfluvium

Down-slope shape: Convex

Across-slope shape: Convex

Parent material: Sandy and gravelly glacial outwash

Typical profile

O_i - 0 to 1 inches: slightly decomposed plant material

A - 1 to 3 inches: very gravelly sandy loam

B_w - 3 to 24 inches: very gravelly sandy loam

C₁ - 24 to 35 inches: very gravelly loamy sand

C₂ - 35 to 60 inches: extremely cobbly coarse sand

Properties and qualities

Slope: 0 to 8 percent

Depth to restrictive feature: More than 80 inches

Drainage class: Somewhat excessively drained

Capacity of the most limiting layer to transmit water (K_{sat}): High
(1.98 to 5.95 in/hr)

Depth to water table: More than 80 inches

Frequency of flooding: None

Frequency of ponding: None

Available water capacity: Low (about 3.2 inches)

Interpretive groups

Land capability classification (irrigated): None specified

Land capability classification (nonirrigated): 4s

Hydrologic Soil Group: A

Forage suitability group: Droughty Soils (G002XS401WA),
Droughty Soils (G002XN402WA), Droughty Soils
(G002XF403WA)

Other vegetative classification: Droughty Soils (G002XS401WA),
Droughty Soils (G002XN402WA), Droughty Soils
(G002XF403WA)

Hydric soil rating: No

Minor Components

Alderwood

Percent of map unit: 10 percent

Landform: Ridges, hills

Landform position (two-dimensional): Summit

Landform position (three-dimensional): Crest, tal

Down-slope shape: Linear, convex

Across-slope shape: Convex

Hydric soil rating: No

Indianola

Percent of map unit: 10 percent

Landform: Terraces, eskers, kames

Landform position (three-dimensional): Tread

Down-slope shape: Linear

Across-slope shape: Linear

Hydric soil rating: No

Data Source Information

Soil Survey Area: Pierce County Area, Washington

Survey Area Data: Version 16, Jun 4, 2020

Hydrologic Soil Group: B
Forage suitability group: Limited Depth Soils (G002XF303WA),
Limited Depth Soils (G002XN302WA)
Other vegetative classification: Limited Depth Soils
(G002XF303WA), Limited Depth Soils (G002XN302WA)
Hydric soil rating: No

Minor Components

Alderwood

Percent of map unit: 5 percent
Landform: Ridges, hills
Landform position (two-dimensional): Summit
Landform position (three-dimensional): Crest, tal
Down-slope shape: Linear, convex
Across-slope shape: Convex
Hydric soil rating: No

Mckenna

Percent of map unit: 2 percent
Landform: Depressions, drainageways
Landform position (three-dimensional): Dip
Down-slope shape: Concave, linear
Across-slope shape: Concave
Hydric soil rating: Yes

Dupont

Percent of map unit: 2 percent
Landform: Depressions, troughs
Landform position (three-dimensional): Dip
Down-slope shape: Concave, linear
Across-slope shape: Concave
Hydric soil rating: Yes

Norma

Percent of map unit: 2 percent
Landform: Depressions, drainageways
Landform position (three-dimensional): Dip
Down-slope shape: Concave, linear
Across-slope shape: Concave
Hydric soil rating: Yes

Harstine

Percent of map unit: 2 percent
Landform: Ridges
Landform position (two-dimensional): Summit
Landform position (three-dimensional): Crest
Down-slope shape: Linear
Across-slope shape: Convex
Hydric soil rating: No

Neilton

Percent of map unit: 2 percent
Landform: Outwash terraces

Landform position (three-dimensional): Tread
Down-slope shape: Linear
Across-slope shape: Linear
Hydric soil rating: No

Data Source Information

Soil Survey Area: Pierce County Area, Washington
Survey Area Data: Version 16, Jun 4, 2020

Pierce County Area, Washington

19C—Kapowsin gravelly ashy loam, 6 to 15 percent slopes

Map Unit Setting

National map unit symbol: 2t61x

Elevation: 50 to 900 feet

Mean annual precipitation: 30 to 50 inches

Mean annual air temperature: 48 to 52 degrees F

Frost-free period: 150 to 220 days

Farmland classification: All areas are prime farmland

Map Unit Composition

Kapowsin and similar soils: 85 percent

Minor components: 15 percent

Estimates are based on observations, descriptions, and transects of the mapunit.

Description of Kapowsin

Setting

Landform: Moraines

Landform position (two-dimensional): Toeslope, footslope

Landform position (three-dimensional): Side slope, base slope

Down-slope shape: Convex

Across-slope shape: Linear

Parent material: Volcanic ash mixed with glacial drift over dense glaciomarine deposits

Typical profile

Ap - 0 to 7 inches: gravelly ashy loam

Bhs - 7 to 11 inches: gravelly ashy loam

Bs1 - 11 to 15 inches: gravelly ashy loam

2Bs2 - 15 to 25 inches: loam

3Bstm - 25 to 29 inches: loam

3Cd - 29 to 59 inches: gravelly loam

Properties and qualities

Slope: 6 to 15 percent

Depth to restrictive feature: More than 80 inches; More than 80 inches

Drainage class: Moderately well drained

Capacity of the most limiting layer to transmit water (Ksat): Very low (0.00 to 0.00 in/hr)

Depth to water table: About 11 to 24 inches

Frequency of flooding: None

Frequency of ponding: None

Available water capacity: Low (about 5.3 inches)

Interpretive groups

Land capability classification (irrigated): None specified

Land capability classification (nonirrigated): 3e

Hydrologic Soil Group: B
Forage suitability group: Limited Depth Soils (G002XF303WA),
Limited Depth Soils (G002XN302WA)
Other vegetative classification: Limited Depth Soils
(G002XF303WA), Limited Depth Soils (G002XN302WA)
Hydric soil rating: No

Minor Components

Alderwood

Percent of map unit: 5 percent
Landform: Ridges, hills
Landform position (two-dimensional): Shoulder
Landform position (three-dimensional): Nose slope, talf
Down-slope shape: Linear, convex
Across-slope shape: Convex
Hydric soil rating: No

Neilton

Percent of map unit: 2 percent
Landform: Outwash terraces
Landform position (three-dimensional): Riser
Down-slope shape: Linear
Across-slope shape: Linear
Hydric soil rating: No

Norma

Percent of map unit: 2 percent
Landform: Depressions, drainageways
Landform position (three-dimensional): Dip
Down-slope shape: Concave, linear
Across-slope shape: Concave
Hydric soil rating: Yes

Mckenna

Percent of map unit: 2 percent
Landform: Depressions, drainageways
Landform position (three-dimensional): Dip
Down-slope shape: Concave, linear
Across-slope shape: Concave
Hydric soil rating: Yes

Dupont

Percent of map unit: 2 percent
Landform: Depressions, troughs
Landform position (three-dimensional): Dip
Down-slope shape: Concave, linear
Across-slope shape: Concave
Hydric soil rating: Yes

Harstine

Percent of map unit: 2 percent
Landform: Ridges
Landform position (two-dimensional): Footslope

Landform position (three-dimensional): Nose slope
Down-slope shape: Linear
Across-slope shape: Convex
Hydric soil rating: No

Data Source Information

Soil Survey Area: Pierce County Area, Washington
Survey Area Data: Version 16, Jun 4, 2020

Pierce County Area, Washington

19E—Kapowsin gravelly ashy loam, 30 to 65 percent slopes

Map Unit Setting

National map unit symbol: 2t620

Elevation: 50 to 900 feet

Mean annual precipitation: 30 to 50 inches

Mean annual air temperature: 48 to 52 degrees F

Frost-free period: 150 to 220 days

Farmland classification: Not prime farmland

Map Unit Composition

Kapowsin and similar soils: 85 percent

Minor components: 15 percent

Estimates are based on observations, descriptions, and transects of the mapunit.

Description of Kapowsin

Setting

Landform: Moraines

Landform position (two-dimensional): Footslope, backslope

Landform position (three-dimensional): Side slope

Down-slope shape: Convex

Across-slope shape: Linear

Parent material: Volcanic ash mixed with glacial drift over dense glaciomarine deposits

Typical profile

Ap - 0 to 7 inches: gravelly ashy loam

Bhs - 7 to 11 inches: gravelly ashy loam

Bs1 - 11 to 15 inches: gravelly ashy loam

2Bs2 - 15 to 25 inches: loam

3Bstm - 25 to 29 inches: loam

3Cd - 29 to 59 inches: gravelly loam

Properties and qualities

Slope: 30 to 65 percent

Depth to restrictive feature: More than 80 inches; More than 80 inches

Drainage class: Moderately well drained

Capacity of the most limiting layer to transmit water (Ksat): Very low (0.00 to 0.00 in/hr)

Depth to water table: About 11 to 24 inches

Frequency of flooding: None

Frequency of ponding: None

Available water capacity: Low (about 5.3 inches)

Interpretive groups

Land capability classification (irrigated): None specified

Land capability classification (nonirrigated): 7e

National Flood Hazard Layer FIRMMette



122°16'39"W 47°9'35"N



0 250 500 1,000 1,500 2,000 Feet 1:6,000 122°16'2"W 47°9'10"N
 Basemap: USGS National Map: Orthoimagery: Data refreshed October, 2020

Legend

SEE FIS REPORT FOR DETAILED LEGEND AND INDEX MAP FOR FIRM PANEL LAYOUT

SPECIAL FLOOD HAZARD AREAS		Without Base Flood Elevation (BFE) <i>Zone A, V, A99</i>
		With BFE or Depth <i>Zone AE, AO, AH, VE, AR</i>
		Regulatory Floodway

OTHER AREAS OF FLOOD HAZARD		0.2% Annual Chance Flood Hazard, Areas of 1% annual chance flood with average depth less than one foot or with drainage areas of less than one square mile <i>Zone X</i>
		Future Conditions 1% Annual Chance Flood Hazard <i>Zone X</i>
		Area with Reduced Flood Risk due to Levee. See Notes. <i>Zone X</i>
		Area with Flood Risk due to Levee <i>Zone D</i>

OTHER AREAS		NO SCREEN Area of Minimal Flood Hazard <i>Zone X</i>
		Effective LOMRs
		Area of Undetermined Flood Hazard <i>Zone D</i>

GENERAL STRUCTURES		Channel, Culvert, or Storm Sewer
		Levee, Dike, or Floodwall

OTHER FEATURES		20.2 Cross Sections with 1% Annual Chance
		17.5 Water Surface Elevation
		Coastal Transect
		Base Flood Elevation Line (BFE)
		Limit of Study
		Jurisdiction Boundary
		Coastal Transect Baseline
		Profile Baseline
		Hydrographic Feature

MAP PANELS		Digital Data Available
		No Digital Data Available
		Unmapped

The pin displayed on the map is an approximate point selected by the user and does not represent an authoritative property location.

This map complies with FEMA's standards for the use of digital flood maps if it is not void as described below. The basemap shown complies with FEMA's basemap accuracy standards

The flood hazard information is derived directly from the authoritative NFHL web services provided by FEMA. This map was exported on 6/29/2021 at 4:45 PM and does not reflect changes or amendments subsequent to this date and time. The NFHL and effective information may change or become superseded by new data over time.

This map image is void if the one or more of the following map elements do not appear: basemap imagery, flood zone labels, legend, scale bar, map creation date, community identifiers, FIRM panel number, and FIRM effective date. Map images for unmapped and unmodernized areas cannot be used for regulatory purposes.

National Flood Hazard Layer FIRMette



122°17'1"W 47°9'59"N

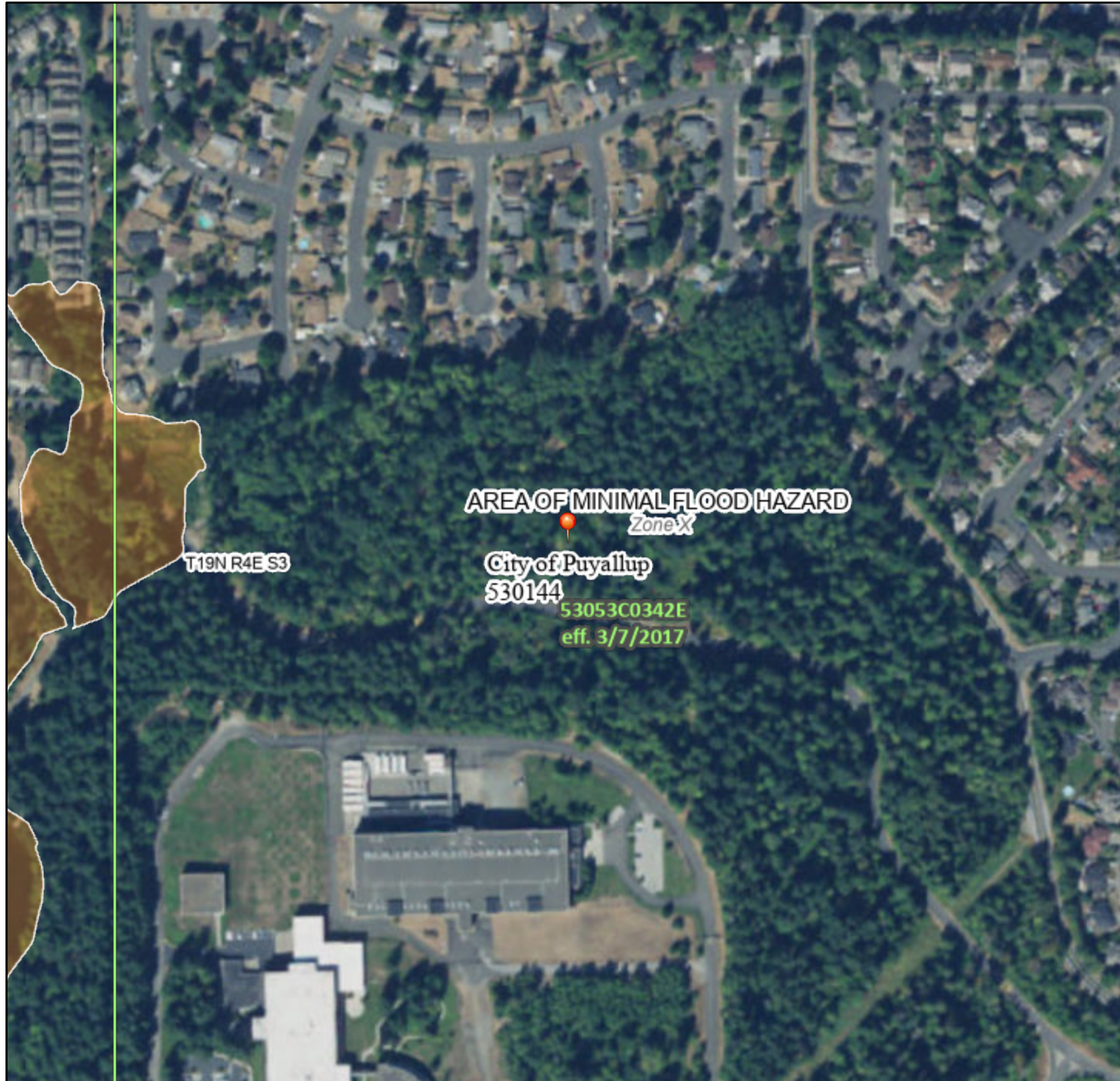

Legend

SEE FIS REPORT FOR DETAILED LEGEND AND INDEX MAP FOR FIRM PANEL LAYOUT

SPECIAL FLOOD HAZARD AREAS		Without Base Flood Elevation (BFE) <i>Zone A, V, A99</i>
		With BFE or Depth <i>Zone AE, AO, AH, VE, AR</i>
		Regulatory Floodway
OTHER AREAS OF FLOOD HAZARD		0.2% Annual Chance Flood Hazard, Areas of 1% annual chance flood with average depth less than one foot or with drainage areas of less than one square mile <i>Zone X</i>
		Future Conditions 1% Annual Chance Flood Hazard <i>Zone X</i>
		Area with Reduced Flood Risk due to Levee. See Notes. <i>Zone X</i>
		Area with Flood Risk due to Levee <i>Zone D</i>
OTHER AREAS		NO SCREEN Area of Minimal Flood Hazard <i>Zone X</i>
		Effective LOMRs
GENERAL STRUCTURES		Area of Undetermined Flood Hazard <i>Zone D</i>
		Channel, Culvert, or Storm Sewer
		Levee, Dike, or Floodwall
OTHER FEATURES		20.2 Cross Sections with 1% Annual Chance
		17.5 Water Surface Elevation
		Coastal Transect
		Base Flood Elevation Line (BFE)
		Limit of Study
MAP PANELS		Jurisdiction Boundary
		Coastal Transect Baseline
		Profile Baseline
		Hydrographic Feature
		Digital Data Available
		No Digital Data Available
		Unmapped

The pin displayed on the map is an approximate point selected by the user and does not represent an authoritative property location.

This map complies with FEMA's standards for the use of digital flood maps if it is not void as described below. The basemap shown complies with FEMA's basemap accuracy standards

The flood hazard information is derived directly from the authoritative NFHL web services provided by FEMA. This map was exported on **6/29/2021 at 4:51 PM** and does not reflect changes or amendments subsequent to this date and time. The NFHL and effective information may change or become superseded by new data over time.

This map image is void if the one or more of the following map elements do not appear: basemap imagery, flood zone labels, legend, scale bar, map creation date, community identifiers, FIRM panel number, and FIRM effective date. Map images for unmapped and unmodernized areas cannot be used for regulatory purposes.



Basemap: USGS National Map: Orthoimagery: Data refreshed October, 2020

Appendix B

Inspection Logs

Construction Stormwater Site Inspection Form

Project Name _____ **Permit #** _____ **Inspection Date** _____ **Time** _____

Name of Certified Erosion Sediment Control Lead (CESCL) or qualified inspector if *less than one acre*
 Print Name: _____

Approximate rainfall amount since the last inspection (in inches): _____

Approximate rainfall amount in the last 24 hours (in inches): _____

Current Weather Clear Cloudy Mist Rain Wind Fog

A. Type of inspection: Weekly Post Storm Event Other

B. Phase of Active Construction (check all that apply):

Pre Construction/installation of erosion/sediment controls	<input type="checkbox"/>	Clearing/Demo/Grading	<input type="checkbox"/>	Infrastructure/storm/roads	<input type="checkbox"/>
Concrete pours	<input type="checkbox"/>	Vertical Construction/buildings	<input type="checkbox"/>	Utilities	<input type="checkbox"/>
Offsite improvements	<input type="checkbox"/>	Site temporary stabilized	<input type="checkbox"/>	Final stabilization	<input type="checkbox"/>

C. Questions:

- | | | | | |
|--|-----|----|-------|-------|
| 1. Were all areas of construction and discharge points inspected? | Yes | No | _____ | _____ |
| 2. Did you observe the presence of suspended sediment, turbidity, discoloration, or oil sheen | Yes | No | _____ | _____ |
| 3. Was a water quality sample taken during inspection? (<i>refer to permit conditions S4 & S5</i>) | Yes | No | _____ | _____ |
| 4. Was there a turbid discharge 250 NTU or greater, or Transparency 6 cm or less?* | Yes | No | _____ | _____ |
| 5. If yes to #4 was it reported to Ecology? | Yes | No | _____ | _____ |
| 6. Is pH sampling required? pH range required is 6.5 to 8.5. | Yes | No | _____ | _____ |

If answering yes to a discharge, describe the event. Include when, where, and why it happened; what action was taken, and when.

*If answering yes to # 4 record NTU/Transparency with continual sampling daily until turbidity is 25 NTU or less/ transparency is 33 cm or greater.

Sampling Results: _____ Date: _____

Parameter	Method (circle one)	Result			Other/Note
		NTU	cm	pH	
Turbidity	tube, meter, laboratory				
pH	Paper, kit, meter				

Construction Stormwater Site Inspection Form

D. Check the observed status of all items. Provide "Action Required" details and dates.

Element #	Inspection	BMPs Inspected			BMP needs maintenance	BMP failed	Action required (describe in section F)
		yes	no	n/a			
1 Clearing Limits	Before beginning land disturbing activities are all clearing limits, natural resource areas (streams, wetlands, buffers, trees) protected with barriers or similar BMPs? (high visibility recommended)						
2 Construction Access	Construction access is stabilized with quarry spalls or equivalent BMP to prevent sediment from being tracked onto roads?						
	Sediment tracked onto the road way was cleaned thoroughly at the end of the day or more frequent as necessary.						
3 Control Flow Rates	Are flow control measures installed to control stormwater volumes and velocity during construction and do they protect downstream properties and waterways from erosion?						
	If permanent infiltration ponds are used for flow control during construction, are they protected from siltation?						
4 Sediment Controls	All perimeter sediment controls (e.g. silt fence, wattles, compost socks, berms, etc.) installed, and maintained in accordance with the Stormwater Pollution Prevention Plan (SWPPP).						
	Sediment control BMPs (sediment ponds, traps, filters etc.) have been constructed and functional as the first step of grading.						
	Stormwater runoff from disturbed areas is directed to sediment removal BMP.						
5 Stabilize Soils	Have exposed un-worked soils been stabilized with effective BMP to prevent erosion and sediment deposition?						

Construction Stormwater Site Inspection Form

Element #	Inspection	BMPs Inspected			BMP needs maintenance	BMP failed	Action required (describe in section F)
		yes	no	n/a			
5 Stabilize Soils Cont.	Are stockpiles stabilized from erosion, protected with sediment trapping measures and located away from drain inlet, waterways, and drainage channels?						
	Have soils been stabilized at the end of the shift, before a holiday or weekend if needed based on the weather forecast?						
6 Protect Slopes	Has stormwater and ground water been diverted away from slopes and disturbed areas with interceptor dikes, pipes and or swales?						
	Is off-site storm water managed separately from stormwater generated on the site?						
	Is excavated material placed on uphill side of trenches consistent with safety and space considerations?						
	Have check dams been placed at regular intervals within constructed channels that are cut down a slope?						
7 Drain Inlets	Storm drain inlets made operable during construction are protected.						
	Are existing storm drains within the influence of the project protected?						
8 Stabilize Channel and Outlets	Have all on-site conveyance channels been designed, constructed and stabilized to prevent erosion from expected peak flows?						
	Is stabilization, including armoring material, adequate to prevent erosion of outlets, adjacent stream banks, slopes and downstream conveyance systems?						
9 Control Pollutants	Are waste materials and demolition debris handled and disposed of to prevent contamination of stormwater?						
	Has cover been provided for all chemicals, liquid products, petroleum products, and other material?						
	Has secondary containment been provided capable of containing 110% of the volume?						
	Were contaminated surfaces cleaned immediately after a spill incident?						
	Were BMPs used to prevent contamination of stormwater by a pH modifying sources?						

Construction Stormwater Site Inspection Form

Element #	Inspection	BMPs Inspected			BMP needs maintenance	BMP failed	Action required (describe in section F)
		yes	no	n/a			
9 Cont.	Wheel wash wastewater is handled and disposed of properly.						
10 Control Dewatering	Concrete washout in designated areas. No washout or excess concrete on the ground.						
	Dewatering has been done to an approved source and in compliance with the SWPPP.						
	Were there any clean non turbid dewatering discharges?						
11 Maintain BMP	Are all temporary and permanent erosion and sediment control BMPs maintained to perform as intended?						
12 Manage the Project	Has the project been phased to the maximum degree practicable?						
	Has regular inspection, monitoring and maintenance been performed as required by the permit?						
	Has the SWPPP been updated, implemented and records maintained?						
13 Protect LID	Is all Bioretention and Rain Garden Facilities protected from sedimentation with appropriate BMPs?						
	Is the Bioretention and Rain Garden protected against over compaction of construction equipment and foot traffic to retain its infiltration capabilities?						
	Permeable pavements are clean and free of sediment and sediment laden-water runoff. Muddy construction equipment has not been on the base material or pavement.						
	Have soiled permeable pavements been cleaned of sediments and pass infiltration test as required by stormwater manual methodology?						
	Heavy equipment has been kept off existing soils under LID facilities to retain infiltration rate.						

E. Check all areas that have been inspected. ✓

All in place BMPs All disturbed soils All concrete wash out area All material storage areas
 All discharge locations All equipment storage areas All construction entrances/exits

Construction Stormwater Site Inspection Form

F. Elements checked "Action Required" (section D) describe corrective action to be taken. List the element number; be specific on location and work needed. Document, initial, and date when the corrective action has been completed and inspected.

Element #	Description and Location	Action Required	Completion Date	Initials

Attach additional page if needed

Sign the following certification:

"I certify that this report is true, accurate, and complete, to the best of my knowledge and belief"

Inspected by: (print) _____ (Signature) _____ Date: _____

Title/Qualification of Inspector: _____

Appendix C

Best Management Practices (BMPs)

BMP C103.....	High Visibility Fence
BMP C105.....	Stabilized Construction Entrance
BMP C120.....	Temporary and Permanent Seeding
BMP C121.....	Mulching
BMP C123.....	Plastic Covering
BMP C140.....	Dust Control
BMP C151.....	Concrete Handling
BMP C152.....	Sawcutting and Surface Pollution Prevention
BMP C160.....	Certified Erosion and Sediment Control Lead
BMP C200.....	Interceptor Dike and Swale
BMP C201.....	Grass-Lined Channels
BMP C207.....	Check Dams
BMP C209.....	Outlet Protection
BMP C220.....	Storm Drain Inlet Protection
BMP C233.....	Silt Fence
BMP C241.....	Temporary Sediment Pond

damage from burying and smothering.

- Vegetative buffer zones for streams, lakes or other waterways shall be established by the local permitting authority or other state or federal permits or approvals.

Maintenance Standards

Inspect the area frequently to make sure flagging remains in place and the area remains undisturbed. Replace all damaged flagging immediately.

BMP C103: High Visibility Fence

Purpose

Fencing is intended to:

1. Restrict clearing to approved limits.
2. Prevent disturbance of sensitive areas, their buffers, and other areas required to be left undisturbed.
3. Limit construction traffic to designated construction entrances, exits, or internal roads.
4. Protect areas where marking with survey tape may not provide adequate protection.

Conditions of Use

To establish clearing limits plastic, fabric, or metal fence may be used:

- At the boundary of sensitive areas, their buffers, and other areas required to be left uncleared.
- As necessary to control vehicle access to and on the site.

Design and Installation Specifications

High visibility plastic fence shall be composed of a high-density polyethylene material and shall be at least four feet in height. Posts for the fencing shall be steel or wood and placed every 6 feet on center (maximum) or as needed to ensure rigidity. The fencing shall be fastened to the post every six inches with a polyethylene tie. On long continuous lengths of fencing, a tension wire or rope shall be used as a top stringer to prevent sagging between posts. The fence color shall be high visibility orange. The fence tensile strength shall be 360 lbs./ft. using the ASTM D4595 testing method.

If appropriate install fabric silt fence in accordance with [BMP C233: Silt Fence \(p.367\)](#) to act as high visibility fence. Silt fence shall be at least 3 feet high and must be highly visible to meet the requirements of this BMP.

Metal fences shall be designed and installed according to the manufacturer's specifications.

Metal fences shall be at least 3 feet high and must be highly visible.

Fences shall not be wired or stapled to trees.

Maintenance Standards

If the fence has been damaged or visibility reduced, it shall be repaired or replaced immediately and visibility restored.

BMP C105: Stabilized Construction Entrance / Exit

Purpose

Stabilized Construction entrances are established to reduce the amount of sediment transported onto paved roads by vehicles or equipment. This is done by constructing a stabilized pad of quarry spalls at entrances and exits for construction sites.

Conditions of Use

Construction entrances shall be stabilized wherever traffic will be entering or leaving a construction site if paved roads or other paved areas are within 1,000 feet of the site.

For residential construction provide stabilized construction entrances for each residence, rather than only at the main subdivision entrance. Stabilized surfaces shall be of sufficient length/width to provide vehicle access/parking, based on lot size/configuration.

On large commercial, highway, and road projects, the designer should include enough extra materials in the contract to allow for additional stabilized entrances not shown in the initial Construction SWPPP. It is difficult to determine exactly where access to these projects will take place; additional materials will enable the contractor to install them where needed.

Design and Installation Specifications

See [Figure II-4.1.1 Stabilized Construction Entrance \(p.273\)](#) for details. Note: the 100' minimum length of the entrance shall be reduced to the maximum practicable size when the size or configuration of the site does not allow the full length (100').

Construct stabilized construction entrances with a 12-inch thick pad of 4-inch to 8-inch quarry spalls, a 4-inch course of asphalt treated base (ATB), or use existing pavement. Do not use crushed concrete, cement, or calcium chloride for construction entrance stabilization because these products raise pH levels in stormwater and concrete discharge to surface waters of the State is prohibited.

A separation geotextile shall be placed under the spalls to prevent fine sediment from pumping up into the rock pad. The geotextile shall meet the following standards:

Grab Tensile Strength (ASTM D4751)	200 psi min.
Grab Tensile Elongation (ASTM D4632)	30% max.
Mullen Burst Strength (ASTM D3786-80a)	400 psi min.
AOS (ASTM D4751)	20-45 (U.S. standard sieve size)

- Consider early installation of the first lift of asphalt in areas that will be paved; this can be used as a stabilized entrance. Also consider the installation of excess concrete as a stabilized entrance. During large concrete pours, excess concrete is often available for this purpose.
- Fencing (see [BMP C103: High Visibility Fence \(p.269\)](#)) shall be installed as necessary to restrict traffic to the construction entrance.
- Whenever possible, the entrance shall be constructed on a firm, compacted sub-grade. This can substantially increase the effectiveness of the pad and reduce the need for maintenance.
- Construction entrances should avoid crossing existing sidewalks and back of walk drains if at all possible. If a construction entrance must cross a sidewalk or back of walk drain, the full length of the sidewalk and back of walk drain must be covered and protected from sediment leaving the site.

Maintenance Standards

Quarry spalls shall be added if the pad is no longer in accordance with the specifications.

- If the entrance is not preventing sediment from being tracked onto pavement, then alternative measures to keep the streets free of sediment shall be used. This may include replacement/cleaning of the existing quarry spalls, street sweeping, an increase in the dimensions of the entrance, or the installation of a wheel wash.
- Any sediment that is tracked onto pavement shall be removed by shoveling or street sweeping. The sediment collected by sweeping shall be removed or stabilized on site. The pavement shall not be cleaned by washing down the street, except when high efficiency sweeping is ineffective and there is a threat to public safety. If it is necessary to wash the streets, the construction of a small sump to contain the wash water shall be considered. The sediment would then be washed into the sump where it can be controlled.
- Perform street sweeping by hand or with a high efficiency sweeper. Do not use a non-high efficiency mechanical sweeper because this creates dust and throws soils into storm systems or conveyance ditches.

- Any quarry spalls that are loosened from the pad, which end up on the roadway shall be removed immediately.
- If vehicles are entering or exiting the site at points other than the construction entrance(s), fencing (see BMP C103) shall be installed to control traffic.
- Upon project completion and site stabilization, all construction accesses intended as permanent access for maintenance shall be permanently stabilized.

Figure II-4.1.1 Stabilized Construction Entrance

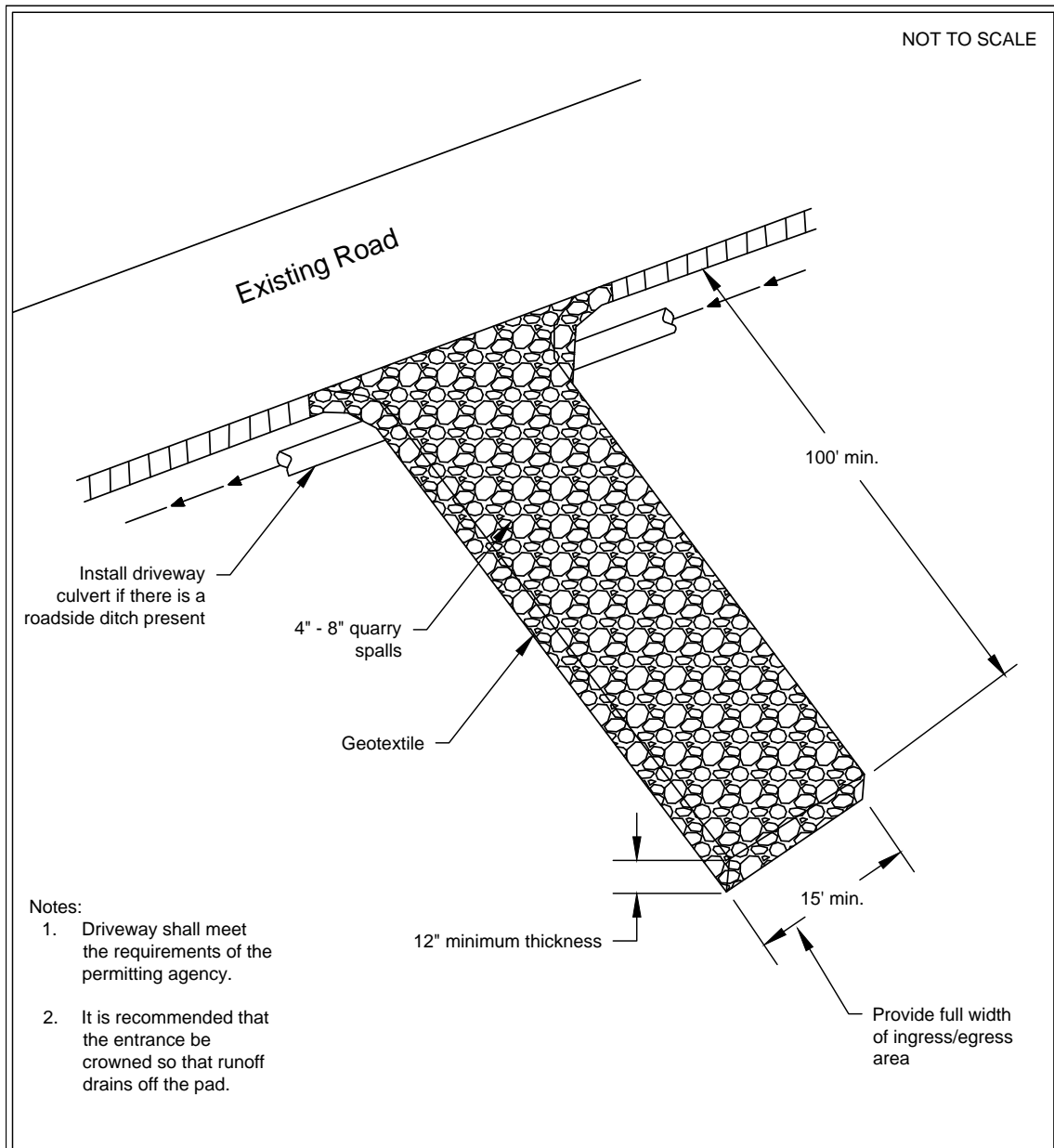

**Figure II-4.1.1
Stabilized Construction Entrance**

Revised June 2015

Please see <http://www.ecy.wa.gov/copyright.html> for copyright notice including permissions, limitation of liability, and disclaimer.

- Storm drain inlets shall be protected to prevent sediment-laden water entering the storm drain system (see [BMP C220: Storm Drain Inlet Protection \(p.357\)](#)).

Maintenance Standards

Inspect stabilized areas regularly, especially after large storm events.

Crushed rock, gravel base, etc., shall be added as required to maintain a stable driving surface and to stabilize any areas that have eroded.

Following construction, these areas shall be restored to pre-construction condition or better to prevent future erosion.

Perform street cleaning at the end of each day or more often if necessary.

BMP C120: Temporary and Permanent Seeding

Purpose

Seeding reduces erosion by stabilizing exposed soils. A well-established vegetative cover is one of the most effective methods of reducing erosion.

Conditions of Use

Use seeding throughout the project on disturbed areas that have reached final grade or that will remain unworked for more than 30 days.

The optimum seeding windows for western Washington are April 1 through June 30 and September 1 through October 1.

Between July 1 and August 30 seeding requires irrigation until 75 percent grass cover is established.

Between October 1 and March 30 seeding requires a cover of mulch with straw or an erosion control blanket until 75 percent grass cover is established.

Review all disturbed areas in late August to early September and complete all seeding by the end of September. Otherwise, vegetation will not establish itself enough to provide more than average protection.

- Mulch is required at all times for seeding because it protects seeds from heat, moisture loss, and transport due to runoff. Mulch can be applied on top of the seed or simultaneously by hydroseeding. See [BMP C121: Mulching \(p.284\)](#) for specifications.
- Seed and mulch, all disturbed areas not otherwise vegetated at final site stabilization. Final stabilization means the completion of all soil disturbing activities at the site and the establishment of a permanent vegetative cover, or equivalent per-

manent stabilization measures (such as pavement, riprap, gabions, or geotextiles) which will prevent erosion.

Design and Installation Specifications

Seed retention/detention ponds as required.

Install channels intended for vegetation before starting major earthwork and hydroseed with a Bonded Fiber Matrix. For vegetated channels that will have high flows, install erosion control blankets over hydroseed. Before allowing water to flow in vegetated channels, establish 75 percent vegetation cover. If vegetated channels cannot be established by seed before water flow; install sod in the channel bottom—over hydromulch and erosion control blankets.

- Confirm the installation of all required surface water control measures to prevent seed from washing away.
- Hydroseed applications shall include a minimum of 1,500 pounds per acre of mulch with 3 percent tackifier. See [BMP C121: Mulching \(p.284\)](#) for specifications.
- Areas that will have seeding only and not landscaping may need compost or meal-based mulch included in the hydroseed in order to establish vegetation. Re-install native topsoil on the disturbed soil surface before application.
- When installing seed via hydroseeding operations, only about 1/3 of the seed actually ends up in contact with the soil surface. This reduces the ability to establish a good stand of grass quickly. To overcome this, consider increasing seed quantities by up to 50 percent.
- Enhance vegetation establishment by dividing the hydromulch operation into two phases:
 1. Phase 1- Install all seed and fertilizer with 25-30 percent mulch and tackifier onto soil in the first lift.
 2. Phase 2- Install the rest of the mulch and tackifier over the first lift.

Or, enhance vegetation by:

1. Installing the mulch, seed, fertilizer, and tackifier in one lift.
2. Spread or blow straw over the top of the hydromulch at a rate of 800-1000 pounds per acre.
3. Hold straw in place with a standard tackifier.

Both of these approaches will increase cost moderately but will greatly improve and enhance vegetative establishment. The increased cost may be offset by the reduced need for:

- Irrigation.
- Reapplication of mulch.
- Repair of failed slope surfaces.

This technique works with standard hydromulch (1,500 pounds per acre minimum) and BFM/MBFMs (3,000 pounds per acre minimum).

- Seed may be installed by hand if:
 - Temporary and covered by straw, mulch, or topsoil.
 - Permanent in small areas (usually less than 1 acre) and covered with mulch, topsoil, or erosion blankets.
 - The seed mixes listed in the tables below include recommended mixes for both temporary and permanent seeding.
 - Apply these mixes, with the exception of the wetland mix, at a rate of 120 pounds per acre. This rate can be reduced if soil amendments or slow-release fertilizers are used.
 - Consult the local suppliers or the local conservation district for their recommendations because the appropriate mix depends on a variety of factors, including location, exposure, soil type, slope, and expected foot traffic. Alternative seed mixes approved by the local authority may be used.
 - Other mixes may be appropriate, depending on the soil type and hydrology of the area.
- [Table II-4.1.2 Temporary Erosion Control Seed Mix \(p.280\)](#) lists the standard mix for areas requiring a temporary vegetative cover.

Table II-4.1.2 Temporary Erosion Control Seed Mix

	% Weight	% Purity	% Germination
Chewings or annual blue grass <i>Festuca rubra var. commutata</i> or <i>Poa anna</i>	40	98	90
Perennial rye <i>Lolium perenne</i>	50	98	90
Redtop or colonial bentgrass <i>Agrostis alba</i> or <i>Agrostis tenuis</i>	5	92	85
White dutch clover <i>Trifolium repens</i>	5	98	90

- [Table II-4.1.3 Landscaping Seed Mix \(p.281\)](#) lists a recommended mix for landscaping seed.

Table II-4.1.3 Landscaping Seed Mix

	% Weight	% Purity	% Germination
Perennial rye blend <i>Lolium perenne</i>	70	98	90
Chewings and red fescue blend <i>Festuca rubra</i> var. <i>commutata</i> or <i>Festuca rubra</i>	30	98	90

- [Table II-4.1.4 Low-Growing Turf Seed Mix \(p.281\)](#) lists a turf seed mix for dry situations where there is no need for watering. This mix requires very little maintenance.

Table II-4.1.4 Low-Growing Turf Seed Mix

	% Weight	% Purity	% Germination
Dwarf tall fescue (several varieties) <i>Festuca arundinacea</i> var.	45	98	90
Dwarf perennial rye (Barclay) <i>Lolium perenne</i> var. <i>barclay</i>	30	98	90
Red fescue <i>Festuca rubra</i>	20	98	90
Colonial bentgrass <i>Agrostis tenuis</i>	5	98	90

- [Table II-4.1.5 Bioswale Seed Mix* \(p.281\)](#) lists a mix for bioswales and other intermittently wet areas.

Table II-4.1.5 Bioswale Seed Mix*

	% Weight	% Purity	% Germination
Tall or meadow fescue <i>Festuca arundinacea</i> or <i>Festuca elatior</i>	75-80	98	90
Seaside/Creeping bentgrass <i>Agrostis palustris</i>	10-15	92	85
Redtop bentgrass <i>Agrostis alba</i> or <i>Agrostis gigantea</i>	5-10	90	80
* Modified Briargreen, Inc. Hydroseeding Guide Wetlands Seed Mix			

- [Table II-4.1.6 Wet Area Seed Mix* \(p.282\)](#) lists a low-growing, relatively non-invasive seed mix appropriate for very wet areas that are not regulated wetlands. Apply

this mixture at a rate of 60 pounds per acre. Consult Hydraulic Permit Authority (HPA) for seed mixes if applicable.

Table II-4.1.6 Wet Area Seed Mix*

	% Weight	% Purity	% Germination
Tall or meadow fescue <i>Festuca arundinacea</i> or <i>Festuca elatior</i>	60-70	98	90
Seaside/Creeping bentgrass <i>Agrostis palustris</i>	10-15	98	85
Meadow foxtail <i>Alepocurus pratensis</i>	10-15	90	80
Alsike clover <i>Trifolium hybridum</i>	1-6	98	90
Redtop bentgrass <i>Agrostis alba</i>	1-6	92	85
* Modified Briargreen, Inc. Hydroseeding Guide Wetlands Seed Mix			

- [Table II-4.1.7 Meadow Seed Mix \(p.282\)](#) lists a recommended meadow seed mix for infrequently maintained areas or non-maintained areas where colonization by native plants is desirable. Likely applications include rural road and utility right-of-way. Seeding should take place in September or very early October in order to obtain adequate establishment prior to the winter months. Consider the appropriateness of clover, a fairly invasive species, in the mix. Amending the soil can reduce the need for clover.

Table II-4.1.7 Meadow Seed Mix

	% Weight	% Purity	% Germination
Redtop or Oregon bentgrass <i>Agrostis alba</i> or <i>Agrostis oregonensis</i>	20	92	85
Red fescue <i>Festuca rubra</i>	70	98	90
White dutch clover <i>Trifolium repens</i>	10	98	90

• **Roughening and Rototilling:**

- The seedbed should be firm and rough. Roughen all soil no matter what the slope. Track walk slopes before seeding if engineering purposes require

compaction. Backblading or smoothing of slopes greater than 4H:1V is not allowed if they are to be seeded.

- Restoration-based landscape practices require deeper incorporation than that provided by a simple single-pass rototilling treatment. Wherever practical, initially rip the subgrade to improve long-term permeability, infiltration, and water inflow qualities. At a minimum, permanent areas shall use soil amendments to achieve organic matter and permeability performance defined in engineered soil/landscape systems. For systems that are deeper than 8 inches complete the rototilling process in multiple lifts, or prepare the engineered soil system per specifications and place to achieve the specified depth.

- **Fertilizers:**

- Conducting soil tests to determine the exact type and quantity of fertilizer is recommended. This will prevent the over-application of fertilizer.
- Organic matter is the most appropriate form of fertilizer because it provides nutrients (including nitrogen, phosphorus, and potassium) in the least water-soluble form.
- In general, use 10-4-6 N-P-K (nitrogen-phosphorus-potassium) fertilizer at a rate of 90 pounds per acre. Always use slow-release fertilizers because they are more efficient and have fewer environmental impacts. Do not add fertilizer to the hydromulch machine, or agitate, more than 20 minutes before use. Too much agitation destroys the slow-release coating.
- There are numerous products available that take the place of chemical fertilizers. These include several with seaweed extracts that are beneficial to soil microbes and organisms. If 100 percent cottonseed meal is used as the mulch in hydroseed, chemical fertilizer may not be necessary. Cottonseed meal provides a good source of long-term, slow-release, available nitrogen.

- **Bonded Fiber Matrix and Mechanically Bonded Fiber Matrix:**

- On steep slopes use Bonded Fiber Matrix (BFM) or Mechanically Bonded Fiber Matrix (MBFM) products. Apply BFM/MBFM products at a minimum rate of 3,000 pounds per acre of mulch with approximately 10 percent tackifier. Achieve a minimum of 95 percent soil coverage during application. Numerous products are available commercially. Installed products per manufacturer's instructions. Most products require 24-36 hours to cure before rainfall and cannot be installed on wet or saturated soils. Generally, products come in 40-50 pound bags and include all necessary ingredients except for seed and fertilizer.

blanket and be stapled. On steeper slopes, this overlap should be installed in a small trench, stapled, and covered with soil.

- With the variety of products available, it is impossible to cover all the details of appropriate use and installation. Therefore, it is critical that the design engineer consult the manufacturer's information and that a site visit takes place in order to ensure that the product specified is appropriate. Information is also available at the following web sites:

1. WSDOT (Section 3.2.4):

<http://www.wsdot.wa.gov/NR/rdonlyres/3B41E087-FA86-4717-932D-D7A8556CCD57/0/ErosionTrainingManual.pdf>

2. Texas Transportation Institute:

http://www.txdot.gov/business/doing_business/product_evaluation/erosion_control.htm

- Use jute matting in conjunction with mulch ([BMP C121: Mulching \(p.284\)](#)). Excelsior, woven straw blankets and coir (coconut fiber) blankets may be installed without mulch. There are many other types of erosion control nets and blankets on the market that may be appropriate in certain circumstances.
- In general, most nets (e.g., jute matting) require mulch in order to prevent erosion because they have a fairly open structure. Blankets typically do not require mulch because they usually provide complete protection of the surface.
- Extremely steep, unstable, wet, or rocky slopes are often appropriate candidates for use of synthetic blankets, as are riverbanks, beaches and other high-energy environments. If synthetic blankets are used, the soil should be hydromulched first.
- 100-percent biodegradable blankets are available for use in sensitive areas. These organic blankets are usually held together with a paper or fiber mesh and stitching which may last up to a year.
- Most netting used with blankets is photodegradable, meaning they break down under sunlight (not UV stabilized). However, this process can take months or years even under bright sun. Once vegetation is established, sunlight does not reach the mesh. It is not uncommon to find non-degraded netting still in place several years after installation. This can be a problem if maintenance requires the use of mowers or ditch cleaning equipment. In addition, birds and small animals can become trapped in the netting.

Maintenance Standards

- Maintain good contact with the ground. Erosion must not occur beneath the net or blanket.

- Repair and staple any areas of the net or blanket that are damaged or not in close contact with the ground.
- Fix and protect eroded areas if erosion occurs due to poorly controlled drainage.

Figure II-4.1.3 Channel Installation

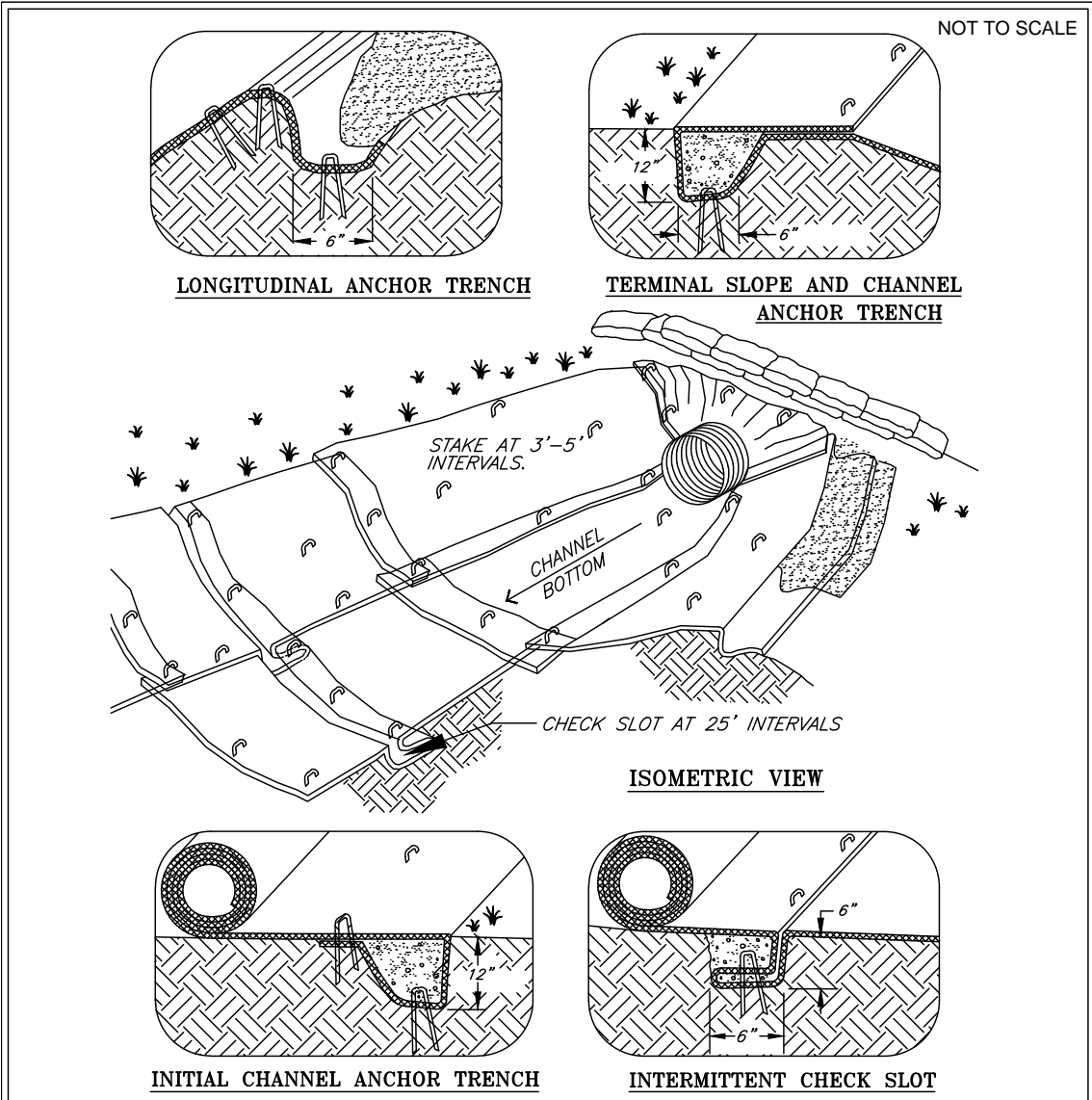

Source: Clackamas County 2009
Erosion Prevention Planning and
Design Manual

- Notes:
1. Check slots to be constructed per manufacturers specifications.
 2. Staking or stapling layout per manufacturers specifications.

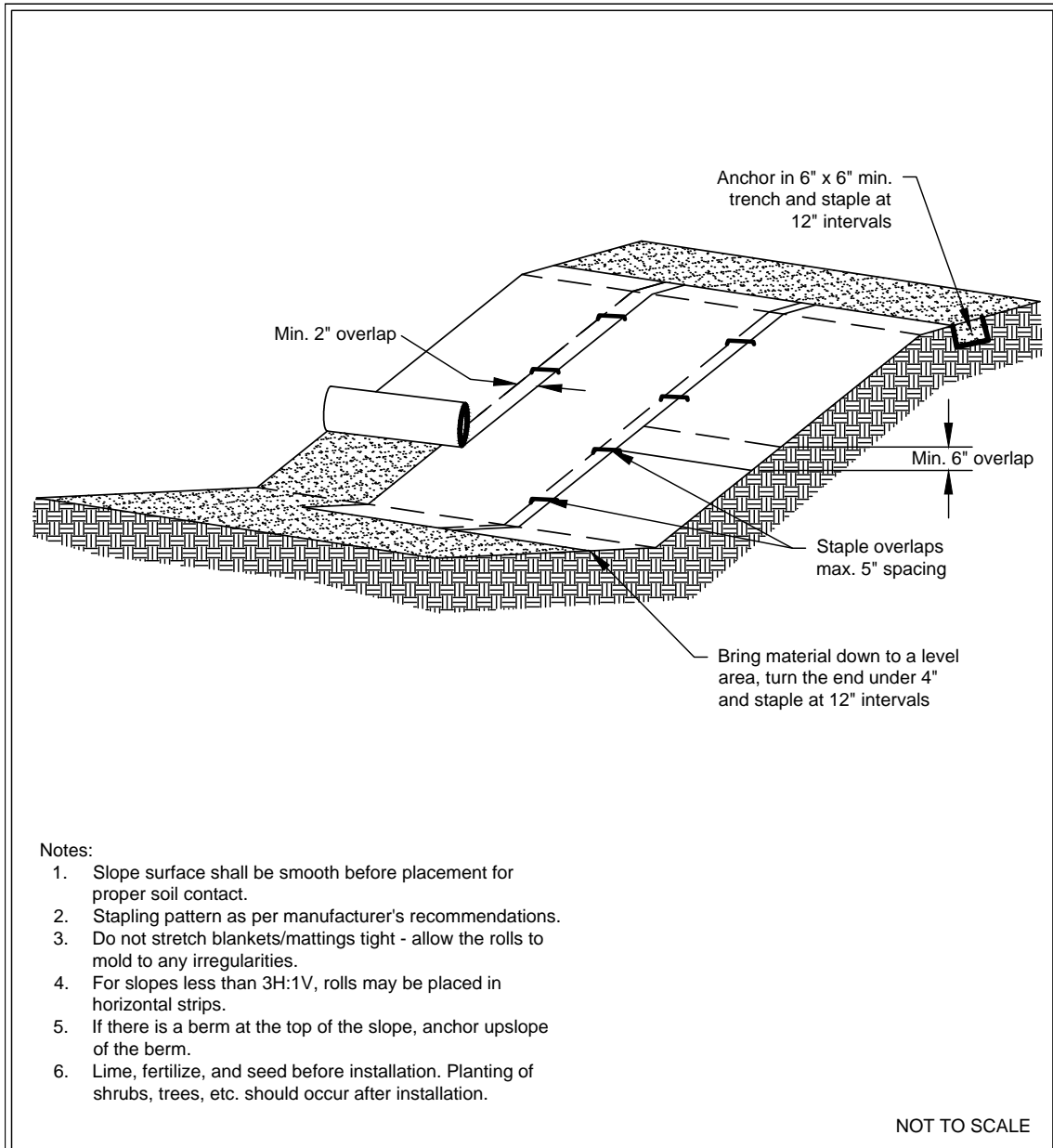

Figure II-4.1.3 Channel Installation

Revised June 2015

Please see <http://www.ecy.wa.gov/copyright.html> for copyright notice including permissions, limitation of liability, and disclaimer.

Figure II-4.1.4 Slope Installation



Notes:

1. Slope surface shall be smooth before placement for proper soil contact.
2. Stapling pattern as per manufacturer's recommendations.
3. Do not stretch blankets/mattings tight - allow the rolls to mold to any irregularities.
4. For slopes less than 3H:1V, rolls may be placed in horizontal strips.
5. If there is a berm at the top of the slope, anchor upslope of the berm.
6. Lime, fertilize, and seed before installation. Planting of shrubs, trees, etc. should occur after installation.



**Figure II-4.1.4
Slope Installation**

Revised June 2015

Please see <http://www.ecy.wa.gov/copyright.html> for copyright notice including permissions, limitation of liability, and disclaimer.

BMP C123: Plastic Covering

Purpose

Plastic covering provides immediate, short-term erosion protection to slopes and disturbed areas.

Conditions of Use

Plastic covering may be used on disturbed areas that require cover measures for less than 30 days, except as stated below.

- Plastic is particularly useful for protecting cut and fill slopes and stockpiles. Note: The relatively rapid breakdown of most polyethylene sheeting makes it unsuitable for long-term (greater than six months) applications.
- Due to rapid runoff caused by plastic covering, do not use this method upslope of areas that might be adversely impacted by concentrated runoff. Such areas include steep and/or unstable slopes.
- Plastic sheeting may result in increased runoff volumes and velocities, requiring additional on-site measures to counteract the increases. Creating a trough with wattles or other material can convey clean water away from these areas.
- To prevent undercutting, trench and backfill rolled plastic covering products.
- While plastic is inexpensive to purchase, the added cost of installation, maintenance, removal, and disposal make this an expensive material, up to \$1.50-2.00 per square yard.
- Whenever plastic is used to protect slopes install water collection measures at the base of the slope. These measures include plastic-covered berms, channels, and pipes used to convey clean rainwater away from bare soil and disturbed areas. Do not mix clean runoff from a plastic covered slope with dirty runoff from a project.
- Other uses for plastic include:
 1. Temporary ditch liner.
 2. Pond liner in temporary sediment pond.
 3. Liner for bermed temporary fuel storage area if plastic is not reactive to the type of fuel being stored.
 4. Emergency slope protection during heavy rains.
 5. Temporary drainpipe (“elephant trunk”) used to direct water.

Design and Installation Specifications

- Plastic slope cover must be installed as follows:
 1. Run plastic up and down slope, not across slope.
 2. Plastic may be installed perpendicular to a slope if the slope length is less than 10 feet.
 3. Minimum of 8-inch overlap at seams.
 4. On long or wide slopes, or slopes subject to wind, tape all seams.
 5. Place plastic into a small (12-inch wide by 6-inch deep) slot trench at the top of the slope and backfill with soil to keep water from flowing underneath.
 6. Place sand filled burlap or geotextile bags every 3 to 6 feet along seams and tie them together with twine to hold them in place.
 7. Inspect plastic for rips, tears, and open seams regularly and repair immediately. This prevents high velocity runoff from contacting bare soil which causes extreme erosion.
 8. Sandbags may be lowered into place tied to ropes. However, all sandbags must be staked in place.
- Plastic sheeting shall have a minimum thickness of 0.06 millimeters.
- If erosion at the toe of a slope is likely, a gravel berm, riprap, or other suitable protection shall be installed at the toe of the slope in order to reduce the velocity of runoff.

Maintenance Standards

- Torn sheets must be replaced and open seams repaired.
- Completely remove and replace the plastic if it begins to deteriorate due to ultra-violet radiation.
- Completely remove plastic when no longer needed.
- Dispose of old tires used to weight down plastic sheeting appropriately.

Approved as Equivalent

Ecology has approved products as able to meet the requirements of [BMP C123: Plastic Covering](#). The products did not pass through the Technology Assessment Protocol – Ecology (TAPE) process. Local jurisdictions may choose not to accept this product approved as equivalent, or may require additional testing prior to consideration for local use. The products are available for review on Ecology’s website at <http://www.ecy.wa.gov/programs/wq/stormwater/newtech/equivalent.html>

BMP C140: Dust Control

Purpose

Dust control prevents wind transport of dust from disturbed soil surfaces onto roadways, drainage ways, and surface waters.

Conditions of Use

- In areas (including roadways) subject to surface and air movement of dust where on-site and off-site impacts to roadways, drainage ways, or surface waters are likely.

Design and Installation Specifications

- Vegetate or mulch areas that will not receive vehicle traffic. In areas where planting, mulching, or paving is impractical, apply gravel or landscaping rock.
- Limit dust generation by clearing only those areas where immediate activity will take place, leaving the remaining area(s) in the original condition. Maintain the original ground cover as long as practical.
- Construct natural or artificial windbreaks or windscreens. These may be designed as enclosures for small dust sources.
- Sprinkle the site with water until surface is wet. Repeat as needed. To prevent carryout of mud onto street, refer to [BMP C105: Stabilized Construction Entrance / Exit \(p.270\)](#).
- Irrigation water can be used for dust control. Irrigation systems should be installed as a first step on sites where dust control is a concern.
- Spray exposed soil areas with a dust palliative, following the manufacturer's instructions and cautions regarding handling and application. Used oil is prohibited from use as a dust suppressant. Local governments may approve other dust palliatives such as calcium chloride or PAM.
- PAM ([BMP C126: Polyacrylamide \(PAM\) for Soil Erosion Protection \(p.300\)](#)) added to water at a rate of 0.5 lbs. per 1,000 gallons of water per acre and applied from a water truck is more effective than water alone. This is due to increased infiltration of water into the soil and reduced evaporation. In addition, small soil particles are bonded together and are not as easily transported by wind. Adding PAM may actually reduce the quantity of water needed for dust control. Use of PAM could be a cost-effective dust control method.

Techniques that can be used for unpaved roads and lots include:

- Lower speed limits. High vehicle speed increases the amount of dust stirred up from unpaved roads and lots.
- Upgrade the road surface strength by improving particle size, shape, and mineral types that make up the surface and base materials.
- Add surface gravel to reduce the source of dust emission. Limit the amount of fine particles (those smaller than .075 mm) to 10 to 20 percent.
- Use geotextile fabrics to increase the strength of new roads or roads undergoing reconstruction.
- Encourage the use of alternate, paved routes, if available.
- Restrict use of paved roadways by tracked vehicles and heavy trucks to prevent damage to road surface and base.
- Apply chemical dust suppressants using the admix method, blending the product with the top few inches of surface material. Suppressants may also be applied as surface treatments.
- Pave unpaved permanent roads and other trafficked areas.
- Use vacuum street sweepers.
- Remove mud and other dirt promptly so it does not dry and then turn into dust.
- Limit dust-causing work on windy days.
- Contact your local Air Pollution Control Authority for guidance and training on other dust control measures. Compliance with the local Air Pollution Control Authority constitutes compliance with this BMP.

Maintenance Standards

Respray area as necessary to keep dust to a minimum.

BMP C150: Materials on Hand

Purpose

Keep quantities of erosion prevention and sediment control materials on the project site at all times to be used for regular maintenance and emergency situations such as unexpected heavy summer rains. Having these materials on-site reduces the time needed to implement BMPs when inspections indicate that existing BMPs are not meeting the Construction SWPPP requirements. In addition, contractors can save money by buying some materials in bulk and storing them at their office or yard.

Conditions of Use

- Construction projects of any size or type can benefit from having materials on hand. A small commercial development project could have a roll of plastic and some gravel available for immediate protection of bare soil and temporary berm construction. A large earthwork project, such as highway construction, might have several tons of straw, several rolls of plastic, flexible pipe, sandbags, geotextile fabric and steel “T” posts.
- Materials are stockpiled and readily available before any site clearing, grubbing, or earthwork begins. A large contractor or developer could keep a stockpile of materials that are available for use on several projects.
- If storage space at the project site is at a premium, the contractor could maintain the materials at their office or yard. The office or yard must be less than an hour from the project site.

Design and Installation Specifications

Depending on project type, size, complexity, and length, materials and quantities will vary. A good minimum list of items that will cover numerous situations includes:

Material
Clear Plastic, 6 mil
Drainpipe, 6 or 8 inch diameter
Sandbags, filled
Straw Bales for mulching,
Quarry Spalls
Washed Gravel
Geotextile Fabric
Catch Basin Inserts
Steel "T" Posts
Silt fence material
Straw Wattles

Maintenance Standards

- All materials with the exception of the quarry spalls, steel “T” posts, and gravel should be kept covered and out of both sun and rain.
- Re-stock materials used as needed.

BMP C151: Concrete Handling

Purpose

Concrete work can generate process water and slurry that contain fine particles and high pH, both of which can violate water quality standards in the receiving water. Concrete spillage or concrete discharge to surface waters of the State is prohibited. Use this BMP to minimize and eliminate concrete, concrete process water, and concrete slurry from entering waters of the state.

Conditions of Use

Any time concrete is used, utilize these management practices. Concrete construction projects include, but are not limited to, the following:

- Curbs
- Sidewalks
- Roads
- Bridges
- Foundations
- Floors
- Runways

Design and Installation Specifications

- Assure that washout of concrete trucks, chutes, pumps, and internals is performed at an approved off-site location or in designated concrete washout areas. Do not wash out concrete trucks onto the ground, or into storm drains, open ditches, streets, or streams. Refer to [BMP C154: Concrete Washout Area \(p.317\)](#) for information on concrete washout areas.
- Return unused concrete remaining in the truck and pump to the originating batch plant for recycling. Do not dump excess concrete on site, except in designated concrete washout areas.
- Wash off hand tools including, but not limited to, screeds, shovels, rakes, floats, and trowels into formed areas only.
- Wash equipment difficult to move, such as concrete pavers in areas that do not directly drain to natural or constructed stormwater conveyances.
- Do not allow washdown from areas, such as concrete aggregate driveways, to drain directly to natural or constructed stormwater conveyances.
- Contain washwater and leftover product in a lined container when no formed areas

are available. Dispose of contained concrete in a manner that does not violate ground water or surface water quality standards.

- Always use forms or solid barriers for concrete pours, such as pilings, within 15-feet of surface waters.
- Refer to [BMP C252: High pH Neutralization Using CO2 \(p.409\)](#) and [BMP C253: pH Control for High pH Water \(p.412\)](#) for pH adjustment requirements.
- Refer to the Construction Stormwater General Permit for pH monitoring requirements if the project involves one of the following activities:
 - Significant concrete work (greater than 1,000 cubic yards poured concrete or recycled concrete used over the life of a project).
 - The use of engineered soils amended with (but not limited to) Portland cement-treated base, cement kiln dust or fly ash.
 - Discharging stormwater to segments of water bodies on the 303(d) list (Category 5) for high pH.

Maintenance Standards

Check containers for holes in the liner daily during concrete pours and repair the same day.

BMP C152: Sawcutting and Surfacing Pollution Prevention

Purpose

Sawcutting and surfacing operations generate slurry and process water that contains fine particles and high pH (concrete cutting), both of which can violate the water quality standards in the receiving water. Concrete spillage or concrete discharge to surface waters of the State is prohibited. Use this BMP to minimize and eliminate process water and slurry created through sawcutting or surfacing from entering waters of the State.

Conditions of Use

Utilize these management practices anytime sawcutting or surfacing operations take place. Sawcutting and surfacing operations include, but are not limited to, the following:

- Sawing
- Coring
- Grinding
- Roughening

- Hydro-demolition
- Bridge and road surfacing

Design and Installation Specifications

- Vacuum slurry and cuttings during cutting and surfacing operations.
- Slurry and cuttings shall not remain on permanent concrete or asphalt pavement overnight.
- Slurry and cuttings shall not drain to any natural or constructed drainage conveyance including stormwater systems. This may require temporarily blocking catch basins.
- Dispose of collected slurry and cuttings in a manner that does not violate ground water or surface water quality standards.
- Do not allow process water generated during hydro-demolition, surface roughening or similar operations to drain to any natural or constructed drainage conveyance including stormwater systems. Dispose process water in a manner that does not violate ground water or surface water quality standards.
- Handle and dispose cleaning waste material and demolition debris in a manner that does not cause contamination of water. Dispose of sweeping material from a pick-up sweeper at an appropriate disposal site.

Maintenance Standards

Continually monitor operations to determine whether slurry, cuttings, or process water could enter waters of the state. If inspections show that a violation of water quality standards could occur, stop operations and immediately implement preventive measures such as berms, barriers, secondary containment, and vacuum trucks.

BMP C153: Material Delivery, Storage and Containment

Purpose

Prevent, reduce, or eliminate the discharge of pollutants to the stormwater system or watercourses from material delivery and storage. Minimize the storage of hazardous materials on-site, store materials in a designated area, and install secondary containment.

Conditions of Use

These procedures are suitable for use at all construction sites with delivery and storage of the following materials:

BMP C160: Certified Erosion and Sediment Control Lead

Purpose

The project proponent designates at least one person as the responsible representative in charge of erosion and sediment control (ESC), and water quality protection. The designated person shall be the Certified Erosion and Sediment Control Lead (CESCL) who is responsible for ensuring compliance with all local, state, and federal erosion and sediment control and water quality requirements.

Conditions of Use

A CESCL shall be made available on projects one acre or larger that discharge stormwater to surface waters of the state. Sites less than one acre may have a person without CESCL certification conduct inspections; sampling is not required on sites that disturb less than an acre.

- The CESCL shall:
 - Have a current certificate proving attendance in an erosion and sediment control training course that meets the minimum ESC training and certification requirements established by Ecology (see details below).

Ecology will maintain a list of ESC training and certification providers at:
<http://www.ecy.wa.gov/programs/wq/stormwater/cescl.html>

OR

- Be a Certified Professional in Erosion and Sediment Control (CPESC); for additional information go to: <http://www.envirocertintl.org/cpesc/>

Specifications

- Certification shall remain valid for three years.
- The CESCL shall have authority to act on behalf of the contractor or developer and shall be available, or on-call, 24 hours per day throughout the period of construction.
- The Construction SWPPP shall include the name, telephone number, fax number, and address of the designated CESCL.
- A CESCL may provide inspection and compliance services for multiple construction projects in the same geographic region.

Duties and responsibilities of the CESCL shall include, but are not limited to the following:

- Maintaining permit file on site at all times which includes the Construction SWPPP and any associated permits and plans.
- Directing BMP installation, inspection, maintenance, modification, and removal.
- Updating all project drawings and the Construction SWPPP with changes made.
- Completing any sampling requirements including reporting results using WebDMR.
- Keeping daily logs, and inspection reports. Inspection reports should include:
 - Inspection date/time.
 - Weather information; general conditions during inspection and approximate amount of precipitation since the last inspection.
 - A summary or list of all BMPs implemented, including observations of all erosion/sediment control structures or practices. The following shall be noted:
 1. Locations of BMPs inspected.
 2. Locations of BMPs that need maintenance.
 3. Locations of BMPs that failed to operate as designed or intended.
 4. Locations of where additional or different BMPs are required.
 - Visual monitoring results, including a description of discharged stormwater. The presence of suspended sediment, turbid water, discoloration, and oil sheen shall be noted, as applicable.
 - Any water quality monitoring performed during inspection.
 - General comments and notes, including a brief description of any BMP repairs, maintenance or installations made as a result of the inspection.
- Facilitate, participate in, and take corrective actions resulting from inspections performed by outside agencies or the owner.

BMP C162: Scheduling

Purpose

Sequencing a construction project reduces the amount and duration of soil exposed to erosion by wind, rain, runoff, and vehicle tracking.

Conditions of Use

The construction sequence schedule is an orderly listing of all major land-disturbing activities together with the necessary erosion and sedimentation control measures

planned for the project. This type of schedule guides the contractor on work to be done before other work is started so that serious erosion and sedimentation problems can be avoided.

Following a specified work schedule that coordinates the timing of land-disturbing activities and the installation of control measures is perhaps the most cost-effective way of controlling erosion during construction. The removal of surface ground cover leaves a site vulnerable to accelerated erosion. Construction procedures that limit land clearing provide timely installation of erosion and sedimentation controls, and restore protective cover quickly can significantly reduce the erosion potential of a site.

Design Considerations

- Minimize construction during rainy periods.
- Schedule projects to disturb only small portions of the site at any one time. Complete grading as soon as possible. Immediately stabilize the disturbed portion before grading the next portion. Practice staged seeding in order to revegetate cut and fill slopes as the work progresses.

II-4.2 Runoff Conveyance and Treatment BMPs

This section contains the standards and specifications for Runoff Conveyance and Treatment BMPs. [Table II-4.2.1 Runoff Conveyance and Treatment BMPs by SWPPP Element \(p.327\)](#), below, shows the relationship of the BMPs in [II-4.2 Runoff Conveyance and Treatment BMPs](#) to the Construction Stormwater Pollution Prevention Plan (SWPPP) Elements described in [II-3.3.3 Step 3 - Construction SWPPP Development and Implementation \(p.236\)](#).

Table II-4.2.1 Runoff Conveyance and Treatment BMPs by SWPPP Element

BMP or Element Name	Element #3 Control Flow Rates	Element #4 Install Sediment Controls	Element #6 Protect Slopes	Element #7 Protect Drain Inlets	Element #8 Stabilize Channels and Outlets	Element #9 Control Pollutants	Element #10 Control De-Watering	Element #13 Protect Low Impact Development
BMP C200: Interceptor Dike and Swale (p.331)			✓					✓

**Table II-4.2.1 Runoff Conveyance and Treatment BMPs by SWPPP
Element (continued)**

BMP or Element Name	Element #3 Control Flow Rates	Element #4 Install Sediment Controls	Element #6 Protect Slopes	Element #7 Protect Drain Inlets	Element #8 Stabilize Channels and Outlets	Element #9 Control Pollutants	Element #10 Control De-Watering	Element #13 Protect Low Impact Development
BMP C201: Grass-Lined Channels (p.333)			✓					✓
BMP C202: Channel Lining (p.338)					✓			
BMP C203: Water Bars (p.339)	✓		✓				✓	
BMP C204: Pipe Slope Drains (p.342)			✓					
BMP C205: Subsurface Drains (p.346)			✓					
BMP C206: Level Spreader (p.348)			✓				✓	
BMP C207: Check Dams (p.352)	✓		✓		✓			✓
BMP C208: Triangular Silt Dike (TSD) (Geo-			✓					✓

**Table II-4.2.1 Runoff Conveyance and Treatment BMPs by SWPPP
Element (continued)**

BMP or Element Name	Element #3 Control Flow Rates	Element #4 Install Sediment Controls	Element #6 Protect Slopes	Element #7 Protect Drain Inlets	Element #8 Stabilize Channels and Outlets	Element #9 Control Pollutants	Element #10 Control De-Watering	Element #13 Protect Low Impact Development
textile-Encased Check Dam (p.355)								
BMP C209: Outlet Protection (p.356)	✓				✓			
BMP C220: Storm Drain Inlet Protection (p.357)				✓				
BMP C231: Brush Barrier (p.365)		✓						✓
BMP C232: Gravel Filter Berm (p.367)		✓						
BMP C233: Silt Fence (p.367)		✓						✓
BMP C234: Vegetated Strip (p.375)		✓						✓
BMP C235: Wattles (p.376)	✓	✓						
BMP C236:							✓	

**Table II-4.2.1 Runoff Conveyance and Treatment BMPs by SWPPP
Element (continued)**

BMP or Element Name	Element #3 Control Flow Rates	Element #4 Install Sediment Controls	Element #6 Protect Slopes	Element #7 Protect Drain Inlets	Element #8 Stabilize Channels and Outlets	Element #9 Control Pollutants	Element #10 Control De-Watering	Element #13 Protect Low Impact Development
Vegetative Filtration (p.379)								
BMP C240: Sediment Trap (p.383)	✓	✓						
BMP C241: Temporary Sediment Pond (p.388)	✓	✓						
BMP C250: Construction Stormwater Chemical Treatment (p.396)		✓				✓		
BMP C251: Construction Stormwater Filtration (p.404)		✓				✓		
BMP C252: High pH Neutralization Using CO2 (p.409)						✓		
BMP C253: pH Control						✓		

**Table II-4.2.1 Runoff Conveyance and Treatment BMPs by SWPPP
Element (continued)**

BMP or Element Name	Element #3 Control Flow Rates	Element #4 Install Sediment Controls	Element #6 Protect Slopes	Element #7 Protect Drain Inlets	Element #8 Stabilize Channels and Outlets	Element #9 Control Pollutants	Element #10 Control De-Watering	Element #13 Protect Low Impact Development
for High pH Water (p.412)								

BMP C200: Interceptor Dike and Swale

Purpose

Provide a ridge of compacted soil, or a ridge with an upslope swale, at the top or base of a disturbed slope or along the perimeter of a disturbed construction area to convey stormwater. Use the dike and/or swale to intercept the runoff from unprotected areas and direct it to areas where erosion can be controlled. This can prevent storm runoff from entering the work area or sediment-laden runoff from leaving the construction site.

Conditions of Use

Where the runoff from an exposed site or disturbed slope must be conveyed to an erosion control facility which can safely convey the stormwater.

- Locate upslope of a construction site to prevent runoff from entering disturbed area.
- When placed horizontally across a disturbed slope, it reduces the amount and velocity of runoff flowing down the slope.
- Locate downslope to collect runoff from a disturbed area and direct water to a sediment basin.

Design and Installation Specifications

- Dike and/or swale and channel must be stabilized with temporary or permanent vegetation or other channel protection during construction.
- Channel requires a positive grade for drainage; steeper grades require channel protection and check dams.
- Review construction for areas where overtopping may occur.
- Can be used at top of new fill before vegetation is established.

- May be used as a permanent diversion channel to carry the runoff.
- Sub-basin tributary area should be one acre or less.
- Design capacity for the peak volumetric flow rate calculated using a 10-minute time step from a 10-year, 24-hour storm, assuming a Type 1A rainfall distribution, for temporary facilities. Alternatively, use 1.6 times the 10-year, 1-hour flow indicated by an approved continuous runoff model. For facilities that will also serve on a permanent basis, consult the local government's drainage requirements.

Interceptor dikes shall meet the following criteria:

- Top Width: 2 feet minimum.
- Height: 1.5 feet minimum on berm.
- Side Slope: 2H:1V or flatter.
- Grade: Depends on topography, however, dike system minimum is 0.5%, and maximum is 1%.
- Compaction: Minimum of 90 percent ASTM D698 standard proctor.
- Horizontal Spacing of Interceptor Dikes:

Average Slope	Slope Percent	Flowpath Length
20H:1V or less	3-5%	300 feet
(10 to 20)H:1V	5-10%	200 feet
(4 to 10)H:1V	10-25%	100 feet
(2 to 4)H:1V	25-50%	50 feet

- Stabilization: depends on velocity and reach
- Slopes <5%: Seed and mulch applied within 5 days of dike construction (see [BMP C121: Mulching \(p.284\)](#)).
- Slopes 5 - 40%: Dependent on runoff velocities and dike materials. Stabilization should be done immediately using either sod or riprap or other measures to avoid erosion.
- The upslope side of the dike shall provide positive drainage to the dike outlet. No erosion shall occur at the outlet. Provide energy dissipation measures as necessary. Sediment-laden runoff must be released through a sediment trapping facility.
- Minimize construction traffic over temporary dikes. Use temporary cross culverts for channel crossing.

Interceptor swales shall meet the following criteria:

- Bottom Width: 2 feet minimum; the cross-section bottom shall be level.
- Depth: 1-foot minimum.

- Side Slope: 2H:1V or flatter.
- Grade: Maximum 5 percent, with positive drainage to a suitable outlet (such as a sediment pond).
- Stabilization: Seed as per [BMP C120: Temporary and Permanent Seeding \(p.278\)](#), or [BMP C202: Channel Lining \(p.338\)](#), 12 inches thick riprap pressed into the bank and extending at least 8 inches vertical from the bottom.

Inspect diversion dikes and interceptor swales once a week and after every rainfall. Immediately remove sediment from the flow area.

Damage caused by construction traffic or other activity must be repaired before the end of each working day.

Check outlets and make timely repairs as needed to avoid gully formation. When the area below the temporary diversion dike is permanently stabilized, remove the dike and fill and stabilize the channel to blend with the natural surface.

BMP C201: Grass-Lined Channels

Purpose

To provide a channel with a vegetative lining for conveyance of runoff. See [Figure II-4.2.1 Typical Grass-Lined Channels \(p.336\)](#) for typical grass-lined channels.

Conditions of Use

This practice applies to construction sites where concentrated runoff needs to be contained to prevent erosion or flooding.

- When a vegetative lining can provide sufficient stability for the channel cross section and at lower velocities of water (normally dependent on grade). This means that the channel slopes are generally less than 5 percent and space is available for a relatively large cross section.
- Typical uses include roadside ditches, channels at property boundaries, outlets for diversions, and other channels and drainage ditches in low areas.
- Channels that will be vegetated should be installed before major earthwork and hydroseeded with a bonded fiber matrix (BFM). The vegetation should be well established (i.e., 75 percent cover) before water is allowed to flow in the ditch. With channels that will have high flows, erosion control blankets should be installed over the hydroseed. If vegetation cannot be established from seed before water is allowed in the ditch, sod should be installed in the bottom of the ditch in lieu of hydromulch and blankets.

BMP C207: Check Dams

Purpose

Construction of small dams across a swale or ditch reduces the velocity of concentrated flow and dissipates energy at the check dam.

Conditions of Use

Where temporary channels or permanent channels are not yet vegetated, channel lining is infeasible, and/or velocity checks are required.

- Check dams may not be placed in streams unless approved by the State Department of Fish and Wildlife. Check dams may not be placed in wetlands without approval from a permitting agency.
- Do not place check dams below the expected backwater from any salmonid bearing water between October 1 and May 31 to ensure that there is no loss of high flow refuge habitat for overwintering juvenile salmonids and emergent salmonid fry.
- Construct rock check dams from appropriately sized rock. The rock used must be large enough to stay in place given the expected design flow through the channel. The rock must be placed by hand or by mechanical means (no dumping of rock to form dam) to achieve complete coverage of the ditch or swale and to ensure that the center of the dam is lower than the edges.
- Check dams may also be constructed of either rock or pea-gravel filled bags. Numerous new products are also available for this purpose. They tend to be reusable, quick and easy to install, effective, and cost efficient.
- Place check dams perpendicular to the flow of water.
- The dam should form a triangle when viewed from the side. This prevents undercutting as water flows over the face of the dam rather than falling directly onto the ditch bottom.
- Before installing check dams impound and bypass upstream water flow away from the work area. Options for bypassing include pumps, siphons, or temporary channels.
- Check dams in association with sumps work more effectively at slowing flow and retaining sediment than just a check dam alone. A deep sump should be provided immediately upstream of the check dam.
- In some cases, if carefully located and designed, check dams can remain as permanent installations with very minor regrading. They may be left as either spillways, in which case accumulated sediment would be graded and seeded, or as

check dams to prevent further sediment from leaving the site.

- The maximum spacing between the dams shall be such that the toe of the upstream dam is at the same elevation as the top of the downstream dam.
- Keep the maximum height at 2 feet at the center of the dam.
- Keep the center of the check dam at least 12 inches lower than the outer edges at natural ground elevation.
- Keep the side slopes of the check dam at 2H:1V or flatter.
- Key the stone into the ditch banks and extend it beyond the abutments a minimum of 18 inches to avoid washouts from overflow around the dam.
- Use filter fabric foundation under a rock or sand bag check dam. If a blanket ditch liner is used, filter fabric is not necessary. A piece of organic or synthetic blanket cut to fit will also work for this purpose.
- In the case of grass-lined ditches and swales, all check dams and accumulated sediment shall be removed when the grass has matured sufficiently to protect the ditch or swale - unless the slope of the swale is greater than 4 percent. The area beneath the check dams shall be seeded and mulched immediately after dam removal.
- Ensure that channel appurtenances, such as culvert entrances below check dams, are not subject to damage or blockage from displaced stones. [Figure II-4.2.7 Rock Check Dam \(p.354\)](#) depicts a typical rock check dam.

Maintenance Standards

Check dams shall be monitored for performance and sediment accumulation during and after each runoff producing rainfall. Sediment shall be removed when it reaches one half the sump depth.

- Anticipate submergence and deposition above the check dam and erosion from high flows around the edges of the dam.
- If significant erosion occurs between dams, install a protective riprap liner in that portion of the channel.

Approved as Equivalent

Ecology has approved products as able to meet the requirements of [BMP C207: Check Dams](#). The products did not pass through the Technology Assessment Protocol – Ecology (TAPE) process. Local jurisdictions may choose not to accept this product approved as equivalent, or may require additional testing prior to consideration for local use. The products are available for review on Ecology’s website at <http://www.ecy.wa.gov/programs/wq/stormwater/newtech/equivalent.html>

Figure II-4.2.7 Rock Check Dam

View Looking Upstream

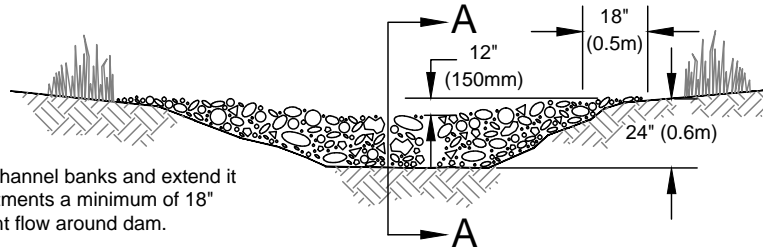

Note:
Key stone into channel banks and extend it beyond the abutments a minimum of 18" (0.5m) to prevent flow around dam.

Section A-A

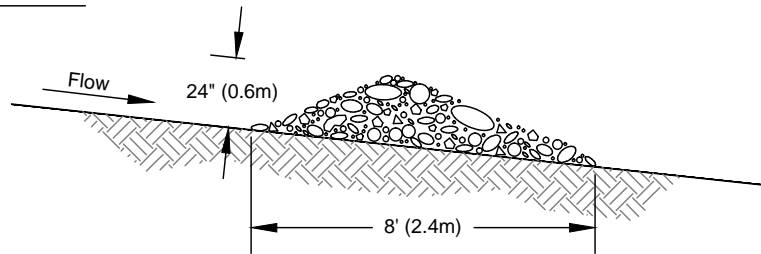

Spacing Between Check Dams

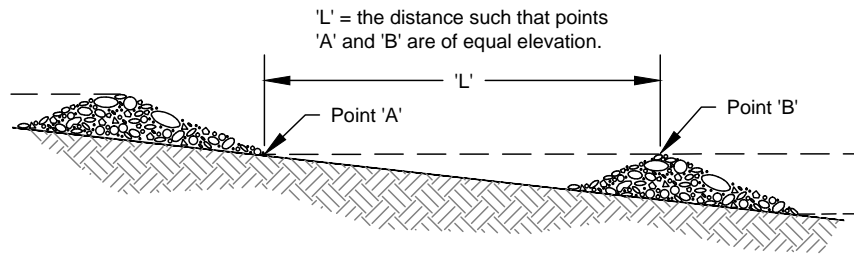

NOT TO SCALE



**Figure II-4.2.7
Rock Check Dam**

Revised July 2015

Please see <http://www.ecy.wa.gov/copyright.html> for copyright notice including permissions, limitation of liability, and disclaimer.

BMP C208: Triangular Silt Dike (TSD) (Geotextile-Encased Check Dam)

Purpose

Triangular silt dikes may be used as check dams, for perimeter protection, for temporary soil stockpile protection, for drop inlet protection, or as a temporary interceptor dike.

Conditions of Use

- May be used on soil or pavement with adhesive or staples.
- TSDs have been used to build temporary:
 1. sediment ponds;
 2. diversion ditches;
 3. concrete wash out facilities;
 4. curbing;
 5. water bars;
 6. level spreaders; and,
 7. berms.

Design and Installation Specifications

Made of urethane foam sewn into a woven geosynthetic fabric.

It is triangular, 10 inches to 14 inches high in the center, with a 20-inch to 28-inch base. A 2-foot apron extends beyond both sides of the triangle along its standard section of 7 feet. A sleeve at one end allows attachment of additional sections as needed.

- Install with ends curved up to prevent water from flowing around the ends.
- The fabric flaps and check dam units are attached to the ground with wire staples. Wire staples should be No. 11 gauge wire and should be 200 mm to 300 mm in length.
- When multiple units are installed, the sleeve of fabric at the end of the unit shall overlap the abutting unit and be stapled.
- Check dams should be located and installed as soon as construction will allow.
- Check dams should be placed perpendicular to the flow of water.
- When used as check dams, the leading edge must be secured with rocks, sand-bags, or a small key slot and staples.

- In the case of grass-lined ditches and swales, check dams and accumulated sediment shall be removed when the grass has matured sufficiently to protect the ditch or swale unless the slope of the swale is greater than 4 percent. The area beneath the check dams shall be seeded and mulched immediately after dam removal.

Maintenance Standards

- Triangular silt dams shall be inspected for performance and sediment accumulation during and after each runoff producing rainfall. Sediment shall be removed when it reaches one half the height of the dam.
- Anticipate submergence and deposition above the triangular silt dam and erosion from high flows around the edges of the dam. Immediately repair any damage or any undercutting of the dam.

BMP C209: Outlet Protection

Purpose

Outlet protection prevents scour at conveyance outlets and minimizes the potential for downstream erosion by reducing the velocity of concentrated stormwater flows.

Conditions of Use

Outlet protection is required at the outlets of all ponds, pipes, ditches, or other conveyances, and where runoff is conveyed to a natural or manmade drainage feature such as a stream, wetland, lake, or ditch.

Design and Installation Specifications

The receiving channel at the outlet of a culvert shall be protected from erosion by rock lining a minimum of 6 feet downstream and extending up the channel sides a minimum of 1-foot above the maximum tailwater elevation or 1-foot above the crown, whichever is higher. For large pipes (more than 18 inches in diameter), the outlet protection lining of the channel is lengthened to four times the diameter of the culvert.

- Standard wingwalls, and tapered outlets and paved channels should also be considered when appropriate for permanent culvert outlet protection. (See WSDOT Hydraulic Manual, available through WSDOT Engineering Publications).
- Organic or synthetic erosion blankets, with or without vegetation, are usually more effective than rock, cheaper, and easier to install. Materials can be chosen using manufacturer product specifications. ASTM test results are available for most products and the designer can choose the correct material for the expected flow.
- With low flows, vegetation (including sod) can be effective.
- The following guidelines shall be used for riprap outlet protection:

1. If the discharge velocity at the outlet is less than 5 fps (pipe slope less than 1 percent), use 2-inch to 8-inch riprap. Minimum thickness is 1-foot.
 2. For 5 to 10 fps discharge velocity at the outlet (pipe slope less than 3 percent), use 24-inch to 48-inch riprap. Minimum thickness is 2 feet.
 3. For outlets at the base of steep slope pipes (pipe slope greater than 10 percent), an engineered energy dissipater shall be used.
- Filter fabric or erosion control blankets should always be used under riprap to prevent scour and channel erosion.
 - New pipe outfalls can provide an opportunity for low-cost fish habitat improvements. For example, an alcove of low-velocity water can be created by constructing the pipe outfall and associated energy dissipater back from the stream edge and digging a channel, over-widened to the upstream side, from the outfall. Overwintering juvenile and migrating adult salmonids may use the alcove as shelter during high flows. Bank stabilization, bioengineering, and habitat features may be required for disturbed areas. This work may require a HPA. See [Volume V \(p.765\)](#) for more information on outfall system design.

Maintenance Standards

- Inspect and repair as needed.
- Add rock as needed to maintain the intended function.
- Clean energy dissipater if sediment builds up.

BMP C220: Storm Drain Inlet Protection

Purpose

Storm drain inlet protection prevents coarse sediment from entering drainage systems prior to permanent stabilization of the disturbed area.

Conditions of Use

Use storm drain inlet protection at inlets that are operational before permanent stabilization of the disturbed drainage area. Provide protection for all storm drain inlets downslope and within 500 feet of a disturbed or construction area, unless conveying runoff entering catch basins to a sediment pond or trap.

Also consider inlet protection for lawn and yard drains on new home construction. These small and numerous drains coupled with lack of gutters in new home construction can add significant amounts of sediment into the roof drain system. If possible delay installing lawn and yard drains until just before landscaping or cap these drains to pre-

vent sediment from entering the system until completion of landscaping. Provide 18-inches of sod around each finished lawn and yard drain.

[Table II-4.2.2 Storm Drain Inlet Protection \(p.358\)](#) lists several options for inlet protection. All of the methods for storm drain inlet protection tend to plug and require a high frequency of maintenance. Limit drainage areas to one acre or less. Possibly provide emergency overflows with additional end-of-pipe treatment where stormwater ponding would cause a hazard.

Table II-4.2.2 Storm Drain Inlet Protection

Type of Inlet Protection	Emergency Overflow	Applicable for Paved/ Earthen Surfaces	Conditions of Use
Drop Inlet Protection			
Excavated drop inlet protection	Yes, temporary flooding will occur	Earthen	Applicable for heavy flows. Easy to maintain. Large area Requirement: 30'x30'/acre
Block and gravel drop inlet protection	Yes	Paved or Earthen	Applicable for heavy concentrated flows. Will not pond.
Gravel and wire drop inlet protection	No		Applicable for heavy concentrated flows. Will pond. Can withstand traffic.
Catch basin filters	Yes	Paved or Earthen	Frequent Maintenance required.
Curb Inlet Protection			
Curb inlet protection with wooden weir	Small capacity overflow	Paved	Used for sturdy, more compact installation.
Block and gravel curb inlet protection	Yes	Paved	Sturdy, but limited filtration.
Culvert Inlet Protection			
Culvert inlet Sediment trap			18 month expected life.

Design and Installation Specifications

Excavated Drop Inlet Protection - An excavated impoundment around the storm drain. Sediment settles out of the stormwater prior to entering the storm drain.

- Provide a depth of 1-2 ft as measured from the crest of the inlet structure.
- Slope sides of excavation no steeper than 2H:1V.
- Minimum volume of excavation 35 cubic yards.
- Shape basin to fit site with longest dimension oriented toward the longest inflow area.
- Install provisions for draining to prevent standing water problems.
- Clear the area of all debris.
- Grade the approach to the inlet uniformly.
- Drill weep holes into the side of the inlet.
- Protect weep holes with screen wire and washed aggregate.
- Seal weep holes when removing structure and stabilizing area.
- Build a temporary dike, if necessary, to the down slope side of the structure to prevent bypass flow.

Block and Gravel Filter - A barrier formed around the storm drain inlet with standard concrete blocks and gravel. See [Figure II-4.2.8 Block and Gravel Filter \(p.360\)](#).

- Provide a height of 1 to 2 feet above inlet.
- Recess the first row 2-inches into the ground for stability.
- Support subsequent courses by placing a 2x4 through the block opening.
- Do not use mortar.
- Lay some blocks in the bottom row on their side for dewatering the pool.
- Place hardware cloth or comparable wire mesh with ½-inch openings over all block openings.
- Place gravel just below the top of blocks on slopes of 2H:1V or flatter.
- An alternative design is a gravel donut.
- Provide an inlet slope of 3H:1V.
- Provide an outlet slope of 2H:1V.
- Provide a 1-foot wide level stone area between the structure and the inlet.
- Use inlet slope stones 3 inches in diameter or larger.
- Use gravel ½- to ¾-inch at a minimum thickness of 1-foot for the outlet slope.

Figure II-4.2.8 Block and Gravel Filter

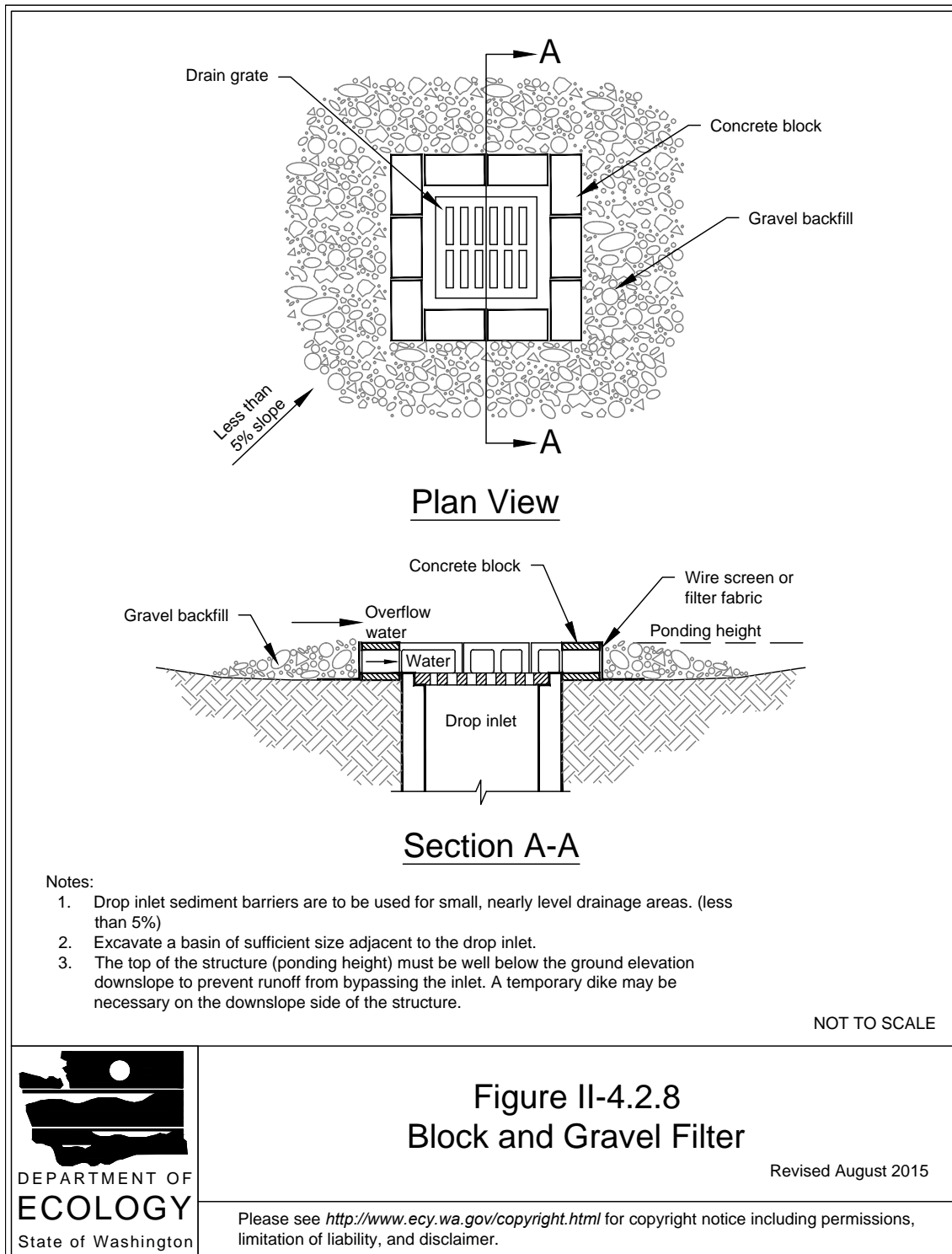

Gravel and Wire Mesh Filter - A gravel barrier placed over the top of the inlet. This structure does not provide an overflow.

- Use a hardware cloth or comparable wire mesh with ½-inch openings.
- Use coarse aggregate.
- Provide a height 1-foot or more, 18-inches wider than inlet on all sides.
- Place wire mesh over the drop inlet so that the wire extends a minimum of 1-foot beyond each side of the inlet structure.
- Overlap the strips if more than one strip of mesh is necessary.
- Place coarse aggregate over the wire mesh.
- Provide at least a 12-inch depth of gravel over the entire inlet opening and extend at least 18-inches on all sides.

Catchbasin Filters – Use inserts designed by manufacturers for construction sites. The limited sediment storage capacity increases the amount of inspection and maintenance required, which may be daily for heavy sediment loads. To reduce maintenance requirements combine a catchbasin filter with another type of inlet protection. This type of inlet protection provides flow bypass without overflow and therefore may be a better method for inlets located along active rights-of-way.

- Provides 5 cubic feet of storage.
- Requires dewatering provisions.
- Provides a high-flow bypass that will not clog under normal use at a construction site.
- Insert the catchbasin filter in the catchbasin just below the grating.

Curb Inlet Protection with Wooden Weir – Barrier formed around a curb inlet with a wooden frame and gravel.

- Use wire mesh with ½-inch openings.
- Use extra strength filter cloth.
- Construct a frame.
- Attach the wire and filter fabric to the frame.
- Pile coarse washed aggregate against wire/fabric.
- Place weight on frame anchors.

Block and Gravel Curb Inlet Protection – Barrier formed around a curb inlet with concrete blocks and gravel. See [Figure II-4.2.9 Block and Gravel Curb Inlet Protection \(p.363\)](#).

- Use wire mesh with ½-inch openings.
- Place two concrete blocks on their sides abutting the curb at either side of the inlet opening. These are spacer blocks.
- Place a 2x4 stud through the outer holes of each spacer block to align the front blocks.
- Place blocks on their sides across the front of the inlet and abutting the spacer blocks.
- Place wire mesh over the outside vertical face.
- Pile coarse aggregate against the wire to the top of the barrier.

Curb and Gutter Sediment Barrier – Sandbag or rock berm (riprap and aggregate) 3 feet high and 3 feet wide in a horseshoe shape. See [Figure II-4.2.10 Curb and Gutter Barrier \(p.364\)](#).

- Construct a horseshoe shaped berm, faced with coarse aggregate if using riprap, 3 feet high and 3 feet wide, at least 2 feet from the inlet.
- Construct a horseshoe shaped sedimentation trap on the outside of the berm sized to sediment trap standards for protecting a culvert inlet.

Maintenance Standards

- Inspect catch basin filters frequently, especially after storm events. Clean and replace clogged inserts. For systems with clogged stone filters: pull away the stones from the inlet and clean or replace. An alternative approach would be to use the clogged stone as fill and put fresh stone around the inlet.
- Do not wash sediment into storm drains while cleaning. Spread all excavated material evenly over the surrounding land area or stockpile and stabilize as appropriate.

Approved as Equivalent

Ecology has approved products as able to meet the requirements of [BMP C220: Storm Drain Inlet Protection](#). The products did not pass through the Technology Assessment Protocol – Ecology (TAPE) process. Local jurisdictions may choose not to accept this product approved as equivalent, or may require additional testing prior to consideration for local use. The products are available for review on Ecology’s website at <http://www.ecy.wa.gov/programs/wq/stormwater/newtech/equivalent.html>

Figure II-4.2.9 Block and Gravel Curb Inlet Protection

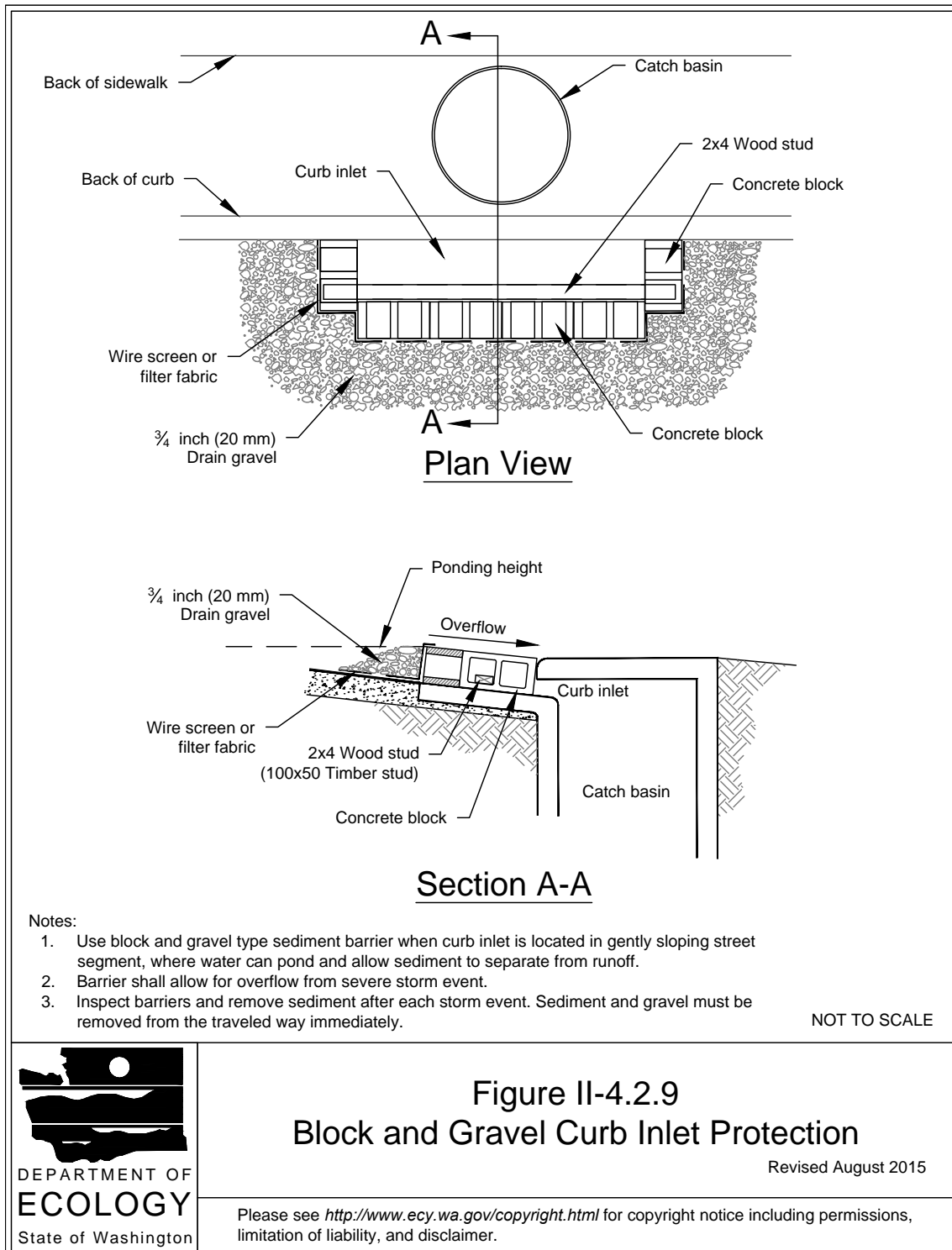
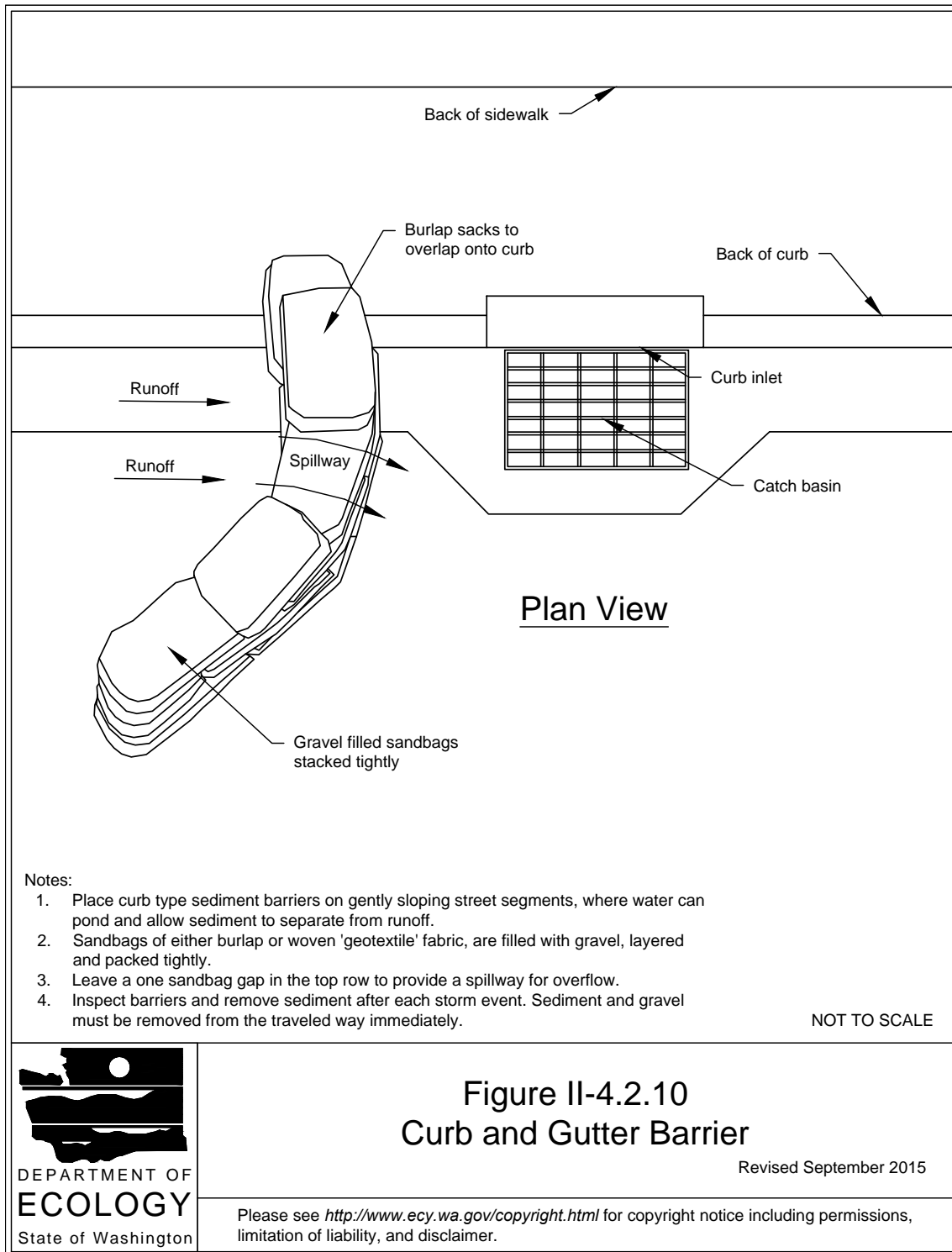

**Figure II-4.2.9
Block and Gravel Curb Inlet Protection**

Revised August 2015

Please see <http://www.ecy.wa.gov/copyright.html> for copyright notice including permissions, limitation of liability, and disclaimer.

Figure II-4.2.10 Curb and Gutter Barrier



**Figure II-4.2.10
Curb and Gutter Barrier**

Revised September 2015

Please see <http://www.ecy.wa.gov/copyright.html> for copyright notice including permissions, limitation of liability, and disclaimer.

BMP C232: Gravel Filter Berm

Purpose

A gravel filter berm is constructed on rights-of-way or traffic areas within a construction site to retain sediment by using a filter berm of gravel or crushed rock.

Conditions of Use

Where a temporary measure is needed to retain sediment from rights-of-way or in traffic areas on construction sites.

Design and Installation Specifications

- Berm material shall be $\frac{3}{4}$ to 3 inches in size, washed well-grade gravel or crushed rock with less than 5 percent fines.
- Spacing of berms:
 - Every 300 feet on slopes less than 5 percent
 - Every 200 feet on slopes between 5 percent and 10 percent
 - Every 100 feet on slopes greater than 10 percent
- Berm dimensions:
 - 1 foot high with 3H:1V side slopes
 - 8 linear feet per 1 cfs runoff based on the 10-year, 24-hour design storm

Maintenance Standards

- Regular inspection is required. Sediment shall be removed and filter material replaced as needed.

BMP C233: Silt Fence

Purpose

Use of a silt fence reduces the transport of coarse sediment from a construction site by providing a temporary physical barrier to sediment and reducing the runoff velocities of overland flow. See [Figure II-4.2.12 Silt Fence \(p.369\)](#) for details on silt fence construction.

Conditions of Use

Silt fence may be used downslope of all disturbed areas.

- Silt fence shall prevent soil carried by runoff water from going beneath, through, or over the top of the silt fence, but shall allow the water to pass through the fence.
- Silt fence is not intended to treat concentrated flows, nor is it intended to treat substantial amounts of overland flow. Convey any concentrated flows through the drainage system to a sediment pond.
- Do not construct silt fences in streams or use in V-shaped ditches. Silt fences do not provide an adequate method of silt control for anything deeper than sheet or overland flow.

Figure II-4.2.12 Silt Fence

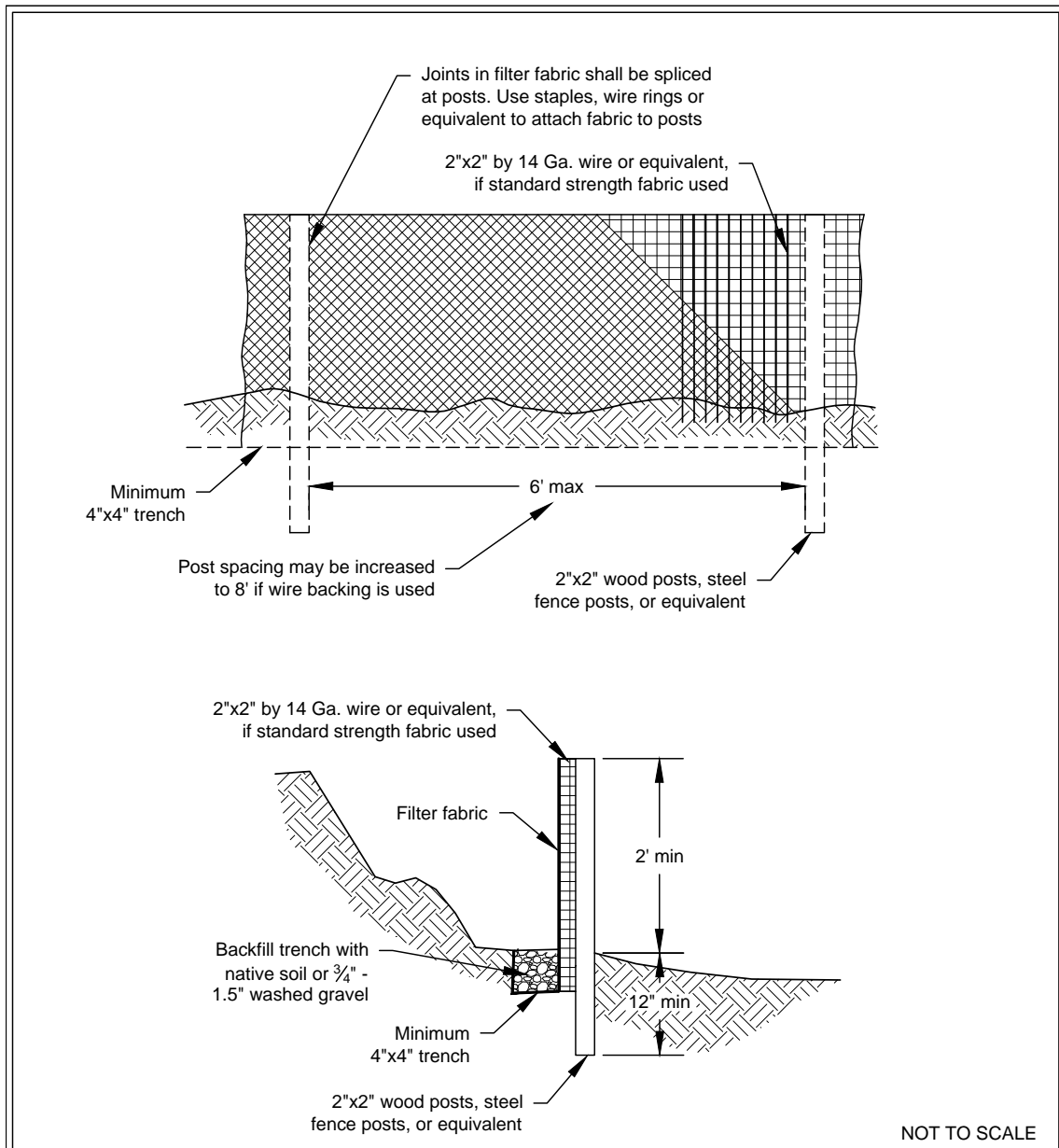

NOT TO SCALE



**Figure II-4.2.12
Silt Fence**

Revised October 2014

Please see <http://www.ecy.wa.gov/copyright.html> for copyright notice including permissions, limitation of liability, and disclaimer.

Design and Installation Specifications

- Use in combination with sediment basins or other BMPs.
- Maximum slope steepness (normal (perpendicular) to fence line) 1H:1V.
- Maximum sheet or overland flow path length to the fence of 100 feet.
- Do not allow flows greater than 0.5 cfs.
- The geotextile used shall meet the following standards. All geotextile properties listed below are minimum average roll values (i.e., the test result for any sampled roll in a lot shall meet or exceed the values shown in [Table II-4.2.3 Geotextile Standards \(p.370\)](#)):

Table II-4.2.3 Geotextile Standards

Polymeric Mesh AOS (ASTM D4751)	0.60 mm maximum for slit film woven (#30 sieve). 0.30 mm maximum for all other geotextile types (#50 sieve). 0.15 mm minimum for all fabric types (#100 sieve).
Water Permittivity (ASTM D4491)	0.02 sec ⁻¹ minimum
Grab Tensile Strength (ASTM D4632)	180 lbs. Minimum for extra strength fabric. 100 lbs minimum for standard strength fabric.
Grab Tensile Strength (ASTM D4632)	30% maximum
Ultraviolet Resistance (ASTM D4355)	70% minimum

- Support standard strength fabrics with wire mesh, chicken wire, 2-inch x 2-inch wire, safety fence, or jute mesh to increase the strength of the fabric. Silt fence materials are available that have synthetic mesh backing attached.
- Filter fabric material shall contain ultraviolet ray inhibitors and stabilizers to provide a minimum of six months of expected usable construction life at a temperature range of 0°F. to 120°F.
- One-hundred percent biodegradable silt fence is available that is strong, long lasting, and can be left in place after the project is completed, if permitted by local regulations.
- Refer to [Figure II-4.2.12 Silt Fence \(p.369\)](#) for standard silt fence details. Include the following standard Notes for silt fence on construction plans and specifications:

1. The contractor shall install and maintain temporary silt fences at the locations shown in the Plans.
2. Construct silt fences in areas of clearing, grading, or drainage prior to starting those activities.
3. The silt fence shall have a 2-foot min. and a 2½-foot max. height above the original ground surface.
4. The filter fabric shall be sewn together at the point of manufacture to form filter fabric lengths as required. Locate all sewn seams at support posts. Alternatively, two sections of silt fence can be overlapped, provided the Contractor can demonstrate, to the satisfaction of the Engineer, that the overlap is long enough and that the adjacent fence sections are close enough together to prevent silt laden water from escaping through the fence at the overlap.
5. Attach the filter fabric on the up-slope side of the posts and secure with staples, wire, or in accordance with the manufacturer's recommendations. Attach the filter fabric to the posts in a manner that reduces the potential for tearing.
6. Support the filter fabric with wire or plastic mesh, dependent on the properties of the geotextile selected for use. If wire or plastic mesh is used, fasten the mesh securely to the up-slope side of the posts with the filter fabric up-slope of the mesh.
7. Mesh support, if used, shall consist of steel wire with a maximum mesh spacing of 2-inches, or a prefabricated polymeric mesh. The strength of the wire or polymeric mesh shall be equivalent to or greater than 180 lbs. grab tensile strength. The polymeric mesh must be as resistant to the same level of ultra-violet radiation as the filter fabric it supports.
8. Bury the bottom of the filter fabric 4-inches min. below the ground surface. Backfill and tamp soil in place over the buried portion of the filter fabric, so that no flow can pass beneath the fence and scouring cannot occur. When wire or polymeric back-up support mesh is used, the wire or polymeric mesh shall extend into the ground 3-inches min.
9. Drive or place the fence posts into the ground 18-inches min. A 12-inch min. depth is allowed if topsoil or other soft subgrade soil is not present and 18-inches cannot be reached. Increase fence post min. depths by 6 inches if the fence is located on slopes of 3H:1V or steeper and the slope is perpendicular to the fence. If required post depths cannot be obtained, the posts shall be adequately secured by bracing or guying to prevent overturning of the fence due to sediment loading.
10. Use wood, steel or equivalent posts. The spacing of the support posts shall

be a maximum of 6-feet. Posts shall consist of either:

- Wood with dimensions of 2-inches by 2-inches wide min. and a 3-foot min. length. Wood posts shall be free of defects such as knots, splits, or gouges.
 - No. 6 steel rebar or larger.
 - ASTM A 120 steel pipe with a minimum diameter of 1-inch.
 - U, T, L, or C shape steel posts with a minimum weight of 1.35 lbs./ft.
 - Other steel posts having equivalent strength and bending resistance to the post sizes listed above.
11. Locate silt fences on contour as much as possible, except at the ends of the fence, where the fence shall be turned uphill such that the silt fence captures the runoff water and prevents water from flowing around the end of the fence.
 12. If the fence must cross contours, with the exception of the ends of the fence, place gravel check dams perpendicular to the back of the fence to minimize concentrated flow and erosion. The slope of the fence line where contours must be crossed shall not be steeper than 3H:1V.
 - Gravel check dams shall be approximately 1-foot deep at the back of the fence. Gravel check dams shall be continued perpendicular to the fence at the same elevation until the top of the check dam intercepts the ground surface behind the fence.
 - Gravel check dams shall consist of crushed surfacing base course, gravel backfill for walls, or shoulder ballast. Gravel check dams shall be located every 10 feet along the fence where the fence must cross contours.
- Refer to [Figure II-4.2.13 Silt Fence Installation by Slicing Method \(p.374\)](#) for slicing method details. Silt fence installation using the slicing method specifications:
 1. The base of both end posts must be at least 2- to 4-inches above the top of the filter fabric on the middle posts for ditch checks to drain properly. Use a hand level or string level, if necessary, to mark base points before installation.
 2. Install posts 3- to 4-feet apart in critical retention areas and 6- to 7-feet apart in standard applications.
 3. Install posts 24-inches deep on the downstream side of the silt fence, and as close as possible to the filter fabric, enabling posts to support the filter fabric from upstream water pressure.
 4. Install posts with the nipples facing away from the filter fabric.

5. Attach the filter fabric to each post with three ties, all spaced within the top 8-inches of the filter fabric. Attach each tie diagonally 45 degrees through the filter fabric, with each puncture at least 1-inch vertically apart. Each tie should be positioned to hang on a post nipple when tightening to prevent sagging.
6. Wrap approximately 6-inches of fabric around the end posts and secure with 3 ties.
7. No more than 24-inches of a 36-inch filter fabric is allowed above ground level.

Compact the soil immediately next to the filter fabric with the front wheel of the tractor, skid steer, or roller exerting at least 60 pounds per square inch. Compact the upstream side first and then each side twice for a total of four trips. Check and correct the silt fence installation for any deviation before compaction. Use a flat-bladed shovel to tuck fabric deeper into the ground if necessary.

Figure II-4.2.13 Silt Fence Installation by Slicing Method

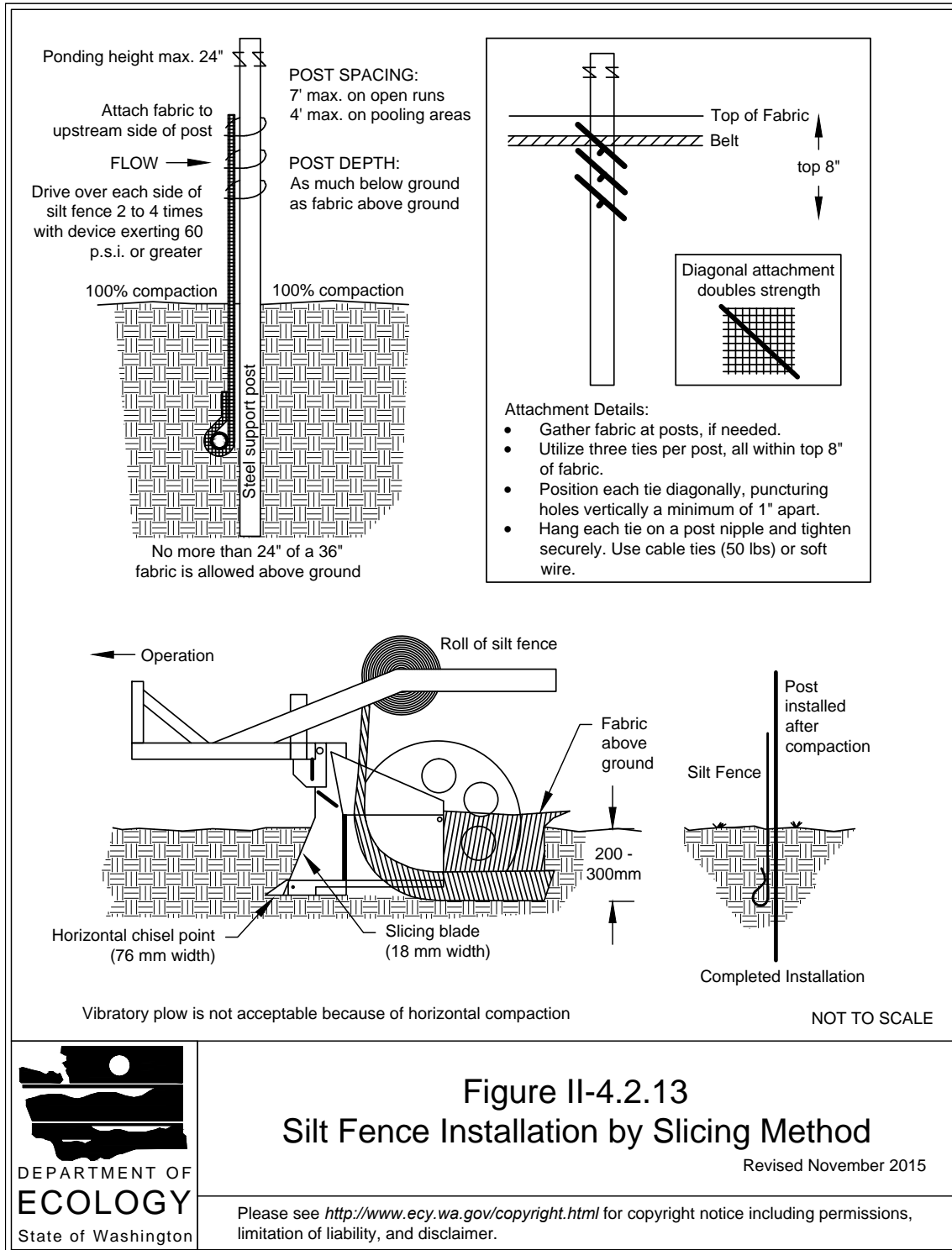

Maintenance Standards

- Repair any damage immediately.
- Intercept and convey all evident concentrated flows uphill of the silt fence to a sediment pond.
- Check the uphill side of the fence for signs of the fence clogging and acting as a barrier to flow and then causing channelization of flows parallel to the fence. If this occurs, replace the fence or remove the trapped sediment.
- Remove sediment deposits when the deposit reaches approximately one-third the height of the silt fence, or install a second silt fence.
- Replace filter fabric that has deteriorated due to ultraviolet breakdown.

BMP C234: Vegetated Strip

Purpose

Vegetated strips reduce the transport of coarse sediment from a construction site by providing a temporary physical barrier to sediment and reducing the runoff velocities of overland flow.

Conditions of Use

- Vegetated strips may be used downslope of all disturbed areas.
- Vegetated strips are not intended to treat concentrated flows, nor are they intended to treat substantial amounts of overland flow. Any concentrated flows must be conveyed through the drainage system to a sediment pond. The only circumstance in which overland flow can be treated solely by a strip, rather than by a sediment pond, is when the following criteria are met (see [Table II-4.2.4 Contributing Drainage Area for Vegetated Strips \(p.375\)](#)):

Table II-4.2.4 Contributing Drainage Area for Vegetated Strips

Average Contributing Area Slope	Average Contributing Area Percent Slope	Max Contributing area Flowpath Length
1.5H : 1V or flatter	67% or flatter	100 feet
2H : 1V or flatter	50% or flatter	115 feet
4H : 1V or flatter	25% or flatter	150 feet
6H : 1V or flatter	16.7% or flatter	200 feet
10H : 1V or flatter	10% or flatter	250 feet

Appendix D

TESC Calculations

The runoff from the disturbed project area is being collected in Baker tanks during construction. This basin is 2.22 acres.

According to WWHM, the 24-hour water quality flow volume is 0.1737 acre-feet.

Water Quality	
On-Line BMP	Off-Line BMP
24 hour Volume (ac-ft) <input type="text" value="0.1737"/>	
Standard Flow Rate (cfs) <input type="text" value="0.2156"/>	Standard Flow Rate (cfs) <input type="text" value="0.1236"/>

This is equal to 59,596 gallons. One Baker tank can hold 18,900 gallons, therefore 3 tanks are required.

Provide the WWHM printout to go along with this calculation. [CSWPPP, pg 9]



2215 North 30th Street
Suite 300
Tacoma, WA 98403
253.383.2422 TEL
253.383.2572 FAX

Pierce College Puyallup - New STEM Building

TESC Calculations

App. D

WWHM2012
PROJECT REPORT

General Model Information

Project Name: STEM - TESC
Site Name: Pierce College STEM
Site Address: 1601 39th Ave SE
City: Puyallup
Report Date: 7/21/2022
Gage: 38 IN CENTRAL
Data Start: 10/01/1901
Data End: 09/30/2059
Timestep: 15 Minute
Precip Scale: 1.000
Version Date: 2021/08/18
Version: 4.2.18

POC Thresholds

Low Flow Threshold for POC1:	50 Percent of the 2 Year
High Flow Threshold for POC1:	50 Year

Landuse Basin Data
Predeveloped Land Use

Mitigated Land Use

Basin 1

Bypass:	No
GroundWater:	No
Pervious Land Use C, Pasture, Flat	acre 0.75
Pervious Total	0.75
Impervious Land Use ROADS FLAT	acre 1.47
Impervious Total	1.47
Basin Total	2.22

Element Flows To:		
Surface	Interflow	Groundwater

Routing Elements
Predeveloped Routing

Mitigated Routing

Analysis Results

POC 1

POC #1 was not reported because POC must exist in both scenarios and both scenarios must have been run.

Model Default Modifications

Total of 0 changes have been made.

PERLND Changes

No PERLND changes have been made.

IMPLND Changes

No IMPLND changes have been made.

Appendix
Predeveloped Schematic

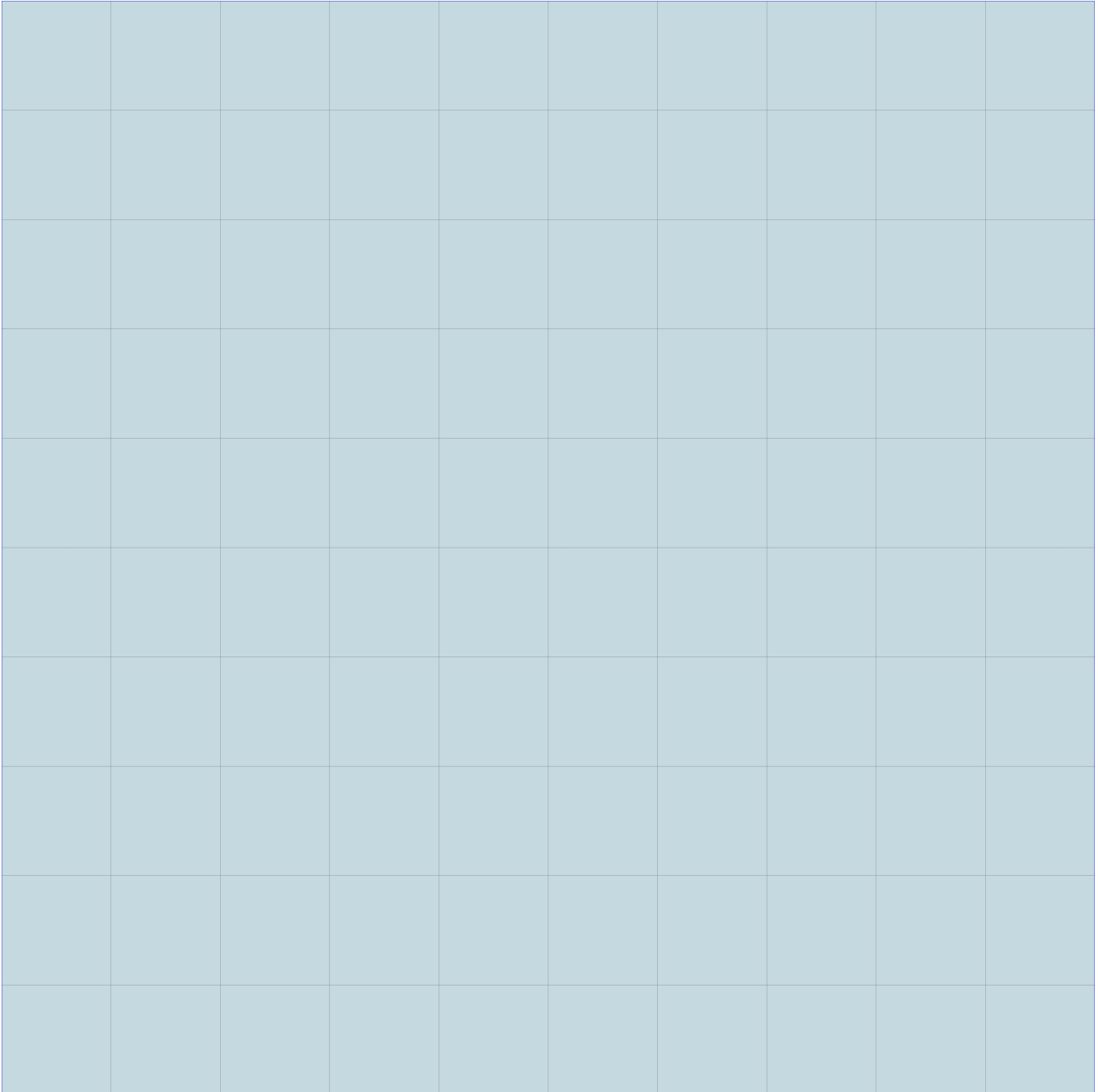

Mitigated Schematic



Basin 1
2.22ac