

# Structural Calculations

# Bradley Heights Carports

202 27th Ave SE  
Puyallup, WA 98374

|                                                                        |              |
|------------------------------------------------------------------------|--------------|
| City of Puyallup<br>Development & Permitting Services<br>ISSUED PERMIT |              |
| Building                                                               | Planning     |
| Engineering                                                            | Public Works |
| Fire                                                                   | Traffic      |

Calculations required to be provided by  
the Permittee on site for all Inspections

**PRCP20260246**

CALCULATIONS

PREPARED FOR

## CARPORTS OF WASHINGTON

P.O. BOX 2389  
BUCKLEY, WA 98321

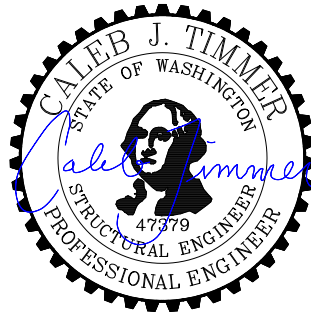

02/17/26

PREPARED BY



4815 Center Street  
Tacoma, WA 98409

February 17, 2026

S & H Job Number: 21,178

**City of Puyallup  
Building  
REVIEWED  
FOR  
COMPLIANCE**

SKinnear  
04/02/2026  
8:55:25 AM



# CALCULATION INDEX

|                                                        |                       |
|--------------------------------------------------------|-----------------------|
| <b><u>BASIS</u></b>                                    | <b><u>2</u></b>       |
| <b><u>DESIGN LOADS</u></b>                             | <b><u>3</u></b>       |
| <b><u>CARPORT SPECIFICATIONS</u></b>                   | <b><u>4</u></b>       |
| <b><u>LATERAL ANALYSIS</u></b>                         | <b><u>5 - 9</u></b>   |
| <b><u>TYPICAL MEMBER CHECKS</u></b>                    | <b><u>10 - 19</u></b> |
| <i>DECKING</i>                                         |                       |
| <i>DECKING-PURLIN CONNECTIONS</i>                      |                       |
| <i>PURLINS</i>                                         |                       |
| <i>PURLIN-POST CONNECTION</i>                          |                       |
| <i>POSTS</i>                                           |                       |
| <i>FOOTING</i>                                         |                       |
| <i>ALTERNATE FOOTING</i>                               |                       |
| <b><u>APPENDICES</u></b>                               | <b><u>20+</u></b>     |
| <i>ENERCALC REPORTS</i>                                |                       |
| <i>GEOTECHNICAL REPORT</i>                             |                       |
| <i>ASCE HAZARDS REPORT</i>                             |                       |
| <i>PIERCE COUNTY ADOPTED CODES AND DESIGN CRITERIA</i> |                       |

# BASIS FOR DESIGN

**BUILDING CODE:**

2021 edition of the International Building Code with State of Washington amendments shall be used and supplemented with ASCE 7-16.

**RISK CATEGORY:**

II.

**GRAVITY LOADS:**

Roof snow load:  $S := 30 \text{ psf}$ .  
Roof dead load: self-weight.

**LATERAL LOAD CRITERIA:**

Wind speed:  $V := 110 \text{ mph}$ . Exposure: C.  
Seismic site class: C.  
Seismic design category: D.

**FOUNDATIONS:**

Allowable soil bearing pressure:  $\sigma_{max} := 2000 \text{ psf}$  per Geotechnical Report 0419036006 provided by Georesources dated February 10, 2022.  
Concrete footings shall bear on firm, undisturbed soil 18" minimum below finished grade.

**STRUCTURAL STEEL:**

|                          |                     |        |
|--------------------------|---------------------|--------|
| Hollow Rectangular Steel | ASTM A500, Grade B  | 46 ksi |
| Bolts                    | ASTM 307, Grade A   |        |
| Nuts                     | ASTM A563           |        |
| Flat/Beveled Washers     | ASTM F463           |        |
| Direct Tension Washers   | ASTM F595           |        |
| Metal Roof Deck          | ASTM A792           | 60 ksi |
| Cold-Formed Shapes       | ASTM A653           | 50 ksi |
| Wide Flange Steel        | ASTM A992, Grade 50 | 50 ksi |

# DESIGN LOADS

**SNOW LOAD:**  $S = 30 \text{ psf}$

**DEAD LOAD:**

$$W_{\text{roofing}} := 0.91 \text{ psf}$$
$$W_{\text{flashing}} := 0.12 \text{ psf}$$
$$W_{\text{deck}} := W_{\text{roofing}} + W_{\text{flashing}} = 1.03 \text{ psf}$$
$$W_{\text{deck}} = 1.03 \text{ psf}$$

# CARPORT SPECIFICATIONS

DESIGN IS BASED ON A TYPICAL 4-STALL CARPORT WITH 9'-0" X 18'-0" STALLS.  
DESIGN IS ALSO VALID FOR OTHER CONFIGURATIONS.

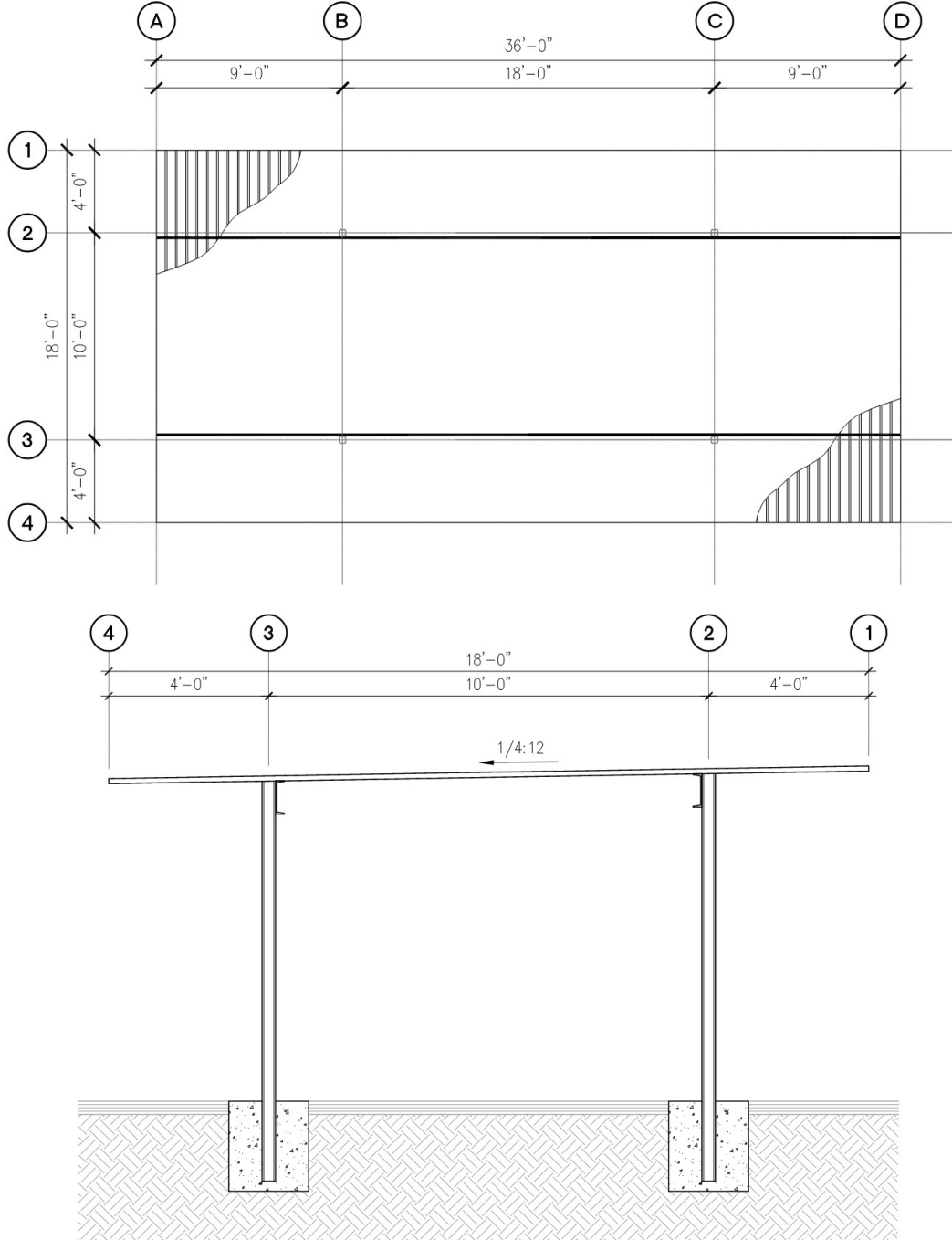

## CARPORT DIMENSIONS

- A := 36 **ft**      carport roof length
- B := 18 **ft**      carport roof width
- h := 8 **ft**      average height of carport roof, structural height

# LATERAL ANALYSIS

## SEISMIC DESIGN CRITERIA

**HORIZONTAL SEISMIC FORCES SHALL BE DETERMINED IN ASCE 7-16 SECTION 12.8 WITH THE EQUIVALENT LATERAL FORCE PROCEDURE.**

|                                                                                                 |                                                                                            |                         |
|-------------------------------------------------------------------------------------------------|--------------------------------------------------------------------------------------------|-------------------------|
| $R := 1.25$                                                                                     | <i>response modification coefficient</i>                                                   | (ASCE TAB. 12.2-1)      |
| $I_e := 1.00$                                                                                   | <i>seismic importance factor</i>                                                           | (ASCE TAB. 1.5-2)       |
| $C_t := 0.02$                                                                                   | <i>building period coefficient</i>                                                         | (ASCE TAB. 12.8-2)      |
| $x := 0.75$                                                                                     | <i>building period coefficient</i>                                                         | (ASCE TAB. 12.8-2)      |
| $T_a := C_t h^x \left( \frac{s}{ft^x} \right) = 0.095 \text{ s}$                                | <i>approximate fundamental period</i>                                                      | (ASCE SEC. 12.8.2.1)    |
| $T := T_a$                                                                                      | <i>structural fundamental period</i>                                                       | (ASCE SEC. 12.8.2)      |
| $C$                                                                                             | <i>Seismic Design Category</i>                                                             | (ASCE SEC. 11.6)        |
| $S_{DS} := 1.01$                                                                                | <i>short period design spectral response acceleration parameter</i>                        | (ASCE EQ. 11.4-3)       |
| $S_1 := 0.435$                                                                                  | <i>mapped MCER, 5% damped, spectral response acceleration parameter at a period of 1 s</i> | (ASCE 7-16 HAZARD TOOL) |
| $S_{D1} := 0.435$                                                                               | <i>design spectral response acceleration parameter</i>                                     | (ASCE SEC. 11.4-4)      |
| $C_{s1} := \frac{S_{DS}}{\left( \frac{R}{I_e} \right)} = 0.808$                                 | <i>seismic response coefficient</i>                                                        | (ASCE SEC. 12.8-2)      |
| $C_{s2} := \frac{S_{D1}}{T \left( \frac{R}{I_e} \right)} (\text{s}) = 3.658$                    | <i>seismic response coefficient</i>                                                        | (ASCE SEC. 12.8-2)      |
| $C_s := \max \left( \min \left( C_{s1}, C_{s2} \right), 0.044 S_{DS} I_e, 0.01 \right) = 0.808$ |                                                                                            | (ASCE SEC. 12.8.1.1)    |

### STRUCTURE SEISMIC WEIGHT:

$$W_{deck} = 1.03 \text{ psf}$$

$$W_{purlin} := 6.43 \text{ plf}$$

$$W_{post} := 6.46 \text{ plf}$$

$$W_E := W_{deck} A \cdot B + 2 W_{purlin} A + 4 W_{post} \left( \frac{1}{2} h \right) = 1233.76 \text{ lbf}$$

### HORIZONTAL SEISMIC FORCE:

$$\rho := 1.0 \quad \text{redundancy factor} \quad (\text{ASCE SEC. 12.3.4.2})$$

$$E_h := \rho C_s W_E = 996.9 \text{ lbf} \quad \text{seismic base shear} \quad (\text{ASCE SEC. 12.4.2.1})$$

## WIND DESIGN CRITERIA

*VELOCITY PRESSURE SHALL BE DETERMINED IN ASCE 7-16 CHAPTER 26.*

$$V = 110 \text{ mph}$$

*basic wind speed, Section 26.5*

$$C$$

*exposure category, Section 26.7.3*

$$K_z := 0.85$$

*velocity pressure expose coefficient, Table 26.10-1*

$$K_{zt} := 1.0$$

*topographic factor, Section 26.8.2*

$$K_d := 0.85$$

*wind directionality factor, Table 26.6-1*

$$z_g := 404.7839$$

*ground elevation in feet*

$$K_e := e^{-0.0000362 \cdot z_g} = 0.985$$

$$K_e = 0.985$$

*ground elevation factor, Table 26.9-1*

$$q_z := 0.00256 K_z K_{zt} K_d K_e V^2 \left( \frac{\text{psf}}{\text{mph}^2} \right) = 22.055 \text{ psf} \quad \text{velocity pressure, (26.10-1)}$$

$$q_h := q_z$$

*as permitted by Section 26.10.2*

**WIND DESIGN CRITERIA FOR MAIN WINDFORCE-RESISTING SYSTEM**

*VERTICAL FORCES APPLIED TO MWFRS WILL BE DETERMINED USING THE DIRECTION PROCEDURE, AS OUTLINED IN CHAPTER 27 OF ASCE 7-16.*

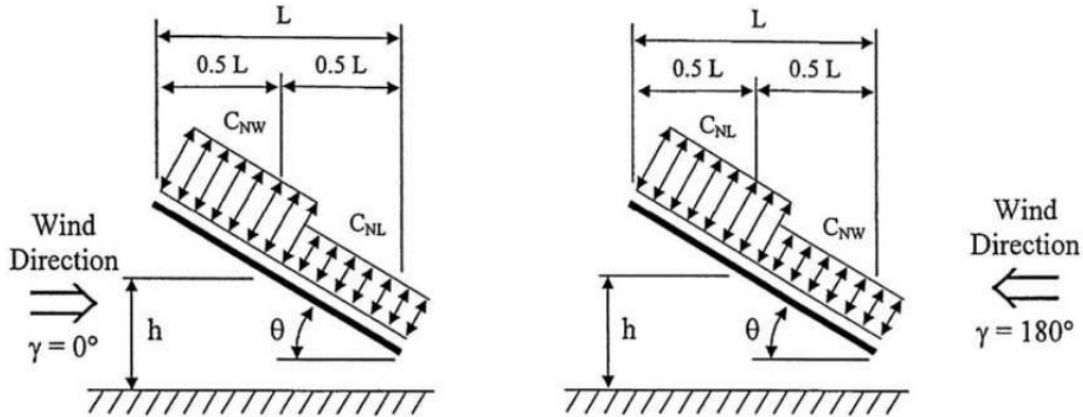
**Diagrams**

**Notation**

$L$  = Horizontal dimension of roof, measured in the along-wind direction, ft (m).

$h$  = Mean roof height, ft (m).

$\gamma$  = Direction of wind, degrees.

$\theta$  = Angle of plane of roof from horizontal, degrees.

**Net Pressure Coefficient,  $C_N$** 

| Roof Angle, $\theta$ | Load Case | Wind Direction, $\gamma = 0^\circ$ |          |                      |          | Wind Direction, $\gamma = 180^\circ$ |          |                      |          |
|----------------------|-----------|------------------------------------|----------|----------------------|----------|--------------------------------------|----------|----------------------|----------|
|                      |           | Clear Wind Flow                    |          | Obstructed Wind Flow |          | Clear Wind Flow                      |          | Obstructed Wind Flow |          |
|                      |           | $C_{NW}$                           | $C_{NL}$ | $C_{NW}$             | $C_{NL}$ | $C_{NW}$                             | $C_{NL}$ | $C_{NW}$             | $C_{NL}$ |
| 0°                   | A         | 1.2                                | 0.3      | -0.5                 | -1.2     | 1.2                                  | 0.3      | -0.5                 | -1.2     |
|                      | B         | -1.1                               | -0.1     | -1.1                 | -0.6     | -1.1                                 | -0.1     | -1.1                 | -0.6     |
| 7.5°                 | A         | -0.6                               | -1.0     | -1.0                 | -1.5     | -0.9                                 | -1.5     | -0.2                 | -1.2     |

ASCE 7-16 TABLE 27.3-4

$$\theta := \text{atan}\left(\frac{0.25}{12}\right) = 1.2^\circ$$

roof slope, use 0 deg. load coefficients

$$G := 0.85$$

gust effect factor

(ASCE SEC. 26.11.1)

**CASE A:**  $C_{NWA} := 1.2$

**CASE B:**  $C_{NWB} := -1.1$

$$C_{NLA} := 0.3$$

$$C_{NLB} := -0.1$$

$$P_{NWA} := q_h G C_{NWA} = 22.5 \text{ psf} \quad \text{net design pressure for MWFRS}$$

(ASCE SEC. 27.3-2)

$$P_{NLA} := q_h G C_{NLA} = 5.6 \text{ psf} \quad \text{net design pressure for MWFRS}$$

(ASCE SEC. 27.3-2)

$$P_{NWB} := q_h G C_{NWB} = -20.6 \text{ psf} \quad \text{net design pressure for MWFRS}$$

(ASCE SEC. 27.3-2)

$$P_{NLB} := q_h G C_{NLB} = -1.9 \text{ psf} \quad \text{net design pressure for MWFRS}$$

(ASCE SEC. 27.3-2)

**HORIZONTAL FORCES APPLIED TO MWFRS WILL BE DETERMINED USING  
THE DIRECTIONAL PROCEDURE, AS OUTLINED IN CHAPTER 29 OF ASCE 7-16**

**Force Coefficients,  $C_f$** 

| $\epsilon$  | Flat-Sided Members | Rounded Members                                          |                                                    |
|-------------|--------------------|----------------------------------------------------------|----------------------------------------------------|
|             |                    | $D\sqrt{q_z} \leq 2.5$<br>( $D\sqrt{q_z} \leq 5.3$ ) s.i | $D\sqrt{q_z} > 2.5$<br>( $D\sqrt{q_z} > 5.3$ ) s.i |
| <0.1        | 2.0                | 1.2                                                      | 0.8                                                |
| 0.1 to 0.29 | 1.8                | 1.3                                                      | 0.9                                                |
| 0.3 to 0.7  | 1.6                | 1.5                                                      | 1.1                                                |

**Notation**

$\epsilon$  = Ratio of solid area to gross area

$D$  = Diameter of a typical round member, in ft (m)

$q_z$  = Velocity pressure evaluated at height  $z$  above ground, in lb/ft<sup>2</sup> (N/m<sup>2</sup>)

**Notes**

1. Signs with openings making up 30% or more of the gross area are classified as open signs.
2. Calculation of the design wind forces shall be based on the area of all exposed members and elements projected on a plane normal to the wind direction. Forces shall be assumed to act parallel to the wind direction.
3. Area  $A_f$  consistent with these force coefficients is the solid area projected normal to the wind direction.

*ASCE 7-16 Table 29.4-2*

$$D := 1 \text{ ft} \quad \text{approximate depth of purlin and roof decking}$$

$$\epsilon := \frac{D B + h (6 \text{ in})}{h B} = 0.153 \quad \text{ratio of solid area to gross area}$$

$$C_f := 1.8 \quad \text{force coefficient} \quad \text{(ASCE TAB. 29.4-2)}$$

$$P_f := \max(q_h G C_f, 16 \text{ psf}) = 33.74 \text{ psf}$$

**Project: BRADLEY HEIGHTS CARPORTS**

**WIND DESIGN CRITERIA FOR COMPONENTS AND CLADDING**

*VERTICAL FORCES APPLIED TO C&C WILL BE DETERMINED USING THE DIRECTIONAL PROCEDURE, AS OUTLINED IN CHAPTER 30 OF ASCE 7-16*

**Diagrams**

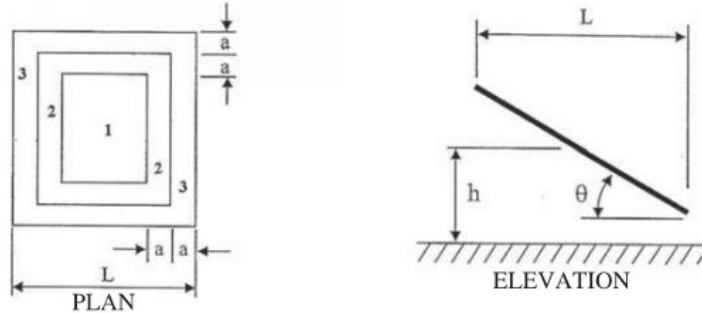

**Notation**

- $a$  = 10% of least horizontal dimension or  $0.4h$ , whichever is smaller but not less than 4% of least horizontal dimension or 3 ft (0.9 m).
- $h$  = Mean roof height, in ft (m).
- $L$  = Horizontal dimension of building, measured in along-wind direction, in ft (m).
- $\theta$  = Angle of plane of roof from horizontal, in degrees.

**Net Pressure Coefficients,  $C_N$**

| Roof Angle, $\theta$ | Effective Wind Area  | Clear Wind Flow |      |        |      |        |      |
|----------------------|----------------------|-----------------|------|--------|------|--------|------|
|                      |                      | Zone 3          |      | Zone 2 |      | Zone 1 |      |
| 0°                   | $\leq a^2$           | 2.4             | -3.3 | 1.8    | -1.7 | 1.2    | -1.1 |
|                      | $> a^2, \leq 4.0a^2$ | 1.8             | -1.7 | 1.8    | -1.7 | 1.2    | -1.1 |
|                      | $> 4.0a^2$           | 1.2             | -1.1 | 1.2    | -1.1 | 1.2    | -1.1 |
| 7.5°                 | $\leq a^2$           | 3.2             | -4.2 | 2.4    | -2.1 | 1.6    | -1.4 |

ASCE 7-16 TABLE 30.7-1

$$a := \max(\min(0.1 B, 0.4 h), 0.04 B, 3 \text{ ft}) = 3 \text{ ft}$$

$$a^2 = 9 \text{ ft}^2$$

$$4 a^2 = 36 \text{ ft}^2$$

*EFFECTIVE WIND AREA MUST BE DETERMINED PER COMPONENT TO OBTAIN THE APPROPRIATE NET PRESSURE COEFFICIENT FOR C&C*

# TYPICAL MEMBER CHECKS

## DECKING

### V-LINE 32 SECTION PROPERTIES AND GENERAL INFORMATION

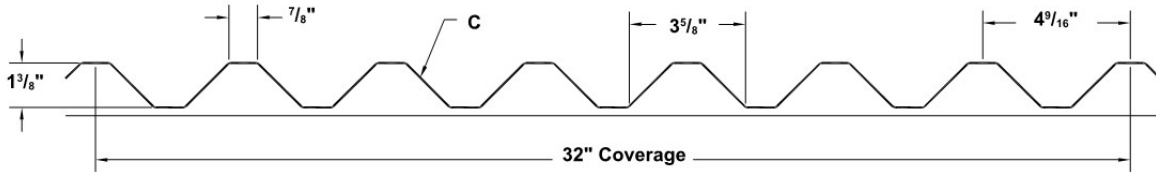

| SECTION PROPERTIES |                |              |               |                            |                            |                            |                            | ALLOWABLE UNIFORM LOADS PSF<br>(3 or More Equal Spans) |    |    |    |    |     |                 |    |    |    |    |     |
|--------------------|----------------|--------------|---------------|----------------------------|----------------------------|----------------------------|----------------------------|--------------------------------------------------------|----|----|----|----|-----|-----------------|----|----|----|----|-----|
| Ga.                | Width<br>(in.) | Yield<br>KSI | Weight<br>PSF | Top in Compression         |                            | Bottom in Compression      |                            | Inward<br>Load                                         |    |    |    |    |     | Outward<br>Load |    |    |    |    |     |
|                    |                |              |               | Ixx<br>In <sup>4</sup> /ft | Sxx<br>In <sup>3</sup> /ft | Ixx<br>In <sup>4</sup> /ft | Sxx<br>In <sup>3</sup> /ft | 5'                                                     | 6' | 7' | 8' | 9' | 10' | 5'              | 6' | 7' | 8' | 9' | 10' |
| 26                 | 32"            | 60           | 0.91          | 0.0619                     | 0.0847                     | 0.0619                     | 0.0833                     | 70                                                     | 52 | 33 | 22 | 16 | 11  | 71              | 53 | 33 | 22 | 16 | 11  |
| 24                 | 32"            | 50           | 1.20          | 0.0870                     | 0.1217                     | 0.0874                     | 0.1209                     | 102                                                    | 70 | 44 | 29 | 21 | 15  | 103             | 70 | 44 | 29 | 21 | 15  |
| 22                 | 32"            | 50           | 1.57          | 0.1163                     | 0.1623                     | 0.1200                     | 0.1683                     | 147                                                    | 92 | 58 | 39 | 27 | 20  | 143             | 92 | 58 | 39 | 27 | 20  |

- Theoretical section properties have been calculated per AISI 2001 "Specification for the Design of Cold-formed Steel Structural Members." Ixx and Sxx are effective section properties for deflection and bending.
- Allowable load is calculated in accordance with AISI 2001 specifications considering bending, shear, combined bending and shear, deflection. Allowable load considers the worst case of 3 and 4 equal span conditions. Allowable load does not address web crippling or fasteners/support connection and panel weight is not considered.
- Deflection consideration is limited by a maximum deflection ratio of L/180 of span.
- Allowable loads do not include a 1/3 stress increase in uplift.

### DECKING SPECIFICATIONS:

$$I := 0.0619 \frac{\text{in}^4}{\text{ft}}$$

$$S_{neg} := 0.0833 \frac{\text{in}^3}{\text{ft}}$$

$$S_{pos} := 0.0847 \frac{\text{in}^3}{\text{ft}}$$

$$F_{allow} := \frac{60 \text{ ksi}}{1.67} = 35.9 \text{ ksi}$$

$$l_{main} := 10 \text{ ft} \quad \text{length of main span}$$

$$l_{cant} := 4 \text{ ft} \quad \text{length of cantilevers}$$

$$b := 32 \text{ in} \quad \text{width of one sheet of decking}$$

### LOADING:

$$D := W_{deck} = 1.03 \text{ psf} \quad \text{weight of decking}$$

$$S = 30 \text{ psf} \quad \text{snow load}$$

**LOADING FOR MAX BEARING: D + S**

$$w := D + S = 31.03 \text{ psf}$$

$$M_{neg} := \frac{1}{2} w l_{cant}^2 = 248.24 \frac{\text{lbf} \cdot \text{ft}}{\text{ft}}$$

$$M_{pos} := \frac{1}{8} w l_{main}^2 - M_{neg} = 139.635 \frac{\text{lbf} \cdot \text{ft}}{\text{ft}}$$

$$f_{neg} := \frac{M_{neg}}{S_{neg}} = 35.761 \text{ ksi}$$

$$\frac{f_{neg}}{F_{allow}} = 99.53\%$$

$$f_{pos} := \frac{M_{pos}}{S_{pos}} = 19.783 \text{ ksi}$$

$$\frac{f_{pos}}{F_{allow}} = 55\%$$

**LOADING FOR MAX UPLIFT: 0.6D + 0.6W**

$$A_T := B b = 48 \text{ ft}^2$$

$$C_N := -1.1$$

(ASCE TAB. 30.7-1)

$$W := \min(q_h G C_N, -16 \text{ psf}) = -20.621 \text{ psf}$$

$$w := 0.6 D + 0.6 W = -11.755 \text{ psf}$$

$$M_{pos} := -\frac{1}{2} w l_{cant}^2 = 94.037 \frac{\text{lbf} \cdot \text{ft}}{\text{ft}}$$

$$M_{neg} := -\frac{1}{8} w l_{main}^2 - M_{pos} = 52.896 \frac{\text{lbf} \cdot \text{ft}}{\text{ft}}$$

$$f_{pos} := \frac{M_{pos}}{S_{pos}} = 13.323 \text{ ksi}$$

$$\frac{f_{pos}}{F_{allow}} = 37\%$$

$$f_{neg} := \frac{M_{neg}}{S_{neg}} = 7.62 \text{ ksi}$$

$$\frac{f_{neg}}{F_{allow}} = 21\%$$

**V-LINE 32, 26 GA. DECKING OK**

## DECKING-PURLIN CONNECTION

### WIND LOADING (C&C ZONE 3)

$$A_T := \frac{1}{4} b \left( \frac{1}{2} l_{main} + l_{cant} \right) = 6 \text{ ft}^2 \quad \text{tributary area of (1) screw}$$

$$C_N := -3.3$$

(ASCE TAB. 30.7-1)

$$W := \min(q_h G C_N, -16 \text{ psf}) = -61.9 \text{ psf}$$

### LOADING FOR MAX UPLIFT: 0.6D + 0.6W

$$R := (0.6 D + 0.6 W) A_T = -219 \text{ lbf} \quad \text{uplift reaction for (1) screw}$$

### ALLOWABLE PULLOVER

$$t_1 := 0.0179 \text{ in}$$

$$t_2 := 0.415 \text{ in}$$

$$F_u := 82 \text{ ksi}$$

$$P_{pullover} := \frac{1.5}{3} t_1 t_2 F_u = 304.6 \text{ lbf} \quad \text{allowable pullover load}$$

$$\frac{-R}{P_{pullover}} = 72\%$$

### ALLOWABLE PULLOUT

TABLE 2—ALLOWABLE TENSILE PULL-OUT LOADS ( $P_{NOT/\Omega}$ ), pounds-force<sup>1, 2, 3, 4, 5</sup>

| Steel $F_u = 45$ ksi, Applied Factor of Safety, $\Omega = 3.0$   |                        |                                                                    |       |       |       |       |       |       |       |       |              |              |
|------------------------------------------------------------------|------------------------|--------------------------------------------------------------------|-------|-------|-------|-------|-------|-------|-------|-------|--------------|--------------|
| Screw Designation                                                | Nominal Diameter (in.) | Design Thickness of Member Not in Contact with the Screw Head (in) |       |       |       |       |       |       |       |       |              |              |
|                                                                  |                        | 0.018                                                              | 0.024 | 0.030 | 0.036 | 0.048 | 0.060 | 0.075 | 0.105 | 0.125 | 0.187        | 0.250        |
| 10-16                                                            | 0.190                  | 44                                                                 | 58    | 73    | 87    | 116   | 145   | 182   | 254   | 303   | <sup>6</sup> | <sup>6</sup> |
| 12-14, 12-24                                                     | 0.216                  | 50                                                                 | 66    | 83    | 99    | 132   | 165   | 207   | 289   | 344   | 515          | 689          |
| <sup>1</sup> / <sub>4</sub> -14, <sup>1</sup> / <sub>4</sub> -28 | 0.250                  | 57                                                                 | 77    | 96    | 115   | 153   | 191   | 239   | 335   | 398   | 596          | 797          |

For SI: 1 inch = 25.4 mm, 1 lbf = 4.45 N, 1 ksi = 6.89 MPa.

<sup>1</sup>For tension connections, the least of the allowable pull-out, pullover, and fastener tension strength found in Tables 2, 3, and 5, respectively, must be used for design.

<sup>2</sup>ANSI/ASME standard screw diameters were used in the calculations and are listed in the tables.

<sup>3</sup>The allowable pull-out capacity for other member thickness can be determined by interpolating within the table.

<sup>4</sup>To calculate LRFD values, multiply values in table by the ASD safety factor of 3.0 and multiply again with the LRFD  $\Phi$  factor of 0.5.

<sup>5</sup>For  $F_u = 58$  ksi, multiply values by 1.29; for  $F_u = 65$  ksi, multiply values by 1.44.

<sup>6</sup>Outside drilling capacity limits.

$$P_{pullout} := 289 \text{ lbf} \quad \text{allowable pullout load}$$

(ESR-1979 TAB. 2)

$$\frac{-R}{P_{pullout}} = 76\%$$

**#12-14 TEK SCREWS @ 9" O.C. OK**

## TYPICAL PURLINS

### PURLIN SPECIFICATIONS:

$$l_{main} := \frac{1}{2} A = 18 \text{ ft} \quad \text{length of main span}$$

$$l_{cant} := \frac{1}{4} A = 9 \text{ ft} \quad \text{length of cantilevers}$$

$$b := \frac{1}{2} B = 9 \text{ ft} \quad \text{tributary width of (1) purlin}$$

$$D := D b + W_{purlin} = 15.7 \text{ plf}$$

### LOADING FOR MAX BEARING: D + S

$$w := D + S b = 285.7 \text{ plf}$$

$$R_1 := w \left( \frac{1}{2} l_{main} + l_{cant} \right) = 5.143 \text{ kip}$$

$$M_{x1} := \max \left( \frac{1}{2} w l_{cant}^2, \frac{1}{8} w l_{main}^2 \right) = 138.85 \text{ kip} \cdot \text{in}$$

$$V_{y1} := \max \left( \frac{w}{2 l_{main}} (l_{main}^2 + l_{cant}^2), \frac{w}{2 l_{main}} (l_{main}^2 - l_{cant}^2), w l_{cant} \right) = 3.214 \text{ kip}$$

### LOADING FOR MAX BEARING: 0.6D + 0.6W

$$A_T := A b = 324 \text{ ft}^2 \quad \text{tributary of (1) purlin}$$

$$C_N := -1.1$$

(ASCE TAB. 30.7-1)

$$W := \min (q_h G C_N, -16 \text{ psf}) = -20.621 \text{ psf}$$

$$w := 0.6 D + 0.6 W b = -101.934 \text{ plf}$$

$$R_2 := w \left( \frac{1}{2} l_{main} + l_{cant} \right) = -1.835 \text{ kip}$$

$$M_{x2} := \max \left( \frac{1}{2} w l_{cant}^2, \frac{1}{8} w l_{main}^2 \right) = -49.54 \text{ kip} \cdot \text{in}$$

$$V_{y2} := \max \left( \frac{w}{2 l_{main}} (l_{main}^2 + l_{cant}^2), \frac{w}{2 l_{main}} (l_{main}^2 - l_{cant}^2), w l_{cant} \right) = -0.688 \text{ kip}$$

### MAXIMUM VALUES:

$$R := \max (R_1, \text{abs} (R_2)) = 5.14 \text{ kip}$$

$$M_x := \max (M_{x1}, \text{abs} (M_{x2})) = 138.85 \text{ kip} \cdot \text{in}$$

$$V_y := \max (V_{y1}, \text{abs} (V_{y2})) = 3.21 \text{ kip}$$

**Project: BRADLEY HEIGHTS CARPORTS**
**DEFLECTION CHECK:**

$$\Delta_a := \frac{l_{main}}{180} = 1.2 \text{ in}$$

*allowable deflection*
*(IBC TAB. 1604.3)*

$$w := S b = 270 \text{ plf}$$

$$I_x := 26.708 \text{ in}^4$$

*(AEP SPAN)*

$$E := 29000 \text{ ksi}$$

$$\Delta := \frac{5 w l_{main}^4}{384 E I_x} = 0.823 \text{ in}$$

$$\frac{\Delta}{\Delta_a} = 69\%$$

**PER ATTACHED, CS 10"x3 1/2", 12 GA. PURLINS OK**
*(CFS 14)*
**Fully Braced Strength - AISI S100-16/S3-22, US, ASD**

Material Type: A653 SS Grade 50/1, Fy=50 ksi

| Axial |                          | Positive Bending |                        | Positive Bending |                        |
|-------|--------------------------|------------------|------------------------|------------------|------------------------|
| Pao   | 31.974 k                 | Maxo             | 153.74 k-in            | Mayo             | 36.44 k-in             |
| Ae    | 1.1511 in <sup>2</sup>   | Ixe              | 26.708 in <sup>4</sup> | Iye              | 3.032 in <sup>4</sup>  |
| Ta    | 55.857 k                 | Sxe(t)           | 5.1348 in <sup>3</sup> | Sye(l)           | 3.0046 in <sup>3</sup> |
|       |                          | Sxe(b)           | 5.5655 in <sup>3</sup> | Sye(r)           | 1.2171 in <sup>3</sup> |
| Shear |                          | Negative Bending |                        | Negative Bending |                        |
| Vay   | 9.712 k                  | Maxo             | 153.74 k-in            | Mayo             | 34.19 k-in             |
| Vax   | 11.358 k                 | Ixe              | 26.708 in <sup>4</sup> | Iye              | 2.515 in <sup>4</sup>  |
| Ba    | 130.06 k-in <sup>2</sup> | Sxe(t)           | 5.5655 in <sup>3</sup> | Sye(l)           | 1.9379 in <sup>3</sup> |
|       |                          | Sxe(b)           | 5.1348 in <sup>3</sup> | Sye(r)           | 1.1421 in <sup>3</sup> |

**Member Check - AISI S100-16/S3-22, US, ASD**

Material Type: A653 SS Grade 50/1, Fy=50 ksi

Design Parameters:

|                    |           |     |           |    |           |
|--------------------|-----------|-----|-----------|----|-----------|
| Lx                 | 18.000 ft | Ly  | 0.000 ft  | Lt | 18.000 ft |
| Kx                 | 1.0000    | Ky  | 1.0000    | Kt | 1.0000    |
| Cbx                | 1.0000    | Cby | 1.0000    | ex | 0.0000 in |
| Cmx                | 1.0000    | Cmy | 1.0000    | ey | 0.0000 in |
| Braced Flange: Top | kφ        | 0 k |           |    |           |
| Red. Factor, R:    | 0.4       | Lm  | 18.000 ft |    |           |

| Loads:   | P<br>(k) | Mx<br>(k-in) | Vy<br>(k) | My<br>(k-in) | Vx<br>(k) |
|----------|----------|--------------|-----------|--------------|-----------|
| Entered  | 0.000    | 138.85       | 3.210     | 0.00         | 0.000     |
| Applied  | 0.000    | 138.85       | 3.210     | 0.00         | 0.000     |
| Strength | 15.503   | 143.83       | 9.712     | 23.91        | 11.358    |

Interaction Equations

|            |             |                                      |
|------------|-------------|--------------------------------------|
| Eq. H1.2-1 | (P, Mx, My) | 0.000 + 0.965 + 0.000 = 0.965 <= 1.0 |
| Eq. H2-1   | (Mx, Vy)    | Sqrt(0.816 + 0.109) = 0.962 <= 1.0   |
| Eq. H2-1   | (My, Vx)    | Sqrt(0.000 + 0.000) = 0.000 <= 1.0   |

## PURLIN-POST CONNECTION

$V_1 := R_1 = 5143 \text{ lbf}$  *ASD-level bearing force*

$V_2 := -R_2 = 1835 \text{ lbf}$  *ASD-level uplift force*

*SHEAR DUE TO LATERAL FORCES (SEISMIC AND C&C)  
ARE OMITTED AS VERTICAL FORCES WILL GOVERN.*

**TABLE 4—ALLOWABLE SHEAR (BEARING) CAPACITY ( $P_{NS}/\Omega$ ), pounds-force<sup>1, 2, 3, 4, 5</sup>**

| Steel Fu = 45 ksi, Applied Factor of Safety, Ω=3.0 |                        |                                                                    |                                                                |       |       |       |       |       |       |       |       |       |       |      |
|----------------------------------------------------|------------------------|--------------------------------------------------------------------|----------------------------------------------------------------|-------|-------|-------|-------|-------|-------|-------|-------|-------|-------|------|
| Screw Designation                                  | Nominal Diameter (in.) | Design Thickness of Member Not in Contact with the Screw Head (in) | Design Thickness of Member in Contact with the Screw Head (in) |       |       |       |       |       |       |       |       |       |       |      |
|                                                    |                        |                                                                    | 0.018                                                          | 0.024 | 0.030 | 0.036 | 0.048 | 0.060 | 0.075 | 0.105 | 0.125 | 0.187 | 0.250 |      |
| 10-16                                              | 0.190                  | 0.018                                                              | 66                                                             | 66    | 66    | 66    | 66    | 66    | 66    | 66    | 66    | 66    | 66    | 66   |
|                                                    |                        | 0.024                                                              | 102                                                            | 102   | 102   | 102   | 102   | 102   | 102   | 102   | 102   | 102   | 102   | 102  |
|                                                    |                        | 0.030                                                              | 111                                                            | 143   | 143   | 143   | 143   | 143   | 143   | 143   | 143   | 143   | 143   | 143  |
|                                                    |                        | 0.036                                                              | 120                                                            | 152   | 185   | 188   | 188   | 188   | 188   | 188   | 188   | 188   | 188   | 188  |
|                                                    |                        | 0.048                                                              | 139                                                            | 168   | 199   | 228   | 289   | 289   | 289   | 289   | 289   | 289   | 289   | 289  |
|                                                    |                        | 0.060                                                              | 139                                                            | 185   | 213   | 239   | 327   | 404   | 404   | 404   | 404   | 404   | 404   | 404  |
|                                                    |                        | 0.075                                                              | 139                                                            | 185   | 231   | 251   | 337   | 427   | 564   | 564   | 564   | 564   | 564   | 564  |
|                                                    |                        | 0.105                                                              | 139                                                            | 185   | 231   | 277   | 356   | 436   | 570   | 808   | 808   | 808   | 808   | 808  |
| 12-14<br>12-24                                     | 0.216                  | 0.018                                                              | 71                                                             | 71    | 71    | 71    | 71    | 71    | 71    | 71    | 71    | 71    | 71    | 71   |
|                                                    |                        | 0.024                                                              | 109                                                            | 109   | 109   | 109   | 109   | 109   | 109   | 109   | 109   | 109   | 109   | 109  |
|                                                    |                        | 0.030                                                              | 125                                                            | 152   | 152   | 152   | 152   | 152   | 152   | 152   | 152   | 152   | 152   | 152  |
|                                                    |                        | 0.036                                                              | 136                                                            | 170   | 205   | 200   | 200   | 200   | 200   | 200   | 200   | 200   | 200   | 200  |
|                                                    |                        | 0.048                                                              | 157                                                            | 190   | 223   | 253   | 308   | 308   | 308   | 308   | 308   | 308   | 308   | 308  |
|                                                    |                        | 0.060                                                              | 157                                                            | 210   | 240   | 266   | 362   | 430   | 430   | 430   | 430   | 430   | 430   | 430  |
|                                                    |                        | 0.075                                                              | 157                                                            | 210   | 262   | 282   | 375   | 468   | 601   | 601   | 601   | 601   | 601   | 601  |
|                                                    |                        | 0.105                                                              | 157                                                            | 210   | 262   | 315   | 402   | 483   | 624   | 919   | 919   | 919   | 919   | 919  |
|                                                    |                        | 0.125                                                              | 157                                                            | 210   | 262   | 315   | 420   | 494   | 629   | 919   | 1094  | 1094  | 1094  | 1094 |
|                                                    |                        | 0.187                                                              | 157                                                            | 210   | 262   | 315   | 420   | 525   | 642   | 819   | 1094  | 1636  | 1636  | 1636 |
|                                                    |                        | 0.250                                                              | 157                                                            | 210   | 262   | 315   | 420   | 525   | 656   | 919   | 1094  | 1636  | 2187  | 2187 |
|                                                    |                        | 0.018                                                              | 76                                                             | 76    | 76    | 76    | 76    | 76    | 76    | 76    | 76    | 76    | 76    |      |

$V_a := 919 \text{ lbf}$  *allowable shear for (1) TEK screw*

$$\frac{\max(V_1, V_2)}{8 V_a} = 70\%$$

**(8) #12-14 TEK SCREWS OK**

## TYPICAL POST

**NOMINAL LOADS:**      *FOR USE IN ENERCALC (SEE APPENDIX)*

$$P_D := \frac{1}{2} A \cdot D = 0.2826 \text{ kip} \quad \text{axial dead load}$$

$$P_S := \frac{1}{4} S \cdot A \cdot B = 4.86 \text{ kip} \quad \text{axial snow load}$$

$$V_W := \frac{1}{4} (1 \text{ ft}) \cdot A \cdot P_f = 0.3037 \text{ kip} \quad \text{wind load about weak axis of post}$$

$$V_E := \frac{1}{4} E_h = 0.2492 \text{ kip} \quad \text{seismic load about weak axis of post}$$

**HSS4x4x1/8 OK**

*(ENERCALC)*

## TYPICAL FOOTING

### NOMINAL LOADS: FOR USE IN ENERCALC (SEE APPENDIX)

$$P_D := P_D + (W_{post} \cdot h) = 0.3343 \text{ kip} \quad \text{axial dead load}$$

$$P_S = 4.86 \text{ kip} \quad \text{axial snow load}$$

$$V_W = 0.3037 \text{ kip} \quad \text{lateral wind load}$$

$$V_E = 0.2492 \text{ kip} \quad \text{lateral seismic load}$$

### POLE FOOTING SPECIFICATIONS

$$\sigma_{max} = 2000 \text{ psf}$$

$$D_{min} := \sqrt{\frac{4 (P_D + P_S)}{\pi \cdot \sigma_{max}}} = 21.8 \text{ in} \quad \text{minimum diameter}$$

$$DIAMETER := 24 \text{ in}$$

$$DEPTH := 3.0 \text{ ft}$$

$$\gamma_{conc} := 150 \text{ pcf} \quad \text{concrete unit weight}$$

**UPLIFT CHECK WITH SOIL CONE THEORY**

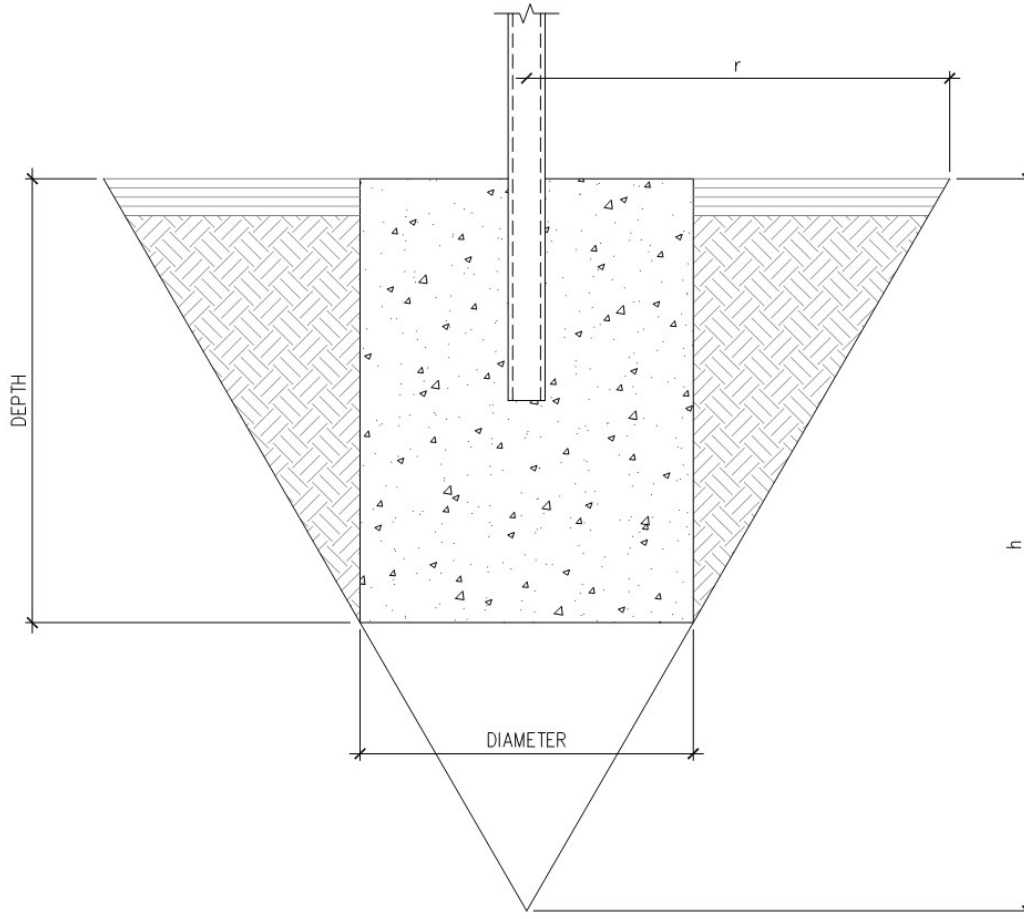

$$\phi := 30^\circ$$

$$\gamma := 110 \text{ pcf} \quad \text{soil unit weight}$$

$$V_{FTG} := \frac{\pi}{4} \text{ DEPTH DIAMETER}^2 = 9.425 \text{ ft}^3$$

$$r := \text{DEPTH} \tan(\phi) + \frac{1}{2} \text{ DIAMETER} = 2.732 \text{ ft}$$

$$h_{cone} := \frac{r}{\tan(\phi)} = 4.732 \text{ ft}$$

$$V_{soil} := \left( \frac{\pi}{3} r^2 h_{cone} \right) - V_{FTG} = 27.563 \text{ ft}^3$$

$$W_{FTG\&cone} := \gamma_{conc} V_{FTG} + \gamma V_{soil} = 4.45 \text{ kip}$$

$$P_{Dreq'd} := -P_{NWB} \cdot \left( \frac{1}{4} \cdot A \cdot B \right) = 3.34 \text{ kip}$$

$$\frac{P_{Dreq'd}}{W_{FTG\&cone}} = 75\%$$

**2-FIT DIAMETER x 3.0-FT DEEP FOOTING OK**

(ENERCALC)

## TYPICAL ALTERNATE FOOTING

**NOMINAL LOADS:**      *FOR USE IN ENERCALC (SEE APPENDIX)*

$$P_D = 0.3343 \text{ kip} \qquad \text{axial dead load}$$

$$P_S = 4.86 \text{ kip} \qquad \text{axial snow load}$$

$$P_W := -\left(\frac{1}{4} A \frac{B}{2} (-P_{NWB} - P_{NLB})\right) = -1.8222 \text{ kip} \qquad \text{axial wind load}$$

$$V_W = 0.3037 \text{ kip} \qquad M_W := V_W h = 2.4295 \text{ kip} \cdot \text{ft} \qquad \text{wind lateral load \& moment}$$

$$V_E = 0.2492 \text{ kip} \qquad M_E := V_E h = 1.9938 \text{ kip} \cdot \text{ft} \qquad \text{seismic lateral load \& moment}$$

**3.5-FT SQUARE x 2-FT DEEP FOOTING w/  
(6) #4 BARS E.W. TOP & BOTTOM OK**

*(ENERCALC)*

## APPENDIX A

---

**Project: BRADLEY HEIGHTS CARPORTS**
**Steel Column**

Project File: 21178 - ENERCALC.ec6

LIC#: KW-06014086, Build:20.24.10.30

SITTS &amp; HILL ENGINEERING, INC.

(c) ENERCALC, LLC 1982-2026

**DESCRIPTION: TYPICAL POST**
**Code References**

Calculations per AISC 360-16, IBC 2021

Load Combinations Used : ASCE 7-16

**General Information**
**Steel Section Name :** HSS4x4x1/8

Analysis Method : Allowable Strength

Steel Stress Grade : A500, Grade B, Fy = 46 ksi, Carbon Steel

Fy : Steel Yield : 46.0 ksi

E : Elastic Bending Modulus : 29,000.0 ksi

Overall Column Height : 8.0 ft

Top &amp; Bottom Fixity : Top Free, Bottom Fixed

Brace condition :

Unbraced Length for buckling ABOUT X-X Axis = 8.0 ft, K = 2.1

Unbraced Length for buckling ABOUT Y-Y Axis = 8.0 ft, K = 2.1

**Applied Loads**

Service loads entered. Load Factors will be applied for calculations.

Column self weight included : 51.680 lbs \* Dead Load Factor

**AXIAL LOADS . . .**

Axial Load at 8.0 ft, D = 0.2826, S = 4.860 k

**BENDING LOADS . . .**

Lat. Point Load at 8.0 ft creating My-y, W = 0.3037, E = 0.2492 k

**DESIGN SUMMARY**
**Bending & Shear Check Results**
**PASS** Max. Axial+Bending Stress Ratio = **0.4556** : 1

Load Combination : +D+0.750S+0.6563E

Location of max.above base : 0.0 ft

At maximum location values are . . .

Pa : Axial : 3.979 k

Pn / Omega : Allowable : 16.341 k

Ma-x : Applied : 0.0 k-ft

Mn-x / Omega : Allowable : 5.483 k-ft

Ma-y : Applied : -1.308 k-ft

Mn-y / Omega : Allowable : 5.483 k-ft

**Maximum Load Reactions . .**

Top along X-X : 0.0 k

Bottom along X-X : 0.3037 k

Top along Y-Y : 0.0 k

Bottom along Y-Y : 0.0 k

**Maximum Load Deflections . . .**

 Along Y-Y : 0.0 in at 0.0ft above base  
for load combination :

 Along X-X : 0.6984 in at 8.0ft above base  
for load combination : W Only

**PASS** Maximum Shear Stress Ratio = **0.01557** : 1

Load Combination : +D+0.8750E

Location of max.above base : 0.0 ft

At maximum location values are . . .

Va : Applied : 0.2181 k

Vn / Omega : Allowable : 14.003 k

**Load Combination Results**

| Load Combination  | Maximum Axial + Bending Stress Ratios |        |          |              | Cb <sub>x</sub> | Cb <sub>y</sub> | K <sub>x</sub> L <sub>x</sub> /R <sub>x</sub> | K <sub>y</sub> L <sub>y</sub> /R <sub>y</sub> | Maximum Shear Ratios |          |  |
|-------------------|---------------------------------------|--------|----------|--------------|-----------------|-----------------|-----------------------------------------------|-----------------------------------------------|----------------------|----------|--|
|                   | Stress Ratio                          | Status | Location | Stress Ratio |                 |                 |                                               |                                               | Status               | Location |  |
| D Only            | 0.020                                 | PASS   | 0.00 ft  | 1.00         | 1.67            | 127.59          | 127.59                                        | 0.000                                         | PASS                 | 0.00 ft  |  |
| +D+S              | 0.318                                 | PASS   | 0.00 ft  | 1.00         | 1.67            | 127.59          | 127.59                                        | 0.000                                         | PASS                 | 0.00 ft  |  |
| +D+0.750S         | 0.244                                 | PASS   | 0.00 ft  | 1.00         | 1.67            | 127.59          | 127.59                                        | 0.000                                         | PASS                 | 0.00 ft  |  |
| +D+0.60W          | 0.276                                 | PASS   | 0.00 ft  | 1.00         | 1.67            | 127.59          | 127.59                                        | 0.013                                         | PASS                 | 0.00 ft  |  |
| +D+0.450W         | 0.210                                 | PASS   | 0.00 ft  | 1.00         | 1.67            | 127.59          | 127.59                                        | 0.010                                         | PASS                 | 0.00 ft  |  |
| +D+0.750S+0.450W  | 0.421                                 | PASS   | 0.00 ft  | 1.00         | 1.67            | 127.59          | 127.59                                        | 0.010                                         | PASS                 | 0.00 ft  |  |
| +0.60D+0.60W      | 0.272                                 | PASS   | 0.00 ft  | 1.00         | 1.67            | 127.59          | 127.59                                        | 0.013                                         | PASS                 | 0.00 ft  |  |
| +D+0.8750E        | 0.328                                 | PASS   | 0.00 ft  | 1.00         | 1.67            | 127.59          | 127.59                                        | 0.016                                         | PASS                 | 0.00 ft  |  |
| +D+0.750S+0.6563E | 0.456                                 | PASS   | 0.00 ft  | 1.00         | 1.67            | 127.59          | 127.59                                        | 0.012                                         | PASS                 | 0.00 ft  |  |
| +0.60D+0.8750E    | 0.324                                 | PASS   | 0.00 ft  | 1.00         | 1.67            | 127.59          | 127.59                                        | 0.016                                         | PASS                 | 0.00 ft  |  |

**Maximum Reactions**

Note: Only non-zero reactions are listed.

| Load Combination | Axial Reaction | X-X Axis Reaction |       | k | Y-Y Axis Reaction |       | M <sub>x</sub> - End Moments |       | M <sub>y</sub> - End Moments |       |
|------------------|----------------|-------------------|-------|---|-------------------|-------|------------------------------|-------|------------------------------|-------|
|                  | @ Base         | @ Base            | @ Top |   | @ Base            | @ Top | @ Base                       | @ Top | @ Base                       | @ Top |
| D Only           | 0.334          |                   |       |   |                   |       |                              |       |                              |       |
| +D+S             | 5.194          |                   |       |   |                   |       |                              |       |                              |       |
| +D+0.750S        | 3.979          |                   |       |   |                   |       |                              |       |                              |       |
| +D+0.60W         | 0.334          | -0.182            |       |   |                   |       |                              |       | -1.458                       |       |

**Steel Column**

Project File: 21178 - ENERCALC.ec6

LIC# : KW-06014086, Build:20.24.10.30

SITTS &amp; HILL ENGINEERING, INC.

(c) ENERCALC, LLC 1982-2026

**DESCRIPTION: TYPICAL POST**
**Maximum Reactions**

Note: Only non-zero reactions are listed.

| Load Combination  | Axial Reaction | X-X Axis Reaction |       | k | Y-Y Axis Reaction |       | Mx - End Moments |       | My - End Moments |       |
|-------------------|----------------|-------------------|-------|---|-------------------|-------|------------------|-------|------------------|-------|
|                   | @ Base         | @ Base            | @ Top |   | @ Base            | @ Top | @ Base           | @ Top | @ Base           | @ Top |
| +D+0.450W         | 0.334          | -0.137            |       |   |                   |       |                  |       | -1.093           |       |
| +D+0.750S+0.450W  | 3.979          | -0.137            |       |   |                   |       |                  |       | -1.093           |       |
| +0.60D+0.60W      | 0.201          | -0.182            |       |   |                   |       |                  |       | -1.458           |       |
| +D+0.70E          | 0.334          | -0.174            |       |   |                   |       |                  |       | -1.396           |       |
| +D+0.750S+0.5250E | 3.979          | -0.131            |       |   |                   |       |                  |       | -1.047           |       |
| +0.60D+0.70E      | 0.201          | -0.174            |       |   |                   |       |                  |       | -1.396           |       |
| S Only            | 4.860          |                   |       |   |                   |       |                  |       |                  |       |
| W Only            |                | -0.304            |       |   |                   |       |                  |       | -2.430           |       |
| E Only            |                | -0.249            |       |   |                   |       |                  |       | -1.994           |       |

**Extreme Reactions**

| Item                    | Extreme Value | Axial Reaction | X-X Axis Reaction |       | k | Y-Y Axis Reaction |       | Mx - End Moments |       | My - End Moments |       |
|-------------------------|---------------|----------------|-------------------|-------|---|-------------------|-------|------------------|-------|------------------|-------|
|                         |               | @ Base         | @ Base            | @ Top |   | @ Base            | @ Top | @ Base           | @ Top | @ Base           | @ Top |
| Axial @ Base            | Maximum       | 5.194          |                   |       |   |                   |       |                  |       |                  |       |
| "                       | Minimum       |                | -0.304            |       |   |                   |       |                  |       | -2.430           |       |
| Reaction, X-X Axis Base | Maximum       | 0.334          |                   |       |   |                   |       |                  |       |                  |       |
| "                       | Minimum       |                | -0.304            |       |   |                   |       |                  |       | -2.430           |       |
| Reaction, Y-Y Axis Base | Maximum       | 0.334          |                   |       |   |                   |       |                  |       |                  |       |
| "                       | Minimum       | 0.334          |                   |       |   |                   |       |                  |       |                  |       |
| Reaction, X-X Axis Top  | Maximum       | 0.334          |                   |       |   |                   |       |                  |       |                  |       |
| "                       | Minimum       | 0.334          |                   |       |   |                   |       |                  |       |                  |       |
| Reaction, Y-Y Axis Top  | Maximum       | 0.334          |                   |       |   |                   |       |                  |       |                  |       |
| "                       | Minimum       |                | -0.249            |       |   |                   |       |                  |       | -1.994           |       |
| Moment, X-X Axis Base   | Maximum       | 0.334          |                   |       |   |                   |       |                  |       |                  |       |
| "                       | Minimum       | 0.334          |                   |       |   |                   |       |                  |       |                  |       |
| Moment, Y-Y Axis Base   | Maximum       | 0.334          |                   |       |   |                   |       |                  |       |                  |       |
| "                       | Minimum       |                | -0.304            |       |   |                   |       |                  |       | -2.430           |       |
| Moment, X-X Axis Top    | Maximum       | 0.334          |                   |       |   |                   |       |                  |       |                  |       |
| "                       | Minimum       | 0.334          |                   |       |   |                   |       |                  |       |                  |       |
| Moment, Y-Y Axis Top    | Maximum       | 0.334          |                   |       |   |                   |       |                  |       |                  |       |
| "                       | Minimum       | 0.334          |                   |       |   |                   |       |                  |       |                  |       |

**Maximum Deflections for Load Combinations**

| Load Combination  | Max. Deflection in X dir | Distance | Max. Deflection in Y dir | Distance |
|-------------------|--------------------------|----------|--------------------------|----------|
| D Only            | 0.0000 in                | 0.000 ft | 0.000 in                 | 0.000 ft |
| +D+S              | 0.0000 in                | 0.000 ft | 0.000 in                 | 0.000 ft |
| +D+0.750S         | 0.0000 in                | 0.000 ft | 0.000 in                 | 0.000 ft |
| +D+0.60W          | 0.4190 in                | 8.000 ft | 0.000 in                 | 0.000 ft |
| +D+0.450W         | 0.3143 in                | 8.000 ft | 0.000 in                 | 0.000 ft |
| +D+0.750S+0.450W  | 0.3143 in                | 8.000 ft | 0.000 in                 | 0.000 ft |
| +0.60D+0.60W      | 0.4190 in                | 8.000 ft | 0.000 in                 | 0.000 ft |
| +D+0.70E          | 0.4011 in                | 8.000 ft | 0.000 in                 | 0.000 ft |
| +D+0.750S+0.5250E | 0.3009 in                | 8.000 ft | 0.000 in                 | 0.000 ft |
| +0.60D+0.70E      | 0.4011 in                | 8.000 ft | 0.000 in                 | 0.000 ft |
| S Only            | 0.0000 in                | 0.000 ft | 0.000 in                 | 0.000 ft |
| W Only            | 0.6984 in                | 8.000 ft | 0.000 in                 | 0.000 ft |
| E Only            | 0.5673 in                | 7.946 ft | 0.000 in                 | 0.000 ft |

**Steel Section Properties : HSS4x4x1/8**
**Steel Section Properties : HSS4x4x1/8**

**Project: BRADLEY HEIGHTS CARPORTS**

**Steel Column**

Project File: 21178 - ENERCALC.ec6

LIC# : KW-06014086, Build:20.24.10.30

SITTS & HILL ENGINEERING, INC.

(c) ENERCALC, LLC 1982-2026

**DESCRIPTION: TYPICAL POST**

|              |   |                       |                 |   |                       |   |   |                       |
|--------------|---|-----------------------|-----------------|---|-----------------------|---|---|-----------------------|
| Depth        | = | 4.000 in              | I <sub>xx</sub> | = | 4.40 in <sup>4</sup>  | J | = | 6.910 in <sup>4</sup> |
| Design Thick | = | 0.116 in              | S <sub>xx</sub> | = | 2.20 in <sup>3</sup>  |   |   |                       |
| Width        | = | 4.000 in              | R <sub>xx</sub> | = | 1.580 in              |   |   |                       |
| Wall Thick   | = | 0.125 in              | Z <sub>x</sub>  | = | 2.560 in <sup>3</sup> |   |   |                       |
| Area         | = | 1.770 in <sup>2</sup> | I <sub>yy</sub> | = | 4.400 in <sup>4</sup> | C | = | 3.490 in <sup>3</sup> |
| Weight       | = | 6.460 plf             | S <sub>yy</sub> | = | 2.200 in <sup>3</sup> |   |   |                       |
|              |   |                       | R <sub>yy</sub> | = | 1.580 in              |   |   |                       |
| Ycg          | = | 0.000 in              |                 |   |                       |   |   |                       |

**Sketches**

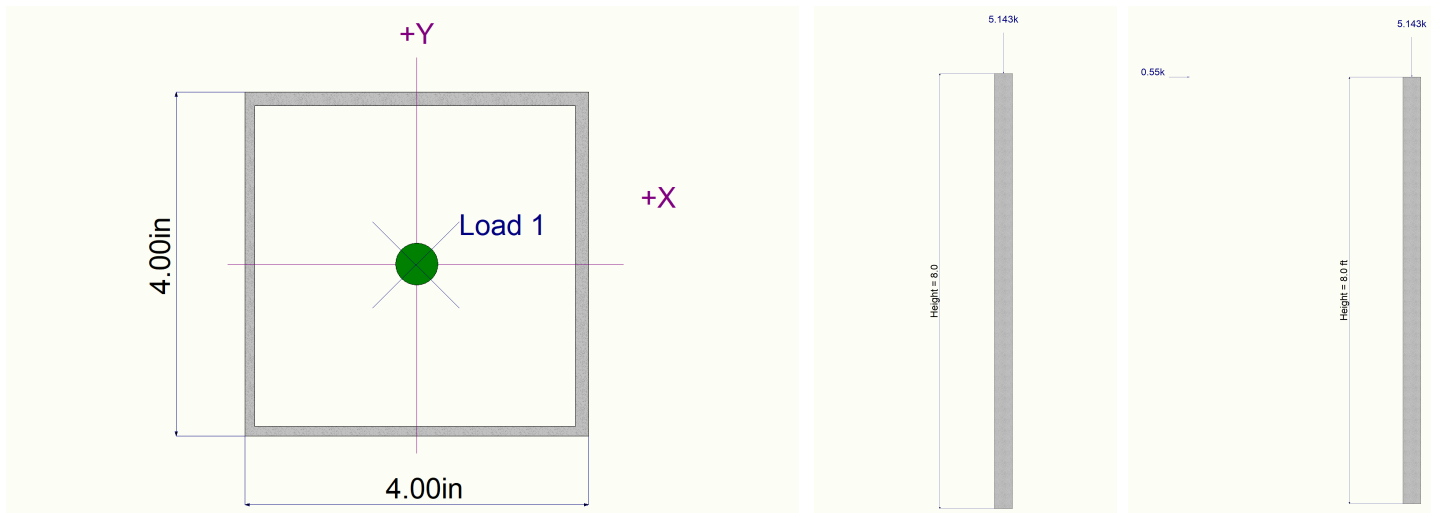

**Pole Footing Embedded in Soil**

Project File: 21178 - ENERCALC.ec6

LIC#: KW-06014086, Build:20.24.10.30

SITTS & HILL ENGINEERING, INC.

(c) ENERCALC, LLC 1982-2026

**DESCRIPTION: TYPICAL FOOTING**

**Code References**

Calculations per IBC 2021 1807.3  
Load Combinations Used : ASCE 7-16

**General Information**

|                                              |           |
|----------------------------------------------|-----------|
| Pole Footing Shape                           | Circular  |
| Pole Footing Diameter                        | 24.0 in   |
| Calculate Min. Depth for Allowable Pressures |           |
| No Lateral Restraint at Ground Surface       |           |
| Allow Passive                                | 300.0 pcf |
| Max Passive                                  | psf       |

**Controlling Values**

|                             |             |
|-----------------------------|-------------|
| Governing Load Combination  | D+0.60W     |
| Lateral Load                | 0.1822 k    |
| Moment                      | 1.458 k-ft  |
| NO Ground Surface Restraint |             |
| Pressures at 1/3 Depth      |             |
| Actual                      | 291.064 psf |
| Allowable                   | 291.993 psf |

**Minimum Required Depth                      3.0 ft**

|                       |            |
|-----------------------|------------|
| Footing Base Area     | 3.142 ft^2 |
| Maximum Soil Pressure | 1.653 ksf  |

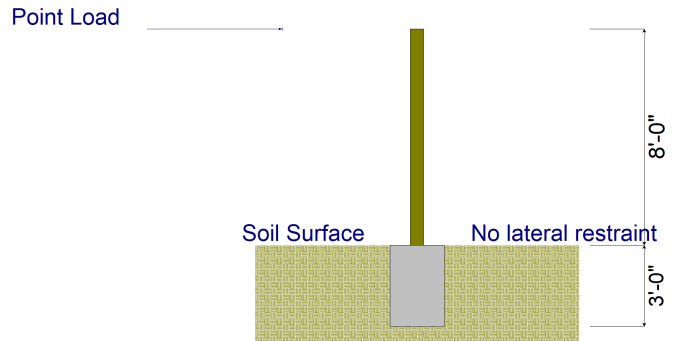

**Applied Loads**

| Lateral Concentrated Load (k)                                  | Lateral Distributed Loads (k)       | Vertical Load (k) |
|----------------------------------------------------------------|-------------------------------------|-------------------|
| D : Dead Load                      k                           |                                     | 0.3343 k          |
| Lr : Roof Live                      k                          |                                     | k                 |
| L : Live                      k                                |                                     | k                 |
| S : Snow                      k                                |                                     | 4.860 k           |
| W : Wind                      0.3037 k                         |                                     | k                 |
| E : Earthquake                      0.2492 k                   |                                     | k                 |
| H : Lateral Earth                      k                       |                                     | k                 |
| Load distance above ground surface                      8.0 ft | TOP of Load above ground surface    |                   |
|                                                                | BOTTOM of Load above ground surface |                   |
|                                                                |                                     | ft                |

**Load Combination Results**

| Load Combination  | Forces @ Ground Surface |                  | Required Depth - (ft) | Pressure at 1/3 Depth |               | Soil Increase Factor |
|-------------------|-------------------------|------------------|-----------------------|-----------------------|---------------|----------------------|
|                   | Loads - (k)             | Moments - (ft-k) |                       | Actual - (psf)        | Allow - (psf) |                      |
| D Only            | 0.000                   | 0.000            | 0.13                  | 0.0                   | 0.0           | 1.000                |
| +D+S              | 0.000                   | 0.000            | 0.13                  | 0.0                   | 0.0           | 1.000                |
| +D+0.750S         | 0.000                   | 0.000            | 0.13                  | 0.0                   | 0.0           | 1.000                |
| +D+0.60W          | 0.182                   | 1.458            | 3.00                  | 291.1                 | 292.0         | 1.000                |
| +D+0.450W         | 0.137                   | 1.093            | 2.75                  | 262.2                 | 263.1         | 1.000                |
| +D+0.750S+0.450W  | 0.137                   | 1.093            | 2.75                  | 262.2                 | 263.1         | 1.000                |
| +0.60D+0.60W      | 0.182                   | 1.458            | 3.00                  | 291.1                 | 292.0         | 1.000                |
| +D+0.70E          | 0.174                   | 1.396            | 3.00                  | 285.5                 | 287.9         | 1.000                |
| +D+0.750S+0.5250E | 0.131                   | 1.047            | 2.63                  | 258.3                 | 258.9         | 1.000                |



Tacoma, WA · (253) 474-9449

Designed: JPR

Date: 02/17/26

Project Number: 21,178

Checked: CJT

Date: 02/17/26

Project: BRADLEY HEIGHTS CARPORTS

**Pole Footing Embedded in Soil**

Project File: 21178 - ENERCALC.ec6

LIC# : KW-06014086, Build:20.24.10.30

SITTS & HILL ENGINEERING, INC.

(c) ENERCALC, LLC 1982-2026

**DESCRIPTION: TYPICAL FOOTING**

|              |       |       |      |       |       |       |
|--------------|-------|-------|------|-------|-------|-------|
| +0.60D+0.70E | 0.174 | 1.396 | 3.00 | 285.5 | 287.9 | 1.000 |
|--------------|-------|-------|------|-------|-------|-------|

**Project: BRADLEY HEIGHTS CARPORTS**

**General Footing**

Project File: 21178 - ENERCALC.ec6

LIC#: KW-06014086, Build: 20.24.10.30

SITTS & HILL ENGINEERING, INC.

(c) ENERCALC, LLC 1982-2026

**DESCRIPTION: TYPICAL ALTERNATE FOOTING**

**Code References**

Calculations per ACI 318-19, IBC 2021  
Load Combinations Used : ASCE 7-16

**General Information**

**Material Properties**

|                                |   |             |
|--------------------------------|---|-------------|
| f'c : Concrete 28 day strength | = | 2.50 ksi    |
| fy : Rebar Yield               | = | 60.0 ksi    |
| Ec : Concrete Elastic Modulus  | = | 3,122.0 ksi |
| Concrete Density               | = | 150.0 pcf   |
| φ Values Flexure               | = | 0.90        |
| Shear                          | = | 0.750       |

**Soil Design Values**

|                                       |   |           |
|---------------------------------------|---|-----------|
| Allowable Soil Bearing                | = | 2.0 ksf   |
| Soil Density                          | = | 110.0 pcf |
| Increase Bearing By Footing Weight    | = | No        |
| Soil Passive Resistance (for Sliding) | = | 300.0 pcf |
| Soil/Concrete Friction Coeff.         | = | 0.350     |

**Analysis Settings**

|                                            |   |         |
|--------------------------------------------|---|---------|
| Min Steel % Bending Reinf.                 | = |         |
| Min Allow % Temp Reinf.                    | = |         |
| Min. Overturning Safety Factor             | = | 1.0 : 1 |
| Min. Sliding Safety Factor                 | = | 1.0 : 1 |
| Add Ftg Wt for Soil Pressure               | : | Yes     |
| Use ftg wt for stability, moments & shears | : | Yes     |
| Add Pedestal Wt for Soil Pressure          | : | Yes     |
| Use Pedestal wt for stability, mom & shear | : | Yes     |

**Increases based on footing depth**

|                                                                    |   |        |
|--------------------------------------------------------------------|---|--------|
| Footing base depth below soil surface                              | = | 2.0 ft |
| Allow press. increase per foot of depth when footing base is below | = | ksf ft |

**Increases based on footing plan dimension**

|                                                                                         |   |        |
|-----------------------------------------------------------------------------------------|---|--------|
| Allowable pressure increase per foot of depth when max. length or width is greater than | = | ksf ft |
|-----------------------------------------------------------------------------------------|---|--------|

**Dimensions**

|                             |   |         |
|-----------------------------|---|---------|
| Width parallel to X-X Axis  | = | 3.50 ft |
| Length parallel to Z-Z Axis | = | 3.50 ft |
| Footing Thickness           | = | 24.0 in |

**Pedestal dimensions...**

|                                                              |   |        |
|--------------------------------------------------------------|---|--------|
| px : parallel to X-X Axis                                    | = | in     |
| pz : parallel to Z-Z Axis                                    | = | in     |
| Height                                                       | = | in     |
| Rebar Centerline to Edge of Concrete... at Bottom of footing | = | 3.0 in |

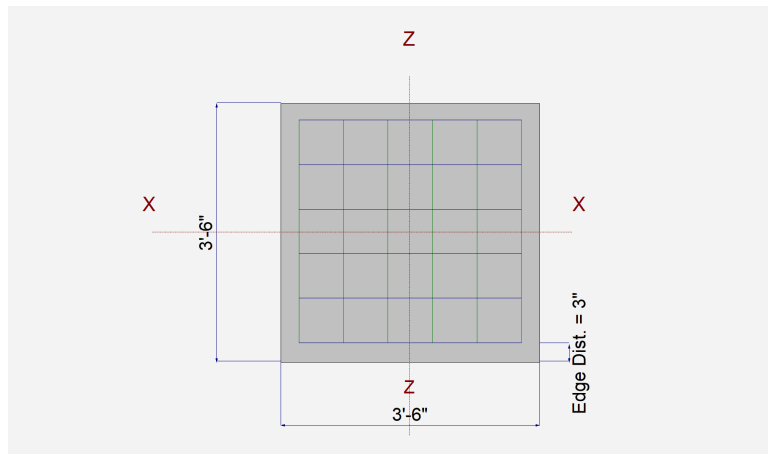

**Reinforcing**

|                                                    |   |     |
|----------------------------------------------------|---|-----|
| <b>Bars parallel to X-X Axis</b>                   | = |     |
| Number of Bars                                     | = | 6   |
| Reinforcing Bar Size                               | = | # 4 |
| <b>Bars parallel to Z-Z Axis</b>                   | = |     |
| Number of Bars                                     | = | 6   |
| Reinforcing Bar Size                               | = | # 4 |
| <b>Bandwidth Distribution Check (ACI 15.4.4.2)</b> |   |     |
| Direction Requiring Closer Separation              |   | n/a |
| # Bars required within zone                        |   | n/a |
| # Bars required on each side of zone               |   | n/a |

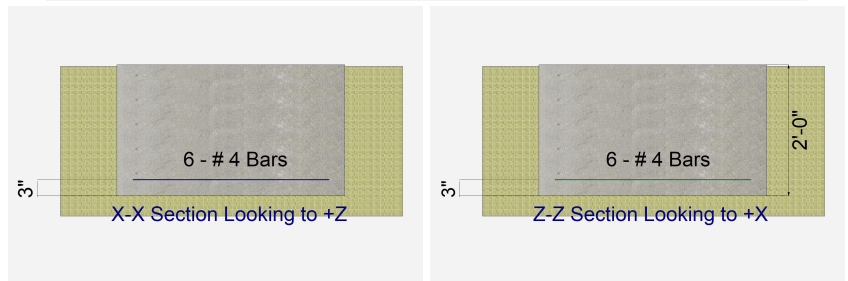

**Applied Loads**

|                 | D | Lr     | L | S | W      | E      | H |  |      |
|-----------------|---|--------|---|---|--------|--------|---|--|------|
| P : Column Load | = | 0.3343 |   |   | 4.860  | -1.822 |   |  | k    |
| OB : Overburden | = |        |   |   |        |        |   |  | ksf  |
| M-xx            | = |        |   |   |        |        |   |  | k-ft |
| M-zz            | = |        |   |   | 2.430  | 1.994  |   |  | k-ft |
| V-x             | = |        |   |   | 0.3037 | 0.2492 |   |  | k    |
| V-z             | = |        |   |   |        |        |   |  | k    |

**Project: BRADLEY HEIGHTS CARPORTS**
**General Footing**

Project File: 21178 - ENERCALC.ec6

LIC#: KW-06014086, Build:20.24.10.30

SITTS &amp; HILL ENGINEERING, INC.

(c) ENERCALC, LLC 1982-2026

**DESCRIPTION: TYPICAL ALTERNATE FOOTING**
**DESIGN SUMMARY**
**Design OK**

|      | Min. Ratio | Item             | Applied       | Capacity       | Governing Load Combination |
|------|------------|------------------|---------------|----------------|----------------------------|
| PASS | 0.3620     | Soil Bearing     | 0.7240 ksf    | 2.0 ksf        | +D+S about Z-Z axis        |
| PASS | n/a        | Overturing - X-X | 0.0 k-ft      | 0.0 k-ft       | No Overturing              |
| PASS | 1.127      | Overturing - Z-Z | 3.736 k-ft    | 4.210 k-ft     | +0.60D+0.60W               |
| PASS | 14.045     | Sliding - X-X    | 0.1822 k      | 2.559 k        | +0.60D+0.60W               |
| PASS | n/a        | Sliding - Z-Z    | 0.0 k         | 0.0 k          | No Sliding                 |
| PASS | 2.20       | Uplift           | -1.093 k      | 2.406 k        | +0.60D+0.60W               |
| PASS | 0.03541    | Z Flexure (+X)   | 1.125 k-ft/ft | 31.778 k-ft/ft | +1.20D+1.60S+0.50W         |
| PASS | 0.03217    | Z Flexure (-X)   | 1.022 k-ft/ft | 31.778 k-ft/ft | +1.20D+1.60S               |
| PASS | 0.03217    | X Flexure (+Z)   | 1.022 k-ft/ft | 31.778 k-ft/ft | +1.20D+1.60S               |
| PASS | 0.03217    | X Flexure (-Z)   | 1.022 k-ft/ft | 31.778 k-ft/ft | +1.20D+1.60S               |
| PASS | n/a        | 1-way Shear (+X) | 0.0 psi       | 33.242 psi     | n/a                        |
| PASS | 0.0        | 1-way Shear (-X) | 0.0 psi       | 0.0 psi        | n/a                        |
| PASS | n/a        | 1-way Shear (+Z) | 0.0 psi       | 33.242 psi     | n/a                        |
| PASS | n/a        | 1-way Shear (-Z) | 0.0 psi       | 33.242 psi     | n/a                        |
| PASS | n/a        | 2-way Punching   | 3.477 psi     | 33.242 psi     | +1.20D+1.60S               |

**Top reinforcing mat required (see 'Bending' tab).**
**Hand check required for anchor pullout.**
**Detailed Results**
**Soil Bearing**

| Rotation Axis & Load Combination... | Gross Allowable | Xecc   | Zecc (in) | Actual Soil Bearing Stress @ Location |         |          |           | Actual / Allow Ratio |
|-------------------------------------|-----------------|--------|-----------|---------------------------------------|---------|----------|-----------|----------------------|
|                                     |                 |        |           | Bottom, -Z                            | Top, +Z | Left, -X | Right, +X |                      |
| X-X, D Only                         | 2.0             | n/a    | 0.0       | 0.3273                                | 0.3273  | n/a      | n/a       | 0.164                |
| X-X, +D+S                           | 2.0             | n/a    | 0.0       | 0.7240                                | 0.7240  | n/a      | n/a       | 0.362                |
| X-X, +D+0.750S                      | 2.0             | n/a    | 0.0       | 0.6248                                | 0.6248  | n/a      | n/a       | 0.312                |
| X-X, +D+0.60W                       | 2.660           | n/a    | 0.0       | 0.2380                                | 0.2380  | n/a      | n/a       | 0.089                |
| X-X, +D+0.450W                      | 2.660           | n/a    | 0.0       | 0.2604                                | 0.2604  | n/a      | n/a       | 0.098                |
| X-X, +D+0.750S+0.450W               | 2.660           | n/a    | 0.0       | 0.5579                                | 0.5579  | n/a      | n/a       | 0.210                |
| X-X, +0.60D+0.60W                   | 2.660           | n/a    | 0.0       | 0.1071                                | 0.1071  | n/a      | n/a       | 0.040                |
| X-X, +D+0.70E                       | 2.660           | n/a    | 0.0       | 0.3273                                | 0.3273  | n/a      | n/a       | 0.123                |
| X-X, +D+0.750S+0.5250E              | 2.660           | n/a    | 0.0       | 0.6248                                | 0.6248  | n/a      | n/a       | 0.235                |
| X-X, +0.60D+0.70E                   | 2.660           | n/a    | 0.0       | 0.1964                                | 0.1964  | n/a      | n/a       | 0.074                |
| Z-Z, D Only                         | 2.0             | 0.0    | n/a       | n/a                                   | n/a     | 0.3273   | 0.3273    | 0.164                |
| Z-Z, +D+S                           | 2.0             | 0.0    | n/a       | n/a                                   | n/a     | 0.7240   | 0.7240    | 0.362                |
| Z-Z, +D+0.750S                      | 2.0             | 0.0    | n/a       | n/a                                   | n/a     | 0.6248   | 0.6248    | 0.312                |
| Z-Z, +D+0.60W                       | 2.660           | 7.50   | n/a       | n/a                                   | n/a     | 0.0      | 0.4912    | 0.185                |
| Z-Z, +D+0.450W                      | 2.660           | 5.143  | n/a       | n/a                                   | n/a     | 0.0710   | 0.4497    | 0.169                |
| Z-Z, +D+0.750S+0.450W               | 2.660           | 2.40   | n/a       | n/a                                   | n/a     | 0.3685   | 0.7473    | 0.281                |
| Z-Z, +0.60D+0.60W                   | 2.660           | 16.664 | n/a       | n/a                                   | n/a     | 0.0      | 0.6806    | 0.256                |
| Z-Z, +D+0.70E                       | 2.660           | 5.222  | n/a       | n/a                                   | n/a     | 0.08558  | 0.5690    | 0.214                |
| Z-Z, +D+0.750S+0.5250E              | 2.660           | 2.051  | n/a       | n/a                                   | n/a     | 0.4436   | 0.8061    | 0.303                |
| Z-Z, +0.60D+0.70E                   | 2.660           | 8.703  | n/a       | n/a                                   | n/a     | 0.0      | 0.4446    | 0.167                |

**Overturing Stability**

| Rotation Axis & Load Combination... | Overturing Moment | Resisting Moment | Stability Ratio | Status |
|-------------------------------------|-------------------|------------------|-----------------|--------|
| X-X, D Only                         | None              | 0.0 k-ft         | Infinity        | OK     |
| X-X, +D+S                           | None              | 0.0 k-ft         | Infinity        | OK     |
| X-X, +D+0.750S                      | None              | 0.0 k-ft         | Infinity        | OK     |
| X-X, +D+0.60W                       | None              | 0.0 k-ft         | Infinity        | OK     |
| X-X, +D+0.450W                      | None              | 0.0 k-ft         | Infinity        | OK     |
| X-X, +D+0.750S+0.450W               | None              | 0.0 k-ft         | Infinity        | OK     |
| X-X, +0.60D+0.60W                   | None              | 0.0 k-ft         | Infinity        | OK     |
| X-X, +D+0.70E                       | None              | 0.0 k-ft         | Infinity        | OK     |
| X-X, +D+0.750S+0.5250E              | None              | 0.0 k-ft         | Infinity        | OK     |
| X-X, +0.60D+0.70E                   | None              | 0.0 k-ft         | Infinity        | OK     |
| Z-Z, D Only                         | None              | 0.0 k-ft         | Infinity        | OK     |
| Z-Z, +D+S                           | None              | 0.0 k-ft         | Infinity        | OK     |

**Project: BRADLEY HEIGHTS CARPORTS**

**General Footing**

Project File: 21178 - ENERCALC.ec6

LIC#: KW-06014086, Build:20.24.10.30

SITTS & HILL ENGINEERING, INC.

(c) ENERCALC, LLC 1982-2026

**DESCRIPTION: TYPICAL ALTERNATE FOOTING**

**Overturning Stability**

| Rotation Axis & Load Combination... | Overturning Moment | Resisting Moment | Stability Ratio | Status |
|-------------------------------------|--------------------|------------------|-----------------|--------|
| Z-Z, +D+0.750S                      | None               | 0.0 k-ft         | Infinity        | OK     |
| Z-Z, +D+0.60W                       | 3.736 k-ft         | 7.016 k-ft       | 1.878           | OK     |
| Z-Z, +D+0.450W                      | 2.802 k-ft         | 7.016 k-ft       | 2.504           | OK     |
| Z-Z, +D+0.750S+0.450W               | 2.802 k-ft         | 13.395 k-ft      | 4.781           | OK     |
| Z-Z, +0.60D+0.60W                   | 3.736 k-ft         | 4.210 k-ft       | 1.127           | OK     |
| Z-Z, +D+0.70E                       | 1.745 k-ft         | 7.016 k-ft       | 4.022           | OK     |
| Z-Z, +D+0.750S+0.5250E              | 1.309 k-ft         | 13.395 k-ft      | 10.237          | OK     |
| Z-Z, +0.60D+0.70E                   | 1.745 k-ft         | 4.210 k-ft       | 2.413           | OK     |

All units k

**Sliding Stability**

| Force Application Axis Load Combination... | Sliding Force | Resisting Force | Stability Ratio | Status |
|--------------------------------------------|---------------|-----------------|-----------------|--------|
| X-X, D Only                                | 0.0 k         | 3.503 k         | No Sliding      | OK     |
| X-X, +D+S                                  | 0.0 k         | 5.204 k         | No Sliding      | OK     |
| X-X, +D+0.750S                             | 0.0 k         | 4.779 k         | No Sliding      | OK     |
| X-X, +D+0.60W                              | 0.1822 k      | 3.121 k         | 17.126          | OK     |
| X-X, +D+0.450W                             | 0.1367 k      | 3.216 k         | 23.534          | OK     |
| X-X, +D+0.750S+0.450W                      | 0.1367 k      | 4.492 k         | 32.869          | OK     |
| X-X, +0.60D+0.60W                          | 0.1822 k      | 2.559 k         | 14.045          | OK     |
| X-X, +D+0.70E                              | 0.1744 k      | 3.503 k         | 20.083          | OK     |
| X-X, +D+0.750S+0.5250E                     | 0.1308 k      | 4.779 k         | 36.528          | OK     |
| X-X, +0.60D+0.70E                          | 0.1744 k      | 2.942 k         | 16.865          | OK     |
| Z-Z, D Only                                | 0.0 k         | 3.503 k         | No Sliding      | OK     |
| Z-Z, +D+S                                  | 0.0 k         | 5.204 k         | No Sliding      | OK     |
| Z-Z, +D+0.750S                             | 0.0 k         | 4.779 k         | No Sliding      | OK     |
| Z-Z, +D+0.60W                              | 0.0 k         | 3.121 k         | No Sliding      | OK     |
| Z-Z, +D+0.70E                              | 0.0 k         | 3.503 k         | No Sliding      | OK     |
| Z-Z, +D+0.750S+0.5250E                     | 0.0 k         | 4.779 k         | No Sliding      | OK     |
| Z-Z, +0.60D+0.70E                          | 0.0 k         | 2.942 k         | No Sliding      | OK     |
| Z-Z, +D+0.450W                             | 0.0 k         | 3.216 k         | No Sliding      | OK     |
| Z-Z, +D+0.750S+0.450W                      | 0.0 k         | 4.492 k         | No Sliding      | OK     |
| Z-Z, +0.60D+0.60W                          | 0.0 k         | 2.559 k         | No Sliding      | OK     |

**Footing Flexure**

| Flexure Axis & Load Combination | Mu k-ft | Side | Tension Surface | As Req'd in^2 | Gvrn. As in^2 | Actual As in^2 | Phi*Mn k-ft | Status |
|---------------------------------|---------|------|-----------------|---------------|---------------|----------------|-------------|--------|
| X-X, +1.40D                     | 0.05850 | +Z   | Bottom          | 0.000619      | Applied Mu    | 0.3429         | 31.778      | OK     |
| X-X, +1.40D                     | 0.05850 | -Z   | Bottom          | 0.000619      | Applied Mu    | 0.3429         | 31.778      | OK     |
| X-X, +1.20D                     | 0.05015 | +Z   | Bottom          | 0.000531      | Applied Mu    | 0.3429         | 31.778      | OK     |
| X-X, +1.20D                     | 0.05015 | -Z   | Bottom          | 0.000531      | Applied Mu    | 0.3429         | 31.778      | OK     |
| X-X, +1.20D+0.50S               | 0.3539  | +Z   | Bottom          | 0.003746      | Applied Mu    | 0.3429         | 31.778      | OK     |
| X-X, +1.20D+0.50S               | 0.3539  | -Z   | Bottom          | 0.003746      | Applied Mu    | 0.3429         | 31.778      | OK     |
| X-X, +1.20D+0.50W               | 0.06373 | +Z   | Top             | 0.000674      | Applied Mu    | 0.3429         | 31.778      | OK     |
| X-X, +1.20D+0.50W               | 0.06373 | -Z   | Top             | 0.000674      | Applied Mu    | 0.3429         | 31.778      | OK     |
| X-X, +1.20D+1.60S               | 1.022   | +Z   | Bottom          | 0.01082       | Applied Mu    | 0.3429         | 31.778      | OK     |
| X-X, +1.20D+1.60S               | 1.022   | -Z   | Bottom          | 0.01082       | Applied Mu    | 0.3429         | 31.778      | OK     |
| X-X, +1.20D+1.60S+0.50W         | 0.9083  | +Z   | Bottom          | 0.009617      | Applied Mu    | 0.3429         | 31.778      | OK     |
| X-X, +1.20D+1.60S+0.50W         | 0.9083  | -Z   | Bottom          | 0.009617      | Applied Mu    | 0.3429         | 31.778      | OK     |
| X-X, +1.20D+W                   | 0.1776  | +Z   | Top             | 0.001880      | Applied Mu    | 0.3429         | 31.778      | OK     |
| X-X, +1.20D+W                   | 0.1776  | -Z   | Top             | 0.001880      | Applied Mu    | 0.3429         | 31.778      | OK     |
| X-X, +1.20D+0.50S+W             | 0.1261  | +Z   | Bottom          | 0.001335      | Applied Mu    | 0.3429         | 31.778      | OK     |
| X-X, +1.20D+0.50S+W             | 0.1261  | -Z   | Bottom          | 0.001335      | Applied Mu    | 0.3429         | 31.778      | OK     |
| X-X, +0.90D+W                   | 0.1901  | +Z   | Top             | 0.002012      | Applied Mu    | 0.3429         | 31.778      | OK     |
| X-X, +0.90D+W                   | 0.1901  | -Z   | Top             | 0.002012      | Applied Mu    | 0.3429         | 31.778      | OK     |
| X-X, +1.20D+0.20S+E             | 0.1716  | +Z   | Bottom          | 0.001817      | Applied Mu    | 0.3429         | 31.778      | OK     |
| X-X, +1.20D+0.20S+E             | 0.1716  | -Z   | Bottom          | 0.001817      | Applied Mu    | 0.3429         | 31.778      | OK     |
| X-X, +0.90D+E                   | 0.03761 | +Z   | Bottom          | 0.000398      | Applied Mu    | 0.3429         | 31.778      | OK     |
| X-X, +0.90D+E                   | 0.03761 | -Z   | Bottom          | 0.000398      | Applied Mu    | 0.3429         | 31.778      | OK     |
| Z-Z, +1.40D                     | 0.05850 | -X   | Bottom          | 0.000619      | Applied Mu    | 0.3429         | 31.778      | OK     |
| Z-Z, +1.40D                     | 0.05850 | +X   | Bottom          | 0.000619      | Applied Mu    | 0.3429         | 31.778      | OK     |
| Z-Z, +1.20D                     | 0.05015 | -X   | Bottom          | 0.000531      | Applied Mu    | 0.3429         | 31.778      | OK     |
| Z-Z, +1.20D                     | 0.05015 | +X   | Bottom          | 0.000531      | Applied Mu    | 0.3429         | 31.778      | OK     |

**Project: BRADLEY HEIGHTS CARPORTS**

**General Footing**

Project File: 21178 - ENERCALC.ec6

LIC#: KW-06014086, Build: 20.24.10.30

SITTS & HILL ENGINEERING, INC.

(c) ENERCALC, LLC 1982-2026

**DESCRIPTION: TYPICAL ALTERNATE FOOTING**

**Footing Flexure**

| Flexure Axis & Load Combination | Mu<br>k-ft | Side | Tension<br>Surface | As Req'd<br>in^2 | Gvrn. As<br>in^2 | Actual As<br>in^2 | Phi*Mn<br>k-ft | Status |
|---------------------------------|------------|------|--------------------|------------------|------------------|-------------------|----------------|--------|
| Z-Z, +1.20D+0.50S               | 0.3539     | -X   | Bottom             | 0.003746         | Applied Mu       | 0.3429            | 31.778         | OK     |
| Z-Z, +1.20D+0.50S               | 0.3539     | +X   | Bottom             | 0.003746         | Applied Mu       | 0.3429            | 31.778         | OK     |
| Z-Z, +1.20D+0.50W               | 0.2807     | -X   | Top                | 0.002970         | Applied Mu       | 0.3429            | 31.778         | OK     |
| Z-Z, +1.20D+0.50W               | 0.1532     | +X   | Bottom             | 0.001621         | Applied Mu       | 0.3429            | 31.778         | OK     |
| Z-Z, +1.20D+1.60S               | 1.022      | -X   | Bottom             | 0.01082          | Applied Mu       | 0.3429            | 31.778         | OK     |
| Z-Z, +1.20D+1.60S               | 1.022      | +X   | Bottom             | 0.01082          | Applied Mu       | 0.3429            | 31.778         | OK     |
| Z-Z, +1.20D+1.60S+0.50W         | 0.6913     | -X   | Bottom             | 0.007319         | Applied Mu       | 0.3429            | 31.778         | OK     |
| Z-Z, +1.20D+1.60S+0.50W         | 1.125      | +X   | Bottom             | 0.01192          | Applied Mu       | 0.3429            | 31.778         | OK     |
| Z-Z, +1.20D+W                   | 0.5458     | -X   | Top                | 0.005778         | Applied Mu       | 0.3429            | 31.778         | OK     |
| Z-Z, +1.20D+W                   | 0.3219     | +X   | Bottom             | 0.003407         | Applied Mu       | 0.3429            | 31.778         | OK     |
| Z-Z, +1.20D+0.50S+W             | 0.3077     | -X   | Top                | 0.003257         | Applied Mu       | 0.3429            | 31.778         | OK     |
| Z-Z, +1.20D+0.50S+W             | 0.560      | +X   | Bottom             | 0.005928         | Applied Mu       | 0.3429            | 31.778         | OK     |
| Z-Z, +0.90D+W                   | 0.4134     | -X   | Top                | 0.004376         | Applied Mu       | 0.3429            | 31.778         | OK     |
| Z-Z, +0.90D+W                   | 0.4507     | +X   | Bottom             | 0.004771         | Applied Mu       | 0.3429            | 31.778         | OK     |
| Z-Z, +1.20D+0.20S+E             | 0.1844     | -X   | Top                | 0.001951         | Applied Mu       | 0.3429            | 31.778         | OK     |
| Z-Z, +1.20D+0.20S+E             | 0.5277     | +X   | Bottom             | 0.005586         | Applied Mu       | 0.3429            | 31.778         | OK     |
| Z-Z, +0.90D+E                   | 0.3144     | -X   | Top                | 0.003327         | Applied Mu       | 0.3429            | 31.778         | OK     |
| Z-Z, +0.90D+E                   | 0.3977     | +X   | Bottom             | 0.004209         | Applied Mu       | 0.3429            | 31.778         | OK     |

**One Way Shear X**

| Load Combination... | Vu @ -X  | Vu @ +X  | Vu:Max   | Phi Vn    | Vu / Phi*Vn | Status |
|---------------------|----------|----------|----------|-----------|-------------|--------|
| +1.40D              | 0.00 psi | 0.00 psi | 0.00 psi | 33.24 psi | 0.00        | OK     |
| +1.20D              | 0.00 psi | 0.00 psi | 0.00 psi | 33.24 psi | 0.00        | OK     |
| +1.20D+0.50S        | 0.00 psi | 0.00 psi | 0.00 psi | 33.24 psi | 0.00        | OK     |
| +1.20D+0.50W        | 0.00 psi | 0.00 psi | 0.00 psi | 33.24 psi | 0.00        | OK     |
| +1.20D+1.60S        | 0.00 psi | 0.00 psi | 0.00 psi | 33.24 psi | 0.00        | OK     |
| +1.20D+1.60S+0.50W  | 0.00 psi | 0.00 psi | 0.00 psi | 33.24 psi | 0.00        | OK     |
| +1.20D+W            | 0.00 psi | 0.00 psi | 0.00 psi | 33.24 psi | 0.00        | OK     |
| +1.20D+0.50S+W      | 0.00 psi | 0.00 psi | 0.00 psi | 33.24 psi | 0.00        | OK     |
| +0.90D+W            | 0.00 psi | 0.00 psi | 0.00 psi | 33.24 psi | 0.00        | OK     |
| +1.20D+0.20S+E      | 0.00 psi | 0.00 psi | 0.00 psi | 33.24 psi | 0.00        | OK     |
| +0.90D+E            | 0.00 psi | 0.00 psi | 0.00 psi | 33.24 psi | 0.00        | OK     |

**One Way Shear Z**

| Load Combination... | Vu @ -Z  | Vu @ +Z  | Vu:Max   | Phi Vn    | Vu / Phi*Vn | Status |
|---------------------|----------|----------|----------|-----------|-------------|--------|
| +1.40D              | 0.00 psi | 0.00 psi | 0.00 psi | 33.24 psi | 0.00        | OK     |
| +1.20D              | 0.00 psi | 0.00 psi | 0.00 psi | 33.24 psi | 0.00        | OK     |
| +1.20D+0.50S        | 0.00 psi | 0.00 psi | 0.00 psi | 33.24 psi | 0.00        | OK     |
| +1.20D+0.50W        | 0.00 psi | 0.00 psi | 0.00 psi | 33.24 psi | 0.00        | OK     |
| +1.20D+1.60S        | 0.00 psi | 0.00 psi | 0.00 psi | 33.24 psi | 0.00        | OK     |
| +1.20D+1.60S+0.50W  | 0.00 psi | 0.00 psi | 0.00 psi | 33.24 psi | 0.00        | OK     |
| +1.20D+W            | 0.00 psi | 0.00 psi | 0.00 psi | 33.24 psi | 0.00        | OK     |
| +1.20D+0.50S+W      | 0.00 psi | 0.00 psi | 0.00 psi | 33.24 psi | 0.00        | OK     |
| +0.90D+W            | 0.00 psi | 0.00 psi | 0.00 psi | 33.24 psi | 0.00        | OK     |
| +1.20D+0.20S+E      | 0.00 psi | 0.00 psi | 0.00 psi | 33.24 psi | 0.00        | OK     |
| +0.90D+E            | 0.00 psi | 0.00 psi | 0.00 psi | 33.24 psi | 0.00        | OK     |

**Two-Way "Punching" Shear**

All units k

| Load Combination... | Vu       | Phi*Vn    | Vu / Phi*Vn | Status |
|---------------------|----------|-----------|-------------|--------|
| +1.40D              | 0.20 psi | 150.00psi | 0.001327    | OK     |
| +1.20D              | 0.17 psi | 150.00psi | 0.001137    | OK     |
| +1.20D+0.50S        | 1.20 psi | 150.00psi | 0.008025    | OK     |
| +1.20D+0.50W        | 0.22 psi | 150.00psi | 0.001445    | OK     |
| +1.20D+1.60S        | 3.48 psi | 150.00psi | 0.02318     | OK     |
| +1.20D+1.60S+0.50W  | 3.09 psi | 150.00psi | 0.0206      | OK     |
| +1.20D+W            | 0.60 psi | 150.00psi | 0.004027    | OK     |
| +1.20D+0.50S+W      | 0.43 psi | 150.00psi | 0.00286     | OK     |
| +0.90D+W            | 0.65 psi | 150.00psi | 0.004312    | OK     |
| +1.20D+0.20S+E      | 0.58 psi | 150.00psi | 0.003892    | OK     |
| +0.90D+E            | 0.13 psi | 150.00psi | 0.000888    | OK     |

February 10, 2022

Bradley Heights SS, LLC  
1816C 11<sup>th</sup> avenue  
Seattle, WA 98122

Attn: Jorden Mellergaard  
(509) 899-0326  
jorden@timberlanepartners.com

Geotechnical Engineering Report  
Proposed Multi-Family Development  
202 - 27<sup>th</sup> Avenue Southeast  
Puyallup, Washington  
PN: 0419036006  
Doc ID: Timberlane.BradleyHeights.RG

## INTRODUCTION

This *geotechnical engineering report* summarizes our site observations, subsurface explorations, laboratory testing and engineering analyses, and provides geotechnical recommendations and design criteria for the proposed multi-story, multi-family residential development to be located at 202 - 27<sup>th</sup> Avenue Southeast in the City of Puyallup within Pierce County, Washington. The development is proposed to be on one Pierce County tax parcel, numbered 0419036006. The site is currently in use as a trailer park with multiple single-family trailers and access road. The general location of the site is shown on the attached Site Location Map, Figure 1.

Our understanding of the project is based on our discussions with you, a review of the *Conceptual Site Plan* provided to us by Azure Green Consultants (attached as our Figure 2), our subsurface explorations, including those completed during our most recent December 22, 2021 site visit, and our experience in the general area.

We understand that the proposed development will include the construction of 12 multi-family residential structures and one clubhouse building. We anticipate the structures will range from one to three stories and will be supported by conventional spread footings. Additional development will include paved drive lanes and parking areas, a below-grade stormwater facility, and associated typical below grade utilities.

## SCOPE

The purpose of our services was to evaluate the surface and subsurface conditions across the site as a basis for providing geotechnical recommendations and design criteria for the proposed development. Specifically, the scope of services for this project will include the following:

1. Reviewed available geological, hydrogeological, and geotechnical literature for the site area;

2. Monitoring the drilling of three hollow-stem auger borings to depths of about 21 feet below existing grades and completed as groundwater observation wells;
3. Describing surface and subsurface conditions, including soil type, and depth to groundwater;
4. Performing one Small Scale (PIT) at a location and elevation determined and approved by the project civil engineer;
5. Providing seismic design parameters, including 2018 IBC site class;
6. Providing geotechnical conclusions and recommendations regarding site grading activities, including site preparation, subgrade preparation, fill placement criteria, suitability of on-site soils for use as structural fill, temporary and permanent cut slopes and drainage and erosion control measures;
7. Providing recommendations for the design and construction of shallow foundations and slabs-on-grade including bearing capacity and subgrade modulus as appropriate;
8. Providing our opinion about the feasibility of onsite infiltration in accordance with the 2012 (with 2014 updates) Department of Ecology Stormwater Management Manual for Western Washington (SWMMWW);
9. Providing recommendations for erosion and sediment control during wet weather grading and construction;
10. Preparing this written *Geotechnical Engineering Report* summarizing our site observations and conclusions, and our geotechnical recommendations and design criteria, along with the supporting data; and,
11. Monitoring groundwater levels on a monthly basis during the prescribed wet season and prepare a written report addendum summarizing the collected data.
12. Provided a design infiltration rate based on in-situ testing, as applicable; and,
13. Updated our preliminary *Geotechnical Engineering Report*, summarized our site observations and conclusions, our geotechnical recommendations and design criteria, along with supporting data.

The above scope of work was summarized in our Proposal for Geotechnical Engineering Services dated December 3, 2021. We received authorization from Mr. David R. Enslow the same day.

## **SITE CONDITIONS**

### **Surface Conditions**

The site is located at 202 – 27<sup>th</sup> Avenue Southeast in Puyallup, Washington (PN: 0419036006), within an area of existing residential development. The site is generally rectangular in shape, measures approximately 1,115 to 1,130 feet wide (east to west) by 300 feet long (north to south), and encompasses about 7.78 acres. The site is bounded by residential development to the south, east, and west, and by 27<sup>th</sup> Avenue Southeast to the north.

The site generally slopes gently down from southeast to northwest towards the intersection of 27<sup>th</sup> Avenue Southeast and South Meridian. The southeastern and south-central portions of the site slope down at approximately 3 to 5 percent, while the north-central and southwestern portions of the site slope down to the northwest at approximately 7 to 10 percent, with localized slopes of approximately 20 to 22 percent located in the southwestern corner of the site. The northwestern corner of the site slopes down to 27<sup>th</sup> Avenue Southeast at approximately 2 to 4 percent. The total topographic

relief across the site is on the order of 48 to 50 feet.

Vegetation across the site generally consists of typical residential landscaping and grass lawn areas with occasional coniferous and deciduous trees along the site perimeter and scattered within the existing lots. No areas of erosion or slope instability were noted at the site at the time of our reconnaissance.

### Site Soils

The USDA Natural Resource Conservation Survey (NRCS) Web Soil Survey maps most of the site, including the areas of proposed development, as being underlain by Everett gravelly sandy loam (13B and 13C). An area in the northwestern portion of the site is mapped as being underlain by Kitsap silt loam (20B). An excerpt from the NRCS soils map for the site area is included as Figure 3. These soils are described below.

- Everett very gravelly sandy loam (13B, 13C): The Everett soils are typically derived from sandy and gravelly glacial outwash and form on slopes of 0 to 8 (13B) and 8 to 15 (13C) percent. These soils are listed as having a “slight” (13B) and “moderate,” (13C) erosion hazard when exposed, and are included in hydrologic soils group A.
- Kitsap Silt Loam (20B): The Kitsap soils are derived from glaciolacustrine deposits, form on slopes of 2 to 8 percent, are listed as having a “slight to moderate” erosion hazard, and are included in hydrologic soils group C/D.

### Site Geology

The draft *Geologic Map of the Puyallup 7.5-minute Quadrangle, Washington* by K. W. Troost (in review) maps the site as being underlain by recessional outwash (Qvsb<sub>4</sub>) and adjacent to areas mapped as underlain by recessional lacustrine deposits (Qvrl). These glacial soils were deposited during near the end of the Vashon Stade of the Fraser Glaciation, approximately 12,000 to 15,000 years ago. An excerpt of the above reference geologic map is attached as Figure 3. Description of the geologic units is provided below.

- Recessional Outwash (Qvsb<sub>4</sub>): Recessional outwash deposits typically consist of a poorly sorted, lightly to moderately stratified mixture of sand and gravel that may locally contain silt or clay. Recessional outwash was deposited by meltwater streams issuing from the receding continental ice mass. Accordingly, they are considered normally consolidated and offer moderate strength properties where undisturbed. The potential for stormwater infiltration is generally favorable, depending on grain size.
- Recessional-Lacustrine (Qvrl): Recessional-lacustrine or glaciolacustrine deposits typically consist of a stratified to varved deposit of clay, silt, and sand that was deposited within glacial lakes or other low energy fluvial environments. These deposits are considered normally consolidated and exhibit low to moderate strength and moderate compressibility characteristics where undisturbed. Because of the silty nature of recessional lacustrine soils, the potential for stormwater infiltration is low.

### Subsurface Explorations

As part of the scope of work for this study, on January 24, 2020 a GeoResources representative was on site and monitored the drilling of three hollow-stem auger borings to depths of 21 to 21½ feet

below existing grades. After termination of drilling, each boring was completed as a groundwater monitoring well in accordance with Washington Department of Ecology Regulations. On December 22, 2021, a GeoResources representative returned to the site and monitored the excavation of two test pits (TP-101 and TP-102) and performed a small-scale pilot infiltration test (PIT) in general accordance with the 2019 Department of Ecology Stormwater Management Manual of Western Washington (2019 SWMMWW) to determine the initial saturated hydraulic conductivity ( $K_{sat, initial}$ ) of the subsurface soils at 4 feet below existing grades. The PIT was completed at the location of TP-102. The test pits were excavated by a licensed contractor operating a track mounted excavator working for us.

On March 21, 2018, we monitored the excavation of five test pits to depths of 7½ to 8½ feet below existing grades under a separate scope of work. The work was completed for a different client as a portion of their feasibility period to purchase the property. The test pits are labeled as TP-1 through TP-5 and their locations are approximately shown on the Site and Exploration Plan, Figure 2.

The specific number, locations, and depths of our explorations were selected by GeoResources personnel based on the configuration of the proposed development and were adjusted in the field based on site access limitations. Given the existing development, access limitations were significant. A field representative from our office continuously monitored the test pit explorations, maintained logs of the subsurface conditions encountered, obtained representative soil samples, and observed pertinent site features. The soil densities presented on the test pit logs were based on the difficulty of excavation and our experience. Each test pit was then backfilled with the excavated material and abandoned.

The subsurface explorations excavated as part of this evaluation indicate the subsurface conditions at specific locations only, as actual subsurface conditions can vary across the site. Furthermore, the nature and extent of such variation would not become evident until additional explorations are performed or until construction activities have begun. Based on our experience in the area and extent of prior explorations in the area, it is our opinion that the soils encountered in the explorations are generally representative of the soils at the site. The soils encountered were visually classified in accordance with the Unified Soil Classification System (USCS) and ASTM D: 2488. The USCS is included in Appendix A as Figure A-1. The approximate locations of our explorations are indicated on the attached Site and Exploration Map, Figure 2, while the descriptive logs of our explorations and are included in Appendix A.

### **Subsurface Conditions**

In our opinion, the soils we encountered generally confirmed the mapped stratigraphy at the site and typical conditions for the general site area. In the western portion of the site, we generally encountered tan to light brown massive to laminated silt that was in a soft wet condition which we interpret as glaciolacustrine recessional outwash. In the central portions of the site, we encountered variable surficial conditions ranging from silt, silty sand, and sandy gravel that was in a loose/soft to medium dense/medium stiff, moist to wet condition. We interpret these soils as glaciolacustrine recessional outwash and uncontrolled fill. In the eastern portion of the site, we encountered dense silty sand with gravel that we interpret as glacial till. It appears the surficial soils in the central and western portions of the site were underlain by glacial till at depth.

Given the limitations of our subsurface exploration program because of the developed conditions, we anticipate that additional areas of uncontrolled fill may be present on the site.

Additional subsurface explorations would be required to determine the depths, extents, and composition of uncontrolled fill at the site.

### Laboratory Testing

Geotechnical laboratory tests were performed on select samples retrieved from the borings and test pits to estimate index engineering properties of the soils encountered. Laboratory testing included visual soil classification per ASTM D: 2488 and ASTM D: 2487, moisture content determinations per ASTM D: 2216, and grain size analyses per ASTM D: 6913 standard procedures. The results of the laboratory tests are included in Appendix B, and summarized below in Table 1.

**TABLE 1:  
 LABORATORY TEST RESULTS FOR ON-SITE SOILS**

| Soil Type                                       | Sample        | Lab ID Number | Gravel Content (percent) | Sand Content (percent) | Silt/Clay Content (percent) |
|-------------------------------------------------|---------------|---------------|--------------------------|------------------------|-----------------------------|
| Poorly graded GRAVEL with silt and sand (GP-GM) | B-1/S-5/12½ft | 099117        | 53.0                     | 36.9                   | 10.1                        |
| Well-graded GRAVEL with silt and sand (GW-GM)   | B-2/S-4/10ft  | 099123        | 55.4                     | 38.5                   | 6.1                         |
| SILT (ML)                                       | B-3/S-4/10ft  | 099129        | NA                       | NA                     | 97.0                        |
| NA = Not Applicable                             |               |               |                          |                        |                             |

### Groundwater Conditions

Groundwater monitoring was completed during the wet season between October 2020 to April 2021 in each of the three monitoring wells installed at the site. Monitoring was completed using downhole pressure transducers that collected daily measurements of water levels in each monitoring well. Additionally, one pressure transducer was installed at the site to provide daily measurements of barometric pressure. Measurements of barometric pressure were used to correct water level measurements for the effects of atmospheric pressure fluctuations.

Our observations indicate a seasonal perched groundwater table develops during the wet season in the western and central portions of the site. A perched groundwater table typically develops when the vertical infiltration of precipitation through a more permeable soil is slowed at depth by a deeper, less permeable soil type, such as glacial till. The groundwater table appears to have a limited thickness and fluctuates relatively rapidly. Total seasonal variation was on the order of 2 to 4 feet. Below, Table 2 summarizes the depths and elevations of groundwater observations for the site. Graphical outputs of wet season groundwater level measurements are included in Appendix C.

**TABLE 2:**  
**APPROXIMATE DEPTHS AND ELEVATIONS OF GROUNDWATER ENCOUNTERED IN EXPLORATIONS**

| Well ID | Depth to Seasonal High Groundwater (feet) | Seasonal High Elevation of Groundwater (feet) | Date Observed   |
|---------|-------------------------------------------|-----------------------------------------------|-----------------|
| MW-1    | 17                                        | 361                                           | February 23, 21 |
| MW-2    | 17                                        | 383                                           | January 13, 21  |
| MW-3    | NE                                        | NE                                            | NA              |

**Notes:** NE = Not encountered NA = Not applicable

## ENGINEERING CONCLUSIONS AND RECOMMENDATIONS

Based on the results of our data review, site reconnaissance, subsurface explorations and our experience in the area, it is our opinion that the site is suitable for the proposed multi-family development. Pertinent conclusions and geotechnical recommendations regarding the design and construction of the proposed multi-family development are presented below.

### Seismic Design

The site is located in the Puget Sound region of western Washington, which is seismically active. Seismicity in this region is attributed primarily to the interaction between the Pacific, Juan de Fuca and North American plates. The Juan de Fuca plate is subducting beneath the North American plate at the Cascadia Subduction Zone (CSZ). This produces both intercrustal (between plates) and intracrustal (within a plate) earthquakes. In the following sections we discuss the design criteria and potential hazards associated with the regional seismicity.

#### Seismic Site Class

Based on our observations and the subsurface units mapped at the site, we interpret the structural site conditions to correspond to a seismic Site Class "C" in accordance with the 2018 IBC documents and American Society of Civil Engineers (ASCE) standard 7-16 Chapter 20 Table 20.3-1. This is based on the reviewed range of SPT (Standard Penetration Test) blow counts for the soil types in the site area. These conditions were assumed to be representative for the subsurface conditions for the site.

#### Design parameters

The U.S. Geological Survey (USGS) completed probabilistic seismic hazard analyses (PSHA) for the entire country in November 1996, which were updated and republished in 2002 and 2008. We used the *ATC Hazard by Location* website to estimate seismic design parameters at the site. Table 4, below, summarizes the recommended design parameters.

**TABLE 3:**  
**2018 IBC Parameters for Design of Seismic Structures**

| Spectral Response Acceleration (SRA) and Site Coefficients | Short Period     | 1 Second Period  |
|------------------------------------------------------------|------------------|------------------|
| Mapped SRA                                                 | $S_s = 1.263$    | $S_1 = 0.435$    |
| Site Coefficients (Site Class C)                           | $F_a = 1.2$      | $F_v = 1.5$      |
| Maximum Considered Earthquake SRA                          | $S_{MS} = 1.516$ | $S_{M1} = 0.653$ |
| Design SRA                                                 | $S_{DS} = 1.010$ | $S_{D1} = 0.435$ |

Peak Ground Acceleration

The mapped peak ground acceleration (PGA) for this site is 0.5g. To account for site class, the PGA is multiplied by a site amplification factor ( $F_{PGA}$ ) of 1.2. The resulting site modified peak ground acceleration ( $PGA_M$ ) is 0.6g. In general, estimating seismic earth pressures ( $k_H$ ) by the Mononobe-Okabe method or seismic inputs for slope stability analysis are taken as 1/3 to 1/2 of the  $PGA_M$ , or 0.2g to 0.3g.

Seismic Hazards

Earthquake-induced geologic hazards may include liquefaction, lateral spreading, slope instability, and ground surface fault rupture. Liquefaction is a phenomenon where there is a reduction or complete loss of soil strength due to an increase in pore water pressure in soils. The increase in pore water pressure is induced by seismic vibrations. Liquefaction primarily affects geologically recent deposits of loose, uniformly graded, fine-grained sands and granular silts that are below the groundwater table. The site is mapped as having a “very low” liquefaction susceptibility by the *Liquefaction Susceptibility Map of Pierce County, Washington* (2004); an excerpt of this map is included as Figure 5. The soils encountered in our explorations consisted of a relatively limited thickness of loose to medium dense silty sand and medium stiff to stiff sandy silt underlain by dense to very dense glacial till. Give the limited perched groundwater table, we anticipate that settlements caused by liquefaction would be limited to less than estimated static settlements.

The ground surface at the project site is gently sloping. Accordingly, it is our opinion the potential for earthquake-induced slope instability on the site is low. No evidence of ground fault rupture was observed in the subsurface explorations or out site reconnaissance. Therefore, in our opinion, the proposed structures should have no greater risk for ground fault rupture than other structures located in the area.

**Foundation Support**

Based on the encountered subsurface conditions at the locations explored and the preliminary building plans, we recommend that spread footings be founded on the medium dense to very dense native glacial soils, or on structural fill that extends to suitable native soils. Based on our understanding of the proposed locations of the structures, it is our opinion that shallow foundations may be used to support the buildings; however, considerations for uncontrolled fill and loose to medium stiff native soils should be made. We have not been provided with the design loads and have assumed the structures will be lightly loaded based on our experience with similar projects.

### Complete Fill Removal

Uncontrolled fill soils and soft silt deposits encountered in the lower, western portion of the site are not a suitable bearing soil for the proposed footings. Any known locations of uncontrolled fill or uncontrolled fill encountered during grading should be removed from the building envelopes of the proposed structures. Soft silt soils in the western portion of the site can likely be mitigated through grading and placement of structural fill.

We recommend that all footing elements be supported by a minimum of 2 feet of properly placed structural fill. In areas where deeper fill removal is required the foundation elements may be deepened to extend to the base of the excavation, or the excavation may be backfilled with structural fill. After removal of the fill materials, the exposed surface should be evaluated prior to placing structural fill.

### Spread Footing design

Footings should bear on properly placed and compacted structural fill as discussed in the "Complete Fill Removal" section, above. Removal of unsuitable soils below the footings should extend beyond the foundation edges 1-foot horizontally for every 1-foot of vertical excavation. Loose, soft, or other unsuitable material present at the base of the excavation should be removed prior to placement of structural fill. The soil at the base of the excavations should be protected against disturbance from weather, traffic, or other adverse conditions. The excavation should be backfilled with suitable materials as described in the "**Structural Fill**" section of this report. If Control Density Fill (CDF) is used as backfill, the horizontal extent of the excavation can be limited to 1H:2V on each side of the footing.

We recommend a minimum width of 24 inches for isolated footings and at least 18 inches for continuous wall footings. All footing elements should be embedded at least 18 inches below grade for frost protection. For footing bearing surfaces prepared as described in the "Complete Fill Removal" we recommend using an allowable soil bearing capacity of 2,000 psf (pounds per square foot) for design. These values are for combined dead and long-term live loads. The weight of the footing and any overlying backfill may be neglected. The allowable bearing value may be increased by one-third for transient loads such as those induced by seismic events or wind loads.

Lateral loads may be resisted by friction on the base of footings and floor slabs and as passive pressure on the sides of footings. We recommend that an allowable coefficient of friction of 0.35 be used to calculate friction between the concrete and the underlying structural fill. Passive pressure may be determined using an allowable equivalent fluid density of 300 pcf (pounds per cubic foot). Factors of safety have been applied to these values.

We estimate that settlements of footings designed and constructed as recommended will be less than 1 inch, for the anticipated load conditions, with differential settlements between comparably loaded footings of ½ inch or less. Most of the settlements should occur essentially as loads are being applied; however, disturbance of the foundation subgrade during construction could result in larger settlements than estimated.

### **Floor Slab Support**

We anticipate that the lower level of the structures will consist of a slab-on-grade floor. Slab-on-grade floors should be supported on medium dense native soils or on structural fill prepared as

described above. Areas of uncontrolled fill material should be evaluated during grading activity for suitability of structural support. Areas of significant organic debris should be removed.

We recommend that floor slabs be directly underlain by a minimum 4-inch thick pea gravel or washed 5/8-inch crushed rock and should contain less than 5 percent fines. This layer should be placed and compacted to an unyielding condition.

A synthetic vapor retarder is recommended to control moisture migration through the slabs. This is of particular importance where moisture migration through the slab is an issue, such as where adhesives are used to anchor carpet or tile to the slab.

A subgrade modulus of 350 kcf (kips per cubic foot) may be used for floor slab design. We estimate that settlement of the floor slabs designed and constructed as recommended, will be 1/2 inch or less over a span of 50 feet.

### **Subgrade/Basement Walls**

The lateral pressures acting on retaining walls (such as basement or grade separation walls) will depend upon the nature and density of the soil behind the wall as well as the presence or absence of hydrostatic pressure. Below we provide recommended design values and drainage recommendations for retaining walls.

#### Design Values

For walls backfilled with granular well-drained soil and a level backslope, the design active pressure may be taken as 35 pcf (equivalent fluid density). For walls that are braced or otherwise restrained, the design at-rest pressure may be taken as 55 pcf. For the condition of an inclined back slope, higher lateral pressures would act on the walls. For a 3H:1V (Horizontal to Vertical) slope above the wall, the pressure may be taken as 35 pcf (equivalent fluid density). For walls that are braced or otherwise active pressure may be taken as 48 pcf; for a 2H:1V back slope condition, a wall design pressures of 55 pcf may be assumed. If basement walls taller than 6 feet are required, as seismic surcharge of 12H should be included where required by the code. If walls will be constructed with a backslope and will be braced or otherwise restrained against movement, we should be notified so that we can evaluate the anticipated conditions and recommend an appropriate at-rest earth pressure.

Lateral loads may be resisted by friction on the base of footings and as passive pressure on the sides of footings and the buried portion of the wall, as described in the "**Foundation Support**" section of this report.

#### Wall Drainage

Adequate drainage behind retaining structures is imperative. Positive drainage which controls the development of hydrostatic pressure can be accomplished by placing a zone of drainage behind the walls. Granular drainage material should contain less than 2 percent fines and at least 30 percent retained on the US No. 4 sieve.

A minimum 4 inch diameter perforated or slotted PVC pipe should be placed in the drainage zone along the base and behind the wall to provide an outlet for accumulated water and direct accumulated water to an appropriate discharge location. We recommend that a nonwoven geotextile filter fabric be placed between the soil drainage material and the remaining wall backfill to reduce silt migration into the drainage zone. The infiltration of silt into the drainage zone can, with time, reduce the permeability of the granular material. The filter fabric should be placed such that it fully separates the drainage material and the backfill, and should be extended over the top of the drainage zone.

A soil drainage zone should extend horizontally at least 18 inches from the back of the wall. The drainage zone should also extend from the base of the wall to within 1 foot of the top of the wall. The soil drainage zone should be compacted to approximately 90 percent of the maximum dry density (MDD), as determined in accordance with ASTM D: 1557. Over-compaction should be avoided as this can lead to excessive lateral pressures on the wall. A geocomposite drain mat may also be used instead of free draining soils, provided it is installed in accordance with the manufacturer's instructions.

### **Below Grade Vaults**

The proposed below grade vault should be designed to resist the static and dynamic lateral earth pressures presented in the **"Subgrade/Basement Walls"** section of this report. We recommend the proposed vault be completely waterproofed (exterior of foundation walls and underside of slab) to prevent water intrusion. The walls and floor slabs associated with these structures should be designed to resist the lateral and uplift forces associated with maximum estimated seasonal high groundwater levels. We recommend using a soil unit weight of 130 pcf to calculate vertical forces acting on the vault lid, base extensions, or anti-flotation slabs.

### **Temporary Excavations**

All job site safety issues and precautions are the responsibility of the contractor providing services/work. The following cut/fill slope guidelines are provided for planning purposes only. Temporary cut slopes will likely be necessary during grading operations or utility installation. All excavations at the site associated with confined spaces, such as utility trenches and retaining walls, must be completed in accordance with local, state, or federal requirements including Washington Administrative Code (WAC) and Washington Industrial Safety and Health Administration (WISHA). Excavation, trenching, and shoring is covered under WAC 296-155 Part N.

Based on WAC 296-155-66401, it is our opinion that the glaciolacustrine recessional outwash soils on the site would be classified as Type C soils, while the underlying glacial till would be classified as Type A soils. For temporary excavations of less than 20 feet in depth, the side slopes in Type C soils should be sloped at a maximum inclination of 1½ H:1V or flatter from the toe to top of the slope; while side slopes in Type A soils should be sloped at a maximum inclination of ¾H:1V or flatter from the toe to top of the slope. All exposed slope faces should be covered with a durable reinforced plastic membrane during construction to prevent slope raveling and rutting during periods of precipitation. These guidelines assume that all surface loads are kept at a minimum distance of at least one half the depth of the cut away from the top of the slope and that significant seepage is not present on the slope face. Flatter cut slopes will be necessary where significant raveling or seepage occurs, if construction materials will be stockpiled along the slope crest, or if construction traffic will be routed along the slope crest.

Where it is not feasible to slope the site soils back at these inclinations, shoring will be required. All shoring for the project should incorporate applicable criteria presented in the **"Subgrade/Basement Walls"** section of this report into the design. Settlement of the ground surface can occur behind shoring during excavation. The amount of settlement depends heavily on the type of shoring system, the contractor's workmanship, and soil conditions. Accordingly, we recommend that structures in the vicinity of the planned shoring installation be reviewed with regard to foundation support and tolerance to settlement.

This information is provided solely for the benefit of the owner and other design consultants, and should not be construed to imply that GeoResources, LLC assumes responsibility for job site safety. It is understood that job site safety is the sole responsibility of the project contractor..

### **Permanent Cut and Fill Slopes**

We do not anticipate that permanent cut and fill slopes will be utilized for this project. However, if cut and fill slopes are required, we recommend a maximum slope of 2H:1V (Horizontal:Vertical) for permanent cut and fill slopes. Where 2H:1V slopes are not feasible, retaining structures should be considered. Where retaining structures are greater than 4 feet in height (bottom of footing to top of structure) or have slopes of greater than 15 percent above them, they should be designed by a qualified engineer.

Fill slopes constructed on grades that are steeper than 5H:1V (20 percent) should be "keyed" into the undisturbed native soils by cutting a series of horizontal benches and should be constructed in accordance with Appendix J of the 2018 IBC. The benches should be 1½ times the width of the equipment used for grading and be a maximum of 3 feet in height. Subsurface drainage may be required in areas where significant seepage is encountered during grading. Collected drainage should be directed to an appropriate discharge point.

### **Site Drainage**

All ground surfaces, pavements and sidewalks at the site should be sloped to direct surface water away from the structures and property lines. Surface water runoff should be controlled by a system of curbs, berms, drainage swales, and or catch basins, and conveyed to an appropriate discharge point.

We recommend that footing drains are installed for the residence in accordance with IBC 1805.4.2, and basement walls (if utilized) have a wall drain as describe above. The roof drain should not be connected to the footing drain.

### **Stormwater Infiltration**

In the following sections we provide an opinion regarding the feasibility of infiltration, and construction considerations.

#### *Infiltration Feasibility*

Based on our observations, laboratory testing, in-situ infiltration testing, and experience, it is our opinion that the soils at the site will not support on-site infiltration. On December 22, 2021, we completed a small-scale pilot infiltration test (PIT) in the lower, western portion of the site in accordance with method outlined by the current Stormwater Management Manual for Western Washington. The results of our PIT indicated the saturated hydraulic conductivity of the soils was less than 0.1 inches per hour, below the infeasibility threshold for infiltration facilities. Accordingly, we recommend that alternative stormwater management methods are used.

#### *Construction Considerations*

To reduce potential clogging of stormwater facilities, they should not be connected to the stormwater runoff system until after construction is complete and the site area is landscaped, paved or otherwise protected. Additional measures may also be taken during construction to minimize the potential of fines contamination of the proposed stormwater facility, such as utilizing an alternative

storm water management location during construction. All contractors working on the site (builders and subcontractors) should divert sediment laden stormwater away from proposed infiltration facilities during construction and landscaping activities. No concrete trucks should be washed or cleaned, and washout areas should not be within the vicinity of the proposed infiltration facilities. After construction activities have been completed, periodic sweeping of the paved areas will help extend the life of the stormwater facility.

### **Pavement Section Design**

We understand that several pavement sections may be used for the onsite portion of the development, including hot mix asphalt (HMA) pavement sections in the passenger car parking stalls, passenger car drive lanes, and either HMA or Portland cement concrete (PCC) pavement in emergency vehicle or truck areas.

#### Pavement Subgrades

Pavement subgrade areas should be prepared by removing any soft or deleterious material down to firm and unyielding soils in accordance with the “**Site Preparation**” section of this report. The prepared subgrade should be evaluated by proof-rolling with a fully-loaded dump truck or equivalent point load equipment. Soft, loose, or wet areas that are identified should be recompacted or removed, as appropriate. Over-excavated areas should be backfilled with compacted structural fill. Where fill is placed, the upper 2 feet of roadway subgrade should have a maximum dry density of at least 95 percent, as determined in accordance with the ASTM D: 1557.

#### Pavement Sections

Pavement section thicknesses should conform to appropriate minimum sections provided in the most current City of Puyallup *Public Works Engineering & Construction Standards*, Section 100 for roadway design.

#### Pavement Frost Conditions

Frost-susceptible soil is generally regarded as having greater than 3 percent finer than 0.02 millimeter (mm). Soil with a fines content not exceeding 7 percent passing the No. 200 sieve, based on the minus ¾-inch fraction, can normally be expected to have 3 percent or less finer than 0.02 mm. Based on the soils observed during our construction monitoring, most of the near-surface soils could be considered frost-susceptible. Based on information provided in the WSDOT Pavement Policy, we recommend assuming the frost depth would be about 18 inches. For both rigid and flexible pavements, WSDOT recommends that the total depth of the pavement section be at least 50 percent of the frost depth.

#### Pavement Materials and Construction

In general, the aggregate base course, HMA, and PCC should be constructed in accordance with the most current City of Puyallup *Public Works Engineering & Construction Standards*, Section 100 for roadway design. Where not covered by Section 100, we recommend defaulting to WSDOT Standard Specifications for Road, Bridge, and Municipal Construction (WSDOT Standard Specifications, 2016). HMA should conform to Section 5-04 in the WSDOT Standard Specifications and the PCC should conform to Section 5-05 of the WSDOT Standard Specifications. We recommend that crushed rock used as CSBC in pavement sections consist of material of approximately the same quality as “crushed

surfacing (base course)" (or better) described in Section 9-03.9(3) of the WSDOT Standard Specifications. We further recommend that CSBC material be compacted to at least 95 percent of the MDD based on the modified Proctor procedure (ASTM D;1577).

## EARTHWORK RECOMMENDATIONS

### Site Preparation

All structural areas on the site to be graded should be stripped of vegetation, organic surface soils, and other deleterious materials including existing structures, foundations or abandoned utility lines. Organic topsoil is not suitable for use as structural fill, but may be used for limited depths in non-structural areas. Stripping depths ranging from 4 to 12 inches should be expected to remove these unsuitable soils. Areas of thicker topsoil or organic debris may be encountered in areas of heavy vegetation or depressions.

Where placement of fill material is required, the stripped/exposed subgrade areas should be compacted to a firm and unyielding surface prior to placement of any fill. Excavations for debris removal should be backfilled with structural fill compacted to the densities described in the "**Structural Fill**" section of this report.

We recommend that a member of our staff evaluate the exposed subgrade conditions after removal of vegetation and topsoil stripping is completed and prior to placement of structural fill. The exposed subgrade soil should be proof-rolled with heavy rubber-tired equipment during dry weather or probed with a 1/2-inch-diameter steel rod during wet weather conditions.

Soft, loose, or otherwise unsuitable areas delineated during proofrolling or probing should be recompacted, if practical, or over-excavated and replaced with structural fill. The depth and extent of overexcavation should be evaluated by our field representative at the time of construction. The areas of old fill material should be evaluated during grading operations to determine if they need mitigation; recompaction or removal.

### Structural Fill

All material placed as fill associated with mass grading, as utility trench backfill, under building areas, or under roadways should be placed as structural fill. The structural fill should be placed in horizontal lifts of appropriate thickness to allow adequate and uniform compaction of each lift. Structural fill should be compacted to at least 95 percent of MDD (maximum dry density as determined in accordance with ASTM D: 1557).

The appropriate lift thickness will depend on the structural fill characteristics and compaction equipment used. We recommend that the appropriate lift thickness be evaluated by our field representative during construction. We recommend that our representative be present during site grading activities to observe the work and perform field density tests.

The suitability of material for use as structural fill will depend on the gradation and moisture content of the soil. As the amount of fines (material passing US No. 200 sieve) increases, soil becomes increasingly sensitive to small changes in moisture content and adequate compaction becomes more difficult to achieve. During wet weather, we recommend use of well-graded sand and gravel with less than 5 percent (by weight) passing the US No. 200 sieve based on that fraction passing the 3/4-inch sieve, such as *Gravel Backfill for Walls* (WSDOT 9-03.12(2)). If prolonged dry weather prevails during

the earthwork and foundation installation phase of construction, higher fines content (up to 10 to 12 percent) may be acceptable.

Material placed for structural fill should be free of debris, organic matter, trash and cobbles greater than 6-inches in diameter. The moisture content of the fill material should be adjusted as necessary for proper compaction.

### **Suitability of On-Site Materials as Fill**

During dry weather construction, the non-organic, granular on-site soil may be considered for use as structural fill; provided it meets the criteria described above in the “**Structural Fill**” section and can be compacted as recommended. If the soil material is over-optimum in moisture content when excavated, it will be necessary to aerate or dry the soil prior to placement as structural fill. We generally did not observe the site soils to be excessively moist at the time of our subsurface exploration program.

The uncontrold fill encountered at shallow depths consist of a mixture of sand, silt, and gravel with debris. We do not anticipate that these soils will be suitable for use as structural fill because of their fines content and the presence of debris. The deeper glacial till is generally comparable to “common borrow” material and will be suitable for use as structural fill provided the moisture content is maintained within 2 percent of the optimum moisture level.

We recommend that completed graded-areas be restricted from traffic or protected prior to wet weather conditions. The graded areas may be protected by paving, placing asphalt-treated base, a layer of free-draining material such as pit run sand and gravel or clean crushed rock material containing less than 5 percent fines, or some combination of the above.

### **Erosion Control**

Weathering, erosion and the resulting surficial sloughing and shallow land sliding are natural processes. As noted, no evidence of surficial raveling or sloughing was observed at the site. To manage and reduce the potential for these natural processes, we recommend erosion protection measures will need to be in place prior to grading activity on the site. Erosion hazards can be mitigated by applying Best Management Practices (BMP’s) outlined in the current *Stormware Management Manual for Western Washington*. These may include, but are not limited to silt fence per BMP C233, straw wattles per BMP C235, temporary and permanent seeding per BMP C120, and mulch per BMP C121.

### **Wet Weather and Wet Condition Considerations**

In the Puget Sound area, wet weather generally begins about mid-October and continues through about May, although rainy periods could occur at any time of year. Therefore, it is strongly encouraged that earthwork be scheduled during the dry weather months of June through September. Most of the soil at the site contains sufficient fines to produce an unstable mixture when wet. Such soil is highly susceptible to changes in water content and tends to become unstable and impossible to proof-roll and compact if the moisture content exceeds the optimum.

In addition, during wet weather months, the groundwater levels could increase, resulting in seepage into site excavations. Performing earthwork during dry weather would reduce these problems and costs associated with rainwater, construction traffic, and handling of wet soil. However, should wet weather/wet condition earthwork be unavoidable, the following recommendations are provided:

- The ground surface in and surrounding the construction area should be sloped as much as possible to promote runoff of precipitation away from work areas and to prevent ponding of water.
- Work areas or slopes should be covered with plastic when not being worked. The use of sloping, ditching, sumps, dewatering, and other measures should be employed as necessary to permit proper completion of the work.
- Earthwork should be accomplished in small sections to minimize exposure to wet conditions. That is, each section should be small enough so that the removal of unsuitable soils and placement and compaction of clean structural fill could be accomplished on the same day. The size of construction equipment may have to be limited to prevent soil disturbance. It may be necessary to excavate soils with a backhoe, or equivalent, and locate them so that equipment does not pass over the excavated area. Thus, subgrade disturbance caused by equipment traffic would be minimized.
- Fill material should consist of clean, well-graded, sand and gravel, of which not more than 5 percent fines by dry weight passes the No. 200 mesh sieve, based on wet-sieving the fraction passing the ¾-inch mesh sieve. The gravel content should range from between 20 and 50 percent retained on a No. 4 mesh sieve. The fines should be non-plastic.
- No exposed soil should be left uncompacted and exposed to moisture. A smooth-drum vibratory roller, or equivalent, should roll the surface to seal out as much water as possible.
- In-place soil or fill soil that becomes wet and unstable and/or too wet to suitably compact should be removed and replaced with clean, granular soil (see gradation requirements above).
- Excavation and placement of structural fill material should be observed on a full-time basis by a geotechnical engineer (or representative) experienced in wet weather/wet condition earthwork to determine that all work is being accomplished in accordance with the project specifications and our recommendations.
- Grading and earthwork should not be accomplished during periods of heavy, continuous rainfall.

We recommend that the above requirements for wet weather/wet condition earthwork be incorporated into the contract specifications.

## LIMITATIONS

We have prepared this report for use by Bradley Heights SS, LLC and other members of the design team, for use in the design of a portion of this project. The data used in preparing this report and this report should be provided to prospective contractors for their bidding or estimating purposes only. Our report, conclusions and interpretations are based on our subsurface explorations, data from others and limited site reconnaissance, and should not be construed as a warranty of the subsurface conditions.

Variations in subsurface conditions are possible between the explorations and may also occur with time. A contingency for unanticipated conditions should be included in the budget and schedule. Sufficient monitoring, testing and consultation should be provided by our firm during construction to confirm that the conditions encountered are consistent with those indicated by the explorations, to provide recommendations for design changes should the conditions revealed during

the work differ from those anticipated, and to evaluate whether earthwork and foundation installation activities comply with contract plans and specifications.

The scope of our services does not include services related to environmental remediation and construction safety precautions. Our recommendations are not intended to direct the contractor's methods, techniques, sequences or procedures, except as specifically described in our report for consideration in design.

If there are any changes in the loads, grades, locations, configurations or type of facilities to be constructed, the conclusions and recommendations presented in this report may not be fully applicable. If such changes are made, we should be given the opportunity to review our recommendations and provide written modifications or verifications, as appropriate.



We have appreciated the opportunity to be of service to you on this project. If you have any questions or comments, please do not hesitate to call at your earliest convenience.

Respectfully submitted,  
GeoResources, LLC

Tyler S. Slothower, EIT  
Staff Engineer

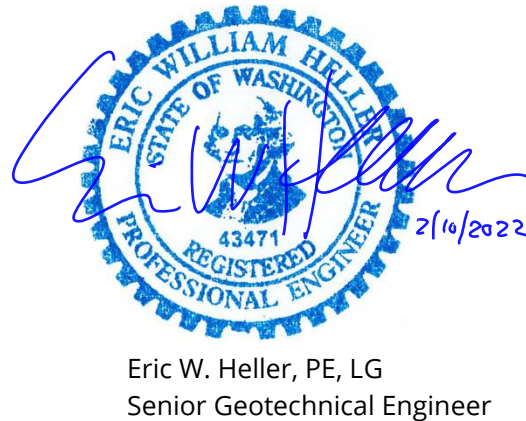
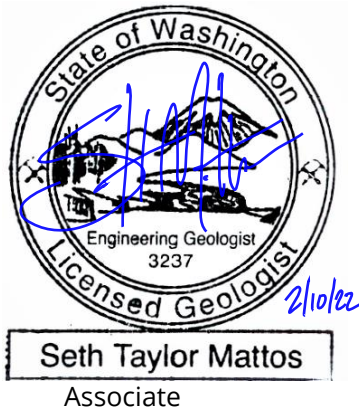

TSS:STM/EWH/tss

DocID: Timberlane.BradleyHeights.RG

Attachments: Figure 1: Site Location Map  
Figure 2: Site & Exploration Plan  
Figure 3: NRCS Soils Map  
Figure 4: Geologic Map  
Figure 5: Liquefaction Hazard Map  
Appendix "A" - Subsurface Explorations  
Appendix "B" - Laboratory Test results  
Appendix "C" - Groundwater Monitoring Data

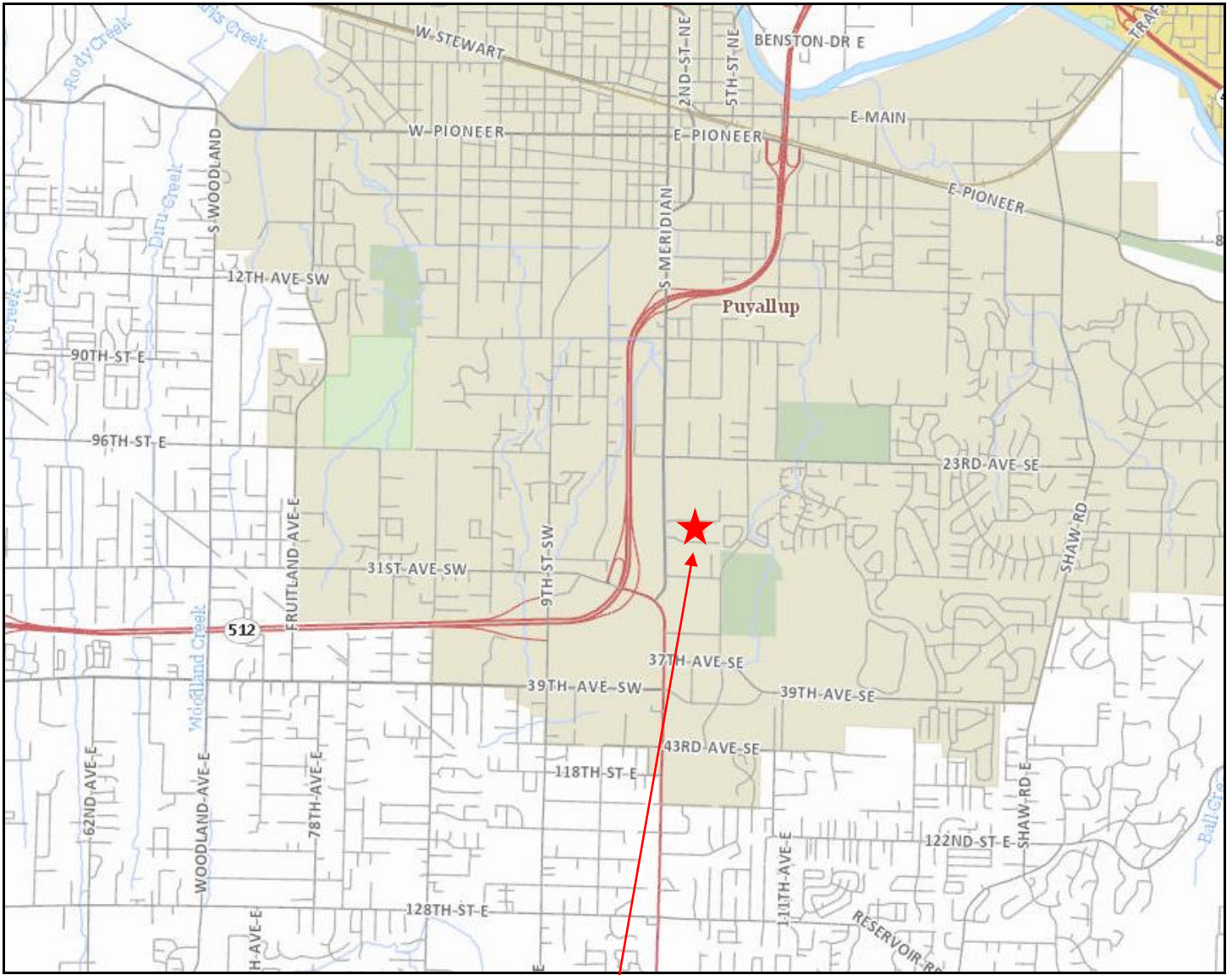

**Approximate Site Location**

Map created from Pierce County Public GIS (<https://matterhornwab.co.pierce.wa.us/publicgis/>)

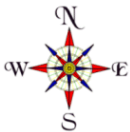

Not to Scale



**Site Location Map**  
 Proposed Multi-Family Development  
 202-27<sup>th</sup> Avenue SE  
 Pierce County, Washington  
 PN: 00419036006



DocID: Timberlane.BradleyHeights.F

February 2022

Figure 1



Conceptual site plan provided by Azure Green Consultants

-  Number and approximate location of borings (1/24/20)
-  Number and approximate location of test pits (excavated 3/21/2018 & 12/22/21)



**Site and Exploration Plan**  
 Proposed Multifamily Redevelopment  
 202 - 27<sup>th</sup> Ave SE  
 Puyallup, Washington

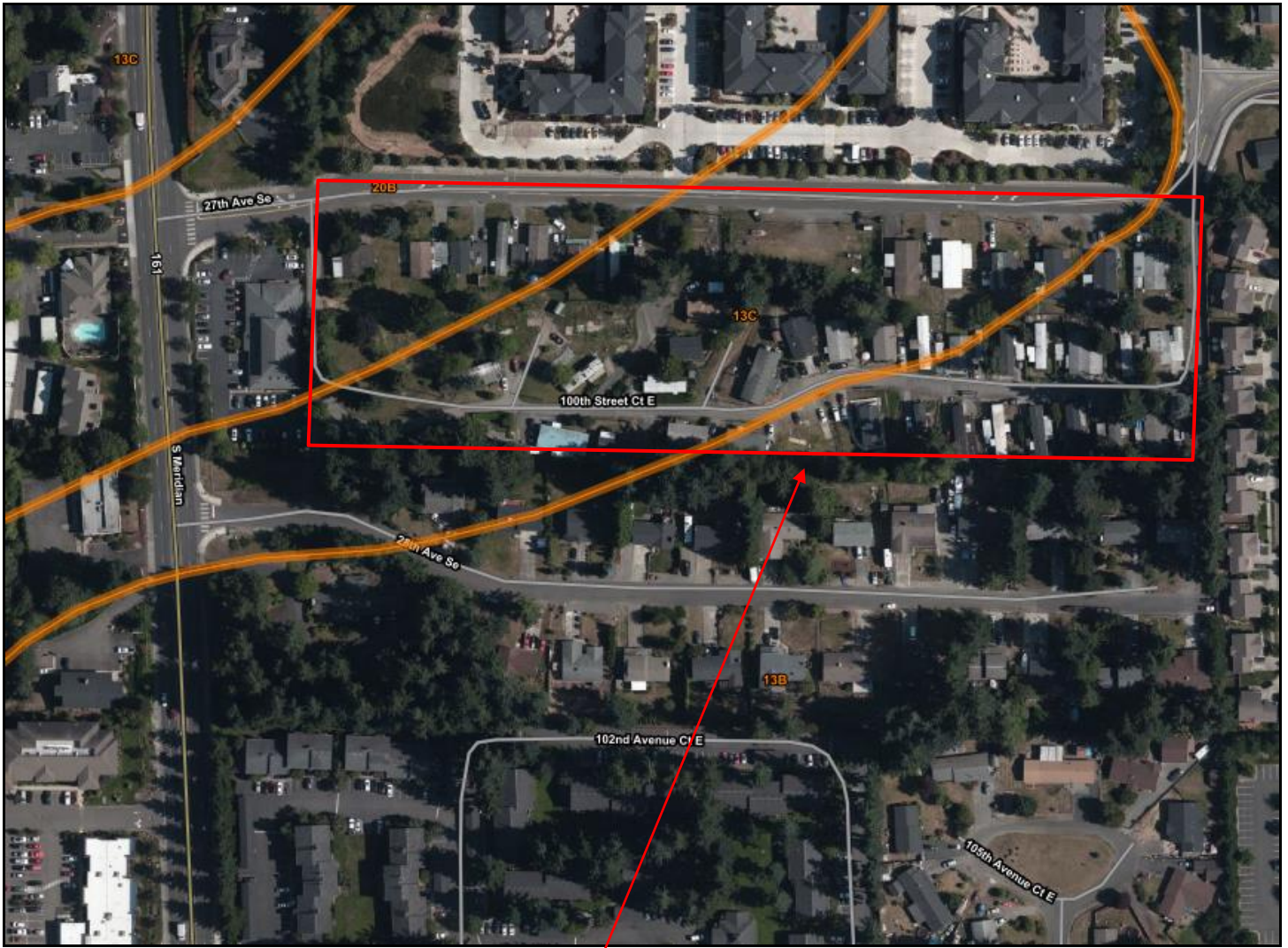

**Approximate Site Location**

Map created from Web Soil Survey (<http://websoilsurvey.sc.egov.usda.gov/App/WebSoilSurvey.aspx>)

| Soil Type | Soil Name                        | Parent Material                    | Slopes  | Erosion Hazard     | Hydrologic Soils Group |
|-----------|----------------------------------|------------------------------------|---------|--------------------|------------------------|
| 13B       | Everett very gravelly sandy loam | Sandy and gravelly glacial outwash | 0 to 8  | Slight             | A                      |
| 13C       |                                  |                                    | 8 to 15 | Moderate           |                        |
| 20B       | Kitsap silt loam                 | Glaciolacustrine deposits          | 2 to 8  | Slight to moderate | C/D                    |

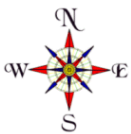

Not to Scale



**NRCS Soils Map**  
 Proposed Multi-Family Development  
 202-27<sup>th</sup> Avenue SE  
 Pierce County, Washington  
 PN: 00419036006

DocID: Timberlane.BradleyHeights.F

February 2022

Figure 3

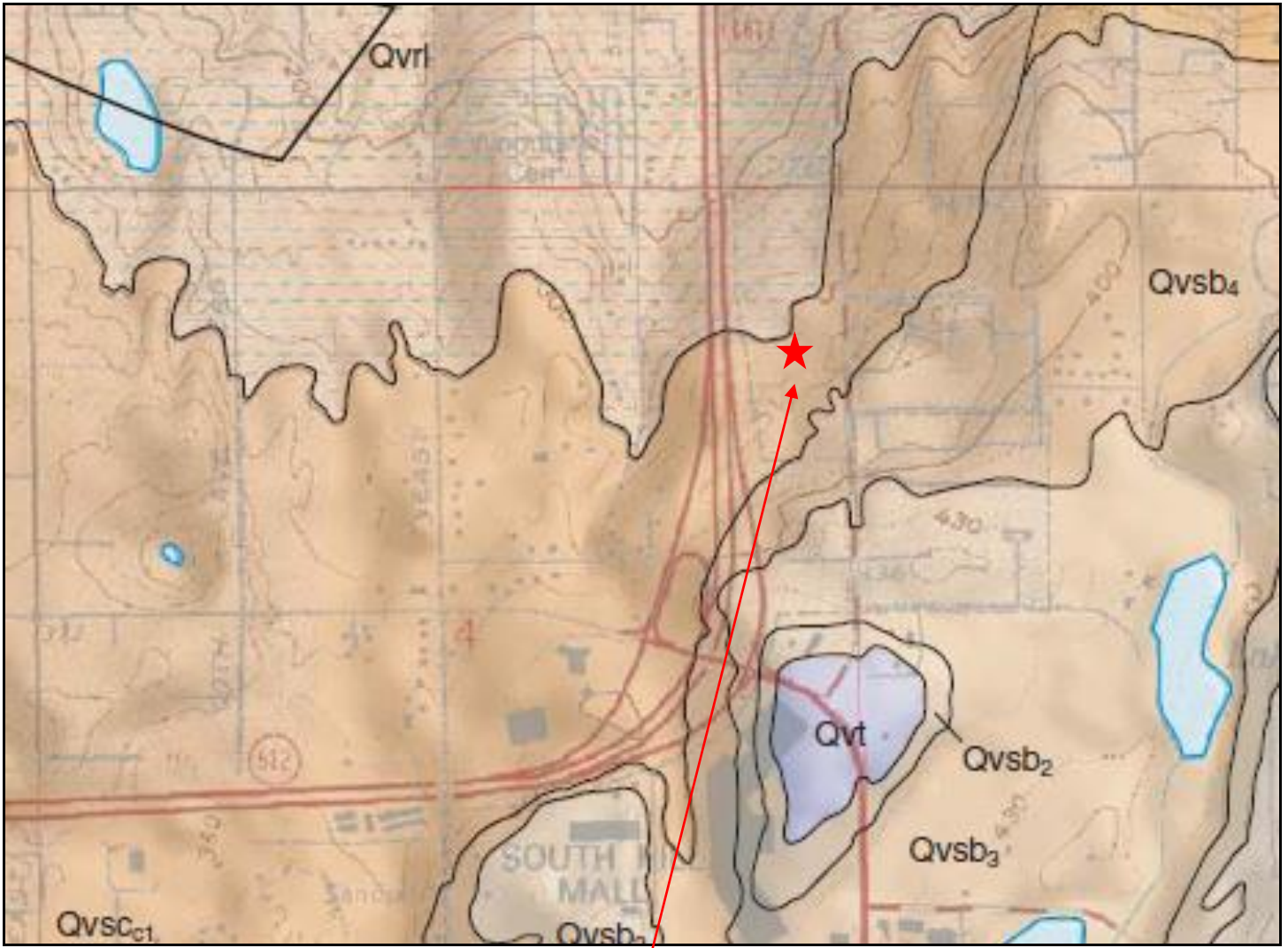

**Approximate Site Location**

An excerpt from the draft *Geologic Map of the Puyallup 7.5-minute Quadrangle, Washington*, by Troost, K.G.

|        |                                            |
|--------|--------------------------------------------|
| Qvrl   | Recessional Lacustrine Deposits            |
| QVSCc1 | Steilacoom gravel-Clover Creek Channel     |
| Qvrb4  | Vashon recessional outwash-Bradley Channel |

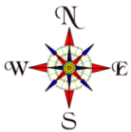

Not to Scale



4809 Pacific Hwy. E. | Fife, WA 98424 | 253.896.1011 | www.georesources.rocks

**Geologic Map**

Proposed Multi-Family Development  
 202-27<sup>th</sup> Avenue SE  
 Pierce County, Washington  
 PN: 00419036006

DocID: Timberlane.BradleyHeights.F

February 2022

Figure 4



**Approximate Site Location**

An excerpt from the *Liquefaction Susceptibility Map of Pierce County, Washington* by Palmer et Al. (2004)

- Liquefaction susceptibility: HIGH
- Liquefaction susceptibility: MODERATE to HIGH
- Liquefaction susceptibility: MODERATE
- Liquefaction susceptibility: LOW to MODERATE
- Liquefaction susceptibility: LOW
- Liquefaction susceptibility: VERY LOW to LOW
- Liquefaction susceptibility: VERY LOW
- Bedrock

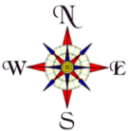

Not to Scale

**Geologic Map**  
 Proposed Multi-Family Development  
 202-27<sup>th</sup> Avenue SE  
 Pierce County, Washington  
 PN: 00419036006

DocID: Timberlane.BradleyHeights.F

February 2022

Figure 4

# **Appendix A**

## Subsurface Explorations

# SOIL CLASSIFICATION SYSTEM

| MAJOR DIVISIONS                                                            |                                                                        |                   | GROUP SYMBOL | GROUP NAME                                |      |
|----------------------------------------------------------------------------|------------------------------------------------------------------------|-------------------|--------------|-------------------------------------------|------|
| <b>COARSE GRAINED SOILS</b><br><br>More than 50% Retained on No. 200 Sieve | GRAVEL<br><br>More than 50% Of Coarse Fraction Retained on No. 4 Sieve | CLEAN GRAVEL      | GW           | WELL-GRADED GRAVEL, FINE TO COARSE GRAVEL |      |
|                                                                            |                                                                        |                   | GP           | POORLY-GRADED GRAVEL                      |      |
|                                                                            |                                                                        | GRAVEL WITH FINES | GM           | SILTY GRAVEL                              |      |
|                                                                            |                                                                        |                   | GC           | CLAYEY GRAVEL                             |      |
|                                                                            | SAND<br><br>More than 50% Of Coarse Fraction Passes No. 4 Sieve        | CLEAN SAND        | SW           | WELL-GRADED SAND, FINE TO COARSE SAND     |      |
|                                                                            |                                                                        |                   | SP           | POORLY-GRADED SAND                        |      |
|                                                                            |                                                                        | SAND WITH FINES   | SM           | SILTY SAND                                |      |
|                                                                            |                                                                        |                   | SC           | CLAYEY SAND                               |      |
| <b>FINE GRAINED SOILS</b><br><br>More than 50% Passes No. 200 Sieve        | SILT AND CLAY<br><br>Liquid Limit Less than 50                         | INORGANIC         | ML           | SILT                                      |      |
|                                                                            |                                                                        |                   | CL           | CLAY                                      |      |
|                                                                            |                                                                        | ORGANIC           | OL           | ORGANIC SILT, ORGANIC CLAY                |      |
|                                                                            | SILT AND CLAY<br><br>Liquid Limit 50 or more                           | INORGANIC         | MH           | SILT OF HIGH PLASTICITY, ELASTIC SILT     |      |
|                                                                            |                                                                        |                   | CH           | CLAY OF HIGH PLASTICITY, FAT CLAY         |      |
|                                                                            |                                                                        | ORGANIC           | OH           | ORGANIC CLAY, ORGANIC SILT                |      |
|                                                                            | HIGHLY ORGANIC SOILS                                                   |                   |              | PT                                        | PEAT |

**NOTES:**

1. Field classification is based on visual examination of soil in general accordance with ASTM D2488-90.
2. Soil classification using laboratory tests is based on ASTM D6913.
3. Description of soil density or consistency are based on interpretation of blow count data, visual appearance of soils, and or test data.

**SOIL MOISTURE MODIFIERS:**

- Dry- Absence of moisture, dry to the touch
- Moist- Damp, but no visible water
- Wet- Visible free water or saturated, usually soil is obtained from below water table



## Unified Soils Classification System

Proposed Multi-Family Development  
 202-27<sup>th</sup> Avenue SE  
 Pierce County, Washington  
 PN: 00419036006





# LOG OF BORING

MW-2

Proposed Multi-Family Development  
202 - 27th Avenue Southwest  
Puyallup, WA

1. Refer to log key for definition of symbols, abbreviations, and codes
2. USCS disination is based on visual manual classification and selected lab testing
3. Groundwater level, if indicated, is for the date shown and may vary
4. NE = Not Encountered
5. ATD = At Time of Drilling
6. HWM = Highest Groundwater Level

**Drilling Company:** \_\_\_\_\_ Holocene **Logged By:** \_\_\_\_\_ EJF  
**Drilling Method:** \_\_\_\_\_ HSA **Drilling Date:** \_\_\_\_\_ 01/24/2020  
**Drilling Rig:** \_\_\_\_\_ Track **Datum:** \_\_\_\_\_ NAVD 88  
**Sampler Type:** \_\_\_\_\_ Cathead? **Elevation:** \_\_\_\_\_ 400 feet  
**Hammer Type:** \_\_\_\_\_ **Termination Depth:** \_\_\_\_\_ 21  
**Hammer Weight:** \_\_\_\_\_ 140 lbs **Latitude:** \_\_\_\_\_  
**Longitude:** \_\_\_\_\_

**Notes:**

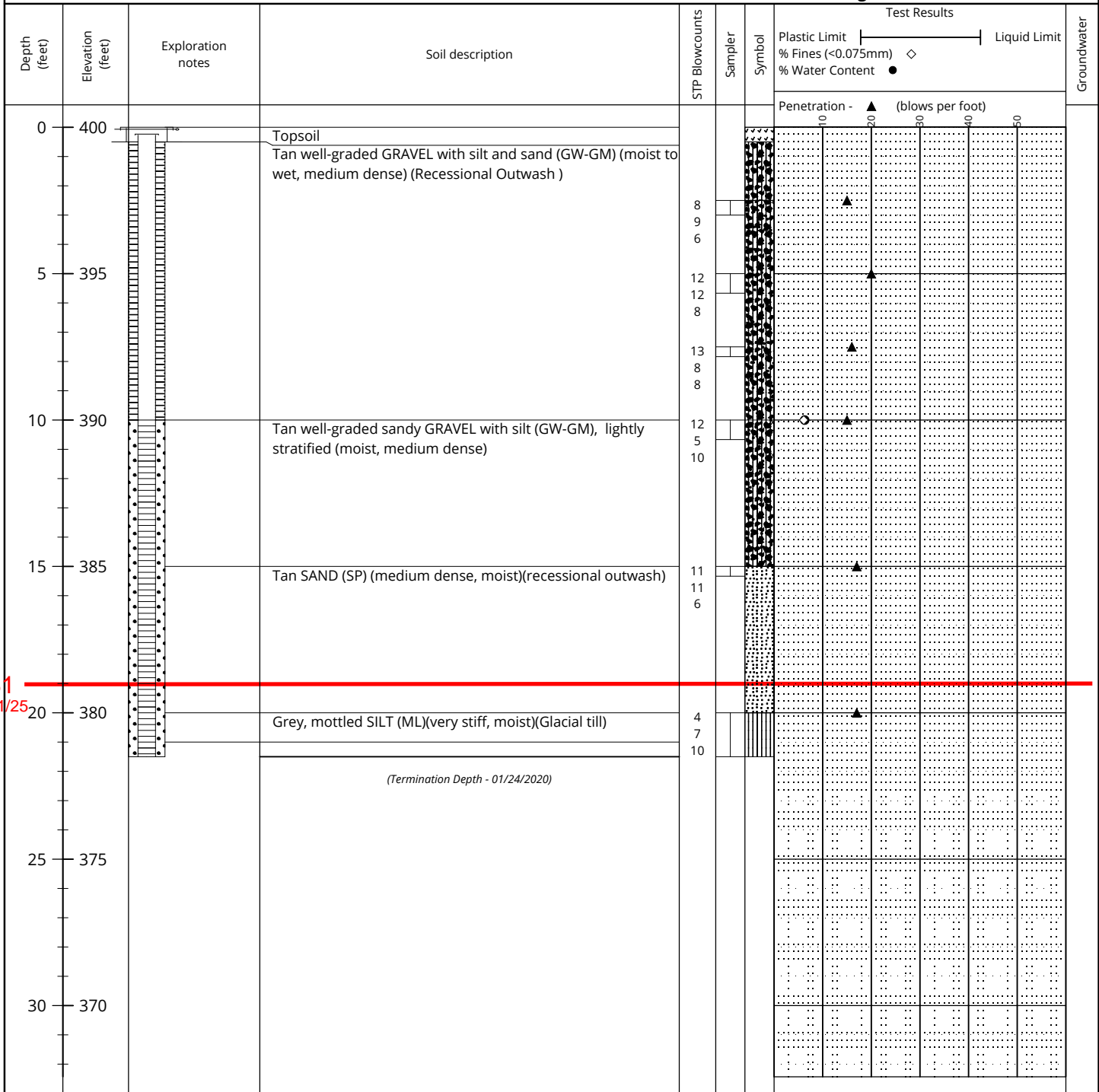

381  
4/11/25

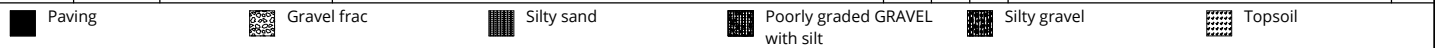

1. Refer to log key for definition of symbols, abbreviations, and codes
2. USCS disination is based on visual manual classification and selected lab testing
3. Groundwater level, if indicated, is for the date shown and may vary
4. NE = Not Encountered
5. ATD = At Time of Drilling
6. HWM = Highest Groundwater Level

**Drilling Company:** Holocene **Logged By:** EJF  
**Drilling Method:** HSA **Drilling Date:** 01/24/2020  
**Drilling Rig:** Track **Datum:** NAVD 88  
**Sampler Type:** Cathead? **Elevation:** 426 feet  
**Hammer Type:** \_\_\_\_\_ **Termination Depth:** 21  
**Hammer Weight:** 140 lbs **Latitude:** \_\_\_\_\_  
**Longitude:** \_\_\_\_\_

**Notes:**

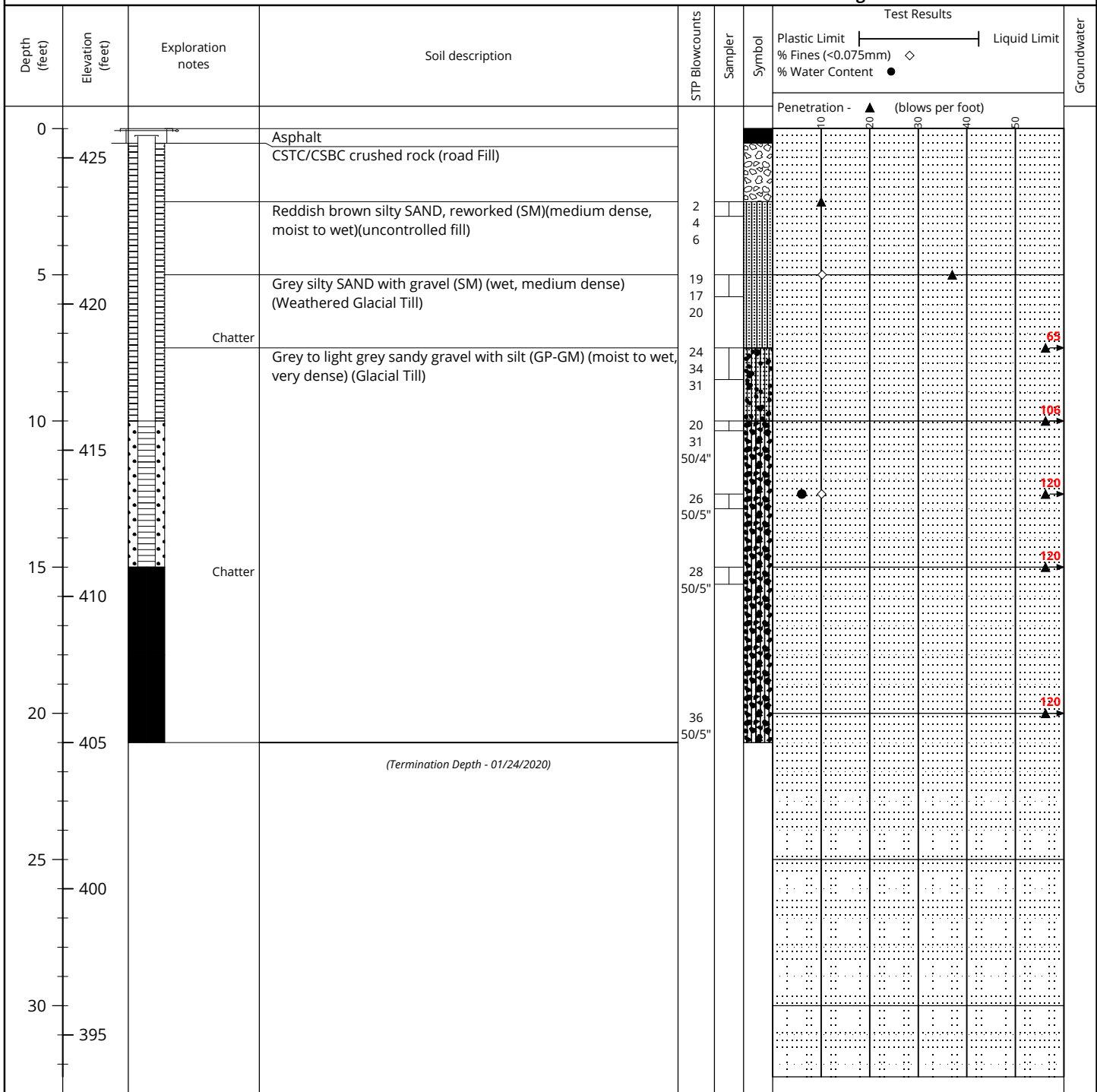

### Test Pit TP-101

Location: central-western portion of property

Approximate Elevation: 388 feet (NAVD 88)

| Depth (ft) | Soil Type | Soil Description                                            |
|------------|-----------|-------------------------------------------------------------|
| 0 - ¼      | -         | Topsoil                                                     |
| ¼ - 1½     | SM        | Brown silty sand (medium dense, moist) (weathered till)     |
| 1½ - 9½    | SM        | Grey silty sand (dense to very dense, moist) (glacial till) |

Terminated at 9½ feet below ground surface.

No caving was observed at time of excavation.

Mottling was observed at 1½ feet below ground surface.

### Test Pit TP-102/PIT-1

Location: Northwestern portion of property

Approximate Elevation: 378 feet (NAVD 88)

| Depth (ft) | Soil Type | Soil Description                                        |
|------------|-----------|---------------------------------------------------------|
| 0 - ¼      | -         | Topsoil                                                 |
| ¼ - 6½     | ML        | Tan to grey silt (medium stiff, moist) (weathered till) |

Terminated at 6½ feet below ground surface.

Caving observed from 2 to 6 feet below ground surface.

No mottling or groundwater seepage observed.

Small-scale PIT completed at 4 feet below ground surface.

Logged by: TSS

Excavated on: December 22, 2021



### Test Pit Logs

Proposed Multi-Family Development  
202-27<sup>th</sup> Avenue SE  
Pierce County, Washington  
PN: 00419036006

# **Appendix B**

## Laboratory Test Results

# Particle Size Distribution Report

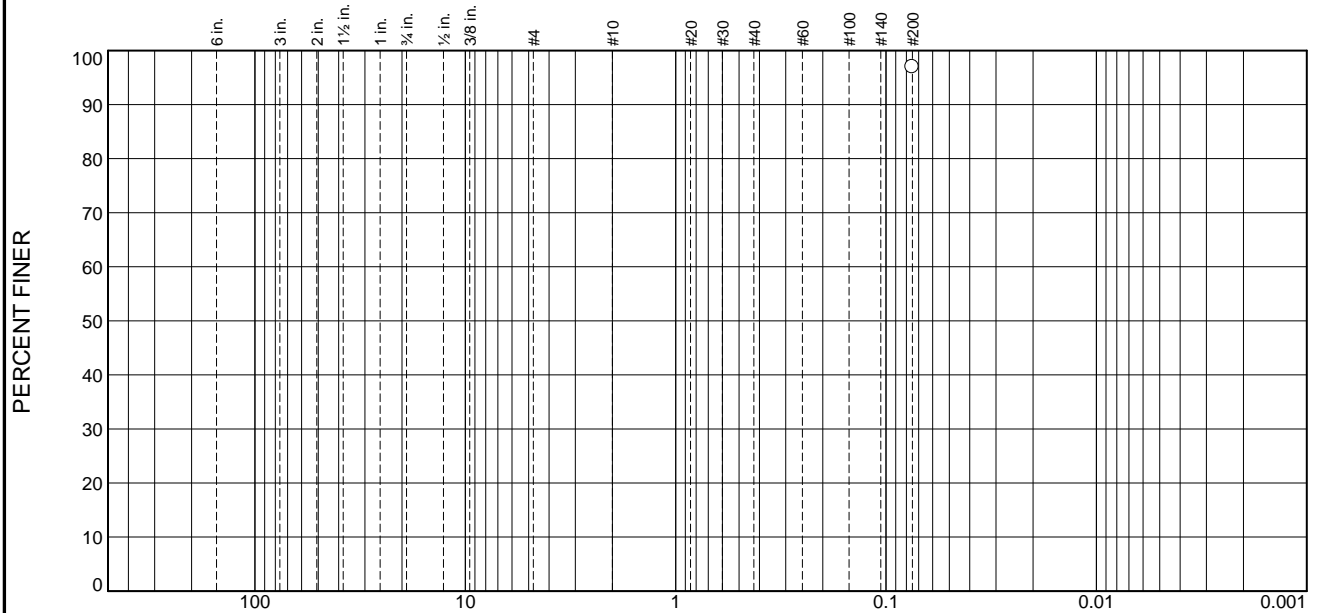

| % +3" | % Gravel |      | % Sand |        |      | % Fines |      |
|-------|----------|------|--------|--------|------|---------|------|
|       | Coarse   | Fine | Coarse | Medium | Fine | Silt    | Clay |
|       |          |      |        |        |      | 97.0    |      |

| Test Results (ASTM D 6913 & ASTM C 117) |               |                  |                |
|-----------------------------------------|---------------|------------------|----------------|
| Opening Size                            | Percent Finer | Spec.* (Percent) | Pass? (X=Fail) |
| #200                                    | 97.0          |                  |                |

\* (no specification provided)

**Material Description**

Tan, mottled, SILT (ML), laminated (wet, soft)

**Atterberg Limits (ASTM D 4318)**

PL= NP      LL= NV      PI= NP

**Classification**

USCS (D 2487)= ML      AASHTO (M 145)= A-2-4(0)

**Coefficients**

D<sub>90</sub>=      D<sub>85</sub>=      D<sub>60</sub>=  
D<sub>50</sub>=      D<sub>30</sub>=      D<sub>15</sub>=  
D<sub>10</sub>=      C<sub>u</sub>=      C<sub>c</sub>=

**Remarks**

Moisture = 37.8%

---

Date Received: 01/24/2020      Date Tested: 02/18/2020

Tested By: EJF \_\_\_\_\_

Checked By: \_\_\_\_\_

Title: \_\_\_\_\_

Source of Sample: MW-1      Depth: 10  
Sample Number: S-4

Date Sampled: 01/24/2020

|                                                        |                                                                                                                                                                                                            |
|--------------------------------------------------------|------------------------------------------------------------------------------------------------------------------------------------------------------------------------------------------------------------|
| <p><b>GeoResources, LLC</b></p> <p><b>Fife, WA</b></p> | <p><b>Client:</b> Bradley Heights SS, LLC</p> <p><b>Project:</b> Proposed Multi-Family Development</p> <p><b>Project No:</b> Timberlane.BradleyHts</p> <p style="text-align: right;"><b>Figure</b> B-3</p> |
|--------------------------------------------------------|------------------------------------------------------------------------------------------------------------------------------------------------------------------------------------------------------------|

These results are for the exclusive use of the client for whom they were obtained. They apply only to the samples tested and are not indicative of apparently identical samples.

Tested By: \_\_\_\_\_ Checked By: \_\_\_\_\_

# Particle Size Distribution Report

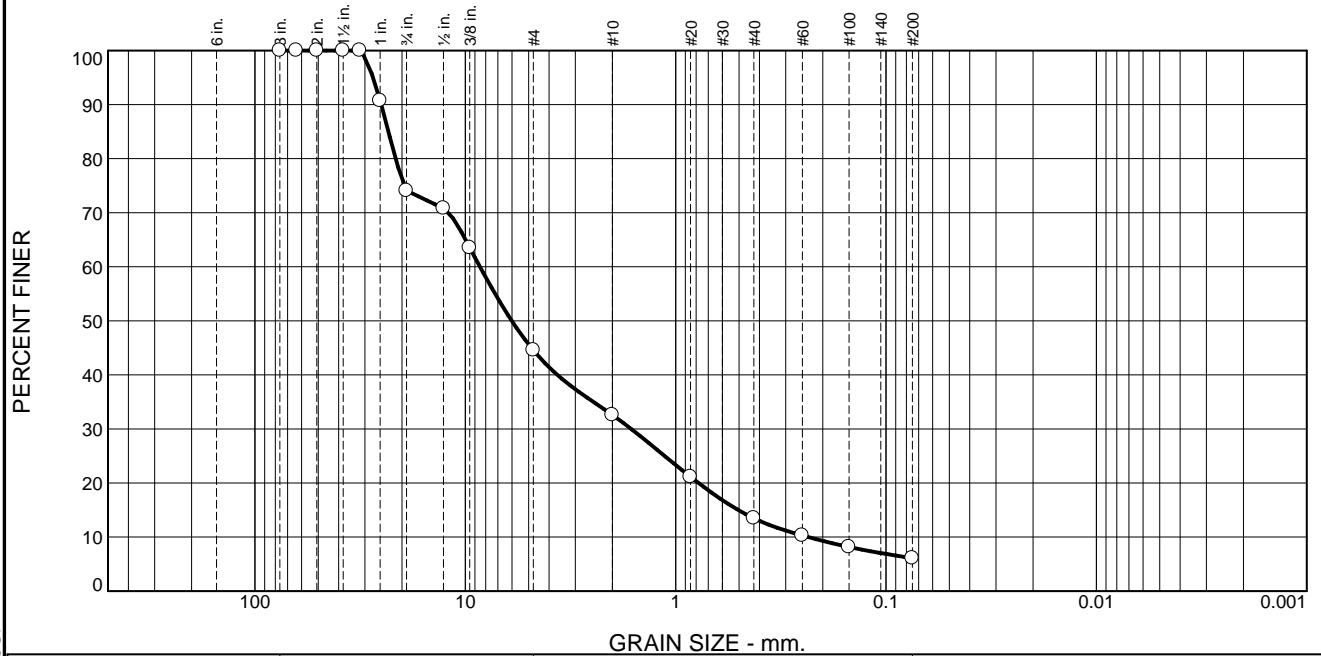

| % +3" | % Gravel |      | % Sand |        |      | % Fines |      |
|-------|----------|------|--------|--------|------|---------|------|
|       | Coarse   | Fine | Coarse | Medium | Fine | Silt    | Clay |
| 0.0   | 25.9     | 29.5 | 12.0   | 19.1   | 7.4  | 6.1     |      |

| Test Results (ASTM D 6913 & ASTM C 117) |               |                  |                |
|-----------------------------------------|---------------|------------------|----------------|
| Opening Size                            | Percent Finer | Spec.* (Percent) | Pass? (X=Fail) |
| 3.0                                     | 100.0         |                  |                |
| 2.5                                     | 100.0         |                  |                |
| 2.0                                     | 100.0         |                  |                |
| 1.5                                     | 100.0         |                  |                |
| 1.25                                    | 100.0         |                  |                |
| 1                                       | 90.7          |                  |                |
| .75                                     | 74.1          |                  |                |
| .5                                      | 70.8          |                  |                |
| 0.375                                   | 63.5          |                  |                |
| #4                                      | 44.6          |                  |                |
| #10                                     | 32.6          |                  |                |
| #20                                     | 21.1          |                  |                |
| #40                                     | 13.5          |                  |                |
| #60                                     | 10.3          |                  |                |
| #100                                    | 8.2           |                  |                |
| #200                                    | 6.1           |                  |                |

\* (no specification provided)

**Material Description**

Tan well-graded sandy gravel with silt (GW-GM), lightly stratified (wet, medium dense)

**Atterberg Limits (ASTM D 4318)**

PL= NP      LL=      PI=

**Classification**

USCS (D 2487)=      AASHTO (M 145)=

**Coefficients**

D<sub>90</sub>= 25.1048      D<sub>85</sub>= 23.2261      D<sub>60</sub>= 8.5264  
 D<sub>50</sub>= 6.0116      D<sub>30</sub>= 1.6294      D<sub>15</sub>= 0.5038  
 D<sub>10</sub>= 0.2347      C<sub>u</sub>= 36.33      C<sub>c</sub>= 1.33

**Remarks**

Moisture = 6.3%

---

Date Received: 01/24/2020      Date Tested: 02/19/2020

Tested By: EJF

Checked By: \_\_\_\_\_

Title: \_\_\_\_\_

Source of Sample: MW-2      Depth: 10      Date Sampled: 01/24/2020  
 Sample Number: S-4

|                                                 |                                                                                                                                                               |
|-------------------------------------------------|---------------------------------------------------------------------------------------------------------------------------------------------------------------|
| <b>GeoResources, LLC</b><br><br><b>Fife, WA</b> | <b>Client:</b> Bradley Heights SS, LLC<br><b>Project:</b> Proposed Multi-Family Development<br><br><b>Project No:</b> Timberlane.BradleyHts <b>Figure</b> B-2 |
|-------------------------------------------------|---------------------------------------------------------------------------------------------------------------------------------------------------------------|

These results are for the exclusive use of the client for whom they were obtained. They apply only to the samples tested and are not indicative of apparently identical samples.

Tested By: \_\_\_\_\_ Checked By: \_\_\_\_\_

# Particle Size Distribution Report

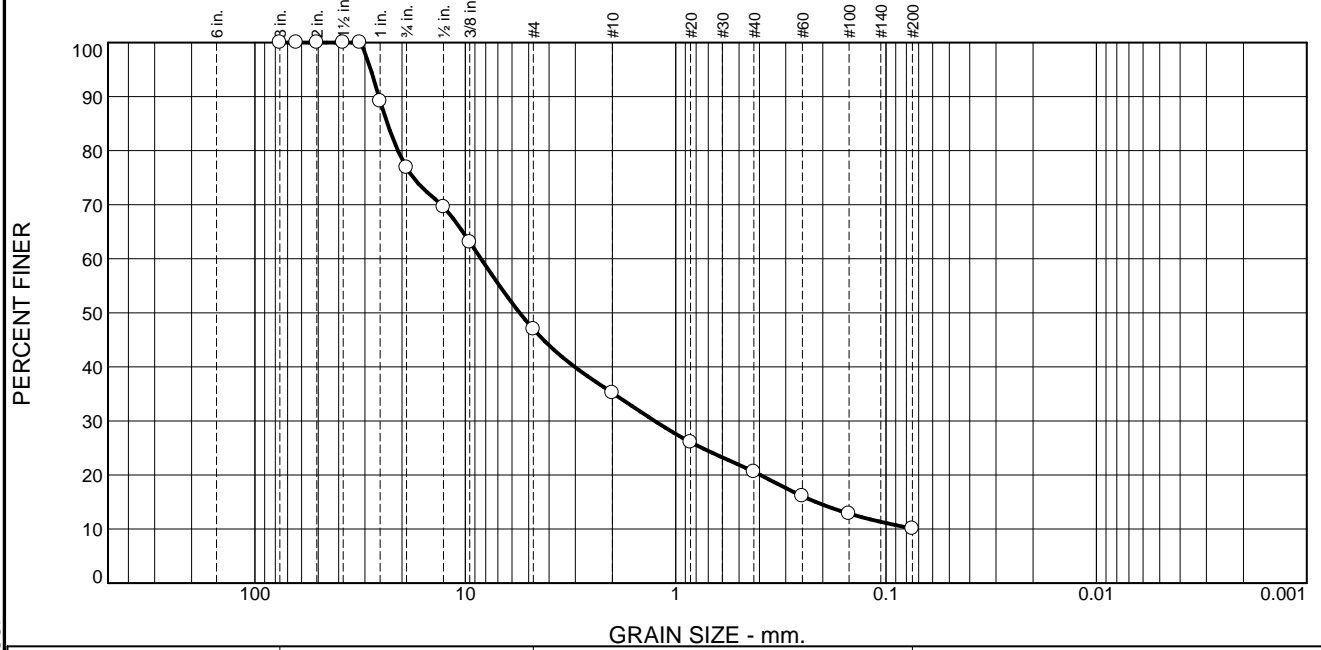

| % +3" | % Gravel |      | % Sand |        |      | % Fines |      |
|-------|----------|------|--------|--------|------|---------|------|
|       | Coarse   | Fine | Coarse | Medium | Fine | Silt    | Clay |
| 0.0   | 23.1     | 29.9 | 11.8   | 14.6   | 10.5 | 10.1    |      |

| Test Results (ASTM D 6913 & ASTM C 117) |               |                  |                |
|-----------------------------------------|---------------|------------------|----------------|
| Opening Size                            | Percent Finer | Spec.* (Percent) | Pass? (X=Fail) |
| 3.0                                     | 100.0         |                  |                |
| 2.5                                     | 100.0         |                  |                |
| 2.0                                     | 100.0         |                  |                |
| 1.5                                     | 100.0         |                  |                |
| 1.25                                    | 100.0         |                  |                |
| 1                                       | 89.2          |                  |                |
| .75                                     | 76.9          |                  |                |
| .5                                      | 69.6          |                  |                |
| 0.375                                   | 63.1          |                  |                |
| #4                                      | 47.0          |                  |                |
| #10                                     | 35.2          |                  |                |
| #20                                     | 26.1          |                  |                |
| #40                                     | 20.6          |                  |                |
| #60                                     | 16.1          |                  |                |
| #100                                    | 12.9          |                  |                |
| #200                                    | 10.1          |                  |                |

\* (no specification provided)

**Material Description**

Tan, poorly graded sandy gravel with silt (GP-GM) (moist to wet, dense)

**Atterberg Limits (ASTM D 4318)**

PL= NP      LL= NV      PI= NP

**Classification**

USCS (D 2487)= GP-GM      AASHTO (M 145)= A-1-a

**Coefficients**

D<sub>90</sub>= 25.7745      D<sub>85</sub>= 23.4789      D<sub>60</sub>= 8.4277  
D<sub>50</sub>= 5.5158      D<sub>30</sub>= 1.2593      D<sub>15</sub>= 0.2156  
D<sub>10</sub>=              C<sub>u</sub>=              C<sub>c</sub>=

**Remarks**

Moisture = 6.0%

---

Date Received: 01/24/2020      Date Tested: 02/18/2020

Tested By: EJF

Checked By: \_\_\_\_\_

Title: \_\_\_\_\_

Source of Sample: MW-3      Depth: 12.5      Date Sampled: 01/24/2020  
Sample Number: S-5

|                                                 |                                                                                                                                                               |
|-------------------------------------------------|---------------------------------------------------------------------------------------------------------------------------------------------------------------|
| <b>GeoResources, LLC</b><br><br><b>Fife, WA</b> | <b>Client:</b> Bradley Heights SS, LLC<br><b>Project:</b> Proposed Multi-Family Development<br><br><b>Project No:</b> Timberlane.BradleyHts <b>Figure</b> B-1 |
|-------------------------------------------------|---------------------------------------------------------------------------------------------------------------------------------------------------------------|

These results are for the exclusive use of the client for whom they were obtained. They apply only to the samples tested and are not indicative of apparently identical samples.

Tested By: \_\_\_\_\_ Checked By: \_\_\_\_\_

# **Appendix C**

## Groundwater Monitoring Data

Wet Season Groundwater Elevations, MW-1 (NAVD88)

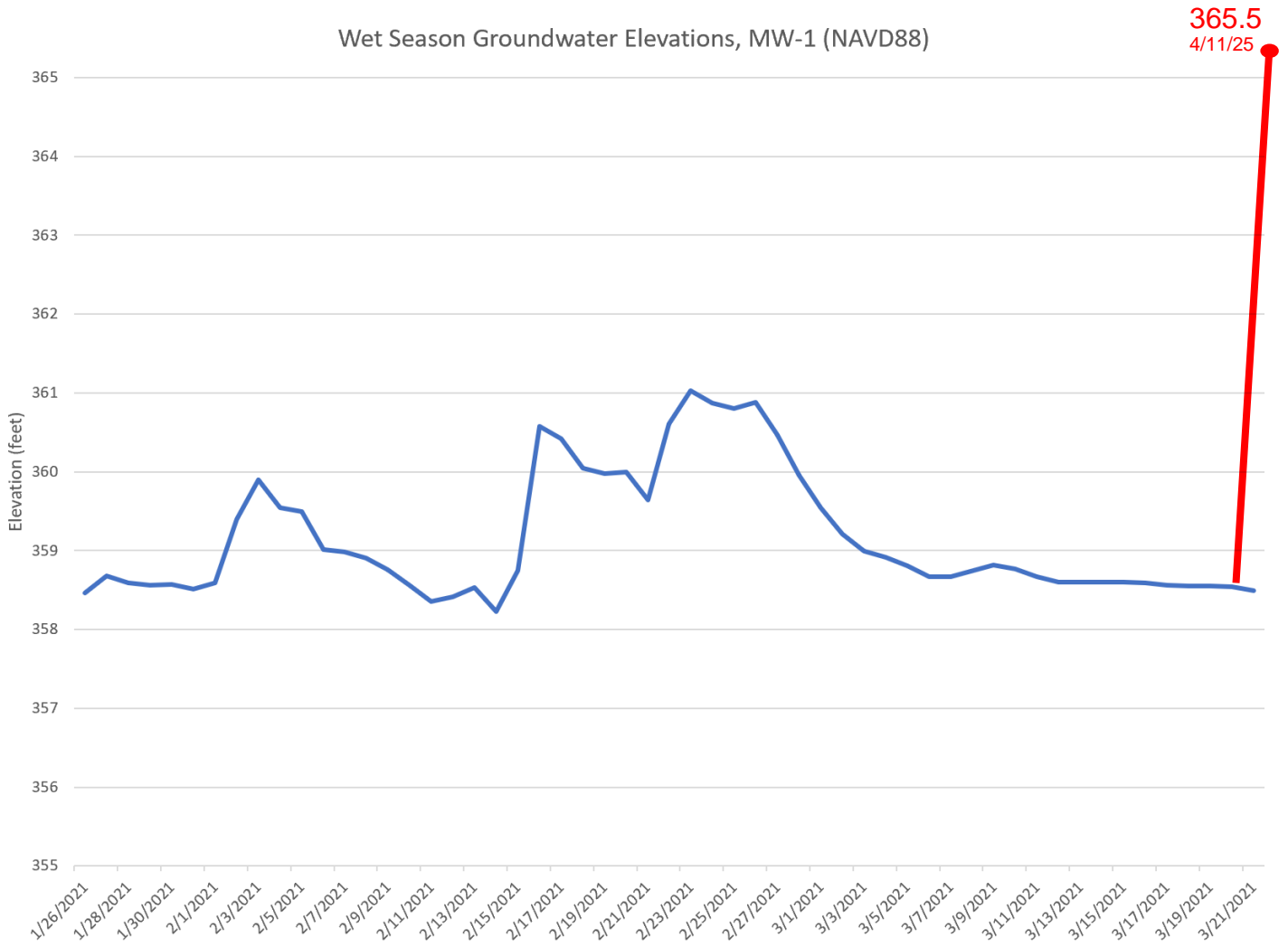

4809 Pacific Hwy. E. | Fife, WA 98424 | 253.896.1011 | www.georesources.rocks

**Seasonal Groundwater Levels**

Proposed Multi-Family Development

202-27<sup>th</sup> Avenue SE

Pierce County, Washington

PN: 00419036006

DocID: Timberlane.BradleyHeights.F

February 2022

Figure C-1

Wet Season Groundwater Elevations, MW-2 (NAVD88)

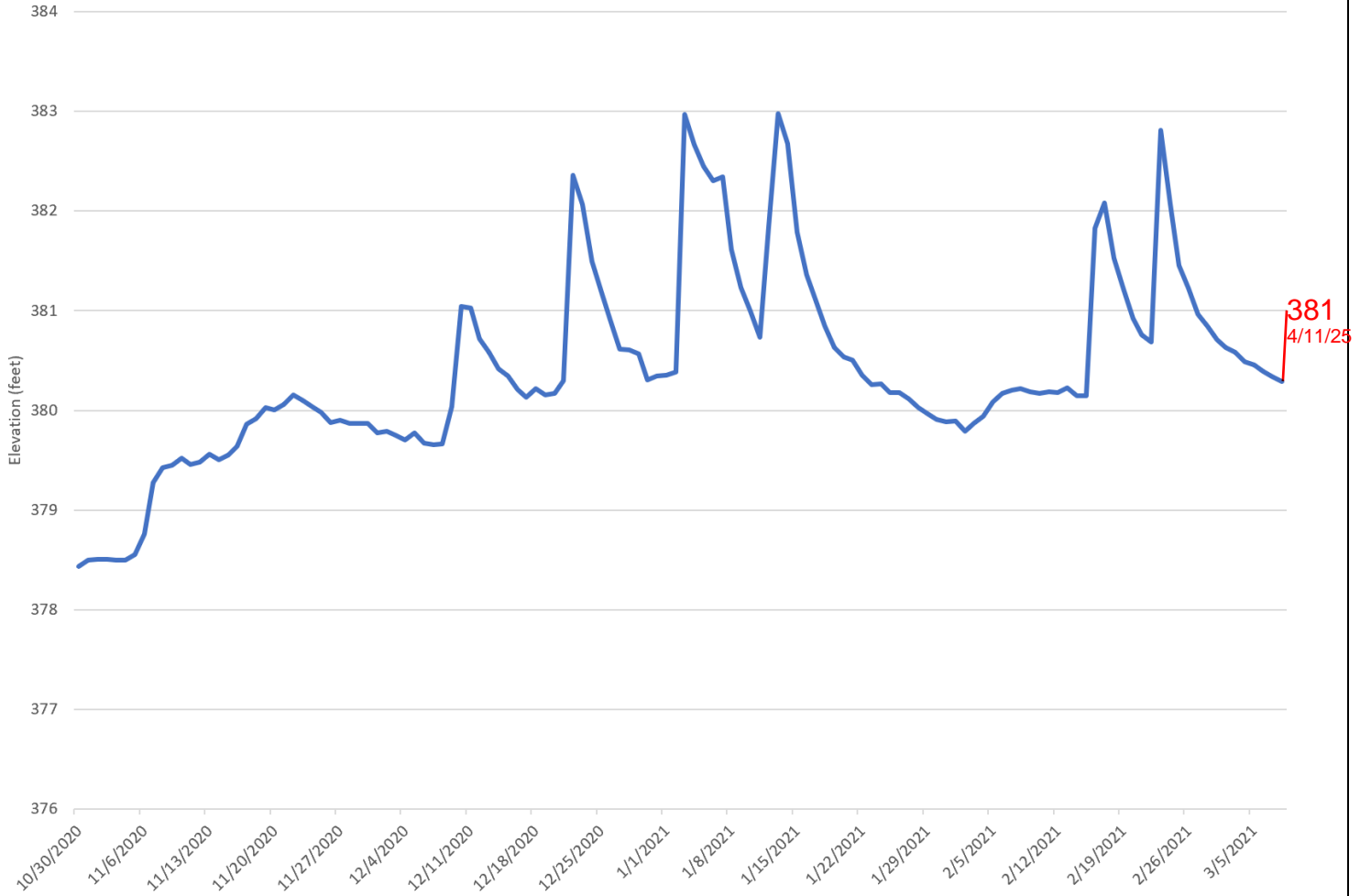

**Seasonal Groundwater Levels**

Proposed Multi-Family Development  
 202-27<sup>th</sup> Avenue SE  
 Pierce County, Washington  
 PN: 00419036006

# ASCE Hazards Report

**Address:**  
202 27th Ave SE  
Puyallup, Washington  
98374

**Standard:** ASCE/SEI 7-16  
**Risk Category:** II  
**Soil Class:** C - Very Dense  
Soil and Soft Rock

**Latitude:** 47.165263  
**Longitude:** -122.289753  
**Elevation:** 404.78392266765206 ft  
(NAVD 88)

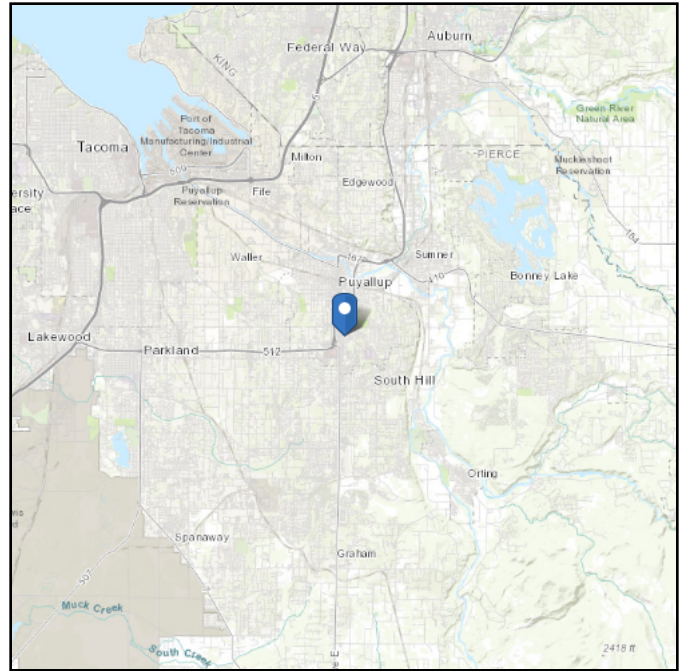
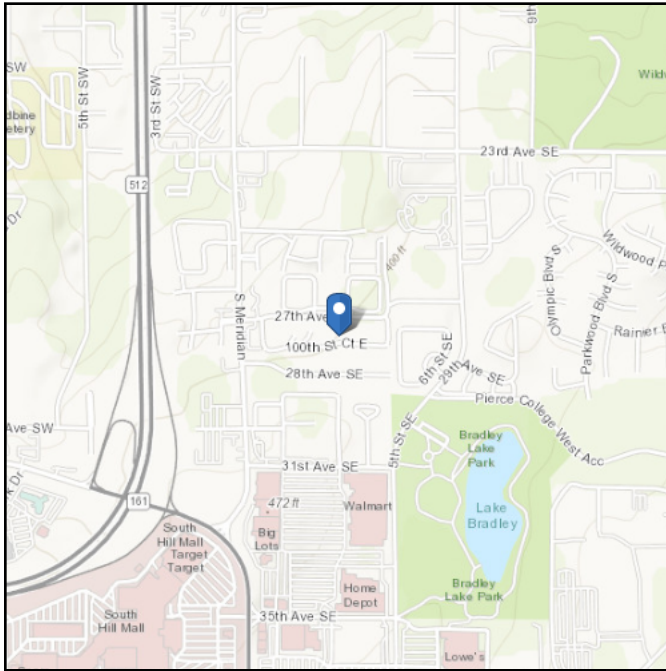

## Wind

### Results:

|              |         |                                                                                                                                                                 |
|--------------|---------|-----------------------------------------------------------------------------------------------------------------------------------------------------------------|
| Wind Speed   | 98 Vmph | <p style="color: red; font-weight: bold;">110 MPH PER<br/>PIERCE COUNTY</p>  |
| 10-year MRI  | 67 Vmph |                                                                                                                                                                 |
| 25-year MRI  | 73 Vmph |                                                                                                                                                                 |
| 50-year MRI  | 78 Vmph |                                                                                                                                                                 |
| 100-year MRI | 83 Vmph |                                                                                                                                                                 |

Data Source: ASCE/SEI 7-16, Fig. 26.5-1B and Figs. CC.2-1–CC.2-4, and Section 26.5.2

Date Accessed: Tue Feb 17 2026

Value provided is 3-second gust wind speeds at 33 ft above ground for Exposure C Category, based on linear interpolation between contours. Wind speeds are interpolated in accordance with the 7-16 Standard. Wind speeds correspond to approximately a 7% probability of exceedance in 50 years (annual exceedance probability = 0.00143, MRI = 700 years).

Site is not in a hurricane-prone region as defined in ASCE/SEI 7-16 Section 26.2.

**Site Soil Class:** C - Very Dense Soil and Soft Rock

**Results:**

|            |       |                    |       |
|------------|-------|--------------------|-------|
| $S_s$ :    | 1.263 | $S_{D1}$ :         | 0.435 |
| $S_1$ :    | 0.435 | $T_L$ :            | 6     |
| $F_a$ :    | 1.2   | PGA :              | 0.5   |
| $F_v$ :    | 1.5   | PGA <sub>M</sub> : | 0.6   |
| $S_{MS}$ : | 1.515 | $F_{PGA}$ :        | 1.2   |
| $S_{M1}$ : | 0.653 | $I_e$ :            | 1     |
| $S_{DS}$ : | 1.01  | $C_v$ :            | 1.153 |

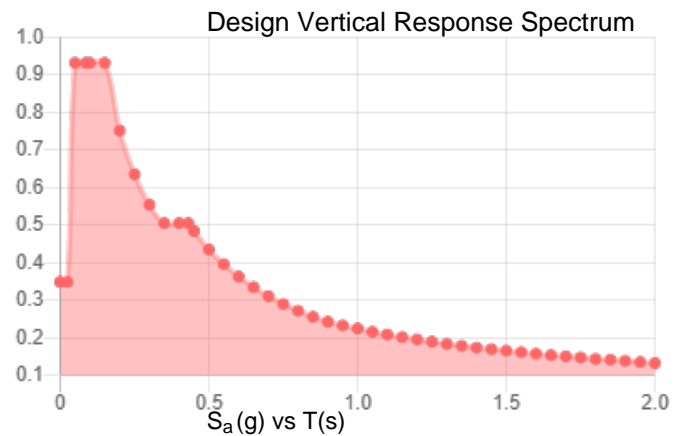
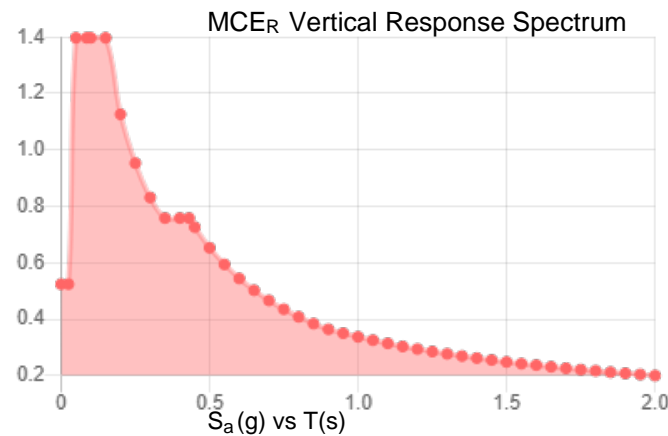
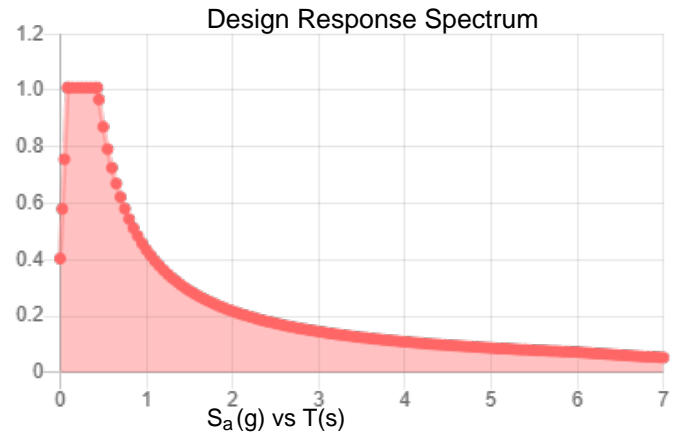
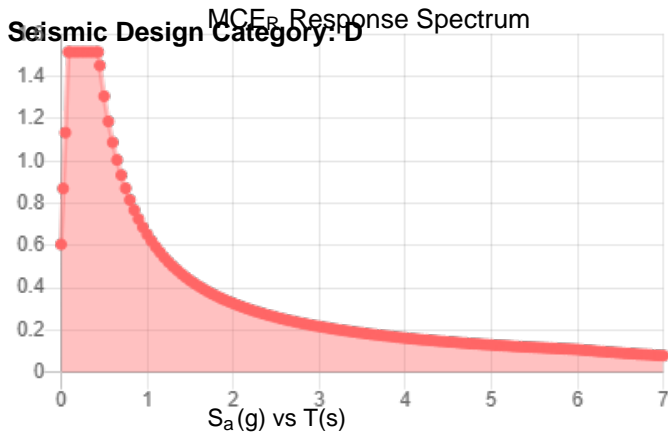

**Data Accessed:** Tue Feb 17 2026

**Date Source:**

USGS Seismic Design Maps based on ASCE/SEI 7-16 and ASCE/SEI 7-16 Table 1.5-2. Additional data for site-specific ground motion procedures in accordance with ASCE/SEI 7-16 Ch. 21 are available from USGS.

The ASCE Hazard Tool is provided for your convenience, for informational purposes only, and is provided “as is” and without warranties of any kind. The location data included herein has been obtained from information developed, produced, and maintained by third party providers; or has been extrapolated from maps incorporated in the ASCE standard. While ASCE has made every effort to use data obtained from reliable sources or methodologies, ASCE does not make any representations or warranties as to the accuracy, completeness, reliability, currency, or quality of any data provided herein. Any third-party links provided by this Tool should not be construed as an endorsement, affiliation, relationship, or sponsorship of such third-party content by or from ASCE.

ASCE does not intend, nor should anyone interpret, the results provided by this Tool to replace the sound judgment of a competent professional, having knowledge and experience in the appropriate field(s) of practice, nor to substitute for the standard of care required of such professionals in interpreting and applying the contents of this Tool or the ASCE standard.

In using this Tool, you expressly assume all risks associated with your use. Under no circumstances shall ASCE or its officers, directors, employees, members, affiliates, or agents be liable to you or any other person for any direct, indirect, special, incidental, or consequential damages arising from or related to your use of, or reliance on, the Tool or any information obtained therein. To the fullest extent permitted by law, you agree to release and hold harmless ASCE from any and all liability of any nature arising out of or resulting from any use of data provided by the ASCE Hazard Tool.

## Residential Design Criteria

For 2021 International Codes & [PCC 17C.20.170](#)

This bulletin establishes the design criteria used in designing buildings using the current International Residential Code (IRC).

It is the responsibility of the property owner to verify all design criteria for their specific site.

| Ground Snow Load | Wind Design |                     | Seismic Design Category | Subject to Damage From |                  |                    | Winter Design Temp | Ice Barrier UnderLayment Required | Flood Hazard    | Air Freezing Index | Mean Annual Temp |
|------------------|-------------|---------------------|-------------------------|------------------------|------------------|--------------------|--------------------|-----------------------------------|-----------------|--------------------|------------------|
|                  | Speed (mph) | Topographic Effects |                         | Weathering             | Frostline Depth  | Termite            |                    |                                   |                 |                    |                  |
| <b>See below</b> | 110 Mph Ult | No                  | <b>D1 / D2</b>          | Moderate               | <b>See below</b> | Slight to Moderate | 26                 | No                                | Ask Engineering | 50                 | 50               |

Table items above in **bold** vary depending on your location. Read below for more information.

### Ground Snow Loads

- All structural tables in the International Residential Code (IRC) have a minimum ground snow load of 30 pounds per square foot (psf). Projects designed to the IRC must be designed to a minimum of 30 psf.
- If plans are designed by engineer using the International Building Code (IBC) then a **minimum ground snow load of 25psf** may be used.
- Higher elevations (above 700 feet) may have a higher snow load.
- Ground snow loads greater than 70psf require structural calculations prepared by a WA state registered engineer (2021 IRC section R301.2.3).

### Wind Design Criteria

- **110 mph Ultimate** with a 3-second gust
- Exposure B (assumed unless the site meets the definition of another type)

**Exposure A:** Not used for residential construction.

**Exposure B:** Urban and suburban areas, wooded areas, or other terrain with numerous closely spaced obstructions having the size of single-family dwellings or larger.

**Exposure C:** Open terrain with scattered obstructions, including hills or other landscape features less than 30 feet extending more than 1,500 feet from the building site in any direction.

**Exposure D:** Flat, unobstructed areas exposed to wind flowing over open water for a horizontal distance of at least 5000 feet.

### Seismic Design Categories

The majority of Pierce County is Category D1. The area of Pierce County abutting Kitsap County (Gig Harbor area) is designated as D2 on the IRC map.

## Soil Site Class

All of Pierce County will be assumed to be soil **Site Class D**, unless a geotechnical evaluation is required from Development Engineering. In this case, the findings of the professional evaluation will set the soil site class and related seismic information. This report must be turned in with the building application.

## Soil Load-Bearing Values

Assume **1,500 pounds per square foot (PSF)** unless a soils report from a licensed geotechnical engineer is provided.

## Frost Depth

All low-land areas have a **frost depth of 12 inches below grade**. Higher elevations will have a deeper frost depth. Visit [PierceCountyWa.gov/AboutMyProperty](http://PierceCountyWa.gov/AboutMyProperty) or check with Building technical support for your specific project.

\*\*Site specific snow loads do not apply to your minimum required design criteria.

\*\*This website provides approximate information only and does not guarantee validity.