

Traffic Impact Analysis

PUYALLUP ARCO AM/PM

Prepared for:
ARCO

March 2023

Prepared by:



12131 113th Avenue NE, Suite 203
Kirkland, WA 98034-7120
Phone: 425-821-3665
www.transpogroup.com

1.22005.00

Table of Contents

Introduction	1
Project Description	1
Study Scope	1
Existing and Future Without-Project Conditions	4
Roadway Network	4
Transit Service	4
Traffic Volumes	5
Traffic Operations	8
Traffic Safety	9
Project Impacts	11
Trip Generation	11
Trip Distribution & Assignment	12
Traffic Volume Impact	14
Traffic Operations Impact	16
Site Access Evaluation	17
Mitigation	18
Findings and Recommendations	19

Appendix

Appendix A: Traffic Impact Analysis Scoping Worksheet
Appendix B: Traffic Counts
Appendix C: LOS Definitions
Appendix D: LOS Worksheets
Appendix E: Detailed Trip Generation
Appendix F: Loading Maneuvers
Appendix G: Sight Distance
Appendix H: Right Turn Lane Warrant Analysis

Figures

Figure 1. Site Vicinity and Study Intersections	2
Figure 2. Site Plan	3
Figure 3. Existing Weekday Peak Hour Traffic Volumes	6
Figure 4. Future (2024) Without-Project Weekday Peak Hour Traffic Volumes	7
Figure 5. Project Trip Distribution and Assignment	13
Figure 6. Future (2024) With-Project Weekday Peak Hour Traffic Volumes	15

Tables

Table 1. Roadway Network Existing Conditions Summary	4
Table 2. Existing Transit Service	5
Table 3. Existing and Future Without-Project Peak Hour LOS Summary	8
Table 4. Existing and Future Without-Project Peak Hour Queueing along S Meridian	9
Table 5. Five-Year Collision Summary (2017-2021)	10
Table 6. Estimated Net New Weekday Vehicle Trip Generation	12
Table 7. Traffic Volume Impacts at Study Intersections	14
Table 8. Future (2024) AM and PM Peak Hour LOS Summary	16
Table 9. Future (2024) AM and PM Peak Hour Queueing along S Meridian	16

Introduction

This traffic impact analysis (TIA) identifies potential transportation-related impacts associated with the construction of a fueling station and convenience market located at 1402 S Meridian in Puyallup. As necessary, mitigation measures are identified that would reduce or offset significant transportation related impacts that the project may have on the surrounding transportation system.

Project Description

The proposed project is located at 1402 S Meridian in Puyallup, WA. Figure 1 illustrates the site vicinity and surrounding streets. The proposed development would construct an 8 fuel pump (16 fueling position) gas station with a 3,675 square feet (sf) convenience market and supportive functions including a car wash and vacuuming stations. Additionally, the project would include 4 EV charging stations. Access to the site would be provided via the existing driveways to the east of the site along S Meridian (with the west leg restricted to right-in/right-out only) and south of the site along 15th Avenue SW. The preliminary site plan is included on Figure 2. The project is anticipated to be constructed and occupied by 2024. The existing 2,760 sf restaurant would be removed with the development of the project.

Study Scope

The scope of the analysis was coordinated with City staff through completion of the City of Puyallup Traffic Scoping Worksheet. The completed worksheet for the project is included in Appendix A. The study intersections identified to be impacted by 25 new project peak hours trips or more include:

1. S Meridian/SR 512 EB Ramps [*Evaluated in the PM peak hour only*]
2. S Meridian/14th Avenue S [*Evaluated in the PM peak hour only*]
3. S Meridian/Existing Driveway (Site Access)
4. S Meridian/15th Avenue SW
5. Existing Driveway (Site Access)/15th Avenue SW

The scope of the analysis included a review of existing and future without-project conditions in the vicinity of the project site under weekday PM peak hour conditions. In addition, the driveways and S Meridian/15th Avenue SW intersection is also evaluated during the weekday AM peak hour for the existing and future conditions. This report includes a review of the surrounding street system, transit service, non-motorized facilities, existing and future weekday peak hour traffic volumes, traffic operations, and traffic safety. Future (2024) with-project conditions were estimated by adding site-generated traffic to future without-project volumes. The project's impacts on the surrounding transportation system were identified by comparing the future with-project conditions to the future without-project conditions.

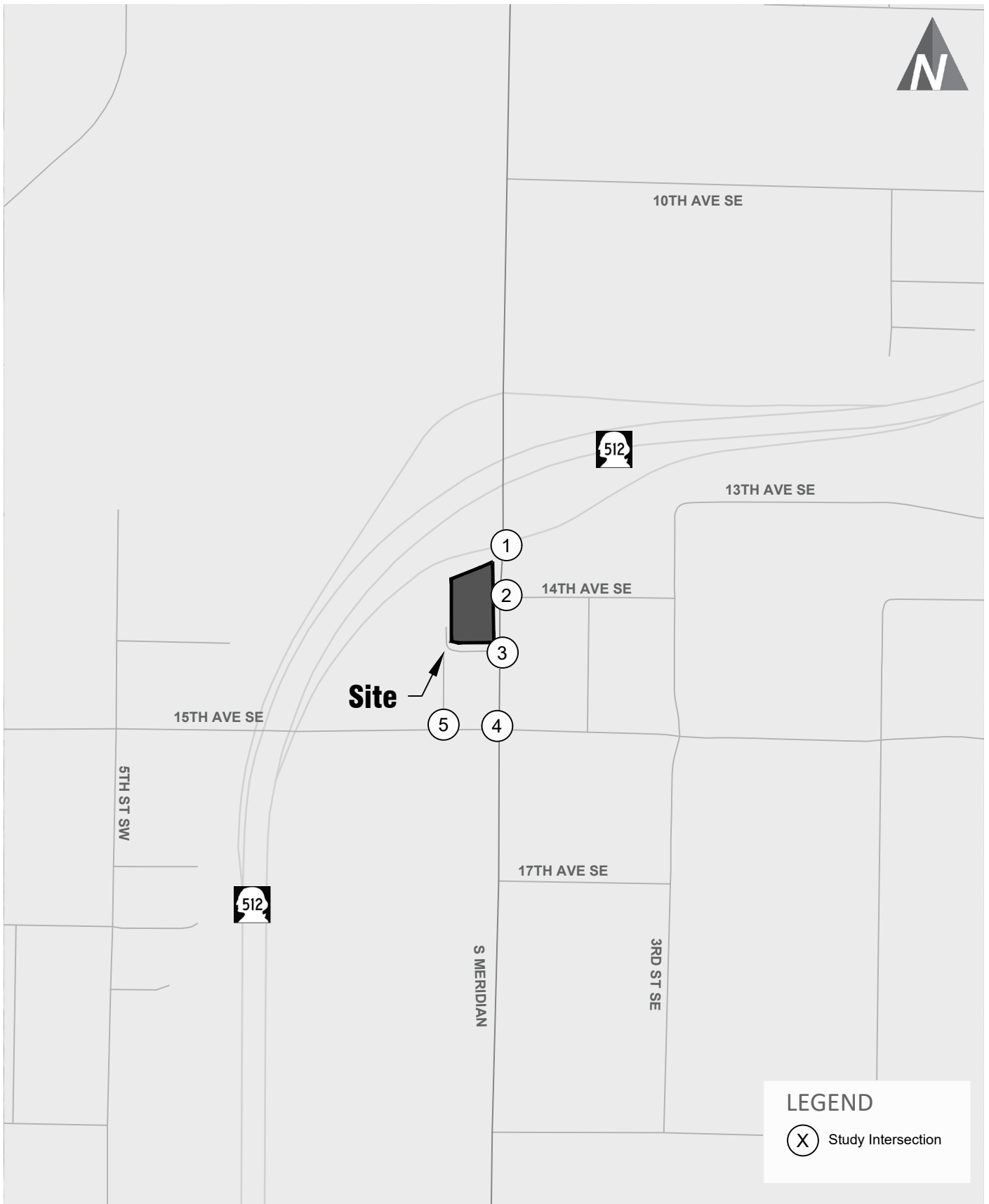

Site Vicinity and Study Intersections

Puyallup ARCO



FIGURE

1

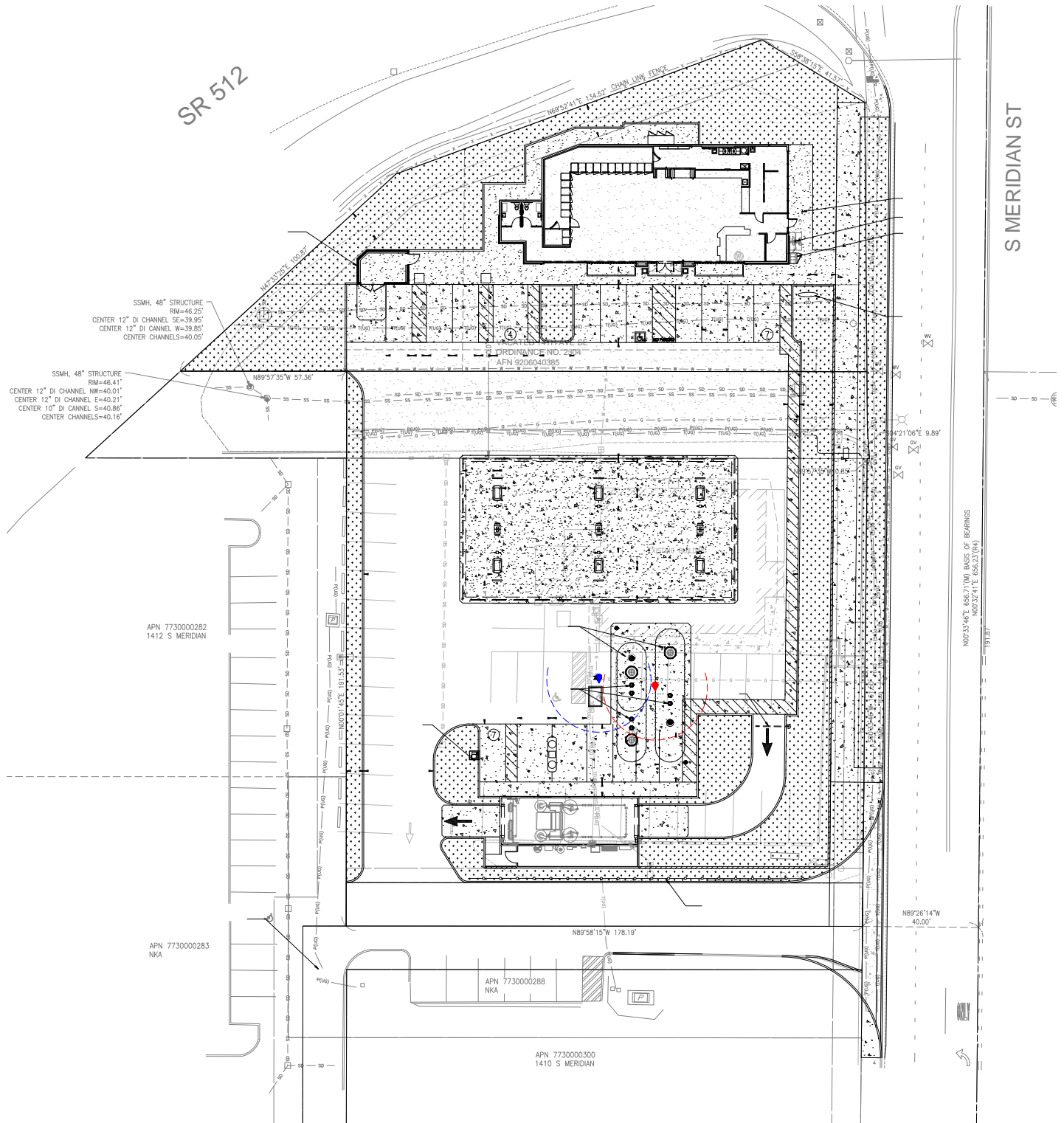

Site Plan

Puyallup ARCO

FIGURE

2



Existing and Future Without-Project Conditions

This section describes both existing and future (2024) without-project conditions within the identified study area. Characteristics are provided for the roadway network, transit service, traffic volumes, traffic operations, and traffic safety.

Roadway Network

The following sections describe the existing street network within the vicinity of the proposed project and anticipated changes resulting from planned improvements.

Existing

The primary roadways within the study area and their characteristics near study intersections are described in Table 1. Roadway functional classifications are based on the City of Puyallup Functional Classification Map per the 2015 Transportation Element. Access for the site is provided via 2 existing driveways along S Meridian (major arterial) and 15th Avenue SW (minor arterial).

Table 1. Roadway Network Existing Conditions Summary

Roadway	Classification	Speed Limit	# Lanes	Parking	Pedestrian Facilities	Bicycle Facilities
S Meridian	Major Arterial	35 mph	5	No	Sidewalks	None
14th Ave SE	Local Road	25 mph	2	Yes	Sidewalks	None
15th Ave SE	Major Collector	25 mph	3	No	Intermittent sidewalks	None
15th Ave SW	Minor Arterial	35 mph	3	No	Sidewalks	None

Planned Improvements

Based on a review of the City of Puyallup *Six Year Transportation Improvement Program (TIP) 2023-2028 Summary Sheet*, several planned improvements were identified within the vicinity of the study area. These projects include:

- **43rd Avenue SE; Meridian to 10th Street SE** - Roundabout or signal at 10th St SE and curb, gutter, sidewalk, and street lighting on north half of 43rd Ave SE and complete roadway to city standard from Meridian to 5th St w/Meridian intersection improvements adding right turn lane.
- **7th Street SE, 12th to 15th Avenue SE & 15th to 23rd Avenue SE** – North/South Corridor that is missing the connecting road between 15th and 12th Avenue SE. Existing Road between 15th & 23rd would need to be improved to current standards with appropriate lane widths, two-way left turn lane, curb gutter, and sidewalk.
- **9th Street SW; 15th Avenue SW to 31st Avenue SW** – 3 lanes with curb, gutter, sidewalk, bike lanes, and street lighting on both sides and additional lane capacity at 31st Ave SW/9th St SW intersection.

The three identified projects are not anticipated to be constructed by the project’s 2024 horizon year and so no changes were assumed in the future operational analysis relative to these projects.

Transit Service

Transit service in the study area is provided by Pierce Transit. The nearest bus stops to the proposed development are located adjacent to the site along S Meridian at 14th Avenue SE.



Additional transit stops are located approximately a quarter mile north of the site along S Meridian as well as approximately 0.15 mile south of the site along S Meridian at 17th Avenue SE. Table 2 shows the transit routes that operate within the project vicinity.

Table 2. Existing Transit Service

Route	Area Served	Approximate Operating Hours	PM Peak Headways (minutes)
402	Meridian E & 171st St Ct E to Federal Way Transit Center	5:45 a.m. to 8:45 p.m.	20-25
425	Puyallup Connector	11:30 a.m. to 5:20 p.m.	20-25

Source: Pierce Transit, 2023

Note: Operating Hours and headways are approximate

Traffic Volumes

The following sections summarize existing and future (2024) without-project traffic volumes within the study area.

Existing

Existing weekday AM peak period (7-9 a.m.) and PM peak period (4-6 p.m.) traffic volumes were collected in February 2023. Note that as coordinated with City staff, queues were also collected at the S Meridian/15th Avenue SW signalized intersection during the weekday AM and PM peak hours as well as southbound along S Meridian at the SR 512 eastbound ramps. Figure 3 illustrates the existing weekday peak hour traffic volumes at the study intersections. Volumes are rounded to the nearest 5 vehicles to account for the daily fluctuations in traffic volumes. Detail traffic counts are provided in Appendix B.

Future Without-Project Traffic Volumes

Future (2024) without-project traffic volumes were forecasted by applying an annual growth rate to existing traffic volumes. An annual growth rate of 3 percent was applied to existing study intersection traffic volumes to estimate 2024 horizon year background traffic growth, as coordinated with City of Puyallup staff. This growth rate captures potential increases in traffic volumes in the study area due to planned development and land use changes. No specific pipeline projects (i.e., planned developments) were identified to be completed by 2024. The forecast future 2024 without-project weekday peak hour traffic volumes are shown in Figure 4.

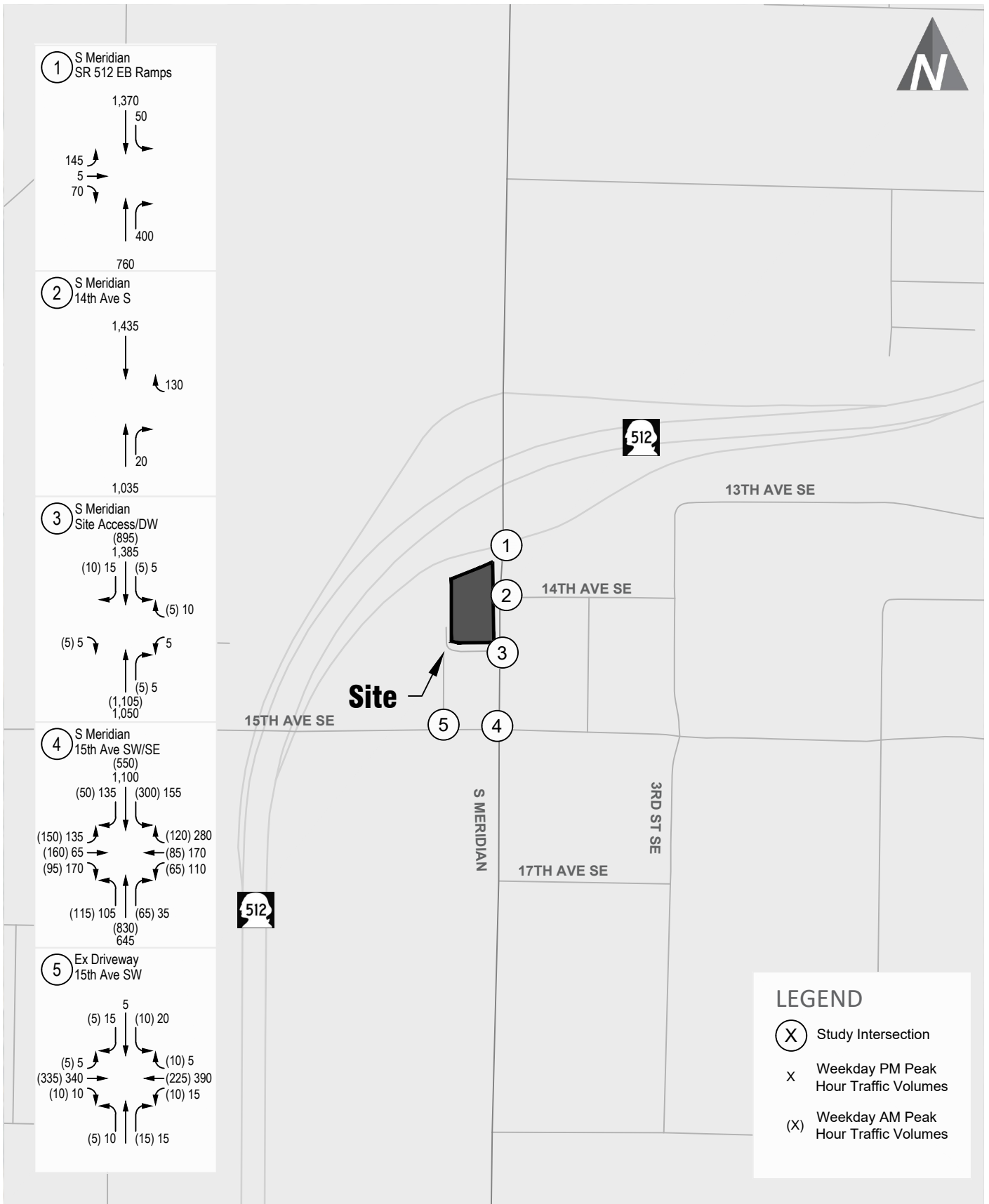

Existing Weekday Peak Hour Traffic Volumes

FIGURE

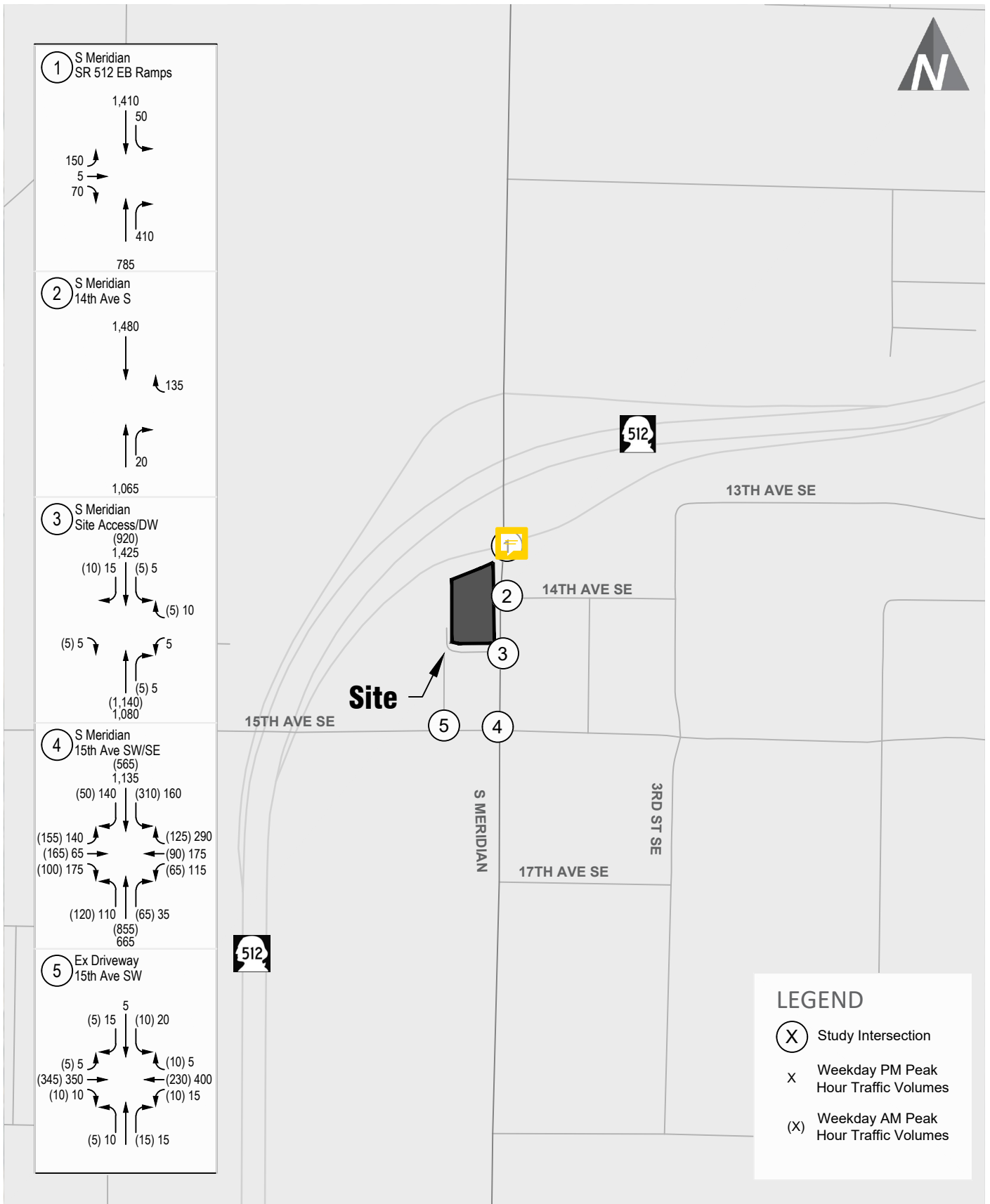

Future (2025) Without-Project
 Weekday Peak Hour Traffic Volumes

Puyallup ARCO

Traffic Operations

The operational characteristics of an intersection are determined by calculating the intersection level of service (LOS). At signalized intersections LOS is measured in average control delay per vehicle and is reported using the intersection delay. At unsignalized side-street, stop-controlled intersections, LOS is measured by the average delay on the worst-movement of the intersection. Traffic operations and average vehicle delay can be described qualitatively with a range of levels of service (LOS A through LOS F), with LOS A indicating free-flowing traffic and LOS F indicating extreme congestion and long vehicle delays. Appendix C contains a detailed explanation of LOS criteria and definitions.

Based on the *City of Puyallup Transportation Element*, the City has adopted an LOS D standard.

The two traffic signals in the study area along S Meridian run on an adaptive traffic signal system. Adaptive systems allow the signal timing to be modified at a cycle-by-cycle level based on fluctuations in traffic volumes. City of Puyallup staff provided recent timing that has occurred during the weekday AM and PM peak hours, which were assumed in the analysis.

Weekday AM and PM peak hour traffic operations for existing and future (2024) without-project conditions were evaluated based on the procedures identified in the *Highway Capacity Manual* (HCM 6) using *Synchro 11*. *Synchro 11* is a software program that uses HCM methodology to evaluate intersection LOS and average vehicle delay. Results for the existing and future without-project operations analyses are summarized in Table 3. Detailed LOS worksheets for each intersection analysis are included in Appendix D.

The observed queues in the field along S Meridian and 15th Avenue SW were reviewed relative to the model suggested queues. The longest queues were observed along S Meridian, specifically northbound in the AM peak hour and southbound in the PM peak hour. Synchro parameters were adjusted to calibrate the analysis to better reflect the existing conditions focusing on the longest queueing observed along the S Meridian corridor. A comparison of the queueing per the analysis and the observations during the peak hour are provided in Table 4. The operations as summarized in Table 3 reflect the calibrated synchro model.

Table 3. Existing and Future Without-Project Peak Hour LOS Summary

Intersection	Traffic Control	Existing			(2024) Without-Project		
		LOS ¹	Delay ²	WM ³	LOS	Delay	WM
AM Peak Hour							
3. S Meridian/Existing Driveway	TWSC	B	13	WB	B	14	WB
4. S Meridian/15th Ave SW	Traffic Signal	D	45	-	D	53	-
5. Existing Driveway/15th Ave SW	TWSC	C	15	SB	C	16	SB
PM Peak Hour							
1. S Meridian/SR 512 EB Ramps	Traffic Signal	A	8	-	A	8	-
2. S Meridian/14th Ave S	TWSC	C	15	WB	C	16	WB
3. S Meridian/Existing Driveway	TWSC	C	19	WB	C	20	WB
4. S Meridian/15th Ave SW	Traffic Signal	D	36	-	D	52	-
5. Existing Driveway/15th Ave SW	TWSC	C	16	SB	C	17	SB

Note: TWSC = Two-way Stop Controlled.

1. Level of Service (A – F) as defined by the *Highway Capacity Manual* (TRB, 6th Edition)

2. Average delay per vehicle in seconds

3. Worst movement reported for unsignalized intersections. SB = southbound, WB = westbound

Table 3 shows the study intersections operate at LOS D or better during the weekday AM and PM peak hours. With the addition of background traffic, the study intersections are

forecast to continue to meet the City LOS standard and operate at LOS D or better during the weekday AM and PM peak hours.

Table 4. Existing and Future Without-Project Peak Hour Queueing along S Meridian

Movement	AM Peak Hour			PM Peak Hour		
	Max Observed ¹	Modeled 95th Percentile ²		Max Observed	Modeled 95th Percentile	
		Existing	Future (2024) Without Project		Existing	Future (2024) Without Project
Northbound (south of 15th Ave SW)						
Northbound Through	705	765	790	320	300	315
Northbound Through/Right	645	765	790	440	300	315
Southbound³ (north of 15th Ave SW)						
Southbound Left	535	420	450	230	75	75
Southbound Through	205	295	305	50	915	970
Southbound Through/Right	170	295	305	950	915	970

Note: Queueing reported in feet.

1. Reflects the peak queue as observed during the peak hour of the traffic counts collected in Feb 2023. 7:30-8:30 a.m. & 4-5 p.m.

2. 95th percentile queue as modeled using synchro.

3. Southbound queues for both the observed and modeled include southbound queues at the 15th Avenue SW and SR 512 EB Ramps intersections along S Meridian.

As noted above and illustrated in Table 4, the analysis and observations consistently reflected the longest queues occurring northbound in the weekday AM peak hour and southbound in the weekday PM peak hour along S Meridian. The southbound maximum observed queue in the weekday PM peak hour along S Meridian was approximately 950 feet, compared with approximately 915 feet 95th percentile queue as evaluated in the existing synchro analysis, extending from 15th Avenue SW, north of the SR 512 eastbound ramps. The northbound maximum observed queue in the weekday AM peak hour along S Meridian was approximately 705 feet, compared with approximately 765 feet 95th percentile queue as evaluated in the existing synchro analysis. In both the AM and PM peak hours, the observed and estimated queues along S Meridian are similar, within approximately 2 to 3 vehicles.

Under future (2024) without-project conditions, the 95th percentile queues are forecast to increase by approximately 2 or fewer vehicles during both the weekday AM and PM peak hours.

Traffic Safety

The five most recent years of collision records (January 1, 2017 and December 31, 2021) provided by the Washington State Department of Transportation (WSDOT) were reviewed within the study area to identify any existing traffic safety issues at the study intersections. A summary of the total and average annual number of reported collisions as well as the collisions rates at the study intersections are provided in Table 5.

The collision rate is representative of the number of collisions per one million entering vehicles (MEV) at each intersection. Intersections with a rate greater than 1.0 collision per MEV are typically flagged for further investigation to determine whether an adverse condition exists. As shown in the table, all study intersections are below 1.0 collisions per MEV during the review period.

Table 5. Five-Year Collision Summary (2017-2021)

Location	Number of Collisions					Total	Annual Average	Collisions per MEV ¹
	2017	2018	2019	2020	2021			
1. S Meridian/SR 512 EB Ramps	6	2	3	1	4	16	3.20	0.31
2. S Meridian/14th Ave S	3	1	0	0	1	5	1.00	0.10
3. S Meridian/Existing Driveway	1	4	2	0	0	7	1.40	0.15
4. S Meridian/15th Ave SW	13	11	5	6	14	49	9.80	0.86
5. Existing Driveway/15th Ave SW	3	2	0	0	1	6	1.20	0.40

Source: WSDOT April 2022

1. MEV = Million Entering Vehicles

The most frequently reported collision type in the study area is rear-end collision, with the majority of collisions resulting in property damage only (PDO). Rear-end collisions are common in stop-and-go traffic such as the congestion observed along S Meridian. No collisions were reported that resulted in a fatality within the study area during the five-year review period. There were two collisions involving a pedestrian and one reported collision involving a bicyclist, all of which occurred at the S Meridian/15th Avenue SW intersection; however, only one of these collisions was due to the driver not granting right-of-way (ROW). The other collisions were associated with the bicyclist not granting ROW to the vehicle or due to a driver under the influence of alcohol. Based on the collision history review in the study area, no existing safety patterns or issues requiring specific improvements were identified.

Project Impacts

The following sections summarize the proposed project's impacts on the surrounding street system. First, traffic volumes generated by the proposed project are estimated and then distributed and assigned to adjacent roadways within the study area. Next, project trips are added to future without-project traffic volumes and the potential impact to traffic operations are identified. Site-specific items are also discussed.

Trip Generation

The approach and trip generation results were coordinated with City staff. Trip generation for the proposed project and existing uses to be removed were calculated based on trip rates using the Institute of Transportation Engineers (ITE) *Trip Generation Manual* (11th Edition, 2021) as available. ITEs Convenience Store/Gas Station - VFP (16-24) (LU #945) and High-Turnover Restaurant (LU #932) land uses were assumed for the proposed project and existing use to be removed, respectively. ITE does not currently have data available for the proposed EV charging stalls, and as such, the trip generation for the EV charging stalls was estimated both programmatically based on information on how the charging stations operate as well as a based on a review of previous studies.

EV Charging Stalls Trip Generation: The proposal includes 4 stalls with 2 charging units (i.e., there can be a vehicle on each side of the unit). Each unit includes 2 plugs total allowing for charging the most common connection configurations (CHAdeMO and Tesla style). The plug types are specific to the vehicle so there can only be one vehicle at a station charging at a time with the specific plug type (e.g., if you have Leaf you need the CHAdeMO plug type and if someone else is using that type you will have to wait or find another station.) Therefore, there can only be 2 of one kind of vehicle charging at any given time, limiting the usage. Additionally, typical charge times range between 20-40 minutes.

- Programmatic estimate: Based on the proposed parameters of the EV stalls, it is anticipated the 4 stalls would provide an average of 20 total charges per day (i.e., 5 charges per stall per day), which equates to a weekday daily trip generation rate of 10 trips/plug (or 40 EV trips for the site per day). These daily trips were distributed assuming 2 trips/stall in the PM peak hour (i.e., 8 EV trips with the 4 stalls) and 1.5 trips/stall in the AM peak hour (i.e., 6 EV trips with the 4 stalls). This equates to approximately 35 percent of daily trips occurring during the peak hours. This is conservative relative to the gas station, which estimates only 12 percent of daily trips occurring during the peak hours.
- Other EV Data. The trip generation study *Charging Electric Vehicles in Smart Cities: An EVI-Pro Analysis of Columbus, Ohio* (National Renewable Energy Laboratory, 2018) reviewed EV stall usage in Seattle. The study showed there were 2.22 sessions/day/plug or 4.44 trips/day/plug. For the proposed project with 4 plugs, the study indicates that there would be 17.76 total daily trips or less trips than the programmatic estimate. There were no peak hour data in the 2018 study; however, if it was assumed 35% of the daily trips occurred during the peak hours (consistent with the programmatic estimate above) then with the lower daily trip rates from the 2018 study there would be less peak hour trips projected. As such, use of the programmatic estimate is conservative relative to the 2018 study and was the basis of analysis.

The proposed project trip generation was adjusted for pass-by. Pass-by trips reflect traffic already on streets in the vicinity of the project site that would visit the commercial components of the project while driving by the site on the way to its final destination. Based on ITE *Trip Generation Manual* (11th Edition, 2021), the pass-by rates for the gas

station/convenience station and restaurant uses are approximately 75 percent and 43 percent, respectively. As no pass-by data was available for the proposed EV charging stalls, no reduction for pass-by was assumed which provides a conservative estimate.

Table 6 shows the weekday net new off-site vehicle trips generated by the proposed project. The detailed trip generation calculations are included in Appendix E.

Table 6. Estimated Net New Weekday Vehicle Trip Generation

Land Use ¹	Size	Daily Trips	AM Peak Hour			PM Peak Hour		
			In	Out	Total	In	Out	Total
Proposed								
Convenience Store/Gas Station (LU #945)	3,675 sf / 16 vfp	1,039.3	30.4	31.3	61.7	36.5	37.2	73.7
EV Charging ²	4 stalls	40.0	2.0	4.0	6.0	5.4	2.6	8.0
	<i>Subtotal</i>	1,079.3	32.4	35.3	67.7	41.9	39.8	81.7
Existing								
High Turnover Restaurant (LU #932)	2,760 sf	168.7	9.3	5.8	15.1	9.6	4.6	14.2
Net New Total		910.6	23.1	29.5	52.6	32.3	35.2	67.5

Note: sf = square feet, vfp = vehicle fueling position.

1. Average trip rates from ITE *Trip Generation Manual*, 11th Edition (2021).

2. Estimated programmatically.

As shown in Table 6, the proposed project is estimated to generate approximately 911 weekday daily trips with 53 occurring in the AM peak hour and 68 occurring in the PM peak hour.

Trip Distribution & Assignment

Trip distribution patterns for the proposed uses to and from the site were based on existing travel patterns in the vicinity of the project site and were confirmed with City of Puyallup staff during scoping. The trip distribution for the proposed project is shown on Figure 5. The net new peak hour project trips were assigned within the study area based on distribution for the proposed project and are shown in Figure 5. For the purposes of the analysis, the vehicle trips shown in Table 5 were rounded to the nearest whole number.

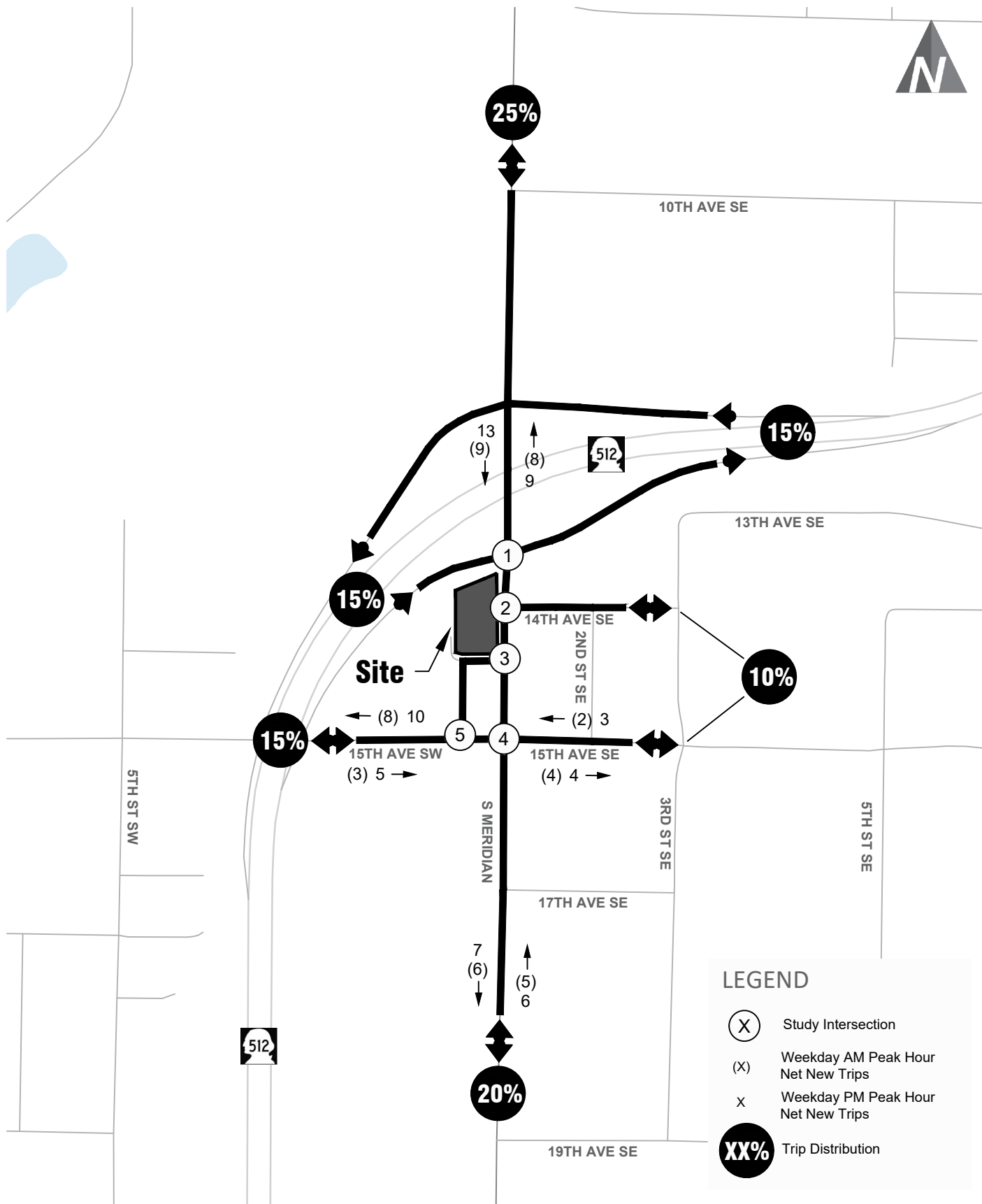

Project Trip Distribution and Assignment

Puyallup ARCO

FIGURE



Traffic Volume Impact

Site generated weekday peak hour traffic volumes were added to future without-project volumes at study intersections. The resulting future (2024) with-project peak hour traffic volumes are illustrated in Figure 6. Table 7 summarizes the anticipated increase in total entering traffic at the study intersections as well as the percent of future with-project traffic volumes attributable to the proposed project.

Table 7. Traffic Volume Impacts at Study Intersections

Intersection	Total Entering Vehicles			Percent Project Share
	2024 Without- Project	Project Trips	2024 With-Project	
Weekday AM Peak Hour Total Entering Vehicles				
3. S Meridian/Existing Driveway (Site Access)	2,090	146	2,236	6.5%
4. S Meridian/15th Ave SW	2,665	29	2,694	1.1%
5. Existing Driveway/15th Ave SW (Site Access)	645	32	677	4.7%
Weekday PM Peak Hour Total Entering Vehicles				
1. S Meridian/SR 512 EB Ramps	2,880	32	2,912	1.1%
2. S Meridian/14th Ave S	2,700	32	2,732	1.2%
3. S Meridian/Existing Driveway (Site Access)	2,550	167	2,717	6.1%
4. S Meridian/15th Ave SW	3,205	34	3,239	1.0%
5. Existing Driveway/15th Ave SW (Site Access)	850	40	890	4.5%

As shown in Table 7, the project generated traffic volumes are anticipated to be approximately 1 percent within the study area with the exception of the site accesses which are forecast to have a 4 to 7 percent project share. The project increase at the study intersections is similar to typical observed daily fluctuations of traffic volumes where traffic can change by up to 10 percent.

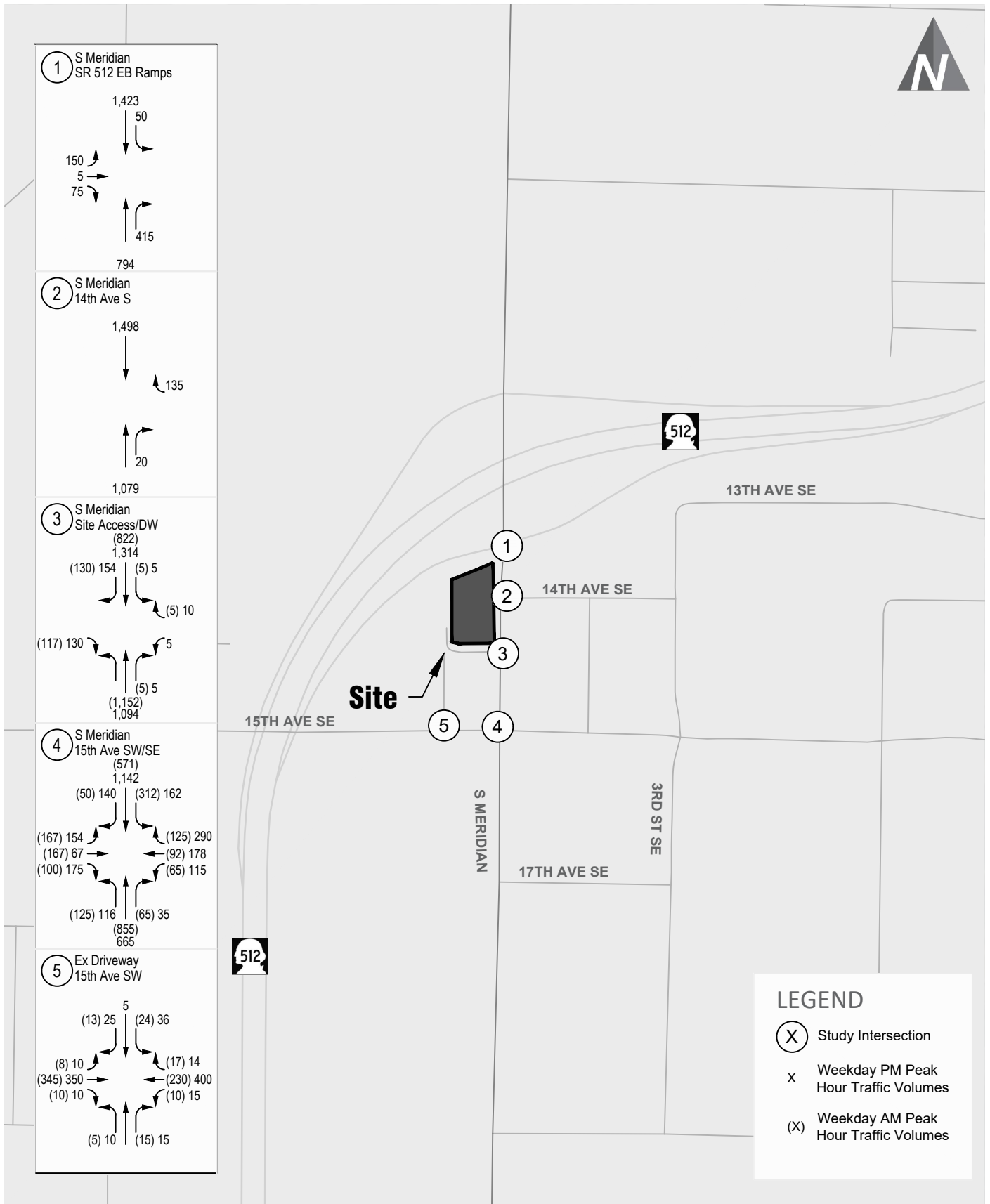

Future (2025) With-Project Weekday Peak Hour Traffic Volumes

FIGURE

Traffic Operations Impact

A future (2024) with-project level of service analysis was conducted for the weekday peak hour to analyze traffic impacts of the proposed project. The same methodologies were applied as described for existing and future without-project conditions. All intersection parameters such as channelization, intersection control, and signal timing were consistent with those used in the evaluation of future without-project conditions. A comparison of future (2024) without-project and with-project weekday peak hour traffic operations is summarized in Table 8. Detailed LOS worksheets are provided in Appendix D. The 95th percentile queues are also summarized in Table 9.

Table 8. Future (2024) AM and PM Peak Hour LOS Summary

Intersection	Traffic Control	(2024) Without-Project			(2024) With-Project		
		LOS ¹	Delay ²	WM ³	LOS	Delay	WM
AM Peak Hour							
3. S Meridian/Existing Driveway	TWSC	B	14	WB	B	15	EB
4. S Meridian/15th Ave SW	Traffic Signal	D	53	-	D	54	-
5. Existing Driveway/15th Ave SW	TWSC	C	16	SB	C	17	SB
PM Peak Hour							
1. S Meridian/SR 512 EB Ramps	Traffic Signal	A	8	-	A	8	-
2. S Meridian/14th Ave S	TWSC	C	16	WB	C	16	WB
3. S Meridian/Existing Driveway	TWSC	C	20	WB	C	22	WB
4. S Meridian/15th Ave SW	Traffic Signal	D	52	-	D	53	-
5. Existing Driveway/15th Ave SW	TWSC	C	17	SB	C	18	SB

Note: TWSC = Two-way Stop Controlled.

1. Level of Service (A – F) as defined by the *Highway Capacity Manual* (TRB, 6th Edition)

2. Average delay per vehicle in seconds

3. Worst movement reported for unsignalized intersections. SB = southbound, WB = westbound, EB = eastbound

With the project, the study intersections are forecast to continue to operate at LOS D or better, meeting the City’s standard with increases in delay of 2 seconds or less.

Table 9. Future (2024) AM and PM Peak Hour Queuing along S Meridian

Movement	AM Peak Hour		PM Peak Hour	
	Modeled 95th Percentile ¹		Modeled 95th Percentile	
	Future (2024) Without Project	Future (2024) With Project	Future (2024) Without Project	Future (2024) With Project
Northbound (south of 15th Ave SW)				
Northbound Through	790	790	315	315
Northbound Through/Right	790	790	315	315
Southbound² (north of 15th Ave SW)				
Southbound Left	450	455	75	85
Southbound Through	305	310	970	980
Southbound Through/Right	305	310	970	980

Note: Queuing reported in feet.

1. 95th percentile queue as modeled using synchro.

2. Southbound queues include southbound queues at the 15th Avenue SW and SR 512 EB Ramps intersections along S Meridian.

Additionally, Table 9 shows that there is forecast to be limited increase in the 95th percentile queues along either S Meridian or 15th Avenue SW with the project relative to the future (2024) without project conditions during both the weekday AM and PM peak hours.

No impact requiring mitigation is identified based on the analysis.

Site Access Evaluation

As described above, there are two existing driveways that will provide access for the site. These include a right-in/right-out access via S Meridian and a full access via 15th Avenue SW both of which are side street stop controlled. The operations at the two site accesses are summarized in Table 8 and are forecast to operate at LOS C or better during both the weekday AM and PM peak hours.

The on-site maneuvers, sight distance, and right turn lane warrant analysis are summarized below.

Maneuvers

The vehicle maneuvers to/from the site were completed by Barghausen assuming the design vehicle of a fuel truck. The autoturn analysis is provided in Appendix F. The maneuvers of the fuel truck are shown to be able to maneuver to/from the site via the primary driveway along S Meridian although are required to use the curb and center lane which is typical of a larger vehicle. Note that the fuel truck makes approximately one (1) trip per day. The typical vehicle to/from the site is a passenger car which is able to stay within the curb lane without impacting the adjacent travel lane when maneuvering to/from the site.

Sight Distance

The entering and stopping sight distance was evaluated per City of Puyallup Roadway Design Standards by Barghausen at the primary site driveway along S Meridian. S Meridian is classified as a major arterial with a posted speed limit of 35 mph or design speed of 45 mph. Per Table 100-2, the required stopping and entering sight distance are 400 and 415 feet, respectively. The sight distance at the right-in/right-out S Meridian driveway is illustrated in Appendix G. As shown in the appendix, the sight distance is met at the proposed access.

Right Turn Lane Warrant Review

A right-turn lane warrant analysis was completed for the two site driveways per WSDOT's design manual Exhibit 1310-19 based on the forecast weekday AM and PM peak hour traffic volumes at the site accesses with the project. The detailed right turn lane warrant analysis is included in Appendix H. As shown in Appendix H, a right-turn lane can be considered along S Meridian and a radius only can be considered for the driveway along 15th Avenue SW.

The operational analysis shows that both driveways operate at LOS C or better during the weekday peak hours and meet the City's LOS standards without the additional capacity of a right-turn lane, such that the right-turn lane is not needed relative to the driveway operations. Also, based on the autoturn analysis summarized above, a right turn lane is not needed to access the site. Finally, the sight distance is met at the S Meridian driveway. Therefore, based on the driveway operations, the turning analysis, and the sight distance review, no right turn lane is recommended.

Mitigation

No significant traffic impacts requiring mitigation have been identified based on the TIA. The project would pay traffic impact fees, which would help offset the impacts of the proposal. The City of Puyallup identifies a traffic impact fee of \$4,500 per net new weekday PM peak hour trips. As summarized above, the proposed project is estimated to generate 67.5 trips, resulting in a fee of \$303,750 for the proposed project. The City would calculate the final fee for the project at the time of permits being issued.

Findings and Recommendations

This traffic impact study summarizes the project traffic impacts of the proposed ARCO AM/PM Development. General findings and recommendations include:

- The proposed project would construct 8 fuel pump (16 fueling position) gas station with a 3,675 square feet (sf) convenience market and supportive functions including a car wash and vacuuming stations. Additionally, the project would include 4 EV charging stations.
- The development is anticipated to generate approximately 911 weekday daily trips with 53 occurring in the AM peak hour and 68 occurring in the PM peak hour.
- The off-site study intersections operate at LOS D or better under existing conditions during both the weekday AM and PM peak hours, meeting the City's LOS standard. In the future, both without and with the project, the off-site study intersections are forecast to continue to operate acceptably at LOS D or better during the weekday AM and PM peak hours.
- Access to the site would be provided via the existing driveways to the east of the site along S Meridian (with the driveway restricted to right-in/right-out only) and south of the site along 15th Avenue SW. Both site driveways are anticipated to operate acceptably during the peak hours and no right-turn lanes are recommended.
- The City would calculate the final fee for the project at the time of permits being issued. The preliminary traffic fee estimate is \$303,750.

Appendix A: Traffic Impact Analysis Scoping Worksheet

City of Puyallup Traffic Scoping Worksheet

PROJECT INFORMATION

Project Title: ARCO AM/PM Date: 11/28/2022

Applicant Name: Nick Wecker, Barghausen Consulting Engineers, Inc. Telephone Number: (425) 656-7469

Project Description: Construct 8 fuel pump (16 fueling position) gas station with a 3,675 sf convenience market and supportive functions including a car wash and vacuuming station. Additionally the project would include 4 EV Charging stations. Remove existing restaurant. Year of Occupancy: 2023

Project Location: 1402 S Meridian, Puyallup Parcel Size: 51,520 SF

Proposed Number of Access Point(s): 1 Existing Number of Access Point(s): 1

Land Use	Quantity	ITE Land Use Code	Average Daily Trips	AM Peak Hour Trips*	PM Peak Hour Trips*	
Existing Use(s)						
High Turnover Sit-Down Restaurant	2,760 sf	932	168	14.4	15.0	14.2
Proposed Use(s)						
Convenience Store/Gas Station - VFP (16-24)	3,675 sf / 16 vfp	945	1,040	61.0	72.7	73.7
EV Charging	4 stations	-	30	4.0	6.0	8.0
Net New Trips			902	50.5	63.7	67.5
Traffic Impact Fees: Net New PM Peak Hour Trips x \$4,500.00 = \$ 286,650 \$303,750						

- * The peak hour project trips shall be rounded to the nearest tenth. 11th Edition
- * The project trips shall be estimated using the ITE's *Trip Generation*, ~~10th Edition~~.
- * Trip generation regression equations shall be used when the R² value is 0.70 or greater.
- * For land uses that do not exist within the ITE's *Trip Generation*, actual field data shall be collected from three local facilities that have similar characteristics to the proposal.
- * For all single-family units and offices and specialty retail centers smaller than 30,000 SF, use ITE's *Trip Generation*, 10th Edition, average rate.

Identify all intersections that will be affected by 25 new project peak hour trips or more:

- | | |
|---|---|
| 1. <u>S Meridian/SR 512 EB</u> | 5. <u>Existing Driveway/15th Ave SW</u> |
| 2. <u>S Meridian/14th Ave SE</u> | 6. _____ |
| 3. <u>S Meridian/Existing/Proposed DW</u> | 7. _____ |
| 4. <u>S Meridian/15th Ave SW</u> | 8. _____ |

Prepared by: Traffic Engineer: Kassi Leingang, PE Telephone Number: (425) 896-5240

Address: Transpo Group, 12131 113th Ave NE, #203, Kirkland, WA 98034

Office Use Only

TIS TAS TAIS No Further Work Required

Checklist (Please make sure you have included the following information):

- Completed Worksheet Attach Site Plan Attach Trip Assignment Attach Trip Distribution
 Mail or hand deliver to 333 South Meridian, Puyallup, WA 98371 or e-mail to broberts@ci.puyallup.wa.us

PRELIMINARY SITE PLAN

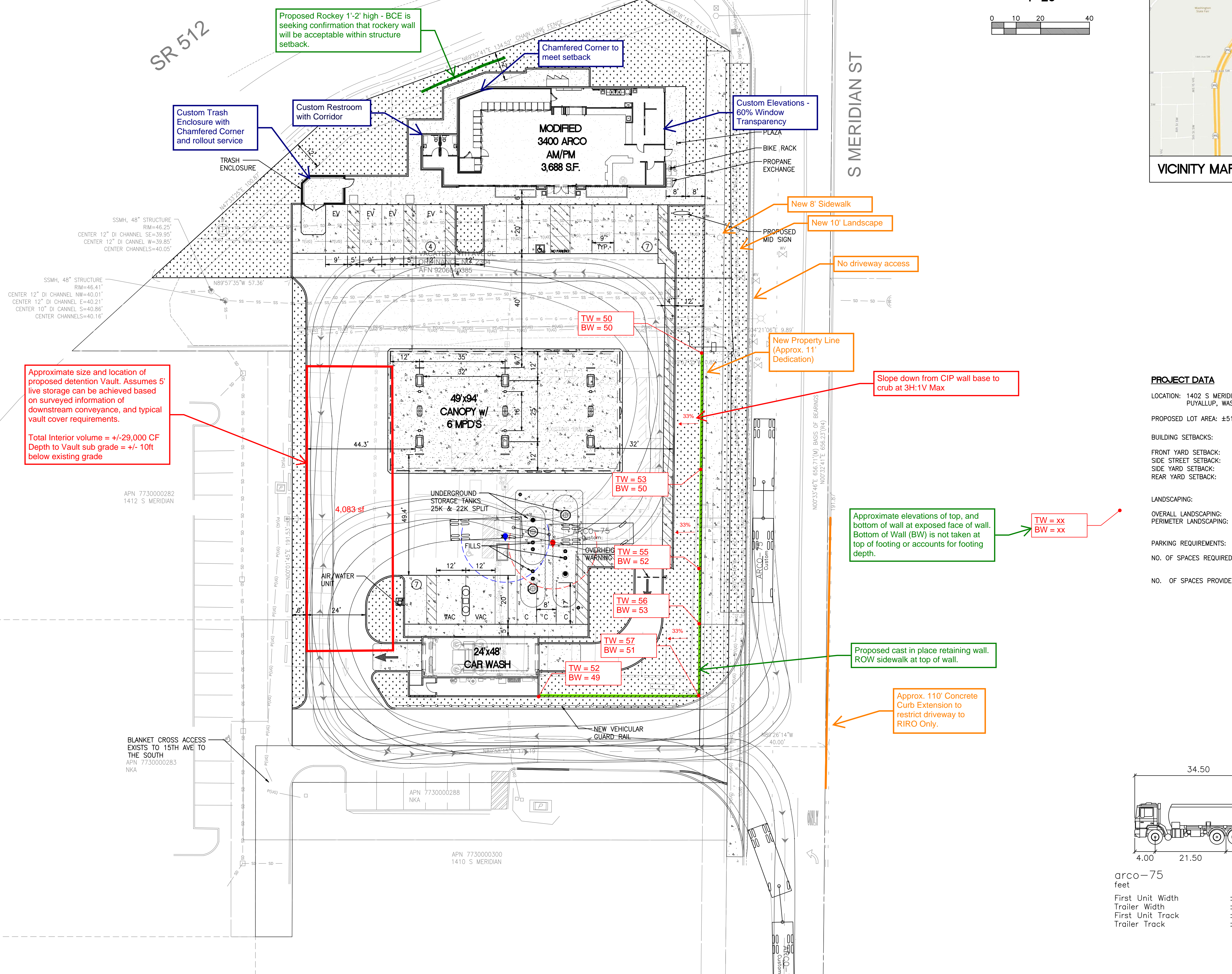
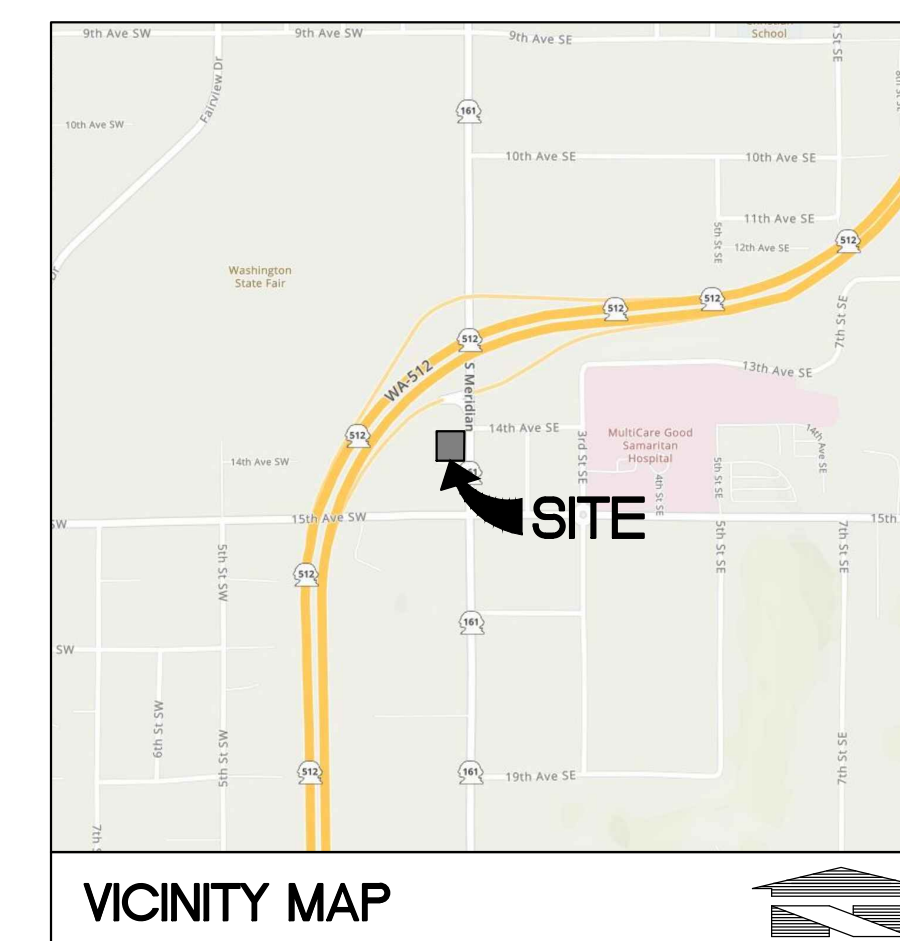
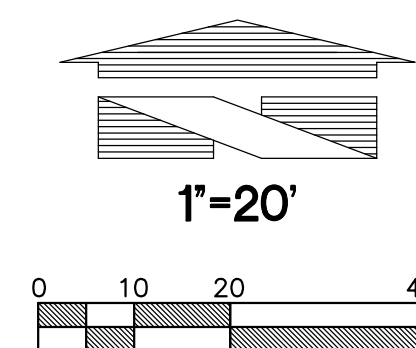

Approximate size and location of proposed detention Vault. Assumes 5' live storage can be achieved based on surveyed information of downstream conveyance, and typical vault cover requirements.

Total Interior volume = +/-29,000 CF
Depth to Vault sub grade = +/- 10ft below existing grade

PROJECT DATA
 LOCATION: 1402 S MERIDIAN PUYALLUP, WASHINGTON
 PROPOSED LOT AREA: ±51,520 S.F. (1.18 AC)
 BUILDING SETBACKS:
 FRONT YARD SETBACK: 12'
 SIDE STREET SETBACK: 12'
 SIDE YARD SETBACK: 0'
 REAR YARD SETBACK: 0'
 LANDSCAPING:
 OVERALL LANDSCAPING: 10% OF PAVED AREA
 PERIMETER LANDSCAPING: SETBACK WIDTH OR 12 FEET, WHICHEVER LESS
 PARKING REQUIREMENTS:
 NO. OF SPACES REQUIRED: 1 SPACE PER 300 SQUARE FEET
 3,688/300 = 12.3
 NO. OF SPACES PROVIDED: 18

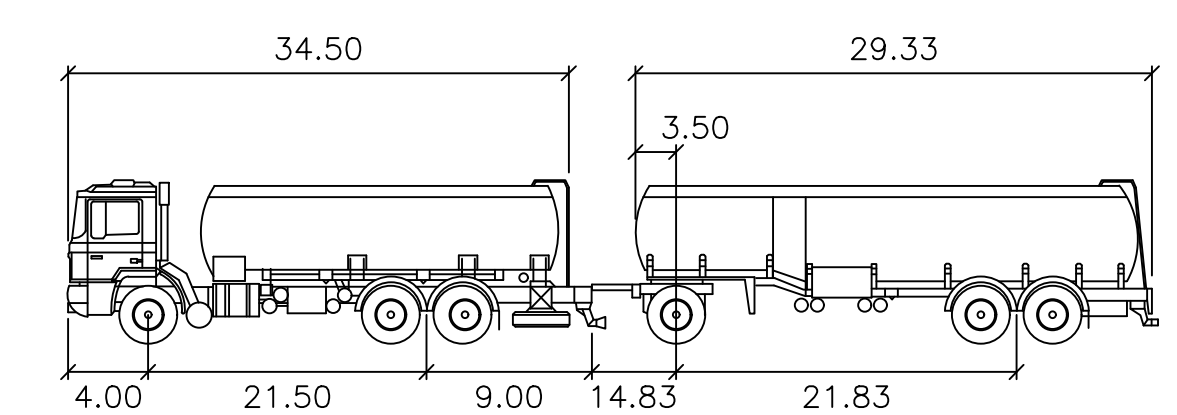

arco-75 feet

First Unit Width	: 8.50	Lock to Lock Time	: 6.0
Trailer Width	: 8.50	Steering Angle	: 36.0
First Unit Track	: 8.50	Articulating Angle	: 70.0
Trailer Track	: 8.50		

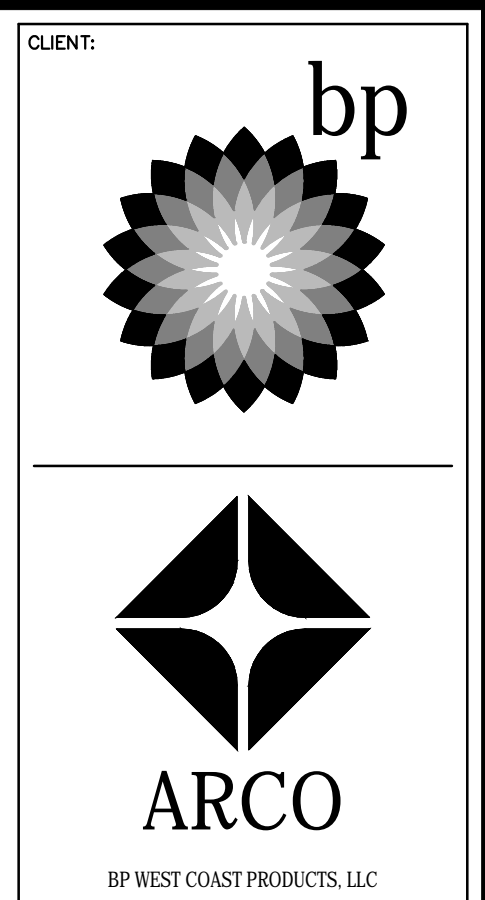

Barghausen Consulting Engineers, Inc.
 18215 72nd Avenue South
 Kent, WA 98032
 425.251.6222
 barghausen.com

NO.	DATE	REVISION DESCRIPTION
1		
2		
3		
4		
5		
6		
7		
8		
9		
10		

Not for Construction

DEVELOPMENT INFORMATION:
 ARCO NTI
 MODIFIED 3400 am/pm FUEL CANOPY w/ 6 MPD's
 24'x48' CAR WASH

SITE ADDRESS:
 SWC S MERIDIAN
 @ HIGHWAY 512
 PUYALLUP, WASHINGTON

FACILITY #TBD

DESIGNED BY:	ALLIANCE ZADM:
CHECKED BY:	BP REP:
DRAWN BY:	ALLIANCE PM:
VERSION:	PROJECT NO. 21730

DRAWING TITLE:
PRELIMINARY SITE PLAN

SHEET NO:
SP-8

Preliminary Not For Construction

File:PA210000\21730\preliminary\Site Plan:SP-8\21730-SP-8.dwg Date/Time:8/4/2022 12:15 PM Scale:1" = 1' D:\EDEL Xref:...

Puyallup ARCO

No ITE pass-by data for EV charging stations

Proposed Use																	
Land Use	Setting	Size	Units	Model	Rate ¹	Units	Inbound %	Gross Trips			%	Pass-By ³			Total Net New		
								Inbound	Outbound	Subtotal		In	Out	Total	Inbound	Outbound	Total
Convenience Store/Gas Station - GFA (2-4k) (LU #945)¹		16 vfp															
Daily	General Urban/Suburban	3,675 sf		Rate	265.12	per vf	50%	2,121	2,121	4,242	76%	1601	1601	3202	520	520	1,040
AM Peak Hour	General Urban/Suburban			Rate	16.06	per vf	50%	128	129	257	76%	98	98	196	30	31	61.0
PM Peak Hour	General Urban/Suburban			Rate	18.42	per vf	50%	147	148	295	75%	111	111	222	36	37	72.7
EV Chargers²		4 stalls															
Daily	General Urban/Suburban			Rate	10.00	per stall	50%	20	20	40	25%	5	5	10	15	15	30
AM Peak Hour	General Urban/Suburban			Rate	1.50	per stall	33%	2	4	6.00	25%	1	1	2	1.0	3.0	4.0
PM Peak Hour	General Urban/Suburban			Rate	2.00	per stall	67%	5	3	8.00	25%	1	1	2	4.4	1.6	6.0
Subtotal																	
Daily								2,141	2,141	4,282		1,606	1,606	3,212	535	535	1,070
AM Peak Hour								130	133	263		99	99	198	31	34	65.0
PM Peak Hour								152	150	303		112	112	224	40	38	78.7

Existing Use																	
Land Use	Setting	Size	Units	Model	Rate	Units	Inbound %	Gross Trips			%	Pass-By			Total Net New		
								Inbound	Outbound	Subtotal		In	Out	Total	Inbound	Outbound	Total
High Turnover Sit-Down Restaurant (LU #932)		2,760 sf															
Daily	General Urban/Suburban			Rate	107.20	per ksf	50%	148	148	296	43%	64	64	128	84	84	168
AM Peak Hour	General Urban/Suburban			Rate	9.57	per ksf	55%	15	11	26	43%	6	6	12	9	5	14.4
PM Peak Hour	General Urban/Suburban			Rate	9.05	per ksf	61%	15	10	25	43%	5	5	10	10	5	15.0

Net New Trips																	
Daily															451	451	902
AM Peak Hour															22	29	50.5
PM Peak Hour															30	33	63.7

Notes:

1. Trip rates based on Institute of Transportation Engineers' (ITE) *Trip Generation* 11th Edition average trip rate as shown above. Note that per conversations with the City, LU 945 as reflected in the analysis above is inclusive of all proposed components of the project including the convenience store, fueling pumps, and car wash.
2. EV Charger's trip generation was estimated assuming a daily trip generation of 20 vehicles (40 trips) for the 4 stalls which was based on anticipated daily capacity/output of the chargers. Based on the daily usage, it was estimated that up to 3 vehicles would be served in the AM peak hour and 4 vehicles in the PM peak hour. This peak hour assumption equates to all or nearly all stalls in use as typical charging takes 20-30 minutes.
3. Passby rates per ITE's *Trip Generation Manual*, 11th Edition. A limited portion of trips at the EV-Chargers are anticipated to be pass-by.

Vehicle Pass-By Rates by Land Use

Source: ITE Trip Generation Manual , 11th Edition

Land Use Code	945									
Land Use	Convenience Store/Gas Station									
Setting	General Urban/Suburban									
Time Period	Weekday AM Peak Period									
# Data Sites	16 Sites with between 2 and 8 VFP					28 Sites with between 9 and 20 VFP				
Average Pass-By Rate	60% for Sites with between 2 and 8 VFP					76% for Sites with between 9 and 20 VFP				
Pass-By Characteristics for Individual Sites										
GFA (000)	VFP	State or Province	Survey Year	# Interviews	Pass-By Trip (%)	Non-Pass-By Trips			Adj Street Peak Hour Volume	Source
						Primary (%)	Diverted (%)	Total (%)		
2	8	Maryland	1992	46	87	13	0	13	2235	25
2.1	6	Maryland	1992	26	58	23	19	42	2080	25
2.1	6	Maryland	1992	26	58	23	19	42	2080	25
2.2	8	Maryland	1992	31	47	34	19	53	1785	25
2.2	< 8	Indiana	1993	79	56	6	38	44	635	2
2.2	8	Maryland	1992	35	78	9	13	22	7080	25
2.3	6	Maryland	1992	37	32	41	27	68	2080	25
2.3	< 8	Kentucky	1993	58	64	5	31	36	1255	2
2.3	6	Maryland	1992	37	32	41	27	68	2080	25
2.4	< 8	Kentucky	1993	—	48	17	35	52	1210	2
2.6	< 8	Kentucky	1993	—	72	15	13	28	940	2
2.8	< 8	Kentucky	1993	—	54	11	35	46	1240	2
3	< 8	Indiana	1993	62	74	10	16	26	790	2
3.6	< 8	Kentucky	1993	49	67	4	29	33	1985	2
3.7	< 8	Kentucky	1993	49	66	16	18	34	990	2
4.694	12	Maryland	2000	—	72	—	—	28	2440	30
4.694	12	Maryland	2000	—	78	—	—	22	1561	30
4.694	12	Maryland	2000	—	79	—	—	21	2764	30
4.848	12	Virginia	2000	—	55	—	—	45	1398	30
5.06	12	Pennsylvania	2000	—	84	—	—	16	3219	30
5.242	12	Virginia	2000	—	74	—	—	26	1160	30
5.242	12	Virginia	2000	—	71	—	—	29	548	30
5.488	12	Delaware	2000	—	80	—	—	20	—	30
5.5	12	Pennsylvania	2000	—	85	—	—	15	2975	30
4.2	< 8	Kentucky	1993	47	62	19	19	38	1705	2
4.694	16	Maryland	2000	—	90	—	—	10	2278	30
4.694	16	Delaware	2000	—	74	—	—	26	2185	30
4.694	16	Delaware	2000	—	58	—	—	42	962	30
4.694	16	Delaware	2000	—	84	—	—	16	2956	30
4.694	16	New Jersey	2000	—	79	—	—	21	1859	30
4.694	20	Delaware	2000	—	84	—	—	16	3864	30
4.848	16	Virginia	2000	—	68	—	—	32	2106	30
4.848	16	Virginia	2000	—	85	—	—	15	2676	30
4.848	16	Virginia	2000	—	75	—	—	25	3244	30
4.848	16	Virginia	2000	—	71	—	—	29	1663	30
4.993	16	Pennsylvania	2000	—	75	—	—	25	1991	30
5.094	16	New Jersey	2000	—	86	—	—	14	1260	30
5.5	16	Pennsylvania	2000	—	82	—	—	18	1570	30
5.543	16	Pennsylvania	2000	—	84	—	—	16	1933	30
5.565	16	Pennsylvania	2000	—	77	—	—	23	2262	30
5.565	16	Pennsylvania	2000	—	68	—	—	32	2854	30
5.565	16	New Jersey	2000	—	58	—	—	42	1253	30
5.565	16	New Jersey	2000	—	79	—	—	21	1928	30
5.565	16	New Jersey	2000	—	84	—	—	16	1953	30

Vehicle Pass-By Rates by Land Use

Source: ITE Trip Generation Manual , 11th Edition

Land Use Code	945									
Land Use	Convenience Store/Gas Station									
Setting	General Urban/Suburban									
Time Period	Weekday PM Peak Period									
# Data Sites	12 Sites with between 2 and 8 VFP					28 Sites with between 9 and 20 VFP				
Average Pass-By Rate	56% for Sites with between 2 and 8 VFP					75% for Sites with between 9 and 20 VFP				
Pass-By Characteristics for Individual Sites										
GFA (000)	VFP	State or Province	Survey Year	# Interviews	Pass-By Trip (%)	Non-Pass-By Trips			Adj Street Peak Hour Volume	Source
						Primary (%)	Diverted (%)	Total (%)		
2.1	8	Maryland	1992	31	52	13	35	48	1785	25
2.1	6	Maryland	1992	30	53	20	27	47	1060	25
2.2	< 8	Indiana	1993	115	48	16	36	52	820	2
2.3	< 8	Kentucky	1993	67	57	16	27	43	1954	2
2.3	6	Maryland	1992	55	40	11	49	60	2760	25
2.4	< 8	Kentucky	1993	—	58	13	29	42	2655	2
2.6	< 8	Kentucky	1993	68	67	15	18	33	950	2
2.8	< 8	Kentucky	1993	—	62	11	27	38	2875	2
3	< 8	Indiana	1993	80	65	15	20	35	1165	2
3.6	< 8	Kentucky	1993	60	56	17	27	44	2505	2
3.7	< 8	Kentucky	1993	70	61	16	23	39	2175	2
4.2	< 8	Kentucky	1993	61	58	26	16	42	2300	2
4.694	12	Maryland	2000	—	78	—	—	22	3549	30
4.694	12	Maryland	2000	—	67	—	—	33	2272	30
4.694	12	Maryland	2000	—	66	—	—	34	3514	30
4.848	12	Virginia	2000	—	71	—	—	29	2350	30
5.06	12	Pennsylvania	2000	—	91	—	—	9	4181	30
5.242	12	Virginia	2000	—	70	—	—	30	2445	30
5.242	12	Virginia	2000	—	56	—	—	44	950	30
5.488	12	Delaware	2000	—	73	—	—	27	—	30
5.5	12	Pennsylvania	2000	—	84	—	—	16	4025	30
4.694	16	Maryland	2000	—	89	—	—	11	2755	30
4.694	16	Delaware	2000	—	73	—	—	27	1858	30
4.694	16	Delaware	2000	—	59	—	—	41	1344	30
4.694	16	Delaware	2000	—	72	—	—	28	3434	30
4.694	16	New Jersey	2000	—	81	—	—	19	1734	30
4.694	20	Delaware	2000	—	76	—	—	24	1616	30
4.848	16	Virginia	2000	—	67	—	—	33	2,954	30
4.848	16	Virginia	2000	—	78	—	—	22	3086	30
4.848	16	Virginia	2000	—	83	—	—	17	4143	30
4.848	16	Virginia	2000	—	73	—	—	27	2534	30
4.993	16	Pennsylvania	2000	—	72	—	—	28	2917	30
5.094	16	New Jersey	2000	—	86	—	—	14	1730	30
5.5	16	Pennsylvania	2000	—	90	—	—	10	2616	30
5.543	16	Pennsylvania	2000	—	87	—	—	13	2363	30
5.565	16	Pennsylvania	2000	—	81	—	—	19	2770	30
5.565	16	Pennsylvania	2000	—	76	—	—	24	3362	30
5.565	16	New Jersey	2000	—	61	—	—	39	1713	30
5.565	16	New Jersey	2000	—	86	—	—	14	1721	30
5.565	16	New Jersey	2000	—	81	—	—	19	2227	30

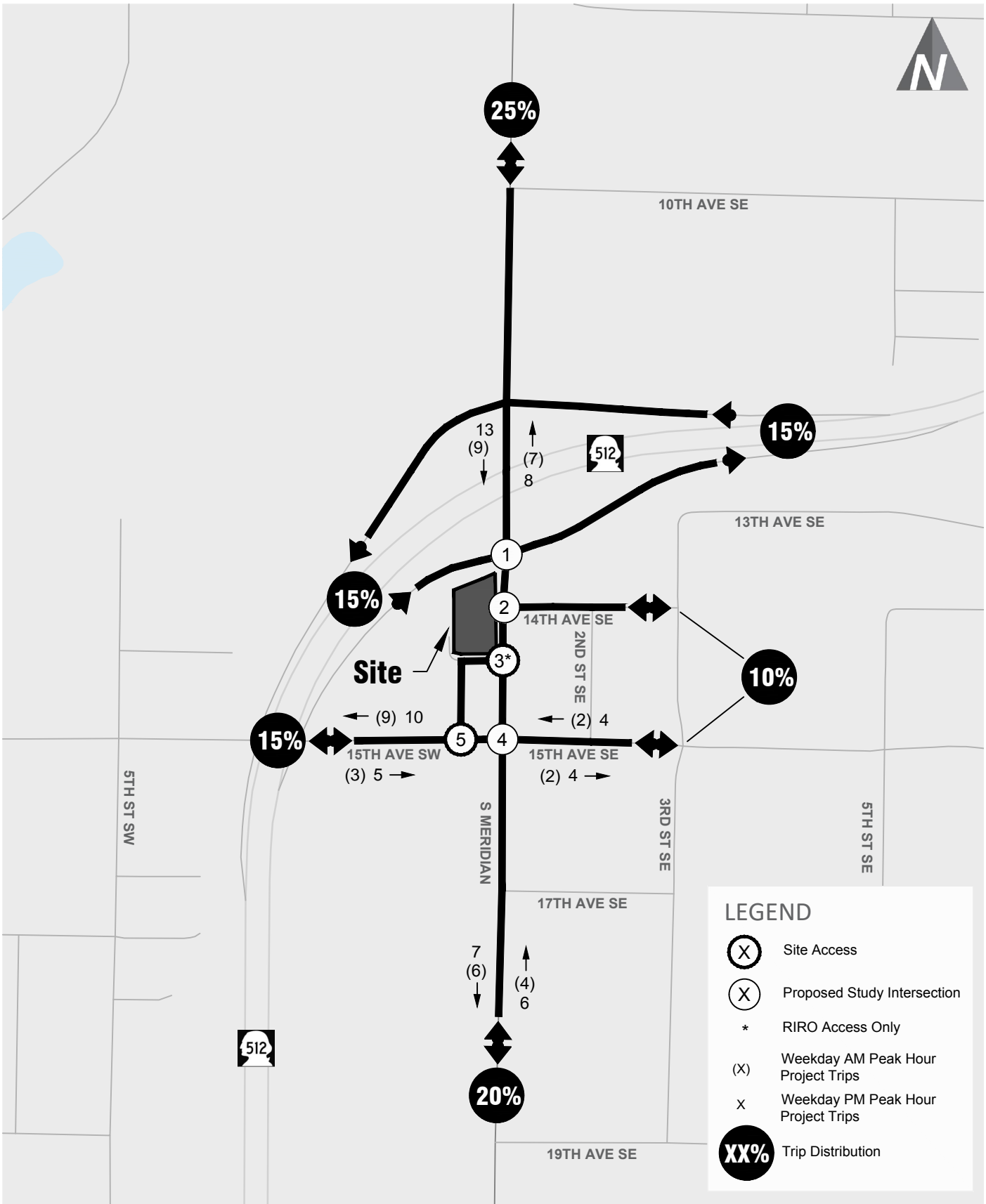

Project Trip Distribution and Assignment

Puyallup ARCO



Appendix B: Traffic Counts

S Meridian SR 512 EB Ramps



Date: 02/22/2023
 Count Period: 4:00 PM to 6:00 PM
 Peak Hour: 4:15 PM to 5:15 PM

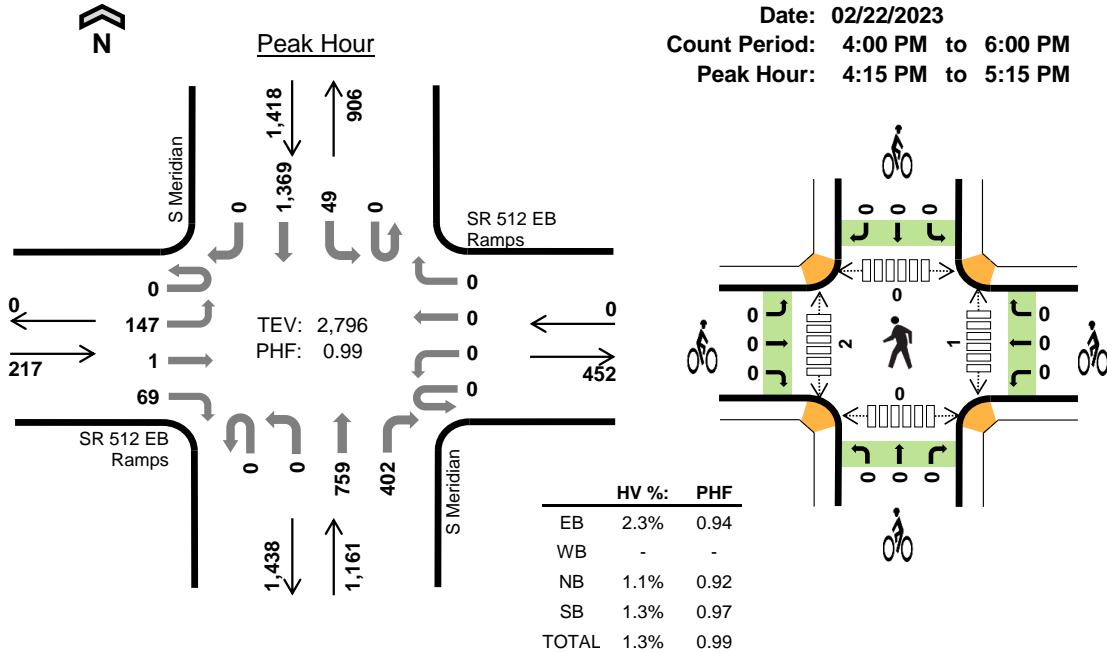

Two-Hour Count Summaries

Interval Start	SR 512 EB Ramps				SR 512 EB Ramps				S Meridian				S Meridian				15-min Total	Rolling One Hour
	Eastbound				Westbound				Northbound				Southbound					
	UT	LT	TH	RT	UT	LT	TH	RT	UT	LT	TH	RT	UT	LT	TH	RT		
4:00 PM	0	23	1	17	0	0	0	0	0	0	231	105	0	13	279	0	669	0
4:15 PM	0	43	1	14	0	0	0	0	0	0	182	90	0	8	357	0	695	0
4:30 PM	0	35	0	17	0	0	0	0	0	0	197	94	0	14	346	0	703	0
4:45 PM	0	31	0	24	0	0	0	0	0	0	180	104	0	15	349	0	703	2,770
5:00 PM	0	38	0	14	0	0	0	0	0	0	200	114	0	12	317	0	695	2,796
5:15 PM	0	36	0	18	0	0	0	0	0	0	182	89	0	12	303	0	640	2,741
5:30 PM	0	23	0	16	0	0	0	0	0	0	168	59	0	10	327	0	603	2,641
5:45 PM	0	32	2	19	0	0	0	0	0	0	132	59	0	12	311	0	567	2,505
Count Total	0	261	4	139	0	0	0	0	0	0	1,472	714	0	96	2,589	0	5,275	0
Peak Hour	All	0	147	1	69	0	0	0	0	0	759	402	0	49	1,369	0	2,796	0
	HV	0	2	0	3	0	0	0	0	0	7	6	0	1	18	0	37	0
	HV%	-	1%	0%	4%	-	-	-	-	-	-	1%	1%	-	2%	1%	-	1%

Note: Two-hour count summary volumes include heavy vehicles but exclude bicycles in overall count.

Interval Start	Heavy Vehicle Totals					Bicycles					Pedestrians (Crossing Leg)				
	EB	WB	NB	SB	Total	EB	WB	NB	SB	Total	East	West	North	South	Total
4:00 PM	0	0	2	4	6	0	0	0	0	0	1	0	0	0	1
4:15 PM	0	0	4	6	10	0	0	0	0	0	1	0	0	0	1
4:30 PM	1	0	4	3	8	0	0	0	0	0	0	0	0	0	0
4:45 PM	3	0	4	7	14	0	0	0	0	0	0	1	0	0	1
5:00 PM	1	0	1	3	5	0	0	0	0	0	0	1	0	0	1
5:15 PM	0	0	2	5	7	0	0	0	0	0	1	3	0	0	4
5:30 PM	0	0	5	4	9	0	0	0	0	0	0	0	0	0	0
5:45 PM	2	0	1	3	6	0	0	0	0	0	0	0	0	0	0
Count Total	7	0	23	35	65	0	0	0	0	0	3	5	0	0	8
Peak Hour	5	0	13	19	37	0	0	0	0	0	1	2	0	0	3

Two-Hour Count Summaries - Heavy Vehicles																		
Interval Start	SR 512 EB Ramps				SR 512 EB Ramps				S Meridian				S Meridian				15-min Total	Rolling One Hour
	Eastbound				Westbound				Northbound				Southbound					
	UT	LT	TH	RT	UT	LT	TH	RT	UT	LT	TH	RT	UT	LT	TH	RT		
4:00 PM	0	0	0	0	0	0	0	0	0	0	2	0	0	0	4	0	6	0
4:15 PM	0	0	0	0	0	0	0	0	0	0	2	2	0	0	6	0	10	0
4:30 PM	0	1	0	0	0	0	0	0	0	0	2	2	0	0	3	0	8	0
4:45 PM	0	1	0	2	0	0	0	0	0	0	3	1	0	0	7	0	14	38
5:00 PM	0	0	0	1	0	0	0	0	0	0	0	1	0	1	2	0	5	37
5:15 PM	0	0	0	0	0	0	0	0	0	0	2	0	0	0	5	0	7	34
5:30 PM	0	0	0	0	0	0	0	0	0	0	3	2	0	0	4	0	9	35
5:45 PM	0	2	0	0	0	0	0	0	0	0	1	0	0	0	3	0	6	27
Count Total	0	4	0	3	0	0	0	0	0	0	15	8	0	1	34	0	65	0
Peak Hour	0	2	0	3	0	0	0	0	0	0	7	6	0	1	18	0	37	0

Two-Hour Count Summaries - Bikes																		
Interval Start	SR 512 EB Ramps			SR 512 EB Ramps			S Meridian			S Meridian			15-min Total	Rolling One Hour				
	Eastbound			Westbound			Northbound			Southbound								
	LT	TH	RT	LT	TH	RT	LT	TH	RT	LT	TH	RT						
4:00 PM	0	0	0	0	0	0	0	0	0	0	0	0	0	0	0	0	0	0
4:15 PM	0	0	0	0	0	0	0	0	0	0	0	0	0	0	0	0	0	0
4:30 PM	0	0	0	0	0	0	0	0	0	0	0	0	0	0	0	0	0	0
4:45 PM	0	0	0	0	0	0	0	0	0	0	0	0	0	0	0	0	0	0
5:00 PM	0	0	0	0	0	0	0	0	0	0	0	0	0	0	0	0	0	0
5:15 PM	0	0	0	0	0	0	0	0	0	0	0	0	0	0	0	0	0	0
5:30 PM	0	0	0	0	0	0	0	0	0	0	0	0	0	0	0	0	0	0
5:45 PM	0	0	0	0	0	0	0	0	0	0	0	0	0	0	0	0	0	0
Count Total	0	0	0	0	0	0	0	0	0	0	0	0	0	0	0	0	0	0
Peak Hour	0	0	0	0	0	0	0	0	0	0	0	0	0	0	0	0	0	0

Note: U-Turn volumes for bikes are included in Left-Turn, if any.

S Meridian 14th Ave SE



Peak Hour

Date: 02/22/2023
 Count Period: 4:00 PM to 6:00 PM
 Peak Hour: 4:15 PM to 5:15 PM

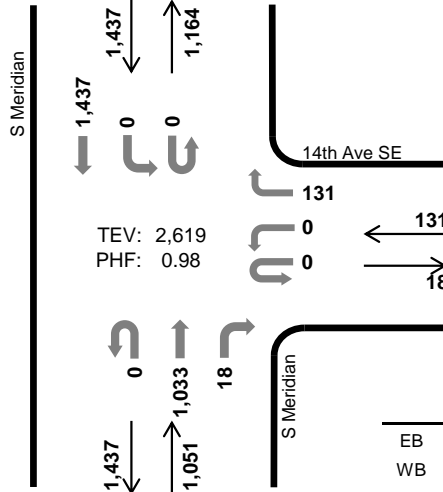

TEV: 2,619
 PHF: 0.98

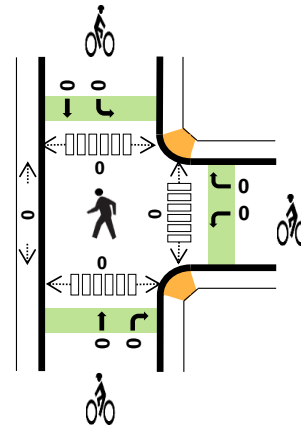

	HV %:	PHF
EB	-	-
WB	3.8%	0.91
NB	0.7%	0.92
SB	1.5%	0.96
TOTAL	1.3%	0.98

Two-Hour Count Summaries

Interval Start	0				14th Ave SE				S Meridian				S Meridian				15-min Total	Rolling One Hour	
	Eastbound				Westbound				Northbound				Southbound						
	UT	LT	TH	RT	UT	LT	TH	RT	UT	LT	TH	RT	UT	LT	TH	RT			
4:00 PM	0	0	0	0	0	0	0	38	0	0	300	2	0	0	309	0	649	0	
4:15 PM	0	0	0	0	0	0	0	36	0	0	238	5	0	0	360	0	639	0	
4:30 PM	0	0	0	0	0	0	0	34	0	0	257	6	0	0	373	0	670	0	
4:45 PM	0	0	0	0	0	0	0	27	0	0	256	4	0	0	365	0	652	2,610	
5:00 PM	0	0	0	0	0	0	0	34	0	0	282	3	0	0	339	0	658	2,619	
5:15 PM	0	0	0	0	0	0	0	34	0	0	236	1	0	0	314	0	585	2,565	
5:30 PM	0	0	0	0	0	0	0	29	0	0	194	4	0	0	338	0	565	2,460	
5:45 PM	0	0	0	0	0	0	0	22	0	0	170	4	0	0	332	0	528	2,336	
Count Total	0	0	0	0	0	0	0	254	0	0	1,933	29	0	0	2,730	0	4,946	0	
Peak Hour	All	0	0	0	0	0	0	0	131	0	0	1,033	18	0	0	1,437	0	2,619	0
	HV	0	0	0	0	0	0	0	5	0	0	7	0	0	0	22	0	34	0
	HV%	-	-	-	-	-	-	-	4%	-	-	1%	0%	-	-	2%	-	1%	0

Note: Two-hour count summary volumes include heavy vehicles but exclude bicycles in overall count.

Interval Start	Heavy Vehicle Totals					Bicycles					Pedestrians (Crossing Leg)				
	EB	WB	NB	SB	Total	EB	WB	NB	SB	Total	East	West	North	South	Total
4:00 PM	0	0	2	3	5	0	0	0	0	0	1	0	0	0	1
4:15 PM	0	2	2	8	12	0	0	0	0	0	0	0	0	0	0
4:30 PM	0	2	1	4	7	0	0	0	0	0	0	0	0	0	0
4:45 PM	0	1	3	7	11	0	0	0	0	0	0	0	0	0	0
5:00 PM	0	0	1	3	4	0	0	0	0	0	0	0	0	0	0
5:15 PM	0	0	1	6	7	0	0	0	0	0	1	0	0	0	1
5:30 PM	0	0	4	6	10	0	0	0	0	0	0	0	0	0	0
5:45 PM	0	1	0	3	4	0	0	0	0	0	0	0	0	0	0
Count Total	0	6	14	40	60	0	0	0	0	0	2	0	0	0	2
Peak Hr	0	5	7	22	34	0	0	0	0	0	0	0	0	0	0

Two-Hour Count Summaries - Heavy Vehicles														15-min Total	Rolling One Hour			
Interval Start	0				14th Ave SE				S Meridian				S Meridian					
	Eastbound				Westbound				Northbound				Southbound					
	UT	LT	TH	RT	UT	LT	TH	RT	UT	LT	TH	RT	UT	LT	TH	RT		
4:00 PM	0	0	0	0	0	0	0	0	0	0	2	0	0	0	3	0		
4:15 PM	0	0	0	0	0	0	0	2	0	0	2	0	0	0	8	0		
4:30 PM	0	0	0	0	0	0	0	2	0	0	1	0	0	0	4	0		
4:45 PM	0	0	0	0	0	0	0	1	0	0	3	0	0	0	7	0		
5:00 PM	0	0	0	0	0	0	0	0	0	0	1	0	0	0	3	0		
5:15 PM	0	0	0	0	0	0	0	0	0	0	1	0	0	0	6	0		
5:30 PM	0	0	0	0	0	0	0	0	0	0	4	0	0	0	6	0		
5:45 PM	0	0	0	0	0	0	0	1	0	0	0	0	0	0	3	0		
Count Total	0	0	0	0	0	0	0	6	0	0	14	0	0	0	40	0		
Peak Hour	0	0	0	0	0	0	0	5	0	0	7	0	0	0	22	0		

Two-Hour Count Summaries - Bikes														15-min Total	Rolling One Hour
Interval Start	0			14th Ave SE			S Meridian			S Meridian					
	Eastbound			Westbound			Northbound			Southbound					
	LT	TH	RT	LT	TH	RT	LT	TH	RT	LT	TH	RT			
4:00 PM	0	0	0	0	0	0	0	0	0	0	0	0			
4:15 PM	0	0	0	0	0	0	0	0	0	0	0	0			
4:30 PM	0	0	0	0	0	0	0	0	0	0	0	0			
4:45 PM	0	0	0	0	0	0	0	0	0	0	0	0			
5:00 PM	0	0	0	0	0	0	0	0	0	0	0	0			
5:15 PM	0	0	0	0	0	0	0	0	0	0	0	0			
5:30 PM	0	0	0	0	0	0	0	0	0	0	0	0			
5:45 PM	0	0	0	0	0	0	0	0	0	0	0	0			
Count Total	0	0	0	0	0	0	0	0	0	0	0	0			
Peak Hour	0	0	0	0	0	0	0	0	0	0	0	0			

Note: U-Turn volumes for bikes are included in Left-Turn, if any.

S Meridian Hotel Driveways



Peak Hour

Date: 02/22/2023
Count Period: 7:00 AM to 9:00 AM
Peak Hour: 7:30 AM to 8:30 AM

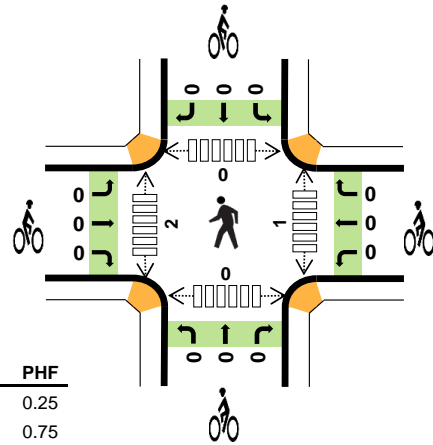
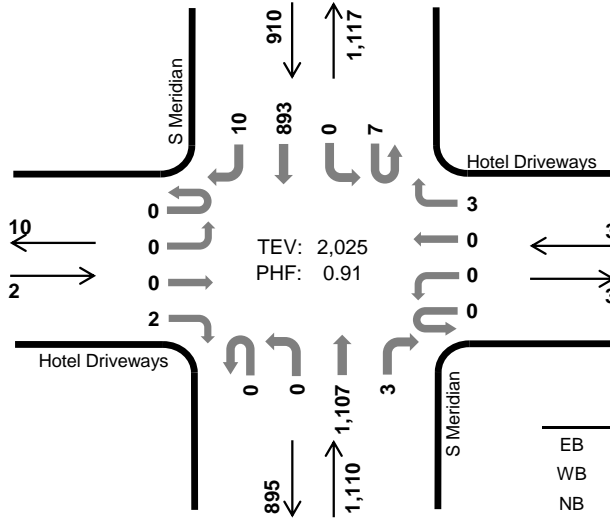

	HV %:	PHF
EB	0.0%	0.25
WB	0.0%	0.75
NB	1.9%	0.91
SB	2.9%	0.91
TOTAL	2.3%	0.91

Two-Hour Count Summaries

Interval Start	Hotel Driveways				Hotel Driveways				S Meridian				S Meridian				15-min Total	Rolling One Hour	
	Eastbound		Westbound		Northbound		Southbound		Northbound		Southbound		Southbound						
	UT	LT	TH	RT	UT	LT	TH	RT	UT	LT	TH	RT	UT	LT	TH	RT			
7:00 AM	0	0	0	0	0	0	0	1	0	0	320	0	1	0	158	2	482	0	
7:15 AM	0	0	0	0	0	0	0	0	0	0	277	0	1	0	156	1	435	0	
7:30 AM	0	0	0	0	0	0	0	1	0	0	304	2	0	0	226	2	535	0	
7:45 AM	0	0	0	2	0	0	0	1	0	0	303	1	5	0	242	3	557	2,009	
8:00 AM	0	0	0	0	0	0	0	0	0	0	254	0	2	0	198	1	455	1,982	
8:15 AM	0	0	0	0	0	0	0	1	0	0	246	0	0	0	227	4	478	2,025	
8:30 AM	0	0	0	0	0	0	0	4	0	0	205	0	3	0	246	1	459	1,949	
8:45 AM	0	0	0	0	0	0	0	1	0	0	192	0	1	0	208	4	406	1,798	
Count Total	0	0	0	2	0	0	0	9	0	0	2,101	3	13	0	1,661	18	3,807	0	
Peak Hour	All	0	0	0	2	0	0	0	3	0	0	1,107	3	7	0	893	10	2,025	0
	HV	0	0	0	0	0	0	0	0	0	0	21	0	0	0	25	1	47	0
	HV%	-	-	-	0%	-	-	-	0%	-	-	2%	0%	0%	-	3%	10%	2%	0

Note: Two-hour count summary volumes include heavy vehicles but exclude bicycles in overall count.

Interval Start	Heavy Vehicle Totals					Bicycles					Pedestrians (Crossing Leg)				
	EB	WB	NB	SB	Total	EB	WB	NB	SB	Total	East	West	North	South	Total
7:00 AM	0	0	6	3	9	0	0	0	0	0	0	0	0	0	0
7:15 AM	0	0	9	3	12	0	0	0	0	0	0	0	0	0	0
7:30 AM	0	0	5	7	12	0	0	0	0	0	1	0	0	0	1
7:45 AM	0	0	5	9	14	0	0	0	0	0	0	1	0	0	1
8:00 AM	0	0	9	7	16	0	0	0	0	0	0	1	0	0	1
8:15 AM	0	0	2	3	5	0	0	0	0	0	0	0	0	0	0
8:30 AM	0	0	3	3	6	0	0	0	0	0	0	0	0	0	0
8:45 AM	0	0	6	6	12	0	0	0	0	0	3	2	0	0	5
Count Total	0	0	45	41	86	0	0	0	0	0	4	4	0	0	8
Peak Hour	0	0	21	26	47	0	0	0	0	0	1	2	0	0	3

Two-Hour Count Summaries - Heavy Vehicles																		
Interval Start	Hotel Driveways				Hotel Driveways				S Meridian				S Meridian				15-min Total	Rolling One Hour
	Eastbound				Westbound				Northbound				Southbound					
	UT	LT	TH	RT	UT	LT	TH	RT	UT	LT	TH	RT	UT	LT	TH	RT		
7:00 AM	0	0	0	0	0	0	0	0	0	0	6	0	0	0	3	0	9	0
7:15 AM	0	0	0	0	0	0	0	0	0	0	9	0	0	0	3	0	12	0
7:30 AM	0	0	0	0	0	0	0	0	0	0	5	0	0	0	7	0	12	0
7:45 AM	0	0	0	0	0	0	0	0	0	0	5	0	0	0	9	0	14	47
8:00 AM	0	0	0	0	0	0	0	0	0	0	9	0	0	0	7	0	16	54
8:15 AM	0	0	0	0	0	0	0	0	0	0	2	0	0	0	2	1	5	47
8:30 AM	0	0	0	0	0	0	0	0	0	0	3	0	0	0	3	0	6	41
8:45 AM	0	0	0	0	0	0	0	0	0	0	6	0	0	0	6	0	12	39
Count Total	0	0	0	0	0	0	0	0	0	0	45	0	0	0	40	1	86	0
Peak Hour	0	0	0	0	0	0	0	0	0	0	21	0	0	0	25	1	47	0

Two-Hour Count Summaries - Bikes																	
Interval Start	Hotel Driveways			Hotel Driveways			S Meridian			S Meridian			15-min Total	Rolling One Hour			
	Eastbound			Westbound			Northbound			Southbound							
	LT	TH	RT	LT	TH	RT	LT	TH	RT	LT	TH	RT					
7:00 AM	0	0	0	0	0	0	0	0	0	0	0	0	0	0	0	0	0
7:15 AM	0	0	0	0	0	0	0	0	0	0	0	0	0	0	0	0	0
7:30 AM	0	0	0	0	0	0	0	0	0	0	0	0	0	0	0	0	0
7:45 AM	0	0	0	0	0	0	0	0	0	0	0	0	0	0	0	0	0
8:00 AM	0	0	0	0	0	0	0	0	0	0	0	0	0	0	0	0	0
8:15 AM	0	0	0	0	0	0	0	0	0	0	0	0	0	0	0	0	0
8:30 AM	0	0	0	0	0	0	0	0	0	0	0	0	0	0	0	0	0
8:45 AM	0	0	0	0	0	0	0	0	0	0	0	0	0	0	0	0	0
Count Total	0	0	0	0	0	0	0	0	0	0	0	0	0	0	0	0	0
Peak Hour	0	0	0	0	0	0	0	0	0	0	0	0	0	0	0	0	0

Note: U-Turn volumes for bikes are included in Left-Turn, if any.

S Meridian Hotel Driveways



Date: 02/22/2023
 Count Period: 4:00 PM to 6:00 PM
 Peak Hour: 4:00 PM to 5:00 PM

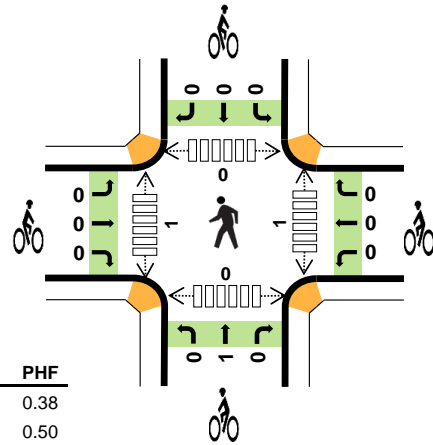
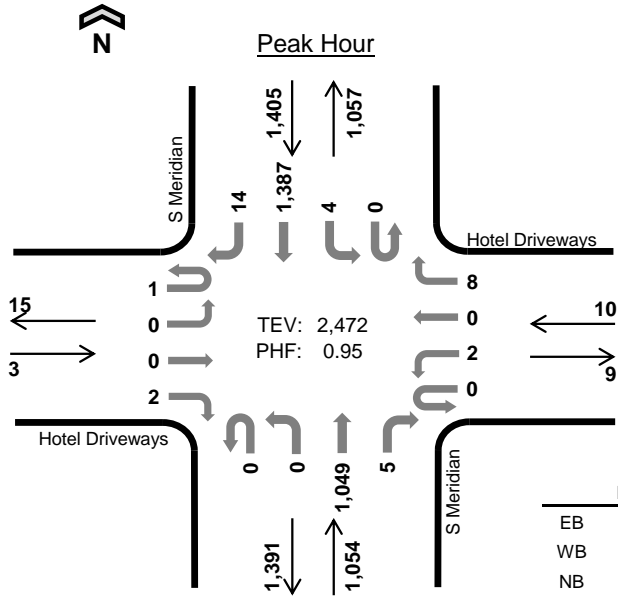

	HV %:	PHF
EB	0.0%	0.38
WB	0.0%	0.50
NB	1.0%	0.87
SB	1.7%	0.95
TOTAL	1.4%	0.95

Two-Hour Count Summaries

Interval Start	Hotel Driveways				Hotel Driveways				S Meridian				S Meridian				15-min Total	Rolling One Hour	
	Eastbound		Westbound		Northbound		Southbound		UT	LT	TH	RT	UT	LT	TH	RT			
4:00 PM	1	0	0	0	0	0	0	1	0	0	301	1	0	2	312	3	621	0	
4:15 PM	0	0	0	0	0	1	0	2	0	0	225	1	0	1	344	4	578	0	
4:30 PM	0	0	0	2	0	0	0	1	0	0	273	1	0	1	368	2	648	0	
4:45 PM	0	0	0	0	0	1	0	4	0	0	250	2	0	0	363	5	625	2,472	
5:00 PM	0	0	0	0	0	1	0	0	0	0	282	2	0	0	334	0	619	2,470	
5:15 PM	0	0	0	0	0	0	0	1	0	0	243	0	0	0	304	1	549	2,441	
5:30 PM	0	0	0	0	0	0	0	1	0	0	206	0	0	1	345	4	557	2,350	
5:45 PM	0	0	0	0	0	0	0	0	0	0	174	0	0	0	339	0	513	2,238	
Count Total	1	0	0	2	0	3	0	10	0	0	1,954	7	0	5	2,709	19	4,710	0	
Peak Hour	All	1	0	0	2	0	2	0	8	0	0	1,049	5	0	4	1,387	14	2,472	0
	HV	0	0	0	0	0	0	0	0	0	0	11	0	0	0	24	0	35	0
	HV%	0%	-	-	0%	-	0%	-	0%	-	-	1%	0%	-	0%	2%	0%	1%	0

Note: Two-hour count summary volumes include heavy vehicles but exclude bicycles in overall count.

Interval Start	Heavy Vehicle Totals					Bicycles					Pedestrians (Crossing Leg)				
	EB	WB	NB	SB	Total	EB	WB	NB	SB	Total	East	West	North	South	Total
4:00 PM	0	0	3	4	7	0	0	0	0	0	0	0	0	0	0
4:15 PM	0	0	2	8	10	0	0	1	0	1	1	0	0	0	1
4:30 PM	0	0	2	4	6	0	0	0	0	0	0	0	0	0	0
4:45 PM	0	0	4	8	12	0	0	0	0	0	0	1	0	0	1
5:00 PM	0	0	1	3	4	0	0	0	0	0	0	1	0	0	1
5:15 PM	0	0	0	3	3	0	0	0	0	0	0	3	0	0	3
5:30 PM	0	0	4	7	11	0	0	0	0	0	0	0	0	0	0
5:45 PM	0	0	0	3	3	0	0	0	0	0	1	1	0	0	2
Count Total	0	0	16	40	56	0	0	1	0	1	2	6	0	0	8
Peak Hour	0	0	11	24	35	0	0	1	0	1	1	1	0	0	2

Two-Hour Count Summaries - Heavy Vehicles																		
Interval Start	Hotel Driveways				Hotel Driveways				S Meridian				S Meridian				15-min Total	Rolling One Hour
	Eastbound				Westbound				Northbound				Southbound					
	UT	LT	TH	RT	UT	LT	TH	RT	UT	LT	TH	RT	UT	LT	TH	RT		
4:00 PM	0	0	0	0	0	0	0	0	0	0	3	0	0	0	4	0	7	0
4:15 PM	0	0	0	0	0	0	0	0	0	0	2	0	0	0	8	0	10	0
4:30 PM	0	0	0	0	0	0	0	0	0	0	2	0	0	0	4	0	6	0
4:45 PM	0	0	0	0	0	0	0	0	0	0	4	0	0	0	8	0	12	35
5:00 PM	0	0	0	0	0	0	0	0	0	0	1	0	0	0	3	0	4	32
5:15 PM	0	0	0	0	0	0	0	0	0	0	0	0	0	0	3	0	3	25
5:30 PM	0	0	0	0	0	0	0	0	0	0	4	0	0	0	7	0	11	30
5:45 PM	0	0	0	0	0	0	0	0	0	0	0	0	0	0	3	0	3	21
Count Total	0	0	0	0	0	0	0	0	0	0	16	0	0	0	40	0	56	0
Peak Hour	0	0	0	0	0	0	0	0	0	0	11	0	0	0	24	0	35	0

Two-Hour Count Summaries - Bikes																	
Interval Start	Hotel Driveways			Hotel Driveways			S Meridian			S Meridian			15-min Total	Rolling One Hour			
	Eastbound			Westbound			Northbound			Southbound							
	LT	TH	RT	LT	TH	RT	LT	TH	RT	LT	TH	RT					
4:00 PM	0	0	0	0	0	0	0	0	0	0	0	0	0	0	0	0	0
4:15 PM	0	0	0	0	0	0	0	0	1	0	0	0	0	0	0	1	0
4:30 PM	0	0	0	0	0	0	0	0	0	0	0	0	0	0	0	0	0
4:45 PM	0	0	0	0	0	0	0	0	0	0	0	0	0	0	0	0	1
5:00 PM	0	0	0	0	0	0	0	0	0	0	0	0	0	0	0	0	1
5:15 PM	0	0	0	0	0	0	0	0	0	0	0	0	0	0	0	0	0
5:30 PM	0	0	0	0	0	0	0	0	0	0	0	0	0	0	0	0	0
5:45 PM	0	0	0	0	0	0	0	0	0	0	0	0	0	0	0	0	0
Count Total	0	0	0	0	0	0	0	0	1	0	0	0	0	0	0	1	0
Peak Hour	0	0	0	0	0	0	0	0	1	0	0	0	0	0	0	1	0

Note: U-Turn volumes for bikes are included in Left-Turn, if any.

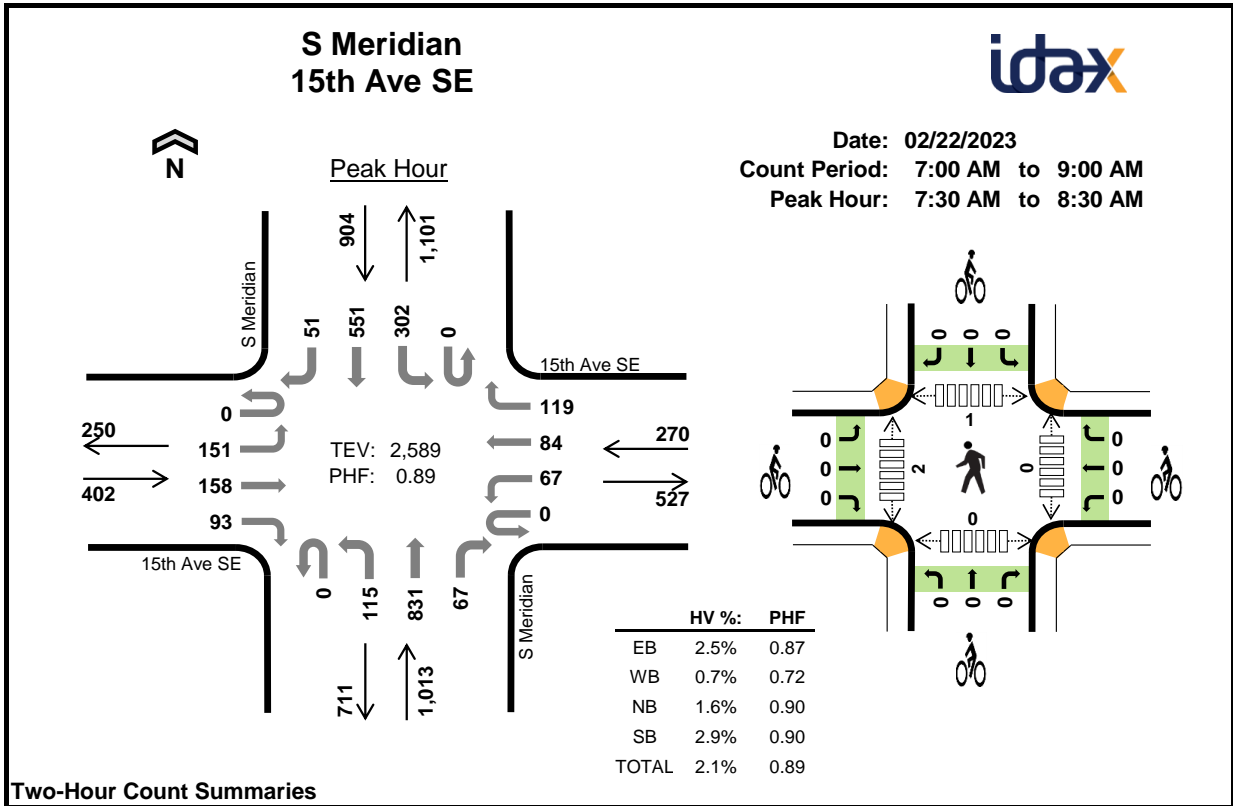

Two-Hour Count Summaries

Interval Start	15th Ave SE				15th Ave SE				S Meridian				S Meridian				15-min Total	Rolling One Hour	
	Eastbound		Westbound		Northbound		Southbound		Northbound		Southbound								
	UT	LT	TH	RT	UT	LT	TH	RT	UT	LT	TH	RT	UT	LT	TH	RT			
7:00 AM	0	39	16	9	0	10	13	17	0	20	250	8	0	57	89	9	537	0	
7:15 AM	0	44	19	19	0	8	4	15	0	15	218	9	0	60	83	10	504	0	
7:30 AM	0	45	49	16	0	31	28	35	0	24	220	16	0	75	130	13	682	0	
7:45 AM	0	41	52	23	0	14	32	34	0	39	226	15	0	70	163	17	726	2,449	
8:00 AM	0	36	30	29	0	11	18	26	0	33	195	17	0	73	123	8	599	2,511	
8:15 AM	0	29	27	25	0	11	6	24	0	19	190	19	0	84	135	13	582	2,589	
8:30 AM	0	31	23	21	0	9	9	28	0	24	155	27	0	81	154	11	573	2,480	
8:45 AM	0	22	24	29	0	12	16	30	0	22	152	15	0	67	121	15	525	2,279	
Count Total	0	287	240	171	0	106	126	209	0	196	1,606	126	0	567	998	96	4,728	0	
Peak Hour	All	0	151	158	93	0	67	84	119	0	115	831	67	0	302	551	51	2,589	0
	HV	0	2	3	5	0	1	0	1	0	4	12	0	0	4	20	2	54	0
	HV%	-	1%	2%	5%	-	1%	0%	1%	-	3%	1%	0%	-	1%	4%	4%	2%	0

Note: Two-hour count summary volumes include heavy vehicles but exclude bicycles in overall count.

Interval Start	Heavy Vehicle Totals					Bicycles					Pedestrians (Crossing Leg)				
	EB	WB	NB	SB	Total	EB	WB	NB	SB	Total	East	West	North	South	Total
7:00 AM	4	0	5	4	13	0	0	0	0	0	0	0	0	0	0
7:15 AM	5	1	8	3	17	0	0	0	0	0	0	0	0	0	0
7:30 AM	1	2	3	6	12	0	0	0	0	0	0	0	1	0	1
7:45 AM	4	0	5	9	18	0	0	0	0	0	0	2	0	0	2
8:00 AM	2	0	7	8	17	0	0	0	0	0	0	0	0	0	0
8:15 AM	3	0	1	3	7	0	0	0	0	0	0	0	0	0	0
8:30 AM	2	1	4	4	11	0	0	0	0	0	0	0	0	0	0
8:45 AM	0	2	4	5	11	0	0	0	0	0	0	1	2	0	3
Count Total	21	6	37	42	106	0	0	0	0	0	0	3	3	0	6
Peak Hour	10	2	16	26	54	0	0	0	0	0	0	2	1	0	3

Two-Hour Count Summaries - Heavy Vehicles																		
Interval Start	15th Ave SE				15th Ave SE				S Meridian				S Meridian				15-min Total	Rolling One Hour
	Eastbound				Westbound				Northbound				Southbound					
	UT	LT	TH	RT	UT	LT	TH	RT	UT	LT	TH	RT	UT	LT	TH	RT		
7:00 AM	0	1	0	3	0	0	0	0	0	1	4	0	0	0	3	1	13	0
7:15 AM	0	2	0	3	0	1	0	0	0	2	6	0	0	0	3	0	17	0
7:30 AM	0	1	0	0	0	1	0	1	0	0	3	0	0	0	6	0	12	0
7:45 AM	0	0	1	3	0	0	0	0	0	2	3	0	0	1	6	2	18	60
8:00 AM	0	0	1	1	0	0	0	0	0	1	6	0	0	3	5	0	17	64
8:15 AM	0	1	1	1	0	0	0	0	0	1	0	0	0	0	3	0	7	54
8:30 AM	0	0	0	2	0	0	0	1	0	2	2	0	0	1	2	1	11	53
8:45 AM	0	0	0	0	0	0	0	2	0	0	3	1	0	0	3	2	11	46
Count Total	0	5	3	13	0	2	0	4	0	9	27	1	0	5	31	6	106	0
Peak Hour	0	2	3	5	0	1	0	1	0	4	12	0	0	4	20	2	54	0

Two-Hour Count Summaries - Bikes																		
Interval Start	15th Ave SE			15th Ave SE			S Meridian			S Meridian			15-min Total	Rolling One Hour				
	Eastbound			Westbound			Northbound			Southbound								
	LT	TH	RT	LT	TH	RT	LT	TH	RT	LT	TH	RT						
7:00 AM	0	0	0	0	0	0	0	0	0	0	0	0	0	0	0	0	0	0
7:15 AM	0	0	0	0	0	0	0	0	0	0	0	0	0	0	0	0	0	0
7:30 AM	0	0	0	0	0	0	0	0	0	0	0	0	0	0	0	0	0	0
7:45 AM	0	0	0	0	0	0	0	0	0	0	0	0	0	0	0	0	0	0
8:00 AM	0	0	0	0	0	0	0	0	0	0	0	0	0	0	0	0	0	0
8:15 AM	0	0	0	0	0	0	0	0	0	0	0	0	0	0	0	0	0	0
8:30 AM	0	0	0	0	0	0	0	0	0	0	0	0	0	0	0	0	0	0
8:45 AM	0	0	0	0	0	0	0	0	0	0	0	0	0	0	0	0	0	0
Count Total	0	0	0	0	0	0	0	0	0	0	0	0	0	0	0	0	0	0
Peak Hour	0	0	0	0	0	0	0	0	0	0	0	0	0	0	0	0	0	0

Note: U-Turn volumes for bikes are included in Left-Turn, if any.

S Meridian 15th Ave SE



Date: 02/22/2023
 Count Period: 4:00 PM to 6:00 PM
 Peak Hour: 4:00 PM to 5:00 PM

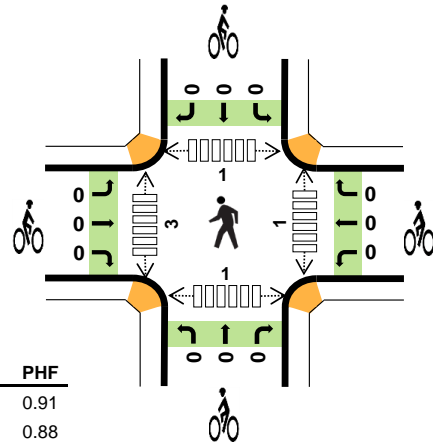
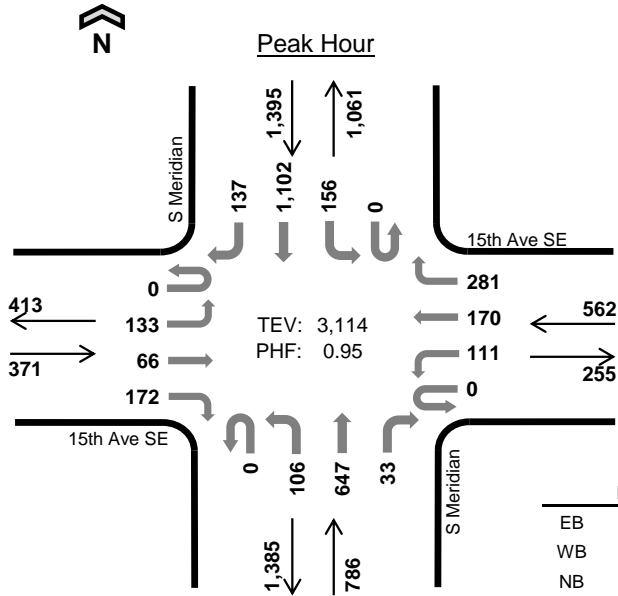

	HV %:	PHF
EB	1.3%	0.91
WB	1.2%	0.88
NB	0.9%	0.83
SB	1.7%	0.92
TOTAL	1.4%	0.95

Two-Hour Count Summaries

Interval Start	15th Ave SE Eastbound				15th Ave SE Westbound				S Meridian Northbound				S Meridian Southbound				15-min Total	Rolling One Hour	
	UT	LT	TH	RT	UT	LT	TH	RT	UT	LT	TH	RT	UT	LT	TH	RT			
4:00 PM	0	47	15	26	0	22	36	68	0	32	196	10	0	35	250	33	770	0	
4:15 PM	0	26	19	54	0	27	40	63	0	30	136	7	0	38	264	36	740	0	
4:30 PM	0	26	16	40	0	30	49	81	0	24	167	9	0	38	299	42	821	0	
4:45 PM	0	34	16	52	0	32	45	69	0	20	148	7	0	45	289	26	783	3,114	
5:00 PM	0	23	12	35	0	21	42	72	0	25	187	4	0	34	265	34	754	3,098	
5:15 PM	0	29	13	44	0	26	41	48	0	28	161	4	0	31	239	30	694	3,052	
5:30 PM	0	21	16	41	0	16	30	42	0	29	143	9	0	38	277	40	702	2,933	
5:45 PM	0	23	16	45	0	20	23	28	0	25	122	8	0	39	262	28	639	2,789	
Count Total	0	229	123	337	0	194	306	471	0	213	1,260	58	0	298	2,145	269	5,903	0	
Peak Hour	All	0	133	66	172	0	111	170	281	0	106	647	33	0	156	1,102	137	3,114	0
	HV	0	2	0	3	0	1	1	5	0	3	4	0	0	6	15	3	43	0
	HV%	-	2%	0%	2%	-	1%	1%	2%	-	3%	1%	0%	-	4%	1%	2%	1%	0

Note: Two-hour count summary volumes include heavy vehicles but exclude bicycles in overall count.

Interval Start	Heavy Vehicle Totals					Bicycles					Pedestrians (Crossing Leg)				
	EB	WB	NB	SB	Total	EB	WB	NB	SB	Total	East	West	North	South	Total
4:00 PM	2	2	1	4	9	0	0	0	0	0	0	0	0	0	0
4:15 PM	0	4	1	6	11	0	0	0	0	0	1	2	1	0	4
4:30 PM	2	0	1	6	9	0	0	0	0	0	0	0	0	1	1
4:45 PM	1	1	4	8	14	0	0	0	0	0	0	1	0	0	1
5:00 PM	0	0	1	3	4	0	0	0	0	0	0	1	0	0	1
5:15 PM	0	1	1	3	5	0	0	0	0	0	0	3	0	0	3
5:30 PM	2	0	6	9	17	0	0	0	0	0	0	0	0	0	0
5:45 PM	2	0	0	3	5	0	0	0	0	0	0	1	1	0	2
Count Total	9	8	15	42	74	0	0	0	0	0	1	8	2	1	12
Peak Hour	5	7	7	24	43	0	0	0	0	0	1	3	1	1	6

Two-Hour Count Summaries - Heavy Vehicles																		
Interval Start	15th Ave SE				15th Ave SE				S Meridian				S Meridian				15-min Total	Rolling One Hour
	Eastbound				Westbound				Northbound				Southbound					
	UT	LT	TH	RT	UT	LT	TH	RT	UT	LT	TH	RT	UT	LT	TH	RT		
4:00 PM	0	1	0	1	0	0	0	2	0	1	0	0	0	3	1	0	9	0
4:15 PM	0	0	0	0	0	1	1	2	0	1	0	0	0	1	4	1	11	0
4:30 PM	0	1	0	1	0	0	0	0	0	0	1	0	0	1	3	2	9	0
4:45 PM	0	0	0	1	0	0	0	1	0	1	3	0	0	1	7	0	14	43
5:00 PM	0	0	0	0	0	0	0	0	0	0	1	0	0	1	2	0	4	38
5:15 PM	0	0	0	0	0	0	1	0	0	0	1	0	0	1	2	0	5	32
5:30 PM	0	1	0	1	0	0	0	0	0	2	3	1	0	3	5	1	17	40
5:45 PM	0	0	0	2	0	0	0	0	0	0	0	0	0	2	1	0	5	31
Count Total	0	3	0	6	0	1	2	5	0	5	9	1	0	13	25	4	74	0
Peak Hour	0	2	0	3	0	1	1	5	0	3	4	0	0	6	15	3	43	0

Two-Hour Count Summaries - Bikes																		
Interval Start	15th Ave SE			15th Ave SE			S Meridian			S Meridian			15-min Total	Rolling One Hour				
	Eastbound			Westbound			Northbound			Southbound								
	LT	TH	RT	LT	TH	RT	LT	TH	RT	LT	TH	RT						
4:00 PM	0	0	0	0	0	0	0	0	0	0	0	0	0	0	0	0	0	0
4:15 PM	0	0	0	0	0	0	0	0	0	0	0	0	0	0	0	0	0	0
4:30 PM	0	0	0	0	0	0	0	0	0	0	0	0	0	0	0	0	0	0
4:45 PM	0	0	0	0	0	0	0	0	0	0	0	0	0	0	0	0	0	0
5:00 PM	0	0	0	0	0	0	0	0	0	0	0	0	0	0	0	0	0	0
5:15 PM	0	0	0	0	0	0	0	0	0	0	0	0	0	0	0	0	0	0
5:30 PM	0	0	0	0	0	0	0	0	0	0	0	0	0	0	0	0	0	0
5:45 PM	0	0	0	0	0	0	0	0	0	0	0	0	0	0	0	0	0	0
Count Total	0	0	0	0	0	0	0	0	0	0	0	0	0	0	0	0	0	0
Peak Hour	0	0	0	0	0	0	0	0	0	0	0	0	0	0	0	0	0	0

Note: U-Turn volumes for bikes are included in Left-Turn, if any.

Chevron Dwy 15th Ave SW



Peak Hour

Date: 02/22/2023
Count Period: 7:00 AM to 9:00 AM
Peak Hour: 7:30 AM to 8:30 AM

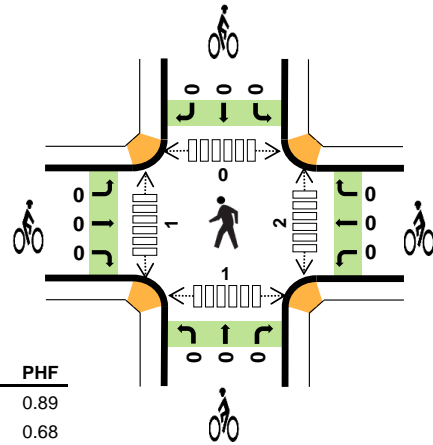
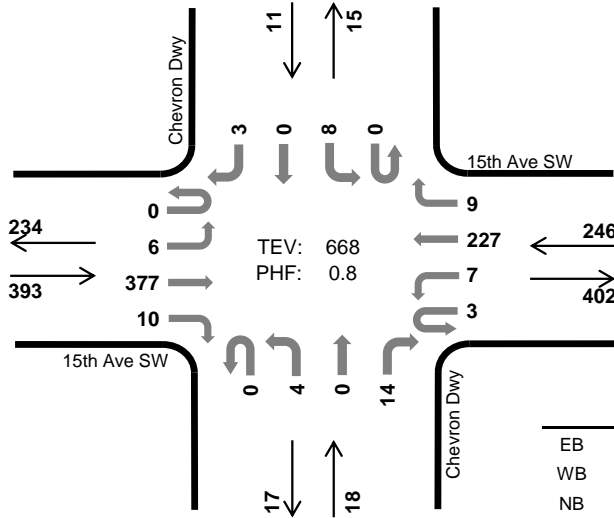

	HV %:	PHF
EB	3.1%	0.89
WB	2.8%	0.68
NB	11.1%	0.75
SB	9.1%	0.55
TOTAL	3.3%	0.80

Two-Hour Count Summaries

Interval Start	15th Ave SW Eastbound				15th Ave SW Westbound				Chevron Dwy Northbound				Chevron Dwy Southbound				15-min Total	Rolling One Hour	
	UT	LT	TH	RT	UT	LT	TH	RT	UT	LT	TH	RT	UT	LT	TH	RT			
7:00 AM	0	0	63	1	0	2	40	0	0	1	0	1	0	0	0	0	108	0	
7:15 AM	0	1	78	5	0	2	26	0	0	2	0	3	0	1	0	0	118	0	
7:30 AM	0	0	97	2	1	1	58	0	0	0	0	6	0	2	0	0	167	0	
7:45 AM	0	0	106	5	2	3	83	3	0	2	0	3	0	1	0	0	208	601	
8:00 AM	0	5	96	2	0	1	56	4	0	1	0	3	0	2	0	1	171	664	
8:15 AM	0	1	78	1	0	2	30	2	0	1	0	2	0	3	0	2	122	668	
8:30 AM	0	1	73	3	0	4	40	2	0	1	0	4	0	1	0	3	132	633	
8:45 AM	0	0	67	0	1	5	47	2	0	0	0	1	0	4	0	1	128	553	
Count Total	0	8	658	19	4	20	380	13	0	8	0	23	0	14	0	7	1,154	0	
Peak Hour	All	0	6	377	10	3	7	227	9	0	4	0	14	0	8	0	3	668	0
	HV	0	0	12	0	0	1	6	0	0	0	0	2	0	0	0	1	22	0
	HV%	-	0%	3%	0%	0%	14%	3%	0%	-	0%	-	14%	-	0%	-	33%	3%	0

Note: Two-hour count summary volumes include heavy vehicles but exclude bicycles in overall count.

Interval Start	Heavy Vehicle Totals					Bicycles					Pedestrians (Crossing Leg)				
	EB	WB	NB	SB	Total	EB	WB	NB	SB	Total	East	West	North	South	Total
7:00 AM	4	2	0	0	6	0	0	0	0	0	0	0	0	0	0
7:15 AM	5	2	0	1	8	0	0	0	0	0	0	1	0	0	1
7:30 AM	1	0	0	0	1	0	0	0	0	0	2	1	0	0	3
7:45 AM	3	4	1	0	8	0	0	0	0	0	0	0	0	1	1
8:00 AM	3	2	1	0	6	0	0	0	0	0	0	0	0	0	0
8:15 AM	5	1	0	1	7	0	0	0	0	0	0	0	0	0	0
8:30 AM	2	2	0	0	4	0	0	0	0	0	0	0	0	0	0
8:45 AM	1	2	0	0	3	0	0	0	0	0	0	0	2	0	2
Count Total	24	15	2	2	43	0	0	0	0	0	2	2	2	1	7
Peak Hour	12	7	2	1	22	0	0	0	0	0	2	1	0	1	4

Two-Hour Count Summaries - Heavy Vehicles																		
Interval Start	15th Ave SW				15th Ave SW				Chevron Dwy				Chevron Dwy				15-min Total	Rolling One Hour
	Eastbound				Westbound				Northbound				Southbound					
	UT	LT	TH	RT	UT	LT	TH	RT	UT	LT	TH	RT	UT	LT	TH	RT		
7:00 AM	0	0	4	0	0	0	2	0	0	0	0	0	0	0	0	0	6	0
7:15 AM	0	0	5	0	0	0	2	0	0	0	0	0	0	0	1	0	0	0
7:30 AM	0	0	1	0	0	0	0	0	0	0	0	0	0	0	0	0	0	1
7:45 AM	0	0	3	0	0	1	3	0	0	0	0	1	0	0	0	0	8	23
8:00 AM	0	0	3	0	0	0	2	0	0	0	0	1	0	0	0	0	6	23
8:15 AM	0	0	5	0	0	0	1	0	0	0	0	0	0	0	0	1	7	22
8:30 AM	0	0	2	0	0	0	2	0	0	0	0	0	0	0	0	0	4	25
8:45 AM	0	0	1	0	0	0	2	0	0	0	0	0	0	0	0	0	3	20
Count Total	0	0	24	0	0	1	14	0	0	0	0	2	0	1	0	1	43	0
Peak Hour	0	0	12	0	0	1	6	0	0	0	0	2	0	0	0	1	22	0

Two-Hour Count Summaries - Bikes																	
Interval Start	15th Ave SW			15th Ave SW			Chevron Dwy			Chevron Dwy			15-min Total	Rolling One Hour			
	Eastbound			Westbound			Northbound			Southbound							
	LT	TH	RT	LT	TH	RT	LT	TH	RT	LT	TH	RT					
7:00 AM	0	0	0	0	0	0	0	0	0	0	0	0	0	0	0	0	0
7:15 AM	0	0	0	0	0	0	0	0	0	0	0	0	0	0	0	0	0
7:30 AM	0	0	0	0	0	0	0	0	0	0	0	0	0	0	0	0	0
7:45 AM	0	0	0	0	0	0	0	0	0	0	0	0	0	0	0	0	0
8:00 AM	0	0	0	0	0	0	0	0	0	0	0	0	0	0	0	0	0
8:15 AM	0	0	0	0	0	0	0	0	0	0	0	0	0	0	0	0	0
8:30 AM	0	0	0	0	0	0	0	0	0	0	0	0	0	0	0	0	0
8:45 AM	0	0	0	0	0	0	0	0	0	0	0	0	0	0	0	0	0
Count Total	0	0	0	0	0	0	0	0	0	0	0	0	0	0	0	0	0
Peak Hour	0	0	0	0	0	0	0	0	0	0	0	0	0	0	0	0	0

Note: U-Turn volumes for bikes are included in Left-Turn, if any.

Chevron Dwy 15th Ave SW



Peak Hour

Date: 02/22/2023
Count Period: 4:00 PM to 6:00 PM
Peak Hour: 4:00 PM to 5:00 PM

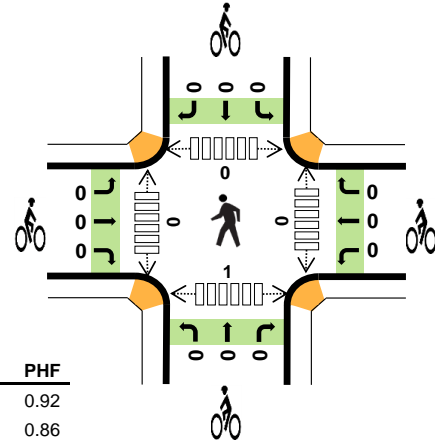
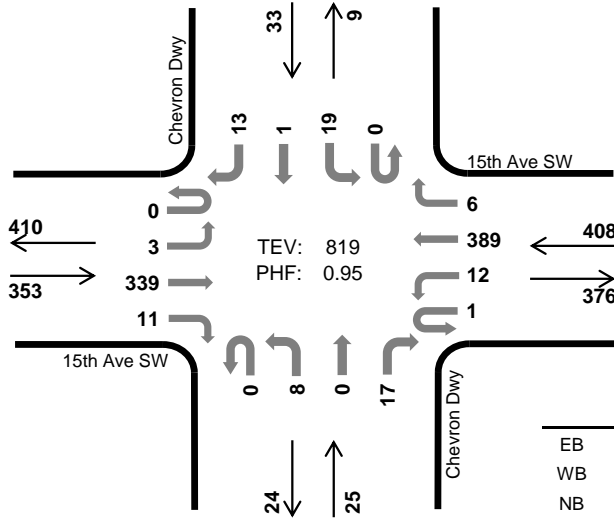

	HV %:	PHF
EB	1.4%	0.92
WB	1.7%	0.86
NB	0.0%	0.69
SB	3.0%	0.75
TOTAL	1.6%	0.95

Two-Hour Count Summaries

Interval Start	15th Ave SW Eastbound				15th Ave SW Westbound				Chevron Dwy Northbound				Chevron Dwy Southbound				15-min Total	Rolling One Hour	
	UT	LT	TH	RT	UT	LT	TH	RT	UT	LT	TH	RT	UT	LT	TH	RT			
4:00 PM	0	0	85	1	1	4	96	1	0	4	0	2	0	7	0	4	205	0	
4:15 PM	0	1	81	3	0	3	97	1	0	2	0	7	0	3	0	5	203	0	
4:30 PM	0	1	82	3	0	1	117	1	0	1	0	2	0	3	1	3	215	0	
4:45 PM	0	1	91	4	0	4	79	3	0	1	0	6	0	6	0	1	196	819	
5:00 PM	0	0	68	3	0	2	110	1	0	1	0	3	0	6	0	4	198	812	
5:15 PM	0	0	66	4	0	3	88	0	0	3	0	6	0	4	0	3	177	786	
5:30 PM	0	0	78	1	0	0	99	0	0	3	0	6	0	0	0	2	189	760	
5:45 PM	0	1	67	2	0	3	75	0	0	0	0	10	0	1	0	1	160	724	
Count Total	0	4	618	21	1	20	761	7	0	15	0	42	0	30	1	23	1,543	0	
Peak Hour	All	0	3	339	11	1	12	389	6	0	8	0	17	0	19	1	13	819	0
	HV	0	0	5	0	0	0	7	0	0	0	0	0	0	0	0	1	13	0
	HV%	-	0%	1%	0%	0%	0%	2%	0%	-	0%	-	0%	-	0%	0%	8%	2%	0

Note: Two-hour count summary volumes include heavy vehicles but exclude bicycles in overall count.

Interval Start	Heavy Vehicle Totals					Bicycles					Pedestrians (Crossing Leg)				
	EB	WB	NB	SB	Total	EB	WB	NB	SB	Total	East	West	North	South	Total
4:00 PM	2	1	0	0	3	0	0	0	0	0	0	0	0	0	0
4:15 PM	0	3	0	0	3	0	0	0	0	0	0	0	0	0	0
4:30 PM	2	1	0	0	3	0	0	0	0	0	0	0	0	1	1
4:45 PM	1	2	0	1	4	0	0	0	0	0	0	0	0	0	0
5:00 PM	1	0	0	0	1	0	0	0	0	0	0	0	0	0	0
5:15 PM	0	0	0	0	0	0	0	0	0	0	0	0	0	1	1
5:30 PM	1	2	1	0	4	0	0	0	0	0	0	0	0	0	0
5:45 PM	2	0	1	0	3	0	0	0	0	0	0	0	1	0	1
Count Total	9	9	2	1	21	0	0	0	0	0	0	0	1	2	3
Peak Hour	5	7	0	1	13	0	0	0	0	0	0	0	0	1	1

Two-Hour Count Summaries - Heavy Vehicles																		
Interval Start	15th Ave SW				15th Ave SW				Chevron Dwy				Chevron Dwy				15-min Total	Rolling One Hour
	Eastbound				Westbound				Northbound				Southbound					
	UT	LT	TH	RT	UT	LT	TH	RT	UT	LT	TH	RT	UT	LT	TH	RT		
4:00 PM	0	0	2	0	0	0	1	0	0	0	0	0	0	0	0	3	0	
4:15 PM	0	0	0	0	0	0	3	0	0	0	0	0	0	0	0	3	0	
4:30 PM	0	0	2	0	0	0	1	0	0	0	0	0	0	0	0	3	0	
4:45 PM	0	0	1	0	0	0	2	0	0	0	0	0	0	0	1	4	13	
5:00 PM	0	0	1	0	0	0	0	0	0	0	0	0	0	0	0	1	11	
5:15 PM	0	0	0	0	0	0	0	0	0	0	0	0	0	0	0	0	8	
5:30 PM	0	0	1	0	0	0	2	0	0	0	0	1	0	0	0	4	9	
5:45 PM	0	0	2	0	0	0	0	0	0	0	0	1	0	0	0	3	8	
Count Total	0	0	9	0	0	0	9	0	0	0	2	0	0	0	1	21	0	
Peak Hour	0	0	5	0	0	0	7	0	0	0	0	0	0	0	1	13	0	

Two-Hour Count Summaries - Bikes																
Interval Start	15th Ave SW			15th Ave SW			Chevron Dwy			Chevron Dwy			15-min Total	Rolling One Hour		
	Eastbound			Westbound			Northbound			Southbound						
	LT	TH	RT	LT	TH	RT	LT	TH	RT	LT	TH	RT				
4:00 PM	0	0	0	0	0	0	0	0	0	0	0	0	0	0	0	0
4:15 PM	0	0	0	0	0	0	0	0	0	0	0	0	0	0	0	0
4:30 PM	0	0	0	0	0	0	0	0	0	0	0	0	0	0	0	0
4:45 PM	0	0	0	0	0	0	0	0	0	0	0	0	0	0	0	0
5:00 PM	0	0	0	0	0	0	0	0	0	0	0	0	0	0	0	0
5:15 PM	0	0	0	0	0	0	0	0	0	0	0	0	0	0	0	0
5:30 PM	0	0	0	0	0	0	0	0	0	0	0	0	0	0	0	0
5:45 PM	0	0	0	0	0	0	0	0	0	0	0	0	0	0	0	0
Count Total	0	0	0	0	0	0	0	0	0	0	0	0	0	0	0	0
Peak Hour	0	0	0	0	0	0	0	0	0	0	0	0	0	0	0	0

Note: U-Turn volumes for bikes are included in Left-Turn, if any.

Location: 15th Ave and Meridian - NB Queue
 Start Date: 22-Feb
 Duration: 730-830am; 4-5pm

730-830 am			
Time	Left Turn Lane	Thru Turn Lane	Thru/Right Turn Lane
	Distance (ft)	Distance (ft)	Distance (ft)
7:30 AM	165	413	455
7:45 AM	165	640	645
8:00 AM	110	705	490
8:15 AM	110	248	583

165 705 645

4-5 pm			
Time	Left Turn Lane	Thru Turn Lane	Thru/Right Turn Lane
	Distance (ft)	Distance (ft)	Distance (ft)
4:00 PM	165	290	430
4:15 AM	165	320	390
4:30 PM	250	265	348
4:45 PM	275	275	440

275 320 440

Location: 15th Ave and Meridian - EB Queue
 Start Date: 22-Feb
 Duration: 730-830am; 4-5pm

730-830 am		
Time	Left Turn Lane	Thru/Right Turn Lane
	Distance (ft)	Distance (ft)
7:30 AM	138	275
7:45 AM	248	330
8:00 AM	138	275
8:15 AM	138	330

248

330

4-5 pm		
Time	Left Turn Lane	Thru/Right Turn Lane
	Distance (ft)	Distance (ft)
4:00 PM	220	193
4:15 AM	138	303
4:30 PM	193	275
4:45 PM	165	205

220

303

Location: 15th Ave and Meridian - WB Queue
 Start Date: 22-Feb
 Duration: 730-830am; 4-5pm

730-830 am			
Time	Left Turn Lane	Thru Turn Lane	Right Turn Lane
	Distance (ft)	Distance (ft)	Distance (ft)
7:30 AM	220	165	110
7:45 AM	193	138	83
8:00 AM	83	83	83
8:15 AM	83	55	55

220 165 110

4-5 pm			
Time	Left Turn Lane	Thru Turn Lane	Right Turn Lane
	Distance (ft)	Distance (ft)	Distance (ft)
4:00 PM	138	193	193
4:15 AM	320	193	83
4:30 PM	310	MAX	183
4:45 PM	275	193	138

320 MAX 193

Location: 15th Ave and Meridian - SB Queue
 Start Date: 22-Feb
 Duration: 730-830am; 4-5pm

730-830 am			
Time	Left Turn Lane	Thru Turn Lane	Thru/Right Turn Lane
	Distance (ft)	Distance (ft)	Distance (ft)
7:30 AM	MAX	138	138
7:45 AM	MAX	205	110
8:00 AM	358	175	170
8:15 AM	350	138	138

MAX
205
170

4-5 pm			
Time	Left Turn Lane	Thru Turn Lane	Thru/Right Turn Lane
	Distance (ft)	Distance (ft)	Distance (ft)
4:00 PM	110	480	360
4:15 AM	138	MAX	MAX
4:30 PM	195	MAX	MAX
4:45 PM	228	MAX	MAX

228 MAX
MAX

Location: Meridian/ 512 Ramps - SB Queue

Start Date: 22-Feb

Duration: 4-5pm

4-5 pm			
Time	Thru Lane (Outside)	Thru Lane (Inside)	Left Turn Lane
	Distance (ft)	Distance (ft)	Distance (ft)
4:00 PM	140	140	50
4:15 AM	315	MAX (400 ft)	50
4:30 PM	350	MAX (400 ft)	50
4:45 PM	315	MAX (400 ft)	25

Appendix C: LOS Definitions

Highway Capacity Manual 2010/6th Edition

Signalized intersection level of service (LOS) is defined in terms of a weighted average control delay for the entire intersection. Control delay quantifies the increase in travel time that a vehicle experiences due to the traffic signal control as well as provides a surrogate measure for driver discomfort and fuel consumption. Signalized intersection LOS is stated in terms of average control delay per vehicle (in seconds) during a specified time period (e.g., weekday PM peak hour). Control delay is a complex measure based on many variables, including signal phasing and coordination (i.e., progression of movements through the intersection and along the corridor), signal cycle length, and traffic volumes with respect to intersection capacity and resulting queues. Table 1 summarizes the LOS criteria for signalized intersections, as described in the *Highway Capacity Manual 2010* and 6th Edition (Transportation Research Board, 2010 and 2016, respectively).

Table 1. Level of Service Criteria for Signalized Intersections

Level of Service	Average Control Delay (seconds/vehicle)	General Description
A	≤10	Free Flow
B	>10 – 20	Stable Flow (slight delays)
C	>20 – 35	Stable flow (acceptable delays)
D	>35 – 55	Approaching unstable flow (tolerable delay, occasionally wait through more than one signal cycle before proceeding)
E	>55 – 80	Unstable flow (intolerable delay)
F ¹	>80	Forced flow (congested and queues fail to clear)

Source: *Highway Capacity Manual 2010 and 6th Edition*, Transportation Research Board, 2010 and 2016, respectively.

1. If the volume-to-capacity (v/c) ratio for a lane group exceeds 1.0 LOS F is assigned to the individual lane group. LOS for overall approach or intersection is determined solely by the control delay.

Unsignalized intersection LOS criteria can be further reduced into two intersection types: all-way stop and two-way stop control. All-way stop control intersection LOS is expressed in terms of the weighted average control delay of the overall intersection or by approach. Two-way stop-controlled intersection LOS is defined in terms of the average control delay for each minor-street movement (or shared movement) as well as major-street left-turns. This approach is because major-street through vehicles are assumed to experience zero delay, a weighted average of all movements results in very low overall average delay, and this calculated low delay could mask deficiencies of minor movements. Table 2 shows LOS criteria for unsignalized intersections.

Table 2. Level of Service Criteria for Unsignalized Intersections

Level of Service	Average Control Delay (seconds/vehicle)
A	0 – 10
B	>10 – 15
C	>15 – 25
D	>25 – 35
E	>35 – 50
F ¹	>50

Source: *Highway Capacity Manual 2010 and 6th Edition*, Transportation Research Board, 2010 and 2016, respectively.

1. If the volume-to-capacity (v/c) ratio exceeds 1.0, LOS F is assigned an individual lane group for all unsignalized intersections, or minor street approach at two-way stop-controlled intersections. Overall intersection LOS is determined solely by control delay.

Appendix D: LOS Worksheets

Intersection												
Int Delay, s/veh	0.1											
Movement	EBL	EBT	EBR	WBL	WBT	WBR	NBL	NBT	NBR	SBL	SBT	SBR
Lane Configurations		↕			↕			↕		↕	↕	
Traffic Vol, veh/h	0	0	5	0	0	5	0	1105	5	5	895	10
Future Vol, veh/h	0	0	5	0	0	5	0	1105	5	5	895	10
Conflicting Peds, #/hr	2	0	2	1	0	1	2	0	1	1	0	2
Sign Control	Stop	Stop	Stop	Stop	Stop	Stop	Free	Free	Free	Free	Free	Free
RT Channelized	-	-	None	-	-	None	-	-	None	-	-	None
Storage Length	-	-	-	-	-	-	-	-	-	50	-	-
Veh in Median Storage, #	-	0	-	-	0	-	-	0	-	-	0	-
Grade, %	-	0	-	-	0	-	-	0	-	-	0	-
Peak Hour Factor	91	91	91	91	91	91	91	91	91	91	91	91
Heavy Vehicles, %	0	0	0	0	0	0	2	2	2	3	3	3
Mvmt Flow	0	0	5	0	0	5	0	1214	5	5	984	11

Major/Minor	Minor2		Minor1		Major1			Major2				
Conflicting Flow All	1611	2222	502	1722	2225	613	-	0	0	1220	0	0
Stage 1	1002	1002	-	1218	1218	-	-	-	-	-	-	-
Stage 2	609	1220	-	504	1007	-	-	-	-	-	-	-
Critical Hdwy	7.5	6.5	6.9	7.5	6.5	6.9	-	-	-	4.16	-	-
Critical Hdwy Stg 1	6.5	5.5	-	6.5	5.5	-	-	-	-	-	-	-
Critical Hdwy Stg 2	6.5	5.5	-	6.5	5.5	-	-	-	-	-	-	-
Follow-up Hdwy	3.5	4	3.3	3.5	4	3.3	-	-	-	2.23	-	-
Pot Cap-1 Maneuver	71	44	520	59	44	440	0	-	-	562	-	-
Stage 1	264	323	-	195	255	-	0	-	-	-	-	-
Stage 2	454	255	-	524	321	-	0	-	-	-	-	-
Platoon blocked, %												
Mov Cap-1 Maneuver	69	43	518	58	43	439	-	-	-	561	-	-
Mov Cap-2 Maneuver	180	147	-	149	148	-	-	-	-	-	-	-
Stage 1	264	319	-	195	255	-	-	-	-	-	-	-
Stage 2	447	255	-	513	317	-	-	-	-	-	-	-

Approach	EB	WB	NB	SB
HCM Control Delay, s	12	13.3	0	0.1
HCM LOS	B	B		

Minor Lane/Major Mvmt	NBT	NBR	EBLn1	WBLn1	SBL	SBT	SBR
Capacity (veh/h)	-	-	518	439	561	-	-
HCM Lane V/C Ratio	-	-	0.011	0.013	0.01	-	-
HCM Control Delay (s)	-	-	12	13.3	11.5	-	-
HCM Lane LOS	-	-	B	B	B	-	-
HCM 95th %tile Q(veh)	-	-	0	0	0	-	-

Queues
4: S Meridian & 15th Ave SW/SE

Puyallup Arco
Existing Weekday AM Peak Hour



Lane Group	EBL	EBT	WBL	WBT	WBR	NBL	NBT	SBL	SBT
Lane Group Flow (vph)	169	287	73	96	135	129	1006	337	674
v/c Ratio	0.62	0.85	0.46	0.47	0.39	0.40	0.98	0.96	0.44
Control Delay	46.8	68.1	41.8	58.8	4.1	20.0	68.2	77.7	25.3
Queue Delay	0.0	0.0	0.0	0.0	0.0	0.0	0.0	0.0	0.0
Total Delay	46.8	68.1	41.8	58.8	4.1	20.0	68.2	77.7	25.3
Queue Length 50th (ft)	114	221	46	76	0	49	~492	234	193
Queue Length 95th (ft)	156	300	74	122	7	99	#764	#420	296
Internal Link Dist (ft)		129		551			458		189
Turn Bay Length (ft)	125		225		225	135		160	
Base Capacity (vph)	307	390	247	346	450	351	1025	388	1540
Starvation Cap Reductn	0	0	0	0	0	0	0	0	0
Spillback Cap Reductn	0	0	0	0	0	0	0	0	0
Storage Cap Reductn	0	0	0	0	0	0	0	0	0
Reduced v/c Ratio	0.55	0.74	0.30	0.28	0.30	0.37	0.98	0.87	0.44























Intersection Summary

~ Volume exceeds capacity, queue is theoretically infinite.
Queue shown is maximum after two cycles.

95th percentile volume exceeds capacity, queue may be longer.
Queue shown is maximum after two cycles.

HCM 6th Signalized Intersection Summary
4: S Meridian & 15th Ave SW/SE

Puyallup Arco
Existing Weekday AM Peak Hour

												
Movement	EBL	EBT	EBR	WBL	WBT	WBR	NBL	NBT	NBR	SBL	SBT	SBR
Lane Configurations												
Traffic Volume (veh/h)	150	160	95	65	85	120	115	830	65	300	550	50
Future Volume (veh/h)	150	160	95	65	85	120	115	830	65	300	550	50
Initial Q (Qb), veh	0	0	0	0	0	0	0	0	0	0	0	0
Ped-Bike Adj(A_pbT)	1.00		1.00	1.00		1.00	1.00		1.00	1.00		1.00
Parking Bus, Adj	1.00	1.00	1.00	1.00	1.00	1.00	1.00	1.00	1.00	1.00	1.00	1.00
Work Zone On Approach		No			No			No			No	
Adj Sat Flow, veh/h/ln	1709	1709	1709	1736	1736	1736	1723	1723	1723	1709	1709	1709
Adj Flow Rate, veh/h	169	180	107	73	96	135	129	933	73	337	618	56
Peak Hour Factor	0.89	0.89	0.89	0.89	0.89	0.89	0.89	0.89	0.89	0.89	0.89	0.89
Percent Heavy Veh, %	3	3	3	1	1	1	2	2	2	3	3	3
Cap, veh/h	273	193	114	125	204	172	457	1051	82	338	1456	132
Arrive On Green	0.09	0.19	0.20	0.04	0.12	0.12	0.04	0.34	0.37	0.31	0.97	0.97
Sat Flow, veh/h	1628	1003	596	1654	1736	1468	1641	3075	241	1628	3010	272
Grp Volume(v), veh/h	169	0	287	73	96	135	129	497	509	337	333	341
Grp Sat Flow(s),veh/h/ln	1628	0	1599	1654	1736	1468	1641	1637	1679	1628	1624	1659
Q Serve(g_s), s	11.4	0.0	23.0	4.7	6.7	11.6	4.7	37.3	37.2	20.0	1.5	1.5
Cycle Q Clear(g_c), s	11.4	0.0	23.0	4.7	6.7	11.6	4.7	37.3	37.2	20.0	1.5	1.5
Prop In Lane	1.00		0.37	1.00		1.00	1.00		0.14	1.00		0.16
Lane Grp Cap(c), veh/h	273	0	307	125	204	172	457	560	574	338	785	802
V/C Ratio(X)	0.62	0.00	0.93	0.58	0.47	0.78	0.28	0.89	0.89	1.00	0.42	0.43
Avail Cap(c_a), veh/h	300	0	365	230	347	294	490	560	574	415	785	802
HCM Platoon Ratio	1.00	1.00	1.00	1.00	1.00	1.00	1.00	1.00	1.00	2.00	2.00	2.00
Upstream Filter(I)	1.00	0.00	1.00	1.00	1.00	1.00	1.00	1.00	1.00	1.00	1.00	1.00
Uniform Delay (d), s/veh	46.3	0.0	51.6	44.0	53.6	55.8	18.1	40.4	40.2	25.3	1.1	1.1
Incr Delay (d2), s/veh	2.1	0.0	26.6	1.6	0.6	3.0	0.1	18.6	18.2	39.0	1.7	1.6
Initial Q Delay(d3),s/veh	0.0	0.0	0.0	0.0	0.0	0.0	0.0	0.0	0.0	0.0	0.0	0.0
%ile BackOfQ(50%),veh/ln	5.0	0.0	11.4	2.0	3.0	4.4	2.1	17.6	18.0	9.1	0.7	0.7
Unsig. Movement Delay, s/veh												
LnGrp Delay(d),s/veh	48.4	0.0	78.3	45.6	54.2	58.7	18.2	59.0	58.4	64.3	2.8	2.8
LnGrp LOS	D	A	E	D	D	E	B	E	E	E	A	A
Approach Vol, veh/h		456			304			1135			1011	
Approach Delay, s/veh		67.2			54.1			54.1			23.3	
Approach LOS		E			D			D			C	
Timer - Assigned Phs	1	2	3	4	5	6	7	8				
Phs Duration (G+Y+Rc), s	14.3	69.6	21.1	25.0	29.8	54.2	13.9	32.2				
Change Period (Y+Rc), s	* 6.7	* 6.7	* 6.7	* 6.7	* 6.7	* 6.7	* 6.7	* 6.7				
Max Green Setting (Gmax), s	* 10	* 47	* 17	* 29	* 29	* 28	* 15	* 30				
Max Q Clear Time (g_c+I1), s	7.7	4.5	14.4	14.6	23.0	40.3	7.7	25.0				
Green Ext Time (p_c), s	0.0	1.4	0.0	0.2	0.1	0.0	0.0	0.3				

Intersection Summary

HCM 6th Ctrl Delay	45.4
HCM 6th LOS	D

Notes

User approved pedestrian interval to be less than phase max green.
* HCM 6th computational engine requires equal clearance times for the phases crossing the barrier.

HCM 6th TWSC
5: Ex Driveway & 15th Ave SW

Puyallup Arco
Existing Weekday AM Peak Hour

Intersection												
Int Delay, s/veh	0.9											
Movement	EBL	EBT	EBR	WBL	WBT	WBR	NBL	NBT	NBR	SBL	SBT	SBR
Lane Configurations	↖	↗		↖	↗			↕			↕	
Traffic Vol, veh/h	5	335	10	10	225	10	5	0	15	10	0	5
Future Vol, veh/h	5	335	10	10	225	10	5	0	15	10	0	5
Conflicting Peds, #/hr	1	0	2	3	0	2	2	0	3	2	0	1
Sign Control	Free	Free	Free	Free	Free	Free	Stop	Stop	Stop	Stop	Stop	Stop
RT Channelized	-	-	None	-	-	None	-	-	None	-	-	None
Storage Length	50	-	-	50	-	-	-	-	-	-	-	-
Veh in Median Storage, #	-	0	-	-	0	-	-	0	-	-	0	-
Grade, %	-	0	-	-	0	-	-	0	-	-	0	-
Peak Hour Factor	80	80	80	80	80	80	80	80	80	80	80	80
Heavy Vehicles, %	3	3	3	3	3	3	11	11	11	9	9	9
Mvmt Flow	6	419	13	13	281	13	6	0	19	13	0	6

Major/Minor	Major1			Major2			Minor1			Minor2		
Conflicting Flow All	296	0	0	435	0	0	760	763	432	766	763	292
Stage 1	-	-	-	-	-	-	441	441	-	316	316	-
Stage 2	-	-	-	-	-	-	319	322	-	450	447	-
Critical Hdwy	4.13	-	-	4.13	-	-	7.21	6.61	6.31	7.19	6.59	6.29
Critical Hdwy Stg 1	-	-	-	-	-	-	6.21	5.61	-	6.19	5.59	-
Critical Hdwy Stg 2	-	-	-	-	-	-	6.21	5.61	-	6.19	5.59	-
Follow-up Hdwy	2.227	-	-	2.227	-	-	3.599	4.099	3.399	3.581	4.081	3.381
Pot Cap-1 Maneuver	1260	-	-	1119	-	-	312	324	605	311	326	731
Stage 1	-	-	-	-	-	-	578	562	-	680	643	-
Stage 2	-	-	-	-	-	-	674	635	-	575	562	-
Platoon blocked, %	-	-	-	-	-	-	-	-	-	-	-	-
Mov Cap-1 Maneuver	1258	-	-	1116	-	-	304	317	602	296	319	728
Mov Cap-2 Maneuver	-	-	-	-	-	-	304	317	-	296	319	-
Stage 1	-	-	-	-	-	-	573	558	-	675	634	-
Stage 2	-	-	-	-	-	-	659	626	-	553	558	-

Approach	EB			WB			NB			SB		
HCM Control Delay, s	0.1			0.3			12.8			15.3		
HCM LOS							B			C		

Minor Lane/Major Mvmt	NBLn1	EBL	EBT	EBR	WBL	WBT	WBR	SBLn1
Capacity (veh/h)	484	1258	-	-	1116	-	-	369
HCM Lane V/C Ratio	0.052	0.005	-	-	0.011	-	-	0.051
HCM Control Delay (s)	12.8	7.9	-	-	8.3	-	-	15.3
HCM Lane LOS	B	A	-	-	A	-	-	C
HCM 95th %tile Q(veh)	0.2	0	-	-	0	-	-	0.2

Queues

1: S Meridian & SR 512 EB Ramps

Puyallup Arco
Existing Weekday PM Peak Hour



Lane Group	EBT	EBR	NBT	SBL	SBT
Lane Group Flow (vph)	151	71	1172	51	1384
v/c Ratio	0.87	0.31	0.51	0.16	0.53
Control Delay	93.3	11.8	4.4	4.0	5.4
Queue Delay	0.0	0.0	0.2	0.0	0.0
Total Delay	93.3	11.8	4.7	4.0	5.4
Queue Length 50th (ft)	116	0	92	7	174
Queue Length 95th (ft)	#226	36	120	15	213
Internal Link Dist (ft)	199		85		474
Turn Bay Length (ft)				50	
Base Capacity (vph)	190	242	2279	330	2610
Starvation Cap Reductn	0	0	391	0	0
Spillback Cap Reductn	0	0	0	0	0
Storage Cap Reductn	0	0	0	0	0
Reduced v/c Ratio	0.79	0.29	0.62	0.15	0.53

Intersection Summary

95th percentile volume exceeds capacity, queue may be longer.
Queue shown is maximum after two cycles.

HCM 6th Signalized Intersection Summary
 1: S Meridian & SR 512 EB Ramps

Puyallup Arco
 Existing Weekday PM Peak Hour



Movement	EBL	EBT	EBR	WBL	WBT	WBR	NBL	NBT	NBR	SBL	SBT	SBR
Lane Configurations		↖	↗					↕		↘	↗	
Traffic Volume (veh/h)	145	5	70	0	0	0	0	760	400	50	1370	0
Future Volume (veh/h)	145	5	70	0	0	0	0	760	400	50	1370	0
Initial Q (Qb), veh	0	0	0				0	0	0	0	0	0
Ped-Bike Adj(A_pbT)	1.00		1.00				1.00		1.00	1.00		1.00
Parking Bus, Adj	1.00	1.00	1.00				1.00	1.00	1.00	1.00	1.00	1.00
Work Zone On Approach		No						No			No	
Adj Sat Flow, veh/h/ln	1723	1723	1723				0	1736	1736	1736	1736	0
Adj Flow Rate, veh/h	146	5	0				0	768	404	51	1384	0
Peak Hour Factor	0.99	0.99	0.99				0.99	0.99	0.99	0.99	0.99	0.99
Percent Heavy Veh, %	2	2	2				0	1	1	1	1	0
Cap, veh/h	169	6					0	1484	777	459	2617	0
Arrive On Green	0.11	0.11	0.00				0.00	1.00	1.00	0.03	0.79	0.00
Sat Flow, veh/h	1589	54	1460				0	2178	1096	1654	3386	0
Grp Volume(v), veh/h	151	0	0				0	605	567	51	1384	0
Grp Sat Flow(s),veh/h/ln	1643	0	1460				0	1650	1538	1654	1650	0
Q Serve(g_s), s	10.8	0.0	0.0				0.0	0.0	0.0	0.9	17.9	0.0
Cycle Q Clear(g_c), s	10.8	0.0	0.0				0.0	0.0	0.0	0.9	17.9	0.0
Prop In Lane	0.97		1.00				0.00		0.71	1.00		0.00
Lane Grp Cap(c), veh/h	175	0					0	1170	1091	459	2617	0
V/C Ratio(X)	0.86	0.00					0.00	0.52	0.52	0.11	0.53	0.00
Avail Cap(c_a), veh/h	192	0					0	1170	1091	485	2617	0
HCM Platoon Ratio	1.00	1.00	1.00				1.00	2.00	2.00	1.00	1.00	1.00
Upstream Filter(I)	1.00	0.00	0.00				0.00	1.00	1.00	1.00	1.00	0.00
Uniform Delay (d), s/veh	52.7	0.0	0.0				0.0	0.0	0.0	3.6	4.4	0.0
Incr Delay (d2), s/veh	27.2	0.0	0.0				0.0	1.6	1.8	0.0	0.8	0.0
Initial Q Delay(d3),s/veh	0.0	0.0	0.0				0.0	0.0	0.0	0.0	0.0	0.0
%ile BackOfQ(50%),veh/ln	5.8	0.0	0.0				0.0	0.5	0.5	0.3	4.8	0.0
Unsig. Movement Delay, s/veh												
LnGrp Delay(d),s/veh	79.9	0.0	0.0				0.0	1.6	1.8	3.6	5.2	0.0
LnGrp LOS	E	A					A	A	A	A	A	A
Approach Vol, veh/h		151						1172			1435	
Approach Delay, s/veh		79.9						1.7			5.1	
Approach LOS		E						A			A	
Timer - Assigned Phs		2			5	6		8				
Phs Duration (G+Y+Rc), s		101.2			10.1	91.1		18.8				
Change Period (Y+Rc), s		6.0			6.0	6.0		6.0				
Max Green Setting (Gmax), s		94.0			6.0	82.0		14.0				
Max Q Clear Time (g_c+I1), s		19.9			2.9	2.0		12.8				
Green Ext Time (p_c), s		4.4			0.0	2.9		0.0				

Intersection Summary

HCM 6th Ctrl Delay	7.8
HCM 6th LOS	A

Notes

- User approved pedestrian interval to be less than phase max green.
- Unsignalized Delay for [EBR] is excluded from calculations of the approach delay and intersection delay.

Intersection						
Int Delay, s/veh	0.8					
Movement	WBL	WBR	NBT	NBR	SBL	SBT
Lane Configurations		↗	↕			↕
Traffic Vol, veh/h	0	130	1035	20	0	1435
Future Vol, veh/h	0	130	1035	20	0	1435
Conflicting Peds, #/hr	0	0	0	0	0	0
Sign Control	Stop	Stop	Free	Free	Free	Free
RT Channelized	-	None	-	None	-	None
Storage Length	-	0	-	-	-	-
Veh in Median Storage, #	0	-	0	-	-	0
Grade, %	0	-	0	-	-	0
Peak Hour Factor	98	98	98	98	98	98
Heavy Vehicles, %	4	4	1	1	2	2
Mvmt Flow	0	133	1056	20	0	1464

Major/Minor	Minor1	Major1	Major2		
Conflicting Flow All	-	538	0	0	-
Stage 1	-	-	-	-	-
Stage 2	-	-	-	-	-
Critical Hdwy	-	6.98	-	-	-
Critical Hdwy Stg 1	-	-	-	-	-
Critical Hdwy Stg 2	-	-	-	-	-
Follow-up Hdwy	-	3.34	-	-	-
Pot Cap-1 Maneuver	0	482	-	-	0
Stage 1	0	-	-	-	0
Stage 2	0	-	-	-	0
Platoon blocked, %			-	-	-
Mov Cap-1 Maneuver	-	482	-	-	-
Mov Cap-2 Maneuver	-	-	-	-	-
Stage 1	-	-	-	-	-
Stage 2	-	-	-	-	-

Approach	WB	NB	SB
HCM Control Delay, s	15.3	0	0
HCM LOS	C		

Minor Lane/Major Mvmt	NBT	NBRWBLn1	SBT
Capacity (veh/h)	-	-	482
HCM Lane V/C Ratio	-	-	0.275
HCM Control Delay (s)	-	-	15.3
HCM Lane LOS	-	-	C
HCM 95th %tile Q(veh)	-	-	1.1

Intersection												
Int Delay, s/veh	0.1											
Movement	EBL	EBT	EBR	WBL	WBT	WBR	NBL	NBT	NBR	SBL	SBT	SBR
Lane Configurations		↕			↕			↕		↕	↕	
Traffic Vol, veh/h	0	0	5	5	0	10	0	1050	5	5	1385	15
Future Vol, veh/h	0	0	5	5	0	10	0	1050	5	5	1385	15
Conflicting Peds, #/hr	0	0	0	0	0	0	1	0	1	1	0	1
Sign Control	Stop	Stop	Stop	Stop	Stop	Stop	Free	Free	Free	Free	Free	Free
RT Channelized	-	-	None	-	-	None	-	-	None	-	-	None
Storage Length	-	-	-	-	-	-	-	-	-	50	-	-
Veh in Median Storage, #	-	0	-	-	0	-	-	0	-	-	0	-
Grade, %	-	0	-	-	0	-	-	0	-	-	0	-
Peak Hour Factor	95	95	95	95	95	95	95	95	95	95	95	95
Heavy Vehicles, %	0	0	0	0	0	0	1	1	1	2	2	2
Mvmt Flow	0	0	5	5	0	11	0	1105	5	5	1458	16

Major/Minor	Minor2		Minor1		Major1			Major2				
Conflicting Flow All	2030	2588	738	1848	2594	556	-	0	0	1111	0	0
Stage 1	1477	1477	-	1109	1109	-	-	-	-	-	-	-
Stage 2	553	1111	-	739	1485	-	-	-	-	-	-	-
Critical Hdwy	7.5	6.5	6.9	7.5	6.5	6.9	-	-	-	4.14	-	-
Critical Hdwy Stg 1	6.5	5.5	-	6.5	5.5	-	-	-	-	-	-	-
Critical Hdwy Stg 2	6.5	5.5	-	6.5	5.5	-	-	-	-	-	-	-
Follow-up Hdwy	3.5	4	3.3	3.5	4	3.3	-	-	-	2.22	-	-
Pot Cap-1 Maneuver	34	26	365	47	25	480	0	-	-	624	-	-
Stage 1	135	192	-	227	288	-	0	-	-	-	-	-
Stage 2	490	287	-	380	190	-	0	-	-	-	-	-
Platoon blocked, %												
Mov Cap-1 Maneuver	33	26	365	46	25	480	-	-	-	623	-	-
Mov Cap-2 Maneuver	106	115	-	148	115	-	-	-	-	-	-	-
Stage 1	135	190	-	227	288	-	-	-	-	-	-	-
Stage 2	479	287	-	372	188	-	-	-	-	-	-	-

Approach	EB	WB	NB	SB
HCM Control Delay, s	15	18.9	0	0
HCM LOS	C	C		

Minor Lane/Major Mvmt	NBT	NBR	EBLn1	WBLn1	SBL	SBT	SBR
Capacity (veh/h)	-	-	365	275	623	-	-
HCM Lane V/C Ratio	-	-	0.014	0.057	0.008	-	-
HCM Control Delay (s)	-	-	15	18.9	10.8	-	-
HCM Lane LOS	-	-	C	C	B	-	-
HCM 95th %tile Q(veh)	-	-	0	0.2	0	-	-

Queues
4: S Meridian & 15th Ave SW/SE

Puyallup Arco
Existing Weekday PM Peak Hour



Lane Group	EBL	EBT	WBL	WBT	WBR	NBL	NBT	SBL	SBT
Lane Group Flow (vph)	142	247	116	179	295	111	716	163	1300
v/c Ratio	0.76	0.84	0.73	0.96	0.70	0.66	0.50	0.42	0.81
Control Delay	65.6	52.4	61.4	109.6	15.0	35.1	27.0	16.2	26.9
Queue Delay	0.0	0.0	0.0	0.0	0.0	0.0	0.0	0.0	0.0
Total Delay	65.6	52.4	61.4	109.6	15.0	35.1	27.0	16.2	26.9
Queue Length 50th (ft)	92	111	73	140	0	34	204	26	424
Queue Length 95th (ft)	137	191	113	210	83	90	301	75	#701
Internal Link Dist (ft)		129		551			458		189
Turn Bay Length (ft)	125		225		225	135		160	
Base Capacity (vph)	205	456	166	379	548	175	1428	390	1613
Starvation Cap Reductn	0	0	0	0	0	0	0	0	0
Spillback Cap Reductn	0	0	0	0	0	0	0	0	0
Storage Cap Reductn	0	0	0	0	0	0	0	0	0
Reduced v/c Ratio	0.69	0.54	0.70	0.47	0.54	0.63	0.50	0.42	0.81

Intersection Summary

95th percentile volume exceeds capacity, queue may be longer.
Queue shown is maximum after two cycles.

HCM 6th Signalized Intersection Summary
4: S Meridian & 15th Ave SW/SE

Puyallup Arco
Existing Weekday PM Peak Hour

Movement	EBL	EBT	EBR	WBL	WBT	WBR	NBL	NBT	NBR	SBL	SBT	SBR
Lane Configurations												
Traffic Volume (veh/h)	135	65	170	110	170	280	105	645	35	155	1100	135
Future Volume (veh/h)	135	65	170	110	170	280	105	645	35	155	1100	135
Initial Q (Qb), veh	0	0	0	0	0	0	0	0	0	0	0	0
Ped-Bike Adj(A_pbT)	1.00		1.00	1.00		1.00	1.00		1.00	1.00		1.00
Parking Bus, Adj	1.00	1.00	1.00	1.00	1.00	1.00	1.00	1.00	1.00	1.00	1.00	1.00
Work Zone On Approach		No			No			No			No	
Adj Sat Flow, veh/h/ln	1736	1736	1736	1736	1736	1736	1736	1736	1736	1723	1723	1723
Adj Flow Rate, veh/h	142	68	179	116	179	295	111	679	37	163	1158	142
Peak Hour Factor	0.95	0.95	0.95	0.95	0.95	0.95	0.95	0.95	0.95	0.95	0.95	0.95
Percent Heavy Veh, %	1	1	1	1	1	1	1	1	1	2	2	2
Cap, veh/h	209	84	221	225	351	297	222	1015	55	394	1360	166
Arrive On Green	0.02	0.20	0.20	0.07	0.20	0.20	0.02	0.32	0.34	0.29	0.93	0.93
Sat Flow, veh/h	1654	422	1112	1654	1736	1469	1654	3181	173	1641	2934	359
Grp Volume(v), veh/h	142	0	247	116	179	295	111	352	364	163	645	655
Grp Sat Flow(s),veh/h/ln	1654	0	1534	1654	1736	1469	1654	1650	1704	1641	1637	1657
Q Serve(g_s), s	0.0	0.0	18.5	6.7	11.0	24.0	2.3	22.2	22.2	0.0	16.3	16.6
Cycle Q Clear(g_c), s	0.0	0.0	18.5	6.7	11.0	24.0	2.3	22.2	22.2	0.0	16.3	16.6
Prop In Lane	1.00		0.72	1.00		1.00	1.00		0.10	1.00		0.22
Lane Grp Cap(c), veh/h	209	0	305	225	351	297	222	526	544	394	759	768
V/C Ratio(X)	0.68	0.00	0.81	0.52	0.51	0.99	0.50	0.67	0.67	0.41	0.85	0.85
Avail Cap(c_a), veh/h	260	0	378	225	381	322	263	526	544	394	759	768
HCM Platoon Ratio	1.00	1.00	1.00	1.00	1.00	1.00	1.00	1.00	1.00	2.00	2.00	2.00
Upstream Filter(I)	1.00	0.00	1.00	1.00	1.00	1.00	1.00	1.00	1.00	1.00	1.00	1.00
Uniform Delay (d), s/veh	51.7	0.0	45.9	36.7	42.6	47.8	27.5	35.4	35.3	31.8	2.9	3.0
Incr Delay (d2), s/veh	2.9	0.0	8.3	0.9	0.4	46.1	0.6	6.6	6.4	0.3	11.5	11.6
Initial Q Delay(d3),s/veh	0.0	0.0	0.0	0.0	0.0	0.0	0.0	0.0	0.0	0.0	0.0	0.0
%ile BackOfQ(50%),veh/ln	4.4	0.0	7.7	2.7	4.7	12.5	1.6	9.7	10.0	3.4	3.8	3.9
Unsig. Movement Delay, s/veh												
LnGrp Delay(d),s/veh	54.6	0.0	54.2	37.7	43.0	93.9	28.1	42.0	41.7	32.1	14.4	14.6
LnGrp LOS	D	A	D	D	D	F	C	D	D	C	B	B
Approach Vol, veh/h		389			590			827			1463	
Approach Delay, s/veh		54.4			67.4			40.0			16.5	
Approach LOS		D			E			D			B	
Timer - Assigned Phs	1	2	3	4	5	6	7	8				
Phs Duration (G+Y+Rc), s	12.0	62.4	11.7	34.0	27.4	47.0	15.1	30.5				
Change Period (Y+Rc), s	* 6.7	* 6.7	* 6.7	* 6.7	* 6.7	* 6.7	* 6.7	* 6.7				
Max Green Setting (Gmax), s	* 8.3	* 47	* 8.7	* 29	* 15	* 40	* 8.4	* 30				
Max Q Clear Time (g_c+I1), s	5.3	18.6	3.0	27.0	3.0	25.2	9.7	20.5				
Green Ext Time (p_c), s	0.0	3.1	0.0	0.2	0.1	1.3	0.0	0.4				

Intersection Summary

HCM 6th Ctrl Delay	36.1
HCM 6th LOS	D

Notes

* HCM 6th computational engine requires equal clearance times for the phases crossing the barrier.

HCM 6th TWSC
5: Ex Driveway & 15th Ave SW

Puyallup Arco
Existing Weekday PM Peak Hour

Intersection												
Int Delay, s/veh	1.4											
Movement	EBL	EBT	EBR	WBL	WBT	WBR	NBL	NBT	NBR	SBL	SBT	SBR
Lane Configurations	↖	↗		↖	↗			↕			↕	
Traffic Vol, veh/h	5	340	10	15	390	5	10	0	15	20	5	15
Future Vol, veh/h	5	340	10	15	390	5	10	0	15	20	5	15
Conflicting Peds, #/hr	0	0	1	1	0	0	0	0	0	0	0	0
Sign Control	Free	Free	Free	Free	Free	Free	Stop	Stop	Stop	Stop	Stop	Stop
RT Channelized	-	-	None	-	-	None	-	-	None	-	-	None
Storage Length	50	-	-	50	-	-	-	-	-	-	-	-
Veh in Median Storage, #	-	0	-	-	0	-	-	0	-	-	0	-
Grade, %	-	0	-	-	0	-	-	0	-	-	0	-
Peak Hour Factor	95	95	95	95	95	95	95	95	95	95	95	95
Heavy Vehicles, %	1	1	1	2	2	2	0	0	0	3	3	3
Mvmt Flow	5	358	11	16	411	5	11	0	16	21	5	16

Major/Minor	Major1			Major2			Minor1			Minor2		
Conflicting Flow All	416	0	0	370	0	0	831	823	365	828	826	414
Stage 1	-	-	-	-	-	-	375	375	-	446	446	-
Stage 2	-	-	-	-	-	-	456	448	-	382	380	-
Critical Hdwy	4.11	-	-	4.12	-	-	7.1	6.5	6.2	7.13	6.53	6.23
Critical Hdwy Stg 1	-	-	-	-	-	-	6.1	5.5	-	6.13	5.53	-
Critical Hdwy Stg 2	-	-	-	-	-	-	6.1	5.5	-	6.13	5.53	-
Follow-up Hdwy	2.209	-	-	2.218	-	-	3.5	4	3.3	3.527	4.027	3.327
Pot Cap-1 Maneuver	1148	-	-	1189	-	-	291	311	685	289	306	636
Stage 1	-	-	-	-	-	-	650	621	-	590	572	-
Stage 2	-	-	-	-	-	-	588	576	-	638	612	-
Platoon blocked, %	-	-	-	-	-	-	-	-	-	-	-	-
Mov Cap-1 Maneuver	1148	-	-	1188	-	-	276	305	684	279	300	636
Mov Cap-2 Maneuver	-	-	-	-	-	-	276	305	-	279	300	-
Stage 1	-	-	-	-	-	-	647	618	-	588	565	-
Stage 2	-	-	-	-	-	-	560	569	-	621	609	-

Approach	EB			WB			NB			SB		
HCM Control Delay, s	0.1			0.3			13.9			16.4		
HCM LOS							B			C		

Minor Lane/Major Mvmt	NBLn1	EBL	EBT	EBR	WBL	WBT	WBR	SBLn1
Capacity (veh/h)	430	1148	-	-	1188	-	-	357
HCM Lane V/C Ratio	0.061	0.005	-	-	0.013	-	-	0.118
HCM Control Delay (s)	13.9	8.2	-	-	8.1	-	-	16.4
HCM Lane LOS	B	A	-	-	A	-	-	C
HCM 95th %tile Q(veh)	0.2	0	-	-	0	-	-	0.4

Intersection												
Int Delay, s/veh	0.1											
Movement	EBL	EBT	EBR	WBL	WBT	WBR	NBL	NBT	NBR	SBL	SBT	SBR
Lane Configurations		↕			↕			↕		↕	↕	
Traffic Vol, veh/h	0	0	5	0	0	5	0	1140	5	5	920	10
Future Vol, veh/h	0	0	5	0	0	5	0	1140	5	5	920	10
Conflicting Peds, #/hr	2	0	2	1	0	1	2	0	1	1	0	2
Sign Control	Stop	Stop	Stop	Stop	Stop	Stop	Free	Free	Free	Free	Free	Free
RT Channelized	-	-	None	-	-	None	-	-	None	-	-	None
Storage Length	-	-	-	-	-	-	-	-	-	50	-	-
Veh in Median Storage, #	-	0	-	-	0	-	-	0	-	-	0	-
Grade, %	-	0	-	-	0	-	-	0	-	-	0	-
Peak Hour Factor	91	91	91	91	91	91	91	91	91	91	91	91
Heavy Vehicles, %	0	0	0	0	0	0	2	2	2	3	3	3
Mvmt Flow	0	0	5	0	0	5	0	1253	5	5	1011	11

Major/Minor	Minor2		Minor1		Major1			Major2				
Conflicting Flow All	1658	2288	515	1775	2291	632	-	0	0	1259	0	0
Stage 1	1029	1029	-	1257	1257	-	-	-	-	-	-	-
Stage 2	629	1259	-	518	1034	-	-	-	-	-	-	-
Critical Hdwy	7.5	6.5	6.9	7.5	6.5	6.9	-	-	-	4.16	-	-
Critical Hdwy Stg 1	6.5	5.5	-	6.5	5.5	-	-	-	-	-	-	-
Critical Hdwy Stg 2	6.5	5.5	-	6.5	5.5	-	-	-	-	-	-	-
Follow-up Hdwy	3.5	4	3.3	3.5	4	3.3	-	-	-	2.23	-	-
Pot Cap-1 Maneuver	65	40	510	54	40	428	0	-	-	543	-	-
Stage 1	254	314	-	184	245	-	0	-	-	-	-	-
Stage 2	442	244	-	514	312	-	0	-	-	-	-	-
Platoon blocked, %												
Mov Cap-1 Maneuver	63	40	508	53	40	427	-	-	-	542	-	-
Mov Cap-2 Maneuver	172	141	-	141	143	-	-	-	-	-	-	-
Stage 1	254	311	-	184	245	-	-	-	-	-	-	-
Stage 2	435	244	-	503	309	-	-	-	-	-	-	-

Approach	EB		WB		NB			SB		
HCM Control Delay, s	12.2		13.5		0			0.1		
HCM LOS	B		B							

Minor Lane/Major Mvmt	NBT	NBR	EBLn1	WBLn1	SBL	SBT	SBR
Capacity (veh/h)	-	-	508	427	542	-	-
HCM Lane V/C Ratio	-	-	0.011	0.013	0.01	-	-
HCM Control Delay (s)	-	-	12.2	13.5	11.7	-	-
HCM Lane LOS	-	-	B	B	B	-	-
HCM 95th %tile Q(veh)	-	-	0	0	0	-	-

Queues
4: S Meridian & 15th Ave SW/SE

Puyallup Arco
Future (2025) Without-Project Weekday AM Peak Hour



Lane Group	EBL	EBT	WBL	WBT	WBR	NBL	NBT	SBL	SBT
Lane Group Flow (vph)	174	297	73	101	140	135	1034	348	691
v/c Ratio	0.62	0.85	0.46	0.48	0.40	0.43	1.06	0.96	0.45
Control Delay	46.2	67.4	41.1	58.2	4.5	21.7	88.8	76.2	26.1
Queue Delay	0.0	0.0	0.0	0.0	0.0	0.0	0.0	0.0	0.0
Total Delay	46.2	67.4	41.1	58.2	4.5	21.7	88.8	76.2	26.1
Queue Length 50th (ft)	116	228	45	80	0	53	~546	243	204
Queue Length 95th (ft)	158	308	73	126	10	105	#791	#448	305
Internal Link Dist (ft)		129		551			458		189
Turn Bay Length (ft)	125		225		225	135		160	
Base Capacity (vph)	312	393	248	346	450	337	977	391	1519
Starvation Cap Reductn	0	0	0	0	0	0	0	0	0
Spillback Cap Reductn	0	0	0	0	0	0	0	0	0
Storage Cap Reductn	0	0	0	0	0	0	0	0	0
Reduced v/c Ratio	0.56	0.76	0.29	0.29	0.31	0.40	1.06	0.89	0.45























Intersection Summary

~ Volume exceeds capacity, queue is theoretically infinite.
Queue shown is maximum after two cycles.

95th percentile volume exceeds capacity, queue may be longer.
Queue shown is maximum after two cycles.

HCM 6th Signalized Intersection Summary
4: S Meridian & 15th Ave SW/SE

Puyallup Arco
Future (2025) Without-Project Weekday AM Peak Hour

												
Movement	EBL	EBT	EBR	WBL	WBT	WBR	NBL	NBT	NBR	SBL	SBT	SBR
Lane Configurations												
Traffic Volume (veh/h)	155	165	100	65	90	125	120	855	65	310	565	50
Future Volume (veh/h)	155	165	100	65	90	125	120	855	65	310	565	50
Initial Q (Qb), veh	0	0	0	0	0	0	0	0	0	0	0	0
Ped-Bike Adj(A_pbT)	1.00		1.00	1.00		1.00	1.00		1.00	1.00		1.00
Parking Bus, Adj	1.00	1.00	1.00	1.00	1.00	1.00	1.00	1.00	1.00	1.00	1.00	1.00
Work Zone On Approach		No			No			No			No	
Adj Sat Flow, veh/h/ln	1709	1709	1709	1736	1736	1736	1723	1723	1723	1709	1709	1709
Adj Flow Rate, veh/h	174	185	112	73	101	140	135	961	73	348	635	56
Peak Hour Factor	0.89	0.89	0.89	0.89	0.89	0.89	0.89	0.89	0.89	0.89	0.89	0.89
Percent Heavy Veh, %	3	3	3	1	1	1	2	2	2	3	3	3
Cap, veh/h	221	197	119	84	306	258	452	1392	106	257	1564	138
Arrive On Green	0.02	0.20	0.20	0.02	0.18	0.18	0.02	0.45	0.47	0.12	1.00	1.00
Sat Flow, veh/h	1628	995	602	1654	1736	1469	1641	3082	234	1628	3018	266
Grp Volume(v), veh/h	174	0	297	73	101	140	135	510	524	348	341	350
Grp Sat Flow(s),veh/h/ln	1628	0	1597	1654	1736	1469	1641	1637	1680	1628	1624	1660
Q Serve(g_s), s	2.0	0.0	23.8	2.2	6.6	11.3	2.0	32.3	32.2	7.6	0.0	0.0
Cycle Q Clear(g_c), s	2.0	0.0	23.8	2.2	6.6	11.3	2.0	32.3	32.2	7.6	0.0	0.0
Prop In Lane	1.00		0.38	1.00		1.00	1.00		0.14	1.00		0.16
Lane Grp Cap(c), veh/h	221	0	316	84	306	258	452	739	759	257	841	860
V/C Ratio(X)	0.79	0.00	0.94	0.87	0.33	0.54	0.30	0.69	0.69	1.35	0.41	0.41
Avail Cap(c_a), veh/h	367	0	365	221	347	294	520	739	759	491	841	860
HCM Platoon Ratio	1.00	1.00	1.00	1.00	1.00	1.00	1.00	1.00	1.00	2.00	2.00	2.00
Upstream Filter(I)	1.00	0.00	1.00	1.00	1.00	1.00	1.00	1.00	1.00	1.00	1.00	1.00
Uniform Delay (d), s/veh	55.0	0.0	51.3	55.3	46.9	48.8	17.9	28.4	28.2	36.3	0.0	0.0
Incr Delay (d2), s/veh	2.3	0.0	28.4	9.7	0.2	0.7	0.1	5.2	5.1	169.8	1.5	1.4
Initial Q Delay(d3),s/veh	0.0	0.0	0.0	0.0	0.0	0.0	0.0	0.0	0.0	0.0	0.0	0.0
%ile BackOfQ(50%),veh/ln	4.9	0.0	11.9	1.6	2.9	4.2	1.4	13.5	13.7	17.2	0.3	0.3
Unsig. Movement Delay, s/veh												
LnGrp Delay(d),s/veh	57.3	0.0	79.7	65.0	47.1	49.4	18.0	33.7	33.3	206.1	1.5	1.4
LnGrp LOS	E	A	E	E	D	D	B	C	C	F	A	A
Approach Vol, veh/h		471			314			1169			1039	
Approach Delay, s/veh		71.4			52.3			31.7			70.0	
Approach LOS		E			D			C			E	
Timer - Assigned Phs	1	2	3	4	5	6	7	8				
Phs Duration (G+Y+Rc), s	11.7	74.1	11.7	32.6	16.9	68.8	11.3	32.9				
Change Period (Y+Rc), s	* 6.7	* 6.7	* 6.7	* 6.7	* 6.7	* 6.7	* 6.7	* 6.7				
Max Green Setting (Gmax), s	* 10	* 47	* 17	* 29	* 29	* 28	* 15	* 30				
Max Q Clear Time (g_c+I1), s	4.0	2.0	4.0	13.3	9.6	34.3	4.2	25.8				
Green Ext Time (p_c), s	0.0	1.4	0.1	0.2	0.1	0.0	0.0	0.3				

Intersection Summary

HCM 6th Ctrl Delay	53.4
HCM 6th LOS	D

Notes

* HCM 6th computational engine requires equal clearance times for the phases crossing the barrier.

HCM 6th TWSC
5: Ex Driveway & 15th Ave SW

Puyallup Arco
Future (2025) Without-Project Weekday AM Peak Hour

Intersection												
Int Delay, s/veh	0.9											
Movement	EBL	EBT	EBR	WBL	WBT	WBR	NBL	NBT	NBR	SBL	SBT	SBR
Lane Configurations	↖	↗		↖	↗			↕			↕	
Traffic Vol, veh/h	5	345	10	10	230	10	5	0	15	10	0	5
Future Vol, veh/h	5	345	10	10	230	10	5	0	15	10	0	5
Conflicting Peds, #/hr	1	0	2	3	0	2	2	0	3	2	0	1
Sign Control	Free	Free	Free	Free	Free	Free	Stop	Stop	Stop	Stop	Stop	Stop
RT Channelized	-	-	None	-	-	None	-	-	None	-	-	None
Storage Length	50	-	-	50	-	-	-	-	-	-	-	-
Veh in Median Storage, #	-	0	-	-	0	-	-	0	-	-	0	-
Grade, %	-	0	-	-	0	-	-	0	-	-	0	-
Peak Hour Factor	80	80	80	80	80	80	80	80	80	80	80	80
Heavy Vehicles, %	3	3	3	3	3	3	11	11	11	9	9	9
Mvmt Flow	6	431	13	13	288	13	6	0	19	13	0	6

Major/Minor	Major1			Major2			Minor1			Minor2		
Conflicting Flow All	303	0	0	447	0	0	779	782	444	785	782	299
Stage 1	-	-	-	-	-	-	453	453	-	323	323	-
Stage 2	-	-	-	-	-	-	326	329	-	462	459	-
Critical Hdwy	4.13	-	-	4.13	-	-	7.21	6.61	6.31	7.19	6.59	6.29
Critical Hdwy Stg 1	-	-	-	-	-	-	6.21	5.61	-	6.19	5.59	-
Critical Hdwy Stg 2	-	-	-	-	-	-	6.21	5.61	-	6.19	5.59	-
Follow-up Hdwy	2.227	-	-	2.227	-	-	3.599	4.099	3.399	3.581	4.081	3.381
Pot Cap-1 Maneuver	1252	-	-	1108	-	-	303	316	595	302	318	724
Stage 1	-	-	-	-	-	-	569	555	-	675	638	-
Stage 2	-	-	-	-	-	-	668	631	-	567	555	-
Platoon blocked, %	-	-	-	-	-	-	-	-	-	-	-	-
Mov Cap-1 Maneuver	1250	-	-	1105	-	-	295	309	592	288	311	721
Mov Cap-2 Maneuver	-	-	-	-	-	-	295	309	-	288	311	-
Stage 1	-	-	-	-	-	-	564	551	-	670	629	-
Stage 2	-	-	-	-	-	-	653	622	-	545	551	-

Approach	EB			WB			NB			SB		
HCM Control Delay, s	0.1			0.3			13			15.5		
HCM LOS							B			C		

Minor Lane/Major Mvmt	NBLn1	EBL	EBT	EBR	WBL	WBT	WBR	SBLn1
Capacity (veh/h)	473	1250	-	-	1105	-	-	360
HCM Lane V/C Ratio	0.053	0.005	-	-	0.011	-	-	0.052
HCM Control Delay (s)	13	7.9	-	-	8.3	-	-	15.5
HCM Lane LOS	B	A	-	-	A	-	-	C
HCM 95th %tile Q(veh)	0.2	0	-	-	0	-	-	0.2

Queues

1: S Meridian & SR 512 EB Ramps

Puyallup Arco

Future (2025) Without-Project Weekday PM Peak Hour



Lane Group	EBT	EBR	NBT	SBL	SBT
Lane Group Flow (vph)	157	71	1207	51	1424
v/c Ratio	0.88	0.31	0.53	0.17	0.55
Control Delay	94.8	11.7	4.6	4.1	5.7
Queue Delay	0.0	0.0	0.2	0.0	0.0
Total Delay	94.8	11.7	4.8	4.1	5.7
Queue Length 50th (ft)	121	0	97	7	183
Queue Length 95th (ft)	#238	36	123	15	224
Internal Link Dist (ft)	199		85		474
Turn Bay Length (ft)				50	
Base Capacity (vph)	190	242	2273	318	2602
Starvation Cap Reductn	0	0	389	0	0
Spillback Cap Reductn	0	0	0	0	0
Storage Cap Reductn	0	0	0	0	0
Reduced v/c Ratio	0.83	0.29	0.64	0.16	0.55

Intersection Summary

95th percentile volume exceeds capacity, queue may be longer.
 Queue shown is maximum after two cycles.

HCM 6th Signalized Intersection Summary
 1: S Meridian & SR 512 EB Ramps

Puyallup Arco
 Future (2025) Without-Project Weekday PM Peak Hour



Movement	EBL	EBT	EBR	WBL	WBT	WBR	NBL	NBT	NBR	SBL	SBT	SBR
Lane Configurations		↕	↗					↕↗		↗	↕↕	
Traffic Volume (veh/h)	150	5	70	0	0	0	0	785	410	50	1410	0
Future Volume (veh/h)	150	5	70	0	0	0	0	785	410	50	1410	0
Initial Q (Qb), veh	0	0	0				0	0	0	0	0	0
Ped-Bike Adj(A_pbT)	1.00		1.00				1.00		1.00	1.00		1.00
Parking Bus, Adj	1.00	1.00	1.00				1.00	1.00	1.00	1.00	1.00	1.00
Work Zone On Approach		No						No			No	
Adj Sat Flow, veh/h/ln	1723	1723	1723				0	1736	1736	1736	1736	0
Adj Flow Rate, veh/h	152	5	0				0	793	414	51	1424	0
Peak Hour Factor	0.99	0.99	0.99				0.99	0.99	0.99	0.99	0.99	0.99
Percent Heavy Veh, %	2	2	2				0	1	1	1	1	0
Cap, veh/h	175	6					0	1481	769	446	2605	0
Arrive On Green	0.11	0.11	0.00				0.00	1.00	1.00	0.03	0.79	0.00
Sat Flow, veh/h	1591	52	1460				0	2186	1090	1654	3386	0
Grp Volume(v), veh/h	157	0	0				0	622	585	51	1424	0
Grp Sat Flow(s),veh/h/ln	1643	0	1460				0	1650	1539	1654	1650	0
Q Serve(g_s), s	11.3	0.0	0.0				0.0	0.0	0.0	0.9	19.2	0.0
Cycle Q Clear(g_c), s	11.3	0.0	0.0				0.0	0.0	0.0	0.9	19.2	0.0
Prop In Lane	0.97		1.00				0.00		0.71	1.00		0.00
Lane Grp Cap(c), veh/h	181	0					0	1164	1086	446	2605	0
V/C Ratio(X)	0.87	0.00					0.00	0.53	0.54	0.11	0.55	0.00
Avail Cap(c_a), veh/h	192	0					0	1164	1086	472	2605	0
HCM Platoon Ratio	1.00	1.00	1.00				1.00	2.00	2.00	1.00	1.00	1.00
Upstream Filter(I)	1.00	0.00	0.00				0.00	1.00	1.00	1.00	1.00	0.00
Uniform Delay (d), s/veh	52.5	0.0	0.0				0.0	0.0	0.0	3.7	4.7	0.0
Incr Delay (d2), s/veh	29.0	0.0	0.0				0.0	1.8	1.9	0.0	0.8	0.0
Initial Q Delay(d3),s/veh	0.0	0.0	0.0				0.0	0.0	0.0	0.0	0.0	0.0
%ile BackOfQ(50%),veh/ln	6.1	0.0	0.0				0.0	0.6	0.6	0.3	5.2	0.0
Unsig. Movement Delay, s/veh												
LnGrp Delay(d),s/veh	81.6	0.0	0.0				0.0	1.8	1.9	3.7	5.5	0.0
LnGrp LOS	F	A					A	A	A	A	A	A
Approach Vol, veh/h		157						1207			1475	
Approach Delay, s/veh		81.6						1.8			5.4	
Approach LOS		F						A			A	
Timer - Assigned Phs		2			5	6		8				
Phs Duration (G+Y+Rc), s		100.8			10.1	90.7		19.2				
Change Period (Y+Rc), s		6.0			6.0	6.0		6.0				
Max Green Setting (Gmax), s		94.0			6.0	82.0		14.0				
Max Q Clear Time (g_c+I1), s		21.2			2.9	2.0		13.3				
Green Ext Time (p_c), s		4.6			0.0	3.0		0.0				

Intersection Summary

HCM 6th Ctrl Delay	8.1
HCM 6th LOS	A

Notes

User approved pedestrian interval to be less than phase max green.
 Unsignalized Delay for [EBR] is excluded from calculations of the approach delay and intersection delay.

Intersection						
Int Delay, s/veh	0.8					
Movement	WBL	WBR	NBT	NBR	SBL	SBT
Lane Configurations		↗	↕			↕
Traffic Vol, veh/h	0	135	1065	20	0	1480
Future Vol, veh/h	0	135	1065	20	0	1480
Conflicting Peds, #/hr	0	0	0	0	0	0
Sign Control	Stop	Stop	Free	Free	Free	Free
RT Channelized	-	None	-	None	-	None
Storage Length	-	0	-	-	-	-
Veh in Median Storage, #	0	-	0	-	-	0
Grade, %	0	-	0	-	-	0
Peak Hour Factor	98	98	98	98	98	98
Heavy Vehicles, %	4	4	1	1	2	2
Mvmt Flow	0	138	1087	20	0	1510

Major/Minor	Minor1	Major1	Major2		
Conflicting Flow All	-	554	0	0	-
Stage 1	-	-	-	-	-
Stage 2	-	-	-	-	-
Critical Hdwy	-	6.98	-	-	-
Critical Hdwy Stg 1	-	-	-	-	-
Critical Hdwy Stg 2	-	-	-	-	-
Follow-up Hdwy	-	3.34	-	-	-
Pot Cap-1 Maneuver	0	471	-	-	0
Stage 1	0	-	-	-	0
Stage 2	0	-	-	-	0
Platoon blocked, %					
Mov Cap-1 Maneuver	-	471	-	-	-
Mov Cap-2 Maneuver	-	-	-	-	-
Stage 1	-	-	-	-	-
Stage 2	-	-	-	-	-

Approach	WB	NB	SB
HCM Control Delay, s	15.8	0	0
HCM LOS	C		

Minor Lane/Major Mvmt	NBT	NBRWBLn1	SBT
Capacity (veh/h)	-	-	471
HCM Lane V/C Ratio	-	-	0.292
HCM Control Delay (s)	-	-	15.8
HCM Lane LOS	-	-	C
HCM 95th %tile Q(veh)	-	-	1.2

Intersection												
Int Delay, s/veh	0.1											
Movement	EBL	EBT	EBR	WBL	WBT	WBR	NBL	NBT	NBR	SBL	SBT	SBR
Lane Configurations		↕			↕			↕		↕	↕	
Traffic Vol, veh/h	0	0	5	5	0	10	0	1080	5	5	1425	15
Future Vol, veh/h	0	0	5	5	0	10	0	1080	5	5	1425	15
Conflicting Peds, #/hr	0	0	0	0	0	0	1	0	1	1	0	1
Sign Control	Stop	Stop	Stop	Stop	Stop	Stop	Free	Free	Free	Free	Free	Free
RT Channelized	-	-	None	-	-	None	-	-	None	-	-	None
Storage Length	-	-	-	-	-	-	-	-	-	50	-	-
Veh in Median Storage, #	-	0	-	-	0	-	-	0	-	-	0	-
Grade, %	-	0	-	-	0	-	-	0	-	-	0	-
Peak Hour Factor	95	95	95	95	95	95	95	95	95	95	95	95
Heavy Vehicles, %	0	0	0	0	0	0	1	1	1	2	2	2
Mvmt Flow	0	0	5	5	0	11	0	1137	5	5	1500	16

Major/Minor	Minor2		Minor1		Major1			Major2				
Conflicting Flow All	2088	2662	759	1901	2668	572	-	0	0	1143	0	0
Stage 1	1519	1519	-	1141	1141	-	-	-	-	-	-	-
Stage 2	569	1143	-	760	1527	-	-	-	-	-	-	-
Critical Hdwy	7.5	6.5	6.9	7.5	6.5	6.9	-	-	-	4.14	-	-
Critical Hdwy Stg 1	6.5	5.5	-	6.5	5.5	-	-	-	-	-	-	-
Critical Hdwy Stg 2	6.5	5.5	-	6.5	5.5	-	-	-	-	-	-	-
Follow-up Hdwy	3.5	4	3.3	3.5	4	3.3	-	-	-	2.22	-	-
Pot Cap-1 Maneuver	31	23	353	43	23	468	0	-	-	607	-	-
Stage 1	127	183	-	217	278	-	0	-	-	-	-	-
Stage 2	479	277	-	369	181	-	0	-	-	-	-	-
Platoon blocked, %												
Mov Cap-1 Maneuver	30	23	353	42	23	468	-	-	-	606	-	-
Mov Cap-2 Maneuver	100	109	-	141	109	-	-	-	-	-	-	-
Stage 1	127	181	-	217	278	-	-	-	-	-	-	-
Stage 2	468	277	-	360	179	-	-	-	-	-	-	-

Approach	EB	WB	NB	SB
HCM Control Delay, s	15.4	19.5	0	0
HCM LOS	C	C		

Minor Lane/Major Mvmt	NBT	NBR	EBLn1	WBLn1	SBL	SBT	SBR
Capacity (veh/h)	-	-	353	264	606	-	-
HCM Lane V/C Ratio	-	-	0.015	0.06	0.009	-	-
HCM Control Delay (s)	-	-	15.4	19.5	11	-	-
HCM Lane LOS	-	-	C	C	B	-	-
HCM 95th %tile Q(veh)	-	-	0	0.2	0	-	-

Queues
4: S Meridian & 15th Ave SW/SE

Puyallup Arco
Future (2025) Without-Project Weekday PM Peak Hour



Lane Group	EBL	EBT	WBL	WBT	WBR	NBL	NBT	SBL	SBT
Lane Group Flow (vph)	147	252	121	184	305	116	737	168	1342
v/c Ratio	0.79	0.85	0.76	0.96	0.71	0.72	0.52	0.44	0.84
Control Delay	69.7	52.3	64.4	108.2	14.7	43.8	27.5	17.3	29.0
Queue Delay	0.0	0.0	0.0	0.0	0.0	0.0	0.0	0.0	0.0
Total Delay	69.7	52.3	64.4	108.2	14.7	43.8	27.5	17.3	29.0
Queue Length 50th (ft)	96	112	76	144	0	36	213	27	455
Queue Length 95th (ft)	141	194	116	214	84	#109	313	77	#745
Internal Link Dist (ft)		129		551			458		189
Turn Bay Length (ft)	125		225		225	135		160	
Base Capacity (vph)	204	458	166	379	556	165	1422	380	1590
Starvation Cap Reductn	0	0	0	0	0	0	0	0	0
Spillback Cap Reductn	0	0	0	0	0	0	0	0	0
Storage Cap Reductn	0	0	0	0	0	0	0	0	0
Reduced v/c Ratio	0.72	0.55	0.73	0.49	0.55	0.70	0.52	0.44	0.84

Intersection Summary

95th percentile volume exceeds capacity, queue may be longer.
Queue shown is maximum after two cycles.

HCM 6th Signalized Intersection Summary
 4: S Meridian & 15th Ave SW/SE

Puyallup Arco
 Future (2025) Without-Project Weekday PM Peak Hour

Movement	EBL	EBT	EBR	WBL	WBT	WBR	NBL	NBT	NBR	SBL	SBT	SBR
Lane Configurations												
Traffic Volume (veh/h)	140	65	175	115	175	290	110	665	35	160	1135	140
Future Volume (veh/h)	140	65	175	115	175	290	110	665	35	160	1135	140
Initial Q (Qb), veh	0	0	0	0	0	0	0	0	0	0	0	0
Ped-Bike Adj(A_pbT)	1.00		1.00	1.00		1.00	1.00		1.00	1.00		1.00
Parking Bus, Adj	1.00	1.00	1.00	1.00	1.00	1.00	1.00	1.00	1.00	1.00	1.00	1.00
Work Zone On Approach		No			No			No			No	
Adj Sat Flow, veh/h/ln	1736	1736	1736	1736	1736	1736	1736	1736	1736	1723	1723	1723
Adj Flow Rate, veh/h	147	68	184	121	184	305	116	700	37	168	1195	147
Peak Hour Factor	0.95	0.95	0.95	0.95	0.95	0.95	0.95	0.95	0.95	0.95	0.95	0.95
Percent Heavy Veh, %	1	1	1	1	1	1	1	1	1	2	2	2
Cap, veh/h	215	75	204	189	253	214	244	1017	54	414	1418	174
Arrive On Green	0.06	0.18	0.18	0.07	0.15	0.15	0.02	0.32	0.34	0.33	0.97	0.97
Sat Flow, veh/h	1654	414	1119	1654	1736	1468	1654	3186	168	1641	2933	360
Grp Volume(v), veh/h	147	0	252	121	184	305	116	362	375	168	665	677
Grp Sat Flow(s),veh/h/ln	1654	0	1533	1654	1736	1468	1654	1650	1705	1641	1637	1657
Q Serve(g_s), s	2.3	0.0	19.3	7.2	12.2	17.5	1.9	23.0	23.0	0.0	8.6	8.8
Cycle Q Clear(g_c), s	2.3	0.0	19.3	7.2	12.2	17.5	1.9	23.0	23.0	0.0	8.6	8.8
Prop In Lane	1.00		0.73	1.00		1.00	1.00		0.10	1.00		0.22
Lane Grp Cap(c), veh/h	215	0	279	189	253	214	244	526	544	414	791	801
V/C Ratio(X)	0.68	0.00	0.90	0.64	0.73	1.43	0.48	0.69	0.69	0.41	0.84	0.85
Avail Cap(c_a), veh/h	215	0	378	189	381	322	291	526	544	414	791	801
HCM Platoon Ratio	1.00	1.00	1.00	1.00	1.00	1.00	1.00	1.00	1.00	2.00	2.00	2.00
Upstream Filter(I)	1.00	0.00	1.00	1.00	1.00	1.00	1.00	1.00	1.00	1.00	1.00	1.00
Uniform Delay (d), s/veh	51.7	0.0	48.0	38.7	49.0	51.3	24.1	35.6	35.6	30.1	1.2	1.2
Incr Delay (d2), s/veh	7.2	0.0	16.6	5.6	1.5	215.4	0.5	7.2	7.0	0.2	10.5	10.6
Initial Q Delay(d3),s/veh	0.0	0.0	0.0	0.0	0.0	0.0	0.0	0.0	0.0	0.0	0.0	0.0
%ile BackOfQ(50%),veh/ln	4.6	0.0	8.6	3.2	5.3	19.1	1.6	10.1	10.4	3.4	2.9	3.0
Unsig. Movement Delay, s/veh												
LnGrp Delay(d),s/veh	58.9	0.0	64.6	44.4	50.5	266.7	24.6	42.8	42.5	30.4	11.6	11.8
LnGrp LOS	E	A	E	D	D	F	C	D	D	C	B	B
Approach Vol, veh/h		399			610			853			1510	
Approach Delay, s/veh		62.5			157.4			40.2			13.8	
Approach LOS		E			F			D			B	
Timer - Assigned Phs	1	2	3	4	5	6	7	8				
Phs Duration (G+Y+Rc), s	11.6	64.7	16.7	27.0	29.3	47.0	15.1	28.6				
Change Period (Y+Rc), s	* 6.7	* 6.7	* 6.7	* 6.7	* 6.7	* 6.7	* 6.7	* 6.7				
Max Green Setting (Gmax), s	* 8.3	* 47	* 8.7	* 29	* 15	* 40	* 8.4	* 30				
Max Q Clear Time (g_c+I1), s	3.9	10.8	4.3	19.5	2.0	25.0	9.2	21.3				
Green Ext Time (p_c), s	0.0	3.3	0.0	0.4	0.1	1.4	0.0	0.4				

Intersection Summary

HCM 6th Ctrl Delay	52.2
HCM 6th LOS	D

Notes

* HCM 6th computational engine requires equal clearance times for the phases crossing the barrier.

HCM 6th TWSC
5: Ex Driveway & 15th Ave SW

Puyallup Arco
Future (2025) Without-Project Weekday PM Peak Hour

Intersection												
Int Delay, s/veh	1.4											
Movement	EBL	EBT	EBR	WBL	WBT	WBR	NBL	NBT	NBR	SBL	SBT	SBR
Lane Configurations	↖	↗		↖	↗			↕			↕	
Traffic Vol, veh/h	5	350	10	15	400	5	10	0	15	20	5	15
Future Vol, veh/h	5	350	10	15	400	5	10	0	15	20	5	15
Conflicting Peds, #/hr	0	0	1	1	0	0	0	0	0	0	0	0
Sign Control	Free	Free	Free	Free	Free	Free	Stop	Stop	Stop	Stop	Stop	Stop
RT Channelized	-	-	None	-	-	None	-	-	None	-	-	None
Storage Length	50	-	-	50	-	-	-	-	-	-	-	-
Veh in Median Storage, #	-	0	-	-	0	-	-	0	-	-	0	-
Grade, %	-	0	-	-	0	-	-	0	-	-	0	-
Peak Hour Factor	95	95	95	95	95	95	95	95	95	95	95	95
Heavy Vehicles, %	1	1	1	2	2	2	0	0	0	3	3	3
Mvmt Flow	5	368	11	16	421	5	11	0	16	21	5	16

Major/Minor	Major1			Major2			Minor1			Minor2		
Conflicting Flow All	426	0	0	380	0	0	851	843	375	848	846	424
Stage 1	-	-	-	-	-	-	385	385	-	456	456	-
Stage 2	-	-	-	-	-	-	466	458	-	392	390	-
Critical Hdwy	4.11	-	-	4.12	-	-	7.1	6.5	6.2	7.13	6.53	6.23
Critical Hdwy Stg 1	-	-	-	-	-	-	6.1	5.5	-	6.13	5.53	-
Critical Hdwy Stg 2	-	-	-	-	-	-	6.1	5.5	-	6.13	5.53	-
Follow-up Hdwy	2.209	-	-	2.218	-	-	3.5	4	3.3	3.527	4.027	3.327
Pot Cap-1 Maneuver	1139	-	-	1178	-	-	282	303	676	280	298	628
Stage 1	-	-	-	-	-	-	642	614	-	582	566	-
Stage 2	-	-	-	-	-	-	581	570	-	631	606	-
Platoon blocked, %	-	-	-	-	-	-	-	-	-	-	-	-
Mov Cap-1 Maneuver	1139	-	-	1177	-	-	267	297	675	270	292	628
Mov Cap-2 Maneuver	-	-	-	-	-	-	267	297	-	270	292	-
Stage 1	-	-	-	-	-	-	639	611	-	580	558	-
Stage 2	-	-	-	-	-	-	553	562	-	614	603	-

Approach	EB			WB			NB			SB		
HCM Control Delay, s	0.1			0.3			14.2			16.8		
HCM LOS							B			C		

Minor Lane/Major Mvmt	NBLn1	EBL	EBT	EBR	WBL	WBT	WBR	SBLn1
Capacity (veh/h)	419	1139	-	-	1177	-	-	348
HCM Lane V/C Ratio	0.063	0.005	-	-	0.013	-	-	0.121
HCM Control Delay (s)	14.2	8.2	-	-	8.1	-	-	16.8
HCM Lane LOS	B	A	-	-	A	-	-	C
HCM 95th %tile Q(veh)	0.2	0	-	-	0	-	-	0.4

Intersection												
Int Delay, s/veh	0.8											
Movement	EBL	EBT	EBR	WBL	WBT	WBR	NBL	NBT	NBR	SBL	SBT	SBR
Lane Configurations		↕			↕			↕		↕	↕	↕
Traffic Vol, veh/h	0	0	117	0	0	5	0	1152	5	5	822	130
Future Vol, veh/h	0	0	117	0	0	5	0	1152	5	5	822	130
Conflicting Peds, #/hr	2	0	2	1	0	1	2	0	1	1	0	2
Sign Control	Stop	Stop	Stop	Stop	Stop	Stop	Free	Free	Free	Free	Free	Free
RT Channelized	-	-	None	-	-	None	-	-	None	-	-	None
Storage Length	-	-	-	-	-	-	-	-	-	50	-	-
Veh in Median Storage, #	-	0	-	-	0	-	-	0	-	-	0	-
Grade, %	-	0	-	-	0	-	-	0	-	-	0	-
Peak Hour Factor	91	91	91	91	91	91	91	91	91	91	91	91
Heavy Vehicles, %	0	0	0	0	0	0	2	2	2	3	3	3
Mvmt Flow	0	0	129	0	0	5	0	1266	5	5	903	143

Major/Minor	Minor2		Minor1		Major1			Major2				
Conflicting Flow All	1622	2259	527	1734	2328	639	-	0	0	1272	0	0
Stage 1	987	987	-	1270	1270	-	-	-	-	-	-	-
Stage 2	635	1272	-	464	1058	-	-	-	-	-	-	-
Critical Hdwy	7.5	6.5	6.9	7.5	6.5	6.9	-	-	-	4.16	-	-
Critical Hdwy Stg 1	6.5	5.5	-	6.5	5.5	-	-	-	-	-	-	-
Critical Hdwy Stg 2	6.5	5.5	-	6.5	5.5	-	-	-	-	-	-	-
Follow-up Hdwy	3.5	4	3.3	3.5	4	3.3	-	-	-	2.23	-	-
Pot Cap-1 Maneuver	70	42	501	57	38	424	0	-	-	536	-	-
Stage 1	269	328	-	181	241	-	0	-	-	-	-	-
Stage 2	438	241	-	553	304	-	0	-	-	-	-	-
Platoon blocked, %												
Mov Cap-1 Maneuver	68	41	499	42	38	423	-	-	-	535	-	-
Mov Cap-2 Maneuver	180	143	-	130	139	-	-	-	-	-	-	-
Stage 1	269	324	-	181	241	-	-	-	-	-	-	-
Stage 2	431	241	-	406	301	-	-	-	-	-	-	-

Approach	EB		WB		NB			SB		
HCM Control Delay, s	14.7		13.6		0			0.1		
HCM LOS	B		B							

Minor Lane/Major Mvmt	NBT	NBR	EBLn1	WBLn1	SBL	SBT	SBR
Capacity (veh/h)	-	-	499	423	535	-	-
HCM Lane V/C Ratio	-	-	0.258	0.013	0.01	-	-
HCM Control Delay (s)	-	-	14.7	13.6	11.8	-	-
HCM Lane LOS	-	-	B	B	B	-	-
HCM 95th %tile Q(veh)	-	-	1	0	0	-	-

Queues
4: S Meridian & 15th Ave SW/SE

Puyallup Arco
Future (2025) With-Project Weekday AM Peak Hour



Lane Group	EBL	EBT	WBL	WBT	WBR	NBL	NBT	SBL	SBT
Lane Group Flow (vph)	188	300	73	103	140	140	1034	351	698
v/c Ratio	0.66	0.85	0.46	0.49	0.40	0.46	1.08	0.95	0.46
Control Delay	48.0	66.9	40.7	58.9	4.6	22.5	95.4	74.8	26.5
Queue Delay	0.0	0.0	0.0	0.0	0.0	0.0	0.0	0.0	0.0
Total Delay	48.0	66.9	40.7	58.9	4.6	22.5	95.4	74.8	26.5
Queue Length 50th (ft)	126	231	45	82	0	55	~554	244	208
Queue Length 95th (ft)	171	314	73	128	10	108	#791	#454	308
Internal Link Dist (ft)		129		551			458		189
Turn Bay Length (ft)	125		225		225	135		160	
Base Capacity (vph)	310	394	249	346	450	331	959	393	1506
Starvation Cap Reductn	0	0	0	0	0	0	0	0	0
Spillback Cap Reductn	0	0	0	0	0	0	0	0	0
Storage Cap Reductn	0	0	0	0	0	0	0	0	0
Reduced v/c Ratio	0.61	0.76	0.29	0.30	0.31	0.42	1.08	0.89	0.46

Intersection Summary

~ Volume exceeds capacity, queue is theoretically infinite.
Queue shown is maximum after two cycles.

95th percentile volume exceeds capacity, queue may be longer.
Queue shown is maximum after two cycles.

HCM 6th Signalized Intersection Summary
4: S Meridian & 15th Ave SW/SE

Puyallup Arco
Future (2025) With-Project Weekday AM Peak Hour



Movement	EBL	EBT	EBR	WBL	WBT	WBR	NBL	NBT	NBR	SBL	SBT	SBR
Lane Configurations	↖	↗		↖	↖	↗	↖	↖↗		↖	↖↗	
Traffic Volume (veh/h)	167	167	100	65	92	125	125	855	65	312	571	50
Future Volume (veh/h)	167	167	100	65	92	125	125	855	65	312	571	50
Initial Q (Qb), veh	0	0	0	0	0	0	0	0	0	0	0	0
Ped-Bike Adj(A_pbT)	1.00		1.00	1.00		1.00	1.00		1.00	1.00		1.00
Parking Bus, Adj	1.00	1.00	1.00	1.00	1.00	1.00	1.00	1.00	1.00	1.00	1.00	1.00
Work Zone On Approach		No			No			No			No	
Adj Sat Flow, veh/h/ln	1709	1709	1709	1736	1736	1736	1723	1723	1723	1709	1709	1709
Adj Flow Rate, veh/h	188	188	112	73	103	140	140	961	73	351	642	56
Peak Hour Factor	0.89	0.89	0.89	0.89	0.89	0.89	0.89	0.89	0.89	0.89	0.89	0.89
Percent Heavy Veh, %	3	3	3	1	1	1	2	2	2	3	3	3
Cap, veh/h	222	200	119	84	308	261	449	1380	105	258	1561	136
Arrive On Green	0.02	0.20	0.20	0.02	0.18	0.18	0.02	0.45	0.47	0.12	1.00	1.00
Sat Flow, veh/h	1628	1002	597	1654	1736	1469	1641	3082	234	1628	3021	263
Grp Volume(v), veh/h	188	0	300	73	103	140	140	510	524	351	345	353
Grp Sat Flow(s),veh/h/ln	1628	0	1598	1654	1736	1469	1641	1637	1680	1628	1624	1661
Q Serve(g_s), s	2.0	0.0	24.0	2.2	6.7	11.3	2.0	32.5	32.4	7.9	0.0	0.0
Cycle Q Clear(g_c), s	2.0	0.0	24.0	2.2	6.7	11.3	2.0	32.5	32.4	7.9	0.0	0.0
Prop In Lane	1.00		0.37	1.00		1.00	1.00		0.14	1.00		0.16
Lane Grp Cap(c), veh/h	222	0	319	84	308	261	449	733	752	258	839	858
V/C Ratio(X)	0.85	0.00	0.94	0.87	0.33	0.54	0.31	0.70	0.70	1.36	0.41	0.41
Avail Cap(c_a), veh/h	367	0	365	221	347	294	516	733	752	488	839	858
HCM Platoon Ratio	1.00	1.00	1.00	1.00	1.00	1.00	1.00	1.00	1.00	2.00	2.00	2.00
Upstream Filter(I)	1.00	0.00	1.00	1.00	1.00	1.00	1.00	1.00	1.00	1.00	1.00	1.00
Uniform Delay (d), s/veh	55.7	0.0	51.2	55.2	46.7	48.6	18.1	28.8	28.6	35.9	0.0	0.0
Incr Delay (d2), s/veh	4.3	0.0	28.9	9.8	0.2	0.6	0.1	5.4	5.3	173.9	1.5	1.5
Initial Q Delay(d3),s/veh	0.0	0.0	0.0	0.0	0.0	0.0	0.0	0.0	0.0	0.0	0.0	0.0
%ile BackOfQ(50%),veh/ln	5.6	0.0	12.1	1.6	2.9	4.2	1.5	13.6	13.8	17.5	0.3	0.3
Unsig. Movement Delay, s/veh												
LnGrp Delay(d),s/veh	60.0	0.0	80.1	65.0	47.0	49.2	18.3	34.2	33.9	209.8	1.5	1.5
LnGrp LOS	E	A	F	E	D	D	B	C	C	F	A	A
Approach Vol, veh/h		488			316			1174			1049	
Approach Delay, s/veh		72.3			52.1			32.2			71.2	
Approach LOS		E			D			C			E	
Timer - Assigned Phs	1	2	3	4	5	6	7	8				
Phs Duration (G+Y+Rc), s	11.7	73.9	11.7	32.8	17.2	68.3	11.3	33.1				
Change Period (Y+Rc), s	* 6.7	* 6.7	* 6.7	* 6.7	* 6.7	* 6.7	* 6.7	* 6.7				
Max Green Setting (Gmax), s	* 10	* 47	* 17	* 29	* 29	* 28	* 15	* 30				
Max Q Clear Time (g_c+I1), s	4.0	2.0	4.0	13.3	9.9	34.5	4.2	26.0				
Green Ext Time (p_c), s	0.0	1.4	0.1	0.2	0.1	0.0	0.0	0.3				

Intersection Summary

HCM 6th Ctrl Delay	54.3
HCM 6th LOS	D

Notes

* HCM 6th computational engine requires equal clearance times for the phases crossing the barrier.

HCM 6th TWSC
5: Ex Driveway & 15th Ave SW

Puyallup Arco
Future (2025) With-Project Weekday AM Peak Hour

Intersection												
Int Delay, s/veh	1.5											
Movement	EBL	EBT	EBR	WBL	WBT	WBR	NBL	NBT	NBR	SBL	SBT	SBR
Lane Configurations	↖	↗		↖	↗			↕			↕	
Traffic Vol, veh/h	8	345	10	10	230	17	5	0	15	24	0	13
Future Vol, veh/h	8	345	10	10	230	17	5	0	15	24	0	13
Conflicting Peds, #/hr	1	0	2	3	0	2	2	0	3	2	0	1
Sign Control	Free	Free	Free	Free	Free	Free	Stop	Stop	Stop	Stop	Stop	Stop
RT Channelized	-	-	None	-	-	None	-	-	None	-	-	None
Storage Length	50	-	-	50	-	-	-	-	-	-	-	-
Veh in Median Storage, #	-	0	-	-	0	-	-	0	-	-	0	-
Grade, %	-	0	-	-	0	-	-	0	-	-	0	-
Peak Hour Factor	80	80	80	80	80	80	80	80	80	80	80	80
Heavy Vehicles, %	3	3	3	3	3	3	11	11	11	9	9	9
Mvmt Flow	10	431	13	13	288	21	6	0	19	30	0	16

Major/Minor	Major1			Major2			Minor1			Minor2		
Conflicting Flow All	311	0	0	447	0	0	796	798	444	797	794	303
Stage 1	-	-	-	-	-	-	461	461	-	327	327	-
Stage 2	-	-	-	-	-	-	335	337	-	470	467	-
Critical Hdwy	4.13	-	-	4.13	-	-	7.21	6.61	6.31	7.19	6.59	6.29
Critical Hdwy Stg 1	-	-	-	-	-	-	6.21	5.61	-	6.19	5.59	-
Critical Hdwy Stg 2	-	-	-	-	-	-	6.21	5.61	-	6.19	5.59	-
Follow-up Hdwy	2.227	-	-	2.227	-	-	3.599	4.099	3.399	3.581	4.081	3.381
Pot Cap-1 Maneuver	1244	-	-	1108	-	-	295	309	595	296	313	721
Stage 1	-	-	-	-	-	-	564	550	-	671	635	-
Stage 2	-	-	-	-	-	-	660	625	-	561	550	-
Platoon blocked, %	-	-	-	-	-	-	-	-	-	-	-	-
Mov Cap-1 Maneuver	1242	-	-	1105	-	-	283	301	592	281	305	718
Mov Cap-2 Maneuver	-	-	-	-	-	-	283	301	-	281	305	-
Stage 1	-	-	-	-	-	-	558	544	-	664	626	-
Stage 2	-	-	-	-	-	-	636	616	-	537	544	-

Approach	EB			WB			NB			SB		
HCM Control Delay, s	0.2			0.3			13.2			16.6		
HCM LOS							B			C		

Minor Lane/Major Mvmt	NBLn1	EBL	EBT	EBR	WBL	WBT	WBR	SBLn1
Capacity (veh/h)	465	1242	-	-	1105	-	-	357
HCM Lane V/C Ratio	0.054	0.008	-	-	0.011	-	-	0.13
HCM Control Delay (s)	13.2	7.9	-	-	8.3	-	-	16.6
HCM Lane LOS	B	A	-	-	A	-	-	C
HCM 95th %tile Q(veh)	0.2	0	-	-	0	-	-	0.4

Queues

1: S Meridian & SR 512 EB Ramps

Puyallup Arco

Future (2025) With-Project Weekday PM Peak Hour



Lane Group	EBT	EBR	NBT	SBL	SBT
Lane Group Flow (vph)	157	76	1221	51	1437
v/c Ratio	0.88	0.33	0.54	0.17	0.55
Control Delay	94.8	13.2	4.6	4.1	5.7
Queue Delay	0.0	0.0	0.3	0.0	0.0
Total Delay	94.8	13.2	4.8	4.1	5.7
Queue Length 50th (ft)	121	0	103	7	186
Queue Length 95th (ft)	#238	42	123	15	228
Internal Link Dist (ft)	199		85		474
Turn Bay Length (ft)				50	
Base Capacity (vph)	190	242	2273	314	2602
Starvation Cap Reductn	0	0	389	0	0
Spillback Cap Reductn	0	0	0	0	0
Storage Cap Reductn	0	0	0	0	0
Reduced v/c Ratio	0.83	0.31	0.65	0.16	0.55

Intersection Summary

95th percentile volume exceeds capacity, queue may be longer.
 Queue shown is maximum after two cycles.

HCM 6th Signalized Intersection Summary

Puyallup Arco

1: S Meridian & SR 512 EB Ramps

Future (2025) With-Project Weekday PM Peak Hour



Movement	EBL	EBT	EBR	WBL	WBT	WBR	NBL	NBT	NBR	SBL	SBT	SBR
Lane Configurations		↖	↗					↖↗		↖	↖↗	
Traffic Volume (veh/h)	150	5	75	0	0	0	0	794	415	50	1423	0
Future Volume (veh/h)	150	5	75	0	0	0	0	794	415	50	1423	0
Initial Q (Qb), veh	0	0	0				0	0	0	0	0	0
Ped-Bike Adj(A_pbT)	1.00		1.00				1.00		1.00	1.00		1.00
Parking Bus, Adj	1.00	1.00	1.00				1.00	1.00	1.00	1.00	1.00	1.00
Work Zone On Approach		No						No			No	
Adj Sat Flow, veh/h/ln	1723	1723	1723				0	1736	1736	1736	1736	0
Adj Flow Rate, veh/h	152	5	0				0	802	419	51	1437	0
Peak Hour Factor	0.99	0.99	0.99				0.99	0.99	0.99	0.99	0.99	0.99
Percent Heavy Veh, %	2	2	2				0	1	1	1	1	0
Cap, veh/h	175	6					0	1481	769	441	2605	0
Arrive On Green	0.11	0.11	0.00				0.00	1.00	1.00	0.03	0.79	0.00
Sat Flow, veh/h	1591	52	1460				0	2185	1090	1654	3386	0
Grp Volume(v), veh/h	157	0	0				0	629	592	51	1437	0
Grp Sat Flow(s),veh/h/ln	1643	0	1460				0	1650	1539	1654	1650	0
Q Serve(g_s), s	11.3	0.0	0.0				0.0	0.0	0.0	0.9	19.5	0.0
Cycle Q Clear(g_c), s	11.3	0.0	0.0				0.0	0.0	0.0	0.9	19.5	0.0
Prop In Lane	0.97		1.00				0.00		0.71	1.00		0.00
Lane Grp Cap(c), veh/h	181	0					0	1164	1086	441	2605	0
V/C Ratio(X)	0.87	0.00					0.00	0.54	0.54	0.12	0.55	0.00
Avail Cap(c_a), veh/h	192	0					0	1164	1086	468	2605	0
HCM Platoon Ratio	1.00	1.00	1.00				1.00	2.00	2.00	1.00	1.00	1.00
Upstream Filter(I)	1.00	0.00	0.00				0.00	1.00	1.00	1.00	1.00	0.00
Uniform Delay (d), s/veh	52.5	0.0	0.0				0.0	0.0	0.0	3.7	4.7	0.0
Incr Delay (d2), s/veh	29.0	0.0	0.0				0.0	1.8	2.0	0.0	0.8	0.0
Initial Q Delay(d3),s/veh	0.0	0.0	0.0				0.0	0.0	0.0	0.0	0.0	0.0
%ile BackOfQ(50%),veh/ln	6.1	0.0	0.0				0.0	0.6	0.6	0.3	5.3	0.0
Unsig. Movement Delay, s/veh												
LnGrp Delay(d),s/veh	81.6	0.0	0.0				0.0	1.8	2.0	3.7	5.5	0.0
LnGrp LOS	F	A					A	A	A	A	A	A
Approach Vol, veh/h		157						1221			1488	
Approach Delay, s/veh		81.6						1.9			5.5	
Approach LOS		F						A			A	
Timer - Assigned Phs		2			5	6		8				
Phs Duration (G+Y+Rc), s		100.8			10.1	90.7		19.2				
Change Period (Y+Rc), s		6.0			6.0	6.0		6.0				
Max Green Setting (Gmax), s		94.0			6.0	82.0		14.0				
Max Q Clear Time (g_c+I1), s		21.5			2.9	2.0		13.3				
Green Ext Time (p_c), s		4.7			0.0	3.1		0.0				

Intersection Summary

HCM 6th Ctrl Delay	8.1
HCM 6th LOS	A

Notes

User approved pedestrian interval to be less than phase max green.

Unsignalized Delay for [EBR] is excluded from calculations of the approach delay and intersection delay.

Intersection						
Int Delay, s/veh	0.8					
Movement	WBL	WBR	NBT	NBR	SBL	SBT
Lane Configurations		↗	↕			↕
Traffic Vol, veh/h	0	135	1079	20	0	1498
Future Vol, veh/h	0	135	1079	20	0	1498
Conflicting Peds, #/hr	0	0	0	0	0	0
Sign Control	Stop	Stop	Free	Free	Free	Free
RT Channelized	-	None	-	None	-	None
Storage Length	-	0	-	-	-	-
Veh in Median Storage, #	0	-	0	-	-	0
Grade, %	0	-	0	-	-	0
Peak Hour Factor	98	98	98	98	98	98
Heavy Vehicles, %	4	4	1	1	2	2
Mvmt Flow	0	138	1101	20	0	1529

Major/Minor	Minor1	Major1	Major2		
Conflicting Flow All	-	561	0	0	-
Stage 1	-	-	-	-	-
Stage 2	-	-	-	-	-
Critical Hdwy	-	6.98	-	-	-
Critical Hdwy Stg 1	-	-	-	-	-
Critical Hdwy Stg 2	-	-	-	-	-
Follow-up Hdwy	-	3.34	-	-	-
Pot Cap-1 Maneuver	0	466	-	-	0
Stage 1	0	-	-	-	0
Stage 2	0	-	-	-	0
Platoon blocked, %					
Mov Cap-1 Maneuver	-	466	-	-	-
Mov Cap-2 Maneuver	-	-	-	-	-
Stage 1	-	-	-	-	-
Stage 2	-	-	-	-	-

Approach	WB	NB	SB
HCM Control Delay, s	15.9	0	0
HCM LOS	C		

Minor Lane/Major Mvmt	NBT	NBRWBLn1	SBT
Capacity (veh/h)	-	-	466
HCM Lane V/C Ratio	-	-	0.296
HCM Control Delay (s)	-	-	15.9
HCM Lane LOS	-	-	C
HCM 95th %tile Q(veh)	-	-	1.2

Intersection												
Int Delay, s/veh	1.2											
Movement	EBL	EBT	EBR	WBL	WBT	WBR	NBL	NBT	NBR	SBL	SBT	SBR
Lane Configurations		↕			↕			↕		↕	↕	
Traffic Vol, veh/h	0	0	130	5	0	10	0	1094	5	5	1314	154
Future Vol, veh/h	0	0	130	5	0	10	0	1094	5	5	1314	154
Conflicting Peds, #/hr	0	0	0	0	0	0	1	0	1	1	0	1
Sign Control	Stop	Stop	Stop	Stop	Stop	Stop	Free	Free	Free	Free	Free	Free
RT Channelized	-	-	None	-	-	None	-	-	None	-	-	None
Storage Length	-	-	-	-	-	-	-	-	-	50	-	-
Veh in Median Storage, #	-	0	-	-	0	-	-	0	-	-	0	-
Grade, %	-	0	-	-	0	-	-	0	-	-	0	-
Peak Hour Factor	95	95	95	95	95	95	95	95	95	95	95	95
Heavy Vehicles, %	0	0	0	0	0	0	1	1	1	2	2	2
Mvmt Flow	0	0	137	5	0	11	0	1152	5	5	1383	162

Major/Minor	Minor2		Minor1			Major1			Major2			
Conflicting Flow All	2051	2633	774	1858	2712	580	-	0	0	1158	0	0
Stage 1	1475	1475	-	1156	1156	-	-	-	-	-	-	-
Stage 2	576	1158	-	702	1556	-	-	-	-	-	-	-
Critical Hdwy	7.5	6.5	6.9	7.5	6.5	6.9	-	-	-	4.14	-	-
Critical Hdwy Stg 1	6.5	5.5	-	6.5	5.5	-	-	-	-	-	-	-
Critical Hdwy Stg 2	6.5	5.5	-	6.5	5.5	-	-	-	-	-	-	-
Follow-up Hdwy	3.5	4	3.3	3.5	4	3.3	-	-	-	2.22	-	-
Pot Cap-1 Maneuver	33	24	346	46	21	463	0	-	-	599	-	-
Stage 1	135	192	-	212	273	-	0	-	-	-	-	-
Stage 2	475	273	-	400	176	-	0	-	-	-	-	-
Platoon blocked, %												
Mov Cap-1 Maneuver	32	24	346	28	21	463	-	-	-	598	-	-
Mov Cap-2 Maneuver	105	112	-	115	106	-	-	-	-	-	-	-
Stage 1	135	190	-	212	273	-	-	-	-	-	-	-
Stage 2	464	273	-	240	174	-	-	-	-	-	-	-

Approach	EB		WB			NB			SB		
HCM Control Delay, s	22.1		21.8			0			0		
HCM LOS	C		C								

Minor Lane/Major Mvmt	NBT	NBR	EBLn1	WBLn1	SBL	SBT	SBR
Capacity (veh/h)	-	-	346	230	598	-	-
HCM Lane V/C Ratio	-	-	0.395	0.069	0.009	-	-
HCM Control Delay (s)	-	-	22.1	21.8	11.1	-	-
HCM Lane LOS	-	-	C	C	B	-	-
HCM 95th %tile Q(veh)	-	-	1.8	0.2	0	-	-

Queues
4: S Meridian & 15th Ave SW/SE

Puyallup Arco
Future (2025) With-Project Weekday PM Peak Hour



Lane Group	EBL	EBT	WBL	WBT	WBR	NBL	NBT	SBL	SBT
Lane Group Flow (vph)	162	255	121	187	305	122	737	171	1349
v/c Ratio	0.85	0.85	0.76	0.96	0.70	0.75	0.52	0.45	0.86
Control Delay	78.2	53.5	64.1	108.3	14.5	48.7	27.9	18.7	31.4
Queue Delay	0.0	0.0	0.0	0.0	0.0	0.0	0.0	0.0	0.0
Total Delay	78.2	53.5	64.1	108.3	14.5	48.7	27.9	18.7	31.4
Queue Length 50th (ft)	106	119	75	146	0	40	215	30	471
Queue Length 95th (ft)	153	199	115	217	84	#138	316	85	#751
Internal Link Dist (ft)		129		551			458		189
Turn Bay Length (ft)	125		225		225	135		160	
Base Capacity (vph)	206	455	165	379	556	164	1408	377	1561
Starvation Cap Reductn	0	0	0	0	0	0	0	0	0
Spillback Cap Reductn	0	0	0	0	0	0	0	0	0
Storage Cap Reductn	0	0	0	0	0	0	0	0	0
Reduced v/c Ratio	0.79	0.56	0.73	0.49	0.55	0.74	0.52	0.45	0.86

Intersection Summary

95th percentile volume exceeds capacity, queue may be longer.
Queue shown is maximum after two cycles.

HCM 6th Signalized Intersection Summary
4: S Meridian & 15th Ave SW/SE

Puyallup Arco
Future (2025) With-Project Weekday PM Peak Hour



Movement	EBL	EBT	EBR	WBL	WBT	WBR	NBL	NBT	NBR	SBL	SBT	SBR
Lane Configurations												
Traffic Volume (veh/h)	154	67	175	115	178	290	116	665	35	162	1142	140
Future Volume (veh/h)	154	67	175	115	178	290	116	665	35	162	1142	140
Initial Q (Qb), veh	0	0	0	0	0	0	0	0	0	0	0	0
Ped-Bike Adj(A_pbT)	1.00		1.00	1.00		1.00	1.00		1.00	1.00		1.00
Parking Bus, Adj	1.00	1.00	1.00	1.00	1.00	1.00	1.00	1.00	1.00	1.00	1.00	1.00
Work Zone On Approach		No			No			No			No	
Adj Sat Flow, veh/h/ln	1736	1736	1736	1736	1736	1736	1736	1736	1736	1723	1723	1723
Adj Flow Rate, veh/h	162	71	184	121	187	305	122	700	37	171	1202	147
Peak Hour Factor	0.95	0.95	0.95	0.95	0.95	0.95	0.95	0.95	0.95	0.95	0.95	0.95
Percent Heavy Veh, %	1	1	1	1	1	1	1	1	1	2	2	2
Cap, veh/h	216	79	204	188	253	214	238	1017	54	411	1414	172
Arrive On Green	0.07	0.18	0.18	0.07	0.15	0.15	0.02	0.32	0.34	0.32	0.96	0.96
Sat Flow, veh/h	1654	427	1108	1654	1736	1468	1654	3186	168	1641	2936	358
Grp Volume(v), veh/h	162	0	255	121	187	305	122	362	375	171	668	681
Grp Sat Flow(s),veh/h/ln	1654	0	1535	1654	1736	1468	1654	1650	1705	1641	1637	1657
Q Serve(g_s), s	3.6	0.0	19.5	7.1	12.4	17.5	1.9	23.0	23.0	0.0	9.8	10.1
Cycle Q Clear(g_c), s	3.6	0.0	19.5	7.1	12.4	17.5	1.9	23.0	23.0	0.0	9.8	10.1
Prop In Lane	1.00		0.72	1.00		1.00	1.00		0.10	1.00		0.22
Lane Grp Cap(c), veh/h	216	0	282	188	253	214	238	526	544	411	788	798
V/C Ratio(X)	0.75	0.00	0.90	0.64	0.74	1.42	0.51	0.69	0.69	0.42	0.85	0.85
Avail Cap(c_a), veh/h	216	0	379	188	381	322	285	526	544	411	788	798
HCM Platoon Ratio	1.00	1.00	1.00	1.00	1.00	1.00	1.00	1.00	1.00	2.00	2.00	2.00
Upstream Filter(I)	1.00	0.00	1.00	1.00	1.00	1.00	1.00	1.00	1.00	1.00	1.00	1.00
Uniform Delay (d), s/veh	52.0	0.0	47.9	38.6	49.1	51.3	25.6	35.6	35.6	30.4	1.3	1.3
Incr Delay (d2), s/veh	12.3	0.0	17.0	5.7	1.6	213.8	0.6	7.2	7.0	0.2	11.0	11.2
Initial Q Delay(d3),s/veh	0.0	0.0	0.0	0.0	0.0	0.0	0.0	0.0	0.0	0.0	0.0	0.0
%ile BackOfQ(50%),veh/ln	5.4	0.0	8.7	3.2	5.4	19.1	1.9	10.1	10.4	3.5	3.1	3.2
Unsig. Movement Delay, s/veh												
LnGrp Delay(d),s/veh	64.2	0.0	64.9	44.3	50.6	265.1	26.2	42.8	42.5	30.7	12.3	12.5
LnGrp LOS	E	A	E	D	D	F	C	D	D	C	B	B
Approach Vol, veh/h		417			613			859			1520	
Approach Delay, s/veh		64.7			156.1			40.3			14.4	
Approach LOS		E			F			D			B	
Timer - Assigned Phs	1	2	3	4	5	6	7	8				
Phs Duration (G+Y+Rc), s	11.6	64.5	16.8	27.1	29.1	47.0	15.1	28.8				
Change Period (Y+Rc), s	* 6.7	* 6.7	* 6.7	* 6.7	* 6.7	* 6.7	* 6.7	* 6.7				
Max Green Setting (Gmax), s	* 8.3	* 47	* 8.7	* 29	* 15	* 40	* 8.4	* 30				
Max Q Clear Time (g_c+I1), s	3.9	12.1	5.6	19.5	2.0	25.0	9.1	21.5				
Green Ext Time (p_c), s	0.0	3.3	0.0	0.4	0.1	1.4	0.0	0.4				

Intersection Summary

HCM 6th Ctrl Delay	52.6
HCM 6th LOS	D

Notes

* HCM 6th computational engine requires equal clearance times for the phases crossing the barrier.

HCM 6th TWSC
5: Ex Driveway & 15th Ave SW

Puyallup Arco
Future (2025) With-Project Weekday PM Peak Hour

Intersection												
Int Delay, s/veh	2											
Movement	EBL	EBT	EBR	WBL	WBT	WBR	NBL	NBT	NBR	SBL	SBT	SBR
Lane Configurations	↶	↷		↶	↷			↕			↕	
Traffic Vol, veh/h	10	350	10	15	400	14	10	0	15	36	5	25
Future Vol, veh/h	10	350	10	15	400	14	10	0	15	36	5	25
Conflicting Peds, #/hr	0	0	1	1	0	0	0	0	0	0	0	0
Sign Control	Free	Free	Free	Free	Free	Free	Stop	Stop	Stop	Stop	Stop	Stop
RT Channelized	-	-	None	-	-	None	-	-	None	-	-	None
Storage Length	50	-	-	50	-	-	-	-	-	-	-	-
Veh in Median Storage, #	-	0	-	-	0	-	-	0	-	-	0	-
Grade, %	-	0	-	-	0	-	-	0	-	-	0	-
Peak Hour Factor	95	95	95	95	95	95	95	95	95	95	95	95
Heavy Vehicles, %	1	1	1	2	2	2	0	0	0	3	3	3
Mvmt Flow	11	368	11	16	421	15	11	0	16	38	5	26

Major/Minor	Major1			Major2			Minor1			Minor2		
Conflicting Flow All	436	0	0	380	0	0	873	865	375	865	863	429
Stage 1	-	-	-	-	-	-	397	397	-	461	461	-
Stage 2	-	-	-	-	-	-	476	468	-	404	402	-
Critical Hdwy	4.11	-	-	4.12	-	-	7.1	6.5	6.2	7.13	6.53	6.23
Critical Hdwy Stg 1	-	-	-	-	-	-	6.1	5.5	-	6.13	5.53	-
Critical Hdwy Stg 2	-	-	-	-	-	-	6.1	5.5	-	6.13	5.53	-
Follow-up Hdwy	2.209	-	-	2.218	-	-	3.5	4	3.3	3.527	4.027	3.327
Pot Cap-1 Maneuver	1129	-	-	1178	-	-	273	294	676	273	291	624
Stage 1	-	-	-	-	-	-	633	607	-	579	564	-
Stage 2	-	-	-	-	-	-	574	565	-	621	599	-
Platoon blocked, %	-	-	-	-	-	-	-	-	-	-	-	-
Mov Cap-1 Maneuver	1129	-	-	1177	-	-	253	287	675	262	284	624
Mov Cap-2 Maneuver	-	-	-	-	-	-	253	287	-	262	284	-
Stage 1	-	-	-	-	-	-	626	600	-	573	556	-
Stage 2	-	-	-	-	-	-	537	557	-	601	592	-

Approach	EB			WB			NB			SB		
HCM Control Delay, s	0.2			0.3			14.5			18.4		
HCM LOS							B			C		

Minor Lane/Major Mvmt	NBLn1	EBL	EBT	EBR	WBL	WBT	WBR	SBLn1
Capacity (veh/h)	405	1129	-	-	1177	-	-	338
HCM Lane V/C Ratio	0.065	0.009	-	-	0.013	-	-	0.206
HCM Control Delay (s)	14.5	8.2	-	-	8.1	-	-	18.4
HCM Lane LOS	B	A	-	-	A	-	-	C
HCM 95th %tile Q(veh)	0.2	0	-	-	0	-	-	0.8

Appendix E: Detailed Trip Generation

Puyallup ARCO

<u>Proposed Use</u>																	
Land Use	Setting	Size	Units	Model	Rate ¹	Units	Inbound %	Gross Trips			Pass-By ³			Total Net New			
								Inbound	Outbound	Subtotal	%	In	Out	Total	Inbound	Outbound	Total
Convenience Store/Gas Station - GFA (2-4k) (LU #945)¹		16 vfp															
Daily	General Urban/Suburban	3,675 sf		Rate	265.12	per vf	50%	2,121	2,121	4,242	76%	1601	1601.355	3203	519.6	519.7	1039.3
AM Peak Hour	General Urban/Suburban			Rate	16.06	per vf	50%	128	129	257	76%	98	98	195	30.4	31.3	61.7
PM Peak Hour	General Urban/Suburban			Rate	18.42	per vf	50%	147	148	295	75%	111	110.52	221	36.5	37.2	73.7
EV Chargers²		4 stalls															
Daily	General Urban/Suburban			Rate	10.00	per stall	50%	20	20	40	0%	0	0	0	20.0	20.0	40.0
AM Peak Hour	General Urban/Suburban			Rate	1.50	per stall	33%	2	4	6.00	0%	0	0	0	2.0	4.0	6.0
PM Peak Hour	General Urban/Suburban			Rate	2.00	per stall	67%	5	3	8.00	0%	0	0	0	5.4	2.6	8.0
<u>Subtotal</u>																	
Daily								2,141	2,141	4,282		1,601	1,601	3,203	539.6	539.7	1,079.3
AM Peak Hour								130	133	263		98	98	195	32.4	35.3	67.7
PM Peak Hour								152	150	303		111	111	221	41.9	39.8	81.7

<u>Existing Use</u>																	
Land Use	Setting	Size	Units	Model	Rate	Units	Inbound %	Gross Trips			Pass-By			Total Net New			
								Inbound	Outbound	Subtotal	%	In	Out	Total	Inbound	Outbound	Total
High Turnover Sit-Down Restaurant (LU #932)		2,760 sf															
Daily	General Urban/Suburban			Rate	107.20	per ksf	50%	148	148	296	43%	64	63.64	127	84.4	84.3	168.7
AM Peak Hour	General Urban/Suburban			Rate	9.57	per ksf	55%	15	11	26	43%	5.7	5.7	11	9.3	5.8	15.1
PM Peak Hour	General Urban/Suburban			Rate	9.05	per ksf	61%	15	10	24.98	43%	5.4	5.4	11	9.6	4.6	14.2

<u>Net New Trips</u>																	
Daily															455.2	455.4	910.6
AM Peak Hour															23.1	29.5	52.6
PM Peak Hour															32.3	35.2	67.5

Notes:

1. Trip rates based on Institute of Transportation Engineers' (ITE) *Trip Generation* 11th Edition average trip rate as shown above. Note that per conversations with the City, LU 945 as reflected in the analysis above is inclusive of all proposed components of the project including the convenience store, fueling pumps, and car wash.

2. EV Charger's trip generation was estimated assuming a daily trip generation of 20 vehicles (40 trips) for the 4 stalls which was based on anticipated daily capacity/output of the chargers. Based on the daily usage, it was estimated that up to 3 vehicles would be served in the AM peak hour and 4 vehicles in the PM peak hour. This peak hour assumption equates to all or nearly all stalls in use as typical charging takes 20-30 minutes.

3. Passby rates per ITE's *Trip Generation Manual*, 11th Edition. A limited portion of trips at the EV-Chargers are anticipated to be pass-by.

Appendix F: Loading Maneuvers

TANKER PATH EXHIBIT

FOR
ARCO ampm PUYALLUP
 SEC. 33, TWN. 20 N, RGE. 4 E, W.M.
 CITY OF PUYALLUP, PIERCE COUNTY

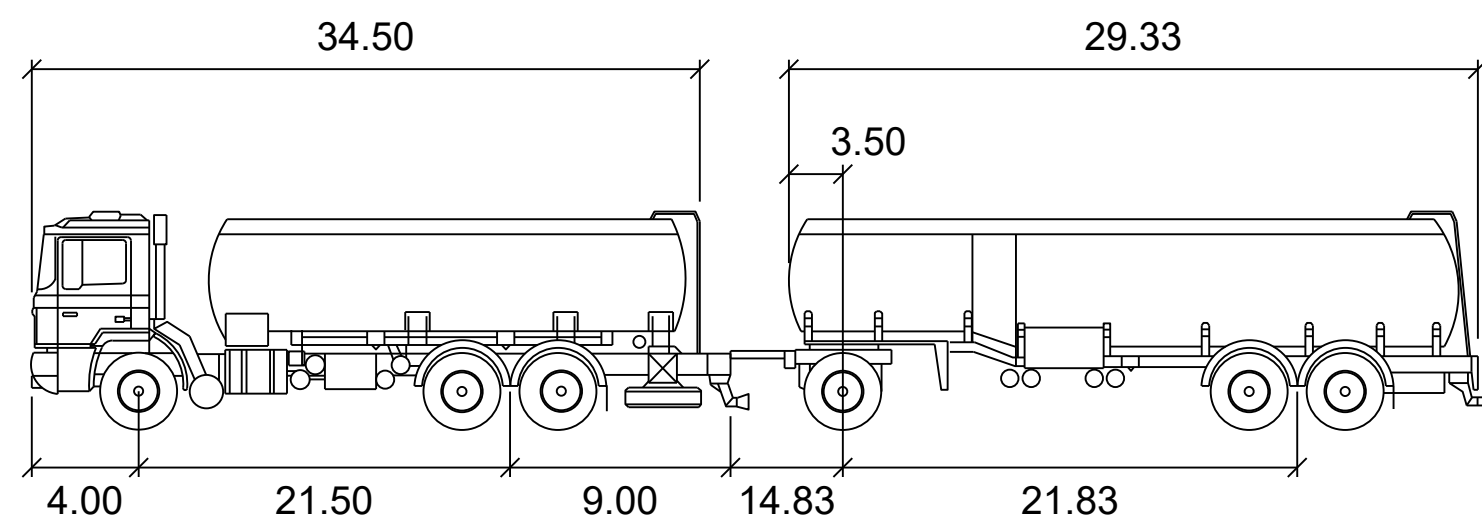

arco-75
 feet

First Unit Width	: 8.50	Lock to Lock Time	: 6.0
Trailer Width	: 8.50	Steering Angle	: 36.0
First Unit Track	: 8.50	Articulating Angle	: 70.0
Trailer Track	: 8.50		

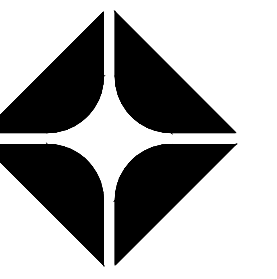
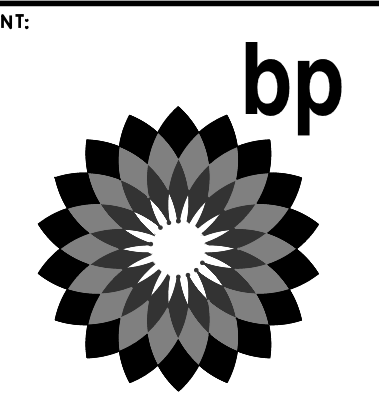
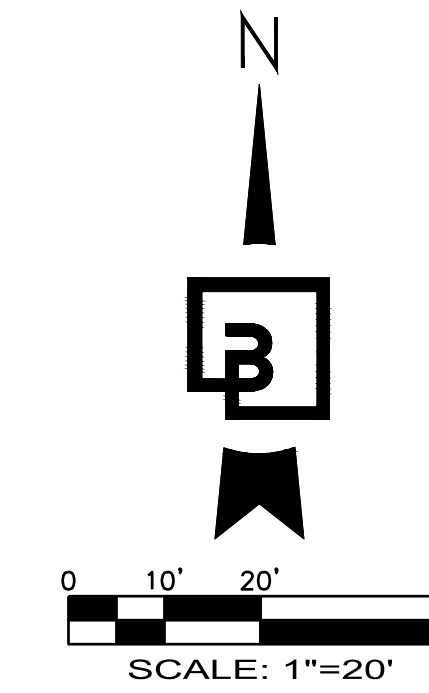
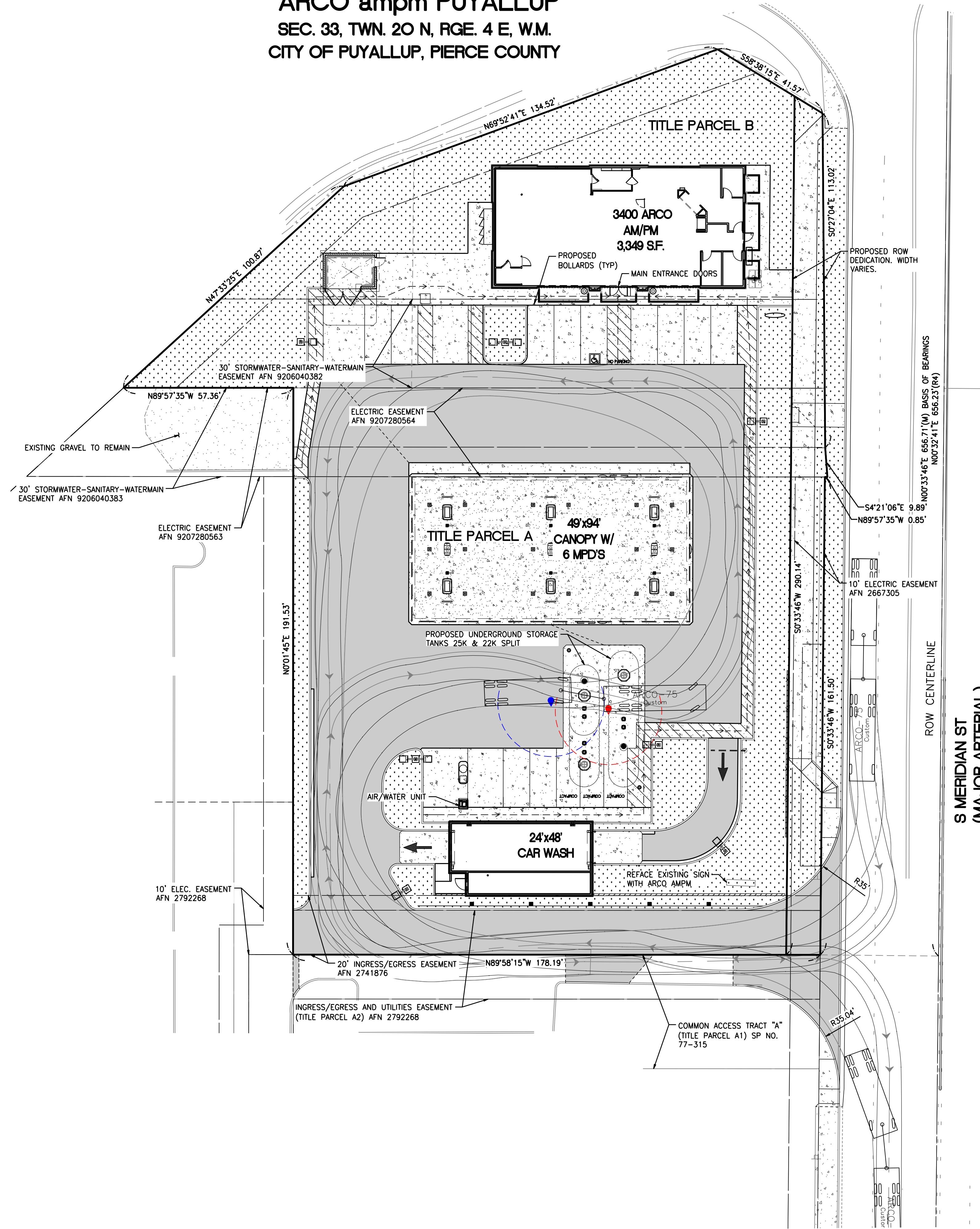

ARCO
 BP WEST COAST PRODUCTS, LLC

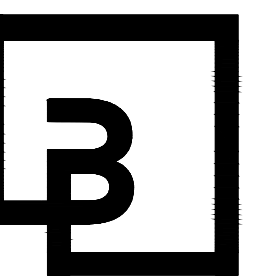

Barghausen Consulting Engineers, Inc.
 18215 72nd Avenue South
 Kent, WA 98032
 425.251.6222
 barghausen.com

NO.	DATE	REVISION DESCRIPTION
1	12-19-22	ENTITLEMENTS RESUBMITAL 01
2	3-9-23	ENTITLEMENTS RESUBMITAL 02

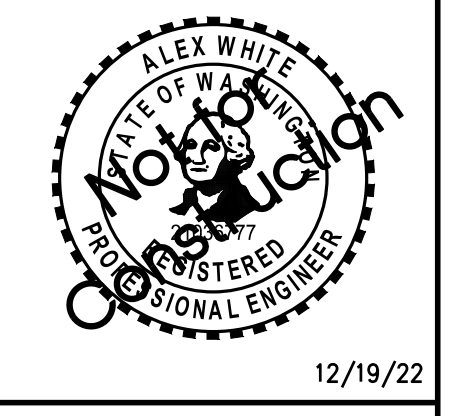

DEVELOPMENT INFORMATION:
ARCO NTI
 3400 am/pm
 FUEL CANOPY w/ 6 MPD's

SITE ADDRESS:
SWC S MERIDIAN
 @ HIGHWAY 512
 PUYALLUP, WASHINGTON

FACILITY #TBD
 DESIGNED BY: AMJ ALLIANCE ZBON:
 CHECKED BY: ADW BP REP:
 DRAWN BY: AMJ ALLIANCE PM:
 VERSION: ARCO PROJECT NO:
 21730

DRAWING TITLE:
TANKER PATH EXHIBIT

SHEET NO:
C2.1

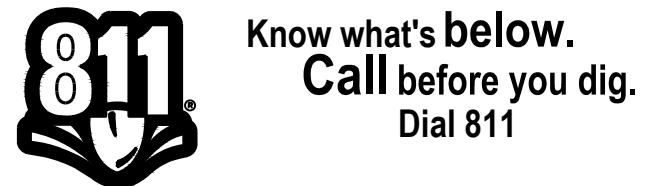

Preliminary Not For Construction

P:\21000s\21730\preliminary\21730-Packing 3/9/2023 3:28 PM AMERCAD00

Appendix G: Sight Distance

SIGHT DISTANCE EXHIBIT

FOR
ARCO ampm PUYALLUP
 SEC. 33, TWN. 20 N, RGE. 4 E, W.M.
 CITY OF PUYALLUP, PIERCE COUNTY

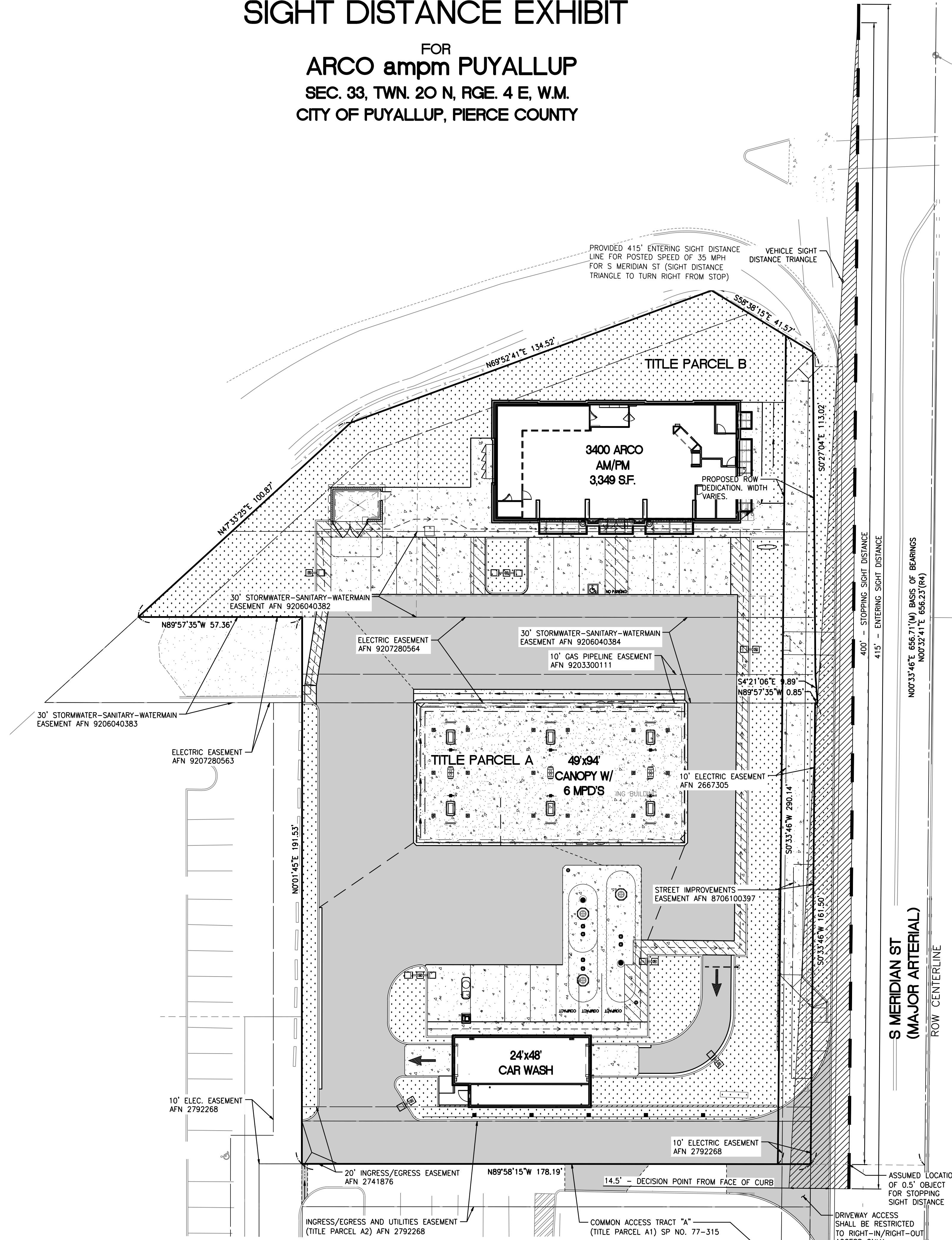
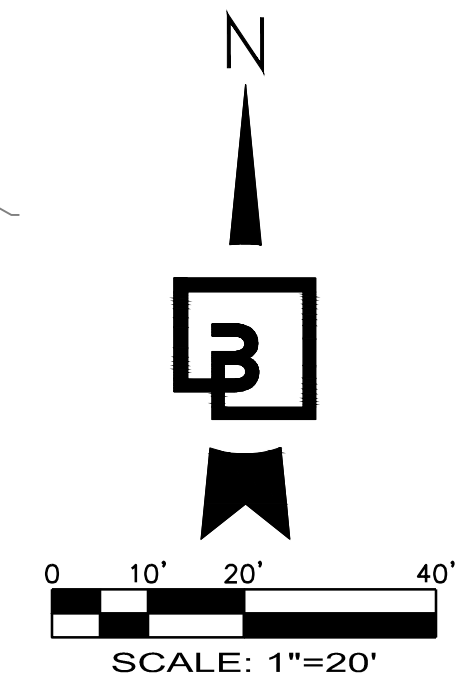

VEHICLE SIGHT DISTANCE NOTE:

TABLE 100-2 OF THE CITY OF PUYALLUP ROADWAY DESIGN STANDARDS (LAST REVISED 01/2016) WAS REFERENCED TO EVALUATE AND DETERMINE ENTERING SIGHT DISTANCE AND STOPPING SIGHT DISTANCE.



POSTED SPEED ON S MERIDIAN ST (MAJOR ARTERIAL): 35 MPH
 DESIGN SPEED ON S MERIDIAN ST (MAJOR ARTERIAL): 45 MPH
 PER TABLE 100-2 OF THE CITY OF PUYALLUP ROADWAY DESIGN STANDARDS (LAST REVISED 01/2016), THE ENTERING SIGHT DISTANCE AND STOPPING SIGHT DISTANCE FOR THE MODIFIED DRIVEWAY IS 415' AND THE STOPPING SIGHT DISTANCE IS 400'.

THE DECISION POINT DISTANCE OF 14.5' FROM FACE OF CURB WAS USED TO EVALUATE THE ENTERING AND STOPPING SIGHT DISTANCES.

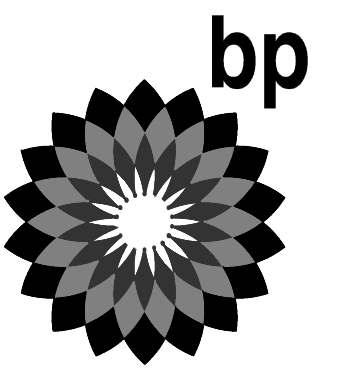

Preliminary Not For Construction

CLIENT:

BP WEST COAST PRODUCTS, LLC



Barghausen Consulting Engineers, Inc.
 18215 72nd Avenue South
 Kent, WA 98032
 425.251.6222
 barghausen.com

NO.	DATE	REVISION DESCRIPTION
1	12-19-22	ENTITLEMENTS RESUBMITAL 01
2	3-9-23	ENTITLEMENTS RESUBMITAL 02

ALEX WHITE
 STATE OF WASHINGTON
 LICENSE NO. 21730
 REGISTERED PROFESSIONAL ENGINEER
 12/19/22

DEVELOPMENT INFORMATION:

ARCO NTI
 3400 am/pm
 FUEL CANOPY w/ 6 MPD's

SITE ADDRESS:

SWC S MERIDIAN
 @ HIGHWAY 512
 PUYALLUP, WASHINGTON

FACILITY #TBD

DESIGNED BY: AMJ ALLIANCE ZBOW:
 CHECKED BY: ADW BP REP:
 DRAWN BY: AMJ ALLIANCE PM:
 VERSION: PROJECT NO.:
 21730

DRAWING TITLE:
SIGHT DISTANCE EXHIBIT

SHEET NO:
C2.0

P:\21000s\21730\preliminary\C21730-SIGHT DISTANCE EXHIBIT.dwg 3/9/2023 3:36 PM ANWHITE

Appendix H: Right Turn Lane Warrant Analysis

Exhibit 1310-19 Right-Turn Lane Guidelines

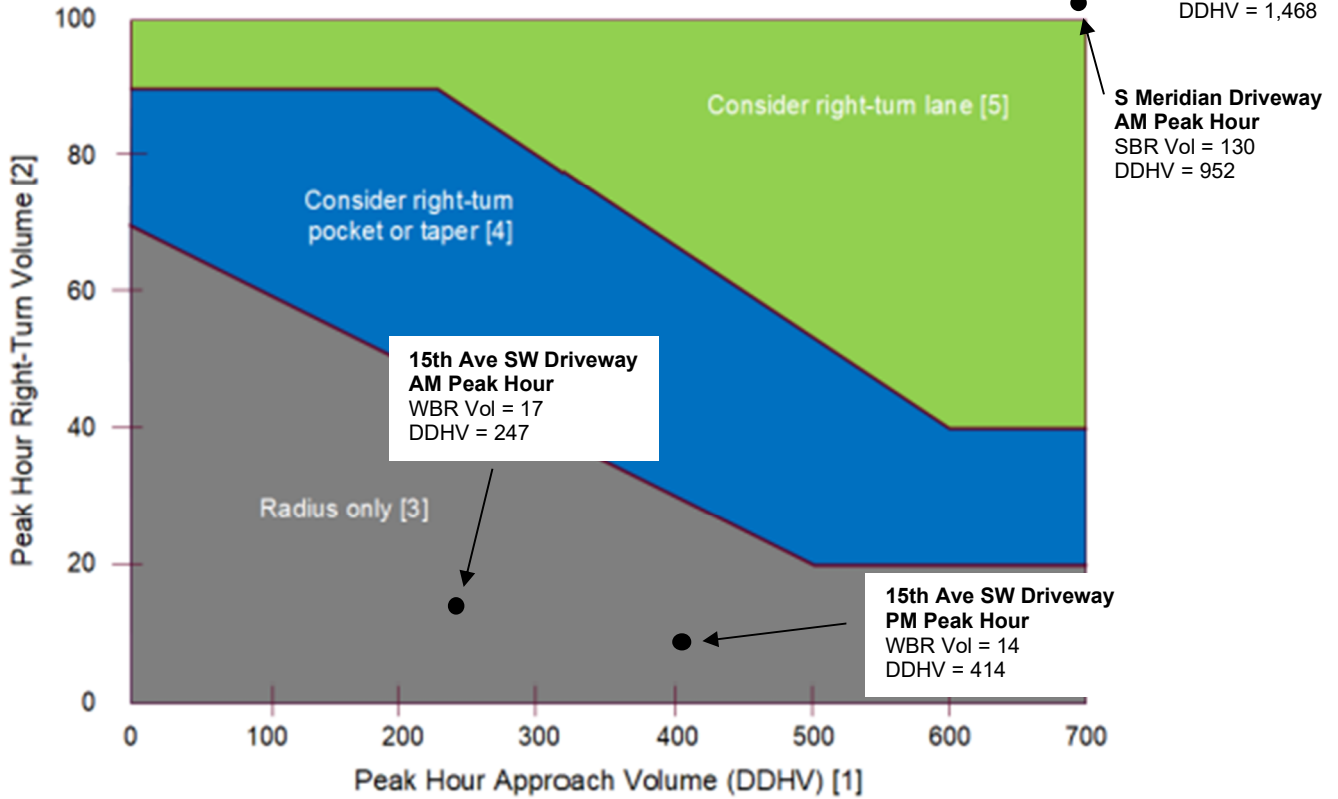

Notes:

- [1] For two-lane highways, use the peak hour DDHV (through + right-turn).
For multilane, highways (posted speed 45 mph or above), use the right-lane peak hour approach volume (through + right-turn).
- [2] When all three of the following conditions are met, reduce the right-turn DDHV by 20:
 - The posted speed is 45 mph or below
 - The right-turn volume is greater than 40 VPH
 - The peak hour approach volume (DDHV) is less than 300 VPH
- [3] For right-turn corner design, see Exhibit 1310-6.
- [4] For right-turn pocket or taper design, see Exhibit 1310-20.
- [5] For right-turn lane design, see Exhibit 1310-21.