

PLANT LEGEND

QTY	BOTANICAL NAME	COMMON NAME	SIZE & SPACING
TREES			
5	GINKGO BILOBA 'PRINCETON SENTRY'	PRINCETON SENTRY GINKGO	2" CALIPER, 30' O.C., 5' GRAFT
4	CORNUS NUTTALLII	PACIFIC DOGWOOD	2" CALIPER, 40' O.C., 5' GRAFT
31	KOELREUTERIA PANICULATA	GOLDENCHAIN TREE	2" CALIPER, 30' O.C., 5' GRAFT
132	CUPRESSUS ARIZONICA VAR. GLABRA	BLUE ICE SMOOTH CYPRESS	6'-8' HEIGHT, 3' O.C. SPACING
20	PSEUDOTSUGA MENZIESII	DOUGLAS FIR	6'-8' HEIGHT, 8' O.C. SPACING
48	THUJA PLICATA	WESTERN RED CEDAR	6'-8' HEIGHT, 8' O.C. SPACING

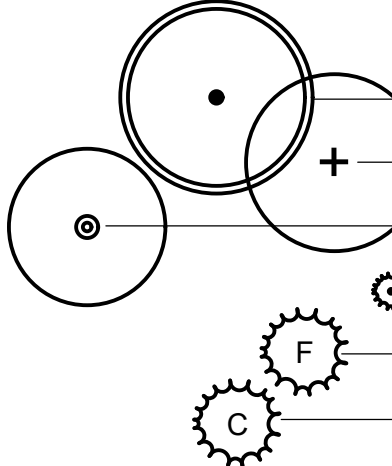

SHRUBS			
42	SYMPHORICARPUS ALBUS	MOCKORANGE	3 GALLON, 7.5' O.C. SPACING
68	ESCALLONIA EXONIENSIS 'FRADESII'	PINK PRINCESS ESCALLONIA	3 GALLON, 4' O.C. SPACING
91	RIBES SANGUINEUM	RED FLOWERING CURRANT	3 GALLON, 7.5' O.C. SPACING
36	CORNUS SERICEA	RED TWIG DOGWOOD	3 GALLON, 4' O.C. SPACING
30	AZALEA 'HINO CRIMSON'	HINO CRIMSON AZALEA	2 GALLON, 3' O.C. SPACING
58	CORNUS SERICEA 'KELSEYI'	KELSEY DOGWOOD	2 GALLON, 3' O.C. SPACING
58	CALAMAGROSTIS 'KARL FOERSTER'	KARL FOERSTER FEATHER REED GRASS	2 GALLON, 3' O.C. SPACING

GROUND COVER			
258	ARCTOSTYLOS UVA-URSI	KINNIKINICK	1 GALLON, 30" O.C. SPACING
339	GAULTHERIA SHALLON	SALAL	1 GALLON, 30" O.C. SPACING
DAFFODIL BULBS			BULBS @ 12" O.C. SPACING

HYDROSEED MIXES			
SPECIAL SUN MIXTURE			BY COUNTRY GREEN TURF FARMS 8 LBS PER 1000 SQ. FT.
PERENNIAL RYEGRASS	80%		
FINE FESCUE	20%		

LANDSCAPE NOTES AND SOIL QUALITY

1. PROVIDE LANDSCAPE PLANTING TO SCREEN ALL OUTDOOR UTILITY EQUIPMENT. PLANT OPTIONS INCLUDE: BLUE ICE ARIZONA CYPRESS, PURPLE ROCK ROSE, PINK PRINCESS ESCALLONIA, OR PACIFIC WAX MYRTLE.
2. LANDSCAPE AREAS SHOULD BE DEEP-TILLED TO A DEPTH OF AT LEAST TWELVE (12) INCHES TO FACILITATE DEEP WATER PENETRATION AND SOIL OXYGENATION. PROVIDE SOIL AMENDMENTS ENCOURAGED TO IMPROVE WATER DRAINAGE, MOISTURE PENETRATION OR WATER-HOLDING CAPACITY. FOR ALL NEWLY LANDSCAPED AREAS ORGANIC MATTER SHOULD BE INCORPORATED TO A DEPTH OF FOUR (4) TO SIX (6) INCHES TO FACILITATE DEEP WATER PENETRATION AND SOIL OXYGENATION.
3. CONTRACTOR SHALL PROVIDE 4" DEPTH IMPORTED TOPSOIL AT SEED MIX AREAS AND 9" DEPTH IMPORTED TOPSOIL AT ALL LANDSCAPE PLANTING AREAS.
4. COMPACT ALL SEED MIX AREAS IN TWO DIRECTIONS WITH ROLLER PRIOR TO HYDROSEEDING.
5. IMPORTED TOPSOIL SHALL BE 3-WAY MIX.
6. CONTRACTOR SHALL PROVIDE 2" DEPTH FINE COMPOST MULCH THROUGHOUT LANDSCAPE PLANTING AREAS.
7. CONTRACTOR SHALL GUARANTEE ALL PLANT MATERIALS FOR A PERIOD OF (1) ONE YEAR FROM TIME OF COMPLETION OF WORK.
8. TREES PLANTED FIVE FEET OR LESS FROM PAVED SURFACES SHALL BE PLANTED WITH ROOT CONTROL BARRIER.

PLANT IMAGES



**BRADBURY PLACE
TOWNHOMES**
 XXX 5TH STREET SOUTHEAST
 PUYALLUP, WA

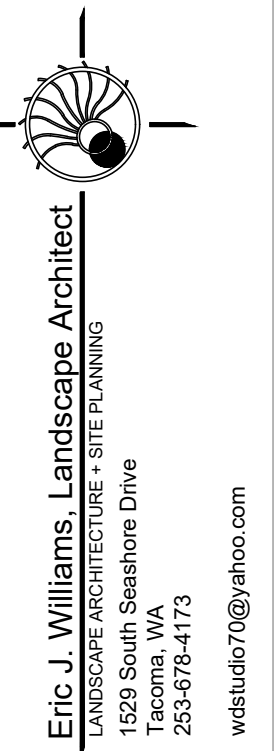

Drawing:
LANDSCAPE PLAN

Date: 6-6-2024
 Job # bradbury-1-2023
 Design: EJW
 Drawn: EJW
 Check: _____
 Revisions: _____

Sheet:

L1.1

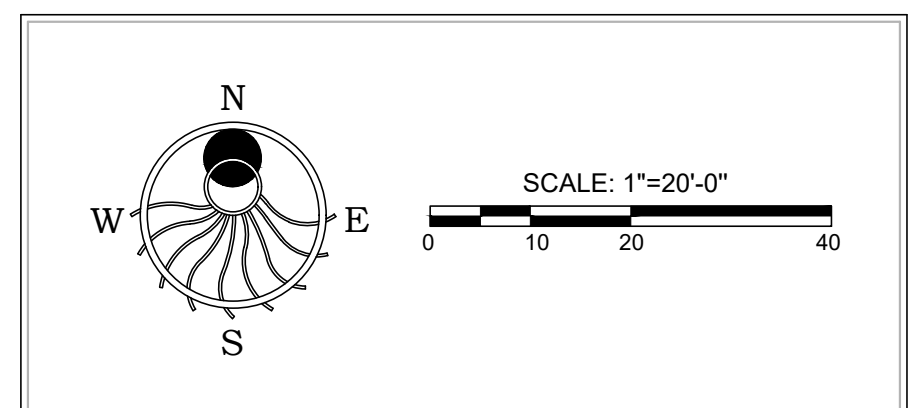

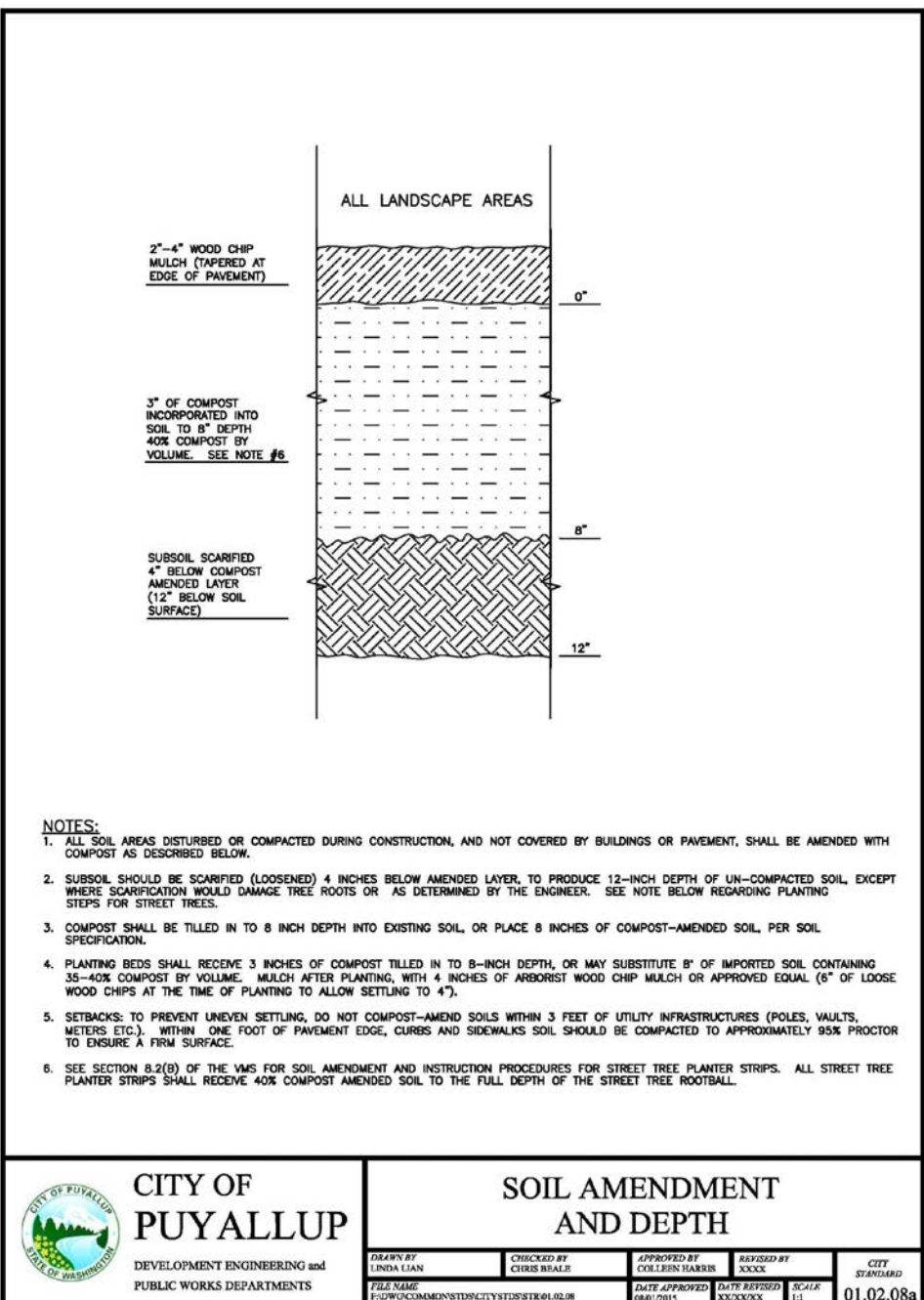
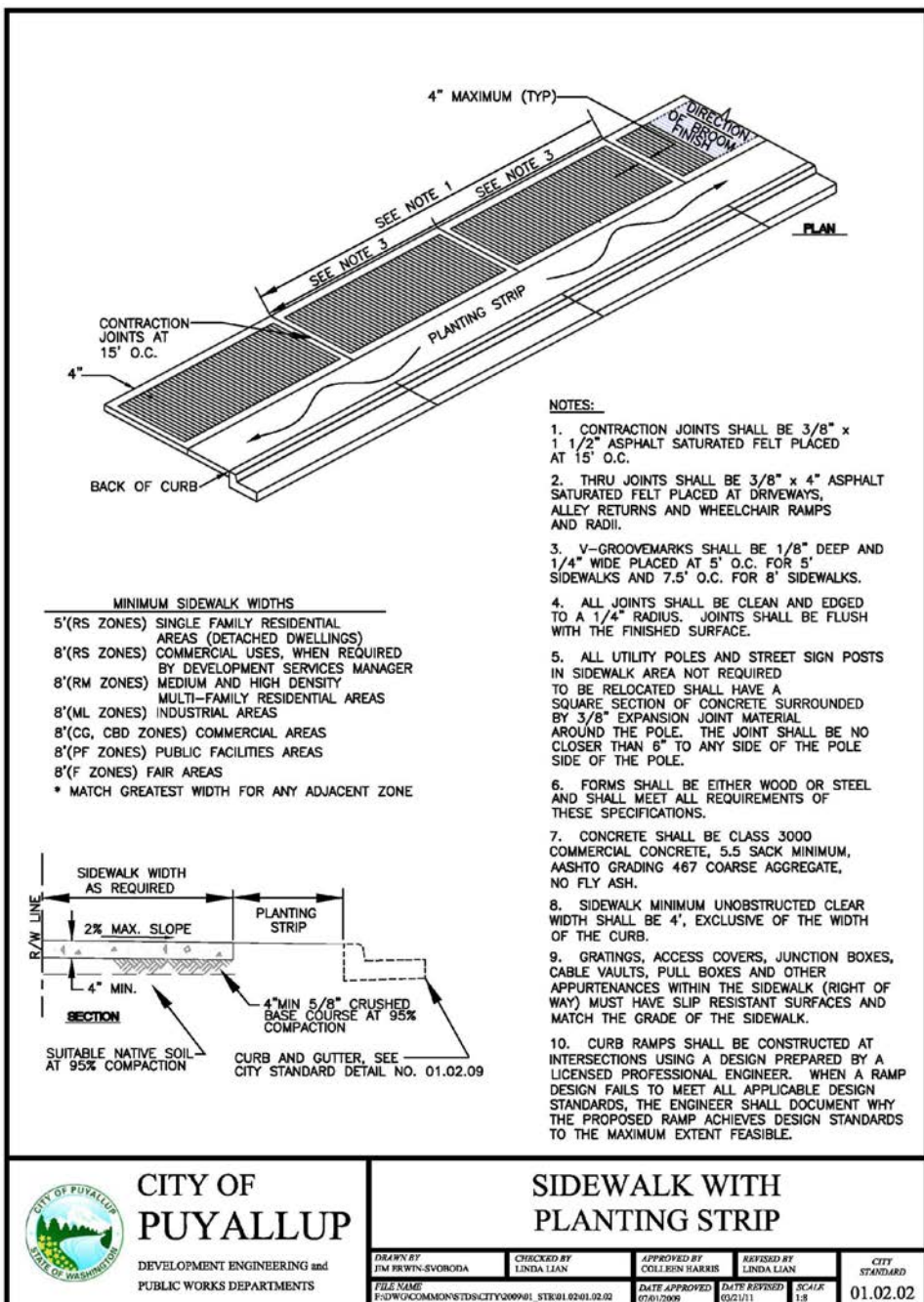
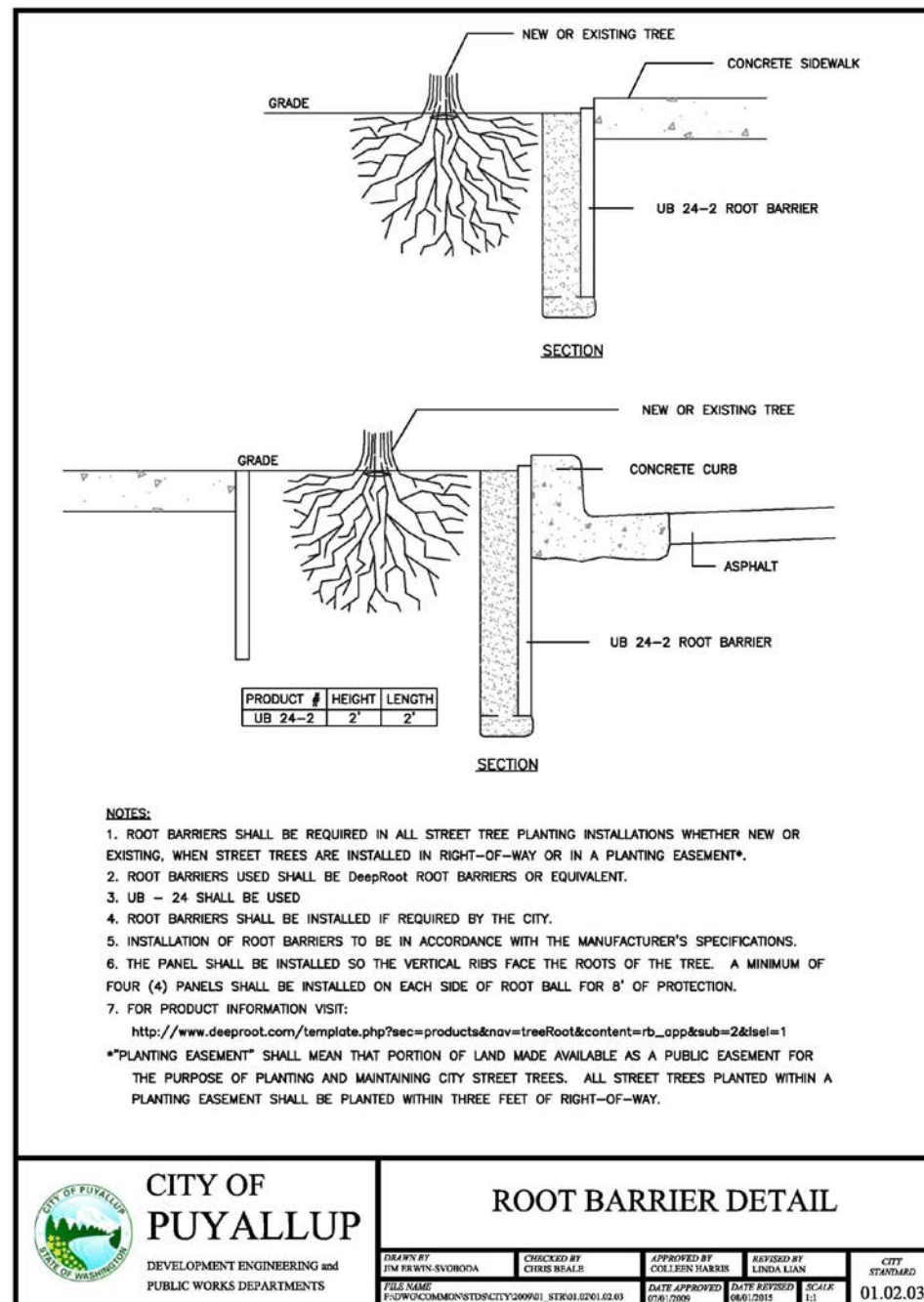
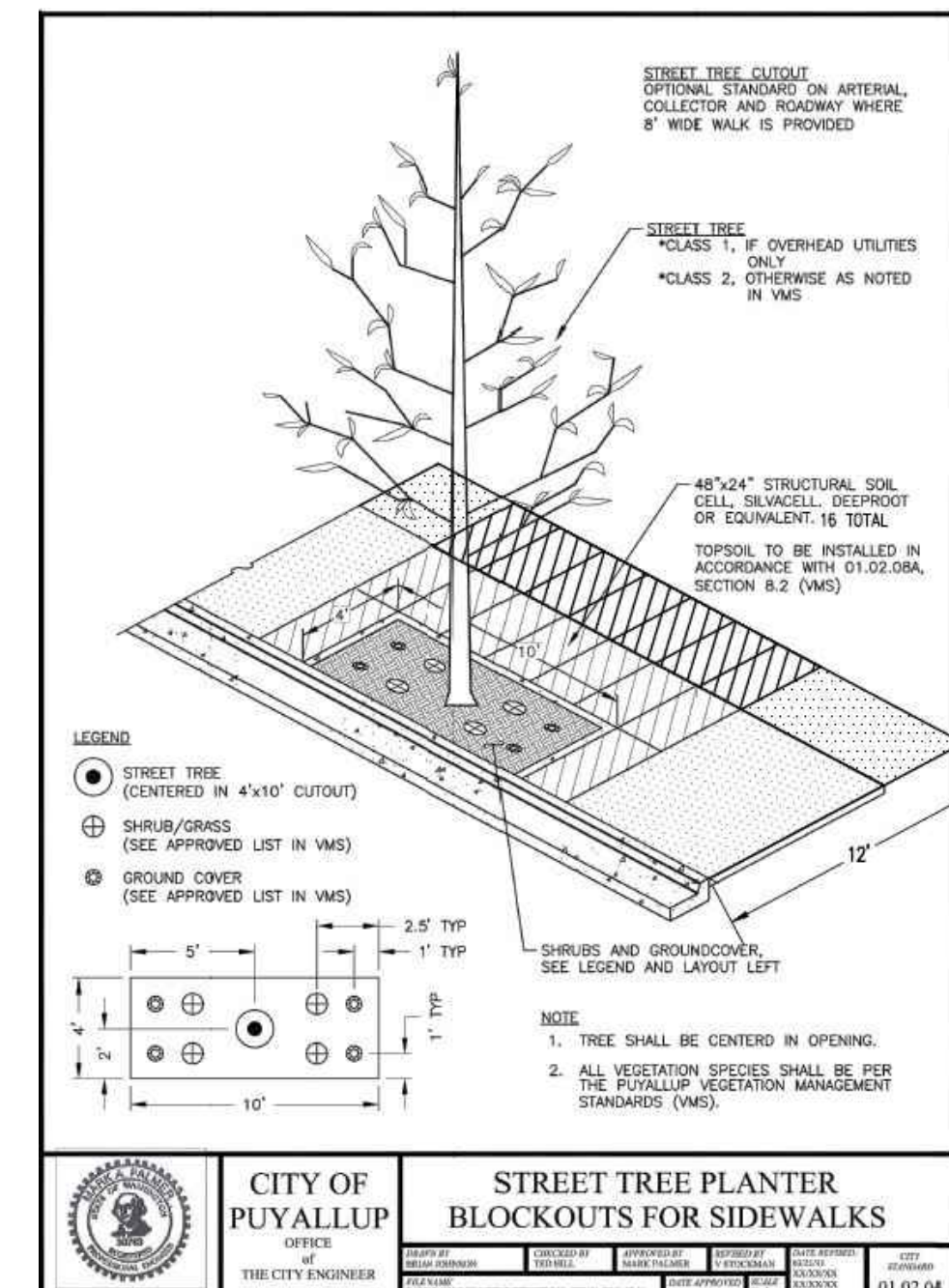
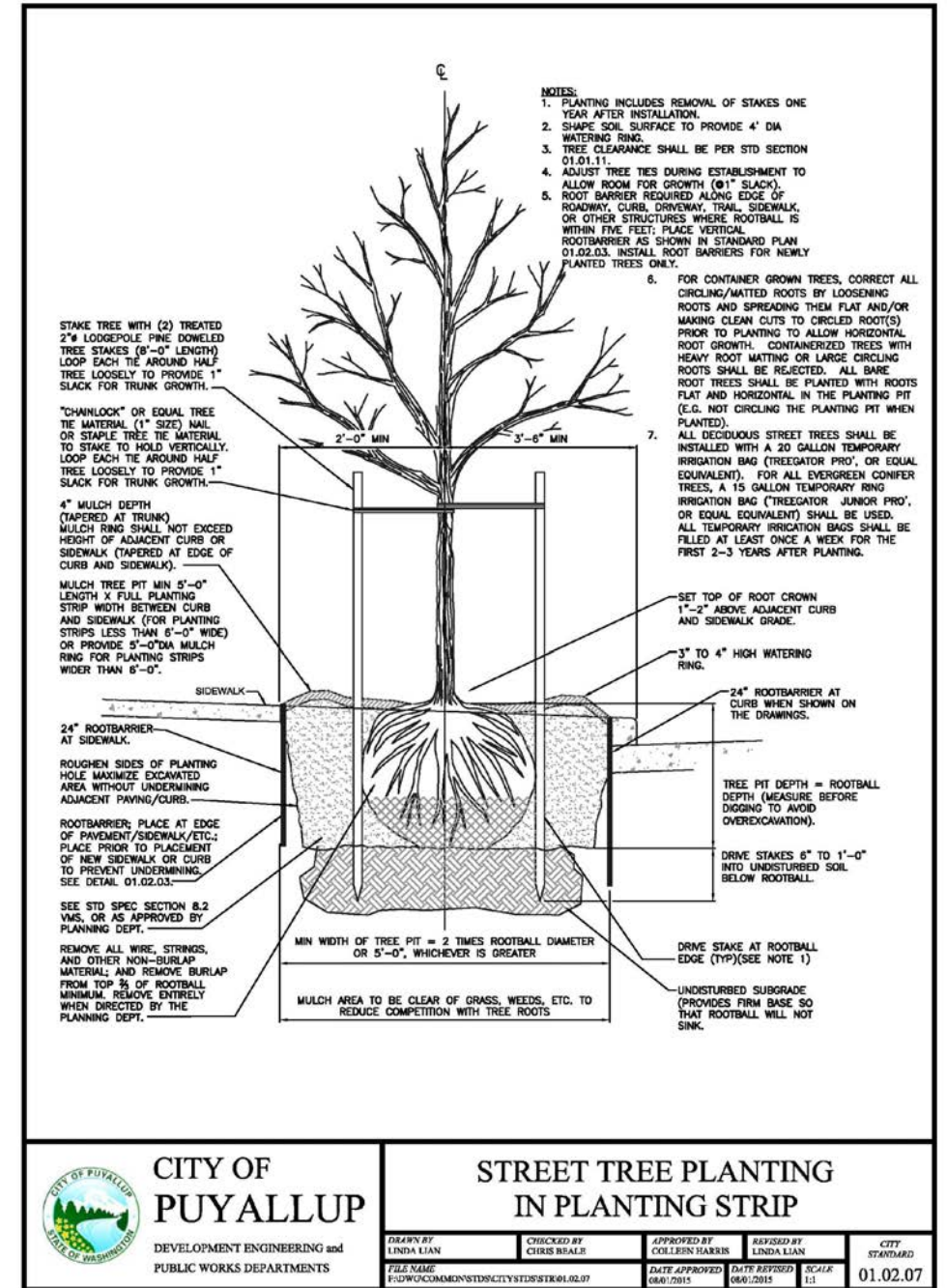
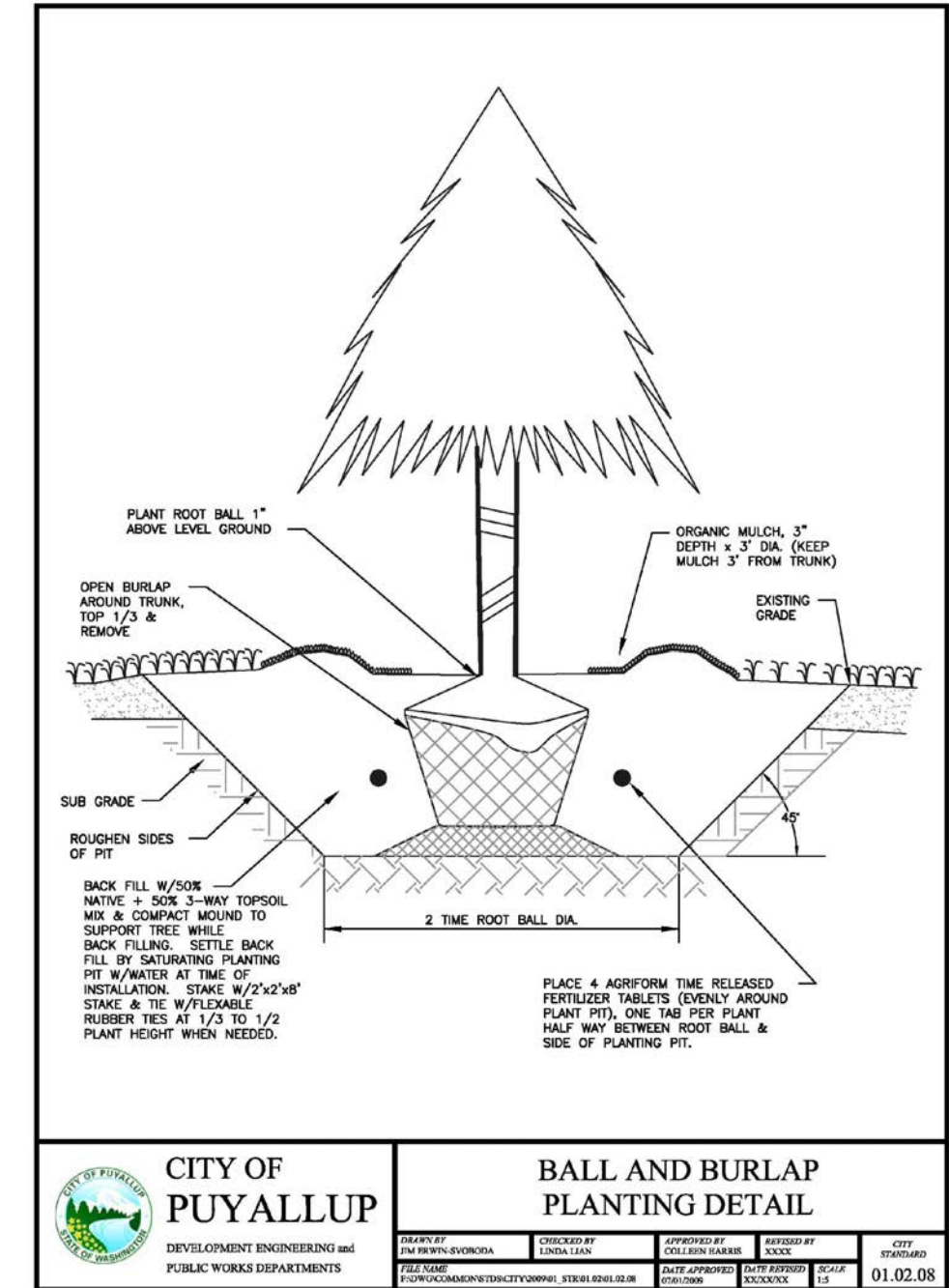
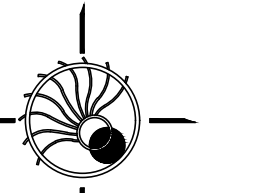



The PlayLab SeeSaw is a fun and innovative take on a playground favorite. Children stand on the rubber-coated platforms, grip the handles and shift their body weight to produce the classic "seesaw" motion. The fully-enclosed rubber spring mechanism creates a smooth gliding motion and prevents abrupt stops and starts endemic to old-fashioned seesaws.

- Features and Benefits:**
- Unique design allows children to stand during play
 - Rubber spring mechanism provides smooth "seesaw" motion without sudden drops or lifts
 - Coated platforms provide slip-resistant surface

Model: 6261
Use Zone: 20' 1in X 13' 4in
Age Group: 5 to 12 Years

Limited Lifetime Warranty on uprights, hardware and connections. Visit gametime.com/warranty for full warranty information

1 PLAY AREA #1 - SEE SAW

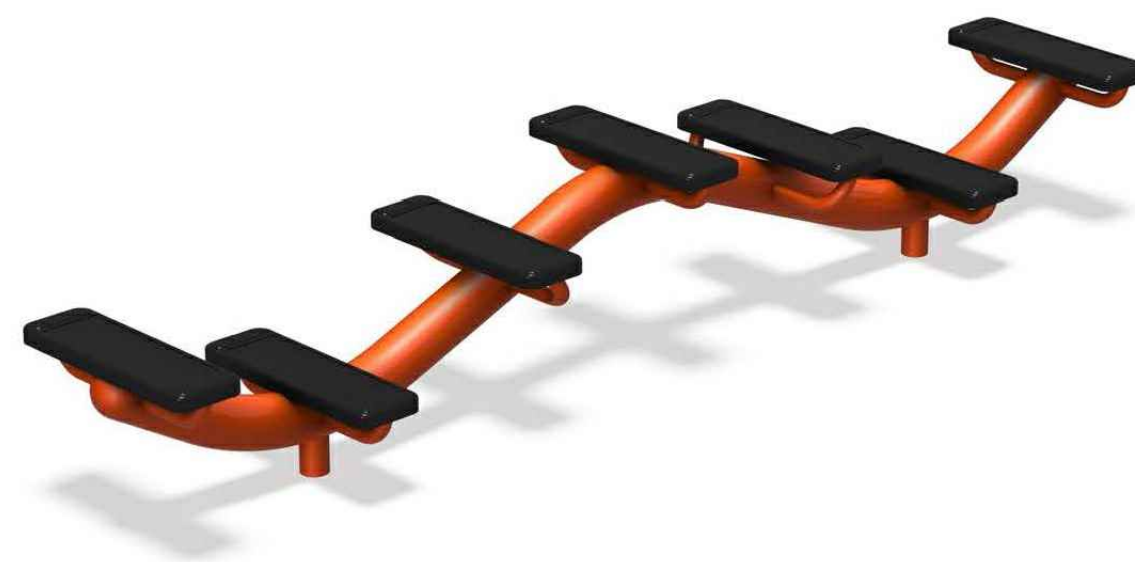

The undulating design of our Inchworm Climber makes it a fun freestanding play activity, or a functional link between two areas of a playground. Body is constructed of durable steel and painted with a powder-coated finish. Rubber steps feature slip-resistant treads.

Features and Benefits:

- Fun way to functionally link two sections of a playground
- Enhances balance and coordination skills
- Inchworm design promotes active play and adds an extra element of fun
- Constructed of durable, recyclable materials and backed by the industry's leading warranty

Model: 8665
Use Zone: 13' 4" X 19' 4"
Fall Height: 4"
Age Group: 5 to 12 Years

Limited Lifetime Warranty on uprights, hardware and connections. Visit gametime.com/warranty for full warranty information

2 PLAY AREA #2 - INCH WORM BALANCE BEAM



Merry-Go-All is a fully accessible, forward-facing inclusive merry-go-round for up to 8 passengers (4 seated, 4 standing). It's a fun motion activity for everyone to enjoy. It features grip/grasp areas to hold onto while riding or pushing others. The center wheel remains stationary so children can work together to turn Merry-Go-All while seated. Available in multi-color...

Features and Benefits:

- Inclusive design with seats at transfer height
- Forward-facing design for up to 8 users (4 seated, 4 standing)
- Promotes social interaction and collaborative play
- Designed for use with an optional 5-point harness (not included)
- Durable, frictionless magnetic braking system to minimize speed

Model: 6272
Use Zone: 19' X 19'
Fall Height: 4"
Age Group: 2 to 5 Years
Age Group: 5 to 12 Years
Number of Children: 8

Limited Lifetime Warranty on uprights, hardware and connections. Visit gametime.com/warranty for full warranty information

3 PLAY AREA #3 - MERRY GO ALL



BRADBURY PLACE
TOWNHOMES
XXX 6TH STREET SOUTHEAST
PUYALLUP, WA

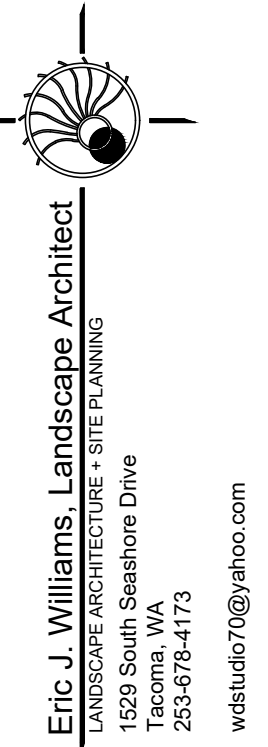

Drawing:
**PLAY AREA
IMAGES**

Date: 6-6-2024
Job # bradbury-1-2023
Design: EJW
Drawn: EJW
Check: _____
Revisions: _____

Sheet:

L1.3