

PRELIMINARY  
STORMWATER DRAINAGE REPORT  
FOR  
43<sup>rd</sup> AVE MULTI-FAMILY  
701 43<sup>rd</sup> AVE SW  
TPN 4320000160

MAY 2, 2025

**PRELIMINARY  
STORMWATER DRAINAGE REPORT**

**FOR**

**43<sup>rd</sup> AVE MULTI-FAMILY**

A portion of the NW Quarter of the NE Quarter of Section 9, Township 19 North,  
Range 4 East, W.M. City of Puyallup, Pierce County, Washington

Prepared for:

DJL Investments LLC  
P.O. Box 26446  
Federal Way, WA 98001  
(253) 988-8815

Prepared by:

Apex Engineering LLC  
2601 South 35th Street, Suite 200  
Tacoma, Washington 98409  
(253) 473-4494  
File #35043-01  
May 2, 2025

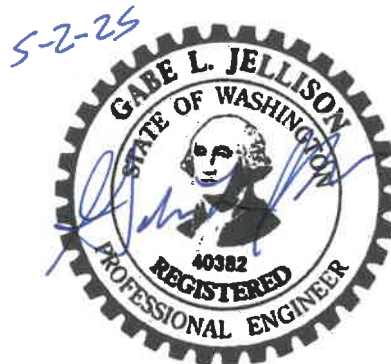

Project Engineer: \_\_\_\_\_  
Gabe L. Jellison, PE



**TABLE OF CONTENTS**

	<u>Page</u>
Chapter 1	Project Overview..... 1
	Figure 1.1 – Vicinity Map
Chapter 2	Existing Conditions Summary ..... 5
	Figure 2.1 – FEMA FIRM
Chapter 3	Off-site Analysis ..... 7
	Figure 3.1 – Downstream Drainage Path Map
Chapter 4	Permanent Stormwater Control Plan ..... 9
	Part 1 – Existing Site Hydrology
	Part 2 – Developed Site Hydrology
	Part 3 – Performance Standards and Goals
	Part 4 – Low Impact Development Features
	Part 5 – Flow Control System
	Part 6 – Runoff Treatment System
	Part 7 – Source Control
	Part 8 – Conveyance System Analysis and Design
Chapter 5	Construction Stormwater Pollution Prevention Plan ..... 12
Chapter 6	Special Reports and Studies..... 12
Chapter 7	Other Permits..... 13
Chapter 8	Operation and Maintenance Manual ..... 13
Chapter 9	Declaration of Covenant for Privately Maintained Flow Control and Runoff Treatment BMPs ..... 13
Chapter 10	Declaration of Covenant for Privately Maintained LID BMPs ..... 13
Chapter 11	Bond Quantities Worksheet ..... 13
Appendix A	Operation and Maintenance (O & M) Manual
Appendix B	Construction Stormwater Pollution Prevention Plan
Appendix C	Engineering Calculations
Appendix D	Geotechnical Reports



## **CHAPTER 1 – PROJECT OVERVIEW**

The proposed project, 43<sup>rd</sup> Ave Multi-Family, is located within Section 9, Township 19 North, Range 4 East, City of Puyallup, Pierce County, Washington. Please refer to Figure 1, Vicinity Map, for a general location. Stormwater mitigation for the project shall meet the current Stormwater Management Manual for Western Washington (SWMMWW) per City of Puyallup requirements.

The project site includes parcel number 4320000160 and is approximately 1.67 acres. The frontage improvements will require right of way dedication along the south and east property lines, yielding approximately 1.56 acres of developable area. The project site is a proposed multi-family residential development that includes the following:

- Apartment complex building
- Internal parking area with drive aisles and sidewalks
- Storm drainage system
- Utility installations
- Frontage improvements along 43<sup>rd</sup> Ave SW and 7<sup>th</sup> St SW

Access to the proposed project will be from 43<sup>rd</sup> Ave SW near the southwest corner of the site.

The site is generally heavily vegetated with a mix of trees and shrubs. The site is bordered on the northern side by multi-family residential development, bordered on the western side by single-family residential development, bordered on the southern side by 43<sup>rd</sup> Ave SW, and bordered on the eastern side by 7<sup>th</sup> St SW.

Topography on the site is rolling with slopes ranging from approximately five to 50 percent. The topography generally slopes up from the boundaries of the site for approximately 50 feet to a ridge and then slopes down to a depression in the central area of the site. The project site consists of two threshold discharge areas. Runoff from the northwest portion of the project flows generally to the northwest to an unnamed water course that continues generally to the west and ultimately discharges to a pothole. Runoff from the southeast portion of the project flows generally to the southeast to a low area/wetland where it continues generally to the northeast to a point a quarter mile downstream. Runoff would then continue west to an unnamed water course and ultimately discharges to a pothole. Run-on is considered minimal, as topography generally slopes away from the project site.

Per the geotechnical investigation completed by Quality Geo NW, PLLC, on-site soils consist of Everett very gravelly sandy loam soils. Refer to Appendix D for a copy of the geotechnical report.

Drainage from the frontage improvements to 43<sup>rd</sup> Avenue SW and 7<sup>th</sup> Street SW is proposed to utilize a proprietary treatment system for water quality and an infiltration trench for flow control. Drainage from the onsite improvements is proposed to be collected and conveyed to a proprietary treatment system



for water quality and an underground chamber system to utilize infiltration for flow control. Refer to Chapter 4 for additional information on the proposed storm systems.

Project coverages are summarized in the following tables:

**Table 1.1: Northwest TDA**

		Existing Basin	Developed Basin
Onsite	Impervious Area (ac)	0	1.015 +/-
	Pervious Area - Forest (ac)	0.958 +/-	0
	Pervious Area - Pasture (ac)	0	0.324 +/-
	Total Area (ac)	0.958 +/-	1.339 +/-
Offsite (43 <sup>rd</sup> /7 <sup>th</sup> )	Impervious Area (ac)	0.031 +/-	0.102 +/-
	Pervious Area - Forest (ac)	0.062 +/-	0
	Pervious Area - Pasture (ac)	0	0.018 +/-
	Total Area (ac)	0.093 +/-	0.120 +/-

**Table 1.1: Southeast TDA**

		Existing Basin	Developed Basin
Onsite	Impervious Area (ac)	0	0.008 +/-
	Pervious Area - Forest (ac)	0.427 +/-	0
	Pervious Area - Pasture (ac)	0	0.038 +/-
	Total Area (ac)	0.427 +/-	0.046 +/-
Offsite (43 <sup>rd</sup> /7 <sup>th</sup> )	Impervious Area (ac)	0.086 +/-	0.214 +/-
	Pervious Area - Forest (ac)	0.207 +/-	0
	Pervious Area - Pasture (ac)	0	0.053 +/-
	Total Area (ac)	0.293 +/-	0.267 +/-

Per Figure I-3.1 from the SWMMWW, all minimum requirements apply to the new and replaced hard surfaces and converted vegetation areas proposed under this project. The minimum requirements are listed below with a short narrative of how each is being met.

**1. Minimum Requirement #1: Preparation of a Stormwater Site Plan:**

Preparation of the future site development plans, and this Drainage Report should meet Minimum Requirement #1.

**2. Minimum Requirement #2: Construction Stormwater Pollution Prevention Plan (SWPPP):**

A Construction SWPPP will be prepared with the future site development permit, which should meet Minimum Requirement #2.

**3. Minimum Requirement #3: Source Control of Pollution:**

Source control will be addressed with the future site development permit and outlined in Attachment B of the Operation and Maintenance Manual.

4. *Minimum Requirement: #4: Preservation of Natural Drainage System and Outfalls:*

The proposed project should not affect any natural drainage systems and is proposed to mimic the existing drainage courses to the maximum extent practicable. The project is proposing infiltration of stormwater runoff for the majority of the proposed site. No new drainage patterns should be created.

5. *Minimum Requirement: #5: On-site Stormwater Management:*

Per Figure I-3.3 of the SWMMWW, the project has chosen to meet the LID performance standard. For lawn and landscaped areas, the project will implement post construction soil quality and depth per BMP T5.13.

6. *Minimum Requirement: #6: Runoff Treatment:*

Runoff from the onsite and offsite improvements will be directed to proprietary systems with Washington State Department of Ecology (WSDOE) General Use Level Designation (GULD) for water quality treatment. Refer to Chapter 4 for additional information.

7. *Minimum Requirement: #7: Flow Control:*

Runoff from the majority of the developed onsite areas is proposed to be directed to an underground chamber system for infiltration to provide flow control. Runoff from the majority of the frontage improvements will be directed to an infiltration trench to provide flow control. Refer to Chapter 4 for additional information.

8. *Minimum Requirement: #8: Wetlands Protection:*

N/A – Per Pierce County GIS, there are no wetlands onsite and the project is proposing to infiltrate the majority of the proposed runoff.

9. *Minimum Requirement: #9: Operation and Maintenance:*

An Operation and Maintenance Manual will be prepared with the future site development permit, which should meet Minimum Requirement #9.

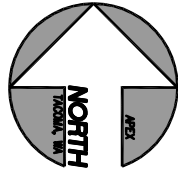
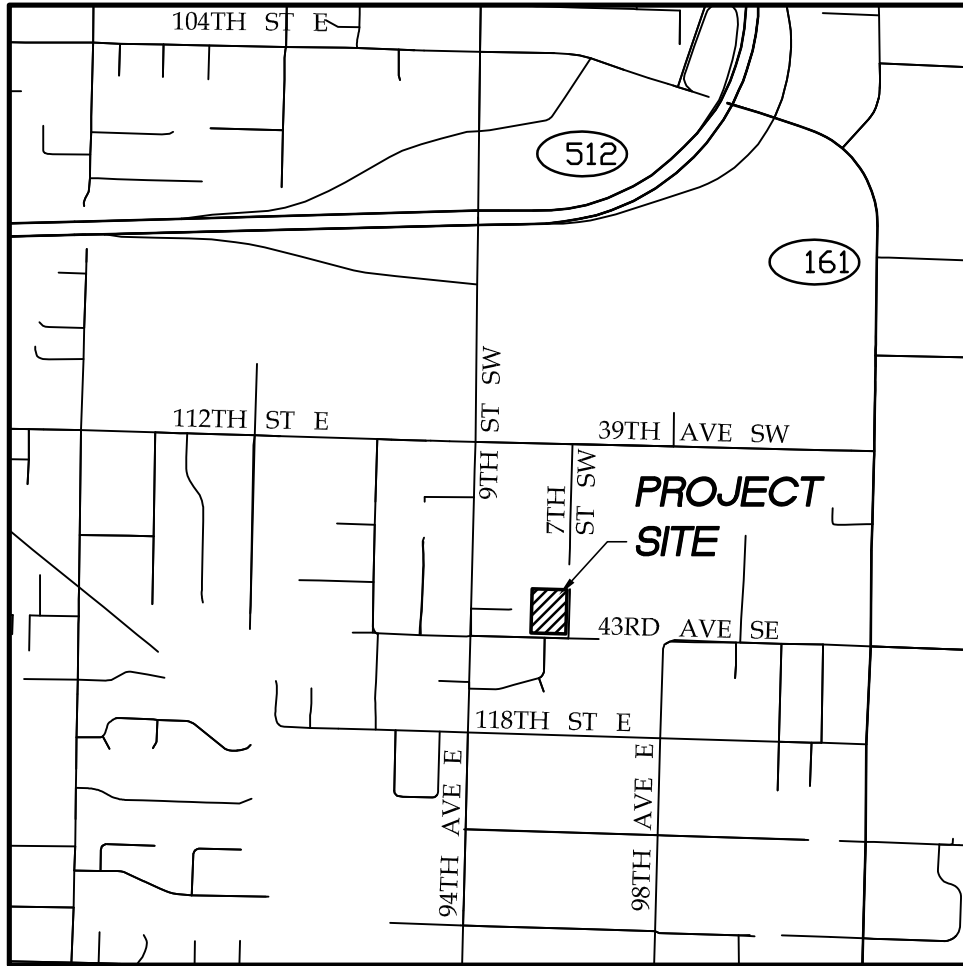

**VICINITY MAP**

SCALE : 1" = 1/4 MILE

**Apex**  
Engineering LLC

2601 South 35th St., Suite 200  
Tacoma, Washington 98409-7479  
(253) 473-4494 FAX: (253) 473-0599  
© APEX ENGINEERING LLC 2025

## **CHAPTER 2 –EXISTING CONDITIONS SUMMARY**

The site is generally heavily vegetated with a mix of trees and shrubs. The site is bordered on the northern side by multi-family residential development, bordered on the western side by single-family residential development, bordered on the southern side by 43<sup>rd</sup> Ave SW, and bordered on the eastern side by 7<sup>th</sup> St SW.

Topography on the site is rolling with slopes ranging from approximately five to 50 percent. The topography generally slopes up from the boundaries of the site for approximately 50 feet to a ridge and then slopes down to a depression in the central area of the site. The project site consists of two threshold discharge areas. Runoff from the northwest portion of the project flows generally to the northwest to an unnamed water course that continues generally to the west and ultimately discharges to a pothole. Runoff from the southeast portion of the project flows generally to the southeast to a low area/wetland where it continues generally to the northeast to a point a quarter mile downstream. Runoff would then continue west to an unnamed water course and ultimately discharges to a pothole. Run-on is considered minimal, as topography generally slopes away from the project site.

Per the geotechnical investigation completed by Quality Geo NW, PLLC, on-site soils consist of Everett very gravelly sandy loam soils. Refer to Appendix D for a copy of the geotechnical report.

Per City of Puyallup mapping/GIS information, the project site does not include any wetlands. The mapping identifies potential landslide hazard areas onsite with moderate risk. A previous determination was made that a steep slope is located near the northern boundary line with an associated setback of 32 feet. Refer to Appendix D for a copy of the geotechnical report.

The project is not located within a known floodplain and/or floodway per FEMA mapping. Refer to the FEMA FIRM included as Figure 2.1 of this report.

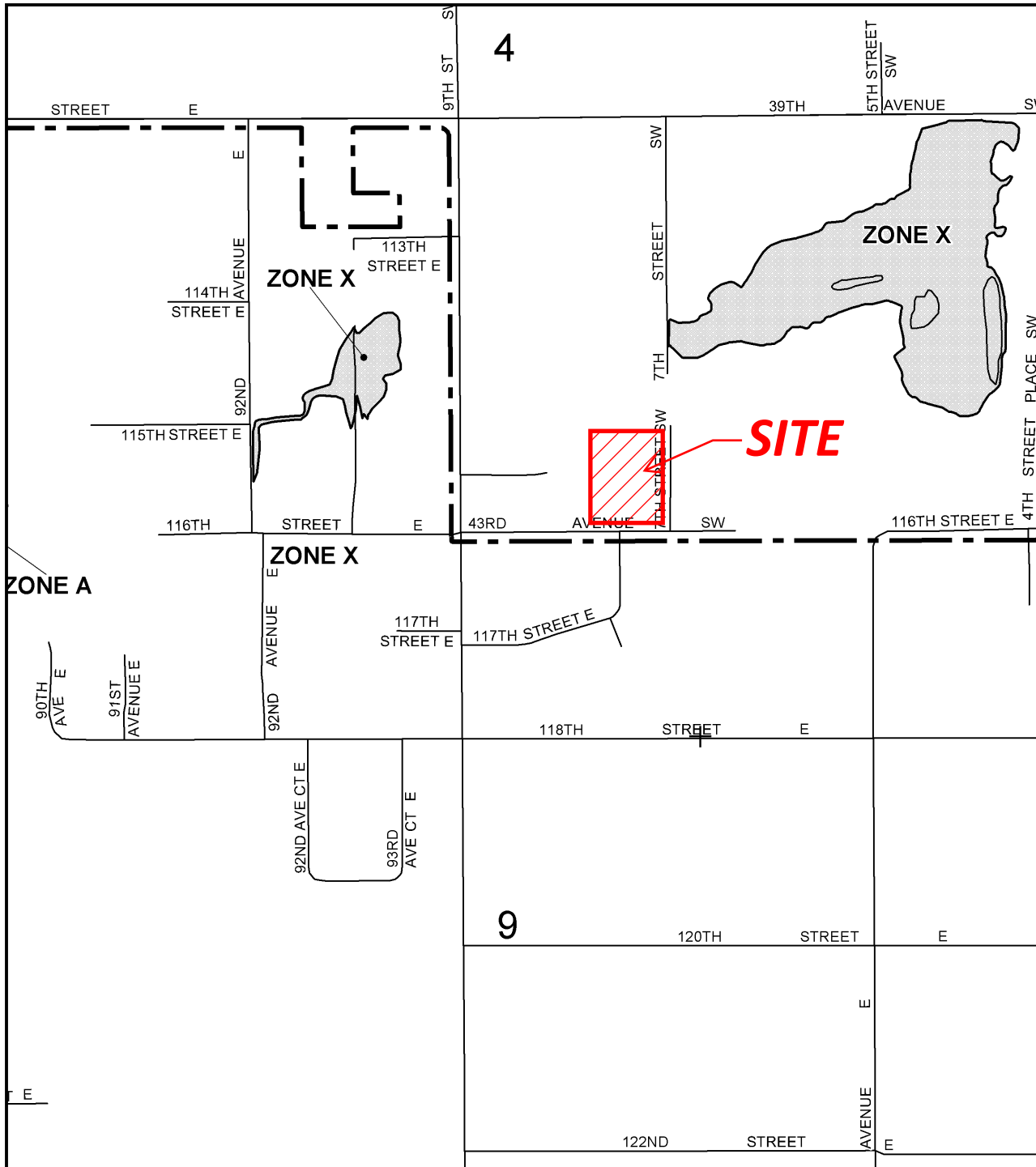

MAP SCALE 1" = 500'

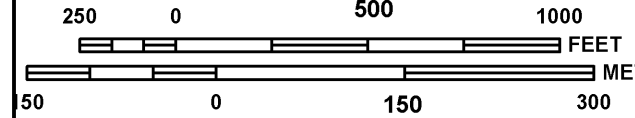

NATIONAL FLOOD INSURANCE PROGRAM

PANEL 0343E

**FIRM**  
**FLOOD INSURANCE RATE MAP**  
**PIERCE COUNTY,**  
**WASHINGTON**  
**AND INCORPORATED AREAS**

**PANEL 343 OF 1375**  
 (SEE MAP INDEX FOR FIRM PANEL LAYOUT)

CONTAINS:

COMMUNITY	NUMBER	PANEL	SUFFIX
PIERCE COUNTY	530138	0343	E
PUYALLUP, CITY OF	530144	0343	E

Notice to User: The **Map Number** shown below should be used when placing map orders; the **Community Number** shown above should be used on insurance applications for the subject community.



**MAP NUMBER**  
**53053C0343E**  
**EFFECTIVE DATE**  
**MARCH 7, 2017**

Federal Emergency Management Agency

This is an official FIRMette showing a portion of the above-referenced flood map created from the MSC FIRMette Web tool. This map does not reflect changes or amendments which may have been made subsequent to the date on the title block. For additional information about how to make sure the map is current, please see the Flood Hazard Mapping Updates Overview Fact Sheet available on the FEMA Flood Map Service Center home page at <https://msc.fema.gov>.

### **CHAPTER 3 - OFF-SITE ANALYSIS**

A downstream study was completed and aided by City of Puyallup and Pierce County GIS information. The downstream flow paths and drainage features are based on this mapping information. The project site consists of two threshold discharge areas. The storm systems are designed to infiltrate 100 percent of runoff for the majority of the site, but should emergency overflow occur for the systems, following is a description of the downstream drainage paths.

#### **Northwest TDA**

Runoff from the northwest portion of the project would flow generally to the northwest for approximately 280 feet to an unnamed water course. Runoff would continue generally to the west within the water course for approximately 170 feet where it would enter a pipe inlet. Runoff would continue to the west for approximately 108 feet within a 24-inch pipe to a catch basin. Runoff would continue to the north for approximately 26 feet within a 24-inch pipe to a catch basin. Runoff would continue to the west underneath 9<sup>th</sup> Street SW (94<sup>th</sup> Ave E) for approximately 98 feet within a 24-inch pipe and discharge to an unnamed water course. Runoff would continue generally to the southwest within the water course for approximately 300 feet where it would enter a culvert. Runoff would continue to the west underneath 94<sup>rd</sup> Ave E for approximately 22 feet within a 24-inch pipe and discharge to an unnamed water course. Runoff would continue generally to the southwest within the water course for approximately 367 feet where it would enter a culvert. Runoff would continue generally to the southwest and underneath 92<sup>nd</sup> Ave E for approximately 192 feet within a 24-inch pipe and discharge to an unnamed water course. Runoff would continue generally to the southwest within the water course for approximately 780 feet where it would enter a culvert. Runoff would continue generally to the west for approximately 182 feet within an 18-inch pipe and discharge to an unnamed water course. Runoff would continue generally to the northwest within the water course for approximately 240 feet where it would enter a pothole.

#### **Southeast TDA**

Runoff from the southeast portion of the project would flow generally to the east in the gutter line of 43<sup>rd</sup> Avenue SW for approximately 245 feet to a catch basin. Runoff would discharge from the catch basin and continue generally to the northeast through a low area/potential wetland for approximately 1,375 feet to a culvert. Runoff would continue generally to the southwest for approximately 510 feet within a 36-inch pipe to a catch basin. Runoff would continue generally to the southwest and underneath 7<sup>th</sup> Street SW for approximately 58 feet within a 24-inch pipe and discharge to an unnamed water course. Runoff would continue generally to the southwest within the water course for approximately 328 feet where it would combine with the drainage path for the northwest TDA.

There are no known emergency services located within ¼-mile down gradient from the project site.

# DOWNSTREAM DRAINAGE PATH MAP

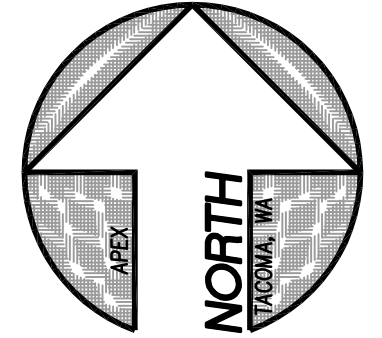
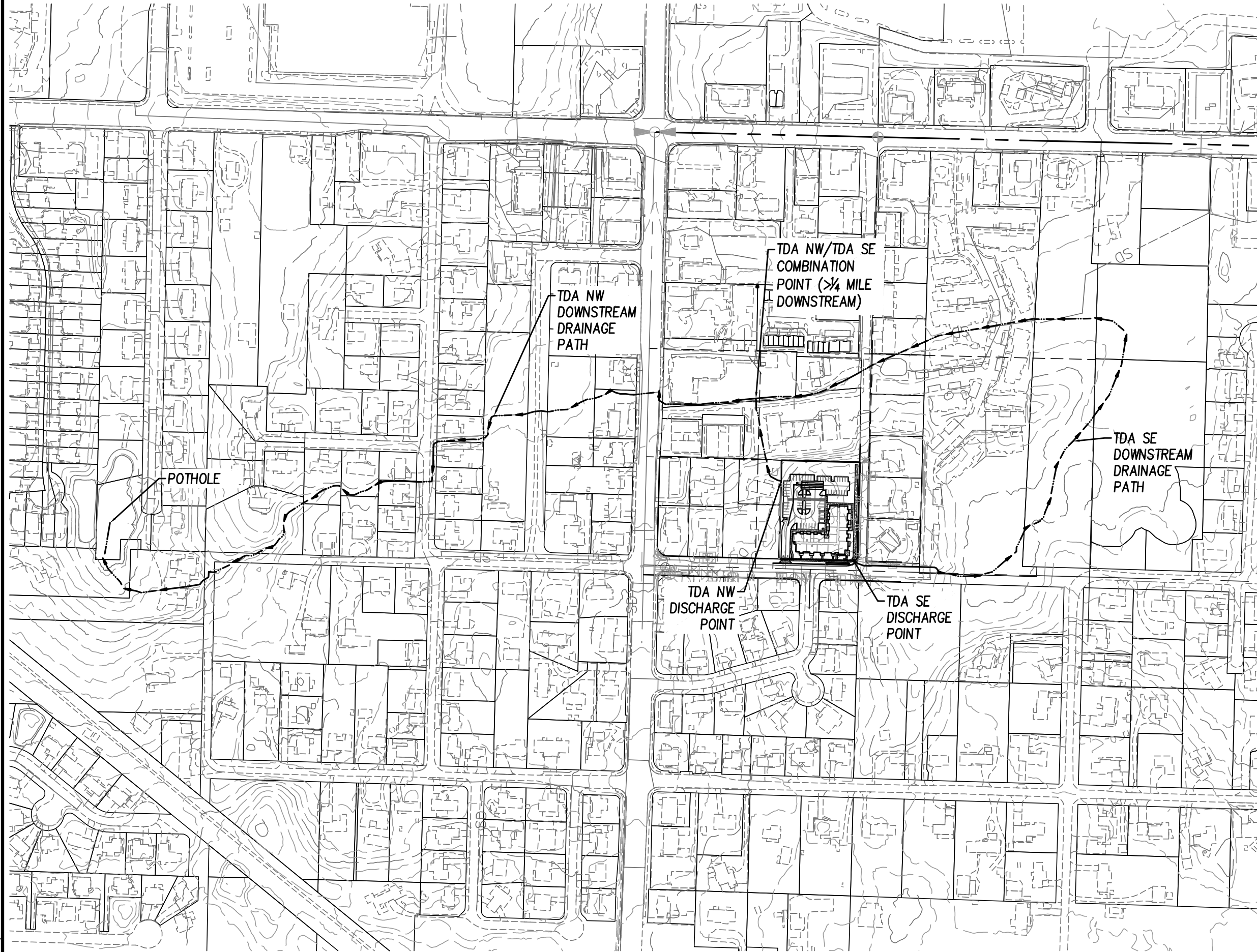

GRAPHIC SCALE

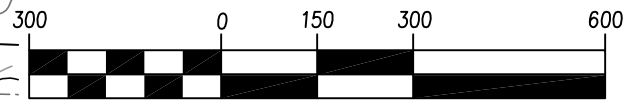

( IN FEET )  
1 inch = 300 ft.

I:\35043-01\Work\35043\_BSN.dwg  
5/2/2025 10:25 AM

35043-01

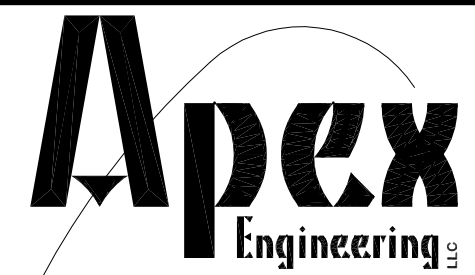

2601 South 35th St., Suite 200  
Tacoma, Washington 98409-7479  
(253) 473-4494 FAX: (253) 473-0599  
© APEX ENGINEERING LLC 2025

## **CHAPTER 4 – PERMANENT STORMWATER CONTROL PLAN**

### ***Part 1 – Existing Site Hydrology***

The site is generally heavily vegetated with a mix of trees and shrubs. The topography generally slopes up from the boundaries of the site for approximately 50 feet to a ridge and then slopes down to a depression in the central area of the site. The project site consists of two threshold discharge areas. Runoff from the northwest portion of the project flows generally to the northwest and runoff from the southeast portion of the project flows generally to the southeast. Run-on is considered minimal, as topography generally slopes away from the project site.

Refer to the Pre-Developed Basin Map included in Appendix C for additional information.

#### **Summary of Pre-developed Site Land Cover**

<b>Sub-Basin ID</b>	<b>Land Use and Cover Condition</b>	<b>Acreage</b>
TDA NW	C, Forest, Mod	1.052 +/-
TDA SE	C, Forest, Mod	0.720 +/-

#### **Summary of Pre-developed Condition Event Output: WWHM2012**

<b>Sub-Basin ID: TDA NW</b>	<b>Peak Flow (cfs)</b>
2-year pre-developed	0.0224
10-year pre-developed	0.0419
25-year pre-developed	0.0489
100-year pre-developed	0.0565

<b>Sub-Basin ID: TDA SE</b>	<b>Peak Flow (cfs)</b>
2-year pre-developed	0.0153
10-year pre-developed	0.0287
25-year pre-developed	0.0335
100-year pre-developed	0.0387

### ***Part 2 – Developed Site Hydrology***

Drainage from the frontage improvements to 43<sup>rd</sup> Avenue SW and 7<sup>th</sup> Street SW is proposed to utilize a proprietary treatment system for basic water quality and an infiltration trench for flow control. Drainage from the onsite improvements is proposed to be collected and conveyed to a proprietary treatment system for metals/enhanced water quality and an underground chamber system to utilize infiltration for flow control. Portions of the developed onsite and offsite improvements will bypass the storm facilities but have been accounted for in the design.

Refer to the Developed Basin Map included in Appendix C for additional information.



### Summary of Developed Site Land Cover

Sub-Basin ID	Land Use and Cover Condition	Acreage
TDA NW	Roads/Flat	0.641+/-
TDA NW	Roof Tops/Flat	0.362 +/-
TDA NW	C, Pasture, Flat	0.282 +/-
TDA NW - BYPASS	Roads/Flat	0.102 +/-
TDA NW - BYPASS	C, Pasture, Flat	0.073 +/-
TDA SE - N	Roads/Mod	0.077+/-
TDA SE - N	C, Pasture, Mod	0.021 +/-
TDA SE - S	Roads/Mod	0.076 +/-
TDA SE - S	C, Pasture, Mod	0.035 +/-
TDA SE - BYPASS	Roads/Mod	0.070 +/-
TDA SE - BYPASS	C, Pasture, Mod	0.035 +/-

### Summary of Developed Site Event Output: WWHM2012 – Developed Inflow

Sub-Basin ID: TDA NW (POC 1)	Peak Flow (cfs)
2-year developed	0.3546
10-year developed	0.5642
25-year developed	0.6849
100-year developed	0.8849

### Summary of Developed Site Event Output: WWHM2012 - Mitigated

Sub-Basin ID: TDA NW (POC 1)	Peak Flow (cfs)
2-year developed	0.0366
10-year developed	0.0582
25-year developed	0.0707
100-year developed	0.0914

### Summary of Developed Site Event Output: WWHM2012 – Developed Inflow

Sub-Basin ID: TDA SE (POC 2)	Peak Flow (cfs)
2-year developed	0.0604
10-year developed	0.0997
25-year developed	0.1235
100-year developed	0.1644

### Summary of Developed Site Event Output: WWHM2012 - Mitigated

Sub-Basin ID: TDA SE (POC 2)	Peak Flow (cfs)
2-year developed	0.0278

10-year developed	0.0458
25-year developed	0.0567
100-year developed	0.0755

**Part 3 - Performance Standards and Goals**

Drainage from the frontage improvements to 43<sup>rd</sup> Avenue SW and 7<sup>th</sup> Street SW is proposed to utilize a proprietary system with WSDOE GULD for basic water quality treatment. Drainage from the onsite improvements is proposed to utilize a proprietary system with WSDOE GULD for metals/enhanced water quality treatment.

Drainage from the offsite and onsite portions of the project is proposed to drain to infiltration systems for flow control. Portions of the developed onsite and offsite improvements will bypass the storm facilities because of elevation constraints. These bypass areas for both TDAs are proposed to meet the Flow Control Performance Standard, stormwater discharges shall match developed discharge durations to pre-developed durations for the range of pre-developed discharge rates from 50% of the 2-year peak flow up to the full 50-year peak flow.

Per Figure I-3.3 of the SWMMWW, the project has chosen to meet the LID performance standard, stormwater discharges shall match developed discharge durations to pre-developed durations for the range of pre-developed discharge rates from 8% of the 2-year peak flow to 50% of the 2-year peak flow.

**Part 4 – Low Impact Development Features**

Drainage from the offsite and onsite portions of the project is proposed to drain to infiltration systems for flow control. Portions of the developed onsite and offsite improvements will bypass the storm facilities because of elevation constraints. These bypass areas for both TDAs are proposed to meet the Flow Control Performance Standard and the LID performance standard.

**Part 5 - Flow Control System**

Runoff from the majority of the developed onsite areas is proposed to be directed to an underground chamber system for infiltration to provide flow control. Runoff from the majority of the frontage improvements will be directed to an infiltration trench to provide flow control. The geotechnical report completed by Quality Geo NW, PLLC recommends a design infiltration rate of 4.39 inches per hour for the design of the facilities. Refer to Appendix D for a copy of the geotechnical report.

Portions of the developed onsite and offsite improvements will bypass the storm facilities because of elevation constraints. These bypass areas for both TDAs are proposed to meet the Flow Control Performance Standard and the LID performance standard.

The WWHM2012 software was utilized to determine the required infiltration volumes and the durations. An onsite chamber system with 5 rows of 9 chambers each has a footprint of approximately



25.42 feet by 67.21 feet and should infiltrate 100 percent of the developed runoff per the WWHM analysis. An offsite infiltration trench with dimensions of 2.5 feet deep by 6 feet wide by 68 feet long should infiltrate 100 percent of the developed runoff per the WWHM analysis. It should be noted that the final configuration of the facilities may differ from the calculated dimensions upon final design with the site development permit.

Refer to the Engineering Calculations included in Appendix C for preliminary calculations and details, and to the preliminary utility plan for the infiltration facilities locations.

### ***Part 6 – Runoff Treatment System***

Drainage from the frontage improvements to 43<sup>rd</sup> Avenue SW and 7<sup>th</sup> Street SW is proposed to utilize a proprietary system with WSDOE GULD for basic water quality treatment, such as a Contech Stormfilter catch basin. Drainage from the onsite improvements is proposed to utilize a proprietary system with WSDOE GULD for metals/enhanced water quality treatment, such as an OldCastle BioPod vault.

The WWHM2012 software was utilized to determine the required water quality flow rate for each facility.

Refer to the Engineering Calculations included in Appendix C for preliminary calculations and details, and to the preliminary utility plan for the treatment facilities locations.

### ***Part 7 – Source Control***

Source control will be addressed with the future site development permit and outlined in Attachment B of the Operation and Maintenance Manual.

### ***Part 8 - Conveyance System Analysis and Design***

Runoff is proposed to be directed to catch basins with associated pipes to direct drainage to the proposed facilities. A conveyance system analysis will be completed with the future site development permit.

## **CHAPTER 5 – CONSTRUCTION STORMWATER POLLUTION PREVENTION PLAN**

A Construction Stormwater Pollution Prevention Plan will be included with the future grading/site development permit.

## **CHAPTER 6 – SPECIAL REPORTS AND STUDIES**

A preliminary geotechnical report was prepared for the project site by GeoResources, dated April 15<sup>th</sup>, 2020 and subsequent groundwater monitoring was performed. An additional geotechnical report was

prepared by Quality Geo NW, PLLC, dated January 27,2025. A copy of the reports has been included within Appendix D and should be referenced for additional information regarding the onsite soils.

#### **CHAPTER 7 – OTHER PERMITS**

There are no other known permits with more restrictive drainage-related requirements.

#### **CHAPTER 8 – OPERATION AND MAINTENANCE MANUAL**

An Operation and Maintenance Manual will be included with the future site development permit.

#### **CHAPTER 9 – DECLARATION OF COVENANT FOR PRIVATELY MAINTAINED FLOW CONTROL AND RUNOFF TREATMENT BMPS**

A Declaration of Covenant for Privately Maintained Flow Control and Runoff Treatment BMPs will be included with the future site development permit as necessary.

#### **CHAPTER 10 – DECLARATION OF COVENANT FOR PRIVATELY MAINTAINED LID BMPS**

A Declaration of Covenant for Privately Maintained LID BMPs will be included with the future site development permit as necessary.

#### **CHAPTER 11 – BOND QUANTITIES WORKSHEET**

A bond quantities worksheet will be prepared as necessary with the site development permit.

I:\35043-01\Docs-Reports\Reports\35043\_Drainage Report\_042525.doc

**APPENDIX A**

OPERATION AND MAINTENANCE (O & M) MANUAL  
(TO BE PROVIDED WITH FUTURE SITE DEVELOPMENT PERMIT)



**APPENDIX B**

CONSTRUCTION STORMWATER  
POLLUTION PREVENTION PLAN  
(TO BE PROVIDED WITH FUTURE SITE DEVELOPMENT PERMIT)



**APPENDIX C**

**ENGINEERING CALCULATIONS**

SWMMWW - FLOW CHARTS



**Figure I-3.1: Flow Chart for Determining Requirements for New Development**

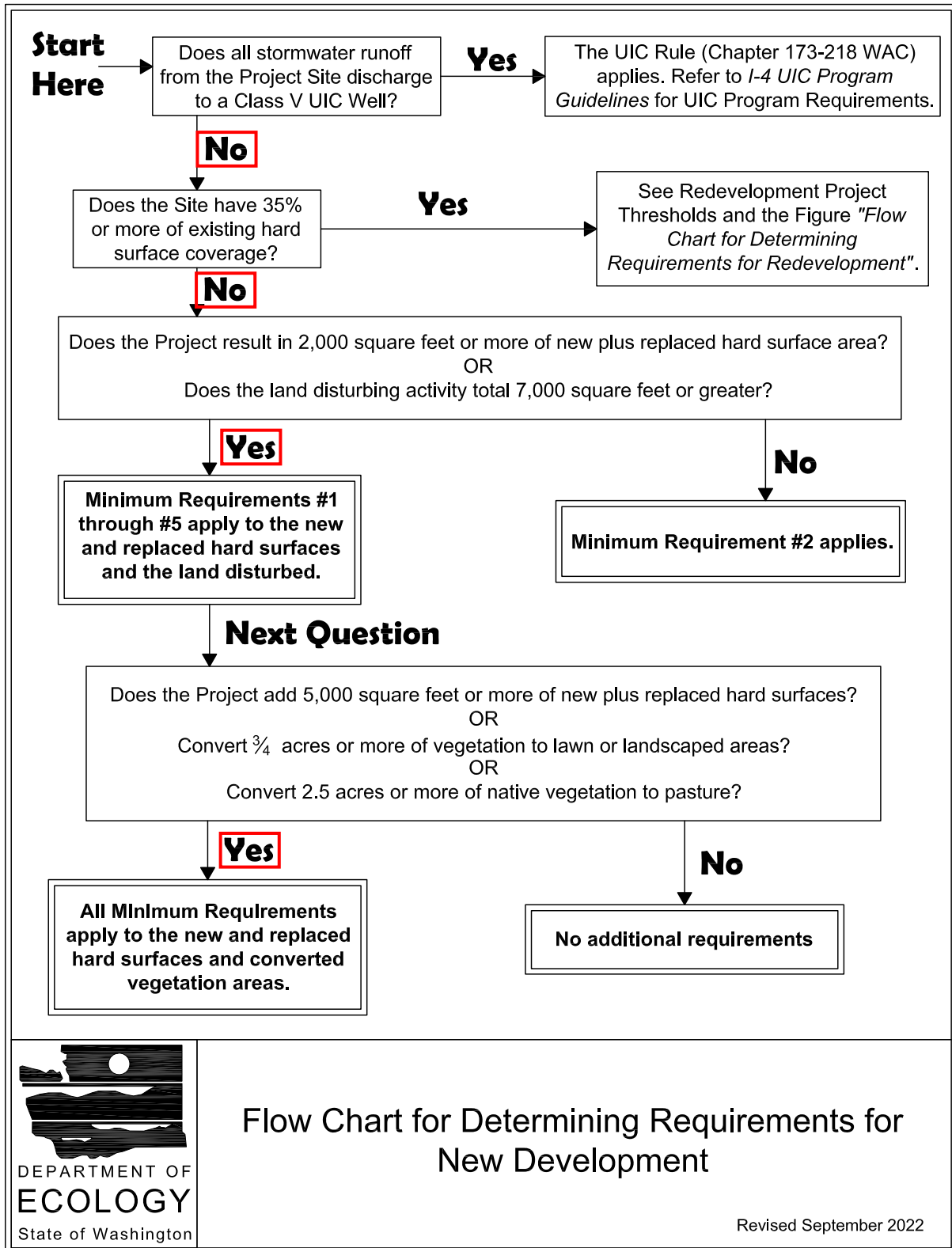

Flow Chart for Determining Requirements for  
New Development

Revised September 2022

**Figure I-3.3: Flow Chart for Determining MR #5 Requirements**

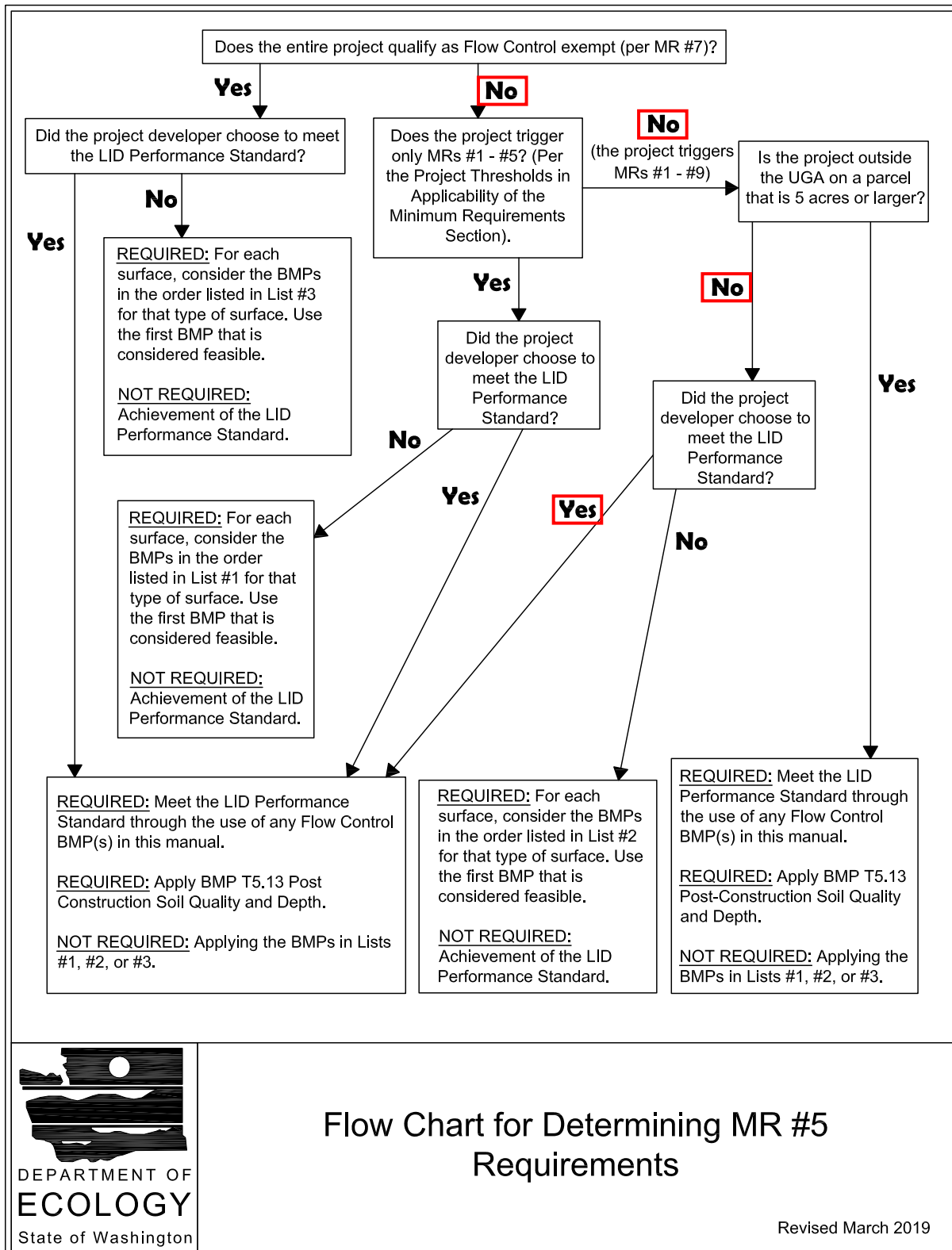

## Flow Chart for Determining MR #5 Requirements

Revised March 2019

## BASIN ANALYSIS

# 43rd Ave. Apartments

## Basin Analysis

	Basin	Total Area (sf)	Total Area (ac)	R/W Impervious Area (sf)	Lot/Tract Impervious Area (sf)	Total Impervious Area (sf)	Total Impervious Area (ac)	Pervious Area - Till Forest (sf)	Pervious Area - Till Forest (ac)	Total Pervious Area - Till Pasture* (sf)	Total Pervious Area - Till Pasture* (ac)
TDA NW	Predeveloped	45,815	1.052	1,345	0	1,345	0.031	44,470	1.021	0	0.000
	Developed	55,936	1.284	0	43,671	43,671	1.003	0	0.000	12,265	0.282
	Bypass	7,617	0.175	4,434	0	4,434	0.102	0	0.000	3,183	0.073
TDA SE	Predeveloped	31,371	0.720	3,743	0	3,743	0.086	27,628	0.634	0	0.000
	Developed	9,064	0.208	6,561	80	6,641	0.152	0	0.000	2,423	0.056
	Bypass	4,569	0.105	2,745	320	3,065	0.070	0	0.000	1,504	0.035

\*Per BMP T5.13: Post-Construction Soil Quality and Depth, Areas meeting the design guidelines may be entered into approved runoff models as "Pasture" rather than "Lawn."

### Chamber System Analysis:

For purposes of WWHM calculations, an equivalent void ratio has been determined for the portion of the trench from the bottom to top of chamber

Assumptions/Given:	Surrounding stone void ratio =	0.4
	Chamber surface area (sf) =	6.632
	Stone each side of chamber (ft) =	0.25
	Chamber height (ft) =	2.525
	Chamber width (ft) =	4.283
	Trench surface area per chamber (sf) = [Chamber width + 2 x Stone each side of chamber] x Chamber height =	12.078
	Stone surface area per chamber (sf) = Trench surface area - Chamber surface area =	5.446
	Trench void ratio from bottom to top of chamber =	0.729

# PRE-DEVELOPED BASIN MAP

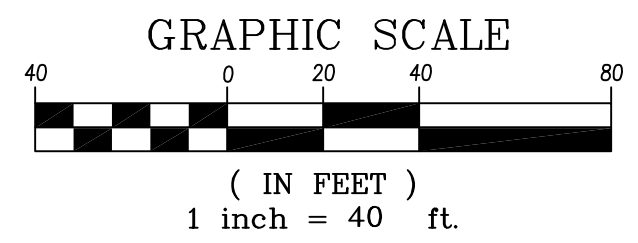
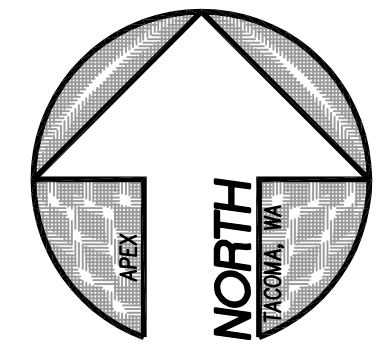
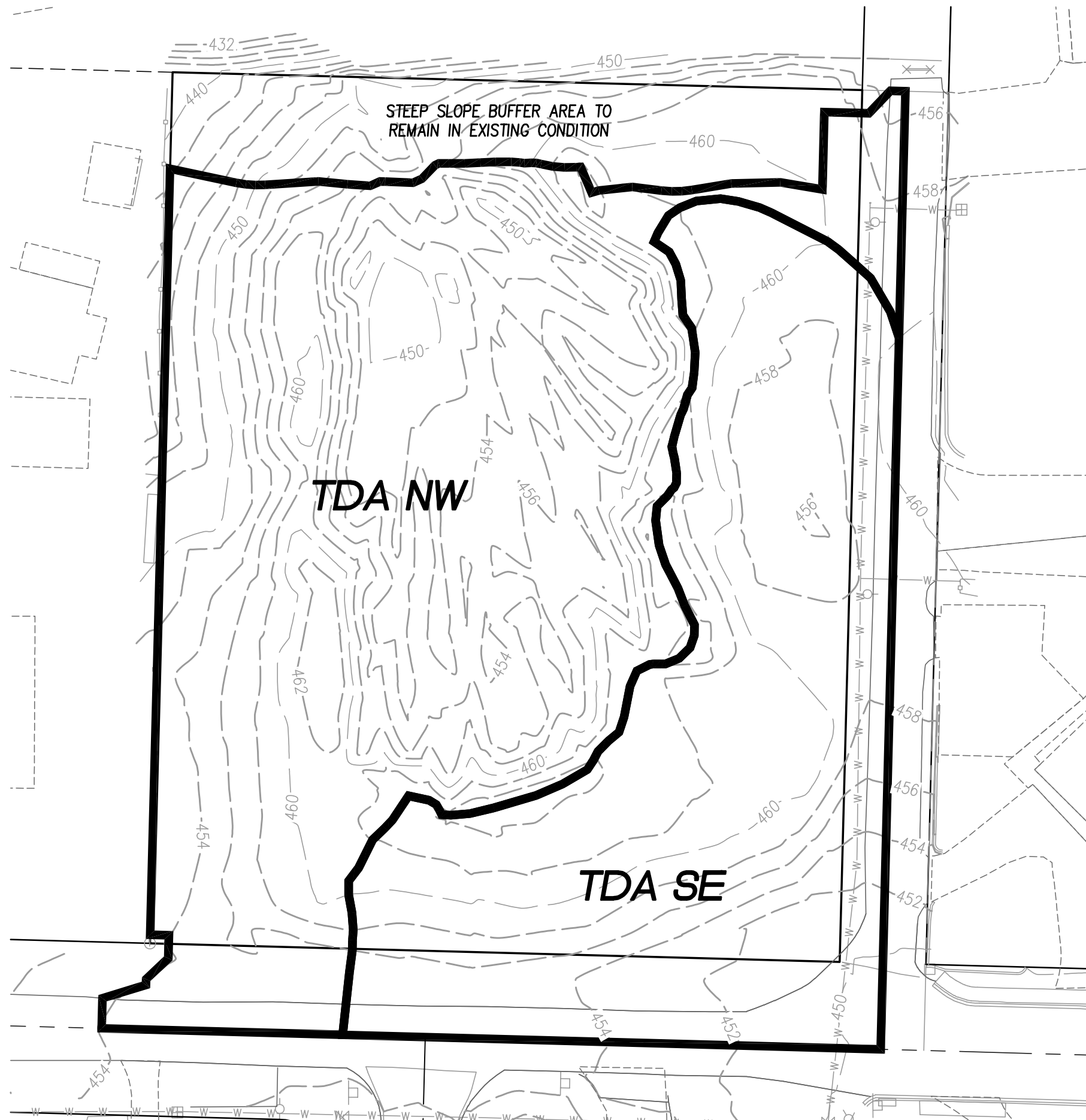

**Apex**  
Engineering LLC

2601 South 35th St., Suite 200  
Tacoma, Washington 98409-7479  
(253) 473-4494 FAX: (253) 473-0599  
© APEX ENGINEERING LLC 2025

35043-01

I:\35043-01\Work\35043\_BSN.dwg  
5/1/2025 10:30 AM

# DEVELOPED BASIN MAP

Either show on this basin map, or provide another basin map that shows a breakdown of the surface coverages. Include a table to accompany the surface coverage breakdown. [Drainage Report, pg. 26]

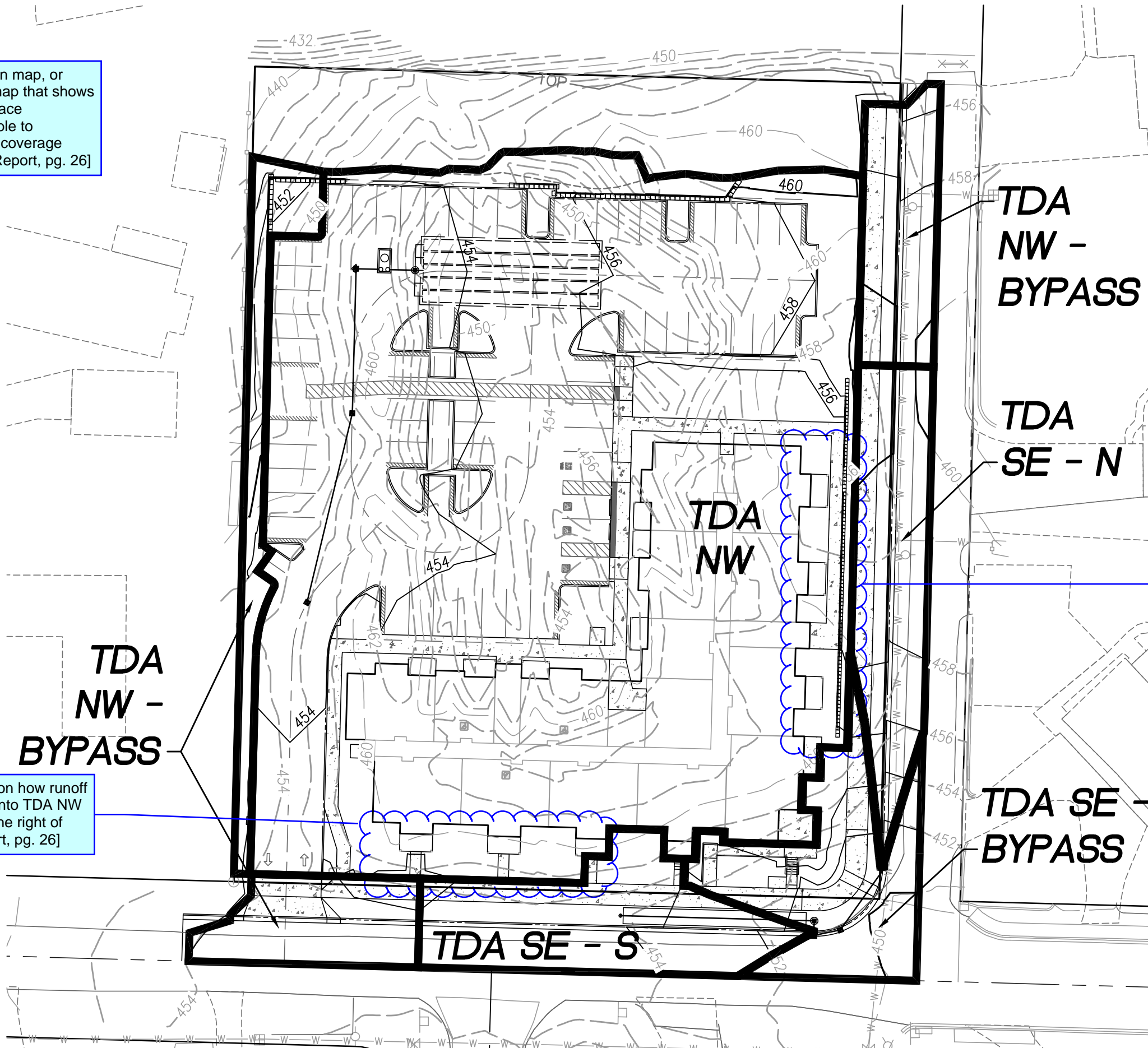
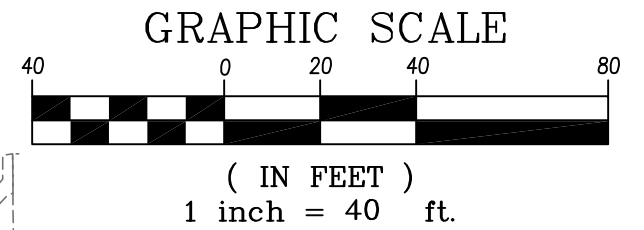
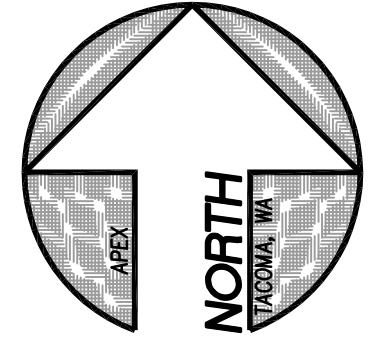

Provide further clarification on how runoff from this area is conveyed into TDA NW rather than flowing toward the right of way TDAs. [Drainage Report, pg. 26]

Provide further clarification on how runoff from this area is conveyed into TDA NW rather than flowing toward the right of way TDAs. [Drainage Report, pg. 26]

**Apex**  
Engineering LLC

2601 South 35th St., Suite 200  
Tacoma, Washington 98409-7479  
(253) 473-4494 FAX: (253) 473-0599  
© APEX ENGINEERING LLC 2025

## FLOW CONTROL CALCULATIONS

**WWHM2012  
PROJECT REPORT**

---

**Project Name:** 35043-01-FLOWCNTRL  
**Site Name:** 43rd MF  
**Site Address:**  
**City** :  
**Report Date:** 5/2/2025  
**Gage** : 38 IN CENTRAL  
**Data Start** : 10/01/1901  
**Data End** : 09/30/2059  
**Precip Scale:** 1.00  
**Version Date:** 2021/08/18  
**Version** : 4.2.18

---

**Low Flow Threshold for POC 1** : 8 Percent of the 2 Year

---

**High Flow Threshold for POC 1:** 50 year

---

**Low Flow Threshold for POC 2** : 50 Percent of the 2 Year

---

**High Flow Threshold for POC 2:** 50 year

---

**PREDEVELOPED LAND USE**

**Name** : TDA NW  
**Bypass:** No

**GroundWater:** No

<u>Pervious Land Use</u>	<u>acre</u>
C, Forest, Mod	1.052
<b>Pervious Total</b>	<b>1.052</b>
<u>Impervious Land Use</u>	<u>acre</u>
Impervious Total	0
<b>Basin Total</b>	<b>1.052</b>

---

**Element Flows To:**

Surface	Interflow	Groundwater
---------	-----------	-------------

---

**Name** : TDA SE  
**Bypass:** No

**GroundWater:** No

<u>Pervious Land Use</u>	<u>acre</u>
C, Forest, Mod	0.72
<b>Pervious Total</b>	<b>0.72</b>
<u>Impervious Land Use</u>	<u>acre</u>
Impervious Total	0
<b>Basin Total</b>	<b>0.72</b>

---



Element Flows To:  
 Surface                      Interflow                      Groundwater

---

**MITIGATED LAND USE**

Name : TDA NW  
 Bypass: No

GroundWater: No

Pervious Land Use                      acre  
 C, Pasture, Flat                      0.282

Pervious Total                      0.282

Impervious Land Use                      acre  
 ROADS FLAT                      0.641  
 ROOF TOPS FLAT                      0.362

Impervious Total                      1.003

Basin Total                      1.285

---

Element Flows To:  
 Surface                      Interflow                      Groundwater  
 Gravel Trench Bed 1      Gravel Trench Bed 1

---

Name : Gravel Trench Bed 1  
 Bottom Length: 67.21 ft.  
 Bottom Width: 25.42 ft.  
 Trench bottom slope 1: 0 To 1  
 Trench Left side slope 0: 0 To 1  
 Trench right side slope 2: 0 To 1  
 Material thickness of first layer: 1.5  
 Pour Space of material for first layer: 0.4  
 Material thickness of second layer: 2.525  
 Pour Space of material for second layer: 0.729  
 Material thickness of third layer: 1  
 Pour Space of material for third layer: 0.4  
 Infiltration On  
 Infiltration rate: 4.39  
 Infiltration safety factor: 1  
 Total Volume Infiltrated (ac-ft.): 432.08  
 Total Volume Through Riser (ac-ft.): 0  
 Total Volume Through Facility (ac-ft.): 432.08  
 Percent Infiltrated: 100  
 Total Precip Applied to Facility: 0  
 Total Evap From Facility: 0  
Discharge Structure  
 Riser Height: 5.025 ft.  
 Riser Diameter: 10 in.

Element Flows To:  
 Outlet 1                      Outlet 2

---

**Gravel Trench Bed Hydraulic Table**

Stage(feet)	Area(ac.)	Volume(ac-ft.)	Discharge(cfs)	Infilt(cfs)
0.0000	0.039	0.000	0.000	0.000
0.0667	0.039	0.001	0.000	0.173
0.1333	0.039	0.002	0.000	0.173
0.2000	0.039	0.003	0.000	0.173
0.2667	0.039	0.004	0.000	0.173
0.3333	0.039	0.005	0.000	0.173
0.4000	0.039	0.006	0.000	0.173
0.4667	0.039	0.007	0.000	0.173
0.5333	0.039	0.008	0.000	0.173
0.6000	0.039	0.009	0.000	0.173

0.6667	0.039	0.010	0.000	0.173
0.7333	0.039	0.011	0.000	0.173
0.8000	0.039	0.012	0.000	0.173
0.8667	0.039	0.013	0.000	0.173
0.9333	0.039	0.014	0.000	0.173
1.0000	0.039	0.015	0.000	0.173
1.0667	0.039	0.016	0.000	0.173
1.1333	0.039	0.017	0.000	0.173
1.2000	0.039	0.018	0.000	0.173
1.2667	0.039	0.019	0.000	0.173
1.3333	0.039	0.020	0.000	0.173
1.4000	0.039	0.022	0.000	0.173
1.4667	0.039	0.023	0.000	0.173
1.5333	0.039	0.024	0.000	0.173
1.6000	0.039	0.026	0.000	0.173
1.6667	0.039	0.028	0.000	0.173
1.7333	0.039	0.030	0.000	0.173
1.8000	0.039	0.032	0.000	0.173
1.8667	0.039	0.034	0.000	0.173
1.9333	0.039	0.036	0.000	0.173
2.0000	0.039	0.038	0.000	0.173
2.0667	0.039	0.040	0.000	0.173
2.1333	0.039	0.042	0.000	0.173
2.2000	0.039	0.044	0.000	0.173
2.2667	0.039	0.045	0.000	0.173
2.3333	0.039	0.047	0.000	0.173
2.4000	0.039	0.049	0.000	0.173
2.4667	0.039	0.051	0.000	0.173
2.5333	0.039	0.053	0.000	0.173
2.6000	0.039	0.055	0.000	0.173
2.6667	0.039	0.057	0.000	0.173
2.7333	0.039	0.059	0.000	0.173
2.8000	0.039	0.061	0.000	0.173
2.8667	0.039	0.063	0.000	0.173
2.9333	0.039	0.064	0.000	0.173
3.0000	0.039	0.066	0.000	0.173
3.0667	0.039	0.068	0.000	0.173
3.1333	0.039	0.070	0.000	0.173
3.2000	0.039	0.072	0.000	0.173
3.2667	0.039	0.074	0.000	0.173
3.3333	0.039	0.076	0.000	0.173
3.4000	0.039	0.078	0.000	0.173
3.4667	0.039	0.080	0.000	0.173
3.5333	0.039	0.082	0.000	0.173
3.6000	0.039	0.084	0.000	0.173
3.6667	0.039	0.085	0.000	0.173
3.7333	0.039	0.087	0.000	0.173
3.8000	0.039	0.089	0.000	0.173
3.8667	0.039	0.091	0.000	0.173
3.9333	0.039	0.093	0.000	0.173
4.0000	0.039	0.095	0.000	0.173
4.0667	0.039	0.096	0.000	0.173
4.1333	0.039	0.097	0.000	0.173
4.2000	0.039	0.098	0.000	0.173
4.2667	0.039	0.099	0.000	0.173
4.3333	0.039	0.100	0.000	0.173
4.4000	0.039	0.101	0.000	0.173
4.4667	0.039	0.102	0.000	0.173
4.5333	0.039	0.103	0.000	0.173
4.6000	0.039	0.104	0.000	0.173
4.6667	0.039	0.105	0.000	0.173
4.7333	0.039	0.106	0.000	0.173
4.8000	0.039	0.108	0.000	0.173
4.8667	0.039	0.109	0.000	0.173
4.9333	0.039	0.110	0.000	0.173
5.0000	0.039	0.111	0.000	0.173
5.0667	0.039	0.113	0.075	0.173
5.1333	0.039	0.116	0.311	0.173
5.2000	0.039	0.119	0.614	0.173
5.2667	0.039	0.121	0.921	0.173
5.3333	0.039	0.124	1.171	0.173

5.4000	0.039	0.126	1.332	0.173
5.4667	0.039	0.129	1.453	0.173
5.5333	0.039	0.132	1.559	0.173
5.6000	0.039	0.134	1.658	0.173
5.6667	0.039	0.137	1.752	0.173
5.7333	0.039	0.139	1.840	0.173
5.8000	0.039	0.142	1.925	0.173
5.8667	0.039	0.145	2.006	0.173
5.9333	0.039	0.147	2.084	0.173
6.0000	0.039	0.150	2.159	0.173

Name : TDA NW - BYPASS  
 Bypass: Yes

GroundWater: No

<u>Pervious Land Use</u>	<u>acre</u>
C, Pasture, Flat	.073
Pervious Total	0.073
<u>Impervious Land Use</u>	<u>acre</u>
ROADS FLAT	0.102
Impervious Total	0.102
Basin Total	0.175

Element Flows To:  
 Surface                      Interflow                      Groundwater

Name : TDA SE - BYPASS  
 Bypass: Yes

GroundWater: No

<u>Pervious Land Use</u>	<u>acre</u>
C, Pasture, Mod	.035
Pervious Total	0.035
<u>Impervious Land Use</u>	<u>acre</u>
ROADS MOD	0.07
Impervious Total	0.07
Basin Total	0.105

Element Flows To:  
 Surface                      Interflow                      Groundwater

Name : TDA SE - N  
 Bypass: No

GroundWater: No

<u>Pervious Land Use</u>	<u>acre</u>
C, Pasture, Mod	.021
Pervious Total	0.021
<u>Impervious Land Use</u>	<u>acre</u>
ROADS MOD	0.077
Impervious Total	0.077

Basin Total 0.098

Element Flows To:

Surface	Interflow	Groundwater
Gravel Trench Bed 2	Gravel Trench Bed 2	

Name : Gravel Trench Bed 2  
 Bottom Length: 68.00 ft.  
 Bottom Width: 6.00 ft.  
 Trench bottom slope 1: 0 To 1  
 Trench Left side slope 0: 0 To 1  
 Trench right side slope 2: 0 To 1  
 Material thickness of first layer: 2.5  
 Pour Space of material for first layer: 0.4  
 Material thickness of second layer: 0  
 Pour Space of material for second layer: 0  
 Material thickness of third layer: 0  
 Pour Space of material for third layer: 0  
 Infiltration On  
 Infiltration rate: 4.39  
 Infiltration safety factor: 1  
 Total Volume Infiltrated (ac-ft.): 67.857  
 Total Volume Through Riser (ac-ft.): 0  
 Total Volume Through Facility (ac-ft.): 67.858  
 Percent Infiltrated: 100  
 Total Precip Applied to Facility: 0  
 Total Evap From Facility: 0  
Discharge Structure  
 Riser Height: 2.5 ft.  
 Riser Diameter: 10 in.

Element Flows To:

Outlet 1	Outlet 2
----------	----------

Gravel Trench Bed Hydraulic Table

Stage(feet)	Area(ac.)	Volume(ac-ft.)	Discharge(cfs)	Infilt(cfs)
0.0000	0.009	0.000	0.000	0.000
0.0333	0.009	0.000	0.000	0.041
0.0667	0.009	0.000	0.000	0.041
0.1000	0.009	0.000	0.000	0.041
0.1333	0.009	0.000	0.000	0.041
0.1667	0.009	0.000	0.000	0.041
0.2000	0.009	0.000	0.000	0.041
0.2333	0.009	0.000	0.000	0.041
0.2667	0.009	0.001	0.000	0.041
0.3000	0.009	0.001	0.000	0.041
0.3333	0.009	0.001	0.000	0.041
0.3667	0.009	0.001	0.000	0.041
0.4000	0.009	0.001	0.000	0.041
0.4333	0.009	0.001	0.000	0.041
0.4667	0.009	0.001	0.000	0.041
0.5000	0.009	0.001	0.000	0.041
0.5333	0.009	0.002	0.000	0.041
0.5667	0.009	0.002	0.000	0.041
0.6000	0.009	0.002	0.000	0.041
0.6333	0.009	0.002	0.000	0.041
0.6667	0.009	0.002	0.000	0.041
0.7000	0.009	0.002	0.000	0.041
0.7333	0.009	0.002	0.000	0.041
0.7667	0.009	0.002	0.000	0.041
0.8000	0.009	0.003	0.000	0.041
0.8333	0.009	0.003	0.000	0.041
0.8667	0.009	0.003	0.000	0.041
0.9000	0.009	0.003	0.000	0.041
0.9333	0.009	0.003	0.000	0.041
0.9667	0.009	0.003	0.000	0.041
1.0000	0.009	0.003	0.000	0.041
1.0333	0.009	0.003	0.000	0.041

1.0667	0.009	0.004	0.000	0.041
1.1000	0.009	0.004	0.000	0.041
1.1333	0.009	0.004	0.000	0.041
1.1667	0.009	0.004	0.000	0.041
1.2000	0.009	0.004	0.000	0.041
1.2333	0.009	0.004	0.000	0.041
1.2667	0.009	0.004	0.000	0.041
1.3000	0.009	0.004	0.000	0.041
1.3333	0.009	0.005	0.000	0.041
1.3667	0.009	0.005	0.000	0.041
1.4000	0.009	0.005	0.000	0.041
1.4333	0.009	0.005	0.000	0.041
1.4667	0.009	0.005	0.000	0.041
1.5000	0.009	0.005	0.000	0.041
1.5333	0.009	0.005	0.000	0.041
1.5667	0.009	0.005	0.000	0.041
1.6000	0.009	0.006	0.000	0.041
1.6333	0.009	0.006	0.000	0.041
1.6667	0.009	0.006	0.000	0.041
1.7000	0.009	0.006	0.000	0.041
1.7333	0.009	0.006	0.000	0.041
1.7667	0.009	0.006	0.000	0.041
1.8000	0.009	0.006	0.000	0.041
1.8333	0.009	0.006	0.000	0.041
1.8667	0.009	0.007	0.000	0.041
1.9000	0.009	0.007	0.000	0.041
1.9333	0.009	0.007	0.000	0.041
1.9667	0.009	0.007	0.000	0.041
2.0000	0.009	0.007	0.000	0.041
2.0333	0.009	0.007	0.000	0.041
2.0667	0.009	0.007	0.000	0.041
2.1000	0.009	0.007	0.000	0.041
2.1333	0.009	0.008	0.000	0.041
2.1667	0.009	0.008	0.000	0.041
2.2000	0.009	0.008	0.000	0.041
2.2333	0.009	0.008	0.000	0.041
2.2667	0.009	0.008	0.000	0.041
2.3000	0.009	0.008	0.000	0.041
2.3333	0.009	0.008	0.000	0.041
2.3667	0.009	0.008	0.000	0.041
2.4000	0.009	0.009	0.000	0.041
2.4333	0.009	0.009	0.000	0.041
2.4667	0.009	0.009	0.000	0.041
2.5000	0.009	0.009	0.000	0.041
2.5333	0.009	0.009	0.053	0.041
2.5667	0.009	0.010	0.151	0.041
2.6000	0.009	0.010	0.276	0.041
2.6333	0.009	0.010	0.420	0.041
2.6667	0.009	0.011	0.575	0.041
2.7000	0.009	0.011	0.733	0.041
2.7333	0.009	0.011	0.885	0.041
2.7667	0.009	0.012	1.024	0.041
2.8000	0.009	0.012	1.145	0.041
2.8333	0.009	0.012	1.242	0.041
2.8667	0.009	0.013	1.316	0.041
2.9000	0.009	0.013	1.372	0.041
2.9333	0.009	0.013	1.439	0.041
2.9667	0.009	0.013	1.494	0.041
3.0000	0.009	0.014	1.546	0.041

Name : TDA SE - S

Bypass: No

GroundWater: No

Pervious Land Use                      acre  
C, Pasture, Mod                              .035

Pervious Total                              0.035

<u>Impervious Land Use</u>	<u>acre</u>
ROADS MOD	0.076
<b>Impervious Total</b>	<b>0.076</b>
<b>Basin Total</b>	<b>0.111</b>

---

<b>Element Flows To:</b>		
<b>Surface</b>	<b>Interflow</b>	<b>Groundwater</b>
Gravel Trench Bed 2	Gravel Trench Bed 2	

---

**ANALYSIS RESULTS**

**Stream Protection Duration**

---

**Predeveloped Landuse Totals for POC #1**  
**Total Pervious Area:1.052**  
**Total Impervious Area:0**

---

**Mitigated Landuse Totals for POC #1**  
**Total Pervious Area:0.355**  
**Total Impervious Area:1.105**

---

**Flow Frequency Return Periods for Predeveloped. POC #1**

<u>Return Period</u>	<u>Flow(cfs)</u>
2 year	0.022385
5 year	0.035014
10 year	0.041901
25 year	0.048925
50 year	0.053106
100 year	0.056546

**Flow Frequency Return Periods for Mitigated. POC #1**

<u>Return Period</u>	<u>Flow(cfs)</u>
2 year	0.036581
5 year	0.049118
10 year	0.058232
25 year	0.070708
50 year	0.080722
100 year	0.091374

---

**Stream Protection Duration**

**Annual Peaks for Predeveloped and Mitigated. POC #1**

<u>Year</u>	<u>Predeveloped</u>	<u>Mitigated</u>
1902	0.016	0.042
1903	0.014	0.047
1904	0.026	0.056
1905	0.011	0.024
1906	0.005	0.027
1907	0.034	0.038
1908	0.025	0.030
1909	0.025	0.036
1910	0.034	0.035
1911	0.022	0.039
1912	0.085	0.073
1913	0.035	0.028
1914	0.009	0.117
1915	0.014	0.025
1916	0.022	0.045
1917	0.007	0.017
1918	0.024	0.036
1919	0.018	0.023
1920	0.023	0.030
1921	0.025	0.027

1922	0.025	0.042
1923	0.020	0.029
1924	0.009	0.052
1925	0.012	0.022
1926	0.022	0.042
1927	0.014	0.035
1928	0.017	0.027
1929	0.036	0.051
1930	0.023	0.054
1931	0.021	0.026
1932	0.016	0.029
1933	0.016	0.028
1934	0.046	0.048
1935	0.022	0.024
1936	0.019	0.034
1937	0.031	0.049
1938	0.018	0.024
1939	0.001	0.030
1940	0.020	0.054
1941	0.010	0.053
1942	0.030	0.042
1943	0.016	0.040
1944	0.030	0.057
1945	0.025	0.043
1946	0.015	0.035
1947	0.009	0.026
1948	0.048	0.036
1949	0.041	0.055
1950	0.012	0.031
1951	0.014	0.047
1952	0.063	0.058
1953	0.056	0.053
1954	0.020	0.030
1955	0.017	0.027
1956	0.008	0.027
1957	0.029	0.029
1958	0.060	0.038
1959	0.037	0.039
1960	0.010	0.029
1961	0.037	0.081
1962	0.020	0.035
1963	0.010	0.026
1964	0.011	0.076
1965	0.042	0.035
1966	0.012	0.029
1967	0.018	0.041
1968	0.018	0.034
1969	0.018	0.031
1970	0.029	0.036
1971	0.045	0.035
1972	0.029	0.110
1973	0.037	0.064
1974	0.022	0.047
1975	0.047	0.051
1976	0.025	0.053
1977	0.008	0.022
1978	0.042	0.040
1979	0.012	0.039
1980	0.024	0.039
1981	0.023	0.036
1982	0.009	0.029
1983	0.037	0.041
1984	0.015	0.041
1985	0.025	0.047
1986	0.022	0.024
1987	0.043	0.040
1988	0.027	0.025
1989	0.024	0.023
1990	0.027	0.030
1991	0.021	0.043
1992	0.031	0.041

1993	0.030	0.047
1994	0.044	0.034
1995	0.009	0.026
1996	0.050	0.035
1997	0.019	0.031
1998	0.022	0.037
1999	0.002	0.039
2000	0.017	0.035
2001	0.009	0.027
2002	0.035	0.053
2003	0.027	0.030
2004	0.025	0.043
2005	0.053	0.083
2006	0.014	0.039
2007	0.014	0.044
2008	0.024	0.036
2009	0.016	0.027
2010	0.014	0.035
2011	0.011	0.037
2012	0.016	0.035
2013	0.013	0.033
2014	0.009	0.031
2015	0.018	0.055
2016	0.007	0.033
2017	0.034	0.052
2018	0.063	0.036
2019	0.061	0.052
2020	0.019	0.040
2021	0.031	0.034
2022	0.013	0.055
2023	0.026	0.067
2024	0.062	0.079
2025	0.023	0.035
2026	0.037	0.039
2027	0.013	0.043
2028	0.012	0.017
2029	0.025	0.029
2030	0.047	0.055
2031	0.015	0.018
2032	0.008	0.029
2033	0.014	0.037
2034	0.013	0.029
2035	0.053	0.039
2036	0.028	0.029
2037	0.007	0.039
2038	0.023	0.039
2039	0.002	0.074
2040	0.012	0.030
2041	0.016	0.037
2042	0.052	0.043
2043	0.025	0.047
2044	0.034	0.033
2045	0.023	0.027
2046	0.027	0.030
2047	0.020	0.036
2048	0.025	0.030
2049	0.023	0.044
2050	0.016	0.034
2051	0.024	0.048
2052	0.014	0.035
2053	0.024	0.030
2054	0.031	0.061
2055	0.010	0.036
2056	0.011	0.047
2057	0.017	0.023
2058	0.021	0.044
2059	0.037	0.055

---

**Stream Protection Duration**  
**Ranked Annual Peaks for Predeveloped and Mitigated. POC #1**



<b>Rank</b>	<b>Predeveloped</b>	<b>Mitigated</b>
1	0.0845	0.1174
2	0.0629	0.1100
3	0.0629	0.0826
4	0.0621	0.0814
5	0.0606	0.0790
6	0.0599	0.0757
7	0.0562	0.0743
8	0.0530	0.0734
9	0.0529	0.0675
10	0.0520	0.0637
11	0.0497	0.0611
12	0.0477	0.0581
13	0.0471	0.0570
14	0.0469	0.0563
15	0.0464	0.0554
16	0.0450	0.0554
17	0.0445	0.0550
18	0.0430	0.0549
19	0.0420	0.0546
20	0.0417	0.0537
21	0.0408	0.0536
22	0.0375	0.0532
23	0.0373	0.0531
24	0.0373	0.0531
25	0.0373	0.0530
26	0.0372	0.0525
27	0.0371	0.0525
28	0.0359	0.0521
29	0.0353	0.0514
30	0.0349	0.0512
31	0.0343	0.0495
32	0.0341	0.0485
33	0.0340	0.0476
34	0.0335	0.0474
35	0.0311	0.0471
36	0.0310	0.0469
37	0.0307	0.0468
38	0.0306	0.0467
39	0.0305	0.0467
40	0.0304	0.0467
41	0.0296	0.0450
42	0.0292	0.0441
43	0.0287	0.0439
44	0.0286	0.0436
45	0.0279	0.0432
46	0.0273	0.0431
47	0.0269	0.0430
48	0.0268	0.0430
49	0.0267	0.0426
50	0.0260	0.0424
51	0.0259	0.0423
52	0.0255	0.0417
53	0.0253	0.0416
54	0.0253	0.0411
55	0.0253	0.0411
56	0.0252	0.0409
57	0.0252	0.0406
58	0.0251	0.0401
59	0.0250	0.0399
60	0.0249	0.0397
61	0.0248	0.0396
62	0.0247	0.0394
63	0.0244	0.0393
64	0.0241	0.0392
65	0.0238	0.0390
66	0.0237	0.0388
67	0.0237	0.0387
68	0.0235	0.0386
69	0.0235	0.0386
70	0.0228	0.0386

71	0.0228	0.0385
72	0.0228	0.0380
73	0.0228	0.0380
74	0.0226	0.0375
75	0.0225	0.0370
76	0.0224	0.0370
77	0.0222	0.0368
78	0.0222	0.0363
79	0.0221	0.0361
80	0.0220	0.0361
81	0.0217	0.0361
82	0.0215	0.0360
83	0.0214	0.0360
84	0.0212	0.0359
85	0.0209	0.0358
86	0.0203	0.0357
87	0.0202	0.0355
88	0.0202	0.0354
89	0.0200	0.0354
90	0.0197	0.0351
91	0.0189	0.0351
92	0.0187	0.0351
93	0.0187	0.0351
94	0.0184	0.0351
95	0.0183	0.0349
96	0.0182	0.0347
97	0.0182	0.0346
98	0.0180	0.0345
99	0.0175	0.0339
100	0.0172	0.0339
101	0.0169	0.0338
102	0.0168	0.0337
103	0.0165	0.0337
104	0.0164	0.0329
105	0.0164	0.0328
106	0.0163	0.0327
107	0.0163	0.0313
108	0.0162	0.0312
109	0.0161	0.0311
110	0.0158	0.0307
111	0.0156	0.0305
112	0.0155	0.0304
113	0.0154	0.0303
114	0.0152	0.0302
115	0.0142	0.0301
116	0.0142	0.0300
117	0.0139	0.0299
118	0.0138	0.0298
119	0.0138	0.0295
120	0.0137	0.0295
121	0.0136	0.0295
122	0.0136	0.0293
123	0.0135	0.0293
124	0.0134	0.0290
125	0.0133	0.0290
126	0.0127	0.0290
127	0.0126	0.0289
128	0.0122	0.0289
129	0.0117	0.0288
130	0.0116	0.0285
131	0.0116	0.0284
132	0.0115	0.0280
133	0.0115	0.0272
134	0.0111	0.0272
135	0.0108	0.0271
136	0.0106	0.0270
137	0.0106	0.0270
138	0.0099	0.0270
139	0.0096	0.0267
140	0.0096	0.0266
141	0.0096	0.0264

142	0.0094	0.0261
143	0.0093	0.0259
144	0.0093	0.0255
145	0.0087	0.0249
146	0.0087	0.0247
147	0.0086	0.0245
148	0.0085	0.0244
149	0.0084	0.0239
150	0.0084	0.0238
151	0.0081	0.0232
152	0.0074	0.0229
153	0.0071	0.0229
154	0.0066	0.0225
155	0.0048	0.0218
156	0.0022	0.0180
157	0.0018	0.0170
158	0.0011	0.0168

---

**Stream Protection Duration**

**POC #1**

**The Facility PASSED**

**The Facility PASSED.**

**Flow(cfs) Predev Mit Percentage Pass/Fail**

0.0018	560100	339772	60	Pass
0.0023	466917	281435	60	Pass
0.0028	394730	237392	60	Pass
0.0033	337334	202600	60	Pass
0.0039	290743	174124	59	Pass
0.0044	252239	150136	59	Pass
0.0049	219719	129859	59	Pass
0.0054	192074	112574	58	Pass
0.0059	168473	97727	58	Pass
0.0065	148917	85095	57	Pass
0.0070	131687	74071	56	Pass
0.0075	116674	64542	55	Pass
0.0080	103488	56453	54	Pass
0.0085	92076	49340	53	Pass
0.0090	82381	43035	52	Pass
0.0096	73849	37628	50	Pass
0.0101	66370	33069	49	Pass
0.0106	59777	28930	48	Pass
0.0111	53899	25429	47	Pass
0.0116	48952	22454	45	Pass
0.0122	44625	19778	44	Pass
0.0127	40725	17496	42	Pass
0.0132	37229	15462	41	Pass
0.0137	34066	13701	40	Pass
0.0142	31179	12183	39	Pass
0.0147	28576	10886	38	Pass
0.0153	26254	9734	37	Pass
0.0158	24254	8709	35	Pass
0.0163	22465	7756	34	Pass
0.0168	20803	6953	33	Pass
0.0173	19279	6221	32	Pass
0.0179	17900	5607	31	Pass
0.0184	16581	5033	30	Pass
0.0189	15274	4531	29	Pass
0.0194	14155	4087	28	Pass
0.0199	13169	3667	27	Pass
0.0205	12194	3332	27	Pass
0.0210	11329	3056	26	Pass
0.0215	10493	2793	26	Pass
0.0220	9745	2557	26	Pass
0.0225	9041	2357	26	Pass
0.0230	8382	2171	25	Pass
0.0236	7795	1987	25	Pass
0.0241	7291	1813	24	Pass
0.0246	6753	1671	24	Pass

0.0251	6299	1548	24	Pass
0.0256	5928	1422	23	Pass
0.0262	5595	1312	23	Pass
0.0267	5270	1200	22	Pass
0.0272	4972	1106	22	Pass
0.0277	4669	1026	21	Pass
0.0282	4442	951	21	Pass
0.0287	4210	877	20	Pass
0.0293	3967	802	20	Pass
0.0298	3731	736	19	Pass
0.0303	3507	691	19	Pass
0.0308	3307	644	19	Pass
0.0313	3145	592	18	Pass
0.0319	3016	559	18	Pass
0.0324	2875	518	18	Pass
0.0329	2714	486	17	Pass
0.0334	2557	453	17	Pass
0.0339	2425	416	17	Pass
0.0344	2311	389	16	Pass
0.0350	2179	367	16	Pass
0.0355	2044	329	16	Pass
0.0360	1940	307	15	Pass
0.0365	1826	286	15	Pass
0.0370	1715	257	14	Pass
0.0376	1625	243	14	Pass
0.0381	1545	226	14	Pass
0.0386	1451	210	14	Pass
0.0391	1360	197	14	Pass
0.0396	1273	181	14	Pass
0.0401	1206	170	14	Pass
0.0407	1132	160	14	Pass
0.0412	1073	145	13	Pass
0.0417	1011	136	13	Pass
0.0422	960	127	13	Pass
0.0427	905	120	13	Pass
0.0433	829	113	13	Pass
0.0438	781	107	13	Pass
0.0443	728	101	13	Pass
0.0448	667	99	14	Pass
0.0453	608	95	15	Pass
0.0458	559	92	16	Pass
0.0464	506	87	17	Pass
0.0469	455	79	17	Pass
0.0474	404	73	18	Pass
0.0479	364	68	18	Pass
0.0484	337	67	19	Pass
0.0490	310	63	20	Pass
0.0495	286	61	21	Pass
0.0500	257	60	23	Pass
0.0505	241	58	24	Pass
0.0510	217	56	25	Pass
0.0516	202	54	26	Pass
0.0521	186	52	27	Pass
0.0526	161	50	31	Pass
0.0531	142	46	32	Pass

---

**Stream Protection Duration**

---

**Predeveloped Landuse Totals for POC #2**

**Total Pervious Area:0.72**  
**Total Impervious Area:0**

---

**Mitigated Landuse Totals for POC #2**

**Total Pervious Area:0.091**  
**Total Impervious Area:0.223**

---

**Flow Frequency Return Periods for Predeveloped. POC #2**

<u>Return Period</u>	<u>Flow(cfs)</u>
2 year	0.015321
5 year	0.023964
10 year	0.028678
25 year	0.033485
50 year	0.036346
100 year	0.038701

**Flow Frequency Return Periods for Mitigated. POC #2**

<u>Return Period</u>	<u>Flow(cfs)</u>
2 year	0.027766
5 year	0.038055
10 year	0.045811
25 year	0.056746
50 year	0.065757
100 year	0.075548

**Stream Protection Duration**

**Annual Peaks for Predeveloped and Mitigated. POC #2**

<u>Year</u>	<u>Predeveloped</u>	<u>Mitigated</u>
1902	0.011	0.031
1903	0.009	0.034
1904	0.018	0.041
1905	0.007	0.019
1906	0.003	0.021
1907	0.023	0.026
1908	0.017	0.021
1909	0.017	0.026
1910	0.023	0.027
1911	0.015	0.029
1912	0.058	0.055
1913	0.024	0.026
1914	0.006	0.100
1915	0.010	0.018
1916	0.015	0.035
1917	0.005	0.015
1918	0.016	0.026
1919	0.012	0.017
1920	0.015	0.025
1921	0.017	0.019
1922	0.017	0.031
1923	0.014	0.021
1924	0.006	0.038
1925	0.008	0.016
1926	0.015	0.030
1927	0.010	0.027
1928	0.012	0.018
1929	0.025	0.037
1930	0.015	0.041
1931	0.014	0.020
1932	0.011	0.022
1933	0.011	0.021
1934	0.032	0.033
1935	0.015	0.017
1936	0.013	0.025
1937	0.021	0.039
1938	0.012	0.019
1939	0.001	0.022
1940	0.014	0.044
1941	0.007	0.044
1942	0.021	0.030
1943	0.011	0.028
1944	0.021	0.043
1945	0.017	0.030
1946	0.011	0.028
1947	0.006	0.019
1948	0.033	0.026
1949	0.028	0.039
1950	0.008	0.026
1951	0.010	0.046

1952	0.043	0.044
1953	0.038	0.036
1954	0.014	0.021
1955	0.011	0.027
1956	0.006	0.023
1957	0.020	0.021
1958	0.041	0.031
1959	0.025	0.031
1960	0.007	0.023
1961	0.026	0.065
1962	0.014	0.028
1963	0.007	0.019
1964	0.007	0.070
1965	0.029	0.030
1966	0.008	0.020
1967	0.013	0.031
1968	0.013	0.027
1969	0.012	0.022
1970	0.020	0.026
1971	0.031	0.025
1972	0.020	0.092
1973	0.025	0.048
1974	0.015	0.033
1975	0.032	0.035
1976	0.017	0.037
1977	0.006	0.017
1978	0.029	0.029
1979	0.008	0.028
1980	0.016	0.032
1981	0.016	0.030
1982	0.006	0.022
1983	0.026	0.029
1984	0.010	0.028
1985	0.017	0.038
1986	0.015	0.019
1987	0.029	0.031
1988	0.018	0.017
1989	0.017	0.019
1990	0.019	0.023
1991	0.015	0.040
1992	0.021	0.041
1993	0.020	0.033
1994	0.030	0.024
1995	0.006	0.018
1996	0.034	0.026
1997	0.013	0.023
1998	0.015	0.027
1999	0.001	0.034
2000	0.012	0.024
2001	0.006	0.026
2002	0.024	0.038
2003	0.018	0.028
2004	0.017	0.032
2005	0.036	0.079
2006	0.009	0.029
2007	0.009	0.033
2008	0.016	0.027
2009	0.011	0.021
2010	0.009	0.026
2011	0.008	0.028
2012	0.011	0.024
2013	0.009	0.025
2014	0.006	0.026
2015	0.012	0.041
2016	0.005	0.029
2017	0.023	0.037
2018	0.043	0.030
2019	0.041	0.038
2020	0.013	0.028
2021	0.021	0.023
2022	0.009	0.039

2023	0.018	0.053
2024	0.042	0.063
2025	0.016	0.030
2026	0.026	0.045
2027	0.009	0.033
2028	0.008	0.012
2029	0.017	0.020
2030	0.032	0.042
2031	0.011	0.013
2032	0.006	0.024
2033	0.009	0.028
2034	0.009	0.020
2035	0.036	0.027
2036	0.019	0.022
2037	0.004	0.036
2038	0.016	0.027
2039	0.002	0.060
2040	0.008	0.022
2041	0.011	0.026
2042	0.036	0.031
2043	0.017	0.034
2044	0.023	0.024
2045	0.016	0.019
2046	0.018	0.023
2047	0.013	0.025
2048	0.017	0.021
2049	0.016	0.032
2050	0.011	0.024
2051	0.016	0.033
2052	0.009	0.030
2053	0.017	0.022
2054	0.021	0.046
2055	0.007	0.028
2056	0.007	0.038
2057	0.011	0.017
2058	0.015	0.040
2059	0.026	0.044

---

**Stream Protection Duration  
Ranked Annual Peaks for Predeveloped and Mitigated. POC #2**

<b>Rank</b>	<b>Predeveloped</b>	<b>Mitigated</b>
1	0.0578	0.1005
2	0.0431	0.0916
3	0.0430	0.0792
4	0.0425	0.0702
5	0.0415	0.0647
6	0.0410	0.0629
7	0.0384	0.0604
8	0.0363	0.0553
9	0.0362	0.0529
10	0.0356	0.0475
11	0.0340	0.0465
12	0.0326	0.0455
13	0.0323	0.0454
14	0.0321	0.0445
15	0.0318	0.0445
16	0.0308	0.0444
17	0.0305	0.0440
18	0.0294	0.0426
19	0.0288	0.0417
20	0.0286	0.0410
21	0.0279	0.0409
22	0.0256	0.0409
23	0.0255	0.0408
24	0.0255	0.0404
25	0.0255	0.0403
26	0.0254	0.0393
27	0.0254	0.0391
28	0.0246	0.0385
29	0.0242	0.0379

30	0.0239	0.0379
31	0.0235	0.0378
32	0.0234	0.0376
33	0.0233	0.0375
34	0.0229	0.0374
35	0.0213	0.0369
36	0.0212	0.0366
37	0.0210	0.0365
38	0.0209	0.0358
39	0.0209	0.0349
40	0.0208	0.0349
41	0.0203	0.0345
42	0.0200	0.0343
43	0.0197	0.0342
44	0.0196	0.0333
45	0.0191	0.0332
46	0.0187	0.0332
47	0.0184	0.0328
48	0.0184	0.0327
49	0.0183	0.0327
50	0.0178	0.0324
51	0.0177	0.0316
52	0.0174	0.0315
53	0.0173	0.0314
54	0.0173	0.0313
55	0.0173	0.0313
56	0.0172	0.0313
57	0.0172	0.0310
58	0.0172	0.0306
59	0.0171	0.0305
60	0.0170	0.0304
61	0.0170	0.0301
62	0.0169	0.0300
63	0.0167	0.0298
64	0.0165	0.0298
65	0.0163	0.0296
66	0.0162	0.0296
67	0.0162	0.0295
68	0.0161	0.0295
69	0.0161	0.0293
70	0.0156	0.0288
71	0.0156	0.0287
72	0.0156	0.0287
73	0.0156	0.0285
74	0.0155	0.0283
75	0.0154	0.0283
76	0.0153	0.0280
77	0.0152	0.0280
78	0.0152	0.0280
79	0.0151	0.0279
80	0.0150	0.0278
81	0.0148	0.0276
82	0.0147	0.0276
83	0.0146	0.0275
84	0.0145	0.0274
85	0.0143	0.0270
86	0.0139	0.0269
87	0.0138	0.0269
88	0.0138	0.0267
89	0.0137	0.0267
90	0.0135	0.0266
91	0.0129	0.0264
92	0.0128	0.0264
93	0.0128	0.0263
94	0.0126	0.0263
95	0.0125	0.0263
96	0.0125	0.0262
97	0.0125	0.0261
98	0.0123	0.0261
99	0.0120	0.0261
100	0.0118	0.0261



101	0.0116	0.0257
102	0.0115	0.0257
103	0.0113	0.0254
104	0.0112	0.0253
105	0.0112	0.0250
106	0.0112	0.0249
107	0.0111	0.0247
108	0.0111	0.0244
109	0.0110	0.0243
110	0.0108	0.0243
111	0.0107	0.0243
112	0.0106	0.0242
113	0.0106	0.0240
114	0.0104	0.0234
115	0.0097	0.0233
116	0.0097	0.0233
117	0.0095	0.0230
118	0.0095	0.0229
119	0.0094	0.0227
120	0.0094	0.0225
121	0.0093	0.0224
122	0.0093	0.0224
123	0.0093	0.0222
124	0.0092	0.0221
125	0.0091	0.0220
126	0.0087	0.0216
127	0.0086	0.0214
128	0.0083	0.0214
129	0.0080	0.0214
130	0.0079	0.0213
131	0.0079	0.0212
132	0.0079	0.0211
133	0.0079	0.0206
134	0.0076	0.0206
135	0.0074	0.0205
136	0.0073	0.0202
137	0.0072	0.0202
138	0.0068	0.0198
139	0.0066	0.0194
140	0.0066	0.0192
141	0.0066	0.0191
142	0.0064	0.0189
143	0.0064	0.0188
144	0.0064	0.0188
145	0.0059	0.0187
146	0.0059	0.0185
147	0.0059	0.0185
148	0.0058	0.0185
149	0.0058	0.0177
150	0.0058	0.0174
151	0.0056	0.0174
152	0.0051	0.0174
153	0.0049	0.0173
154	0.0045	0.0170
155	0.0033	0.0162
156	0.0015	0.0152
157	0.0012	0.0128
158	0.0008	0.0117

---

**Stream Protection Duration**

**POC #2**

**The Facility PASSED**

**The Facility PASSED.**

<b>Flow(cfs)</b>	<b>Predev</b>	<b>Mit</b>	<b>Percentage</b>	<b>Pass/Fail</b>
0.0077	53129	27778	52	Pass
0.0080	49085	25146	51	Pass
0.0082	45478	22742	50	Pass
0.0085	42265	20609	48	Pass

0.0088	39246	18725	47	Pass
0.0091	36470	16964	46	Pass
0.0094	33961	15418	45	Pass
0.0097	31601	13978	44	Pass
0.0100	29384	12803	43	Pass
0.0103	27423	11717	42	Pass
0.0106	25639	10703	41	Pass
0.0108	24027	9789	40	Pass
0.0111	22587	8947	39	Pass
0.0114	21224	8155	38	Pass
0.0117	19933	7512	37	Pass
0.0120	18736	6859	36	Pass
0.0123	17645	6271	35	Pass
0.0126	16559	5778	34	Pass
0.0129	15462	5333	34	Pass
0.0132	14548	4884	33	Pass
0.0135	13667	4505	32	Pass
0.0137	12897	4136	32	Pass
0.0140	12105	3781	31	Pass
0.0143	11396	3476	30	Pass
0.0146	10698	3188	29	Pass
0.0149	10061	2941	29	Pass
0.0152	9457	2751	29	Pass
0.0155	8914	2611	29	Pass
0.0158	8382	2425	28	Pass
0.0161	7889	2295	29	Pass
0.0164	7479	2153	28	Pass
0.0166	7041	2025	28	Pass
0.0169	6615	1909	28	Pass
0.0172	6271	1808	28	Pass
0.0175	5961	1688	28	Pass
0.0178	5695	1585	27	Pass
0.0181	5413	1486	27	Pass
0.0184	5173	1395	26	Pass
0.0187	4900	1293	26	Pass
0.0190	4668	1210	25	Pass
0.0193	4476	1147	25	Pass
0.0195	4303	1085	25	Pass
0.0198	4115	1031	25	Pass
0.0201	3916	988	25	Pass
0.0204	3719	941	25	Pass
0.0207	3532	874	24	Pass
0.0210	3371	834	24	Pass
0.0213	3217	791	24	Pass
0.0216	3096	751	24	Pass
0.0219	2989	706	23	Pass
0.0221	2879	666	23	Pass
0.0224	2757	634	22	Pass
0.0227	2616	601	22	Pass
0.0230	2503	573	22	Pass
0.0233	2398	549	22	Pass
0.0236	2304	523	22	Pass
0.0239	2197	487	22	Pass
0.0242	2076	461	22	Pass
0.0245	1996	437	21	Pass
0.0248	1897	411	21	Pass
0.0250	1809	395	21	Pass
0.0253	1718	368	21	Pass
0.0256	1638	348	21	Pass
0.0259	1585	333	21	Pass
0.0262	1502	316	21	Pass
0.0265	1429	298	20	Pass
0.0268	1358	277	20	Pass
0.0271	1285	261	20	Pass
0.0274	1229	246	20	Pass
0.0277	1174	235	20	Pass
0.0279	1112	224	20	Pass
0.0282	1066	213	19	Pass
0.0285	1017	205	20	Pass
0.0288	973	196	20	Pass
0.0291	929	192	20	Pass

0.0294	877	186	21	Pass
0.0297	817	179	21	Pass
0.0300	779	166	21	Pass
0.0303	736	160	21	Pass
0.0306	689	153	22	Pass
0.0308	635	148	23	Pass
0.0311	594	140	23	Pass
0.0314	551	131	23	Pass
0.0317	511	128	25	Pass
0.0320	472	125	26	Pass
0.0323	424	121	28	Pass
0.0326	392	116	29	Pass
0.0329	361	109	30	Pass
0.0332	337	105	31	Pass
0.0334	312	100	32	Pass
0.0337	297	99	33	Pass
0.0340	274	99	36	Pass
0.0343	254	97	38	Pass
0.0346	240	93	38	Pass
0.0349	221	90	40	Pass
0.0352	207	88	42	Pass
0.0355	194	87	44	Pass
0.0358	176	83	47	Pass
0.0361	156	78	50	Pass
0.0363	142	76	53	Pass

---

**Perlnd and Implnd Changes**

No changes have been made.

---

This program and accompanying documentation are provided 'as-is' without warranty of any kind. The entire risk regarding the performance and results of this program is assumed by End User. Clear Creek Solutions Inc. and the governmental licensee or sublicensees disclaim all warranties, either expressed or implied, including but not limited to implied warranties of program and accompanying documentation. In no event shall Clear Creek Solutions Inc. be liable for any damages whatsoever (including without limitation to damages for loss of business profits, loss of business information, business interruption, and the like) arising out of the use of, or inability to use this program even if Clear Creek Solutions Inc. or their authorized representatives have been advised of the possibility of such damages. Software Copyright © by : Clear Creek Solutions, Inc. 2005-2025; All Rights Reserved.

I:\COMMUNICATION\TENTON\07 CHAMBERMAXX\40 STANDARD DRAWINGS\CHAMBERMAXX\CCP-CM-STANDARD DETAIL\_2.DWG 10/21/2016 8:28 AM

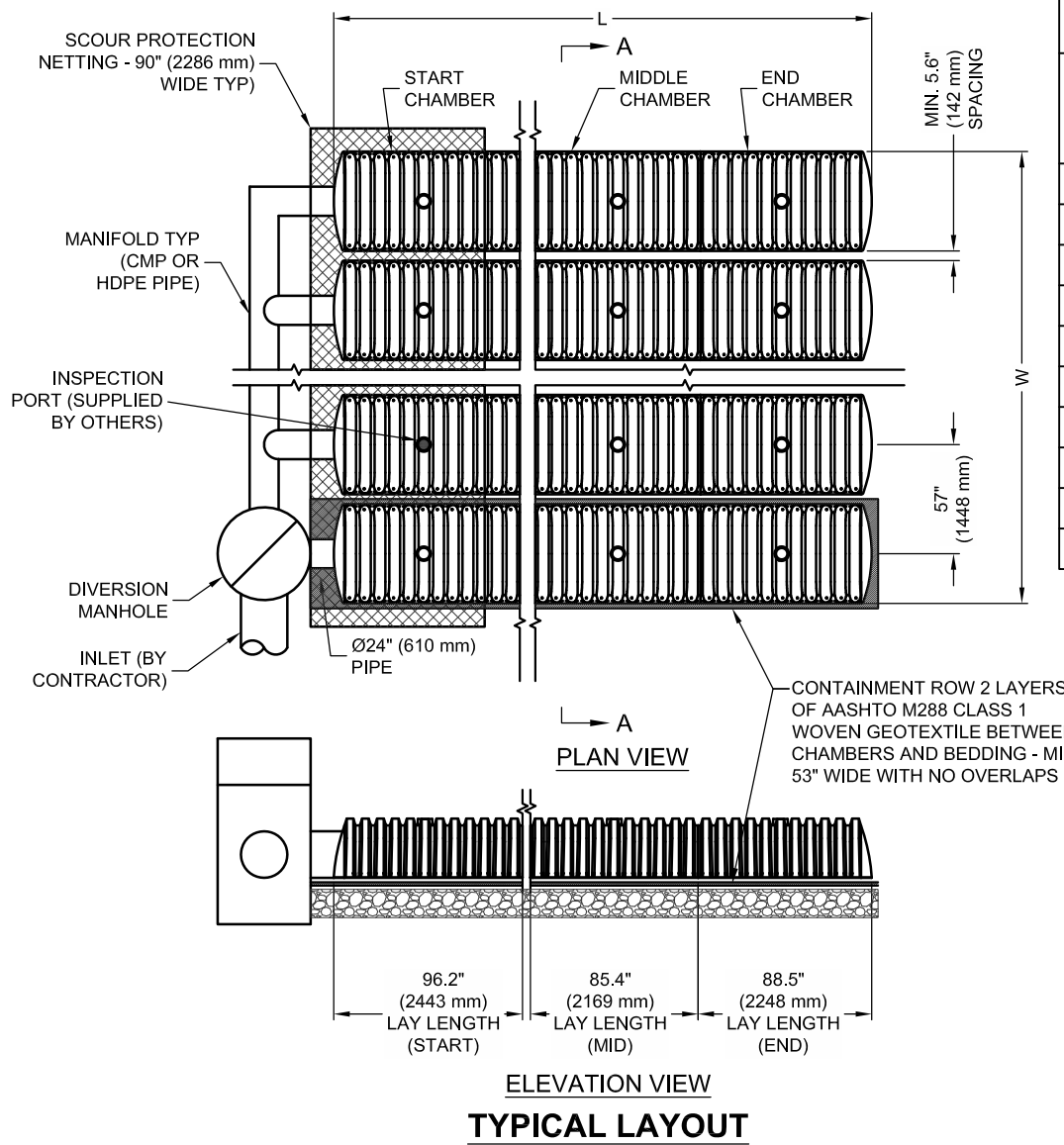

CHAMBERMAXX DESIGN DETAILS			
FEATURE	START CHAMBER	MIDDLE CHAMBER	END CHAMBER
OVERALL CHAMBER HEIGHT - IN (mm)	30.3 (770)	30.3 (770)	30.3 (770)
OVERALL CHAMBER WIDTH - IN (mm)	51.4 (1306)	51.4 (1306)	51.4 (1306)
ACTUAL LENGTH - IN (mm)	98.4 (2500)	91.0 (2311)	92.0 (2337)
INSTALLED LAY LENGTHS - IN (mm)	96.2 (2443)	85.4 (2169)	88.5 (2248)
CHAMBER STORAGE VOLUME - CF (m³)	50.2 (1.421)	47.2 (1.336)	46.2 (1.307)
CHAMBER STORAGE PER LINEAR FOOT - CF/LF (m³/m)	6.3 (0.582)	6.6 (0.616)	6.3 (0.582)
*INSTALLED CHAMBER VOLUME - CF (m³)	78.1 (2.211)	75.1 (2.127)	74.1 (2.098)
*INSTALLED CHAMBER VOLUME PER LINEAR FOOT - CF/LF (m³/m)	9.7 (0.905)	10.6 (0.981)	10.0 (0.934)
CHAMBER WEIGHT - LB (kg)	83 (37.65)	73 (33.11)	76 (34.47)
*6" (152 mm) OF STONE ABOVE AND BELOW CHAMBER, 5.6" (142 mm) CHAMBER SPACING AND 40% POROSITY			

* SITE SPECIFIC DATA REQUIREMENTS	
FOR DETAILED DESIGN ASSISTANCE REFERENCE CHAMBERMAXX DYODS (DESIGN YOUR OWN DETENTION SYSTEM) SOFTWARE AND CHAMBERMAXX STAGE STORAGE CALCULATOR @ WWW.CONTECHSTORMWATER.COM	
TOTAL REQUIRED STORAGE VOLUME (CF OR m³)	
DEPTH TO INVERT BELOW ASPHALT (FT OR m)	
LIMITING WIDTH (FT OR m)	
LIMITING LENGTH (FT OR m)	
POROUS STONE ABOVE CHAMBER (IN OR mm)	
POROUS STONE BELOW CHAMBER (IN OR mm)	
STONE POROSITY (0 TO 40%)	
MANIFOLD SYSTEM DIAMETER (IN OR mm)	
* PER ENGINEER OF RECORD	

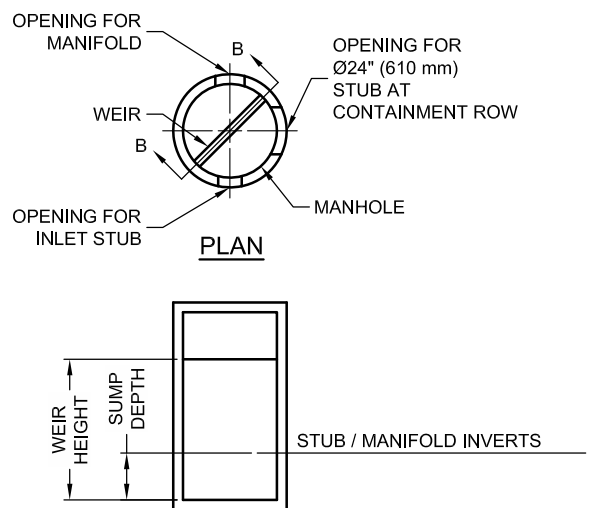

**GENERAL NOTES**

1. ALL ELEVATIONS, DIMENSIONS AND LOCATIONS OF RISERS AND INLETS SHALL BE VERIFIED BY THE ENGINEER OF RECORD.
2. PRIOR TO INSTALLATION OF THE CHAMBERMAXX SYSTEM A PRE-CONSTRUCTION MEETING SHALL BE CONDUCTED. THOSE REQUIRED TO ATTEND ARE THE SUPPLIER OF THE SYSTEM, THE GENERAL CONTRACTOR, SUB-CONTRACTORS AND THE ENGINEER.
3. CHAMBERMAXX CHAMBERS ARE MANUFACTURED FROM POLYPROPYLENE PLASTIC.
4. CHAMBERMAXX SYSTEM TO MEET AASHTO HS20/HS25 LIVE LOADING, PER AASHTO LRFD SECTION 12.
5. ACCESS COVERS TO MEET AASHTO HS20/HS25 LIVE LOADING.
6. MINIMUM COVER IS 18-INCHES (457 mm) AND MAXIMUM COVER IS 96-INCHES (2438 mm) TO BOTTOM OF FLEXIBLE PAVEMENT OR TO TOP OF RIGID PAVEMENT. FOR COVER HEIGHTS GREATER THAN 96-INCHES (2438 mm) CONTACT YOUR LOCAL REPRESENTATIVE.
7. ALL PARTS PROVIDED BY CONTECH UNLESS OTHERWISE NOTED.
8. FOR INFORMATION ON PRE-TREATMENT SYSTEMS, REFERENCE CONTECH PRE-TREATMENT SYSTEM STANDARD DETAILS OR CONTACT YOUR LOCAL REPRESENTATIVE.
9. CHAMBERMAXX BY CONTECH ENGINEERED SOLUTIONS, LLC

**INSTALLATION NOTES**

1. CHAMBERMAXX INSTALLATION GUIDE TO BE REVIEWED BY CONTRACTOR PRIOR TO INSTALLATION.
2. PRIOR TO PLACING BEDDING, THE FOUNDATION MUST BE CONSTRUCTED TO A UNIFORM AND STABLE GRADE. IN THE EVENT THAT UNSUITABLE FOUNDATION MATERIALS ARE ENCOUNTERED DURING EXCAVATION, A GEOGRID SHALL BE UTILIZED OR UNSUITABLE MATERIAL SHALL BE REMOVED AND BROUGHT BACK TO GRADE WITH FILL MATERIAL AS APPROVED BY THE ENGINEER OF RECORD. ONCE THE FOUNDATION PREPARATION IS COMPLETE, THE BEDDING MATERIAL CAN BE PLACED.
3. THE SCOUR PROTECTION NETTING TO EXTEND 1'-0" (305 mm) BEYOND OUTSIDE EDGE OF INLET CHAMBERS.
4. COVER ANY OPEN VOID SPACES GREATER THAN 3/4" (19 mm) ON CHAMBERS WITH A NON-WOVEN GEOTEXTILE TO PREVENT INFILTRATION OF BACKFILL MATERIAL.
5. STONE EMBEDMENT MATERIAL SHALL BE INSTALLED TO 95% STANDARD PROCTOR DENSITY AND PLACED IN 6-INCH (152 mm) TO 8-INCH (203 mm) LIFTS SUCH THAT THERE IS NO MORE THAN A TWO LIFT DIFFERENTIAL BETWEEN ANY OF THE CHAMBERS AT ANY TIME. GRANULAR BACKFILL MATERIAL SHALL BE COMPACTED TO 90% SPD. BACKFILLING SHALL BE ADVANCED ALONG THE LENGTH OF THE CHAMBER ROWS AT THE SAME RATE TO AVOID DIFFERENTIAL LOADING AND DISPLACEMENT OF THE CHAMBERS. THE MINIMUM CHAMBER SPACING MUST BE MAINTAINED.
6. REFER TO CHAMBERMAXX INSTALLATION GUIDE FOR TEMPORARY CONSTRUCTION LOADING GUIDELINES.
7. IT IS ALWAYS THE CONTRACTOR'S RESPONSIBILITY TO FOLLOW OSHA GUIDELINES FOR SAFE PRACTICES.
8. GENERAL INSTALLATION METHODS AND MATERIALS TO BE IN ACCORDANCE WITH ASTM D2321.

- KEY**
1. FLEXIBLE PAVEMENT.
  2. GRANULAR ROAD BASE.
  3. ANY SUITABLE NATIVE OR GENERAL BACKFILL, SEE ENGINEER PLANS.
  4. WELL GRADED GRANULAR FILL. AASHTO M145 A1, A2, OR A3. COMPACT TO MIN. 90% STANDARD DENSITY PER AASHTO T99. MAY INCLUDE ROAD BASE.
  5. FREE DRAINING ANGULAR WASHED STONE 3/4" (19 mm) - 2" (51 mm) PARTICLE SIZE. INSTALL TO MIN. 95% STANDARD DENSITY PER AASHTO T99.

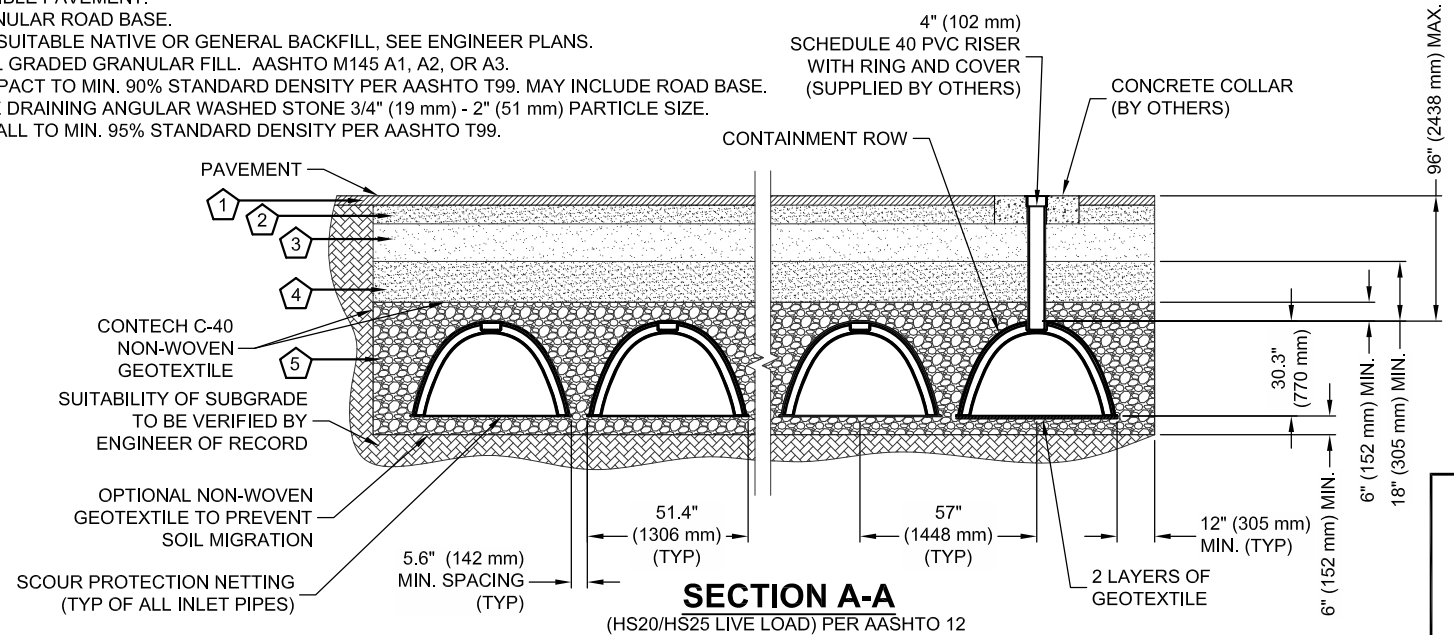

**CHAMBERMaxx®**  
PATENT PENDING

**CONTECH®**  
ENGINEERED SOLUTIONS LLC  
www.ContechES.com  
9025 Centre Pointe Dr., Suite 400, West Chester, OH 45069  
800-338-1122 513-645-7000 513-645-7993 FAX

**CHAMBERMAXX STORMWATER RETENTION  
STANDARD DETAIL  
CONTAINMENT ROW OPTION**

## WATER QUALITY TREATMENT CALCULATIONS

# 43rd Ave. Apartments

## Water Quality Analysis

### Biopod Biofilter Analysis:

#### Onsite:

Water Quality Flow Rate = 0.0578 (Per WWHM calculations)

Per Oldcastle Infrastructure Typical Detail, the maximum treatment flow for a BPU-48IB BioPod Biofilter vault is 0.085 cfs

Therefore the BPU-48IB should be adequate

#### Offsite Frontage:

No. of cartridges = Water quality flow rate/Cartridge flow rate

Where: Water quality flow rate as estimated by WWHM (cfs) = 0.0137

Cartridge flow rate for 18" cart. (gpm/cart.) = 7.5

No. of cartridges = 0.82

Therefore a 1-cartridge StormFilter catch basin should be adequate

WWHM2012  
PROJECT REPORT

---

Project Name: 35043-01-WQ  
Site Name: 43rd MF  
Site Address:  
City :  
Report Date: 5/2/2025  
Gage : 38 IN CENTRAL  
Data Start : 10/01/1901  
Data End : 09/30/2059  
Precip Scale: 1.00  
Version Date: 2021/08/18  
Version : 4.2.18

---

Low Flow Threshold for POC 1 : 50 Percent of the 2 Year

---

High Flow Threshold for POC 1: 50 year

---

Low Flow Threshold for POC 2 : 50 Percent of the 2 Year

---

High Flow Threshold for POC 2: 50 year

---

PREDEVELOPED LAND USE

Name : TDA NW  
Bypass: No

GroundWater: No

<u>Pervious Land Use</u>	<u>acre</u>
C, Forest, Mod	1.284

Pervious Total	1.284
----------------	-------

<u>Impervious Land Use</u>	<u>acre</u>
----------------------------	-------------

Impervious Total	0
------------------	---

Basin Total	1.284
-------------	-------

---

Element Flows To:		
Surface	Interflow	Groundwater

---

Name : TDA SE  
Bypass: No

GroundWater: No

<u>Pervious Land Use</u>	<u>acre</u>
C, Forest, Mod	0.208

Pervious Total	0.208
----------------	-------

<u>Impervious Land Use</u>	<u>acre</u>
----------------------------	-------------

Impervious Total	0
------------------	---

Basin Total	0.208
-------------	-------

---

Element Flows To:

Surface	Interflow	Groundwater
---------	-----------	-------------

---

MITIGATED LAND USE

Name : TDA NW  
 Bypass: No

GroundWater: No

<u>Pervious Land Use</u>	<u>acre</u>
C, Pasture, Flat	0.282
<b>Pervious Total</b>	<b>0.282</b>
<u>Impervious Land Use</u>	<u>acre</u>
ROADS MOD	0.641
<b>Impervious Total</b>	<b>0.641</b>
<b>Basin Total</b>	<b>0.923</b>

---

Element Flows To:		
Surface	Interflow	Groundwater

---

Name : TDA SE  
 Bypass: No

GroundWater: No

<u>Pervious Land Use</u>	<u>acre</u>
C, Pasture, Mod	.056
<b>Pervious Total</b>	<b>0.056</b>
<u>Impervious Land Use</u>	<u>acre</u>
ROADS MOD	0.152
<b>Impervious Total</b>	<b>0.152</b>
<b>Basin Total</b>	<b>0.208</b>

---

Element Flows To:		
Surface	Interflow	Groundwater

---

ANALYSIS RESULTS

Stream Protection Duration

---

Predeveloped Landuse Totals for POC #1  
 Total Pervious Area:1.284  
 Total Impervious Area:0

---

Mitigated Landuse Totals for POC #1  
 Total Pervious Area:0.282  
 Total Impervious Area:0.641

---

Flow Frequency Return Periods for Predeveloped. POC #1

<u>Return Period</u>	<u>Flow(cfs)</u>
2 year	0.027322
5 year	0.042736
10 year	0.051142
25 year	0.059714



50 year 0.064817  
 100 year 0.069017

**Flow Frequency Return Periods for Mitigated. POC #1**

<u>Return Period</u>	<u>Flow(cfs)</u>
2 year	0.253447
5 year	0.347153
10 year	0.417759
25 year	0.517263
50 year	0.599242
100 year	0.688281

---

**Stream Protection Duration**

**Annual Peaks for Predeveloped and Mitigated. POC #1**

<u>Year</u>	<u>Predeveloped</u>	<u>Mitigated</u>
1902	0.020	0.287
1903	0.017	0.314
1904	0.032	0.370
1905	0.013	0.173
1906	0.006	0.196
1907	0.041	0.238
1908	0.031	0.195
1909	0.030	0.242
1910	0.042	0.244
1911	0.027	0.263
1912	0.103	0.492
1913	0.043	0.239
1914	0.011	0.920
1915	0.017	0.161
1916	0.027	0.320
1917	0.009	0.139
1918	0.029	0.241
1919	0.021	0.159
1920	0.027	0.227
1921	0.031	0.173
1922	0.031	0.283
1923	0.025	0.187
1924	0.011	0.343
1925	0.014	0.148
1926	0.027	0.275
1927	0.017	0.251
1928	0.021	0.169
1929	0.044	0.338
1930	0.028	0.374
1931	0.026	0.184
1932	0.020	0.203
1933	0.019	0.192
1934	0.057	0.301
1935	0.026	0.160
1936	0.023	0.232
1937	0.038	0.353
1938	0.022	0.175
1939	0.001	0.202
1940	0.025	0.407
1941	0.012	0.406
1942	0.037	0.269
1943	0.019	0.256
1944	0.037	0.390
1945	0.031	0.275
1946	0.019	0.255
1947	0.011	0.173
1948	0.058	0.235
1949	0.050	0.360
1950	0.014	0.239
1951	0.017	0.426
1952	0.077	0.396
1953	0.069	0.330
1954	0.025	0.195
1955	0.020	0.247
1956	0.010	0.210

1957	0.035	0.193
1958	0.073	0.284
1959	0.045	0.284
1960	0.012	0.210
1961	0.045	0.592
1962	0.024	0.254
1963	0.012	0.172
1964	0.013	0.642
1965	0.051	0.271
1966	0.014	0.185
1967	0.022	0.277
1968	0.022	0.244
1969	0.022	0.197
1970	0.035	0.239
1971	0.055	0.224
1972	0.036	0.838
1973	0.045	0.435
1974	0.026	0.303
1975	0.058	0.315
1976	0.031	0.339
1977	0.010	0.159
1978	0.051	0.260
1979	0.014	0.256
1980	0.029	0.287
1981	0.028	0.273
1982	0.011	0.206
1983	0.046	0.267
1984	0.019	0.260
1985	0.030	0.342
1986	0.027	0.170
1987	0.053	0.280
1988	0.033	0.158
1989	0.029	0.178
1990	0.033	0.212
1991	0.026	0.369
1992	0.037	0.375
1993	0.036	0.300
1994	0.054	0.221
1995	0.010	0.169
1996	0.061	0.239
1997	0.023	0.212
1998	0.027	0.242
1999	0.002	0.313
2000	0.021	0.222
2001	0.011	0.235
2002	0.043	0.343
2003	0.033	0.259
2004	0.031	0.297
2005	0.065	0.725
2006	0.017	0.263
2007	0.017	0.299
2008	0.029	0.245
2009	0.020	0.189
2010	0.017	0.241
2011	0.014	0.259
2012	0.020	0.221
2013	0.015	0.231
2014	0.011	0.239
2015	0.022	0.371
2016	0.009	0.270
2017	0.042	0.335
2018	0.077	0.269
2019	0.074	0.339
2020	0.023	0.251
2021	0.038	0.213
2022	0.016	0.358
2023	0.032	0.484
2024	0.076	0.563
2025	0.028	0.271
2026	0.045	0.416
2027	0.016	0.299

2028	0.014	0.107
2029	0.031	0.181
2030	0.057	0.382
2031	0.019	0.117
2032	0.010	0.223
2033	0.017	0.253
2034	0.016	0.188
2035	0.065	0.244
2036	0.034	0.205
2037	0.008	0.328
2038	0.029	0.248
2039	0.003	0.553
2040	0.015	0.204
2041	0.020	0.242
2042	0.064	0.284
2043	0.030	0.316
2044	0.041	0.219
2045	0.028	0.170
2046	0.033	0.207
2047	0.024	0.228
2048	0.031	0.195
2049	0.028	0.289
2050	0.020	0.222
2051	0.029	0.302
2052	0.017	0.278
2053	0.030	0.202
2054	0.038	0.414
2055	0.012	0.256
2056	0.013	0.347
2057	0.020	0.156
2058	0.026	0.370
2059	0.046	0.407

---

**Stream Protection Duration**

**Ranked Annual Peaks for Predeveloped and Mitigated. POC #1**

<b>Rank</b>	<b>Predeveloped</b>	<b>Mitigated</b>
1	0.1031	0.9201
2	0.0768	0.8381
3	0.0767	0.7251
4	0.0758	0.6415
5	0.0739	0.5924
6	0.0732	0.5630
7	0.0686	0.5533
8	0.0647	0.4924
9	0.0645	0.4842
10	0.0635	0.4353
11	0.0607	0.4257
12	0.0582	0.4160
13	0.0575	0.4135
14	0.0572	0.4075
15	0.0567	0.4074
16	0.0549	0.4064
17	0.0543	0.3962
18	0.0525	0.3900
19	0.0513	0.3816
20	0.0509	0.3748
21	0.0498	0.3738
22	0.0457	0.3712
23	0.0455	0.3704
24	0.0455	0.3698
25	0.0455	0.3686
26	0.0454	0.3601
27	0.0453	0.3584
28	0.0439	0.3528
29	0.0431	0.3468
30	0.0426	0.3434
31	0.0419	0.3426
32	0.0417	0.3425
33	0.0415	0.3394
34	0.0409	0.3389

35	0.0379	0.3377
36	0.0379	0.3353
37	0.0375	0.3297
38	0.0373	0.3279
39	0.0372	0.3197
40	0.0371	0.3156
41	0.0362	0.3151
42	0.0356	0.3142
43	0.0350	0.3129
44	0.0349	0.3033
45	0.0340	0.3025
46	0.0333	0.3006
47	0.0328	0.3004
48	0.0327	0.2993
49	0.0326	0.2989
50	0.0317	0.2967
51	0.0316	0.2890
52	0.0311	0.2869
53	0.0309	0.2865
54	0.0308	0.2842
55	0.0308	0.2840
56	0.0308	0.2837
57	0.0307	0.2834
58	0.0307	0.2804
59	0.0305	0.2783
60	0.0304	0.2771
61	0.0303	0.2752
62	0.0302	0.2751
63	0.0298	0.2732
64	0.0294	0.2712
65	0.0291	0.2709
66	0.0290	0.2699
67	0.0289	0.2688
68	0.0287	0.2686
69	0.0286	0.2672
70	0.0279	0.2632
71	0.0278	0.2629
72	0.0278	0.2599
73	0.0278	0.2595
74	0.0276	0.2594
75	0.0275	0.2589
76	0.0273	0.2559
77	0.0271	0.2559
78	0.0271	0.2556
79	0.0270	0.2545
80	0.0268	0.2541
81	0.0265	0.2528
82	0.0263	0.2514
83	0.0261	0.2513
84	0.0259	0.2483
85	0.0255	0.2475
86	0.0248	0.2449
87	0.0247	0.2442
88	0.0246	0.2440
89	0.0244	0.2439
90	0.0240	0.2421
91	0.0230	0.2420
92	0.0229	0.2419
93	0.0228	0.2413
94	0.0224	0.2410
95	0.0223	0.2391
96	0.0223	0.2391
97	0.0222	0.2391
98	0.0219	0.2390
99	0.0214	0.2389
100	0.0210	0.2379
101	0.0206	0.2353
102	0.0205	0.2351
103	0.0202	0.2318
104	0.0200	0.2312
105	0.0200	0.2279

106	0.0199	0.2272
107	0.0198	0.2241
108	0.0197	0.2229
109	0.0197	0.2223
110	0.0193	0.2222
111	0.0191	0.2213
112	0.0189	0.2206
113	0.0189	0.2192
114	0.0185	0.2130
115	0.0174	0.2121
116	0.0174	0.2120
117	0.0170	0.2105
118	0.0169	0.2100
119	0.0168	0.2072
120	0.0168	0.2059
121	0.0167	0.2048
122	0.0165	0.2042
123	0.0165	0.2026
124	0.0164	0.2022
125	0.0163	0.2016
126	0.0155	0.1969
127	0.0154	0.1955
128	0.0149	0.1954
129	0.0143	0.1953
130	0.0142	0.1952
131	0.0141	0.1933
132	0.0141	0.1917
133	0.0141	0.1890
134	0.0136	0.1876
135	0.0132	0.1872
136	0.0130	0.1848
137	0.0129	0.1839
138	0.0120	0.1806
139	0.0117	0.1776
140	0.0117	0.1753
141	0.0117	0.1734
142	0.0114	0.1727
143	0.0114	0.1725
144	0.0113	0.1723
145	0.0106	0.1701
146	0.0106	0.1696
147	0.0105	0.1688
148	0.0104	0.1685
149	0.0103	0.1615
150	0.0103	0.1596
151	0.0099	0.1590
152	0.0090	0.1588
153	0.0087	0.1581
154	0.0080	0.1555
155	0.0058	0.1480
156	0.0027	0.1390
157	0.0022	0.1172
158	0.0014	0.1074

---

**Water Quality BMP Flow and Volume for POC #1**  
**On-line facility volume:** 0.0744 acre-feet  
**On-line facility target flow:** 0.1003 cfs.  
**Adjusted for 15 min:** 0.1003 cfs.  
**Off-line facility target flow:** 0.0578 cfs.  
**Adjusted for 15 min:** 0.0578 cfs.

---

**Stream Protection Duration**

---

**Predeveloped Landuse Totals for POC #2**  
**Total Pervious Area:**0.208  
**Total Impervious Area:**0

---

Mitigated Landuse Totals for POC #2  
Total Pervious Area:0.056  
Total Impervious Area:0.152

---

Flow Frequency Return Periods for Predeveloped. POC #2

<u>Return Period</u>	<u>Flow(cfs)</u>
2 year	0.004426
5 year	0.006923
10 year	0.008285
25 year	0.009673
50 year	0.0105
100 year	0.01118

Flow Frequency Return Periods for Mitigated. POC #2

<u>Return Period</u>	<u>Flow(cfs)</u>
2 year	0.060053
5 year	0.082298
10 year	0.099066
25 year	0.122706
50 year	0.142187
100 year	0.163351

---

Stream Protection Duration

Annual Peaks for Predeveloped and Mitigated. POC #2

<u>Year</u>	<u>Predeveloped</u>	<u>Mitigated</u>
1902	0.003	0.068
1903	0.003	0.074
1904	0.005	0.088
1905	0.002	0.041
1906	0.001	0.046
1907	0.007	0.056
1908	0.005	0.046
1909	0.005	0.057
1910	0.007	0.058
1911	0.004	0.062
1912	0.017	0.117
1913	0.007	0.057
1914	0.002	0.218
1915	0.003	0.038
1916	0.004	0.076
1917	0.001	0.033
1918	0.005	0.057
1919	0.003	0.038
1920	0.004	0.054
1921	0.005	0.041
1922	0.005	0.067
1923	0.004	0.044
1924	0.002	0.081
1925	0.002	0.035
1926	0.004	0.065
1927	0.003	0.060
1928	0.003	0.040
1929	0.007	0.080
1930	0.004	0.089
1931	0.004	0.044
1932	0.003	0.048
1933	0.003	0.045
1934	0.009	0.071
1935	0.004	0.038
1936	0.004	0.055
1937	0.006	0.084
1938	0.004	0.041
1939	0.000	0.048
1940	0.004	0.097
1941	0.002	0.096
1942	0.006	0.064
1943	0.003	0.061
1944	0.006	0.092

1945	0.005	0.065
1946	0.003	0.060
1947	0.002	0.041
1948	0.009	0.056
1949	0.008	0.085
1950	0.002	0.057
1951	0.003	0.101
1952	0.012	0.094
1953	0.011	0.078
1954	0.004	0.046
1955	0.003	0.059
1956	0.002	0.050
1957	0.006	0.046
1958	0.012	0.067
1959	0.007	0.067
1960	0.002	0.050
1961	0.007	0.140
1962	0.004	0.060
1963	0.002	0.041
1964	0.002	0.152
1965	0.008	0.064
1966	0.002	0.044
1967	0.004	0.066
1968	0.004	0.058
1969	0.004	0.047
1970	0.006	0.057
1971	0.009	0.053
1972	0.006	0.199
1973	0.007	0.103
1974	0.004	0.072
1975	0.009	0.074
1976	0.005	0.080
1977	0.002	0.038
1978	0.008	0.061
1979	0.002	0.061
1980	0.005	0.068
1981	0.005	0.065
1982	0.002	0.049
1983	0.007	0.063
1984	0.003	0.061
1985	0.005	0.081
1986	0.004	0.040
1987	0.009	0.066
1988	0.005	0.037
1989	0.005	0.042
1990	0.005	0.050
1991	0.004	0.087
1992	0.006	0.089
1993	0.006	0.071
1994	0.009	0.052
1995	0.002	0.040
1996	0.010	0.057
1997	0.004	0.050
1998	0.004	0.057
1999	0.000	0.074
2000	0.003	0.053
2001	0.002	0.056
2002	0.007	0.081
2003	0.005	0.061
2004	0.005	0.070
2005	0.010	0.172
2006	0.003	0.062
2007	0.003	0.071
2008	0.005	0.058
2009	0.003	0.045
2010	0.003	0.057
2011	0.002	0.062
2012	0.003	0.052
2013	0.002	0.055
2014	0.002	0.057
2015	0.004	0.088

2016	0.001	0.064
2017	0.007	0.079
2018	0.012	0.063
2019	0.012	0.080
2020	0.004	0.060
2021	0.006	0.050
2022	0.003	0.085
2023	0.005	0.115
2024	0.012	0.134
2025	0.005	0.064
2026	0.007	0.099
2027	0.003	0.071
2028	0.002	0.025
2029	0.005	0.043
2030	0.009	0.090
2031	0.003	0.028
2032	0.002	0.053
2033	0.003	0.060
2034	0.003	0.044
2035	0.010	0.057
2036	0.006	0.049
2037	0.001	0.078
2038	0.005	0.059
2039	0.000	0.131
2040	0.002	0.048
2041	0.003	0.057
2042	0.010	0.067
2043	0.005	0.075
2044	0.007	0.052
2045	0.005	0.040
2046	0.005	0.049
2047	0.004	0.054
2048	0.005	0.046
2049	0.005	0.069
2050	0.003	0.053
2051	0.005	0.072
2052	0.003	0.066
2053	0.005	0.048
2054	0.006	0.098
2055	0.002	0.061
2056	0.002	0.082
2057	0.003	0.037
2058	0.004	0.088
2059	0.007	0.097

---

**Stream Protection Duration**

**Ranked Annual Peaks for Predeveloped and Mitigated. POC #2**

<b>Rank</b>	<b>Predeveloped</b>	<b>Mitigated</b>
1	0.0167	0.2182
2	0.0124	0.1988
3	0.0124	0.1720
4	0.0123	0.1522
5	0.0120	0.1405
6	0.0119	0.1343
7	0.0111	0.1312
8	0.0105	0.1173
9	0.0105	0.1148
10	0.0103	0.1032
11	0.0098	0.1010
12	0.0094	0.0986
13	0.0093	0.0982
14	0.0093	0.0966
15	0.0092	0.0966
16	0.0089	0.0964
17	0.0088	0.0939
18	0.0085	0.0925
19	0.0083	0.0905
20	0.0083	0.0889
21	0.0081	0.0886
22	0.0074	0.0883



23	0.0074	0.0878
24	0.0074	0.0877
25	0.0074	0.0874
26	0.0074	0.0854
27	0.0073	0.0850
28	0.0071	0.0837
29	0.0070	0.0822
30	0.0069	0.0814
31	0.0068	0.0814
32	0.0067	0.0813
33	0.0067	0.0805
34	0.0066	0.0801
35	0.0061	0.0798
36	0.0061	0.0795
37	0.0061	0.0780
38	0.0060	0.0778
39	0.0060	0.0758
40	0.0060	0.0748
41	0.0059	0.0745
42	0.0058	0.0745
43	0.0057	0.0742
44	0.0057	0.0719
45	0.0055	0.0715
46	0.0054	0.0712
47	0.0053	0.0711
48	0.0053	0.0710
49	0.0053	0.0709
50	0.0051	0.0703
51	0.0051	0.0685
52	0.0050	0.0680
53	0.0050	0.0680
54	0.0050	0.0674
55	0.0050	0.0673
56	0.0050	0.0672
57	0.0050	0.0671
58	0.0050	0.0665
59	0.0049	0.0660
60	0.0049	0.0658
61	0.0049	0.0653
62	0.0049	0.0652
63	0.0048	0.0648
64	0.0048	0.0643
65	0.0047	0.0642
66	0.0047	0.0640
67	0.0047	0.0636
68	0.0047	0.0634
69	0.0046	0.0633
70	0.0045	0.0624
71	0.0045	0.0623
72	0.0045	0.0615
73	0.0045	0.0615
74	0.0045	0.0614
75	0.0045	0.0614
76	0.0044	0.0607
77	0.0044	0.0607
78	0.0044	0.0606
79	0.0044	0.0603
80	0.0043	0.0603
81	0.0043	0.0599
82	0.0043	0.0596
83	0.0042	0.0595
84	0.0042	0.0587
85	0.0041	0.0587
86	0.0040	0.0581
87	0.0040	0.0579
88	0.0040	0.0576
89	0.0040	0.0574
90	0.0039	0.0574
91	0.0037	0.0573
92	0.0037	0.0572
93	0.0037	0.0572

94	0.0036	0.0571
95	0.0036	0.0567
96	0.0036	0.0567
97	0.0036	0.0567
98	0.0036	0.0567
99	0.0035	0.0566
100	0.0034	0.0561
101	0.0033	0.0558
102	0.0033	0.0557
103	0.0033	0.0549
104	0.0032	0.0548
105	0.0032	0.0540
106	0.0032	0.0538
107	0.0032	0.0529
108	0.0032	0.0529
109	0.0032	0.0527
110	0.0031	0.0526
111	0.0031	0.0524
112	0.0031	0.0522
113	0.0031	0.0519
114	0.0030	0.0503
115	0.0028	0.0502
116	0.0028	0.0502
117	0.0028	0.0499
118	0.0027	0.0498
119	0.0027	0.0491
120	0.0027	0.0488
121	0.0027	0.0486
122	0.0027	0.0483
123	0.0027	0.0480
124	0.0026	0.0479
125	0.0026	0.0478
126	0.0025	0.0466
127	0.0025	0.0464
128	0.0024	0.0463
129	0.0023	0.0462
130	0.0023	0.0462
131	0.0023	0.0458
132	0.0023	0.0453
133	0.0023	0.0448
134	0.0022	0.0445
135	0.0021	0.0444
136	0.0021	0.0438
137	0.0021	0.0436
138	0.0020	0.0427
139	0.0019	0.0421
140	0.0019	0.0414
141	0.0019	0.0410
142	0.0019	0.0409
143	0.0018	0.0409
144	0.0018	0.0409
145	0.0017	0.0403
146	0.0017	0.0402
147	0.0017	0.0399
148	0.0017	0.0399
149	0.0017	0.0382
150	0.0017	0.0378
151	0.0016	0.0377
152	0.0015	0.0376
153	0.0014	0.0373
154	0.0013	0.0369
155	0.0009	0.0350
156	0.0004	0.0330
157	0.0004	0.0278
158	0.0002	0.0255

---

**Water Quality BMP Flow and Volume for POC #2**  
**On-line facility volume: 0.0174 acre-feet**  
**On-line facility target flow: 0.0238 cfs.**  
**Adjusted for 15 min: 0.0238 cfs.**

**Off-line facility target flow:** 0.0137 cfs.  
**Adjusted for 15 min:** 0.0137 cfs.

---

**Perlnd and Implnd Changes**

No changes have been made.

---

This program and accompanying documentation are provided 'as-is' without warranty of any kind. The entire risk regarding the performance and results of this program is assumed by End User. Clear Creek Solutions Inc. and the governmental licensee or sublicensees disclaim all warranties, either expressed or implied, including but not limited to implied warranties of program and accompanying documentation. In no event shall Clear Creek Solutions Inc. be liable for any damages whatsoever (including without limitation to damages for loss of business profits, loss of business information, business interruption, and the like) arising out of the use of, or inability to use this program even if Clear Creek Solutions Inc. or their authorized representatives have been advised of the possibility of such damages. Software Copyright © by : Clear Creek Solutions, Inc. 2005-2025; All Rights Reserved.

SITE SPECIFIC DATA				
Structure ID	ID			
Treatment Flow Rate (cfs)	-			
Peak Flow Rate (cfs)	-			
Rim Elevation	-			
Top of Vault Elevation	-			
Pipe Data	Pipe Location	Pipe Size	Pipe Type	Invert Elevation
Inlet	-	-	-	-
Outlet	-	-	-	-
Notes:				
PERFORMANCE SPECIFICATIONS				
Treatment Flow Capacities:*				
NJDEP 80% Removal, 75 micron	0.096 cfs			
WA Ecology GULD - Basic, Enhanced & Phosphorus	0.085 cfs			
Bypass Capacity	5.0 cfs			
*Contact Oldcastle for alternative treatment flow capacities.				

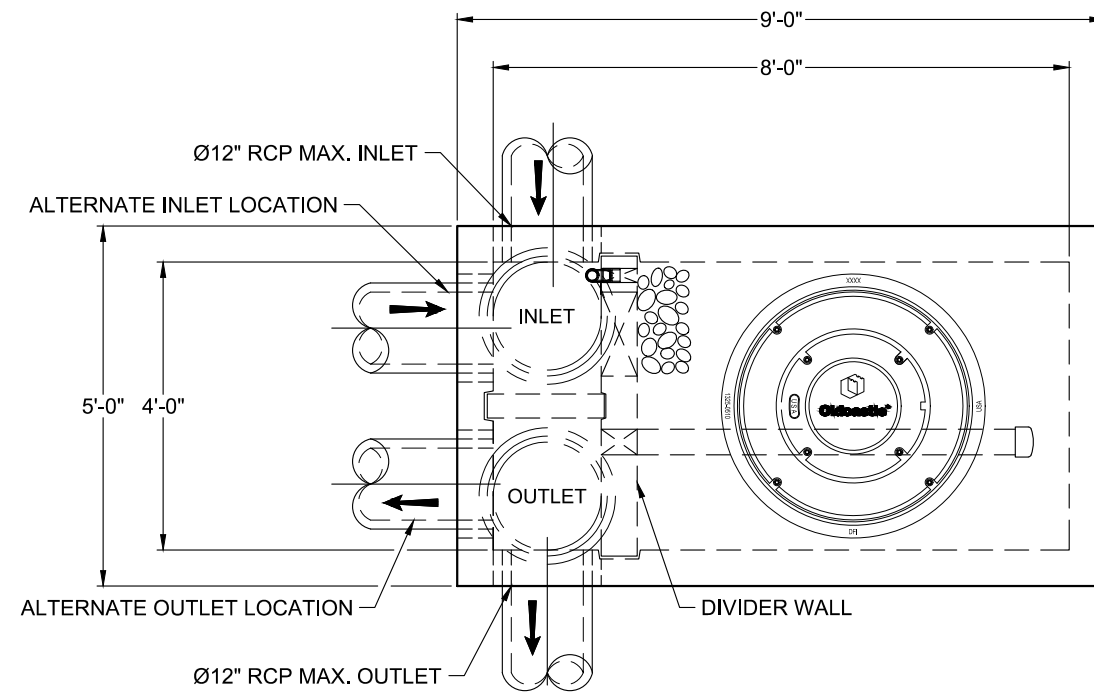

PLAN VIEW

NOTES:

- DESIGN LOADINGS:
  - AASHTO HS-20-44 (WITH IMPACT)
  - DESIGN SOIL COVER: 5'-0" MAXIMUM
  - ASSUMED WATER TABLE: BELOW BASE OF PRECAST (ENGINEER-OF-RECORD TO CONFIRM SITE WATER TABLE ELEVATION)
  - LATERAL EARTH PRESSURE: 45 PCF (DRAINED)
  - LATERAL LIVE LOAD SURCHARGE: 80 PSF (APPLIED TO 8'-0" BELOW GRADE)
  - NO LATERAL SURCHARGE FROM ADJACENT BUILDINGS, WALLS, PIERS, OR FOUNDATIONS.
- CONCRETE 28-DAY MINIMUM COMPRESSIVE STRENGTH: 5,000 PSI MINIMUM.
- REINFORCING: REBAR, ASTM A615/A706, GRADE 60
- CEMENT: ASTM C150
- REQUIRED ALLOWABLE SOIL BEARING CAPACITY: 2,500 PSF
- REFERENCE STANDARD:
  - ASTM C890
  - ASTM C913
  - ACI 318-14
- THIS STRUCTURE IS DESIGNED TO THE PARAMETERS NOTED HEREIN. ENGINEER-OF-RECORD SHALL VERIFY THAT NOTED PARAMETERS MEET OR EXCEED PROJECT REQUIREMENTS. IF DESIGN PARAMETERS ARE INCORRECT, REVIEWING ENGINEER/AUTHORITY SHALL NOTIFY OLDCASTLE INFRASTRUCTURE UPON REVIEW.
- INLET AND OUTLET HOLES WILL BE FACTORY CORED/CAST PER PLANS AND CUSTOMER REQUIREMENTS. INLET AND OUTLET LOCATIONS CAN BE MIRRORED.
- CONTRACTOR RESPONSIBLE TO VERIFY ALL SIZES, LOCATIONS, AND ELEVATIONS OF OPENINGS.
- CONTRACTOR RESPONSIBLE TO ENSURE ADEQUATE BEARING SURFACE IS PROVIDED (I.E. COMPACTED AND LEVEL PER PROJECT SPECIFICATIONS).
- SECTION HEIGHTS, SLAB/WALL THICKNESSES, AND KEYWAYS ARE SUBJECT TO CHANGE AS REQUIRED FOR SITE REQUIREMENTS AND/OR DUE TO PRODUCT AVAILABILITY AND PRODUCTION FACILITY CONSTRAINTS.
- MAXIMUM PICK WEIGHTS\*:
  - TOP: XX,XXX LBS
  - BASE: XX,XXX LBS\* (\* COMBINED WEIGHT OF BASE INCLUDES BYPASS WEIR, DIVIDER WALL, ROCK & MEDIA)
- INTERNALS SHALL CONSIST OF UNDERDRAIN PIPE, ROCK, STORMMIX™ MEDIA, MULCH, DIVIDER WALL, BYPASS WEIR AND OPTIONAL DRAIN DOWN.

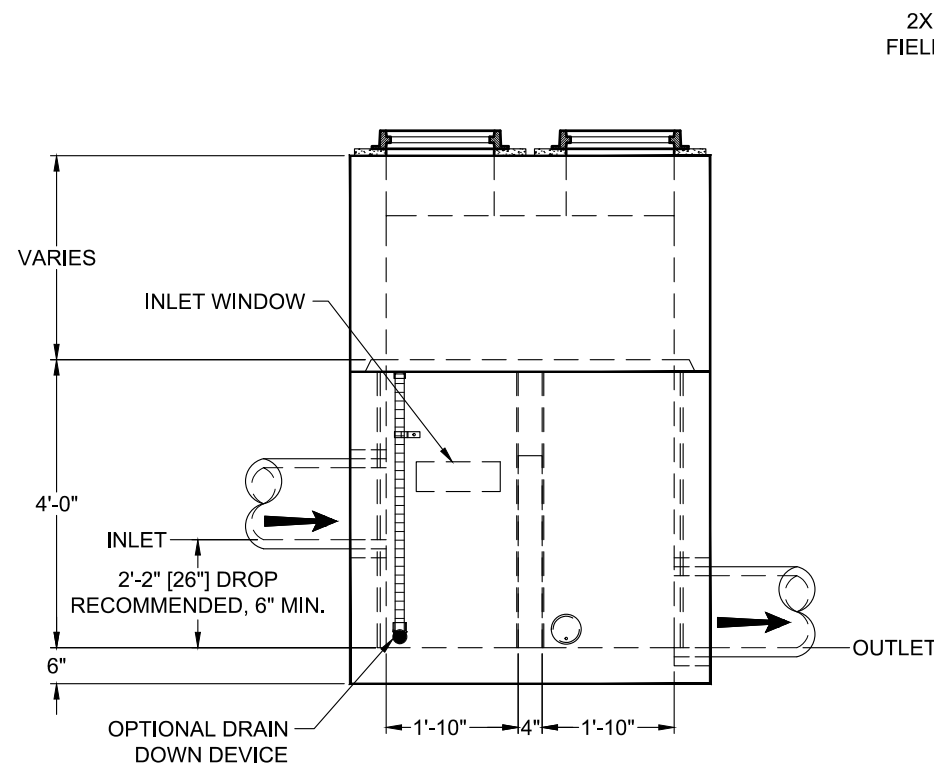

LEFT END VIEW

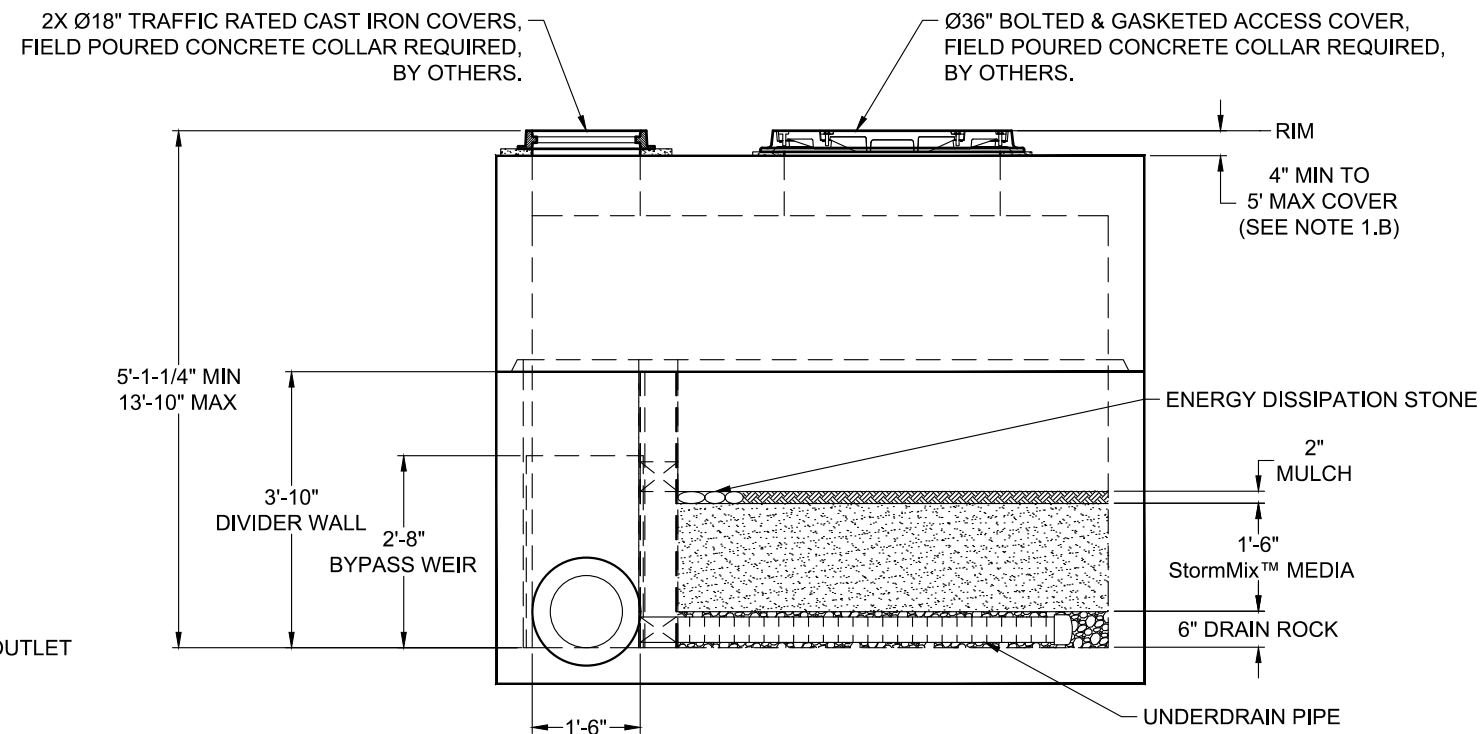

ELEVATION VIEW



**Oldcastle Infrastructure**  
A CRH COMPANY

Ph: 800.579.8819 | www.oldcastleinfrastructure.com/stormwater

THIS DOCUMENT IS THE PROPERTY OF OLDCASTLE INFRASTRUCTURE, INC. IT IS CONFIDENTIAL, SUBMITTED FOR REFERENCE PURPOSES ONLY AND SHALL NOT BE USED IN ANY WAY INJURIOUS TO THE INTERESTS OF, OR WITHOUT THE WRITTEN PERMISSION OF OLDCASTLE INFRASTRUCTURE, INC. COPYRIGHT © 2021 OLDCASTLE INFRASTRUCTURE, INC. ALL RIGHTS RESERVED.

BioPod™ Biofilter System (STANDARD)		
Underground Vault with Internal Bypass		
CUSTOMER	-	
PROJECT NAME	-	
SHEET NAME	REVISION	SHEET
Specifier Drawing BPU-481B	-	1 OF 1
	REV DATE	
	-	

**STORMFILTER STEEL CATCHBASIN DESIGN NOTES**

STORMFILTER TREATMENT CAPACITY IS A FUNCTION OF THE CARTRIDGE SELECTION AND THE NUMBER OF CARTRIDGES. 1 CARTRIDGE CATCHBASIN HAS A MAXIMUM OF ONE CARTRIDGE. SYSTEM IS SHOWN WITH A 27" CARTRIDGE, AND IS ALSO AVAILABLE WITH AN 18" CARTRIDGE. STORMFILTER CATCHBASIN CONFIGURATIONS ARE AVAILABLE WITH A DRY INLET BAY FOR VECTOR CONTROL. PEAK HYDRAULIC CAPACITY PER TABLE BELOW. IF THE SITE CONDITIONS EXCEED PEAK HYDRAULIC CAPACITY, AN UPSTREAM BYPASS STRUCTURE IS REQUIRED.

**CARTRIDGE SELECTION**

CARTRIDGE HEIGHT	27"			18"			18" DEEP		
RECOMMENDED HYDRAULIC DROP (H)	3.05'			2.3'			3.3'		
SPECIFIC FLOW RATE (gpm/sf)	2 gpm/sf	1.67* gpm/sf	1 gpm/sf	2 gpm/sf	1.67* gpm/sf	1 gpm/sf	2 gpm/sf	1.67* gpm/sf	1 gpm/sf
CARTRIDGE FLOW RATE (gpm)	22.5	18.79	11.25	15	12.53	7.5	15	12.53	7.5
PEAK HYDRAULIC CAPACITY	1.0			1.0			2.25		
INLET PERMANENT POOL LEVEL (A)	1'-0"			1'-0"			2'-0"		
OVERALL STRUCTURE HEIGHT (B)	4'-9"			3'-9"			4'-9"		

\* 1.67 gpm/sf SPECIFIC FLOW RATE IS APPROVED WITH PHOSPHOSORB® (PSORB) MEDIA ONLY

**GENERAL NOTES**

- CONTECH TO PROVIDE ALL MATERIALS UNLESS NOTED OTHERWISE.
- FOR SITE SPECIFIC DRAWINGS WITH DETAILED STORMFILTER CATCHBASIN STRUCTURE DIMENSIONS AND WEIGHTS, PLEASE CONTACT YOUR CONTECH ENGINEERED SOLUTIONS LLC REPRESENTATIVE. [www.contechES.com](http://www.contechES.com)
- STORMFILTER CATCHBASIN WATER QUALITY STRUCTURE SHALL BE IN ACCORDANCE WITH ALL DESIGN DATA AND INFORMATION CONTAINED IN THIS DRAWING.
- INLET SHOULD NOT BE LOWER THAN OUTLET. INLET (IF APPLICABLE) AND OUTLET PIPING TO BE SPECIFIED BY ENGINEER AND PROVIDED BY CONTRACTOR.
- MANUFACTURER TO APPLY A SURFACE BEAD WELD IN THE SHAPE OF THE LETTER "O" ABOVE THE OUTLET PIPE STUB ON THE EXTERIOR SURFACE OF THE STEEL SFCB.
- STORMFILTER CATCHBASIN EQUIPPED WITH 4 INCH (APPROXIMATE) LONG STUBS FOR INLET (IF APPLICABLE) AND OUTLET PIPING. STANDARD OUTLET STUB IS 8 INCHES IN DIAMETER. MAXIMUM OUTLET STUB IS 15 INCHES IN DIAMETER. CONNECTION TO COLLECTION PIPING CAN BE MADE USING FLEXIBLE COUPLING BY CONTRACTOR.
- STEEL STRUCTURE TO BE MANUFACTURED OF 1/4 INCH STEEL PLATE. CASTINGS SHALL MEET AASHTO M306 LOAD RATING. TO MEET HS20 LOAD RATING ON STRUCTURE, A CONCRETE COLLAR IS REQUIRED. WHEN REQUIRED, CONCRETE COLLAR WITH #4 REINFORCING BARS TO BE PROVIDED BY CONTRACTOR.
- FILTER CARTRIDGES SHALL BE MEDIA-FILLED, PASSIVE, SIPHON ACTUATED, RADIAL FLOW, AND SELF CLEANING. RADIAL MEDIA DEPTH SHALL BE 7-INCHES. FILTER MEDIA CONTACT TIME SHALL BE AT LEAST 38 SECONDS.
- SPECIFIC FLOW RATE IS EQUAL TO THE FILTER TREATMENT CAPACITY (gpm) DIVIDED BY THE FILTER CONTACT SURFACE AREA (sq ft).

**INSTALLATION NOTES**

- ANY SUB-BASE, BACKFILL DEPTH, AND/OR ANTI-FLOTATION PROVISIONS ARE SITE-SPECIFIC DESIGN CONSIDERATIONS AND SHALL BE SPECIFIED BY ENGINEER OF RECORD.
- CONTRACTOR TO PROVIDE EQUIPMENT WITH SUFFICIENT LIFTING AND REACH CAPACITY TO LIFT AND SET THE CATCHBASIN (LIFTING CLUTCHES PROVIDED).
- CONTRACTOR TO TAKE APPROPRIATE MEASURES TO PROTECT CARTRIDGES FROM CONSTRUCTION-RELATED EROSION RUNOFF.

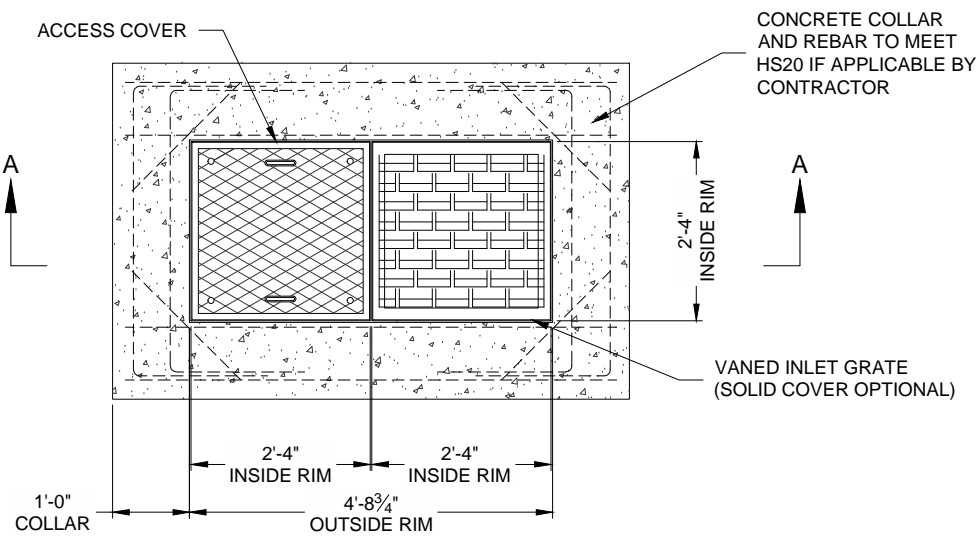

**PLAN VIEW**

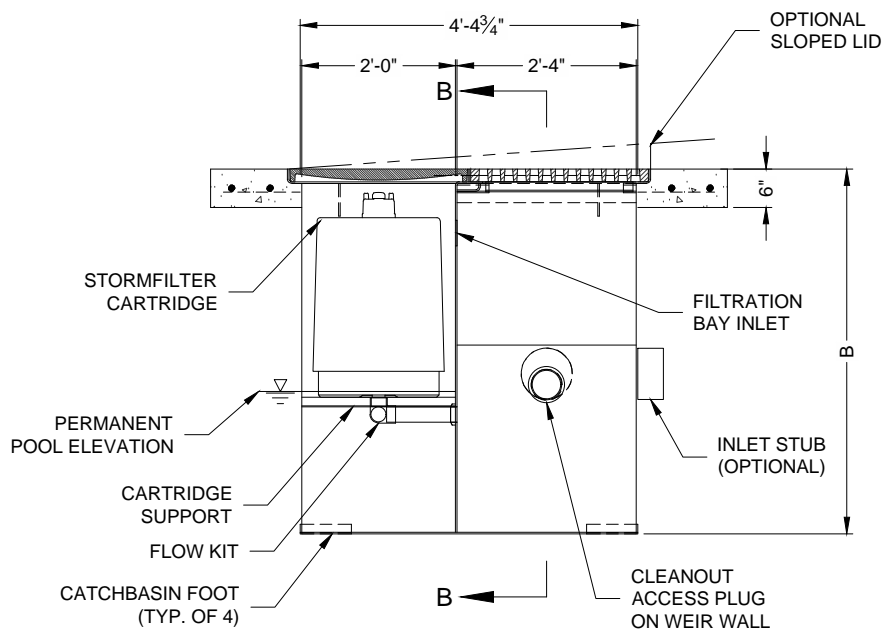

**SECTION A-A**

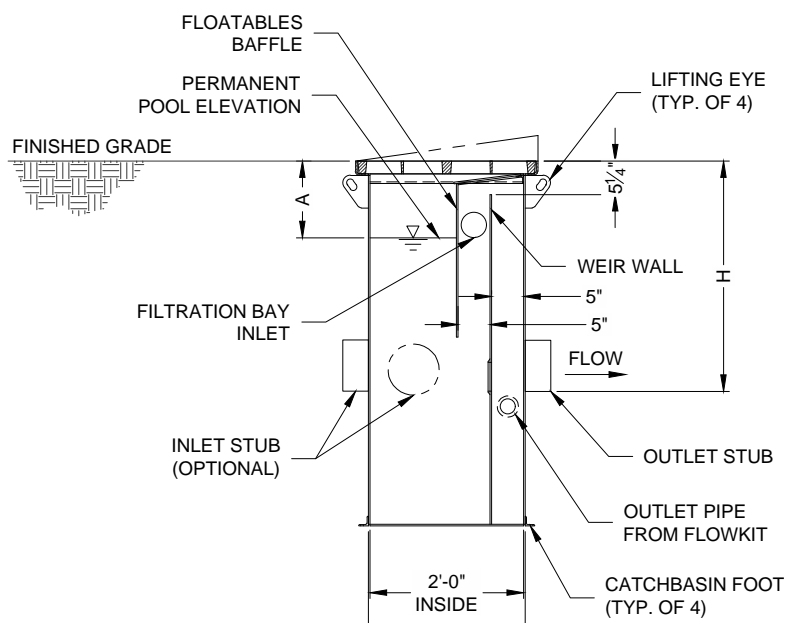

**SECTION B-B**

**1-CARTRIDGE CATCHBASIN STORMFILTER DATA**

STRUCTURE ID	XXX	
WATER QUALITY FLOW RATE (cfs)	X.XX	
PEAK FLOW RATE (<1 cfs)	X.XX	
RETURN PERIOD OF PEAK FLOW (yrs)	XXX	
CARTRIDGE HEIGHT (27", 18", 18" DEEP)	XX	
CARTRIDGE FLOW RATE (gpm)	XX	
MEDIA TYPE (PERLITE, ZPG, PSORB)	XXXXX	
RIM ELEVATION	XXX.XX'	
PIPE DATA:	I.E.	DIAMETER
INLET STUB	XXX.XX'	XX"
OUTLET STUB	XXX.XX'	XX"
CONFIGURATION	OUTLET INLET	OUTLET INLET
SLOPED LID	YES/NO	
SOLID COVER	YES/NO	
NOTES/SPECIAL REQUIREMENTS:		



[www.contechES.com](http://www.contechES.com)  
 9025 Centre Pointe Dr., Suite 400, West Chester, OH 45069  
 800-526-3999 513-645-7000 513-645-7993 FAX

**1 CARTRIDGE CATCHBASIN  
 STORMFILTER  
 STANDARD DETAIL**

CONVEYANCE CALCULATIONS  
(TO BE PROVIDED WITH FUTURE SITE DEVELOPMENT PERMIT)

**APPENDIX D**

**GEOTECHNICAL REPORTS**



1/27/2025

**Homes by Landmark**

Attn: David Litowitz  
P.O. Box 26116  
Federal Way, WA

**c/o: Apex Engineering**

Attn: Gabe Jellison  
2601 S. 35<sup>th</sup> St. Ste. 200  
Tacoma, WA

**Subject: Geotechnical Services Report**

**43<sup>rd</sup> Avenue Apartments Geotechnical Investigation**

7<sup>th</sup> St SW & 43<sup>rd</sup> Ave SW, Puyallup, WA 98465 (GPS:47.151659, -122.30189)

Project Number: QG24-160

Dear Client,

At your request, Quality Geo NW, PLLC (QG) has completed a soils investigation of the above-referenced project. The investigation was performed in accordance with our proposal for professional services.

We would be pleased to continue our role as your geotechnical consultant of record during the project planning and construction phases, as local inspection firms have not been found to be as familiar or reliably experienced with geotechnical design. This may include soil subgrade inspections, periodic review of special inspection reports, or supplemental recommendations if changes occur during construction. We will happily meet with you at your convenience to discuss these and other additional *Time & Materials* services.

We thank you for the opportunity to be of service on this project and trust this report satisfies your project needs currently. QG wishes you the best while completing the project.

Respectfully Submitted,

**Quality Geo NW, PLLC**

Luke Preston McCann, L.E.G.  
Owner + Principal

Ray Gean II  
Staff Geologist/Project Manager



# SOILS REPORT

43<sup>rd</sup> AVENUE APARTMENTS GEOTECHNICAL INVESTIGATION  
7<sup>TH</sup> ST SW & 43<sup>RD</sup> AVE SW  
PUYALLUP, WA

**Homes by Landmark**  
Attn: David Litowitz  
P.O. Box 26116  
Federal Way, WA

**c/o: Apex Engineering**  
Attn: Gabe Jellison  
2601 S. 35<sup>th</sup> St. Ste. 200  
Tacoma, WA

Prepared by:

Approved by:



Corrine Arbelaez  
Staff Geologist



1/27/2025

**LUKE PRESTON MCCANN**

Luke Preston McCann, L.E.G.  
Principal Licensed Engineering Geologist

Quality Geo NW, PLLC  
Geotechnical Investigation & Engineering Consultation  
Phone: 360-878-9705 | Web: [qualitygeonw.com](http://qualitygeonw.com)  
Mail: 4631 Whitman Ln SE, Ste D, Lacey, WA 98513

1/27/2025

QG Project # QG24-160

Copyright © 2025 Quality Geo NW, PLLC

All Rights Reserved



## TABLE OF CONTENTS

1.0	INTRODUCTION.....	4
1.1	PROJECT DESCRIPTION .....	4
1.2	FIELD WORK.....	4
2.0	EXISTING SITE CONDITIONS.....	5
2.1	AREA GEOLOGY .....	5
2.2	SITE & SURFACE CONDITIONS .....	5
2.3	SOIL LOG .....	5
2.4	SURFACE WATER AND GROUNDWATER CONDITIONS .....	6
3.0	GEOTECHNICAL RECOMMENDATIONS .....	7
3.1	SHALLOW FOUNDATION RECOMMENDATIONS .....	7
3.2	LATERAL SOIL & CONCRETE FOUNDATION CONSIDERATIONS.....	8
3.2.1	<b>BUILDING SLAB ON GRADE FLOOR</b> .....	10
3.3	INFILTRATION RATE DETERMINATION .....	11
3.3.1	<b>GRADATION ANALYSIS METHODS &amp; RESULTS</b> .....	11
3.3.2	<b>TREATMENT POTENTIAL</b> .....	12
3.4	DRAINAGE RECOMMENDATIONS.....	12
3.5	EROSION CONTROLS.....	13
4.0	CONSTRUCTION RECOMMENDATIONS .....	15
4.1	EARTHWORK.....	15
4.1.1	<b>GRADING &amp; EXCAVATION</b> .....	15
4.1.2	<b>SUBGRADE EVALUATION &amp; PREPARATION</b> .....	15
4.1.3	<b>SITE PREPARATION, EROSION CONTROLL, WET WEATHER</b> .....	15
4.2	STRUCTURAL FILL MATERIALS AND COMPACTION .....	16
4.2.1	<b>MATERIALS</b> .....	16
4.2.2	<b>FILL PLACEMENT AND COMPACTION</b> .....	17
4.3	TEMPORARY EXCAVATIONS AND TRENCHES .....	17
5.0	SPECIAL INSPECTION .....	19
6.0	LIMITATIONS .....	20
	Appendix A. Region & Vicinity Maps .....	21
	Appendix B. Exploration Map .....	22
	Appendix C. Exploration Logs .....	23
	Appendix D. Laboratory Results.....	28

# 1.0 INTRODUCTION

This report presents the findings and recommendations of Quality Geo NW's (QG) soil investigation conducted in support of new site surface improvements.

## 1.1 PROJECT DESCRIPTION

QG understands the project entails construction of a new apartment structure within a currently undeveloped forested property. QG has been contracted to perform a soils investigation of the proposed site to provide stormwater, foundation, erosion hazard protections and earthwork recommendations.

## 1.2 FIELD WORK

Site exploration activities were performed on 12/16/2024. Exploration locations were marked in the field by a QG Staff Geologist with respect to the map provided and cleared for public conductible utilities. Our exploration locations were selected by a QG Staff Geologist prior to fieldwork to provide safest access to relevant soil conditions. The geologist directed the advancement of 4 excavated test pits (TP). The test pits were advanced within the vicinity of the anticipated development footprint areas, to maximum depths of 10 feet below present grade (BPG) in general accordance with the specified contract depth.

During explorations QG logged and classified each soil horizon encountered in accordance with the Unified Soil Classification System (USCS). Representative soil samples were collected from each unit, identified according to boring location and depth, placed in plastic bags to protect against moisture loss, and were transported to the soil laboratory for supplemental classification and other tests.

QG advanced 1 Wildcat Dynamic Cone Penetrometer (DCP) test at a representative location within the vicinity of the proposed development. The penetrometer test was terminated upon reaching the equipment's maximum practical extent. During penetrometer advancement, blow counts were recorded in 10-centimeter increments as a thirty-five-pound weight was dropped 15 inches. Blow counts were then converted to resistance (kg/cm<sup>2</sup>), standard penetration blow counts (N-values), and corresponding soil consistency, with complete results shown on the attached logs.

## 2.0 EXISTING SITE CONDITIONS

### 2.1 AREA GEOLOGY

QG reviewed available map publications to assess known geologic conditions and hazards present at the site location. The Washington Geologic Information Portal (WGIP), maintained by the Department of Natural Resources Division of Geology and Earth Resources, provides 1:100,000-scale geologic mapping of the region. Geology of the site location and vicinity consists of continental glacial outwash, Fraser-age (Qgo). The deposits on site are described as, “Silt, clay, sand and gravel deposited by glacial meltwater; variably sorted; loose to compact; massive to well stratified; horizontal to steeply dipping beds; includes drumlins, eskers, kettles, kames, and deltas.”

The WGIP Map also offers layers of mapped geohazard conditions within the state. According to the regional-scale interactive map, no known geohazards are mapped for the site.

The United States Department of Agriculture portal (USDA) provides a soil mapping of the region. The soils in the vicinity of is mapped as Everett very gravelly sandy loam (13B) which is formed as moraines and eskers derived from sandy and gravelly glacial outwash. The soils are described as slightly decomposed plant material from 0 to 1 inch, very gravelly sandy loam from 1 to 24 inches, very gravelly loamy sandy from 24 to 35 inches and extremely cobbly coarse sand from 35 to 60 inches. Depth to restrictive feature is more than 80 inches. Capacity of most limiting layer to transmit water (ksat) is listed as high (1.98 to 5.95 in/hr). Depth to water table is more than 80 inches.

### 2.2 SITE & SURFACE CONDITIONS

The proposed building area is within a presently undeveloped parcel that is generally rectangular in shape. The site is bound by existing multi-family residential development to the north, and existing single-family residences to the west, south, and east. The parcel is heavily vegetated with mature trees, brambles and shrubs. No areas of seeps or standing water were observed at the time of our site visit.

### 2.3 SOIL LOG

Site soil conditions were generally consistent across the property within all test pits. Representative lab samples were taken from TP-1 and TP-2. Soils conditions from the site were as follows:

- **0' to 1.0' – Silty Sand (SM) (Topsoil)**

An overriding layer of topsoil was present across the site that had a high organic content consisting of humic matter and roots. Few cobbles were found within this layer, the soil was moist and dark brown, and no mottling was observed. The soil was in a generally medium dense condition.

- **1.0' to 4.0' – Poorly-Graded Gravel with Sand (GP)**

Beneath topsoil, the soil grades into a brown poorly graded gravel with sand. Rounded cobbles were encountered in this unit, with maximum diameters of approximately 10-inches. No mottling was observed in this, and in a medium dense condition.

- **4.0'-10.0'– Silty Sand (SM)**

Beneath the silty gravel, the soil grades to a tan silty sand with few organics. Rounded cobbles were encountered in this unit, with maximum diameters of approximately 8-inches. Light mottling was observed in this unit in the form of nodules in TP-1 and TP-2 and in a medium dense condition. No groundwater was encountered in any of the test pits.

## **2.4 SURFACE WATER AND GROUNDWATER CONDITIONS**

No active surface water features are present on site. During our test pit explorations, no groundwater was encountered in any of the test pits. The regional groundwater table is inferred to exist greater than 276 feet beneath the entire site, based on well logs made publicly available by the WA Department of Ecology.

QG's scope of work did not include determination or monitoring of seasonal groundwater elevation variations, formal documentation of wet season site conditions, or conclusive measurement of groundwater elevations at depths past the extent feasible for explorations at the time of the field explorations.

## 3.0 GEOTECHNICAL RECOMMENDATIONS

### 3.1 SHALLOW FOUNDATION RECOMMENDATIONS

Assuming site preparation is completed as described below, we recommend the following:

- **Subgrade Preparation**

QG recommends excavating and clearing any loose or organic cover soils, including the thin overriding layer of topsoil where necessary, from areas of proposed pavement construction, down to firm bearing conditions and benching the final bottom of subgrade elevation flat. Excavations should be performed with a smooth blade bucket to limit disturbance of subgrade soils. Vibratory compaction methods are suitable for densification of the non-organic native soils.

After excavations have been completed to the planned subgrade elevations, but before placing fill or structural elements, the exposed subgrade should be evaluated under the periodic guidance of a QG representative. Any areas that are identified as being soft or yielding during subgrade evaluation should be brought to the attention of the geotechnical engineer. Where over excavation is performed below a structure, the over excavation area should extend beyond the outside of the footing a distance equal to the depth of the over excavation below the footing. The over-excavated areas should be backfilled with properly compacted structural fill.

The proposed buildings may utilize either stepped or continuous footings with slab-on-grade elements. For continuous footing elements, upon reaching bearing strata, we recommend benching foundation lines flat. Continuous perimeter and strip foundations may be stepped as needed to accommodate variations in final subgrade level. We also recommend maximum steps of 18 inches with spacing of at least 5 feet be constructed unless specified otherwise by the design engineer. Structural fill may then be placed as needed to reestablish final foundation grade.

- **Allowable Bearing Capacity:**

A bearing capacity of up to 1,500 pounds per square foot (psf) may be considered for foundations placed on **12-inches of compacted structural fill** over compacted native soils. Bearing capacities, at or below 1,500 psf may eliminate the need additional inspection requirements if approved by the permitting authority. The allowable bearing capacity may be increased by 1/3 for transient loading due to wind and seismic events.

- **Minimum Footing Depth:**

For a shallow perimeter and spread footing system, all exterior footings shall be embedded a minimum of 18 inches and all interior footings shall be embedded a minimum of 12 inches below the lowest adjacent finished grade, but not less than the depth required by design. However, all footings must also penetrate to the prescribed bearing stratum cited above. Minimum depths are

referenced per IBC requirements for frost protection; other design concerns may dictate greater values be applied.

- **Minimum Footing Width:**

Footings should be proportioned to meet the stated bearing capacity and/or the IBC 2018 (or current) minimum requirements. For a shallow perimeter and spread footing system, continuous strip footings should be a minimum of 16 inches wide and interior or isolated column footings should be a minimum of 24 inches wide.

- **Estimated Settlements:**

All concrete settles after placement. We estimate that the maximum settlements will be on the order of 0.5 inch, or less, with a differential settlement of ½ inch, or less, over 50 linear feet. Settlement is anticipated to occur soon after the load is applied during construction.

### 3.2 LATERAL SOIL & CONCRETE FOUNDATION CONSIDERATIONS

The results of QG’s investigation indicate shallow and deep subsurface conditions at the proposed building area consist of generally silty sand and poorly graded gravel with sand.

The finished grade is assumed to be similar to the existing grade. In general, native soils may be considered suitable for use as backfill against new in-ground structures or direct bearing. QG understands that the building structures may likely incorporate continuous perimeter grade beams as well as isolated footings, incorporating soil amendment as determined by the structural design team. For lateral support of these structures, the following soil parameters should be considered regarding any structural fill against these features (ignoring the upper 18 inches, due to freeze/thaw softening, unless covered in concrete or asphalt).

**Table 1.** Lateral Earth Pressures

Soil Type	Active Pressure (PSF*H)	At-Rest Pressure (PSF*H)	Seismic Surcharge (PSF*H)	Grade Beam Passive Equivalent Fluid Weight (PCF)	Grade Beam Coefficient of Friction
Existing SM Soils	45	60	8	195*	0.35**
Existing GP Soils	30	60	13	221*	0.38**
New Structural Fill	35	55	10	200	0.35

\*Factor of Safety: 2.0

\*\*Factor of Safety: 1.5

All concrete foundation elements may bear directly on compacted native soils or approved, imported, granular, structural fill per the requirements of *Section 4.2 Structural Fill Materials and Compaction*.

To ensure adequate friction, no fabric shall be placed between the structural fill and native soils when placed under primary building foundations & grade beams.

The proposed buildings may utilize continuous grade beams with slab-on-grade, where appropriate, depending on the chosen development style. For continuous footing elements, upon reaching bearing strata, we recommend benching foundation lines flat.

**SEISMIC DESIGN PARAMETERS AND LIQUEFACTION**

According to the Liquefaction Susceptibility Map of Seismic Design Maps Portal, the site is identified as having low susceptibility. This is generally consistent with the findings of QG’s investigation to date. Liquefaction is a phenomenon typically associated with a subsurface profile of relatively loose, cohesionless soils saturated by groundwater. Under seismic shaking the pore pressure can exceed the soil’s shear resistance and the soil ‘liquefies’, which may result in excessive differential settlements that are damaging to structures and disruptive to exterior improvements. *The Washington Interactive Geologic Map - Seismic Site Class Map* classifies the project regional vicinity as *Site Class C to D*. As is common for Washington, we have identified the site as Site Class D due to the sandy nature of soils on site.

The USGS Seismic Design Map Tool was used to determine seismic design coefficients and spectral response accelerations assuming Site Class D, representing a generally stiff soil profile (upper 100 feet). Parameters in Table 2 were calculated using 2014 USGS hazard data and ASCE 7-16 was referenced for site Peak Ground Acceleration.

**Table 2.** Seismic Design Parameters

Seismic Design Category		D	D	D-Default
Reference		ASCE 7-10	ASCE 7-16	ASCE 7-16
Risk Category		II	II	II
MCE <sub>R</sub> ground motion (period=0.2s)	S <sub>S</sub>	1.247	1.264	1.264
MCER ground motion (period=1.0s)	S <sub>1</sub>	0.48	0.436	0.436
Site-modified spectral acceleration value	S <sub>MS</sub>	1.249	1.264	1.517
Site-modified spectral acceleration value	S <sub>M1</sub>	0.729	NULL	NULL
Numeric seismic design value at 0.2s SA	S <sub>DS</sub>	0.832	0.843	1.011
Numeric seismic design value at 1.0s SA	S <sub>D1</sub>	0.486	NULL	NULL
Site amplification factor at 0.2s	F <sub>a</sub>	1.001	1.0	1.2
Site amplification factor at 1.0s	F <sub>v</sub>	1.52	NULL	NULL
Site modified peak ground acceleration	PGA <sub>M</sub>	0.5	0.55	0.6



Based on the findings of this study, the site is generally considered to have a low risk of liquefaction-induced settlement.

### **3.2.1 BUILDING SLAB ON GRADE FLOOR**

QG anticipates that slab-on-grade floors are planned for the interior of the proposed building. Based on typical construction practices, we assume finished slab grade will be similar to or marginally above present grade for the below recommendations. If floor grades are planned to be substantially raised or lowered from existing grade, QG should be contacted to provide revised or alternative recommendations.

- **Capillary Break:**

A capillary break will be helpful to maintain a dry slab floor and reduce the potential for floor damage resulting from shallow perched water inundation. To provide a capillary moisture break, a 6-inch thick, properly compacted granular mat consisting of open-graded, free-draining angular aggregate is recommended below floor slabs. To provide additional slab structural support, or to substitute for a structural fill base pad where specified, QG recommends the capillary break should consist of crushed rock all passing the 1-inch sieve and no more than 3 percent (by weight) passing the U.S. No. #4 sieve, compacted in accordance with *Section 4.2.2* of this report.

- **Vapor Barrier:**

A vapor retarding membrane such as 10 mil polyethylene film should be placed beneath all floor slabs to prevent transmission of moisture where floor coverings may be affected. Care should be taken during construction not to puncture or damage the membrane. To protect the membrane, a layer of sand no more than 2 inches thick may be placed over the membrane if desired. If excessive relict organic fill material is discovered at any location, additional sealant or more industrial gas barriers may be required to prevent off-gassing of decaying material from infiltrating the new structure. These measures shall be determined by the structural engineer to meet local code requirements as necessary.

- **Structural Design Considerations:**

QG assumes the design and specifications of slabs will be assessed by the project design engineer. We suggest a minimum unreinforced concrete structural section of 4.0 inches be considered to help protect against cracking and localized settlement, especially where larger equipment or localized loads are anticipated. It is generally recommended that any floor slabs and annular exterior concrete paving subject to vehicular loading be designed to incorporate reinforcing. Additionally, some level of reinforcing, such as a wire mesh may be desirable to prolong slab life

due to the overwhelming presence of such poor underlying soils. It should be noted that QG does not express any guarantee or warranty for proposed slab sections.

### 3.3 INFILTRATION RATE DETERMINATION

QG understands the design of on-site stormwater controls are pending the results of this study to confirm design parameters and interpreted depths to perched seasonal groundwater and restrictive soil features.

#### 3.3.1 GRADATION ANALYSIS METHODS & RESULTS

During test pit excavations for general site investigation, QG collected representative samples of native soil deposits among potential infiltration strata and depths. Representative soil samples were selected from native soils within TP-1 and TP-2 to characterize the local infiltration conditions.

We understand the project will be subject to infiltration design based on the Washington Department of Ecology Stormwater Management Manual for Western Washington (DoE SMMWW). For initial site infiltration characterization within the scope of this study, laboratory gradation analyses were completed including sieve and hydrometer tests for stormwater design characterization and rate determination to supplement field observations. Results of laboratory testing in terms of rate calculation are summarized below.

Laboratory results were interpreted to recommended design inputs in accordance with methods of the 2024 DoE SMMWW. Gradation results were applied to the Massmann (2003) equation (1) to calculate Ksat representing the initial saturated hydraulic conductivity.

$$(1) \quad \log_{10}(K_{sat}) = -1.57 + 1.90 \cdot D_{10} + 0.015 \cdot D_{60} - 0.013 \cdot D_{90} - 2.08 \cdot ff$$

Corrected Ksat values presented below are a product of the initial Ksat and correction factor CFT. For a generalized site-wide design situation, we have applied a site variability factor of CFv = 0.7 along with typical values of CFt = 0.4 (for the Grain Size Method) and CFm = 0.9 (assuming standard influent control).

$$(2) \quad CFT = CFv \times CFt \times CFm \times CFb = 0.7 \times 0.4 \times 0.9 \times 1.0 = 0.25$$

Results were cross-referenced with test pit logs to determine the validity and suitability of unique materials as an infiltration receptor. Additional reduction factors were applied for practical rate determination based on our professional judgement.

**Table 3. Results Of Massmann Analysis**

TP #	Sample Depth (BPG)	Unit Extent (ft)	Soil Type	D10	D60	D90	Fines (%)	Ksat (in/hr)	CorrectedKsat (in/hr)	LT Design Infiltration Rate(in/hr)	Cation Exchange Capacity (meq/100g)	Organic Content %
2	2.5	1.0-3.7	GP	0.439	16.82	38.24	4.2	121.17	57.25	20.0	3.7	1.8
1	8.0	0.5-10.0	SM	0.038	0.22	0.81	19.5	17.41	4.39	4.39	4.6	0.6

Beneath the topsoil, the SM and GP soils were observed to generally exhibit low fines content and minimal oxidation patterns. In-ground infiltration structures are required to maintain a minimum of 5-foot separation from restrictive soil & groundwater features. Available well logs do not indicate the potential for shallow ground water. Groundwater is inferred to exist greater than 276 feet below existing grade based on public well logs. **For in-ground infiltration galleries, we recommend a maximum design rate of up to 4.39 inches/hour be considered.** The required separation appears generally achievable across the site. Currently, QG does not recommend mounding analysis due to the generally suitable site conditions.

Alternatives to in-ground infiltration include the use of rain gardens, bio-swales, or pervious pavement, which can be considered at the discretion of the designer and client depending on final development needs and constraints. For shallow infiltration features utilizing treatment media, we recommend a maximum design rate of up to 1.0 inch/hour be considered. This considers potential reductions from compaction during construction.

QG recommends the facility designer review these results and stated assumptions per reference literature to ensure applicability with the proposed development, level of anticipated controls, and long-term maintenance plan. The designer may make reasonable adjustments to correction factors and the resulting design values based on these criteria to ensure design and operational intent is met. We recommend that we be contacted if substantial changes to rate determination are considered.

### **3.3.2 TREATMENT POTENTIAL**

Depending on stormwater and runoff sources, some stormwater features, such as rain gardens or pervious pavements may require treatment. Stormwater facilities utilizing native soils as treatment media typically require Cation Exchange Capacities (CEC) of greater than 5 milliequivalents per 100grams (meq/100g) and organic contents greater than 1% (this may vary depending on local code). Native soils beneath topsoil across the site **do not** meet these requirements.

### **3.4 DRAINAGE RECOMMENDATIONS**

QG recommends proper drainage controls for stormwater runoff during and after site development to protect the site. The ground surface adjacent to structures should be sloped to drain away at a 5% minimum to prevent ponding of water adjacent to them.

Foundations shall incorporate a wraparound footing drain composed of imported clean granular drain rock. There shall be a perforated drainpipe connected around the perimeter of the footing drain (within the rock) graded to gravity drain to an outfall pipe, to allow any accumulated water to be released to an approved drainage feature or location. The outfall point must be lower in elevation than the lowest point of possible water accumulation in the mat fill, so as to allow any captured water within the mat or crawlspace to completely drain away from the building footprint preventing standing water from accumulating. QG recommends all stormwater catchments (new or existing) be tightlined (piped) away from structures to an existing catch basin, stormwater system, established channel, or approved outfall to be released using appropriate energy-dissipating features at the outfall to minimize point erosion. Roof and footing drains should be tightlined separately or should be gathered in an appropriately sized catch basin structure and redistributed collectively. If storm drains are incorporated for impervious flatworks (driveways, sidewalks, etc.) collected waters should also be discharged according to the above recommendations. Appropriate measures should be taken by the site designer to consider and allow for an adequate emergency outfall location in the event of a future record stormwater fall that cannot be anticipated.

### 3.5 EROSION CONTROLS

Erosion is one of the most common driving forces leading to slope instability. In addition to the above commentary, the following general recommendations should be implemented in general to reduce long-term erosion potential of the slope below the project site and maintain slope stability:

- Minimize the volume and velocity of water that travels toward and down the slope face (via proper choice of site development features including stormwater controls discussed above).
- Avoid accelerating slope erosion and mass wasting due to human activity such as:
  - ✓ Adding side-cast such as dumping landscape debris or fallen trees on or above the slopes.
  - ✓ Using heavy construction equipment on or near steep slopes.
  - ✓ Excavating near adjacent steep slopes toe or on slope face.
  - ✓ Placing excavated soil near the steep slope crest.
- Prior to construction, a silt fence and/or a continuous line of straw bales should be placed on the slopeward edge of the construction area. Heavy construction equipment, construction materials, or native and imported soils should not be placed behind the erosion control devices. Suitable temporary erosion and sediment control measures should be implemented at the construction site during and immediately after ground disturbance occurs. Temporary areas bare of vegetation should be protected from erosion via a blanket of straw or rolled erosion control product (RECP) during prolonged breaks in site work and prior to reseeding or revegetation.
- At the end of the project, all bare surfaces and areas of disturbed vegetation should be replanted and maintained until fully reestablished. Concentrated surface water should not be allowed to

traverse the slope during or after the construction phase of the project. Roof downspouts and footing drains should be routed into closed separate pipes which outfall into appropriate drainages. Outlets for these pipes should be protected from erosion through the use of rip-rap (quarry spalls) or some other energy dissipating device. Similarly, concentrated drainages should be captured in closed pipe systems and routed down slope to appropriate outfalls.

- Clearing of existing vegetation outside the proposed building area on and adjacent to the existing slopes should be avoided except as approved by a qualified professional. This provides additional stability to the loose topsoil and minimizes the effects of down-slope water movement. This is excepting removal of problem, dead, or dying, trees if posing a direct hazard to site installations or adjacent roadways.
- Grading or excavation of soils during construction should be accompanied by grass reseeding and re-vegetation as the project is completed. Areas of existing moderate vegetation can also benefit from additional deep rooting plants. According to “Vegetation Management: A Guide for Puget Sound Bluff Property Owners” (Manashe, 1993) the following types of vegetation provide good to excellent erosion control:

<i>Common Name</i>	<i>Botanical Name</i>	<i>Deciduous/Evergreen</i>	<i>Mature Height (ft)</i>
Bigleaf Maple	Acer macrophyllum	Deciduous	60
Douglas Fir	Pseudotsuga menziesii	Evergreen	200+
Evergreen	Vaccinium ovatum	Evergreen	To 8
Oceanspray	Holodiscus discolor	Deciduous	10+
Oregon Grape	Mahonia spp.	Evergreen	To 6
Pacific Madrone	Arbutus menziesii	Evergreen	70
Red huckleberry	Vaccinium parvifolium	Deciduous	To 12
Rose	Rose spp.	Deciduous	2-10
Salal	Gaultheria shallon	Evergreen	To 4
Salmonberry	Rubus spectabilis	Deciduous	To 12
Serviceberry	Amelanchier alnifolia	Deciduous	12+
Snowberry	Symphoricarpos albus	Deciduous	3+
Vine Maple	Acer cricatum	Deciduous	10+
Willow	Salix spp.	Deciduous	10+

## **4.0 CONSTRUCTION RECOMMENDATIONS**

### **4.1 EARTHWORK**

#### ***4.1.1 GRADING & EXCAVATION***

A grading plan was not available to QG at the time of this report. However, based on provided conceptual plans, this study assumes finished site grade will approximate current grade. Therefore, depths referred to in this report are considered roughly equivalent to final depths. Excavations can generally be performed with conventional earthmoving equipment such as bulldozers, scrapers, and excavators.

#### ***4.1.2 SUBGRADE EVALUATION & PREPARATION***

After excavations have been completed to the planned subgrade elevations, but before placing fill or structural elements, the exposed subgrade should be evaluated under the part-time observation and guidance of a QG representative.

The special inspection firm should continuously evaluate all backfilling. Any areas that are identified as being soft or yielding during subgrade evaluation should be over excavated to a firm and unyielding condition or to the depth determined by the geotechnical engineer. Where over excavation is performed below a structure, the over excavation area should extend beyond the outside of the footing a distance equal to the depth of the over excavation below the footing. The over-excavated areas should be backfilled with properly compacted structural fill.

#### ***4.1.3 SITE PREPARATION, EROSION CONTROLL, WET WEATHER***

Any silty or organic rich native soils may be moisture-sensitive and become soft and difficult to traverse with construction equipment when wet. During wet weather, the contractor should take measures to protect any exposed soil subgrades, limit construction traffic during earthwork activities, and limit machine use only to areas undergoing active preparation.

Once the geotechnical engineer has approved the subgrade, further measures should be implemented to prevent degradation or disturbance of the subgrade. These measures could include, but are not limited to, placing a layer of crushed rock or lean concrete on the exposed subgrade, or covering the exposed subgrade with a plastic tarp and keeping construction traffic off the subgrade. Once the subgrade has been approved, any disturbance because the subgrade was not protected should be repaired by the contractor at no cost to the owner.

During wet weather, earthen berms or other methods should be used to prevent runoff from draining into excavations. All runoffs should be collected and disposed of properly. Measures may also be

required to reduce the moisture content of on-site soils in the event of wet weather. These measures can include, but are not limited to, air drying and soil amendment, etc.

QG recommends earthwork activities take place during the summer dry season.

## 4.2 STRUCTURAL FILL MATERIALS AND COMPACTION

### 4.2.1 MATERIALS

All material placed below structures or pavement areas should be considered structural fill. Excavated native soils may be considered suitable for reuse as structural fill on a case-by-case basis. Imported material can also be used as structural fill. Care should be taken by the earthwork contractor during grading to avoid contaminating stockpiled soils that are planned for reuse as structural fill with native organic materials. Frozen soil is not suitable for use as structural fill. Fill material may not be placed on frozen soil.

Structural fill material shall be free of deleterious materials, have a maximum particle size of 4 inches, and be compactable to the required compaction level. Imported structural fill material should conform to the WSDOT manual Section 9-03.14(1) Gravel Borrow, or an approved alternative import material. Controlled-density fill (CDF) or lean mix concrete can be used as an alternative to structural fill materials, except in areas where free-draining materials are required or specified.

Imported materials utilized for trench back fill shall conform to Section 9-03.19, Trench Backfill, of the most recent edition (at the time of construction) of the State of Washington Department of Transportation *Standard Specifications for Road, Bridge, and Municipal Construction (WSDOT Standard Specifications)*. Imported materials utilized as grade fill beneath roads shall conform to WSDOT Section 9-03.10, Gravel Base.

Pipe bedding material should conform to the manufacturer's recommendations and be worked around the pipe to provide uniform support. Cobbles exposed in the bottom of utility excavations should be covered with pipe bedding or removed to avoid inducing concentrated stresses on the pipe.

Soils with fines content near or greater than 10% fines content may likely be moisture sensitive and become difficult to use during wet weather. Care should be taken by the earthwork contractor during grading to avoid contaminating stockpiled soils that are planned for reuse as structural fill with native organic materials.

The contractor should submit samples of each of the required earthwork materials to the materials testing lab for evaluation and approval prior to delivery to the site. The samples should be submitted **at least 5 days prior to their delivery** and sufficiently in advance of the work to allow the contractor to identify alternative sources if the material proves unsatisfactory.



#### **4.2.2 FILL PLACEMENT AND COMPACTION**

For lateral and bearing support, structural fill placement below footings shall extend at minimum a distance past each edge of the base of the footing equal to the depth of structural fill placed below the footing [i.e. extending at least a 1H:1V past both the interior and the exterior of the concrete footing].

Prior to placement and compaction, structural fill should be moisture conditioned to within 3 percent of its optimum moisture content. Loose lifts of structural fill shall not exceed 12 inches in thickness. All structural fill shall be compacted to a firm and unyielding condition and to a minimum percent compaction based on its modified Proctor maximum dry density as determined per ASTM D1557. Structural fill placed beneath each of the following shall be compacted to the indicated percent compaction:

- Foundation and Floor Slab Subgrades: 95 Percent
- Pavement Subgrades & wall backfill (upper 2 feet): 95 Percent
- Pavement Subgrades & wall backfill (below 2 feet): 90 Percent
- Utility Trenches (upper 4 feet): 95 Percent
- Utility Trenches (below 4 feet): 90 Percent

A sufficient number of tests should be performed to verify the compaction of each lift. The number of tests required will vary depending on the fill material, its moisture condition and the equipment being used. Initially, more frequent tests will be required while the contractor establishes the means and methods required to achieve proper compaction.

Jetting or flooding is not a substitute for mechanical compaction and should not be allowed.

#### **4.3 TEMPORARY EXCAVATIONS AND TRENCHES**

All excavations and trenches must comply with applicable local, state, and federal safety regulations. Construction site safety is the sole responsibility of the Contractor, who shall also be solely responsible for the means, methods, and sequencing of construction operations. We are providing soil type information solely as a service to our client for planning purposes. Under no circumstances should the information be interpreted to mean that QG is assuming responsibility for construction site safety or the Contractor's activities; such responsibility is not being implied and should not be inferred. The contractor shall be responsible for the safety of personnel working in utility trenches. Given that steep excavations in native soils may be prone to caving, we recommend all utility trenches, but particularly those greater than 4 feet in depth, be supported in accordance with state and federal safety regulations. Heavy construction equipment, building materials, excavated soil, and vehicular traffic should not be allowed near the top of any excavation.



Temporary excavations and trenches should be protected from the elements by covering them with plastic sheeting or some other similar impermeable material. Sheeting sections should overlap by at least 12 inches and be tightly secured with sandbags, tires, staking, or other means to prevent wind from exposing the soils under the sheeting.

## 5.0 SPECIAL INSPECTION

The recommendations made in this report assume that an adequate program of tests and observations will be made throughout construction to verify compliance with these recommendations. Testing and observations performed during construction should include, but not necessarily be limited to, the following:

- Geotechnical plan review and engineering consultation as needed prior to construction phase,
- Observations and testing during site preparation, earthwork, structural fill, and pavement section placement,
- Consultation on temporary excavation cutslopes and shoring if needed,
- Consultation as necessary during construction.

QG recommends that we be retained for construction phase soils testing and periodic earthwork observation in accordance with the local code requirements. We also strongly recommend that QG be retained as the project Geotechnical Engineering Firm of Record (GER) during the construction of this project to perform periodic supplementary geotechnical observations and review the special inspectors reports during construction.

Our knowledge of the project site and the design recommendations contained herein will be of great benefit in the event that difficulties arise and either modifications or additional geotechnical engineering recommendations are required or desired. We can also, in a timely fashion observe the actual soil conditions encountered during construction, evaluate the applicability of the recommendations presented in this report to the soil conditions encountered, and recommend appropriate changes in design or construction procedures if conditions differ from those described herein.

We would be pleased to meet with you at your convenience to discuss the *Time & Materials* scope and cost for these services.

## 6.0 LIMITATIONS

Upon acceptance and use of this report, and its interpretations and recommendations, the user shall agree to indemnify and hold harmless QG, including its owners, employees and subcontractors, from any adverse effects resulting from development and occupation of the subject site. Ultimately, it is the owner's choice to develop and live in such an area of possible geohazards (which exist in perpetuity across the earth in one form or another), and therefore the future consequences, both anticipated and unknown, are solely the responsibility of the owner. By using this report for development of the subject property, the owner must accept and understand that it is not possible to fully anticipate all inherent risks of development. The recommendations provided above are intended to reduce (but may not eliminate) such risks.

This report does not represent a construction specification or engineered plan and shall not be used or referenced as such. The information included in this report should be considered supplemental to the requirements contained in the project plans & specifications and should be read in conjunction with the above referenced information. The selected recommendations presented in this report are intended to inform only the specific corresponding subjects. All other requirements of the above-mentioned items remain valid, unless otherwise specified.

Recommendations contained in this report are based on our understanding of the proposed development and construction activities, field observations and explorations, and laboratory test results. It is possible that soil and groundwater conditions could vary and differ between or beyond the points explored. If soil or groundwater conditions are encountered during construction that differ from those described herein, or If the scope of the proposed construction changes from that described in this report, QG should be notified immediately in order to review and provide supplemental recommendations.

The findings of this study are limited by the level of scope applied. We have prepared this report in substantial accordance with the generally accepted geotechnical engineering practice as it exists in the subject region. No warranty, expressed or implied, is made. The recommendations provided in this report assume that an adequate program of tests and observations will be conducted by a WABO approved special inspection firm during the construction phase in order to evaluate compliance with our recommendations.

This report may be used only by the Client and their design consultants and only for the purposes stated within a reasonable time from its issuance, but in no event later than 18 months from the date of the report. It is the Client's responsibility to ensure that the Designer, Contractor, Subcontractors, etc. are made aware of this report in its entirety. Note that if another firm assumes Geotechnical Engineer of Record responsibilities, they need to review this report and either concur with the findings, conclusions, and recommendations or provide alternate findings, conclusions and recommendation.

Land or facility use, on- and off-site conditions, regulations, or other factors may change over time, and additional work may be required. Based on the intended use of the report, QG may recommend that additional work be performed and that an updated report be issued. Non-compliance with any of these requirements by the Client or anyone else will release QG from any liability resulting from the use of this report. The Client, the design consultants, and any unauthorized party, agree to defend, indemnify, and hold harmless QG from any claim or liability associated with such unauthorized use or non-compliance. We recommend that QG be given the opportunity to review the final project plans and specifications to evaluate if our recommendations have been properly interpreted. We assume no responsibility for misinterpretation of our recommendations.



# Appendix A. Region & Vicinity Maps

## REGION

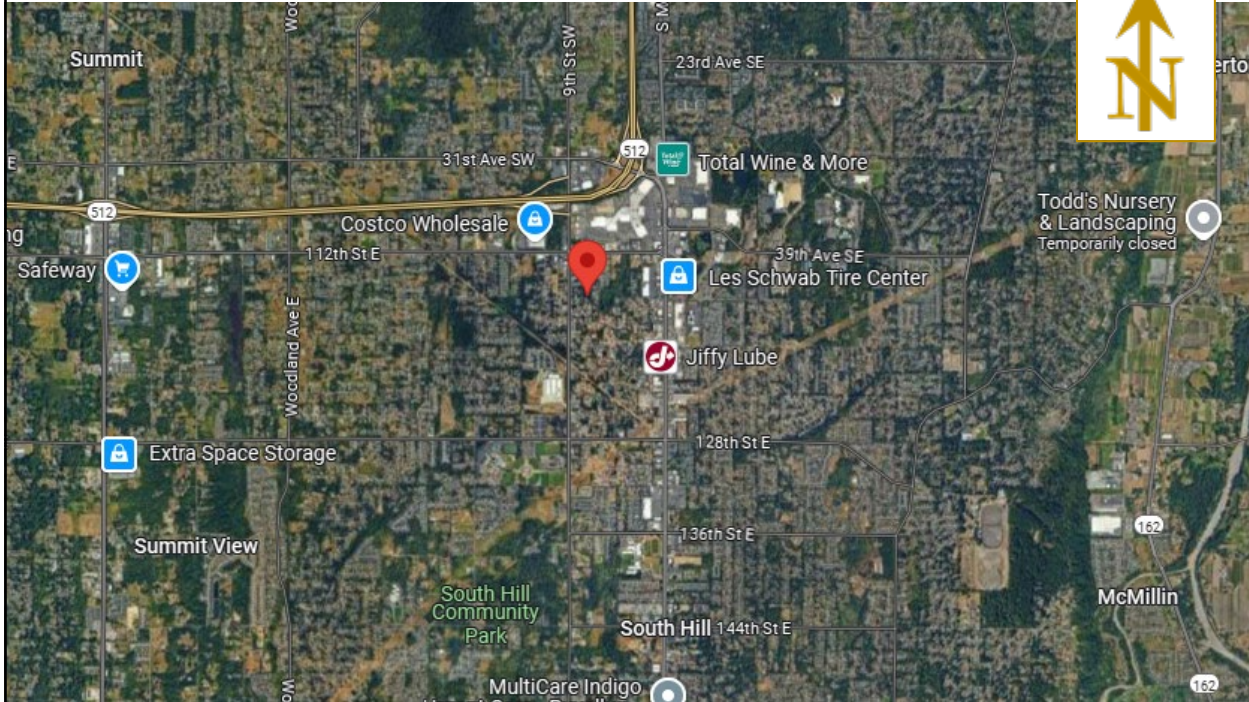

## VICINITY

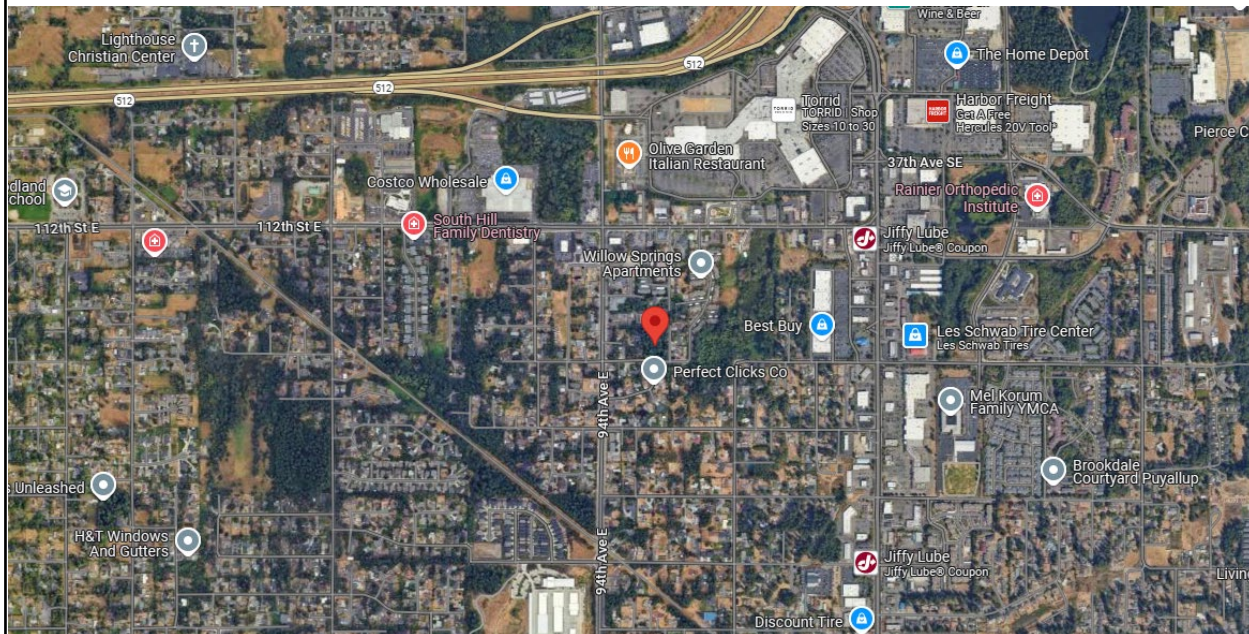

**Quality Geo  
 NW, PLLC**

**Site Region**  
 43<sup>rd</sup> Ave Apartments Geo

Source: Google Imagery, 2025  
 Scale & Locations are approx.  
**Not for Construction**

**Figure 1**



## Appendix B. Exploration Map



Quality Geo  
 NW, PLLC

Site Map  
 43<sup>rd</sup> Ave Apartments Geo

Source: Pierce Co., GIS, 2025  
 Scale & Locations are approx.  
 Not for Construction

Figure 2

# Appendix C. Exploration Logs



## Test Pit Log TP-1

PROJECT NUMBER QG24-260		FIELD WORK DATE 12/16/2024		BORING LOCATION Center of parcel, potential infiltration facility	
PROJECT NAME 43rd Ave Apts Geo		DRILLING METHOD Excavator		SURFACE ELEVATION Existing	
PROJECT LOCATION Puyallup, WA				LOGGED BY CA	
COMMENTS					
Depth (ft)	Samples	Is Analysed?	Graphic Log	USCS	Material Description
0.5				SM	SILTY SAND (TOPSOIL)
1				SM	Dark brown, moist, highly organic (roots, humus), no mottling, cobbles (rounded, to 6-inch diameter), medium dense
1.5					VISUAL CLASSIFICATION: Gravel= 35%, Sand= 45%, Fines= 20%
2					SILTY SAND Tan, moist, few organics (roots), light mottling (nodules), few cobbles (rounded to 8-inch diameter), medium dense
2.5					Gravel= 6% Sand= 74% Fines= 20%
3					
3.5					
4					
4.5					
5					
5.5					
6					
6.5					
7					
7.5					
8	TP-1@8ft	Y			
8.5					
9					
9.5					
10					Terminated at Max Machine Extent No Groundwater Encountered
10.5					



Test Pit Log TP-2

PROJECT NUMBER QG24-260		FIELD WORK DATE 12/16/2024		BORING LOCATION Northeast of TP-1, potential infiltration facility	
PROJECT NAME 43rd Ave Apts Geo		DRILLING METHOD Excavator		SURFACE ELEVATION Existing	
PROJECT LOCATION Puyallup, WA				LOGGED BY CA	
COMMENTS					
Depth (ft)	Samples	Is Analysed?	Graphic Log	USCS	Material Description
0.5				SM	SILTY SAND (TOPSOIL) Dark brown, moist, highly organic (roots, humus), no mottling, cobbles (rounded, to 6-inch diameter), medium dense
1				GP	VISUAL CLASSIFICATION: Gravel= 35%, Sand= 45%, Fines= 20% POORLY GRADED GRAVEL with SAND Brown, moist, few organics (roots), no mottling, abundant cobbles (rounded to 10-inch diameter), medium dense
1.5					Gravel= 69% Sand= 27% Fines= 4%
2					
2.5	TP-2@2.5ft	Y			
3					
3.5					
4				SM	SILTY SAND Tan, moist, few organics (roots), light mottling (nodules), few cobbles (rounded to 8-inch diameter), medium dense
4.5					Gravel= 6% Sand= 74% Fines= 20%
5					
5.5					
6					
6.5					
7					
7.5					
8					
8.5					
9					
9.5					
10					Terminated at Max Machine Extent No Groundwater Encountered
10.5					



Test Pit Log TP-3

<b>PROJECT NUMBER</b> QG24-260	<b>FIELD WORK DATE</b> 12/16/2024	<b>BORING LOCATION</b> North of TP-1, potential infiltration facility
<b>PROJECT NAME</b> 43rd Ave Apts Geo	<b>DRILLING METHOD</b> Excavator	<b>SURFACE ELEVATION</b> Existing
<b>PROJECT LOCATION</b> Puyallup, WA		<b>LOGGED BY</b> CA

COMMENTS

Depth (ft)	Samples	Is Analysed?	Graphic Log	USCS	Material Description
0.5				SM	SILTY SAND (TOPSOIL)
1				GP	Dark brown, moist, highly organic (roots, humus), no mottling, cobbles (rounded, to 6-inch diameter), medium dense  VISUAL CLASSIFICATION: Gravel= 35%, Sand= 45%, Fines= 20% POORLY GRADED GRAVEL with SAND Brown, moist, few organics (roots), no mottling, abundant cobbles (rounded to 10-inch diameter), medium dense  Gravel= 69% Sand= 27% Fines= 4%
3				SM	SILTY SAND Tan, moist, few organics (roots), no mottling, few cobbles (rounded to 8-inch diameter), medium dense  Gravel= 6% Sand= 74% Fines= 20%
10					Terminated at Max Machine Extent No Groundwater Encountered





Test Pit Log TP-4

<b>PROJECT NUMBER</b> QG24-260	<b>FIELD WORK DATE</b> 12/16/2024	<b>BORING LOCATION</b> South of TP-1, proposed building area
<b>PROJECT NAME</b> 43rd Ave Apts Geo	<b>DRILLING METHOD</b> Excavator	<b>SURFACE ELEVATION</b> Existing
<b>PROJECT LOCATION</b> Puyallup, WA		<b>LOGGED BY</b> CA

COMMENTS

Depth (ft)	Samples	Is Analysed?	Graphic Log	USCS	Material Description
0.5				SM	SILTY SAND (TOPSOIL) Dark brown, moist, highly organic (roots, humus), no mottling, cobbles (rounded, to 6-inch diameter), medium dense
1				SM	VISUAL CLASSIFICATION: Gravel= 35%, Sand= 45%, Fines= 20% SILTY SAND Tan, moist, few organics (roots), no mottling, few cobbles (rounded to 8-inch diameter), medium dense
1.5					Gravel= 6% Sand= 74% Fines= 20%
2					
2.5					
3					
3.5					
4					
4.5					
5					
5.5					
6					
6.5					
7					
7.5					
8					
8.5					
9					
9.5					
10					Terminated at Max Machine Extent No Groundwater Encountered
10.5					

### WILDCAT DYNAMIC CONE LOG

Quality Geo NW, PLLC  
Geotechnical Consultants  
Lacey, WA

PROJECT NUMBER: QG24-160  
DATE STARTED: 12-16-2024  
DATE COMPLETED: 12-16-2024

HOLE #: DCP-1  
CREW: CA  
PROJECT: 43rd Ave Apts  
ADDRESS: th St SW & 43rd Ave SW, Puyallup, WA 98465  
LOCATION: Proposed building area,

SURFACE ELEVATION: Existing  
WATER ON COMPLETION: No  
HAMMER WEIGHT: 35 lbs.  
CONE AREA: 10 sq. cm

DEPTH	BLOWS PER 10 cm	RESISTANCE Kg/cm <sup>2</sup>	GRAPH OF CONE RESISTANCE				N'	TESTED CONSISTENCY	
			0	50	100	150		NON-COHESIVE	COHESIVE
-	6	26.6	*****				7	LOOSE	MEDIUM STIFF
-	7	31.1	*****				8	LOOSE	MEDIUM STIFF
- 1 ft	7	31.1	*****				8	LOOSE	MEDIUM STIFF
-	9	40.0	*****				11	MEDIUM DENSE	STIFF
-	13	57.7	*****				16	MEDIUM DENSE	VERY STIFF
- 2 ft	12	53.3	*****				15	MEDIUM DENSE	STIFF
-	14	62.2	*****				17	MEDIUM DENSE	VERY STIFF
-	14	62.2	*****				17	MEDIUM DENSE	VERY STIFF
- 3 ft	14	62.2	*****				17	MEDIUM DENSE	VERY STIFF
- 1 m	19	84.4	*****				24	MEDIUM DENSE	VERY STIFF
-	20	77.2	*****				22	MEDIUM DENSE	VERY STIFF
- 4 ft	14	54.0	*****				15	MEDIUM DENSE	STIFF
-	12	46.3	*****				13	MEDIUM DENSE	STIFF
-	20	77.2	*****				22	MEDIUM DENSE	VERY STIFF
- 5 ft	15	57.9	*****				16	MEDIUM DENSE	VERY STIFF
-	15	57.9	*****				16	MEDIUM DENSE	VERY STIFF
-	12	46.3	*****				13	MEDIUM DENSE	STIFF
- 6 ft	16	61.8	*****				17	MEDIUM DENSE	VERY STIFF
-	22	84.9	*****				24	MEDIUM DENSE	VERY STIFF
- 2 m	16	61.8	*****				17	MEDIUM DENSE	VERY STIFF
- 7 ft	14	47.9	*****				13	MEDIUM DENSE	STIFF
-	21	71.8	*****				20	MEDIUM DENSE	VERY STIFF
-	14	47.9	*****				13	MEDIUM DENSE	STIFF
- 8 ft	24	82.1	*****				23	MEDIUM DENSE	VERY STIFF
-	25	85.5	*****				24	MEDIUM DENSE	VERY STIFF
-	31	106.0	*****				25+	MEDIUM DENSE	VERY STIFF
- 9 ft	36	123.1	*****				25+	DENSE	HARD
-	32	109.4	*****				25+	DENSE	HARD
-	50	171.0	*****				25+	DENSE	HARD
- 3 m 10 ft									
-									
-									
- 11 ft									
-									
- 12 ft									
-									
- 4 m 13 ft									

# Appendix D. Laboratory Results



**SAMPLE ID: TP-1@8ft**

Sieve Analysis |  Wet Wash |  Hydrometer |  Atterberg Limits

Project Name: 43rd Ave Apartment  
Project Number: QG24-160  
Date Collected: 12/16/24  
Date Reported: 01/10/25  
Boring ID: TP-1  
Boring Depth: 8ft

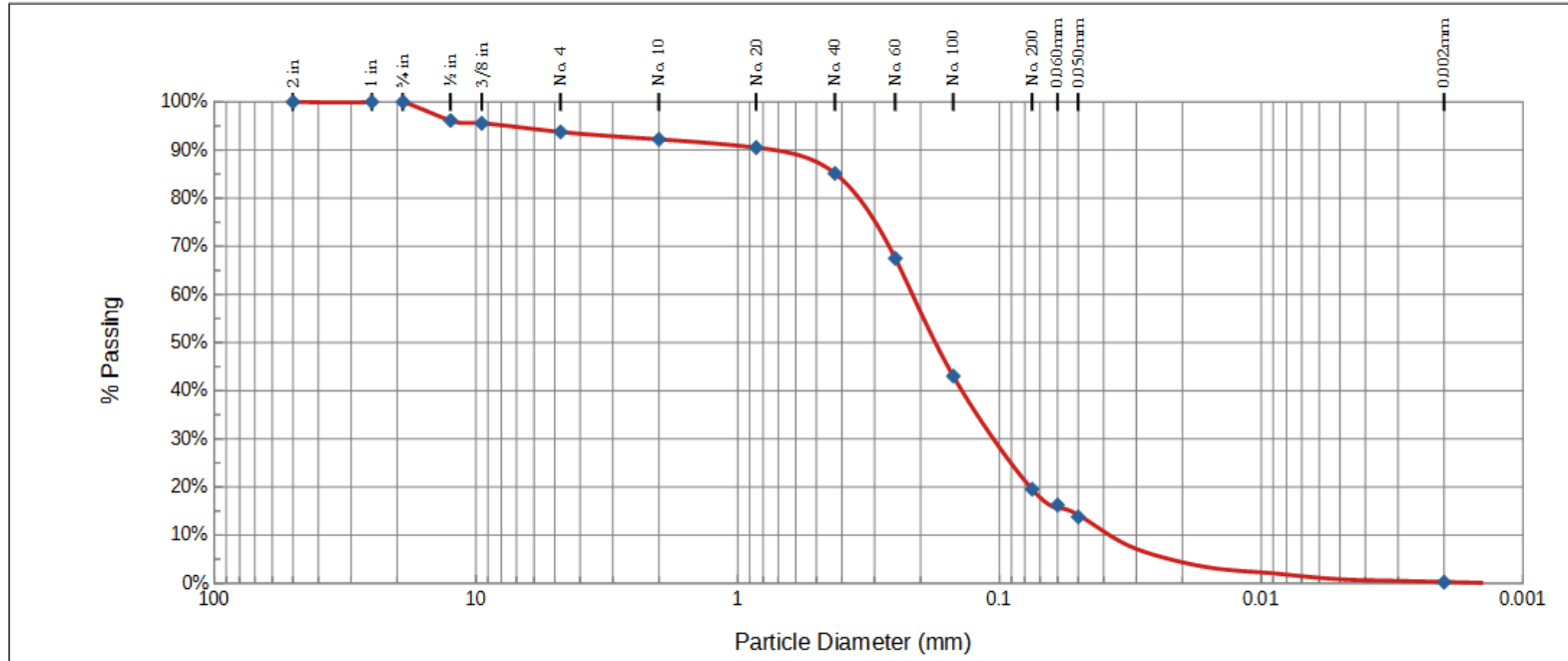

USCS Scale	Coarse Gravel		Fine Gravel			Coarse Sand		Medium Sand		Fine Sand			(% of Fines Passing #200 Sieve)			Sand Total	Gravel Total
	Sieve #	Diameter, mm	2"	1"	3/4"	3/8"	4	10	20	40	60	100	200	Hydrometer Method			
Retained	0.0%	0.0%	0.0%	3.9%	4.4%	6.3%	7.8%	9.5%	14.9%	32.5%	57.0%	80.5%	16.2%	13.8%	0.22%	74.2%	6.3%
Passing	100.0%	100.0%	100.0%	96.1%	95.6%	93.7%	92.2%	90.5%	85.1%	67.5%	43.0%	19.5%					

**Graph Values**

D90 0.81  
D60 0.22  
D30 0.108  
D10 0.038

Coefficient of Uniformity: 2.02  
Coefficient of Gradation: 1.41

CEC: 4.6 meq/100g  
OM (LOI 360): 0.6 %

Unified Soil Classification System (USCS) Description	
SM	SILTY SAND

Staff Initials: T

Test Methods: ASTM D6913, ASTM D7928

January 10, 2025



**SAMPLE ID: TP-2@2.5ft**

Sieve Analysis |  Wet Wash |  Hydrometer |  Atterberg Limits

Project Name: 43rd Ave Apartment  
Project Number: QG24-160  
Date Collected: 12/16/24  
Date Reported: 01/08/25  
Boring ID: TP-2  
Boring Depth: 2.5ft

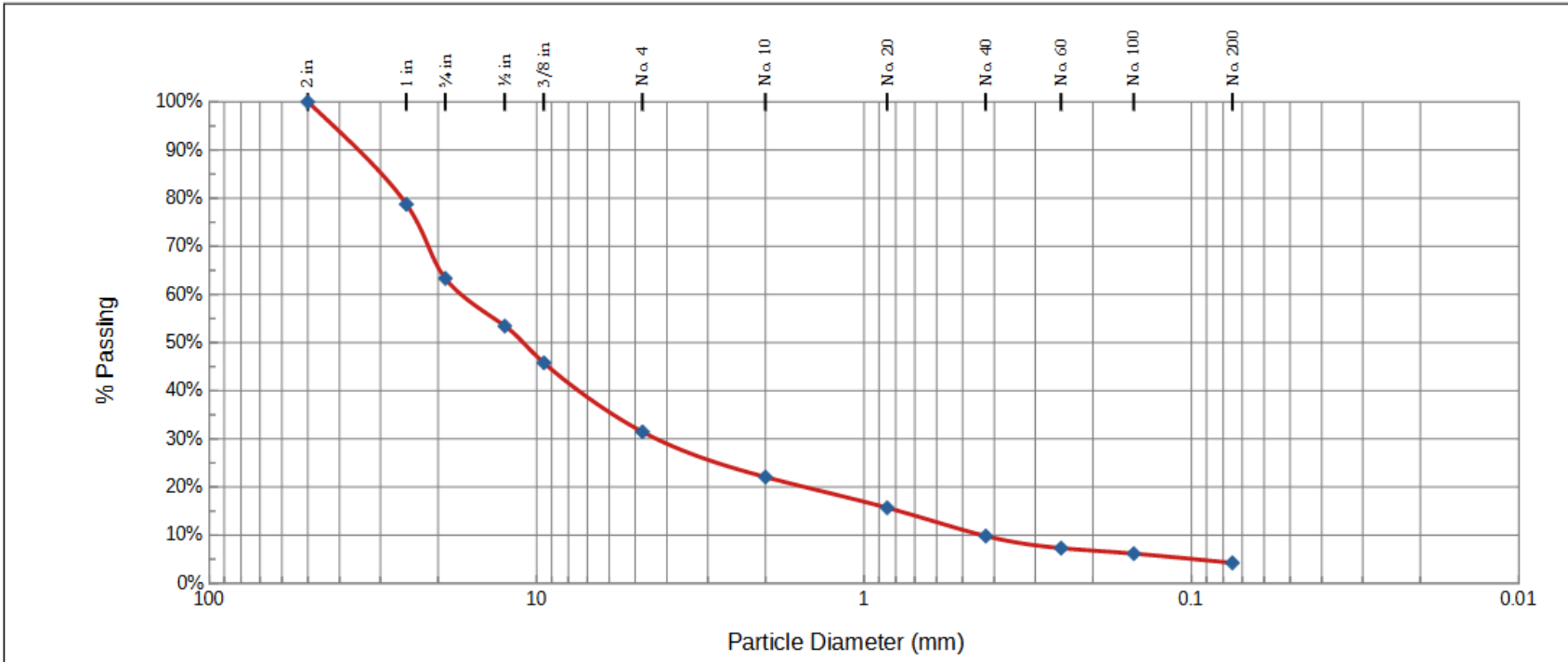

USCS Scale	Coarse Gravel		Fine Gravel			Coarse Sand		Medium Sand		Fine Sand			(% of Fines Passing #200 Sieve)			Sand Total	Gravel Total
	Sieve #	Diameter, mm	3/4"	1/2"	3/8"	4	10	20	40	60	100	200	0.060	0.050	0.002		
Retained	0.0%	21.3%	36.7%	46.6%	54.2%	68.5%	77.9%	84.3%	90.2%	92.7%	93.9%	95.8%	NA	NA	NA	27.2%	68.5%
Passing	100.0%	78.7%	63.3%	53.4%	45.8%	31.5%	22.1%	15.7%	9.8%	7.3%	6.1%	4.2%					

**Graph Values**

D90 38.24  
D60 16.82  
D30 4.324  
D10 0.439  
Coefficient of Uniformity: 3.89  
Coefficient of Gradation: 2.53  
CEC: 3.7 meq/100g  
OM (LOI 360): 1.8 %

Unified Soil Classification System (USCS) Description	
GP	POORLY GRADED GRAVEL with SAND

Staff Initials: T

Test Methods: ASTM D6913

January 8, 2025

April 15, 2020

AVT Services, LLC  
1633 S Geiger Street  
Tacoma, Washington 98465  
(253) 579-8018  
Vtcaci1978@yahoo.com

Geotechnical Engineering Report  
Proposed Multi-Family Development  
xxx- 7<sup>th</sup> Street Southwest  
Puyallup, Washington  
PN: 4320000160  
Doc ID: AVTServices.7thStSW.RG

## **INTRODUCTION**

This geotechnical engineering report summarizes our site observations, our subsurface explorations, geotechnical data review and engineering analyses, and provides geotechnical recommendations and design criteria for the proposed multi-family residential development to be constructed on the above referenced parcel. Our understanding of the project is based on our discussions with the project owner, Mr. Vladimir Tkach and the project Civil Engineer, Mr. Tres Kirkebo, our experience in the site area, and our understanding of the City of Puyallup Critical Areas and development codes. We understand the current proposal is to construct a multi-family residential development at the site that includes four new structures, and a paved parking area. We anticipate each new structure will be two to three stories, with 12 to 18 units each, and will be of wood frame construction founded on shallow spread footings. Additional development will include typical underground utilities and a stormwater facility. Based on the proposed site plan, we anticipate the stormwater facility will be constructed below grade, within the parking area.

## **SCOPE**

The scope of our services was to evaluate the surface and subsurface conditions across the site as a basis for developing recommendations and conclusions to aid in development of the site, including addressing potential geologic hazards and the potential for stormwater infiltration. Specifically, the scope of services included the following:

1. Reviewing the readily available geologic, hydrogeologic and geotechnical data for the site area;
2. Conducting a geologic reconnaissance of the site area;
3. Exploring the subsurface conditions by monitoring the excavation of six test pits at the site with a subcontracted backhoe to depths of 8 to 12 feet;
4. Collecting soil samples from the explorations and conducting two grain size analyses on selected samples;

5. Installing open standpipe piezometers at one test pit location to a depth of 10 feet.
6. Return to the site to collect water level data from the piezometer during the wet season
7. Addressing the appropriate criteria for potential geologic hazards per the current City of Puyallup Municipal Code (PMC) Chapter 21.06 Geologically Hazardous Areas;
8. Providing recommendations for development on or near sloping ground based on City of Puyallup development codes;
9. Providing recommended seismic design criteria, including seismic site class;
10. Providing geotechnical conclusions for shallow foundation design, including allowable bearing capacity;
11. Providing recommendations for earthwork including site preparation, fill placement and compaction and an evaluation of on-site materials for use as structural fill;
12. Performing one small scale pilot infiltration test (PIT) at the site;
13. Providing our evaluation of site drainage issues, including an evaluation of the feasibility of onsite infiltration of stormwater or the use of Low Impact Development best management practices;
14. Preparing a written Geotechnical *Engineering Report* summarizing our site observations and conclusions, and our geotechnical recommendations and design criteria, along with the supporting data.

The above scope of work was summarized in our Proposal for Geotechnical Engineering Services dated February 20, 2020. We received written authorization to proceed with our scope of services from you the same day.

## • SITE CONDITIONS

### Surface Conditions

The site is an unaddressed parcel located adjacent west of the existing single-family residence at 629 – 43<sup>rd</sup> Avenue southwest in Puyallup, Washington. Based on information obtained from Pierce County Public GIS the site is generally rectangular in shape, measures approximately 305 feet wide (north to south) by 240 feet deep (east to west) and encompasses approximately 1.67 acres. The site is bounded by existing multi-family residential development to the north, existing single-family residences to the west, 43<sup>rd</sup> Avenue Southwest to the south, and 7<sup>th</sup> Street Southwest to the east.

Based on topographic data obtained from the Pierce County Public GIS website and our site observations, other than a small open depression along 7<sup>th</sup> Street Southwest, the ground surface of the site generally slopes up in all directions towards the center of the site at 20 to 35 percent. These slopes truncate somewhat abruptly and then slope down towards the center of the site in all directions at 50 to more than 100 percent, forming a topographic depression approximately 6 to 12 feet in depth. Along the northern property boundary, the site slopes down to the north at 30 to 40 percent. This slope continues offsite and steepens to approximately 100 percent. Total topographic relief across the site is on the order of 14 to 18 feet. Topographic relief of the steep offsite slope is on the order of 14 to 32 feet. The existing site topography is shown on the Site and Exploration Map, Figure 2.

Vegetation across the site generally consists of a dense to very dense stand of mature conifers with a typical understory of native and invasive plants and shrubs. No areas of seeps, springs, or standing water were observed at the time of our reconnaissance. No areas of erosion or slope instability

were noted at the site at the time of our reconnaissance.

### **Site Soils**

The USDA Natural Resources Conservation Service (NRCS) Web Soil Survey maps the site as being underlain by Everett very gravelly sandy loam (13B) soils. The Everett very gravelly sandy loam soils are derived from sandy and gravelly glacial outwash, form on slopes of 0 to 8 percent, have a "slight" erosion hazard when exposed, and are included in hydrologic soils group A. A copy of the soils map for the site area is shown as Figure 3.

### **Site Geology**

The draft *Geologic Map of the Puyallup 7.5-minute Quadrangle, Washington* by K. W. Troost (in review) maps the site as being underlain by Steilacoom Gravel-Bradley Channel (Qvsb<sub>2</sub>). Steilacoom gravel is described as consisting of gravel and cobbles with lesser amounts of poorly to well sorted sand, deposited by episodic discharges from glacial Lake Puyallup. The Steilacoom gravel deposits are generally in a medium dense condition and considered normally consolidated. An excerpt of the above referenced geologic map is included as Figure 4.

### **Subsurface Explorations**

On February 22, 2020, a GeoResources geologist was on site and monitored the excavation of 6 test pits to a depth of 6 to 9.5 feet below existing ground surface. The test pit explorations were excavated by a small track-mounted machine (Cat 304) and operator provided by you. The specific number, locations, and depths of our explorations were selected by GeoResources personnel based on the configuration of the proposed development and were adjusted in the field based on site access limitations. Our exploration locations were limited by the dense spacing of mature conifers and steep slopes the track-mounted machine could not negotiate. Our geologist continuously monitored the explorations, maintained logs of the subsurface conditions encountered, obtained representative soil samples, and observed pertinent site features. The soil densities presented on the logs was based on the difficulty of excavation and our experience. Representative soil samples obtained from the explorations were placed in sealed containers and taken to our laboratory for further examination and testing as deemed necessary. Each test pit was then backfilled and bucket tamped in place, but not otherwise compacted.

The subsurface explorations excavated as part of this evaluation indicate the subsurface conditions at specific locations only, as actual subsurface conditions can vary across the site. Furthermore, the nature and extent of such variation would not become evident until additional explorations are performed or until construction activities have begun. Given the access limitations at the time of exploration, we recommend additional explorations are performed prior to final design or construction.

The soils encountered were visually classified in accordance with the Unified Soil Classification System (USCS) and ASTM D: 2488. The USCS is included in Appendix A as Figure A-1. The approximate locations of our explorations are indicated on the attached Site and Exploration Map, Figure 2, while the descriptive logs of our explorations and are included in Appendix A. The exploration locations were determined by taping, pacing, and estimating from permanent site features or by terrain association. The approximate elevation of each exploration was determined by interpolating between contours shown on Pierce County public GIS data. Accordingly, the locations and elevations of our explorations should only be considered accurate to the degree implied by our measurement methods.

### **Subsurface Conditions**

The soils encountered at the site generally consist of brown poorly graded gravel with silt and sand with some occasional cobbles and trace boulders in a medium dense to dense, moist condition. We interpret these soils to be consistent with gravelly recessional outwash soils. These soils were encountered in all of our test pits and were encountered to the full extent explored in test pits TP-2, TP-3, and TP-5. In test pits TP-1, TP-4, TP-6 we observed tan poorly graded sand in a medium dense, moist condition underlying the gravelly recessional outwash. We interpret these soils to be consistent with sandy recessional outwash. These soils were encountered to the full extent explored in test pits TP-1, TP-4, and TP-6. We interpret subsurface conditions to consist of three soil units: topsoil, gravelly recessional outwash, and sandy recessional outwash.

### **Laboratory Testing**

Geotechnical laboratory tests were performed on select samples retrieved from the borings and test pits to determine soil index and engineering properties encountered. Laboratory testing included visual soil classification per ASTM D: 2488, moisture content determinations per ASTM D: 2216, and grain size analyses per ASTM D: 6913 standard procedures. The results of the laboratory tests are included in Appendix B.

### **Groundwater Conditions**

No groundwater or evidence of groundwater was observed within the depth explored at the time of excavation. Based on the nature of the near surface soils, we anticipate fluctuations in the local groundwater levels may occur in response to precipitation patterns, off-site construction activities, and site utilization. Based on our experience in the area and our review of water well logs within the site vicinity, we anticipate that the regional groundwater table is many tens of feet below the existing ground surface.

## **ENGINEERING CONCLUSIONS AND RECOMMENDATIONS**

Based on the results of our data review, site reconnaissance, subsurface explorations and our experience in the area, it is our opinion that the site is suitable for the proposed development. Pertinent conclusions and geotechnical recommendations regarding the design and construction of the proposed development are presented below.

### **Landslide Hazards per PMC 21.06.1210(3)(b)**

The PMC defines landslide hazard areas as areas subject to landslides based on a combination of geologic, topographic, and hydrologic factors. They include any areas susceptible to landslide



because of any combination of bedrock, soil, slope (gradient), slope aspect, structure, hydrology, or other factors, and include, at a minimum, the following:

1. Areas of historic failures, such as:
  - a. Those areas delineated by the United States Department of Agriculture Natural Resources Conservation Service as having a significant limitation for building site development;
  - b. Those coastal areas mapped as class u (unstable), uos (unstable old slides), and urs (unstable recent slides) in the Department of Ecology Washington coastal atlas; or
  - c. Areas designated as quaternary slumps, earthflows, mudflows, lahars, or landslides on maps published by the United States Geological Survey or Washington Department of Natural Resources.
2. Areas with all three of the following characteristics:
  - a. Slopes steeper than 15 percent;
  - b. Hillsides intersecting geologic contacts with a relatively permeable sediment overlying a relatively impermeable sediment or bedrock; and
  - c. Springs or groundwater seepage.
3. Areas that have shown movement during the holocene epoch (from 10,000 years ago to the present) or which are underlain or covered by mass wastage debris of this epoch;
4. Slopes that are parallel or subparallel to planes of weakness (such as bedding planes, joint systems, and fault planes) in subsurface materials;
5. Slopes having gradients steeper than eighty percent subject to rockfall during seismic shaking
6. Areas potentially unstable as a result of rapid stream incision, stream bank erosion, and undercutting by wave action, including stream channel migration zones;
7. Areas that show evidence of, or are at risk from snow avalanches;
8. Areas located in a canyon or on an active alluvial fan, presently or potentially subject to inundation by debris flows or catastrophic flooding; and
9. Any area with a slope of 40 percent or steeper and with a vertical relief of 10 or more feet except areas composed of bedrock. A slope is delineated by establishing its toe and top and measured by averaging the inclination over at least 10 feet of vertical relief.

PMC Chapter 21.06.1210(3)(b) uses the above referenced 9 item checklist to define a landslide hazard area. Based on our observations of the site and review of published information, we offer the following comments.

No areas of the site are delineated by the United States Department of Agriculture Natural Resources Conservation Service as having a significant limitation for building site development. The site is not in a coastal area and is not mapped in the Washington Department of Ecology Coastal Atlas. No areas of the site or site area are designated as quaternary slumps, earthflows, mudflows, lahars, or landslides. No areas at the site are mapped as having shown movement during the Holocene epoch or underlain or covered by mass wastage debris. No planes of weakness, slopes steeper than 80 percent subject to rockfall during seismic shaking, areas potentially unstable as a result of rapid stream incision, stream bank erosion, and undercutting by wave action were observed at the site. The site is not at risk from snow avalanches, located in a canyon or active alluvial fan, subject to inundation by debris flow or catastrophic flooding. There are areas of slopes steeper than 40 percent with more than 10 feet of vertical relief.

Based on the above, the site exhibits one of above landslide hazard indicators on or within 200 feet of the site (slopes with inclinations greater than 40 percent with a vertical of relief of more than 10 feet. In accordance with PMC 21.06.1240, a 25-foot native vegetation buffer should be established from the top of any portion of the steep slope area in the northern portion of the site that is steeper than 40 percent with a vertical height of more than 10 feet. We anticipate the site will be regraded to a generally level condition to accommodate the development. Regrading should effectively reduce any hazard associated with these slopes. The slopes around the central depression have a vertical height of 10 feet or less. Accordingly, regrading should be allowed per PMC 21.06.1240.

### **Seismic Hazards per PMC 21.06.1210(3)(c)**

The PMC defines seismic hazard areas as “areas subject to severe risk of damage as a result of earthquake-induced ground shaking, slope failure, settlement, soil liquefaction, lateral spreading, or surface faulting. Settlement and soil liquefaction conditions occur in areas underlain by cohesionless, loose, or soft-saturated soils of low density, typically in association with a shallow ground water table”.

Liquefaction is a phenomenon where there is a reduction or complete loss of soil strength due to an increase in pore water pressure. The increase in pore water pressure is induced by seismic vibrations. Liquefaction mainly affects geologically recent deposits of loose, fine-grained sands that located below the groundwater table. The soils observed at the site generally consisted gravelly outwash soils. Additionally, the site is located within an area mapped as having a very low susceptibility to liquefaction. An excerpt from the published liquefaction susceptibility map for the site area is included as Figure 6. In our opinion, the potential for liquefaction and lateral spreading is not significant because of the gravelly nature of the on-site soils and lack of a shallow groundwater table.

The ground surface within the site boundaries consists of moderate slopes that we anticipate will be regraded to a generally level condition; therefore, the potential for earthquake-induced slope instability on the site is low. The prescriptive 25-foot native vegetation buffer should ameliorate the potential hazards of earthquake induced slope stability of the on and offsite northern steep slope. The site is approximately X miles from the nearest mapped location of the Tacoma fault and no evidence of ground fault rupture was observed during our site reconnaissance. Therefore, in our opinion the potential for ground surface fault rupture is also low.

### **Volcanic Hazards per PMC 21.06.1210(3)(d)**

The PMC defines volcanic hazard areas as “those areas subject to pyroclastic flows, lava flows, debris avalanche, and inundation by debris flows, lahars, mudflows, or related flooding resulting from volcanic activity”. Volcanic hazard areas shall be classified as Case I or Case II lahars, as identified in the report Sedimentology, Behavior, and Hazards of Debris Flows at Mount Rainier, Washington, U.S. Geological Survey Professional Paper 1547, 1995. The site is not mapped as being in an area of the lahar flow path from Mt Rainier, as mapped by the Washington Department of Natural Resources. Accordingly, the risk of inundation via lahar, mudflow, or lava flow should be considered low. An excerpt from The Volcanic Hazard Areas map (WA State DNR) for the site area is provided as Figure 7.

### **Recommended Setback**

Proposed structures may require a building setback from slopes steeper than 3H:1V (Horizontal: Vertical) percent to satisfy requirements of the International Building Code (IBC) Section

1805. The typical IBC setback from the top of the slope equals the lesser of one third the height of the slope or 40 feet unless evaluated and reduced, and/or a “structural setback” is provided, by a licensed geotechnical engineer. Based on the vertical height of the steep slope area north of the site, an IBC building setback of 5 to 12 feet would be required. However, it is our opinion the prescriptive 25-foot native vegetation buffer provides

### Seismic Design

Based on our observations and the subsurface units mapped at the site, we interpret the structural site conditions to correspond to a seismic Site Class “D” in accordance with the 2015 IBC documents and American Society of Civil Engineers (ASCE) standard 7-10 Chapter 20 Table 20.3-1. This is based on the soil types encountered in the site area. These conditions were assumed to be representative for the subsurface conditions for the site. The U.S. Geological Survey (USGS) completed probabilistic seismic hazard analyses (PSHA) for the entire country in November 1996, which were updated and republished in 2002 and 2008. We used the *ATC Hazard by Location* website to estimate seismic design parameters at the site. Table 1, below, summarizes the recommended design parameters.

**TABLE1:**  
**2015 IBC Parameters for Design of Seismic Structures**

Spectral Response Acceleration (SRA) and Site Coefficients	Short Period	1 Second Period
Mapped SRA	$S_s = 1.247$	$S_1 = 0.48$
Site Coefficients (Site Class C)	$F_a = 1.001$	$F_v = 1.52$
Maximum Considered Earthquake SRA	$S_{MS} = 1.248$	$S_{M1} = 0.729$
Design SRA	$S_{DS} = 0.832$	$S_{D1} = 0.486$

The mapped peak ground acceleration (PGA) for this site is 0.50g. To account for site class, the PGA is multiplied by a site amplification factor ( $F_{PGA}$ ) of 1.0. The resulting site modified peak ground acceleration ( $PGA_M$ ) is 0.50g. In general, estimating seismic earth pressures ( $k_h$ ) by the Mononobe-Okabe method or seismic inputs for slope stability analysis are taken as 30 to 50 percent of the  $PGA_M$ , or 0.15g to 0.25g.

### Foundation Support

Based on the subsurface conditions encountered at the locations explored, we recommend that spread footings be founded on the medium dense native gravelly recessional outwash soils, or on structural fill that extends to suitable native soils.

The soil at the base of the footing excavations should be disturbed as little as possible. All loose, soft or unsuitable material should be removed from the excavation. A representative from our firm should observe the foundation excavations to determine if suitable bearing surfaces have been prepared.

We recommend a minimum width of 24 inches for isolated footings and at least 16 inches for continuous wall footings. All footing elements should be embedded at least 18 inches below grade for frost protection. Footings founded on the native, undisturbed outwash soils or appropriately prepared structural fill can be designed using an allowable soil bearing capacity of 3,000 psf (pounds per square foot) for combined dead and long-term live loads. The weight of the footing and any overlying backfill may be neglected. The allowable bearing value may be increased by one-third for transient loads such as those induced by seismic events or wind loads.

Lateral loads may be resisted by friction on the base of footings and floor slabs and as passive pressure on the sides of footings. We recommend that an allowable coefficient of friction of 0.35 be used to calculate friction between the concrete and the underlying soil. Passive pressure may be determined using an allowable equivalent fluid density of 350 pcf (pounds per cubic foot). Factors of safety have been applied to these values.

We estimate that settlements of footings designed and constructed as recommended will be on the order of 1 inch for the anticipated load conditions, with differential settlements between comparably loaded footings of 1/2 inch or less over a span of 50 feet. Most of the settlements should occur essentially as loads are being applied. However, disturbance of the foundation subgrade during construction could result in larger settlements than predicted.

### **Floor Slab Support**

Slab-on-grade floors, where constructed, should be supported on the native outwash soils or appropriately prepared structural fill.

We recommend that floor slabs be directly underlain by a minimum 6-inch thickness capillary break material such as coarse sand, pea gravel, or crushed rock containing less than 2 percent fines. The capillary break material should be placed in one lift and compacted to an unyielding condition.

A synthetic vapor retarder is recommended to control moisture migration through the slabs. This is of particular importance where the foundation elements are underlain by the silty alluvial subgrade, or where moisture migration through the slab is an issue, such as where adhesives are used to anchor carpet or tile to the slab or where slabs are present below heated, enclosed spaces.

A subgrade modulus of 300 pci (pounds per cubic inch) may be used for floor slab design. We estimate that settlement of the floor slabs designed and constructed as recommended, will be 1/2-inch or less over a span of 50 feet.

### **Subgrade/Basement Walls**

Adequate drainage behind retaining structures is imperative. Positive drainage can be accomplished by placing a zone of drainage behind the walls. Granular drainage material should contain less than 2 percent fines and at least 30 percent greater than the US No. 4 sieve. A geocomposite drain mat may also be used instead of free draining soils, provided it is installed in accordance with the manufacturer's instructions. The soil drainage zone should extend horizontally at least 18 inches from the back of the wall and extend from the base of the wall to within 1 foot of the top of the wall. The soil drainage zone should be compacted to approximately 90 percent of the MDD (maximum dry density) as determined by ASTM D: 1557. Over-compaction should be avoided as this can lead to excessive lateral pressures. Typical wall drainage and backfilling details are shown in Figure 4. Recommended earth pressures for the native and fill soils are shown in Figure 5.

A minimum 4-inch diameter perforated or slotted PVC pipe should be placed in the drainage zone along the base and behind the wall to provide an outlet for accumulated water and direct accumulated water to an appropriate discharge location. We recommend that a nonwoven geotextile filter fabric be placed between the soil drainage material and the remaining wall backfill to reduce silt migration into the drainage zone. The infiltration of silt into the drainage zone can, with time, reduce the permeability of the granular material. The filter fabric should be placed such that it fully separates the drainage material and the backfill and should be extended over the top of the drainage zone.

For walls backfilled with granular well-drained soil and a level backslope, the design active pressure may be taken as 35 pcf (equivalent fluid density). For walls that are braced or otherwise restrained, the design active pressure may be taken as 55 pcf. For the condition of an inclined back slope, higher lateral pressures would act on the walls. For a 3H:1V (Horizontal to Vertical) slope above the wall, the active pressure may be taken as 48 pcf; for a 2H:1V back slope condition, a wall design pressures of 55 pcf may be assumed. If basement walls taller than 6 feet are required, as seismic surcharge of 10H should be included where required by the code. If walls will be constructed with a backslope and will be braced or otherwise restrained against movement, we should be notified so that we can evaluate the anticipated conditions and recommend an appropriate at-rest earth pressure.

Lateral loads may be resisted by friction on the base of footings and as passive pressure on the sides of footings and the buried portion of the wall, as described in the “**Foundation Support**” section.

### **Temporary Excavations**

All job site safety issues and precautions are the responsibility of the contractor providing services/work. The following cut/fill slope guidelines are provided for planning purposes only. Temporary cut slopes will likely be necessary during grading operations or utility installation. All excavations at the site associated with confined spaces, such as utility trenches and retaining walls, must be completed in accordance with local, state, or federal requirements including Washington Administrative Code (WAC) and Washington Industrial Safety and Health Administration (WISHA). Excavation, trenching, and shoring is covered under WAC 296-155 Part N.

Based on WAC 296-155-66401, it is our opinion that the medium dense recessional and outwash soils on the site would be classified as Type C soils. According to WAC 296-155-66403, for temporary excavations of less than 20 feet in depth, the side slopes in Type C soils should be sloped at a maximum inclination of 1½H:1V or flatter from the toe to top of the slope. All exposed slope faces should be covered with a durable reinforced plastic membrane during construction to prevent slope raveling and rutting during periods of precipitation. These guidelines assume that all surface loads are kept at a minimum distance of at least one half the depth of the cut away from the top of the slope and that significant seepage is not present on the slope face. Flatter cut slopes will be necessary where significant raveling or seepage occurs, or if construction materials will be stockpiled along the slope crest.

Where it is not feasible to slope the site soils back at these inclinations, a retaining structure should be considered. Retaining structures greater than 4-feet in height (bottom of footing to top of structure) or that have slopes of greater than 15 percent above them, should be engineered per Washington Administrative Code (WAC 51-16-080 item 5). This information is provided solely for the benefit of the owner and other design consultants, and should not be construed to imply that GeoResources assumes responsibility for job site safety. It is understood that job site safety is the sole responsibility of the project contractor.

## Site Drainage

All ground surfaces, pavements and sidewalks at the site should be sloped away from the structures. Surface water runoff should be controlled by a system of curbs, berms, drainage swales, and or catch basins, and conveyed to an appropriate discharge point.

We recommend that footing drains are installed for the development in accordance with IBC 1805.4.2, and basement walls (if utilized) have a wall drain as describe above. The roof drain should not be connected to the footing drain.

## Stormwater Infiltration

The City of Puyallup uses the Department of Ecology's (Ecology) Stormwater Management Manual for Western Washington. We reviewed the *2012 Stormwater Management Manual for Western Washington, as Amended in December 2014 (2014 SWMMWW)*.

Per the *2014 SWMMWW*, Volume III, Section 3.3.7, *Site Selection Criteria-5*, a minimum of 5 feet of separation is required between the bottom of a proposed infiltration facility and the top of seasonal high groundwater, bedrock, or other low permeability layer. No evidence of seasonal high groundwater was observed in our subsurface explorations. Based on our review of the above referenced documents, our subsurface explorations, and our laboratory testing, it is our opinion that stormwater infiltration is feasible onsite.

### Test Method

For the purposes of this project we used the small-scale pilot infiltration test method as defined by (2014 SWMMWW).

### Preliminary Design Infiltration Rate

The design infiltration rate is determined based on the procedure provided in Volume III, Appendix III section 3.3.6 of the 2014 SWMMWW. Three correction factors are applied to the measured infiltration rate to account for site variability ( $CF_y$ ), test method used ( $CF_t$ ), and influent control to prevent siltation and bio-buildup ( $CF_m$ ). The design infiltration rate is determined as follows:

$$I_{design} = I_{measured} * CF_y * CF_t * CF_m$$

Where:

$I_{design}$  = Infiltration rate to be used for design of infiltration facility

$I_{measured}$  = Infiltration rate measured in the field or estimated by grain size analysis

$CF_y$  = Accounts for number of tests relative to infiltration area and site variability (0.33 to 1)

$CF_t$  = Test method used (Small Scale PIT = 0.5)

$CF_m$  = Degree of influent control to prevent siltation and bio-buildup (0.9)

Based on our observations, we used a value of 0.5 for  $CF_y$ , a value of 0.5 for  $CF_t$ , and a value of 0.9 for  $CF_m$ . Applying these correction factors to the measured infiltration rate, as outlined in Volume III, Section 3.3.6 of the 2014 SWMMWW results in a preliminary long-term (design) infiltration rates. Based on the sample collected and our analysis, we recommend using a **preliminary long-term design rate of 2.0 inches per hour**. Additional information regarding preliminary infiltration rates is included in Appendix C.

For the purposes of estimating a preliminary infiltration and to reflect the early design stages of the project, we selected relatively conservative correction factors. It is possible, that during the design process these values may be reduced potentially resulting in a higher design infiltration rate.

### Construction Considerations

We recommend that a representative from our firm be onsite at the time of excavation of the proposed infiltration facilities to verify that the soils encountered during construction are consistent with the soils observed in our subsurface explorations. Verification infiltration testing should also be performed at the time of construction to verify the recommended infiltration rate per the 2014 SWMMWW.

Appropriate design, construction and maintenance measures will be required to ensure the infiltration rate can be effectively maintained over time. Appropriate temporary erosion and sediment control methods should be included in the project plans and specifications to minimize the potential for fines contamination of infiltration facility utilized at the site. To further reduce the potential for fines migration, the infiltration system should not be connected to the stormwater runoff system until after construction is complete and the site area is landscaped, paved or otherwise protected.

Additional measures may also be taken during construction to minimize the potential of fines contamination of the proposed infiltration system, such as utilizing an alternative storm water management location during construction or leaving the bottom of the permanent systems 1 to 2 feet high, and subsequently excavating to the finished grade once the site soils have been stabilized. All contractors working on the site (builders and subcontractors) should divert sediment laden stormwater away from proposed infiltration facilities during construction and landscaping activities. No concrete trucks should be washed or cleaned, and washout areas should not be within the vicinity of the proposed infiltration facilities. After construction activities have been completed, periodic sweeping of the paved areas will help extend the life of the infiltration system.

## **EARTHWORK RECOMMENDATIONS**

### **Site Preparation**

All structural areas on the site to be developed should be stripped of vegetation, organic surface soils, and other deleterious materials including existing structures, foundations or abandoned utility lines. Organic topsoil is not suitable for use as structural fill, but may be used for limited depths in non-structural areas. Stripping depths ranging from 8 to 16 inches should be expected to remove these unsuitable soils. Areas of thicker topsoil or organic debris may be encountered in areas of heavy vegetation or depressions. Initial estimation of stripping depths should consider the limitations of the initial subsurface exploration program and contingencies should be incorporated into the grading plan and bid documents for the project until additional explorations can be completed.

Where placement of fill material is required, the stripped/exposed subgrade areas should be compacted to a firm and unyielding surface prior to placement of any fill. Excavations for debris removal should be backfilled with structural fill compacted to the densities described in the **"Structural Fill"** section of this report.

We recommend that a member of our staff evaluate the exposed subgrade conditions after removal of vegetation and topsoil stripping is completed and prior to placement of structural fill. The exposed subgrade soil should be proof-rolled with heavy rubber-tired equipment during dry weather or probed with a 1/2-inch-diameter steel rod during wet weather conditions.

Soft, loose or otherwise unsuitable areas delineated during proofrolling or probing should be recompacted, if practical, or over-excavated and replaced with structural fill. The depth and extent of overexcavation should be evaluated by our field representative at the time of construction. The areas of old fill material should be evaluated during grading operations to determine if they need mitigation; recompaction or removal.

### **Structural Fill**

All material placed as fill associated with mass grading, as utility trench backfill, under building areas, or under roadways should be placed as structural fill. The structural fill should be placed in horizontal lifts of appropriate thickness to allow adequate and uniform compaction of each lift. Structural fill should be compacted to at least 95 percent of MDD as determined in accordance with ASTM D: 1557.

The appropriate lift thickness will depend on the structural fill characteristics and compaction equipment used. We recommend that the appropriate lift thickness be evaluated by our field representative during construction. We recommend that our representative be present during site grading activities to observe the work and perform field density tests.

The suitability of material for use as structural fill will depend on the gradation and moisture content of the soil. As the amount of fines (material passing US No. 200 sieve) increases, soil becomes increasingly sensitive to small changes in moisture content and adequate compaction becomes more difficult to achieve. During wet weather, we recommend use of well-graded sand and gravel with less than 5 percent (by weight) passing the US No. 200 sieve based on that fraction passing the 3/4-inch sieve, such as *Gravel Backfill for Walls* (WSDOT 9-03.12(2)). If prolonged dry weather prevails during the earthwork and foundation installation phase of construction, higher fines content (up to 10 to 12 percent) may be acceptable.

Material placed for structural fill should be free of debris, organic matter, trash, and cobbles greater than 6-inches in diameter. The moisture content of the fill material should be adjusted as necessary for proper compaction.

### **Suitability of On-Site Materials as Fill**

During dry weather construction, non-organic on-site soil may be considered for use as structural fill; provided it meets the criteria described above in the "**Structural Fill**" section and can be compacted as recommended. If the moisture content of the soil material is over-optimum when excavated, it will be necessary to aerate or dry the soil prior to placement as structural fill. We generally did not observe the site soils to be excessively moist at the time of our subsurface exploration program.

The native gravelly outwash at the site generally consisted of gravel with sand. These soils are generally comparable to *Common Borrow* (WSDOT) 9-03.14(3). According to our grain size analysis, the outwash soils had a fines content of approximately 0.7 to 5.4 percent. These soils should be suitable for use as structural fill provided the moisture content is maintained within 3 percent of the optimum moisture level. Because of the low fines content and gravelly nature of the outwash soils, these soils are considered moderately moisture sensitive and should be suitable for reuse in a wider range of moisture conditions and periods of wet weather.

We recommend that completed graded-areas be restricted from traffic or protected prior to wet weather conditions. The graded areas may be protected by paving, placing asphalt-treated base,



a layer of free-draining material such as pit run sand and gravel or clean crushed rock material containing less than 5 percent fines, or some combination of the above.

### **Erosion Control**

Weathering, erosion and the resulting surficial sloughing and shallow land sliding are natural processes. As noted, no evidence of surficial raveling or sloughing was observed at the site. To manage and reduce the potential for these natural processes, we recommend erosion protection measures will need to be in place prior to grading activity on the site. Erosion hazards can be mitigated by applying Best Management Practices (BMP's).

### **Wet Weather and Wet Condition Considerations**

In the Puget Sound area, wet weather generally begins about mid-October and continues through about May, although rainy periods could occur at any time of year. Therefore, it is strongly encouraged that earthwork be scheduled during the dry weather months of June through September. Most of the soil at the site contains sufficient fines to produce an unstable mixture when wet. Such soil is highly susceptible to changes in water content and tends to become unstable and impossible to proof-roll and compact if the moisture content exceeds the optimum.

In addition, during wet weather months, the groundwater levels could rise, resulting in seepage into site excavations. Performing earthwork during dry weather would reduce these problems and costs associated with rainwater, construction traffic, and handling of wet soil. However, should wet weather/wet condition earthwork be unavoidable, the following recommendations are provided:

- The ground surface in and surrounding the construction area should be sloped as much as possible to promote runoff of precipitation away from work areas and to prevent ponding of water.
- Work areas or slopes should be covered with plastic. The use of sloping, ditching, sumps, dewatering, and other measures should be employed as necessary to permit proper completion of the work.
- Earthwork should be accomplished in small sections to minimize exposure to wet conditions. That is, each section should be small enough so that the removal of unsuitable soils and placement and compaction of clean structural fill could be accomplished on the same day. The size of construction equipment may have to be limited to prevent soil disturbance. It may be necessary to excavate soils with a backhoe, or equivalent, and locate them so that equipment does not pass over the excavated area. Thus, subgrade disturbance caused by equipment traffic would be minimized.
- Fill material should consist of clean, well-graded, sand and gravel, of which not more than 5 percent fines by dry weight passes the No. 200 mesh sieve, based on wet-sieving the fraction passing the ¾-inch mesh sieve. The gravel content should range from between 20 and 50 percent retained on a No. 4 mesh sieve. The fines should be non-plastic.
- No exposed soil should be left uncompacted and exposed to moisture. A smooth-drum vibratory roller, or equivalent, should roll the surface to seal out as much water as possible.
- In-place soil or fill soil that becomes wet and unstable and/or too wet to suitably compact should be removed and replaced with clean, granular soil (see gradation requirements above).

- Excavation and placement of structural fill material should be observed on a full-time basis by a geotechnical engineer (or representative) experienced in wet weather/wet condition earthwork to determine that all work is being accomplished in accordance with the project specifications and our recommendations.
- Grading and earthwork should not be accomplished during periods of heavy, continuous rainfall.

We recommend that the above requirements for wet weather/wet condition earthwork be incorporated into the contract specifications.

### **LIMITATIONS**

We have prepared this report for use by AVT Services LLC, and other members of the design team, for use in the design of a portion of this project. The data used in preparing this report and this report should be provided to prospective contractors for their bidding or estimating purposes only. Our report, conclusions and interpretations are based on our subsurface explorations, data from others and limited site reconnaissance, and should not be construed as a warranty of the subsurface conditions.

Variations in subsurface conditions are possible between the explorations and may also occur with time. A contingency for unanticipated conditions should be included in the budget and schedule. Sufficient monitoring, testing and consultation should be provided by our firm during construction to confirm that the conditions encountered are consistent with those indicated by the explorations, to provide recommendations for design changes should the conditions revealed during the work differ from those anticipated, and to evaluate whether earthwork and foundation installation activities comply with contract plans and specifications.

The scope of our services does not include services related to environmental remediation and construction safety precautions. Our recommendations are not intended to direct the contractor's methods, techniques, sequences or procedures, except as specifically described in our report for consideration in design.

If there are any changes in the loads, grades, locations, configurations or type of facilities to be constructed, the conclusions and recommendations presented in this report may not be fully applicable. If such changes are made, we should be given the opportunity to review our recommendations and provide written modifications or verifications, as appropriate.



We have appreciated the opportunity to be of service to you on this project. If you have any questions or comments, please do not hesitate to call at your earliest convenience.

Respectfully submitted,  
GeoResources, LLC

Davis Carlsen  
Staff Geologist

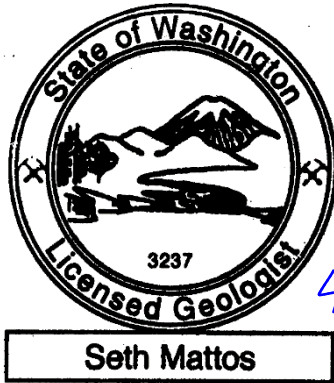

4/15/2020

Seth Mattos, LG  
Senior Geologist



4/15/2020

Eric W. Heller, PE, LG  
Senior Geotechnical Engineer

STM:EWH/dc

DocID:AVTServices.7thStSW.RG

Attachments:

- Figure 1: Site Location Map
- Figure 2: Site and Exploration Map
- Figure 3: NRCS Soils Map
- Figure 4: Geologic Map
- Figure 5: WA DNR Landslide Susceptibility Map
- Figure 6: Liquefaction Susceptibility Map
- Figure 7: WA DNR Volcanic Hazards Map
- Appendix "A" - Subsurface Explorations
- Appendix "B" - Laboratory Test results



**Approximate Site Location**

Map created from Pierce County Public GIS (<https://matterhornwab.co.pierce.wa.us/publicgis/>)

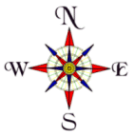

Not to Scale



**Site Location Map**  
 Proposed Multi-family Development  
 xxx - 7<sup>th</sup> Street SW  
 Puyallup, Washington  
 PN: 4320000160

DocID: AVTServices.7thStSW.F

April 2020

Figure 1



Map created from Pierce County Public GIS  
 (<https://matterhornwab.co.pierce.wa.us/publicgis/>)

 Number and approximate location of test pit



**Site and Exploration Map**  
 Proposed Multi-family Development  
 xxx - 7<sup>th</sup> Street SW  
 Puyallup, Washington  
 PN: 4320000160

Doc ID: AVTServices.7thStSW.F

April 2020

Figure 2



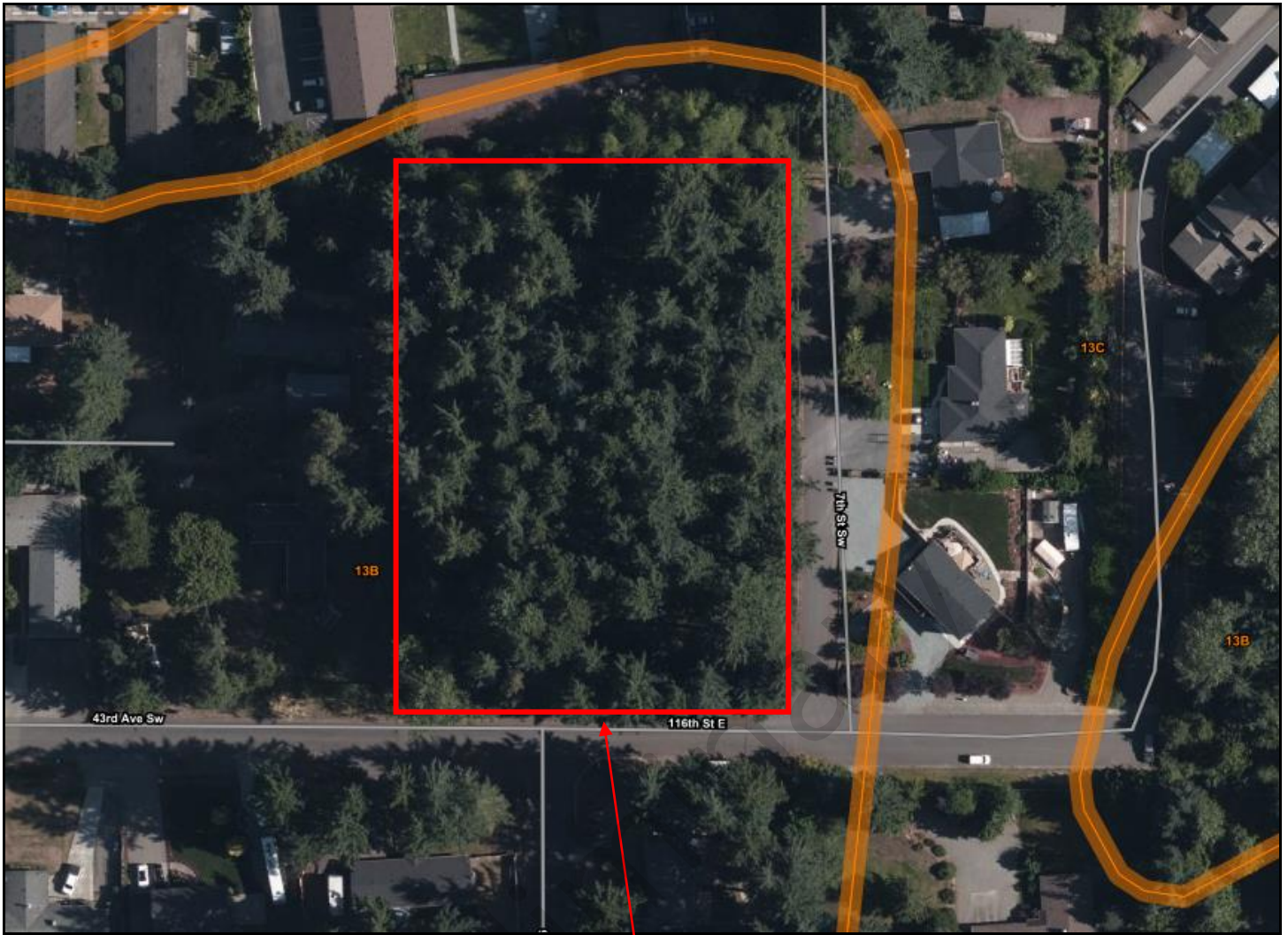

**Approximate Site Location**

Map created from Web Soil Survey (<http://websoilsurvey.sc.egov.usda.gov/App/WebSoilSurvey.aspx>)

Soil Type	Soil Name	Parent Material	Slopes	Erosion Hazard	Hydrologic Soils Group
13B	Everett very gravelly sandy loam	Sandy and gravelly glacial outwash	0 to 8	Slight	A
13C			8 to 15	Slight to moderate	

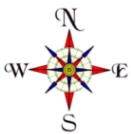

Not to Scale



**NRCS Soils Map**  
 Proposed Multi-family Development  
 xxx - 7<sup>th</sup> Street SW  
 Puyallup, Washington  
 PN: 4320000160

Doc ID: AVTServices.7thStSW.F

April 2020

Figure 3

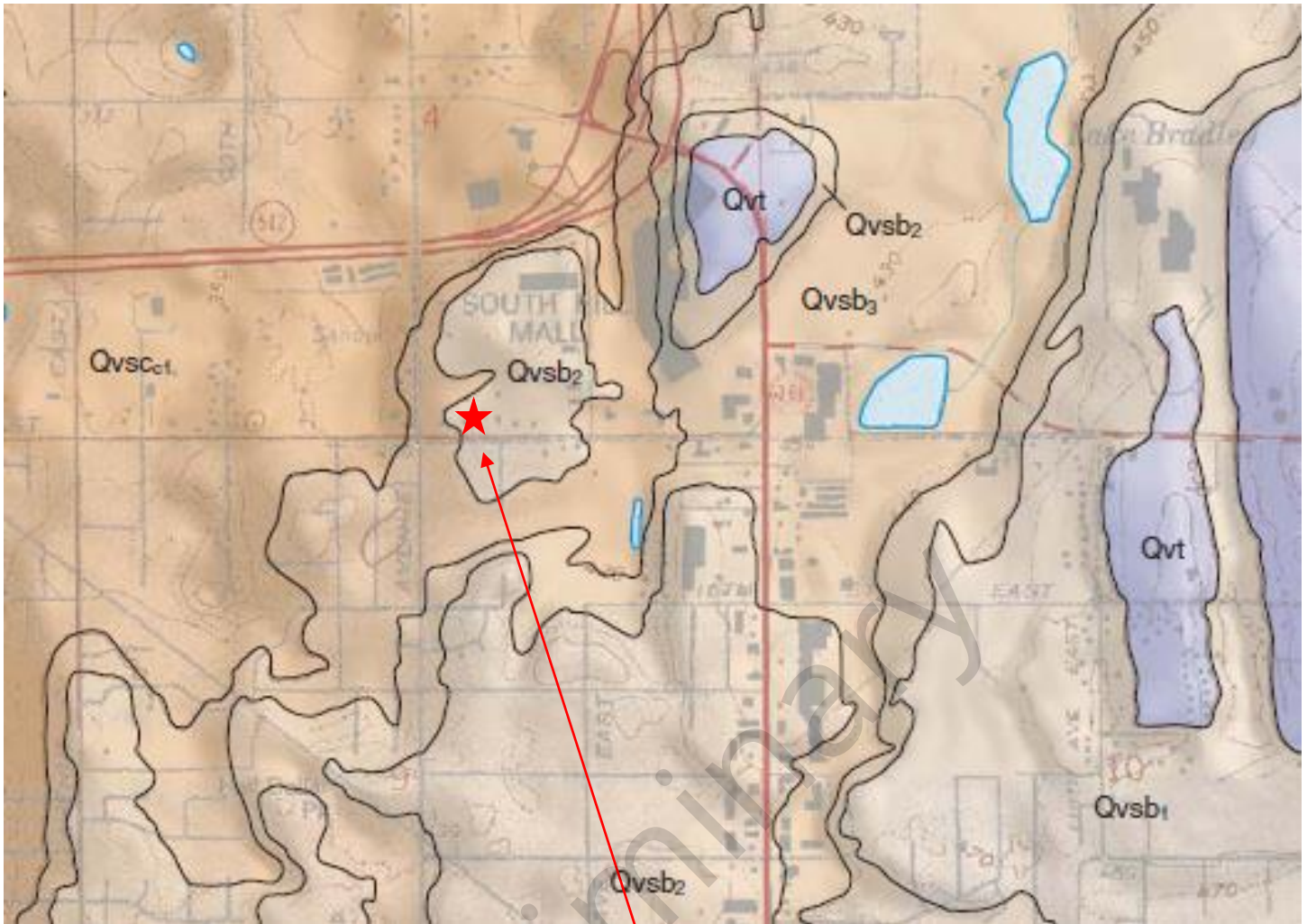

**Approximate Site Location**

An excerpt from the draft *Geologic Map of the Puyallup 7.5-minute Quadrangle, Washington*, by Troost, K.G.

Qvsb <sub>3</sub>	Steilacoom Gravel-Bradley Channel
Qvsb <sub>2</sub>	Steilacoom Gravel-Bradley Channel
Qvsc <sub>1</sub>	Steilacoom Gravel-Clover Creek Channel

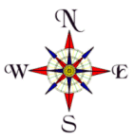

Not to Scale



**Geologic Map**  
 Proposed Multi-family Development  
 xxx - 7<sup>th</sup> Street SW  
 Puyallup, Washington  
 PN: 4320000160

Doc ID: AVTServices.7thStSW.F

April 2020

Figure 4





**Shallow Susceptibility**

- Moderate
- High

**Deep Susceptibility**

- Moderate
- High

**Approximate Site Location**

Map created from the Washington State Department of Natural Resources Landslide Inventory  
 (Information Portal <https://geologyportal.dnr.wa.gov/>)

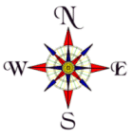

Not to Scale



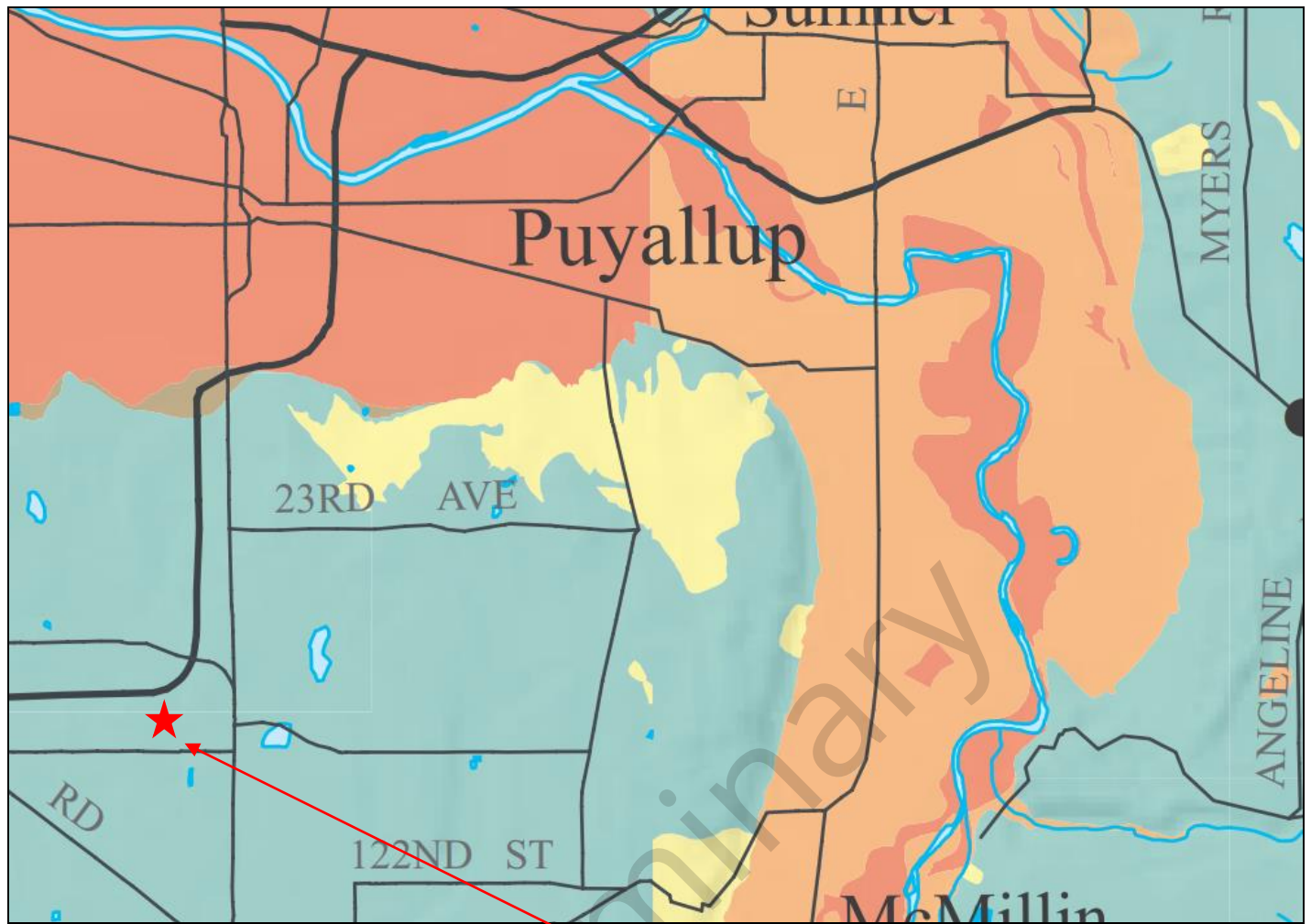

**Approximate Site Location**

An excerpt from the *Liquefaction Susceptibility Map of Pierce County, Washington* by Palmer, et al. (2004)

**EXPLANATION**

- Liquefaction susceptibility: HIGH
- Liquefaction susceptibility: MODERATE to HIGH
- Liquefaction susceptibility: MODERATE
- Liquefaction susceptibility: LOW to MODERATE
- Liquefaction susceptibility: LOW
- Liquefaction susceptibility: VERY LOW to LOW
- Liquefaction susceptibility: VERY LOW

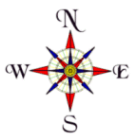

Not to Scale

**Liquefaction Susceptibility Map**

Proposed Multi-family Development

xxx - 7<sup>th</sup> Street SW

Puyallup, Washington

PN: 4320000160

**GEORESOURCES**  
 earth science & geotechnical engineering  
 5007 Pacific Hwy E., Suite 16 | Fife, WA 98424 | 253.896.1011 | www.georesources.rocks

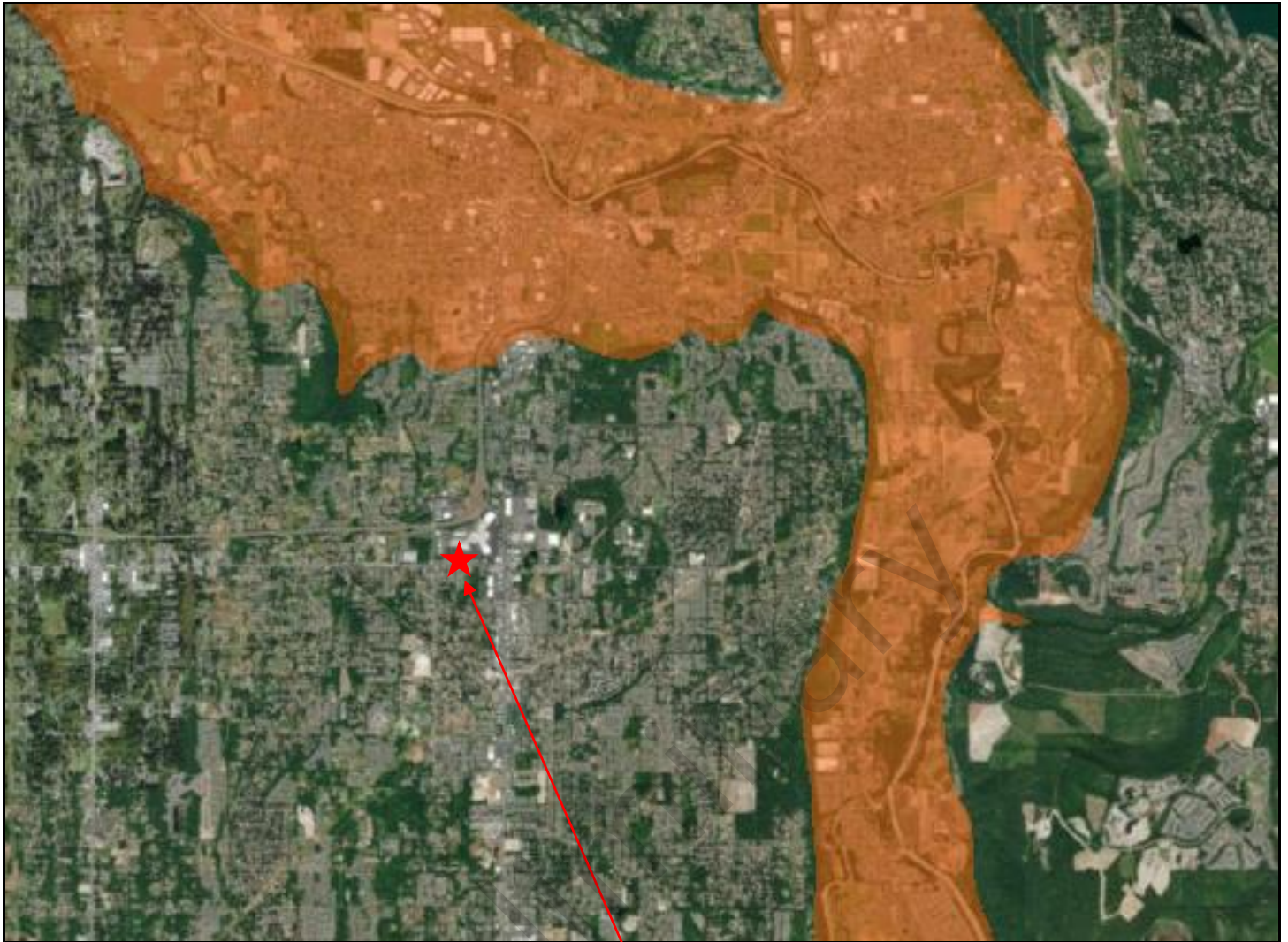

**Approximate Site Location**

Map created from the Washington State Department of Natural Resources Volcanic Hazards Map  
 (Information Portal [https:// geologyportal.dnr.wa.gov/](https://geologyportal.dnr.wa.gov/))

■ Lahars

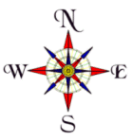

Not to Scale

**Appendix A**  
Subsurface Explorations

preliminary

# SOIL CLASSIFICATION SYSTEM

MAJOR DIVISIONS			GROUP SYMBOL	GROUP NAME
<b>COARSE GRAINED SOILS</b>  More than 50% Retained on No. 200 Sieve	GRAVEL  More than 50% Of Coarse Fraction Retained on No. 4 Sieve	CLEAN GRAVEL	GW	WELL-GRADED GRAVEL, FINE TO COARSE GRAVEL
			GP	POORLY-GRADED GRAVEL
		GRAVEL WITH FINES	GM	SILTY GRAVEL
			GC	CLAYEY GRAVEL
	SAND  More than 50% Of Coarse Fraction Passes No. 4 Sieve	CLEAN SAND	SW	WELL-GRADED SAND, FINE TO COARSE SAND
			SP	POORLY-GRADED SAND
		SAND WITH FINES	SM	SILTY SAND
			SC	CLAYEY SAND
<b>FINE GRAINED SOILS</b>  More than 50% Passes No. 200 Sieve	SILT AND CLAY  Liquid Limit Less than 50	INORGANIC	ML	SILT
			CL	CLAY
	SILT AND CLAY  Liquid Limit 50 or more	INORGANIC	MH	SILT OF HIGH PLASTICITY, ELASTIC SILT
			CH	CLAY OF HIGH PLASTICITY, FAT CLAY
		ORGANIC	OH	ORGANIC CLAY, ORGANIC SILT
			HIGHLY ORGANIC SOILS	

**NOTES:**

1. Field classification is based on visual examination of soil in general accordance with ASTM D2488-90.
2. Soil classification using laboratory tests is based on ASTM D6913.
3. Description of soil density or consistency are based on interpretation of blow count data, visual appearance of soils, and or test data.

**SOIL MOISTURE MODIFIERS:**

- Dry- Absence of moisture, dry to the touch
- Moist- Damp, but no visible water
- Wet- Visible free water or saturated, usually soil is obtained from below water table



**Unified Soils Classification System**

Proposed Multi-family Development  
 xxx - 7<sup>th</sup> Street SW  
 Puyallup, Washington  
 PN: 4320000160



### Test Pit TP-1

Location: Eastern extent of site  
Approximate Elevation: 460 feet (NAVD88)

Depth (ft)	Soil Type	Soil Description
0.0 - 1.25	-	Dark brown topsoil/forest duff (loose, moist)
1.25 - 3.5	GP	Light brown to orange-brown sandy GRAVEL with silt to silty GRAVEL with sand (medium dense, moist) (recessional outwash)
3.5 - 8.5	SP	Tan gravelly SAND with trace cobbles (medium dense, moist) (recessional outwash)

Terminated at 8.5 feet below the existing ground surface.  
No iron oxide staining observed at time of excavation  
No caving observed at time of excavation  
No groundwater seepage observed at time of excavation

### Test Pit TP-2

Location: Southeast corner of site  
Approximate Elevation: 464 feet (NAVD88)

Depth (ft)	Soil Type	Soil Description
0.0 - 1.0	-	Dark brown topsoil/forest duff (loose, moist)
1.0 - 2.5	GP	Orange-reddish brown poorly graded GRAVEL with silt and sand (medium dense, moist) (recessional outwash)
2.5 - 7.5	GP	Orange-reddish brown poorly graded GRAVEL with silt and sand, occasional cobble, trace boulders (medium dense to dense, moist) (recessional outwash)

Terminated at 7.5feet below the existing ground surface.  
No iron oxide staining observed at the time of excavation.  
No caving observed at the time of excavation.  
No groundwater seepage observed at the time of excavation.

Logged by: STM

Excavated on: February 20, 2020



### Test Pit Logs

Proposed Multi-family Development  
xxx - 7<sup>th</sup> Street SW  
Puyallup, Washington  
PN: 4320000160

Doc ID: AVTServices.7thStSW.F

April 2020

Figure A-2

### Test Pit TP-3

Location: Southern extent of site  
Approximate Elevation: 456 feet (NAVD88)

Depth (ft)	Soil Type	Soil Description
0.0 - 1.0	-	Dark brown topsoil/forest duff (loose, moist)
1.0 - 3.0	GP	Orange-reddish brown poorly graded GRAVEL with silt and sand (medium dense, moist) (recessional outwash)
2.0 - 6.0	GP	Orange-reddish brown poorly graded GRAVEL with silt and sand, occasional cobble, trace boulders (medium dense to dense, moist) (recessional outwash)

Terminated at 6.0 feet below the existing ground surface.  
No iron oxide staining observed at the time of excavation.  
No caving observed at the time of excavation.  
No groundwater seepage observed at the time of excavation.

### Test Pit TP-4

Location: Southwest portion of site  
Approximate Elevation: 456 feet (NAVD88)

Depth (ft)	Soil Type	Soil Description
0.0 - 1.0	-	Dark brown topsoil/forest duff (loose, moist)
1.0 - 2.5	GP	Weathered dark brown poorly graded GRAVEL with silt and sand (medium dense, moist) (recessional outwash)
2.5 - 4.0	GP	Brown poorly graded GRAVEL with silt and sand, occasional cobble, trace boulders (medium dense to dense, moist) (recessional outwash)
4.0 - 7.5	SP	Tan poorly graded SAND (medium dense, moist) (recessional outwash)

Terminated at 7.5 feet below the existing ground surface.  
No iron oxide staining observed at the time of excavation.  
No caving observed at the time of excavation.  
No groundwater seepage observed at the time of excavation.

Logged by: STM

Excavated on: February 20, 2020



**Test Pit Logs**  
Proposed Multi-family Development  
xxx - 7<sup>th</sup> Street SW  
Puyallup, Washington  
PN: 4320000160

Doc ID: AVTServices.7thStSW.F

April 2020

Figure A-3

### Test Pit TP-5

Location: Northeast corner of the site  
Approximate Elevation: 458 feet (NAVD88)

Depth (ft)	Soil Type	Soil Description
0.0 - 0.75	-	Dark brown topsoil/forest duff (loose, moist)
0.75 - 2.5	GP	Weathered dark brown poorly graded GRAVEL with silt and sand (medium dense, moist) (recessional outwash)
2.5 - 9.5	GP	Brown poorly graded GRAVEL (Medium dense to dense, moist) (recessional outwash)

Terminated at 9.5 feet below the existing ground surface.  
No iron oxide staining observed at the time of excavation.  
No caving observed at the time of excavation.  
No groundwater seepage observed at the time of excavation.

### Test Pit TP-6

Location: Eastern edge of site  
Approximate Elevation: 460 feet (NAVD88)

Depth (ft)	Soil Type	Soil Description
0.0 - 0.75	-	Dark brown topsoil/forest duff (loose, moist)
0.75 - 4.0	GP	Orange brown GRAVEL with sand (medium dense, moist) (recessional outwash)
1.8 - 9.0	SP	Tan fine to medium sand (medium dense, moist) (recessional outwash)

Terminated at 9.0 feet below the existing ground surface.  
No iron oxide staining observed at the time of excavation.  
No caving observed at the time of excavation.  
No groundwater seepage observed at the time of excavation.

Logged by: STM

Excavated on: February 20, 2020



### Test Pit Logs

Proposed Multi-family Development  
xxx - 7<sup>th</sup> Street SW  
Puyallup, Washington  
PN: 4320000160

Doc ID: AVTServices.7thStSW.F

April 2020

Figure A-4

**Appendix B**  
Laboratory Test Results

preliminary



# Particle Size Distribution Report

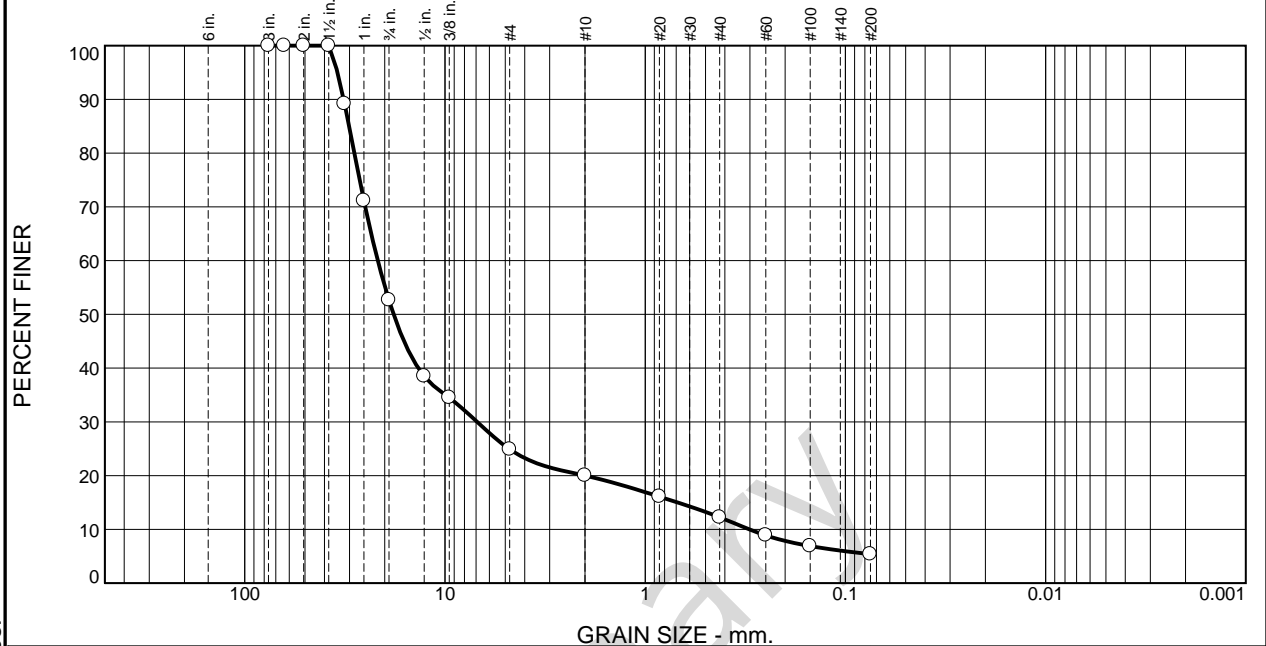

These results are for the exclusive use of the client for whom they were obtained. They apply only to the samples tested and are not indicative of apparently identical samples.

% +3"	% Gravel		% Sand			% Fines	
	Coarse	Fine	Coarse	Medium	Fine	Silt	Clay
0.0	47.4	27.7	4.9	7.8	6.8	5.4	

Test Results (ASTM D 6913 & ASTM D 1140)			
Opening Size	Percent Finer	Spec.* (Percent)	Pass? (X=Fail)
3.0	100.0		
2.5	100.0		
2.0	100.0		
1.5	100.0		
1.25	89.2		
1	71.1		
.75	52.6		
.5	38.5		
0.375	34.5		
#4	24.9		
#10	20.0		
#20	16.1		
#40	12.2		
#60	8.9		
#100	6.9		
#200	5.4		

\* (no specification provided)

**Material Description**

poorly graded gravel with silt and sand

**Atterberg Limits (ASTM D 4318)**

PL= NP      LL= NV      PI= NV

**Classification**

USCS (D 2487)= GP-GM    AASHTO (M 145)= A-1-a

**Coefficients**

D<sub>90</sub>= 32.0883    D<sub>85</sub>= 30.1172    D<sub>60</sub>= 21.6665  
D<sub>50</sub>= 18.0484    D<sub>30</sub>= 6.9144    D<sub>15</sub>= 0.6881  
D<sub>10</sub>= 0.3018    C<sub>u</sub>= 71.80      C<sub>c</sub>= 7.31

Remarks

---

Date Received: \_\_\_\_\_ Date Tested: 2/20/2020

Tested By: DC

Checked By: STM

Title: PM

Location: TP-2 S-1      Sample Number: 099315      Depth: 1.5'-2.5'      Date Sampled: 2/20/2020

<p><b>GeoResources, LLC</b></p> <p><b>Fife, WA</b></p>	<p>Client: AVT Services</p> <p>Project: AVT.Services.7thStSW</p> <p>Project No: _____</p> <p style="text-align: right;">Figure _____</p>
--	--

Tested By: \_\_\_\_\_ Checked By: \_\_\_\_\_

# Particle Size Distribution Report

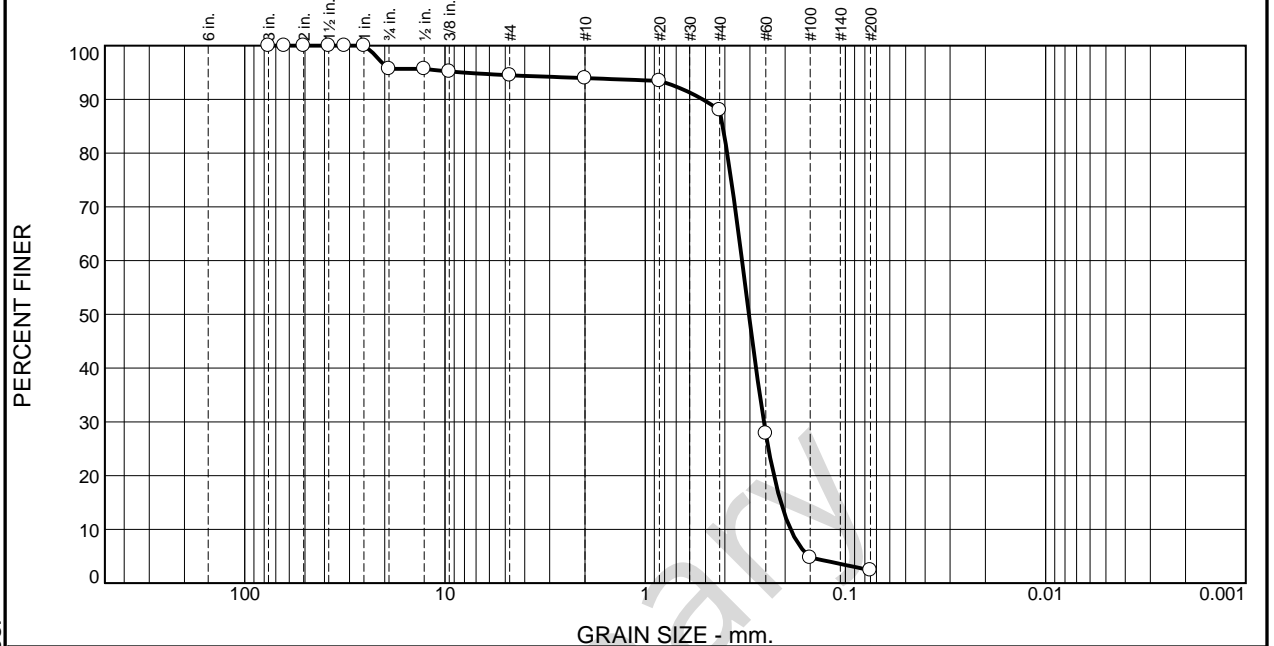

% +3"	% Gravel		% Sand			% Fines	
	Coarse	Fine	Coarse	Medium	Fine	Silt	Clay
0.0	4.3	1.2	0.5	6.0	85.6	2.4	

These results are for the exclusive use of the client for whom they were obtained. They apply only to the samples tested and are not indicative of apparently identical samples.

Test Results (ASTM D 6913 & ASTM D 1140)			
Opening Size	Percent Finer	Spec.* (Percent)	Pass? (X=Fail)
3.0	100.0		
2.5	100.0		
2.0	100.0		
1.5	100.0		
1.25	100.0		
1	100.0		
.75	95.7		
.5	95.7		
0.375	95.2		
#4	94.5		
#10	94.0		
#20	93.4		
#40	88.0		
#60	27.9		
#100	4.8		
#200	2.4		

\* (no specification provided)

**Material Description**

poorly graded sand

**Atterberg Limits (ASTM D 4318)**

PL= NP      LL= NV      PI= NV

**Classification**

USCS (D 2487)= SP      AASHTO (M 145)= A-3

**Coefficients**

D<sub>90</sub>= 0.5166      D<sub>85</sub>= 0.4099      D<sub>60</sub>= 0.3283  
 D<sub>50</sub>= 0.3034      D<sub>30</sub>= 0.2555      D<sub>15</sub>= 0.2101  
 D<sub>10</sub>= 0.1880      C<sub>u</sub>= 1.75      C<sub>c</sub>= 1.06

**Remarks**

---

Date Received: \_\_\_\_\_ Date Tested: 2/20/2020

Tested By: DC

Checked By: STM

Title: PM

Location: TP-4 S-1      Sample Number: 099317      Depth: 6'      Date Sampled: 2/20/2020

<p><b>GeoResources, LLC</b></p> <p><b>Fife, WA</b></p>	<p>Client: AVT Services</p> <p>Project: AVT.Services.7thStSW</p> <p>Project No: _____</p> <p style="text-align: right;">Figure _____</p>
--	--

Tested By: \_\_\_\_\_ Checked By: \_\_\_\_\_

# Particle Size Distribution Report

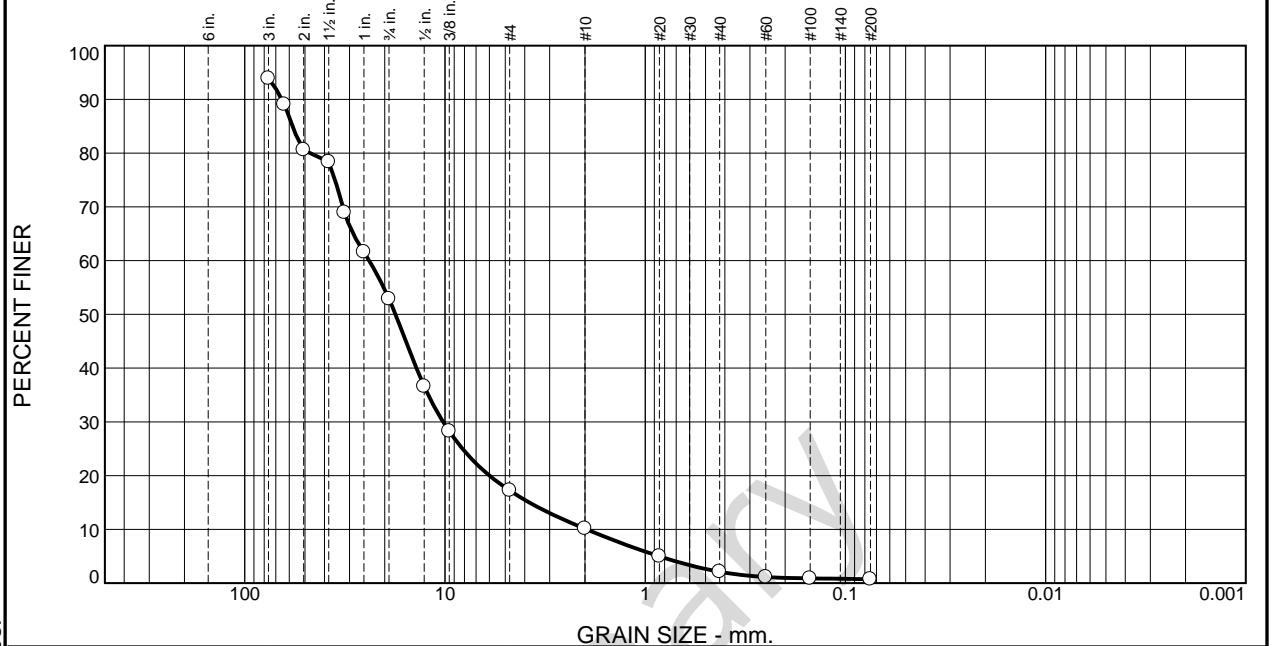

% +3"	% Gravel		% Sand			% Fines	
	Coarse	Fine	Coarse	Medium	Fine	Silt	Clay
	41.0	35.7	7.1	8.0	1.4		0.7

These results are for the exclusive use of the client for whom they were obtained. They apply only to the samples tested and are not indicative of apparently identical samples.

Test Results (ASTM D 6913 & ASTM D 1140)			
Opening Size	Percent Finer	Spec.* (Percent)	Pass? (X=Fail)
3.0	93.9		
2.5	89.1		
2.0	80.6		
1.5	78.4		
1.25	68.9		
1	61.6		
.75	52.9		
.5	36.6		
0.375	28.3		
#4	17.2		
#10	10.1		
#20	5.0		
#40	2.1		
#60	1.1		
#100	0.9		
#200	0.7		

\* (no specification provided)

**Material Description**

well-graded gravel with sand

**Atterberg Limits (ASTM D 4318)**

PL= NP      LL= NV      PI= NP

**Classification**

USCS (D 2487)= GW      AASHTO (M 145)= A-1-a

**Coefficients**

D<sub>90</sub>= 65.2363      D<sub>85</sub>= 57.6816      D<sub>60</sub>= 23.9129  
 D<sub>50</sub>= 17.6724      D<sub>30</sub>= 10.2243      D<sub>15</sub>= 3.7892  
 D<sub>10</sub>= 1.9640      C<sub>u</sub>= 12.18      C<sub>c</sub>= 2.23

**Remarks**

---

Date Received: 2/20/2020      Date Tested: 2/20/2020

Tested By: DC

Checked By: STM

Title: PM

Location: TP-4 S-2 Sample Number: 099318      Depth: 8'	Date Sampled:
<b>GeoResources, LLC</b>  <b>Fife, WA</b>	Client: AVT Services Project: AVT.Services.7thStSW  Project No: _____      Figure _____

Tested By: \_\_\_\_\_ Checked By: \_\_\_\_\_

# Particle Size Distribution Report

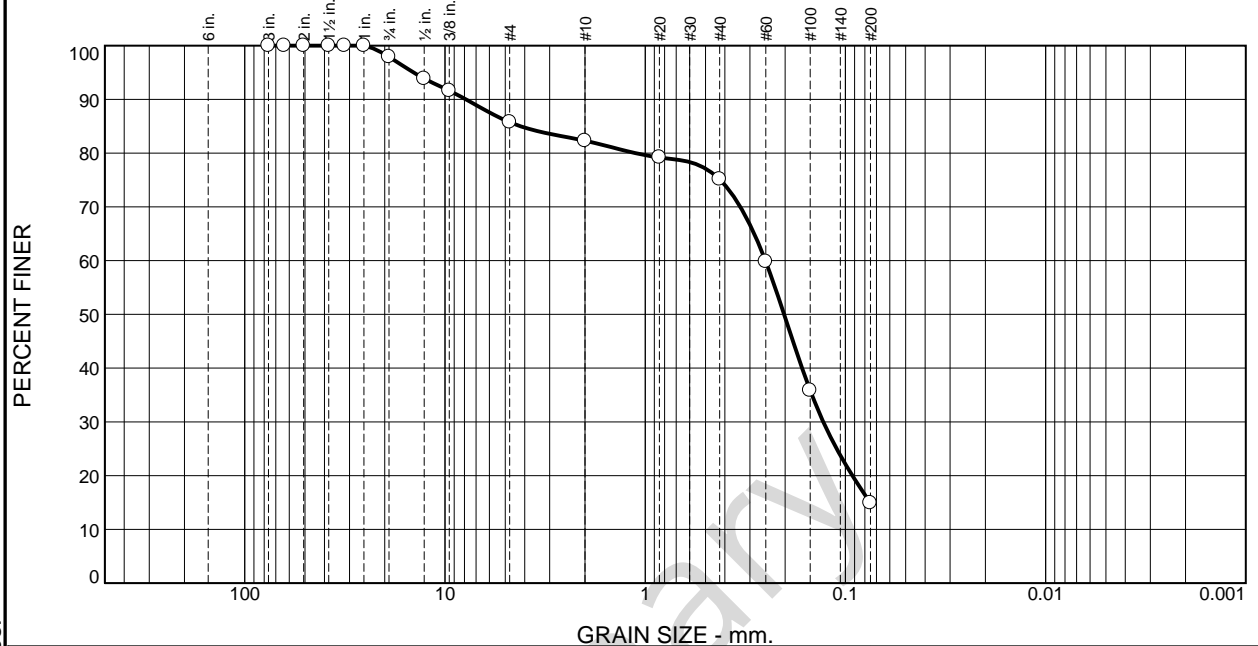

% +3"	% Gravel		% Sand			% Fines	
	Coarse	Fine	Coarse	Medium	Fine	Silt	Clay
0.0	2.1	12.2	3.4	7.2	60.2	14.9	

These results are for the exclusive use of the client for whom they were obtained. They apply only to the samples tested and are not indicative of apparently identical samples.

Test Results (ASTM D 6913 & ASTM D 1140)			
Opening Size	Percent Finer	Spec.* (Percent)	Pass? (X=Fail)
3.0	100.0		
2.5	100.0		
2.0	100.0		
1.5	100.0		
1.25	100.0		
1	100.0		
.75	97.9		
.5	93.9		
0.375	91.6		
#4	85.7		
#10	82.3		
#20	79.2		
#40	75.1		
#60	59.8		
#100	35.8		
#200	14.9		

\* (no specification provided)

**Material Description**

silty sand

**Atterberg Limits (ASTM D 4318)**

PL= NP      LL= NV      PI= NV

**Classification**

USCS (D 2487)= SM      AASHTO (M 145)= A-2-4(0)

**Coefficients**

D<sub>90</sub>= 7.8667      D<sub>85</sub>= 4.1971      D<sub>60</sub>= 0.2510  
D<sub>50</sub>= 0.2023      D<sub>30</sub>= 0.1290      D<sub>15</sub>= 0.0753  
D<sub>10</sub>=              C<sub>u</sub>=              C<sub>c</sub>=

Remarks

Date Received: \_\_\_\_\_ Date Tested: 2/20/2020

Tested By: DC

Checked By: STM

Title: PM

Location: TP-5 S-1      Sample Number: 099319      Depth: 7'-7.5'      Date Sampled: 2/20/2020

**GeoResources, LLC**

**Fife, WA**

Client: AVT Services  
Project: AVT.Services.7thStSW

Project No: \_\_\_\_\_ Figure \_\_\_\_\_

Tested By: \_\_\_\_\_ Checked By: \_\_\_\_\_

**AVT Services - 43rd Ave Multifamily**

**Figure 2**  
Groundwater Monitoring 2022-2023

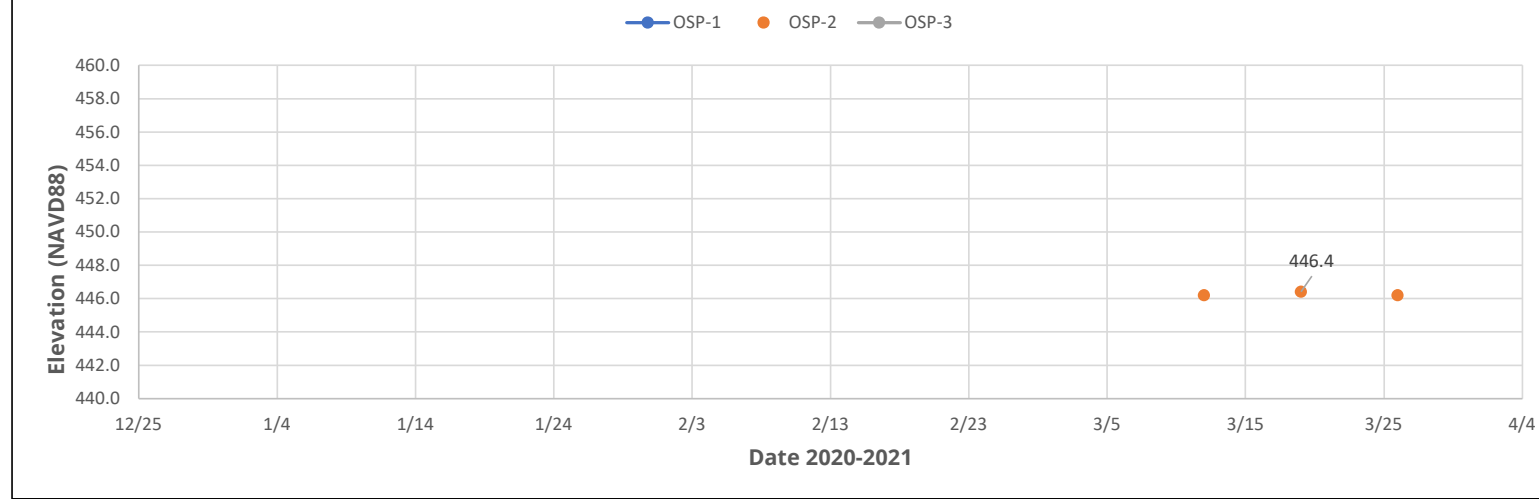

Date	OSP-1: Northeast		OSP-2: North Center		OSP-3: South Center	
	Measured Depth to Water	Water Elevation	Measured Depth to Water	Water Elevation	Measured Depth to Water	Water Elevation
12/31/2020	NE	N/A	NE	N/A	NE	N/A
1/14/2021	NE	N/A	NE	N/A	NE	N/A
1/19/2021	NE	N/A	NE	N/A	NE	N/A
2/5/2021	NE	N/A	NE	N/A	NE	N/A
2/12/2021	NE	N/A	NE	N/A	NE	N/A
2/16/2021	NE	N/A	NE	N/A	NE	N/A
3/5/2021	NE	N/A	NE	N/A	NE	N/A
3/12/2021	NE	N/A	5.8	446.2	NE	N/A
3/19/2021	NE	N/A	5.6	446.4	NE	N/A
3/26/2021	NE	N/A	5.8	446.2	NE	N/A

Well ID	Ground surface elevation at well location (Feet)	Correction for riser stickup to GS (feet)	Well Elevation	Total Depth
OSP-1	462	0	462	9.5
OSP-2	452	0	452	6
OSP-3	466	0	466	6

Note: Use column "K" only if needed. Do not use for flush-mount well monuments with known/ surveyed elevations

