

Seasons on Meeker Phase 1

***115 2nd St SE
Puyallup, Washington, 98372***

Preliminary Storm Drainage Report



6814 Greenwood Ave N
Seattle, WA 98103

T 206.522.9510
www.pacland.com

***Prepared By: Jeff Chambers, P.E.
Prepared: November 2025***

Table of Contents

EXECUTIVE SUMMARY	1
SECTION 1 - PROJECT OVERVIEW	4
SECTION 2 - EXISTING CONDITIONS	5
SECTION 3 - DEVELOPED CONDITIONS	8
SECTION 4 - OFF-SITE ANALYSIS	8
SECTION 5 - CONDITIONS AND REQUIREMENTS	9
SECTION 6 - HYDROLOGIC MODELING	15
SECTION 7 - CSWPPP ANALYSIS AND DESIGN	19
SECTION 8 - SPECIAL REPORTS AND STUDIES	212
SECTION 9 - OTHER PERMITS	21
SECTION 10 - OPERATIONS AND MAINTENANCE MANUAL	21

APPENDICES:	A – GEOTECHNICAL REPORT
	B – DOCUMENTATION (DESIGN CALCULATIONS)
	C – MAINTENANCE REPORT
	D – COVENANTS, DEDICATIONS, EASEMENTS
	E – PLANS & EXHIBITS
	F – CSWPPP

Executive Summary

The proposed development is located at 115 2nd St SE in Puyallup, Washington. The proposed redevelopment site is currently covered with asphalt surfacing, sidewalks, a YMCA building, and landscaped curb islands. The project for this report intends to redevelop approximately 1.8 acres of the site to a mixture of new retail and residential buildings, parking, amenity areas, and access changes. The project site lies within the South Puyallup River Drainage Basin.

Design Criteria:

The City of Puyallup uses the 2019 SWMMWW (2019 Stormwater Management Manual for Western Washington). The existing site is developed and consists mostly of impervious surface, with minor landscaping. Per the requirements of SWMMWW, both flow control and water quality mitigation will be required as a result of the proposed development, however, the City has indicated that the project would be allowed to direct discharge stormwater to the Puyallup River. This project is analyzed as a redevelopment project given the existing site is greater than 35% impervious. This project will be subject to MR #1 through #9 based on the Redevelopment Flow Chart included here.

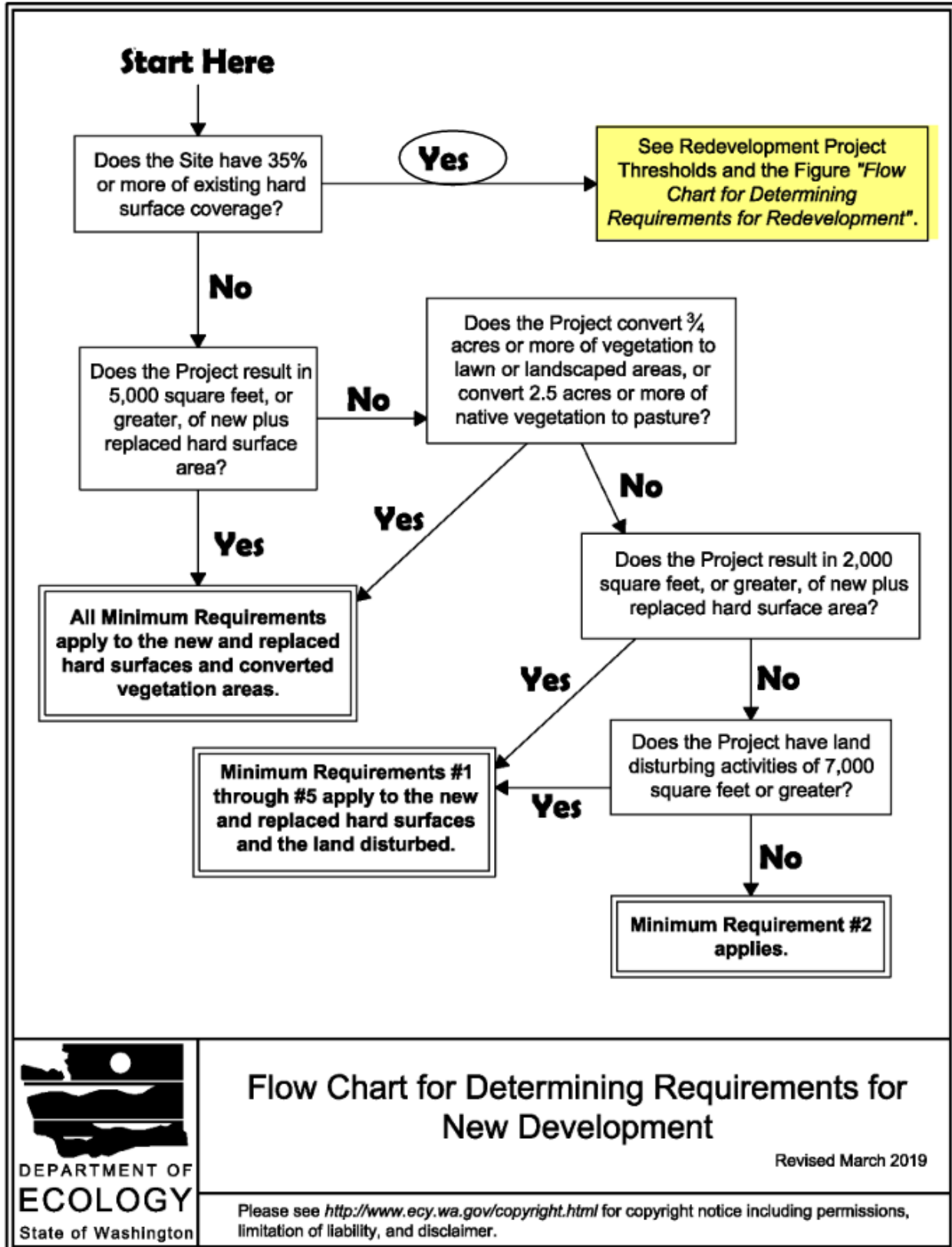

Flow Chart for Determining Requirements for New Development

Revised March 2019

Please see <http://www.ecy.wa.gov/copyright.html> for copyright notice including permissions, limitation of liability, and disclaimer.

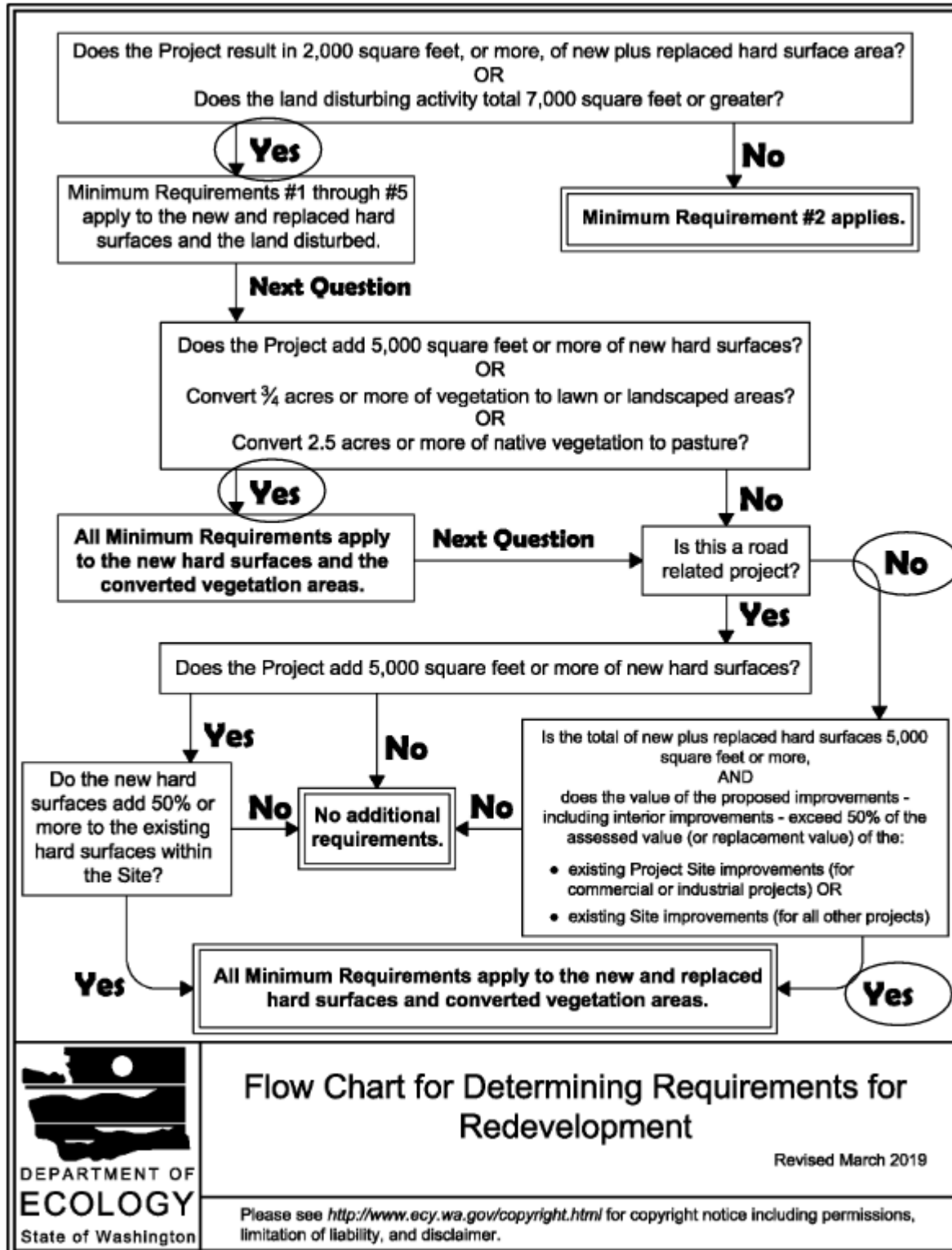

Proposed Drainage System:

Under the redeveloped site, runoff generated from the newly replaced surfaces will sheet flow into a network of catch basins and stormwater conveyance pipes before being passed through a Bayfilter treatment system. The treated water will discharge to the existing storm system in the relocated 2nd St and Meeker St.

Section 1 - Project Overview***Project Description***

The proposed development is located at 115 2nd St SE in Puyallup, Washington. The proposed redevelopment site is currently covered with asphalt surfacing, sidewalks, a YMCA building, and landscaped curb islands. The project for this report intends to redevelop approximately 1.8 acres of the site to a mixture of new retail and residential buildings, parking, amenity areas, and access changes. The project site lies within the South Puyallup River Drainage Basin.



Figure 1 - Site Photo

Site Location**Figure 2 - Site Location**

Location:	115 2 nd St SE, Puyallup, WA 98372
Section/Township/Range:	SW Quarter of Section 27, Township 20 N, Range 04 E
Parcel/Tax Lot(s):	7060000020, 7060000030, 7060000070
Size:	1.83 acres (Limits of Work)
City, County, State:	Puyallup, Pierce County, Washington
Governing Agency:	City of Puyallup
Design Criteria:	2019 SWMMWW (2019 Stormwater Management Manual for Western Washington)
Drainage Basin:	South Puyallup River

Section 2 - Existing Conditions**Existing Sub-basins**

The existing property drains to the South Puyallup River Drainage Basin via a City owned and maintained conveyance system located within 2nd St Se & Meeker St.

The project site is considered one on-site basin. This is further shown in **Tables 1 and 2** and **Appendix E**.

Basin A – The existing YMCA building and a row of covered parking, along with primarily parking lot pavement and minimal landscaping.

These areas are further broken down under the developed conditions based on different pre-developed and developed conditions.

Existing Stormwater Facilities

The existing site utilizes a series of catch basins and stormwater conveyance pipes to discharge to the 12” City-owned system in Meeker St. There are no existing detention or water quality treatment systems on the project site.

Soils

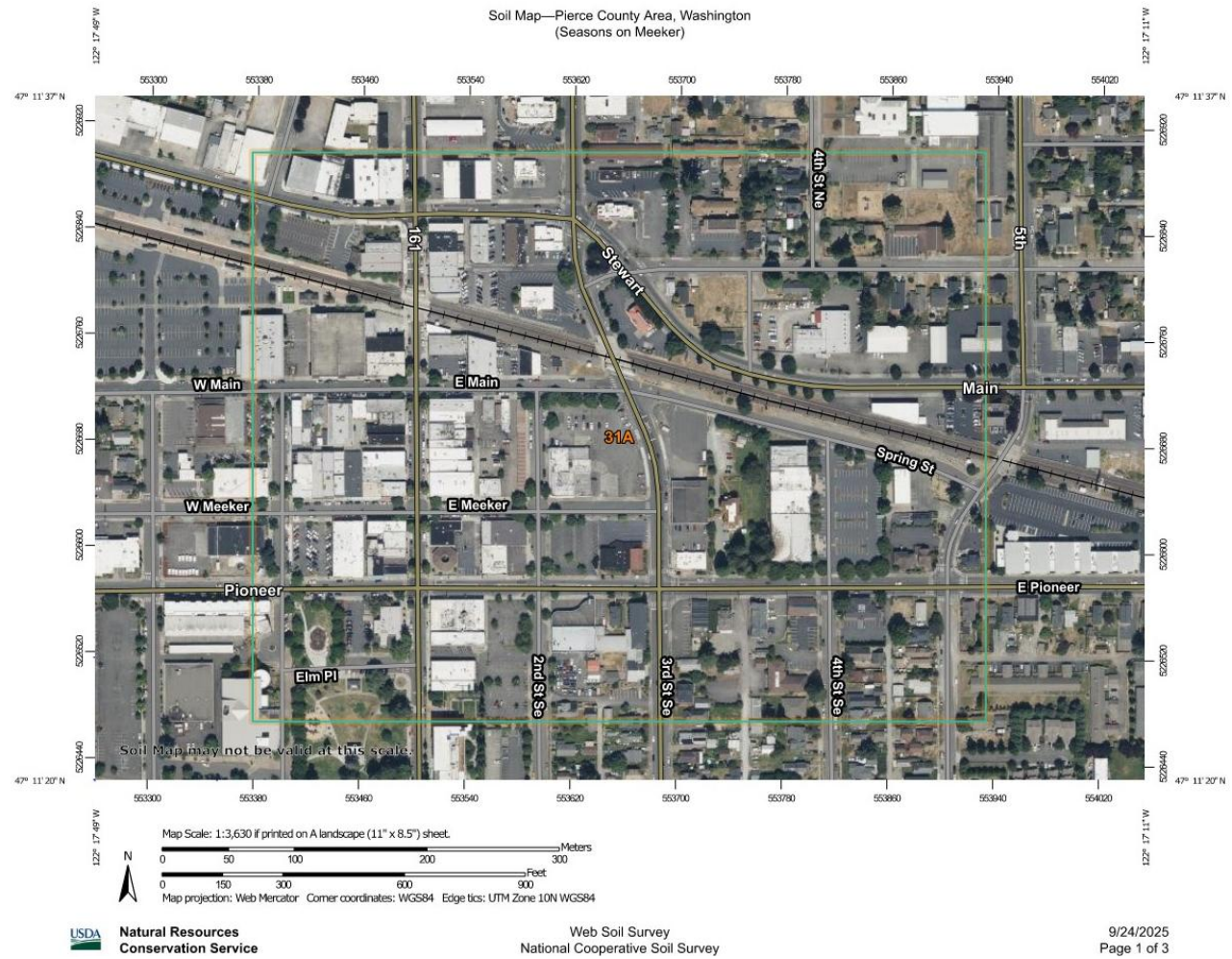

Map Unit Legend

Map Unit Symbol	Map Unit Name	Acres in AOI	Percent of AOI
31A	Puyallup fine sandy loam	59.1	100.0%
Totals for Area of Interest		59.1	100.0%

Figure 3 - Site Soils (USDA Web Soil Survey Map)

The site is underlain entirely of Puyallup fine sandy loam, according to the USDA Natural Resource Conservation Service, Web Soil Survey for Pierce County Area, Washington.

Geotechnical Report

According to the Geotechnical Engineering Report prepared by Columbia West Engineering, Inc., dated August 18, 2023, groundwater was encountered between 7 and 10 feet below the ground surface. The on-site subsurface soils consist of existing fill approximately 1 to 4 feet below the ground surface, consisting of generally loose, gray to brown, moist silty sand. Underlying the pavement and existing fill generally consists of interbedded layers of very soft to very stiff silts with varying proportions of sand and very loose to medium dense silty and clayey sand. According to the Geologic Map of the Tacoma 1:100,000-scale Quadrangle, Washington, the site is underlain by Quaternary alluvium (Qa). The alluvium is described as unconsolidated or semi-consolidated clay, silt, sand, gravel or cobble deposits.

This report is in **Appendix A**.

Infiltration

Infiltration potential was performed using Pilot Infiltration Tests (PIT) per the 2019 DOE Stormwater Manual for Western Washington to determine the measured infiltration rate (in/hr).

PIT tests were performed at TP-1 and TP-4 in August 2023 per the figure below:

Test Number	Location (See Figure 2)	Approximate Test Depth (feet BGS)	Approximate Depth to Groundwater on 08-02-23 (feet BGS)	USCS Soil Type	Passing No. 200 Sieve (percent)	Measured Infiltration Rate (inches/hour)
IT-1.1	TP-1	2	9	SM, Silty SAND	36	0.4
IT-1.2	TP-1	5	9	SM, Silty SAND	34	0.9
IT-4.2	TP-4	6	8.5	SM, Silty SAND	18	8

Per the report, due to the presence of near-surface existing fill, shallow groundwater, and fine-textured, low permeability soils at the site, subsurface disposal of concentrated stormwater is infeasible.

This report is in **Appendix A**.

Section 3 - Developed Conditions

Developed Sub-basins

The developed Basin 1 consists primarily of a new retail building and townhomes with associated sidewalks, parking lot pavement, and landscaping. The basin also includes the relocated 2nd St SE (shifting west of the proposed townhomes). The basin will continue to drain to the Puyallup River via a City-owned and maintained conveyance system located in Meeker St. This will not change with development although site runoff will pass through a proposed water quality treatment system prior to discharging to the City-owned system. Under future phases of the proposed development, multifamily residential buildings will be constructed along the north and east as well as required frontage improvements along 3rd St SE and Main St.

The project basins are shown in **Appendix E**.

Developed Stormwater Facilities

Basin 1:

The areas associated with the Phase 1 development will drain to a network of catch basins and conveyance pipes before passing through a proposed treatment system that has been sized to treat 91% of the site runoff before discharging to the City-owned and maintained conveyance system located in Meeker St, which drains to the Puyallup River. The City Engineer has stated that the project will be allowed to direct discharge stormwater via the City-owned trunkline to the stormwater basin that services the project site.

As part of the proposed development, the existing 2nd St SE will be vacated and relocated west of the proposed townhomes. As such, the existing 12" conveyance system in the vacated street will also be relocated to its new location and maintain its current capacity by matching pipe sizes and slopes at the minimum.

More detail about the developed hydrology and stormwater facilities will be described in **Section 6**.

Section 4 - Off-Site Analysis

Upstream Analysis

Based on existing topography, the site receives minimal runoff from the property to the west due to existing perimeter curbing. All other portions of the site are self-contained due to perimeter curbing and public sidewalks, with the exception of the existing 2nd St SE. The relocated 2nd St will have grade breaks at the proposed access to Main St to prevent upstream run-on.

Threshold Discharge Area (TDA)

The TDA for the project is within the Puyallup River drainage basin as it currently exists. The project will incorporate ridges and valleys to collect the localized stormwater for treatment before discharging at undetained flow rates. The project site is defined by the bounds of Main St, 3rd St SE, Meeker St, and the west property line.

Downstream Analysis/Discharge Location

The proposed stormwater management system for the project site will route surface water to a proprietary treatment system before discharging off-site to the existing City-owned system in Meeker St.

After entering the municipal system, stormwater travels approximately 12,100 feet to the northwest via existing storm pipes ranging from 12" to 60" and outfalls into the Puyallup River. A map of the downstream analysis can be seen in Figure 4.

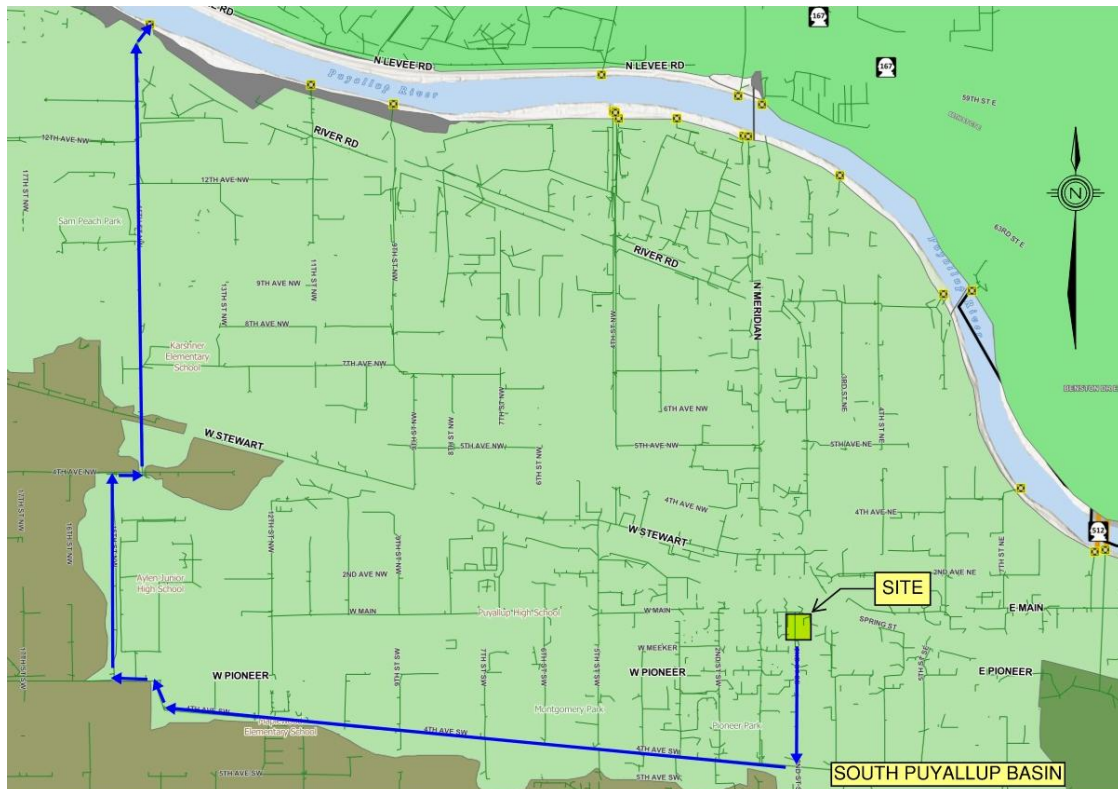

Figure 4 - Downstream Area (Map from City of Puyallup GIS)

Section 5 - Conditions and Requirements

As required by the 2019 Stormwater Management Manual for Western Washington (SWMMWW), this project is subject to a full drainage review. Therefore, the storm drainage design for this project is required to comply with all nine (9) Minimum Requirements. The requirements have been met as follows:

Minimum Requirement #1: Preparation of Stormwater Site Plans

This project proposes to replace greater than 2,000 square feet of impervious surface; thus, Minimum requirement #1 applies and a Stormwater Site Plan must be prepared for review by the local jurisdiction.

Response: *This Storm Drainage Report has been prepared to address this requirement.*

Minimum Requirement #2: Construction Stormwater Pollution Prevention Plan (SWPPP)

All erosion and sediment control measures shall be governed by the requirements of Department of Ecology's 2019 Stormwater Management Manual for Western Washington and the General Permit for Construction Stormwater. The thirteen elements as identified in the manual and provided below will be incorporated into the TESC plans:

- Element 1: Preserve Vegetation/Mark Clearing Limits*
- Element 2: Establish Construction Access*
- Element 3: Control Flow Rates*
- Element 4: Install Sediment Controls*
- Element 5: Stabilize Soils*
- Element 6: Protect Slopes*
- Element 7: Protect Drain Inlets*
- Element 8: Stabilize Channels and Outlets*
- Element 9: Control Pollutants*
- Element 10: Control De-watering*
- Element 11: Maintain BMPs*
- Element 12: Manage the Project*
- Element 13: Protect Low Impact Development BMPs*

Response: *Temporary Erosion and Sediment control plans will be prepared to address the elements identified. Since the project will result in 2,000 square feet or more of new plus replaced hard surface area, a Stormwater Pollution Prevention Plan (SWPPP) is required. Additionally, since the project will result in more than 1 acre of soil disturbance, coverage under the Department of Ecology (DOE) Construction Stormwater General Permit (CSWGP) is required. See Section 8 of this report for a complete description of the construction and erosion control strategies being implemented.*

Minimum Requirement #3: Source Control of Pollution

All known, available, and reasonable source control BMPs must be applied to all projects. Source control BMPs must be selected, designed, and maintained according to the 2019 SWMMWW.

Response: *Source control BMPs will be implemented according to the standards outlined in the 2019 SWMMWW. Downturned elbows are being utilized upstream of the treatment system for trash management from the parking lot.*

Minimum Requirement #4: Preservation of Natural Drainage Systems and Outfalls

Natural drainage patterns shall be maintained, and discharges from the project site shall occur at the natural location, to the maximum extent practicable. How runoff is discharged from the project site must not cause a significant adverse impact to downstream receiving waters and downgradient properties. All outfalls require energy dissipation.

Response: *The proposed drainage design for the project site will not alter the existing site's drainage pattern, outside of relocating the discharge point to the new location for 2nd St SE. This is in alignment with the City's plans for infrastructure improvements to Meeker St. Basin 1 will treat captured runoff before discharging at undetained flow rates, as the City has confirmed that the project can direct discharge to the Puyallup River without the need for additional flow control. Refer to Section 4 for more details about the existing and proposed drainage hydrology.*

Minimum Requirement #5: On-site Stormwater Management

Projects shall employ On-site Stormwater Management BMPs in accordance with the following projects thresholds, standards, and lists to infiltrate, disperse, and retain stormwater runoff on-site to the extent feasible without causing flooding or erosion impacts.

Response: *List #2 was analyzed for compliance to MR #5. The project geotechnical engineer recommended against the use of infiltration due to the presence of near-surface existing fill, shallow groundwater, and fine-textured, low permeability soils at the site. See below for further responses to each element.*

Figure I-3.3: Flow Chart for Determining MR #5 Requirements

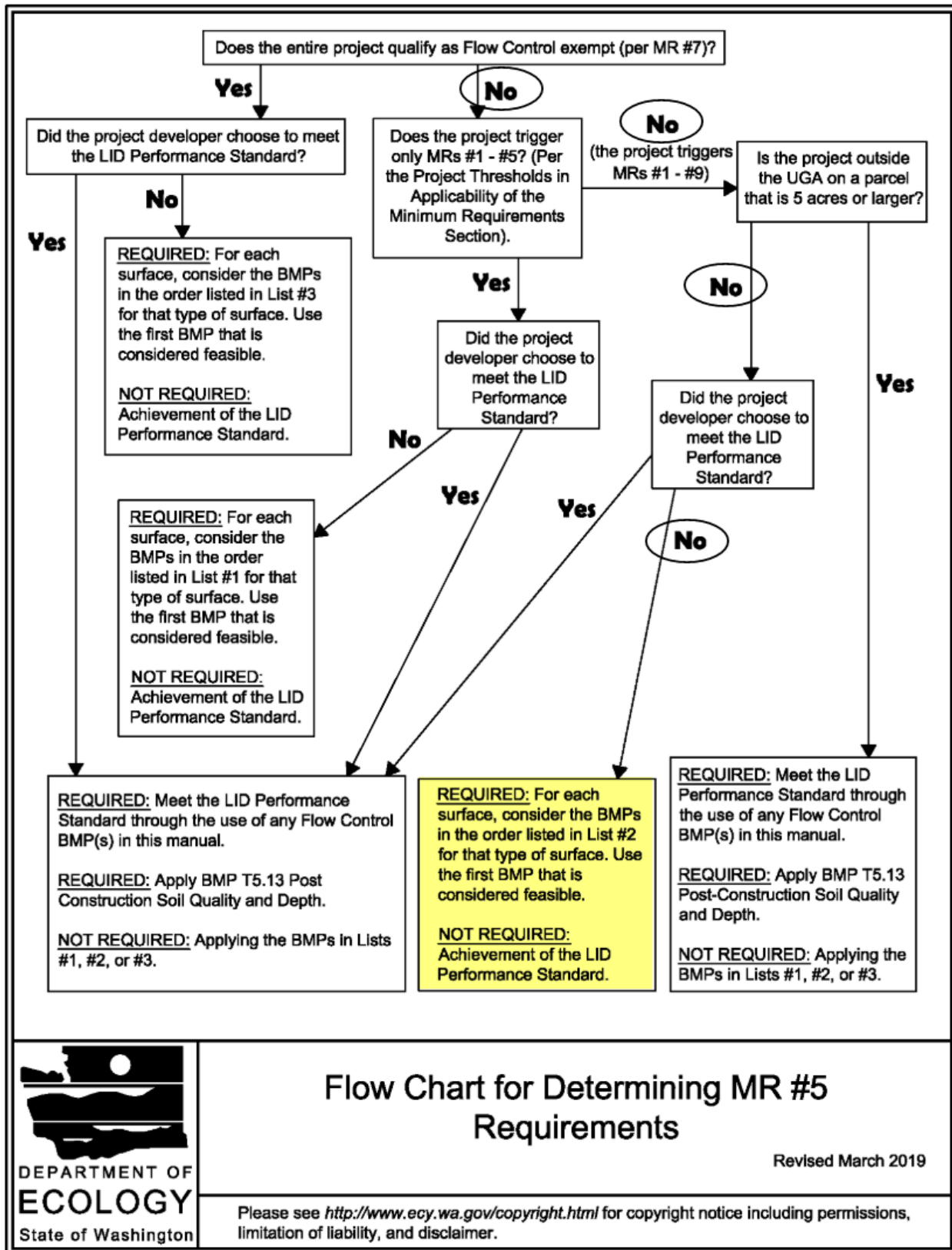

Flow Chart for Determining MR #5 Requirements

Revised March 2019

Please see <http://www.ecy.wa.gov/copyright.html> for copyright notice including permissions, limitation of liability, and disclaimer.

1. *Lawn and landscaped areas:*

- a. *Post-Construction Soil Quality and Depth in accordance with BMP T5.13 in Chapter 5 of Volume V*

Response: The project will meet BMP T5.13.

1. A topsoil layer with a minimum organic matter content of 10% dry weight in planting beds, and 5% organic matter content in turf areas, and a pH from 6.0 to 8.0 or matching the pH of the undisturbed soil. The topsoil layer shall have a minimum depth of eight inches except where tree roots limit the depth of incorporation of amendments needed to meet the criteria. Subsoils below the topsoil layer should be scarified at least 4 inches with some incorporation of the upper material to avoid stratified layers, where feasible.
2. Mulch planting beds with 2 inches of organic material
3. Use compost and other materials that meet these organic content requirements:
 - a. The organic content for “pre-approved” amendment rates can be met only using compost meeting the compost specification for Bioretention (BMP T7.30), with the exception that the compost may have up to 35% biosolids or manure. The compost must also have an organic matter content of 40% to 65%, and a carbon to nitrogen ratio below 25:1. The carbon to nitrogen ratio may be as high as 35:1 for plantings composed entirely of plants native to the Puget Sound Lowlands region.
 - b. Calculated amendment rates may be met through use of composted material meeting (a.) above; or other organic materials amended to meet the carbon to nitrogen ratio requirements, and not exceeding the contaminant limits identified in Table 220-B, Testing Parameters, in WAC 173-350-220.

2. *Roofs:*

- a. *Full Dispersion in accordance with BMP T5.30 in Chapter 5 of Volume V, or Downspout Full Infiltration Systems in accordance with BMP T5.10A in Section 3.1.1 in Chapter 3 of Volume III*

Response: Full dispersion is not allowable due to on-site grades and proximity to E Main Ave, 3rd St SE, and E Meeker. Based on the project geotechnical engineer’s recommendations against the use of infiltration, perforated stub-outs for the roof areas will not be utilized.

- b. *Bioretention (See Chapter 7 of Volume V) facilities that have a minimum horizontally projected surface area below the overflow which is at least 5% of the total surface area draining to it.*

Response: Based on the project geotechnical engineer's recommendations against the use of infiltration, bioretention for the roof areas will not be utilized.

- c. *Downspout Dispersion Systems in accordance with BMP T5.10B in Section 3.1.2 in Chapter 3 of Volume III*

Response: There is no space for downspout diversion.

- d. *Perforated Stub-out Connections in accordance with BMP T5.10C in Section 3.1.3 in Chapter 3 of Volume III*

Response: Based on the project geotechnical engineer's recommendations against the use of infiltration, perforated stub-outs for the roof areas will not be utilized.

3. *Other Hard Surfaces:*

- a. *Full Dispersion in accordance with BMP T5.30 in Chapter 5 of Volume V*

Response: Site does not have adequate space to allow for a downstream dispersion path.

- b. *Permeable pavement¹ in accordance with BMP T5.15 in Chapter 5 of Volume V.*

Response: Based on the project geotechnical engineer's recommendations against the use of infiltration, we are not considering permeable pavement to be feasible.

- c. *Bioretention (See Chapter 7 of Volume V) facilities that have a minimum horizontally projected surface area below the overflow which is at least 5% of the total surface area draining to it.*

Response: Bioretention areas cannot be located on the project site due to grades and the project geotechnical engineer recommends against the use of infiltration.

- d. *Sheet Flow Dispersion in accordance with BMP T5.12, or Concentrated Flow Dispersion in accordance with BMP T5.11 in Chapter 5 of Volume V.*

Response: There is not a downstream path that allows dispersion.

¹This is not a requirement to pave these surfaces. Where pavement is proposed, it must be permeable to the extent feasible unless full dispersion is employed.

Minimum Requirement #6: Runoff Treatment

Projects in which the total of effective, pollution-generating impervious surface (PGIS) is 5,000 SF or more in a threshold discharge area of the project require construction of stormwater treatment facilities. Projects in which the total of pollution-generating pervious surfaces (PGPS) is three-quarters (3/4) of an acre or more in a threshold discharge area, and from which there is a surface discharge in a natural or man-made conveyance system from the site also require treatment facilities.

Response: *As the site is not considered a high-use site, Basin 1 will utilize a proprietary system for basic water quality treatment prior to discharging to the City-owned system.*

Minimum Requirement #7: Flow Control

Projects must provide flow control to reduce the impacts of stormwater runoff from hard surfaces and land cover conversions. The requirement below applies to projects that discharge stormwater directly, or indirectly through a conveyance system, into a fresh waterbody.

Stormwater discharges shall match 50% of the pre-developed 2-year peak flow up to the full 50 -year peak flow. The pre-developed condition should match a forested land cover. Proper Flow Control BMPs shall be selected and designed according to the current SWMMWW.

Response: *Though MR #7 is applicable to this project, per direction received from the City Engineer, the project will be allowed to direct discharge stormwater to the Puyallup River as the City plans to extend a direct discharge trunkline to the Puyallup River Drainage Basin that currently serves the project site.*

Minimum Requirement #8: Wetlands Protection

The thresholds identified in Minimum Requirement #6 and Minimum Requirement #7 shall also be applied for any discharge to wetlands.

Response: *There are no wetlands located within the vicinity of the site.*

Minimum Requirement #9: Operation and Maintenance

An operation and maintenance manual that is consistent with the provisions in the SWMMWW shall be provided for proposed stormwater facilities and BMPs, and the parties responsible for maintenance and operation shall be identified.

Response: *The Operations and Maintenance of the storm water management system is detailed in the Operations and Maintenance section of this report, **Appendix C**. The Operations and Maintenance Manual will be provided during permitting and not as part of this preliminary site plan review.*

Section 6 - Hydrologic Modeling

Hydrologic Modeling Method

Hydrologic analysis of water quality and flow control for the project was performed using the Washington State Department of Ecology's Western Washington Hydrologic Method of computer modeling WWHM2012 program. The model utilized design data for specific soil types and vegetative covers to simulate runoff.

The pre-developed and post-developed conditions for the project site sub-basin are shown in **Tables 1 and 2**. Calculations are provided in **Appendix B**. An exhibit showing the existing conditions and proposed Preliminary Stormwater Site Plan included in **Appendix E**.

Table 1 – Pre-Developed Conditions (Acres)

Description	Total
Roof	0.000
Sidewalk	0.000
PGIS	0.000
<i>Sub-Total</i>	0.000
Forested, Flat	1.827
<i>Sub-Total</i>	1.827
Total	1.827

Table 2 – Developed Conditions (Acres)

Description	Total
Roof	0.987
Sidewalk	0.207
PGIS	0.578
<i>Sub-Total</i>	1.772
Landscape	0.055
Forested, Flat	0.000
<i>Sub-Total</i>	0.055
Total	1.827

Flow Control Analysis

As described in Section 5, though MR #7 is applicable to this project, we are allowed to direct discharge stormwater to the Puyallup River as the City plans to extend a direct discharge trunkline to the Puyallup River Drainage Basin that currently serves the project site. As such, no additional flow control BMPs are proposed for this development. **Table 3** provides the undetained peak flows leaving the site at the discharge point in Meeker St.

Table 3 – Basin 1 Peak Flows

Storm Event	Developed (CFS)
2-year	0.6216
5-year	0.8344
10-year	0.9890
25-year	1.2007
50-year	1.3706
100-year	1.5512

Analysis Results

POC 1

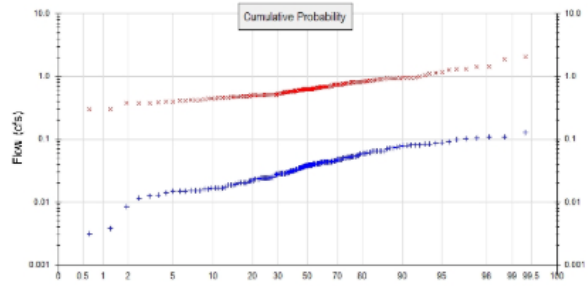
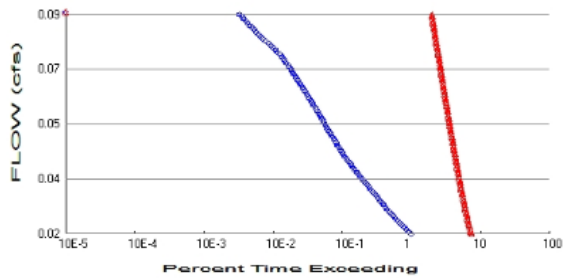

+ Predeveloped x Mitigated

Predeveloped Landuse Totals for POC #1

Total Pervious Area: 1.827
 Total Impervious Area: 0

Mitigated Landuse Totals for POC #1

Total Pervious Area: 0.055
 Total Impervious Area: 1.772

Flow Frequency Method: Log Pearson Type III 17B

Flow Frequency Return Periods for Predeveloped. POC #1

Return Period	Flow(cfs)
2 year	0.0385
5 year	0.059895
10 year	0.07152
25 year	0.083352
50 year	0.090385
100 year	0.096168

Flow Frequency Return Periods for Mitigated. POC #1

Return Period	Flow(cfs)
2 year	0.621605
5 year	0.834384
10 year	0.989031
25 year	1.200685
50 year	1.37055
100 year	1.551202

Water Quality System

Water quality treatment will be provided based on basic standards as the development is not considered to be a high-use site requiring more stringent treatment standards.

Basin 1:

Basic water quality for Basin 1 will be achieved by routing captured stormwater thru an underground Bayfilter sized to treat the peak 15-minute flow rate (0.116 CFS) as calculated using the latest version of WWHM. The treatment flow capacity for the 60" diameter manhole containing a 2-cartridge Bayfilter system is 0.20 CFS.

Conveyance

The on-site stormwater conveyance can be calculated based on gravity flow analysis of the piping network. Peak run-off associated with and up to a 25-year storm event has been determined to be adequate. Uniform flow analysis utilizing Manning's equation, shown below, was employed with a Manning's Roughness Coefficient (n) of 0.012.

Manning's equation:
$$Q = \frac{1.49}{n} \times A \times R^{2/3} \times S^{1/2}$$

With: Q = Flow (CFS)

n = Manning's Roughness Coefficient (0.012)

A = Flow Area (SF)

R = Hydraulic Radius = Area /Wetted Perimeter (LF)

S = Slope of the pipe (ft/ft)

Flows greater than the 100-year event will safely discharge from the site and into the City owned system in Main St, 3rd St SE, and Meeker St. Conveyance capacity calculations are in **Appendix B**.

100-Year Flood/Overflow Condition

Review of the current FEMA FIRM maps (Panel 53053C0333E) indicates that the project site is in Zone X and outside of the 100-year flood plain. The stormwater system for this project has been designed to address the storm events in accordance with design criteria described previously. In the event of a larger storm, it is unlikely that the system would fail. Based on a review of the site and immediate surroundings, the overflow of the stormwater conveyance system would allow surface water to sheet flow over the existing pavement and into the adjacent storm system, ultimately entering into the City storm system in Main St, 3rd St SE, and Meeker St.

Section 7 - CSWPPP Analysis and Design

All erosion and sediment control measures shall be governed by the requirements Department of Ecology's 2019 Storm Water Management for Western Washington and the General Permit for Construction Storm Water. A National Pollutant Discharge Elimination System (NPDES) Permit will be obtained and a Stormwater Pollution Prevention Plan (SWPPP) has been prepared for this project and is in **Appendix F**.

A temporary erosion and sedimentation control plan will be prepared to assist the contractor in complying with these requirements. The Erosion and Sediment Control (ESC) plan will be included with the construction plans.

1. Construction Sequence and Procedure

The proposed development will include an erosion/sedimentation control plan designed to prevent sediment-laden run-off from leaving the site during construction. The erosion potential of the site is influenced by four major factors: soil characteristics, vegetative cover, topography, and climate. Erosion/sedimentation control is achieved by a combination of structural measures, cover measures, and construction practices that are tailored to fit the specific site.

The contractor will be responsible for implementing the following erosion control and storm water management control measures. The contractor may designate these tasks to certain subcontractors as they see fit, but the ultimate responsibility for implementing these controls and ensuring their proper functioning remains with the contractor. The order of activities will be as follows.

Phase 1

1. Prior to any construction work on the site, representatives from the City of Puyallup must approve the storm water pollution prevention plan.
2. Mark clearing limits.
3. Install inlet protection to all existing catch basins.
4. Install temporary stabilized construction entrance.
5. Install perimeter silt fences, compost socks, etc. Protect existing and proposed infiltration areas.
6. Remove any existing structures that may be on site.
7. Protect and stabilize slopes.
8. Begin clearing and grubbing operations. Clearing and grubbing done from October 1st through April 30th is authorized as long as there are erosion and sediment control measures.
9. Commence site grading.

Phase 2

1. Disturbed areas of the site where construction activity has ceased for more than 7 days between May 1 and September 30 or 2 days between October 1 and April 30 shall be temporarily seeded and watered.
2. Install haul road.
3. Construct building pad and install concrete wash out area.
4. Construct permanent storm water facilities.
5. Install utilities, underdrains, storm sewers, curbs and gutters.
6. Install inlet/outlet protection at the locations of all grate inlets, curb inlets, and at the ends of all exposed storm sewer pipes.

7. Prepare site for paving. Finalize pavement subgrade preparation.
8. Remove inlet protection around inlets and manholes no more than 48 hours prior to placing stabilized base course.
9. Install base material as required for pavement. Pave site. Do not pave over catch basins.
10. Complete final grading in non-parking areas and install permanent seeding and planting.
11. Remove silt fencing only after all paving is complete and exposed surfaces are stabilized.
12. Remove temporary construction exits only prior to pavement construction in these areas (These areas are to be paved last).

The degree of erosion risk on the proposed project site is minimal. Slope across the site is minimal. Runoff will not travel at high velocities across the site and, therefore, will not cause noticeable erosion impacts.

2. Temporary Soil Stabilization

Temporary stabilization practices for this project include:

- Temporary seeding and planting of all unpaved areas using the hydro-mulching grass seeding technique.
- Mulching exposed areas
- Installation of rolled erosion control products
- Rock surfacing

Structural practices for this project include the following. Refer to the Erosion Control plans for specific locations and details:

- Inlet protection using fiber fabric.
- Perimeter protection using silt fences and compost socks.
- Stabilized construction entrance/exit points and staging area.

Daily inspection of the erosion control measures will be required during construction. Any sediment buildup shall be removed and disposed offsite at an appropriate disposal facility.

Vehicle tracking of mud off-site shall be avoided. A gravel construction entrance/exit will be installed at a location to enter the site. The construction entrance/exit is a minimum requirement and may be supplemented if tracking of mud onto public streets becomes excessive. If mud is tracked off site, it shall be swept and disposed of offsite on a daily basis.

Because vegetative cover is the most important form of erosion control, construction practices must adhere to stringent cover requirements. More specifically, the contractor will not be allowed to leave soils open for more than 7 days between May 1st and September 30th and 2 days between October 1st and April 30th. Soils shall be stabilized at the end of the shift before a holiday or weekend if needed based on the weather forecast. Applicable practices include, but are not limited to, temporary and permanent seeding, sodding, mulching, plastic covering, and soil application of polyacrylamide.

Soil stockpiles must be stabilized from erosion, protected with sediment trapping measures, and, where possible, be located away from storm drain inlets, waterways and drainage channels.

3. Permanent Erosion Control and Site Restoration

Upon completion of the project, areas of the site that are not stabilized with paving, rooftops, or landscaping as shown on the site plans will be protected with either grass, ground cover/plantings or existing vegetation as shown on the Landscape Plans. In general, storm runoff from the site will be collected by catch basins connected to a storm water quality structure and then flows into detention system.

4. Inspection Sequence

The construction site operator will periodically inspect its sites. Because our project disturbs more than one acre, a certified erosion and sediment control lead will be identified within the SWPPP. This individual will always be present on site or on call.

5. Control of Pollutants Other than Sediments

Pollutants shall be controlled on the work site through the utilization of a centralized area for equipment, a concrete truck washout, and an area designated for temporary storage of debris and stockpiled materials.

Section 8 - Special Reports and Studies

The following Special Reports and Studies were used or have been completed for this project:

- *Geotechnical Engineering Report* – Columbia West Engineering, Inc., dated August 18, 2023

Section 9 - Other Permits

The following governmental approvals or permits will likely be required for this project:

- City of Puyallup Building Permit
- City of Puyallup Civil Construction Permit
- City of Puyallup Clear, Fill and Grade Permit
- City of Puyallup ROW Permit
- Water Service Permit by City of Puyallup
- Side Sewer Permit by City of Puyallup
- City of Puyallup Demolition Permit
- NPDES Permit by Washington State DOE

Section 10 - Operations and Maintenance Manual

The Operations & Maintenance Manual can be found in **Appendix C**.

CONCLUSION

The proposed storm water management system for this project has been designed in accordance with regulatory criteria described above and consistent with sound engineering practice. This design has incorporated storm water detention and storm water quality best management practices. Therefore, no significant adverse impacts to the upstream or downstream storm water management systems are expected as a result of the proposed development.

Appendix A – Geotechnical Engineering Report

Geotechnical Engineering Report

Season on Meeker

Puyallup, Washington

August 18, 2023

Geotechnical ■ Environmental ■ Special Inspections

Columbia West
Engineering, Inc





**GEOTECHNICAL ENGINEERING REPORT
SEASON ON MEEKER
PUYALLUP, WASHINGTON**

Prepared For:

**Palindrome Puyallup, LLC
Attn: Jason Ellis
42 NW 5th Avenue, Suite 200
Portland, Oregon 97209**

Site Location:

**115 2nd Street Southeast
Tax Parcels 7060000030, 7060000020, and
7060000070
Puyallup, Washington**

Prepared By:

**Columbia West Engineering, Inc.
8880 SW Nimbus Avenue, Suite A
Beaverton, Oregon 97008
Phone: 971-384-1666**

Date Prepared:

August 18, 2023

EXECUTIVE SUMMARY

This executive summary presents the primary geotechnical considerations associated with the proposed Season on Meeker project located in Puyallup, Washington. Our conclusions and recommendations are based on the subsurface information presented in this report and proposed development information provided by the design team. Detailed discussion of the geotechnical considerations summarized here is presented in respective sections of the report.

- The site is susceptible to liquefaction under design levels of ground shaking. Maximum settlement associated with liquefaction is expected to be 5 inches with differential settlement of approximately half the total over a distance of 50 feet. Detailed discussion of site strain softening potential is presented in Section 5.1, *Liquefaction and Strain Softening*. If the risk of damage following a seismic event cannot be accepted, we recommend structures be supported on improved ground using rammed aggregate piers (RAPs), or other acceptable method.
- Foundation loads were not available at the time of this report. We have assumed maximum column, wall, and slab loads of 350 kips, 4 kips per foot, and 100 psf, respectively. The on-site alluvial soil is compressible. It is our opinion that foundation settlement from assumed loads will exceed structural tolerances without ground improvement as discussed in Section 6.1.1, *Spread Footings Bearing on RAPs*.
- Existing fill was encountered in the test pits to depths up to 4 feet below ground surface (BGS). Improvement of existing fill within the footprints of proposed structures should be determined by the ground improvement design-build contractor. There is also a risk of premature pavement distress if existing fill is left in place beneath future pavements. Additional discussion is provided in Section 7.1.1, *Existing Fill*.
- Groundwater was observed between 7 and 10 feet BGS in the test pits and CPTs. The shallow depth to groundwater may impact site cuts for foundations, utilities, and stormwater management facilities. Dewatering should be assumed where proposed excavations extend more than a few feet below existing grade.
- Based on groundwater conditions, cut off drains may be required to intercept water in areas of significant cut. Our experience indicates that installation of cut-off drains prior to site grading activity will assist in dewatering during site construction, particularly during the wet-weather season.
- Perimeter building foundation drains should be considered for shallow foundations constructed below existing site grades. Drains beneath building floor slabs may also be required where the proposed finished floor elevation is lower than existing grade.

- Moisture conditioning (drying) of existing fill and native soil may be required to use the material as structural fill. Addition of moisture may also be necessary during periods of warm, dry weather. If moisture conditioning is not feasible, soils may require cement-amendment to be used as structural fill.
- Fine-grained soils will be sensitive to disturbance and softening when at a moisture content that is above optimum. Haul roads and staging areas will be necessary to minimize damage to exposed subgrade during construction. Subgrade protection is discussed in Section 7.2, Construction Traffic and Staging.
- Based on groundwater observations and results of in situ infiltration testing, infiltration is likely not feasible for stormwater management.

TABLE OF CONTENTS

LIST OF FIGURES	ii
LIST OF APPENDICES	iii
1.0 INTRODUCTION	1
1.1 General Site Information	1
1.2 Project Understanding	1
2.0 SCOPE OF SERVICES	1
3.0 REGIONAL GEOLOGY AND SEISMOLOGY	2
4.0 GEOTECHNICAL AND GEOLOGIC FIELD INVESTIGATION	3
4.1 Surface Investigation and Site Description	3
4.2 Subsurface Conditions	4
5.0 SEISMIC HAZARDS	5
5.1 Liquefaction and Strain Softening	5
5.2 Lateral Spreading	7
6.0 DESIGN RECOMMENDATIONS	7
6.1 Foundation Support	7
6.2 Seismic Design Considerations	9
6.3 Retaining Structures	10
6.4 Pavement Design	10
6.5 Drainage	13
7.0 CONSTRUCTION RECOMMENDATIONS	14
7.1 Site Preparation and Grading	14
7.2 Construction Traffic and Staging	15
7.3 Cut and Fill Slopes	16
7.4 Excavation	17
7.5 Dewatering	17
7.6 Materials	18
7.7 Erosion Control Measures	23
8.0 CONCLUSION AND LIMITATIONS	23
REFERENCES	
FIGURES	
APPENDICES	

LIST OF FIGURES

<u>Number</u>	<u>Title</u>
1	Site Location Map
2	Exploration Location Map
2A	Preliminary Site Plan
3	Surcharge-Induced Lateral Earth Pressures
4	Typical Perimeter Footing Drain Detail
5	Typical Perforated Drainpipe Trench Detail
6	Typical Drainage Mat Detail
7	Typical Under Slab Drainage Detail
8	Typical Cut and Fill Slope Cross-Section
9	Minimum Foundation Slope Setback Detail

LIST OF APPENDICES

<u>Number</u>	<u>Title</u>
A	Subsurface Exploration Program
B	Laboratory Test Results
C	Soil and Rock Classification Information
D	Photo Log
E	Report Limitations and Important Information



GEOTECHNICAL ENGINEERING REPORT

SEASON ON MEEKER

PUYALLUP, WASHINGTON

1.0 INTRODUCTION

Columbia West Engineering, Inc. (Columbia West) was retained by Palindrome Puyallup, LLC, to conduct a geotechnical site investigation for use in design and construction of the proposed Season on Meeker project located in Puyallup, Washington. This report is subject to the limitations expressed in Section 8.0, *Conclusion and Limitations*, and Appendix E.

1.1 General Site Information

As indicated on Figures 1 and 2, the subject site is located at 115 2nd Street Southeast in Puyallup, Washington and is comprised of tax parcels 7060000030, 7060000020, and a portion of parcel 7060000070 totaling approximately 2 acres. The approximate latitude and longitude are N 47° 11' 29" and W 122° 17' 32". The site is currently occupied by a commercial development and associated asphalt parking areas and drive aisles. The regulatory jurisdictional agency is the City of Puyallup, Washington.

1.2 Project Understanding

Columbia West understands the current scope of development includes the construction of a new multi-structure, mixed commercial and residential district. A conceptual site plan is shown on Figure 2A. Buildings are anticipated to have a maximum of 5 stories and will likely consist of wood framing or wood framing over a concrete podium. Structural details of the individual buildings were not available at the time of this report. We have assumed buildings will have maximum column, wall, and slab loads of 350 kips, 4 kips per foot, and 100 psf, respectively. We have also assumed that cuts and fill will be no greater than 3 feet each. Development will also include asphalt drive aisles and parking stalls, utilities, and stormwater management facilities.

2.0 SCOPE OF SERVICES

Columbia West's scope of services was outlined in a proposal dated July 7, 2023. In accordance with our proposal, we performed the following geotechnical services:

- Reviewed information available in our files from previous geological and geotechnical studies conducted in the vicinity of the site.
- Reviewed preliminary plans provided by the design team.
- Conducted a subsurface exploration program at the site that included:
 - One boring drilled to a depth of 56.5 feet BGS and two borings drilled to a depth of 31.5 feet BGS.
 - Three cone penetration tests (CPTs) to depths of 60 to 80 feet BGS.
 - Four test pits excavated to a maximum depth of 10 feet BGS
 - Infiltration testing was conducted in two test pits.

- Collected disturbed and relatively undisturbed soil samples from the borings and test pits for laboratory analysis.
- Classified and logged observed soil and groundwater conditions.
- Prepared this geotechnical engineering report for the proposed development, which includes:
 - Subsurface soil and groundwater conditions
 - Summary of geologic and seismic literature research used to evaluate relevant seismic risks, including locations of faults and earthquake magnitudes
 - Liquefaction, strain softening, and lateral spreading potential
 - Fill- and load-induced settlement potential
 - Geotechnical design and construction recommendations for:
 - Foundation support recommendations including allowable bearing capacity, estimated foundation settlement and lateral resistance parameters;
 - Retaining walls, including drainage, backfill, and lateral earth pressures
 - Site preparation and grading, organic stripping, fill placement and compaction, over-excavation, and construction monitoring and testing
 - Structural fill materials, onsite soil suitability, and import aggregate specifications
 - Utility trench excavation and backfill
 - Drainage and management of groundwater conditions
 - Infiltration test results
 - Asphaltic concrete pavement construction for access roads and parking lots, including section thicknesses for base aggregate and asphalt layers
 - Seismic design parameters in accordance with *ASCE 7-16*

3.0 REGIONAL GEOLOGY AND SEISMOLOGY

According to the “Geologic Map of the Tacoma 1:100,000-scale Quadrangle, Washington” (Schuster et. Al. 2015) the site is underlain by Quaternary alluvium (Qa). The alluvium is described as unconsolidated or semi-consolidated clay, silt, sand, gravel or cobble deposits. Alluvium deposits in this region are anticipated to be underlain by lahars and mudflow deposits from Mt. Rainier.

Three seismic sources could cause ground shaking at the site. Two of the possible earthquake sources are associated with the Cascadia Subduction Zone (CSZ), and the third event is a shallow, local crustal earthquake that could occur in the North American plate. The three earthquake scenarios are discussed below.

The CSZ is the region where the Juan de Fuca Plate is being subducted beneath the North American Plate. This subduction is occurring in the coastal region between Vancouver Island and northern California. Evidence has accumulated suggesting that this subduction zone has generated eight great earthquakes in the last 4,000 years, with the most recent

event occurring approximately 300 years ago (Weaver and Shedlock, 1991). The fault trace is mapped approximately 50 to 120 km off the Oregon and Washington Coast. Two types of subduction zone earthquakes are possible:

1. An interface event earthquake on the seismogenic part of the interface between the Juan de Fuca Plate and the North American Plate on the CSZ. This source is reportedly capable of generating earthquakes with a moment magnitude of between 8.5 and 9.0.
2. A deep intraplate earthquake on the seismogenic part of the subducting Juan de Fuca Plate. These events typically occur at depths of between 30 and 60 km. This source is capable of generating an event with a moment magnitude of up to 7.5.

Crustal Events

There are at least three major known faults or fault zones in the vicinity of the site that may be capable of generating potentially destructive horizontal accelerations. These fault zones are described briefly in Table 1.

Table 1. Faults Within the Site Vicinity

Fault Name	Proximity to Site ¹ (km)	Mapped Length ¹ (km)
Seattle Fault Zone	37	69
Tacoma Fault	7	23
Southern Whidbey Island Fault Zone	60	64

1. Reported by USGS Quaternary Fault and Fold Database of the United States

4.0 GEOTECHNICAL AND GEOLOGIC FIELD INVESTIGATION

A geotechnical field investigation that consists of visual reconnaissance, three CPTs (CPT-1 through CPT-3), three drilled borings (B-1 through B-3), and four test pits (TP-1 through TP-4) was conducted on July 17 and 18, and August 2, 2023. A detailed description of the exploration program and explorations logs are presented in Appendix A. Laboratory test results are presented in Appendix B. Soil descriptions and classification information are provided in Appendix C. A photo log is presented in Appendix D.

4.1 Surface Investigation and Site Description

The conceptual layout presented on Figure 2A shows the subject site is split between the west and east sides of 2nd Street Southeast between East Meeker Street and East Main in Puyallup, Washington. The portion of the site west of 2nd Street Southeast is comprised of both open and covered asphalt parking areas and drive aisles. These features are bordered to the west by various commercial developments not associated with the current project.

The portion of the site east of 2nd Street Southeast consists of an approximately 12,000 square-foot, single-story commercial building in the southwest corner and open asphalt parking areas and drive aisles throughout the remainder of the site. It is bound on the east by 3rd Street Southeast. Site vegetation in both portions is limited to isolated landscape

islands and trees. Field reconnaissance and review of topographic mapping of the site indicates relatively flat terrain with grades less than 5 percent. Site elevations range from approximately 37 to 40 feet above mean sea level (amsl).

4.2 Subsurface Conditions

CPTs were advanced to depths between 60 and 80 feet BGS. Borings were drilled to depths between 31.5 and 56.5 feet BGS. Test pits were excavated to a maximum depth of 10 feet BGS. Exploration locations were selected to observe subsurface soil characteristics in proximity to proposed development areas and are shown on Figure 2. Exploration logs are presented in Appendix A, *Subsurface Exploration Program*.

4.2.1 Soil Type Description

The geologic units described below were observed during our subsurface exploration: existing pavement section, existing fill, and fine-grained flood deposits.

Existing Pavement Section

Explorations were advanced through approximately 2 to 3 inches of asphalt in existing parking areas and drive aisles. At the locations of TP-1, TP-4, and B-1 through B-3, the asphalt was underlain by 2 to 9 inches of gravel or crushed aggregate. Asphalt at the location of TP-3 was underlain by silty sand fill. A concrete slab was encountered immediately beneath the asphalt in TP-2 and beneath the asphalt and crushed aggregate in B-2.

Existing Fill

Existing fill was observed in all test pits and extended between approximately 1 and 4 feet BGS. Depth of fill west of 2nd Street SE was not determined due to practical refusal of the mini excavator on a concrete slab immediately beneath the asphalt at the location of TP-2.

Fill observed underlying pavement sections generally consists of loose, gray to brown, moist silty sand. Minor to significant caving occurred in test pits TP-3 and TP-4 at approximately 2 feet BGS. Additional recommendations pertaining to existing fill are presented in Section 7.1.1, *Existing Fill*.

Fine-Grained Flood Deposits

Underlying the pavement and existing fill, the profile generally consists of interbedded layers of very soft to very stiff silts with varying proportions of sand and very loose to medium dense silty and clayey sand. Reference to CPT-1 (vicinity of B-2) indicates silty sand deposits increase in relative density below the terminal depth of the boring from approximately 25 to 40 feet before transitioning to very soft to soft compressible silts and clays. The relatively dense sand layer decreases in thickness moving east across the site from CPT-2 to CPT-3. Reference to CPT-3 also indicates the lower compressible materials extend to approximately 65 feet BGS where they are underlain by denser silt and sand mixtures.

4.2.2 Groundwater

Groundwater was encountered in test pits TP-1, TP-3 and TP-4 at depths ranging from 8.5 to 9 feet bgs. Pore pressure dissipation tests conducted within the CPTs indicate an phreatic

surface between 7 and 10 feet BGS. Groundwater was not observed in the borings due to mud rotary drilling methods.

Groundwater levels are often subject to seasonal variance and may rise during extended periods of increased precipitation or flooding. Seeps and springs may become evident during site grading, primarily along slopes or in areas cut below existing grade. Structures, roads, and drainage design should be planned accordingly. Piezometer installation and long-term monitoring, beyond the scope of this investigation, would be necessary to provide more detailed groundwater information.

4.2.3 Infiltration Testing

Infiltration potential of site soils was evaluated through in situ infiltration testing in test pits TP-1 and TP-4. Single-ring, falling head infiltration testing was performed by embedding a 3-inch diameter steel pipe into undisturbed soil, filling the apparatus with water, and measuring time relative to changes in hydraulic head. Representative soil samples were collected from select test locations and submitted for laboratory analysis. Results of in situ infiltration testing are presented in Table 2.

Table 2. Infiltration Test Results

Test Number	Location (See Figure 2)	Approximate Test Depth (feet BGS)	Approximate Depth to Groundwater on 08-02-23 (feet BGS)	USCS Soil Type	Passing No. 200 Sieve (percent)	Measured Infiltration Rate (inches/hour)
IT-1.1	TP-1	2	9	SM, Silty SAND	36	0.4
IT-1.2	TP-1	5	9	SM, Silty SAND	34	0.9
IT-4.2	TP-4	6	8.5	SM, Silty SAND	18	8

Due to the presence of near-surface existing fill, shallow groundwater, and fine-textured, low permeability soils at the site, subsurface disposal of concentrated stormwater is infeasible.

5.0 SEISMIC HAZARDS

5.1 Liquefaction and Strain Softening

Liquefaction is a phenomenon caused by a rapid increase in pore water pressure that reduces the effective stress between soil particles to near zero. The excessive buildup of pore water pressure results in the sudden loss of shear strength in a soil. Granular soil, which relies on interparticle friction for strength, is susceptible to liquefaction until the excess pore pressures can dissipate. Sand boils and flows observed at the ground surface after an earthquake are the result of excess pore pressures dissipating upwards, carrying soil particles with the draining water. In general, loose, saturated sand soil with low silt and clay content is the most susceptible to liquefaction. Low plasticity, silty sand and silt may be moderately susceptible to liquefaction under relatively higher levels of ground shaking.

The cyclic and post-cyclic behavior of silt has been well-documented as intermediate between the generalized either “sand-like” or “clay-like”, thereby adding a level of complexity to projects focused on the seismic performance of earth retention systems, foundations, and

slope stability involving silt. Laboratory-based investigations of the cyclic resistance and post-cyclic stress-strain behavior of this intermediate, or “transitional”, soil have contributed to the understanding of the practice-oriented procedures.

5.1.1 Liquefaction Analysis

The evolution of perspectives on post-cyclic behavior (i.e., volumetric strain, residual undrained shearing resistance, vulnerability of lateral spread and ground failure) of silt is similar in the sense that laboratory-based procedures developed for clean sands and silty sands must be applied judiciously, if at all, for transitional soil. The potentially significant differences in cyclic shear strain accumulation, progressive development of excess pore pressure, strain-dependent behavior of silt, and the implications for the seismic performance of embankments, bridge foundations and appurtenant structures are documented in a database compiled by New Albion, Geotechnical, Inc, for the Oregon Department of Transportation Bridge Engineering Section (New Albion, 2022). The data presented in this database suggest differences between the cyclic behavior of silts that classify as ML, CL, MH and CH based on USCS classification and loose sands. The silt soils do not exhibit such dramatic degradation of stiffness even after developing shear strains of 3 percent and larger. Most of the tests performed did not reach 3 percent shear strain by the end of the cyclic loading phase (after 50 to 200 cycles). Based on the testing conducted on fine-grained soil, such as those present at the subject site, we believe that soil will not lose significant strength and will undergo volumetric strain of between 0.5 and 1 percent.

Our analysis was conducted using the 2014 methodology developed by Boulanger and Idriss. Maximum total post cyclic is predicted to be approximately 5 inches. A differential settlement of 2.5 inches can be assumed over a distance of 50 feet.

As published by *ASCE 7-16*, soil improvement or deep foundations are required if seismic differential settlement exceeds the values presented in *Table 12.13-3*. Settlement tolerances in *Table 12.13-3* are based on the construction type, column spacing, and risk category of a given structure. We understand that the proposed structures will meet the criteria for Risk Category I or II. *Table 3* presents the maximum tolerable seismic settlement limits for various column spacing for Risk Category I and II structures. As presented in the table, the allowable seismic settlement increases with column spacing.

Information regarding proposed building types and column spacing was not available at the time this report was prepared. If the anticipated differential settlement of 2.5 inches is less than the maximum allowable limit for the proposed building type and column spacing, ground improvement or deep foundations are not required per *ASCE 7-16*. Proposed buildings meeting these criteria may therefore be supported by conventional spread footings without ground improvement or deep foundations, provided the risk of structural damage following a seismic event is acceptable. If the risk of damage following a seismic event cannot be accepted, we recommend that the structure be supported by RAPs that are designed and installed by a qualified design-build specialty contractor. Additional discussion is presented in Section 6.1.1, *Spread Footings Bearing on RAPs*.

**Table 3. ASCE 7-16 Allowable Seismic Differential Settlement (in inches)
for Risk Category I and II Structures**

Type of Structure	Column Spacing (feet)						
	20	25	30	35	40	45	50
Single-story Structures with Concrete or Masonry Walls	1.8	2.2	2.7	3.1	3.6	4.0	4.5
Multi-Story Structures with Concrete or Masonry Walls	1.2	1.5	1.8	2.1	2.4	2.7	3
Other Single-Story Structures	3.6	4.5	5.4	6.3	7.2	8.1	9
Other Multi-Story Structures	2.4	3	3.6	4.2	4.8	5.4	6

5.2 Lateral Spreading

Lateral spreading is a liquefaction-related seismic hazard that occurs on gently sloping or flat sites underlain by liquefiable sediment adjacent to an open face, such as a riverbank. Liquefied soil adjacent to an open face can flow toward the open face, resulting in lateral ground displacement. Lateral spreading can also occur where soil is strain-softened. Due to the lack of an open face on or near the proposed development area, lateral spreading is not a geotechnical design consideration.

6.0 DESIGN RECOMMENDATIONS

The geotechnical site investigation suggests the proposed development is generally compatible with surface and subsurface soils, provided the recommendations presented in this report are incorporated in design and implemented during construction. The primary geotechnical considerations for the project were summarized previously in the *Executive Summary*. Specific design and construction recommendations are presented in the following sections.

6.1 Foundation Support

The on-site alluvial soil is compressible. Based on the assumed building loads, it is our opinion that foundation settlement will likely exceed structural tolerances without ground improvement. The proposed buildings can be supported by conventional spread footings bearing on improved native soil or engineered structural fill that is underlain by ground improvement. Typical ground improvement techniques include RAP's, vibro replacement and cement deep soil mixed (CDSM) columns. This report focuses on RAP's but other techniques are acceptable.

6.1.1 Spread Footings Bearing on RAPs

The foundation system for buildings may consist of spread footings underlain by RAPs installed using a patented displacement mandrel. The displacement process allows for installation without generating significant soil spoils and eliminates the need for casing. These foundation systems are proprietary and are provided by design-build specialty contractors.

Our experience with local design-build contractors indicates the RAPs that use a displacement technique could result in an allowable bearing pressure of 4,000 to 6,000 psf. We anticipate that this value can be increased by one-third when considering transient loads such as wind and seismic forces. The RAPs are estimated to be approximately 40 to 50 feet long to penetrate through soft and seismic settlement-prone soils. The design-build contractors should be contacted to provide the actual allowable bearing pressures and RAP configurations. We anticipate the RAP foundation system can be installed to meet the settlement criteria for the buildings. The design-build contractor should complete a settlement analysis for the RAPs. The contractor can use the information in this report and, if necessary, should conduct additional explorations if the geotechnical information is insufficient. We recommend load testing of the RAPs to confirm design capacities.

Based on our prior experience with similar projects, installing the RAPs may require predrilling the upper few feet to increase the bearing capacity. Predrilling will encounter soft and loose soil, which will be prone to raveling, sloughing, and running conditions if groundwater is encountered. If casing is required to control raveling, sloughing, and running conditions, it will increase the costs typically seen with predrilling the upper few feet using “open hole” methods by advancing a bucket auger. Also, predrilling will generate soil spoils during installation.

Conventional spread foundations can be constructed over the completed RAPs. The footing will typically be supported on a minimum 3-inch-thick granular pad that extends the full dimension (width and length) of the footing (on and between the piers).

6.1.2 Settlement

The design-build contractor should conduct a settlement analysis for the ground improvement system. As discussed in Section 5.0, *Seismic Hazards*, we estimate total seismic settlement at the existing ground surface will be approximately 5 inches during a design-level earthquake. We anticipate differential settlement will be less than one-half of the total seismic settlement over a 50-foot distance. Post-liquefaction settlement of foundations supported by a ground improvement system will be estimated by the design-build ground improvement contractor.

6.1.3 Floor Slabs

To mitigate settlement, floor slabs should also be supported by RAPs as discussed in Section 6.1.1. To provide a capillary break, slabs should be underlain by at least 6 inches of compacted crushed aggregate that has less than 5 percent by dry weight passing the No. 200 Sieve. Geotextile may be used below the crushed aggregate layer to increase subgrade

support. Recommendations for floor slab base aggregate and subgrade geotextile are discussed in Section 7.6, *Materials*. The modulus of subgrade reaction for slabs should be provided by the RAP design-build specialty contractor.

6.2 Seismic Design Considerations

Seismic design for proposed structures is prescribed by *ASCE 7-16*. Due to the presence of liquefiable soils at the site, the site meets the criteria for Site Class F. If the fundamental period of the structure exceeds 0.5 second, a site-specific ground motion response analysis is required in accordance with *Section 21.1* of *ASCE 7-16*. If the proposed structure has a fundamental period of less than 0.5 second, seismic design parameters may be determined using the pre-liquefaction seismic site class, which is Site Class E. Seismic design parameters for Site Class E are presented in Table 4.

Table 4. ASCE 7-16 Seismic Design Parameters¹

	Short Period ($T_s = 0.2$ s)	1 Second Period ($T_1 = 1.0$ s)
MCE Spectral Acceleration	1.271	0.438
Site Class	F ²	
Site Coefficient	$F_a = 1.2^3$	$F_v = 2.3$
Adjusted Spectral Response Acceleration	$S_{MS} = 1.525$	$S_{M1} = 1.018$
Design Spectral Response Acceleration	$S_{DS} = 1.017$	$S_{D1} = 0.679$

1. The structural engineer should evaluate *ASCE 7-16* code requirements and exceptions to determine if these parameters are valid for design.
2. Seismic Site Class E can be assumed to compute base shear assuming that the fundamental period for the proposed structures will be less than 0.5 second.
3. F_a value corresponding to Site Class C in accordance with *ASCE 7-16, Section 11.4.8, Exception 1*.

For Site Class E sites with mapped maximum considered earthquake spectral response acceleration parameter S_s greater than or equal to 1.0 or S_1 greater than or equal to 0.2, a ground motion hazard analysis may be required according to *ASCE 7-16, Section 11.4.8* unless exemption criteria are met. According to *ASCE 7-16, Section 11.4.8, Exception 1*, a ground motion hazard analysis is not required for Site Class E sites with S_s greater than or equal to 1.0, provided the site coefficient F_a is taken as equal to that of Site Class C.

According to *ASCE 7-16, Section 11.4.8, Exception 3*, a ground motion hazard analysis is also not required for Site Class E sites with S_1 greater than or equal to 0.2, provided that T is less than or equal to T_s , where T is the fundamental period of the structure and T_s is equal to the design spectral response acceleration parameter at a one second period (SD_1) divided by the design spectral response acceleration parameter at short periods (SD_s).

Columbia West recommends that structural engineers on the project evaluate code requirements and exceptions to determine if a site-specific ground motion hazard evaluation will be required for the proposed structures.

6.3 Retaining Structures

Lateral earth pressures should be considered during design of retaining walls and below-grade structures. Hydrostatic pressure and additional surcharge loading should also be considered. Wall foundation construction and bearing capacity should adhere to specifications provided previously in Section 6.1, *Foundation Support*.

Permanent retaining walls that are not restrained from rotation should be designed for active earth pressures using an equivalent fluid pressure of 35 pcf. Walls that are restrained from rotation should be designed for an at-rest, equivalent fluid pressure of 55 pcf. The recommended earth pressures assume a maximum wall height of 10 feet with well-drained, level backfill. These values also assume that adequate drainage is provided behind retaining walls to prevent hydrostatic pressures from developing. Lateral earth pressures induced by surcharge loads may be estimated using the criteria presented on Figure 3.

Seismic forces may be calculated by superimposing a uniform lateral force of $7H^2$ pounds per lineal foot of wall, where H is the total wall height in feet. The force should be applied as a distributed load with the resultant located at $0.6H$ from the base of the wall.

6.3.1 Wall Drainage and Backfill

A minimum 4-inch-diameter, perforated collector pipe should be placed at the base of retaining walls. The pipe should be embedded in a minimum 2-foot-wide zone of angular drain rock that is wrapped in a drainage geotextile fabric and extends up the back of the wall to within 1 foot of finished grade. The drain rock and geotextile drainage fabric should meet the specifications provided in Section 7.6, *Materials*. The perforated collector pipes should discharge at an appropriate location away from the base of the wall. The discharge pipe(s) should not be tied directly into stormwater drainage systems unless measures are taken to prevent backflow into the drainage system of the wall.

Backfill material placed behind the walls and extending a horizontal distance of $\frac{1}{2} H$, where H is the height of the retaining wall, should consist of select granular material placed and compacted as described in Section 7.6.1, *Structural Fill*.

Settlement of up to 1 percent of the wall height commonly occurs immediately adjacent to the wall as the wall rotates and develops active lateral earth pressures. Consequently, we recommend that construction of flatwork adjacent to retaining walls be delayed at least four weeks after placement of wall backfill, unless survey data indicates that settlement is complete prior to that time.

6.4 Pavement Design

6.4.1 Design Parameters and Traffic

Pavement should be installed on firm, competent native subgrade soil or engineered structural fill prepared as described in this report. Constructing pavement on undocumented fill is possible provided the risk of future maintenance is acceptable. If pavement is constructed over the existing fill we recommend the upper 18-inches of fill be scarified and compacted in place or amended with cement or lime. Our pavement recommendations are based on the following design parameters and assumptions:

- Pavement subgrade is prepared in accordance with the recommendations in this report.
- Resilient moduli for subgrade soil and aggregate base materials were assumed to be 4,500 psi and 20,000 psi, respectively.
- Pavement design life of 20 years with no expected traffic growth.
- Initial and terminal serviceability indices of 4.2 and 2.5, respectively.
- Reliability of 85 percent and standard deviation of 0.4.
- Pavement may be exposed to a fire apparatus load of 75,000 pounds on an infrequent basis.

The specific type and frequency of traffic was not available at the time we prepared this report. Based on experience, we assume that heavy truck traffic will consist of approximately 40 percent FHWA Class Group 6 type trucks (4-axle, single unit) and 60 percent FHWA Class Group 8 type trucks (tractor/trailer 2- to 3-axle). Lightly-loaded drive aisles and parking stalls are expected to service typical passenger vehicle traffic.

6.4.2 Asphaltic Concrete (AC) Pavement Design Sections

Pavement design recommendations for a range of traffic conditions and loading scenarios are presented in Table 5. Material properties and compaction recommendations for asphalt surfacing and crushed aggregate base layers are presented in Section 7.6, *Materials*.

Table 5. Recommended AC Pavement Sections Constructed over Native Soil or Engineered Fill

Traffic	Trucks Per Day	Equivalent Single-Axle Loads (ESALs)	AC Thickness (in)	Base Aggregate Thickness (in)
Passenger Vehicle Parking	0	10,000	2.5	8
Passenger Vehicle Drive Aisles	0	20,000	3	9
Heavy Truck Areas	10	92,000	4	10.5
	25	229,000	4.5	12.5
	50	458,000	5	14
	100	916,000	5.5	16.5

Pavement sections may be reduced in areas where subgrade soils are cement-amended to a minimum depth of 12 inches and have achieved a seven-day unconfined compressive strength of 100 psi, AC pavement sections may be constructed as presented in Table 6.

Table 6. Recommended AC Pavement Sections Constructed over Cement-Amended Subgrade Soil

Traffic	Trucks Per Day	Equivalent Single-Axle Loads (ESALs)	AC Thickness (in)	Base Aggregate Thickness (in)	Cement-Amendment Thickness (in)
Passenger Vehicle Parking	0	10,000	2.5	4	12
Passenger Vehicle Drive Aisles	0	20,000	3	4	
Heavy Truck Areas	10	92,000	4	4	
	25	229,000	4.5	4	
	50	458,000	5	4	
	100	916,000	5.5	6	

6.4.3 General Pavement Recommendations

Recommended pavement section thicknesses are intended to be minimum acceptable values and do not include construction traffic loading. The recommendations assume that pavement construction will be completed during an extended period of warm, dry weather. Wet weather construction may require an increased thickness of base aggregate as discussed later in Section 7.2, *Construction Traffic and Staging*.

Cement-amended soil should be allowed to cure for at least four days prior to aggregate base placement or exposure to construction traffic. Prior to construction traffic access, the cement-amended subgrade should be protected by a minimum 4-inch-thick layer of compacted crushed aggregate. Construction traffic should be limited to dedicated haul roads or non-structural, unpaved portions of the site. Construction traffic should not be permitted on new pavement, unless accounted for in the pavement design section. Base aggregate and cement-amended soils supporting pavement are also not intended for construction traffic. Haul roads and staging areas supporting construction traffic are discussed later in Section 7.2, *Construction Traffic and Staging*.

Asphalt paving is generally not recommended during cold weather conditions where ambient air temperatures are less than 40 degrees Fahrenheit. Compacting asphalt in low-temperature conditions can result in low relative density of the asphalt layer and premature pavement distress.

Asphalt mix designs have a recommended compaction temperature range that is specific to the AC binder used. In low-temperature conditions, maintaining the temperature of the AC mix is difficult as heat can be lost during transport, placement, and compaction. The ambient air temperature during paving should be at least 40 degrees Fahrenheit for a lift thickness greater than 2.5 inches and at least 50 degrees Fahrenheit for a lift thickness between 2 and 2.5 inches. If AC paving must take place during cold-weather construction as defined in this section, the contractor and design team should discuss options for minimizing risk to pavement serviceability.

6.5 Drainage

At a minimum, site drainage should include surface water collection and conveyance to properly designed stormwater management structures and facilities. Drainage design in general should conform to City of Puyallup regulations. Finished site grading should be conducted with positive drainage away from structures at a minimum 2 percent slope for a distance of at least 10 feet. Depressions or shallow areas that may retain ponding water should be avoided.

Recommendations for foundation drains, subdrains, and sub-slab drainage are presented in the following sections. Drain rock and geotextile drainage fabric should meet the requirements presented in Section 7.6, *Materials*. Drains should be closely monitored after construction to assess their effectiveness. If additional surface or shallow subsurface seeps become evident, the drainage provisions may require modification or additional drains. We should be consulted to provide appropriate recommendations.

6.5.1 Foundation Drains

Roof drains and perimeter foundation drains should be considered for the proposed structures. Foundation and roof drains should consist of separate systems that gravity flow away from foundations to an approved discharge location. Perimeter foundation drains should consist of 4-inch perforated PVC pipe surrounded by a minimum 2-foot-wide zone of clean, washed drain rock wrapped with geotextile drainage fabric. The wrapped drain rock zone should extend up the sides of embedded walls to within 12 inches of proposed finished grade. Foundation drains should be constructed with a minimum slope of ½ percent. The drainpipe's invert elevation should be at least 18 inches below the elevation of the floor slab. Figure 4 presents a typical foundation drain detail.

6.5.2 Subdrains

Subdrains should be considered if portions of the site are cut below surrounding grades. Shallow groundwater, springs, or seeps should be conveyed via drainage channel or perforated pipe into an approved discharge. Recommendations for design and installation of perforated drainage pipe may be performed on a case-by-case basis by Columbia West during construction. Failure to provide adequate surface and sub-surface drainage may result in soil slumping or unanticipated settlement of structures exceeding tolerable limits. A typical perforated drainpipe trench detail is presented in Figure 5.

6.5.3 Drainage Mat

Site improvements construction in some areas may occur at or near the shallow groundwater table, particularly if work is conducted during wet-weather conditions. Dewatering may be necessary, and a drainage mat may be required to achieve sufficient elevation for fill placement. A typical drainage mat is shown on Figure 6. Columbia West should determine drainage mat location, extent, and thickness when subsurface conditions are exposed. Drainage mats may need to be constructed in conjunction with subdrains to convey captured water to an approved discharge location.

6.5.4 Sub-Slab Drains

Under slab drains may be necessary in areas where the finished floor grade will be at or below existing grades. Floor slabs established at or below existing grade may encounter shallow groundwater conditions. Depending on the depth of the cut and depth to groundwater, a series of under slab drainage pipes may need to be installed. Figure 7 shows a typical under slab drainage detail.

7.0 CONSTRUCTION RECOMMENDATIONS

7.1 Site Preparation and Grading

Vegetation, organic material, unsuitable fill, and deleterious material that may be encountered should be cleared from areas identified for structures and site grading. Vegetation, root zones, organic material, and debris should be removed from the site. Stripped topsoil, if encountered, should also be removed or used only as landscape fill in nonstructural areas with slopes less than 25 percent. The post-construction maximum depth of landscape fill placed or spread at any location onsite should not exceed one foot.

The required stripping depth may increase in areas of existing fill or previously-existing structures. Actual stripping depths should be determined based upon visual observations made during construction when soil conditions are exposed.

Previously disturbed soil, debris, or undocumented fill encountered during grading or construction activities should be removed completely and thoroughly from structural areas. This includes old remnant foundations, basement walls, utilities, associated soft soils, and debris. Excavation areas should be backfilled with engineered structural fill.

Test pits excavated during site exploration were backfilled loosely with onsite soils. These excavations should be located and properly backfilled with structural fill during site improvements construction.

Site grading activities should be performed in accordance with requirements specified in the *2018 International Building Code* (IBC), Chapter 18 and Appendix J, with exceptions noted in the text herein. Site preparation, soil stripping, and grading activities should be observed and documented by Columbia West.

7.1.1 Existing Fill

Existing fill was observed underlying the pavement section in all test pits. The fill is reported to be between 0.75 and 4 feet thick and generally consists loose, gray to brown, moist silty sand. A 3-inch thick concrete slab was also observed underlying the pavement section in test pit TP-2 and boring B-2.

Existing fill and other previously disturbed soils or debris are not suitable for supporting structures in their current state and should be removed completely removed from the influence zone of foundations unless otherwise directed by the ground improvement design-build contractor. Areas of the site where additional fill is planned, existing fill should be removed until firm native soils are encountered prior to the placement of additional fill.

To minimize long-term risk of adverse impacts to pavements, existing fill should also be thoroughly removed from proposed pavements and slabs-on-grade. If existing fill is left in place, pavement structures and slabs on grade may experience a reduction in long-term serviceability due to premature pavement or slab distress which could include asphalt cracking, localized grade depressions, and inadequate drainage. The decision to construct pavements over existing fill and acceptance of the associated risk should be made by the owner and project stakeholders.

Partial mitigation of premature pavement distress risk may be accomplished by over-excavation and backfill with granular structural fill or application of cement amended materials. If this option is selected, Columbia West should be contacted for additional analysis and study, but would likely consist of improving the upper 18-inches of existing fill. This can be accomplished by scarifying and compacting it in place, cement emending it, or removing it and replacing it with structural fill.

Based upon Columbia West's investigation, existing fill soils as described appear to be acceptable for reuse as structural fill, provided materials are observed to exhibit index properties similar to those observed during this investigation and that construction adheres to the specifications presented in this report. Note that the limited scope of exploration conducted for this investigation cannot wholly eliminate uncertainty regarding the presence of unsuitable soils in areas not explored.

7.1.2 Subgrade Evaluation

Upon completion of stripping and prior to the placement of structural fill or pavement improvements, exposed subgrade soil should be evaluated by proof rolling with a fully-loaded dump truck or similar heavy, rubber tire construction equipment. When the subgrade is too wet for proof rolling, a foundation probe may be used to identify areas of soft, loose, or unsuitable soil. Subgrade evaluation should be performed by Columbia West. If soft or yielding subgrade areas are identified during evaluation, we recommend the subgrade be over-excavated and backfilled with compacted imported granular fill.

7.2 Construction Traffic and Staging

Near-surface soils will be easily disturbed during construction. If not carefully executed, site preparation, excavation, and grading can create extensive soft areas resulting in significant repair costs. Earthwork planning should include considerations for minimizing subgrade disturbance, particularly during wet-weather conditions.

If construction occurs during wet-weather conditions, or if the moisture content of the surficial soil is more than a few percentage points above optimum, site stripping and cutting may need to be accomplished using track-mounted equipment. Under these conditions, granular haul roads and staging areas will also be necessary to provide a firm support base and sustain construction equipment.

The recommended base aggregate thickness for pavement sections is intended to support post-construction design traffic loads and will not provide adequate support for construction traffic. Staging areas and haul roads will require an increased base thickness during wet

weather conditions. The configuration of staging and haul road areas, as well as the required thickness of granular material, will vary with the contractor's means and methods. Therefore, design and construction of staging areas and haul roads should be the responsibility of the contractor. Based on our experience, between 12 and 18 inches of imported granular material is generally required in staging areas and between 18 and 24 inches in haul road areas. In areas of heavy construction traffic, geotextile separation fabric may be placed between the subgrade soil and imported granular material to increase subgrade support and minimize silt migration into the base aggregate layer.

As an alternative to thickened aggregate sections, haul roads and staging areas may be constructed using a combination of cement-amended subgrade and crushed aggregate surfacing. If cement-amendment is used, the base aggregate thickness for staging areas and haul roads can typically be reduced to between 6 and 9 inches, respectively. This recommendation is based on a minimum seven-day unconfined compressive strength of 100 psi for the cement-amended soil with a treatment depth of 12 to 16 inches. Based on experience, 6 to 7 percent cement by weight is typically required to achieve the indicated compressive strength.

Project stakeholders should understand that wet weather construction is risky and costly. Proper construction methods and techniques are critical to overall project integrity and should be observed and documented by Columbia West.

7.3 Cut and Fill Slopes

Fill slopes should consist of structural fill material as discussed in Section 7.6.1, *Structural Fill*. Fill placed on existing grades steeper than 5H:1V should be horizontally benched at least 10 feet into the slope. Fill slopes greater than six feet in height should be vertically keyed into existing subsurface soil. A typical fill slope cross-section is shown in Figure 8. Drainage implementations, including subdrains or perforated drainpipe trenches, may also be necessary in proximity to cut and fill slopes if seeps or springs are encountered. Drainage design may be performed on a case-by-case basis. Extent, depth, and location of drainage may be determined in the field by Columbia West during construction when soil conditions are exposed. Failure to provide adequate drainage may result in soil sloughing, settlement, or erosion.

Final cut or fill slopes at the site should not exceed 2H:1V or 10 feet in height without individual slope stability analysis. The values above assume a minimum horizontal setback for loads of 10 feet from top of cut or fill slope face or overall slope height divided by three (H/3), whichever is greater. A minimum slope setback detail for structures is presented in Figure 9.

Concentrated drainage or water flow over the face of slopes should be prohibited, and adequate protection against erosion is required. Fill slopes should be overbuilt, compacted, and trimmed at least two feet horizontally to provide adequate compaction of the outer slope face. Proper cut and fill slope construction is critical to overall project stability and should be observed and documented by Columbia West.

7.4 Excavation

The site was explored to a maximum depth of 10 feet with a mini excavator, 56.5 feet BGS with a truck-mounted drill rig, and 80 feet BGS with a truck-mounted CPT rig. A 3-inch thick concrete slab was encountered at the locations of test pit TP-2 and boring B-2. Conventional earthmoving equipment in proper working condition should generally be capable of making necessary site excavations. Appropriately sized equipment should be utilized in areas of buried slabs or other existing structural features encountered during demolition and site clearing operations.

Groundwater was observed in the test pits and CPTs at depths ranging from 7 to 10 feet BGS. Recommendations as described in Section 7.5, *Dewatering*, should be considered where subsurface construction activities intersect the shallow groundwater table.

Shoring is not required for temporary excavation shallower than 4 feet, however sidewalls may cave and slough. Caving and sloughing occurred in three of the test pit excavations conducted for this study. Reference to the test pit logs presented in Appendix A indicate caving conditions in test pits TP-1, TP-3, and TP-4. Open-cut excavation techniques may be used to excavate trenches between 4 and 8 feet deep, provided the walls of the excavation are cut at a maximum slope of 1H:1V and groundwater seepage is not present. Excavation slopes should be reduced to 1.5H:1V or 2H:1V if excessive sloughing or raveling occurs.

Shoring may be required if open-cut excavations are infeasible or if excavations are proposed adjacent to existing infrastructure. Typical methods for stabilizing excavations consist of soldier piles and timber lagging, sheet pile walls, tiebacks and shotcrete, or pre-fabricated hydraulic shoring. As a wide variety of shoring and dewatering systems are available, we recommend that the contractor be responsible for selecting the appropriate shoring and dewatering systems.

The contractor should be held responsible for site safety, sloping, and shoring. All excavation activity should be conducted in accordance with applicable OSHA requirements. Columbia West is not responsible for contractor activities and in no case should excavation be conducted in excess of applicable local, state, and federal laws.

7.5 Dewatering

Groundwater was observed between 7 and 10 feet in the subsurface explorations. Based on these observations, groundwater will likely be encountered in utility trench excavations and in areas of significant cut. Generalized recommendations for temporary construction dewatering are presented in the following section.

7.5.1 Construction Dewatering

The contractor should be responsible for temporary drainage of surface water, perched water, and groundwater. Dewatering should be performed to the extent necessary to prevent standing water and/or erosion of exposed site soils. During rough and finished grading of building pad areas, the contractor should keep all footing excavations and slab subgrade soils free of standing water.

The contractor's proposed dewatering plan should be capable of maintaining groundwater levels at least two feet below the base of proposed trench excavations. Without adequate trench dewatering, running soil, caving, and sloughing will increase backfill volumes and may result in damage to adjacent structures or utilities. Significant pumping and dewatering may be required to temporarily reduce the groundwater elevation to the recommended depth. Dewatering via a sump within excavation zones may be insufficient to control groundwater and provide excavation side slope stability. Dewatering may be more feasibly conducted by installing a system of temporary well points and pumps around proposed excavation areas or utility trenches. Depending on proposed utility depths, a site-specific dewatering plan may be necessary.

If groundwater is present at the base of utility excavations, we recommend placing 18 to 24 inches of stabilization material at the base of the excavation. Subgrade geotextile placed directly over trench subgrade soils may reduce the required thickness of the stabilization material. The actual thickness of stabilization material should be determined at the time of construction based on observed field conditions. Trench stabilization material should be placed in one lift and compacted until well keyed. Stabilization material and geotextile fabric should meet the requirements presented in Section 7.6, *Materials*.

7.6 Materials

7.6.1 Structural Fill

Areas proposed for fill placement should be appropriately prepared as described in Section 7.1, *Site Preparation and Grading*. Engineered fill placement should be observed by Columbia West. Compaction of engineered structural fill should be verified by nuclear gauge field compaction testing performed in accordance with *ASTM D6938*. Field compaction testing should be performed for each vertical foot of engineered fill placed.

Various materials may be acceptable for use as structural fill. Structural fill should be free of organic material or other unsuitable material and meet specifications provided in the following sections. Representative samples of proposed engineered structural fill should be submitted for laboratory analysis and approval by Columbia West prior to placement.

7.6.1.1 Onsite Soil

Most onsite native soil (silt and silty sand) will be suitable for use as structural fill if adequately dried or moisture-conditioned to achieve recommended compaction specifications. Native clay soil with a plasticity index greater than 25, if encountered, should be evaluated and approved by Columbia West prior to use as structural fill. Laboratory analysis indicated that the moisture content of site soil was above optimum at the time of exploration. Moisture conditioning will likely be necessary to dry the soil prior to applying compaction effort. In addition, the near-surface silt and clay will be moisture sensitive and difficult, if not impossible, to compact during wet weather conditions. Therefore, structural fill placement using onsite soil should be performed during dry summer months if possible. Onsite soil may also require addition of moisture during extended periods of dry weather.

Onsite soil used as structural fill should be placed in loose lifts not exceeding 8 inches in depth and compacted using standard conventional compaction equipment. The soil moisture content should be within a few percentage points of optimum conditions. The soil should be compacted to at least 95 percent of maximum dry density as determined by the modified Proctor moisture-density relationship test (*ASTM D1557*). Compacted onsite fill soils should be covered shortly after placement.

Onsite soil will likely expand during excavation and transport and consolidate during compaction. Development of site-specific expansion and consolidation factors is beyond the scope of this investigation. We can provide site-specific factors upon request.

7.6.1.2 Imported Granular Material

Imported granular material should consist of pit- or quarry-run rock, crushed rock, or crushed gravel and sand meeting *WSDOT 9-03.14(1)* specifications for *Gravel Borrow*. Imported granular material should be placed in loose lifts not exceeding 12 inches in depth and compacted to at least 95 percent of maximum dry density as determined by the modified Proctor moisture-density relationship test (*ASTM D1557*). During wet-weather conditions or where wet subgrade conditions are present, the initial loose lift of granular fill should be approximately 18 inches thick and should be compacted with a smooth-drum roller operating in static mode.

7.6.1.3 Stabilization Material

Stabilization material should consist of durable, 4- or 6-inch-minus pit- or quarry-run rock, crushed rock, or crushed gravel and sand that is free of organics and other deleterious material. The material should have a maximum particle size of 6 inches with less than 5 percent by dry weight passing the U.S. Standard No. 4 sieve. The material should have at least two mechanically-fractured faces.

Stabilization material should be placed in loose lifts between 12 and 24 inches thick and be compacted to a firm, unyielding condition. Equipment with vibratory action should not be used when compacting stabilization material over wet, fine-textured soils. If stabilization material is used to stabilize soft subgrade below pavement or construction haul roads, a subgrade geotextile should be placed as a separation barrier between the soil subgrade and the stabilization material.

7.6.1.4 Trench Backfill

Trench backfill placed below, adjacent to, and up to at least 12 inches above utility lines (i.e., the pipe zone) should consist of well-graded granular material meeting *WSDOT 9-03.12(3)* specifications for *Gravel Backfill for Pipe Zone Bedding*. Pipe zone backfill should be compacted to at least 90 percent of maximum dry density, as determined by the modified Proctor moisture-density relationship test (*ASTM D1557*), or as required by the local jurisdictional agency or pipe manufacturer.

Within structural areas (below pavement and building pads), trench backfill above the pipe zone should consist of *WSDOT 9-03.19 Bank Run Gravel for Trench Backfill* or *WSDOT 9-03.14(2) Select Borrow* with a maximum particle size of 2 ½-inches. Trench backfill

material within 18 inches of the top of utility pipes should be hand compacted (i.e., no heavy compaction equipment). Remaining trench backfill should be compacted to at least 95 percent of the maximum dry density as determined by the modified Proctor moisture-density relationship test (*ASTM D1557*), or as required by the local jurisdictional agency or pipe manufacturer.

Outside of structural areas, trench backfill placed above the pipe zone should be compacted to at least 90 percent of the maximum dry density as determined by the modified Proctor moisture-density relationship test (*ASTM D1557*), or as required by the local jurisdictional agency or pipe manufacturer.

7.6.1.5 Floor Slab Base Aggregate

Base aggregate for building floor slabs should consist of 1 ¼"-minus crushed aggregate meeting *WSDOT 9-03.9(3)* specifications for *Crushed Surfacing*. Slab base aggregate should be compacted to at least at least 95 percent of the maximum dry density as determined by the modified Proctor moisture-density relationship test (*ASTM D1557*).

7.6.1.6 Pavement Base Aggregate

Base aggregate for pavement should consist of 1 ¼"-minus crushed aggregate meeting *WSDOT 9-03.9(3)* specifications for *Crushed Surfacing*. Pavement base aggregate should be compacted to at least at least 95 percent of the maximum dry density as determined by the modified Proctor moisture-density relationship test (*ASTM D1557*).

7.6.1.7 Retaining Wall Backfill

Backfill material placed behind retaining walls and extending a horizontal distance of ½ H, where H is the height of the retaining wall, should consist of free-draining granular material meeting *WSDOT 9-03.12(2)* specifications for *Gravel Backfill for Walls*. The wall backfill should be separated from structural fill, native soil, and/or topsoil using a geotextile fabric that meets the specifications provided below for drainage geotextiles.

Wall backfill located within a horizontal distance of 3 feet from the face of a retaining wall should be compacted to 90 percent of the maximum dry density, as determined by *ASTM D1557*. Backfill placed within 3 feet of the wall should be compacted in loose lifts less than 6 inches thick using hand-operated tamping equipment (such as a jumping jack or vibratory plate compactor). Remaining wall backfill should be compacted to at least 95 percent of the maximum dry density, as determined by *ASTM D1557*.

7.6.1.8 Retaining Wall Leveling Pad

Crushed aggregate used as a leveling pad for retaining wall footings should consist of 1 ¼"-minus crushed aggregate meeting *WSDOT 9-03.9(3)* specifications for *Crushed Surfacing*. The leveling pad material should be compacted to at least 95 percent of the maximum dry density as determined by the modified Proctor moisture-density relationship test (*ASTM D1557*).

7.6.1.9 Drain Rock

Drain rock should consist of angular, granular material with a maximum particle size of 2 inches and less than 2 percent by weight passing the No. 200 sieve. Drain rock should be

free of roots, organic debris, and other unsuitable material and should have at least two mechanically-fractured faces. Drain rock should be compacted to a firm, unyielding condition. Drain rock should be completely wrapped in a geotextile drainage fabric meeting the requirements presented below.

7.6.1.10 Existing Concrete and Crushed Rock

Concrete and crushed rock from the existing pavement areas and structures can be used in general structural fill, provided particles greater than 3 inches are not present, it is thoroughly mixed and well graded so that there are no voids between the fragments, and the resulting mix is moisture conditioned for compaction. This material can be used as trench backfill if it meets the requirements for imported granular material, which would require a smaller maximum particle size. The material should be placed in lifts with a maximum uncompacted thickness of 12 inches and compacted to not less than 95 percent of the maximum dry density, as determined by ASTM D1557.

7.6.2 Geotextile Fabric

7.6.2.1 Subgrade Geotextile

Subgrade geotextile should meet the specifications provided in *WSDOT 9-33.2(1), Table 3, Geotextile for Separation or Soil Stabilization*. The geotextile should be installed in accordance with the manufacturer's recommendations. A minimum initial aggregate base lift of 6 inches is required over geotextiles. All stabilization material should be underlain by a subgrade geotextile.

7.6.2.2 Drainage Geotextile

Subgrade geotextile should meet the specifications provided in *WSDOT 9-33.2(1), Table 2, Geotextile for Underground Drainage Filtration Properties*. The AOS should be between the No. 70 and No. 100 sieve. The water permittivity should be greater than 1.5/sec. The geotextile should be installed in accordance with the manufacturer's recommendations. A minimum initial aggregate base lift of 6 inches is required over geotextiles.

7.6.3 Soil Amendment with Cement

The on-site soil can be amended with Portland cement to obtain suitable properties for use as wet-weather structural fill or subbase for pavement. The effectiveness of soil amendment is highly dependent on proper mixing techniques, soil moisture conditioning, and the quantity of cement. The quantity of cement applied during amendment should be based on an assumed dry unit weight of 100 pcf for site soil.

7.6.3.1 Subbase Stabilization

Specific recommendations for soil amendment should be based on exposed site conditions at the time of construction. For preliminary design purposes, we recommend cement-amended subgrade for building pads and pavement subbase (below the base aggregate layer) achieve a target strength of 100 psi after seven days. The quantity of cement required to achieve the target strength will vary with moisture content and soil type. Laboratory testing of cement-amended soil should be used to confirm design expectations.

The amount of cement added to the soil at the time of construction should be selected by the contractor based on observed field conditions and subgrade performance. During extended periods of dry weather, water may need to be applied during the amendment and tilling process to achieve the optimum moisture content required for compaction. Typically 6 to 8 percent cement by dry weight is sufficient to achieve a strength of 100 psi.

Cement-amendment equipment should have balloon tires to minimize softening, rutting, and disturbance of fine-grained site soil. A sheepsfoot or segmented pad roller with a minimum static weight of 40,000 pounds should be used for initial compaction. Rollers with vibratory action should not be used to compact fine-grained, cement-amended soil. Final compaction should be conducted with a smooth-drum roller with a minimum applied linear force of 700 pounds per inch. The amended soil should be compacted to at least 95 percent of the maximum dry density as determined by *ASTM D558*.

Following cement amendment, a minimum curing time of four days is required prior to exposure to construction traffic. Construction traffic should not be allowed on unprotected, cement-amended subgrade. To protect cement-amended areas from damage, the finished surface should be covered with 4 to 6 inches of imported granular material. The protective layer of crushed rock often becomes contaminated with soil during construction, particularly in staging and haul road areas. Contaminated aggregate, where present, should be removed and replaced with clean crushed aggregate prior to construction of pavement or other permanent site improvements supported by base aggregate.

Cement amendment should not be attempted during moderate to heavy precipitation or when the ambient air temperature is below 40 degrees Fahrenheit. Cement should not be placed in areas of standing water or where saturated subgrade conditions exist.

7.6.3.2 Cement-Amended Structural Fill

If adequate compaction is not achievable with onsite silt and clay due to moisture or weather conditions, the soil may be cement-amended and placed as general structural fill. Prior to placement of cement-amended fill, subgrade soils should be prepared as described in Section 8.1, *Site Preparation and Grading*. Where multiple lifts of cement-amended fill are necessary to meet finished grade, consecutive lifts may be placed immediately following amendment and compaction of the underlying lift. However, where the final lift of cement-amended fill will serve as building pad or pavement subbase material, the four-day cure period as discussed above is recommended.

7.6.3.3 Verification Testing

Cement-amendment of site soils should be observed and tested by Columbia West to document conformance with design recommendations. Cement spread rate should be verified with a pan sample test conducted at one random location per lift per 20,000 square-feet of cement-amended fill. Treatment depth should be verified through excavation of a small test pit and measurement at one random location per lift of cement-amended fill. Adequate compaction and moisture content should be verified by conducting nuclear gauge density testing at a frequency of approximately one test per 5,000 square feet of cement-amended fill in accordance with *ASTM D6938*. At least one representative sample

should be collected per day of cement-amendment, cured for 7 days, and tested for unconfined compressive strength in accordance with ASTM D1633. The tested samples should have a minimum 7-day, unconfined compressive strength of 100 psi.

7.6.3.4 Drainage Considerations

Cement-amended soil does not drain well and will not be suitable for planting areas. The material may also be difficult to excavate with light-duty landscaping equipment. Proposed landscape areas should not be cement-amended unless accommodations are made for drainage and planting.

Cement-amendment within building pad areas should consider the potential for trapped water below the floor slab. Columbia West should be consulted to provide appropriate recommendations if cement-amendment is proposed within building pad areas.

7.6.4 Pavement

7.6.4.1 Asphaltic Concrete

Asphaltic concrete should consist of HMA Class ½" adhering to *WSDOT 9-03.8(6), HMA Proportions of Materials*. The asphalt binder should consist of PG 58-22 meeting *WSDOT 9-02.1(4), Performance Graded (PG) Asphalt Binder*. Asphalt should be compacted to 91 percent of the theoretical maximum density as determined by *ASTM D2041*. Minimum and maximum asphalt lift thicknesses should be 2 and 3 inches, respectively. Nuclear gauge density testing should be conducted to verify adherence to recommended specifications. Testing frequency should be in accordance with WSDOT and City of Vancouver specifications.

7.7 Erosion Control Measures

Soil at this site is susceptible to erosion by wind and water; therefore, erosion control measures should be carefully planned and installed before construction begins. Surface water runoff should be collected and directed away from sloped areas to prevent water from running down the slope face. Measures that can be employed to reduce erosion include the use of silt fences, hay bales, buffer zones of natural growth, sedimentation ponds, and granular haul roads. All erosion control methods should be in accordance with local jurisdiction standards.

8.0 CONCLUSION AND LIMITATIONS

This geotechnical site investigation report was prepared in accordance with accepted standard conventional principles and practices of geotechnical engineering. This investigation pertains only to material tested and observed as of the date of this report and is based upon proposed site development as described in the text herein. This report is a professional opinion containing recommendations established by engineering interpretations of subsurface soils based upon conditions observed during site exploration. Soil conditions may differ between tested locations or over time. Slight variations may produce impacts to the performance of structural facilities if not adequately addressed. This underscores the importance of diligent QA/QC construction observation and testing to verify soil conditions are as anticipated in this report.

Therefore, this report contains several recommendations for field observation and testing by Columbia West personnel during construction activities. Columbia West cannot accept responsibility for deviations from recommendations described in this report. Future performance of structural facilities is often related to the degree of construction observation by qualified personnel. These services should be performed to the full extent recommended.

This report is not an environmental assessment and should not be construed as a representative warranty of site subsurface conditions. The discovery of adverse environmental conditions, or subsurface soils that deviate from those described in this report, should immediately prompt further investigation. The above statements are in lieu of all other statements expressed or implied.

This report was prepared solely for the client and is not to be reproduced without prior authorization from Columbia West. Final engineering plans and specifications for the project should be reviewed and approved by Columbia West as they relate to geotechnical and grading issues prior to final design approval. Columbia West is not responsible for independent conclusions or recommendations made by other parties based upon information presented in this report. Unless a particular service was expressly included in the scope, it was not performed and there should be no assumptions based upon services not provided. Additional report limitations and important information about this document are presented in Appendix E. This information should be carefully read and understood by the client and other parties reviewing this document.

Sincerely,

COLUMBIA WEST ENGINEERING, Inc.



Jason F. Merritt, P.E.
Senior Project Engineer

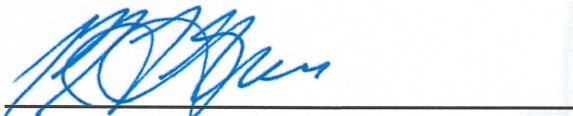

Brett A. Shipton, PE, GE
Principal



8/18/2023

JFM:BAS

Attachments: Figures 1 through 9

Appendix A through E

Document ID: Palindrome-1-01-01geor

REFERENCES

Annual Book of ASTM Standards, Soil and Rock (I), v04.08, American Society for Testing and Materials, 1999.

ASCE 7-16, Minimum Design Loads for Buildings and Other Structures, American Society of Civil Engineers, 2016.

Schuster et. Al, 2015, *Geologic Map of the Tacoma 1:100,000-scale Quadrangle, Washington*, Washington Division of Geology and Earth Resources, Map Series 2015-03



FIGURES



MAP SOURCE: Google Maps 2023

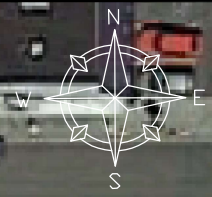

E MAIN AVEUNE

2ND STREET SE

3RD STREET SE

E MEEKER

Infiltration Test Results

Test Number	Location	Approximate Test Depth (feet bgs)	Approximate Depth to Groundwater on 08/02/23 (feet bgs)	USCS Soil Type	Passing No. 200 Sieve (%)	Measured Infiltration Rate (inches/hour)
IT-1.1	TP-1	2	9	SM, Silty SAND	26	0.4
IT-1.2		5		SM, Silty SAND	34	0.6
IT-4.2	TP-4	6	8.5	SM, Silty SAND	18	8

Existing Fill Thickness	
Exploration ID	Depth of Fill (feet)
TP-1	0.75
TP-2	*
TP-3	4
TP-4	4

* Depth of fill not determined due to refusal in concrete slab

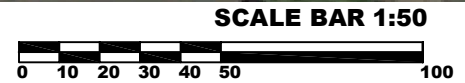
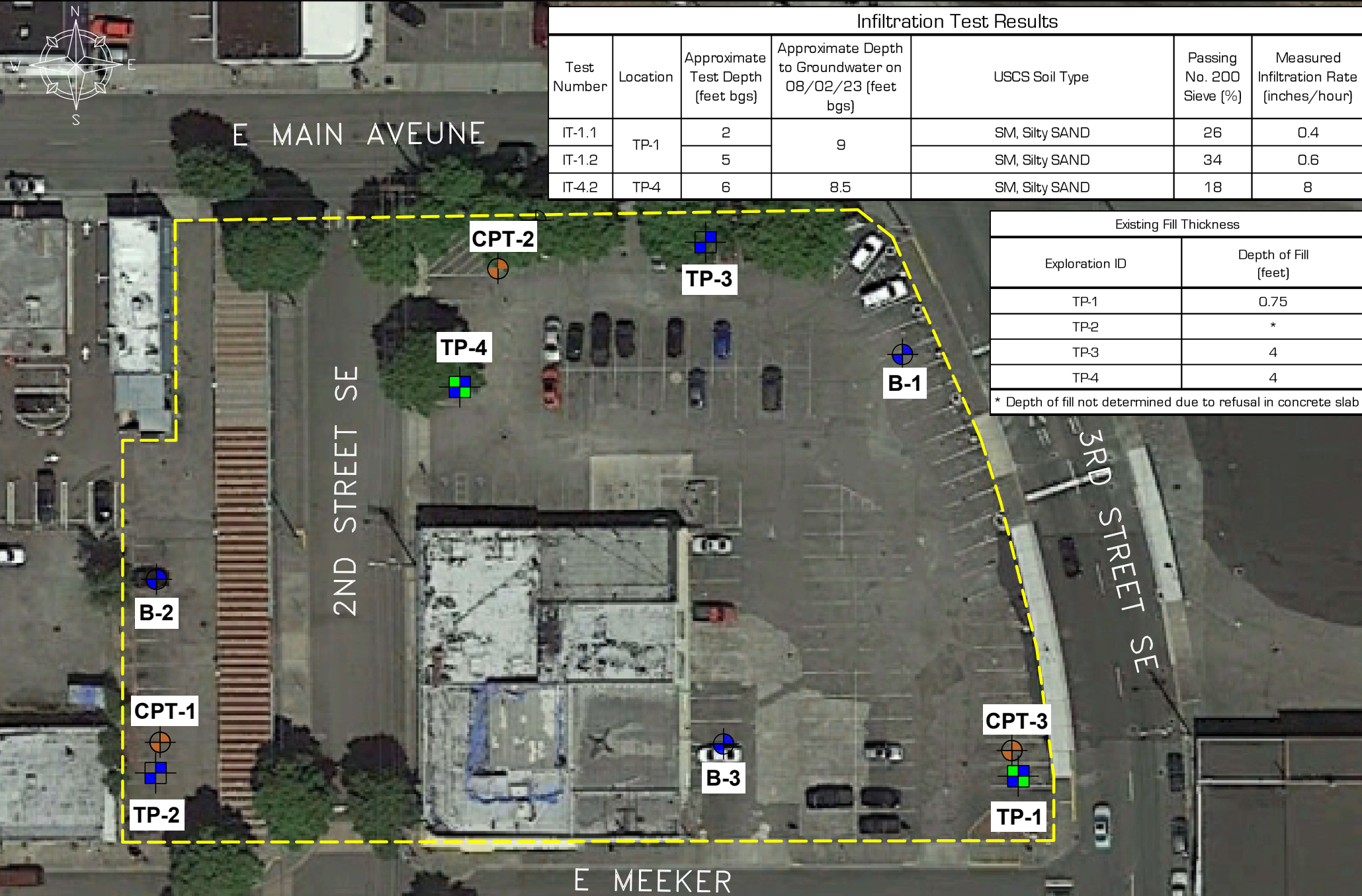

- SITE BOUNDARY
- ⊕ LOCATION OF TEST PIT
- ⊕ LOCATION OF CONE PENETRATION TEST
- ⊕ LOCATION OF BORING
- ⊕ LOCATION OF TEST PIT WITH INFILTRATION



Job No: PALINDROME
1-01-01
Date: 08/14/23
Drawn: EMU
Checked: JFM

**EXPLORATION LOCATION MAP
SEASON ON MEEKER**

- NOTES:
1. SITE LOCATION: 115 2ND STREET SE IN PUYALLUP, WASHINGTON.
 2. SITE CONSISTS OF TAX PARCEL NOS. 7060000030, 7060000020, AND 7060000070 TOTALING APPROXIMATELY 2 ACRES.
 3. AERIAL PHOTO SOURCED FROM GOOGLE EARTH.
 4. EXPLORATION LOCATIONS ARE APPROXIMATE AND NOT SURVEYED.
 5. BORINGS BACKFILLED WITH BENTONITE ON JULY 17 AND 18, 2023.
 6. TEST PITS BACKFILLED LOOSELY WITH ONSITE SOILS ON AUGUST 2, 2023.
 7. CONE PENETRATION TESTS BACKFILLED WITH BENTONITE AUGUST 2, 2023.

FIGURE
2



VERTICAL POINT LOAD

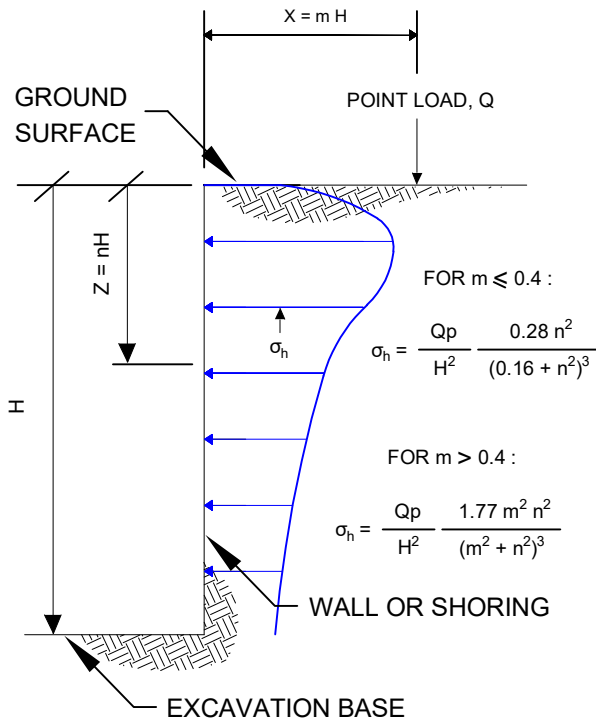

LINE LOAD PARALLEL TO WALL

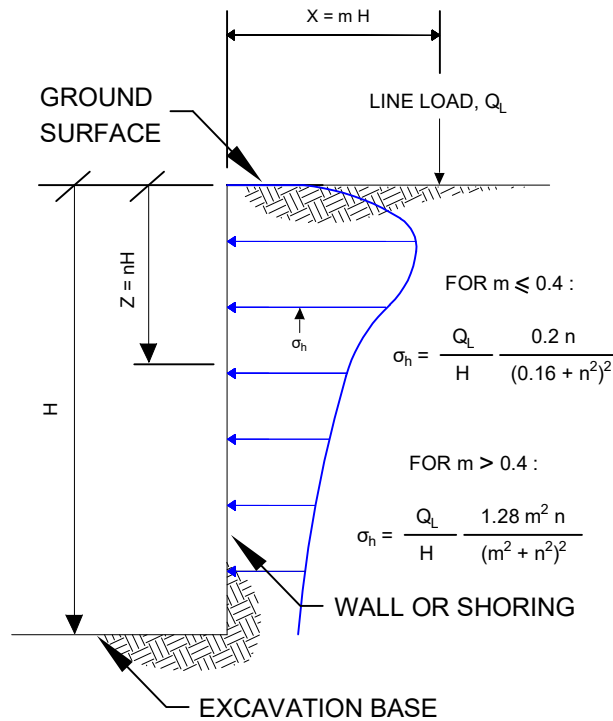

STRIP LOAD PARALLEL TO WALL

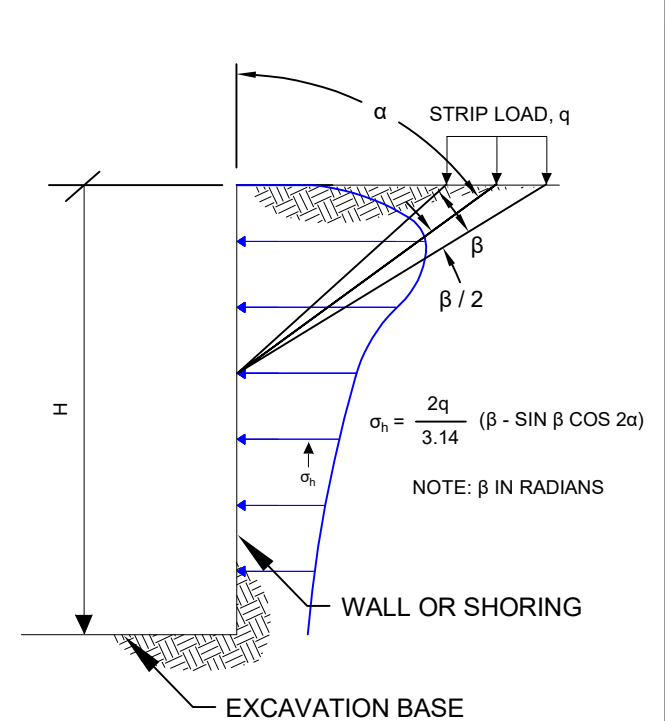

**VERTICAL POINT LOAD
HORIZONTAL PRESSURE DISTRIBUTION**

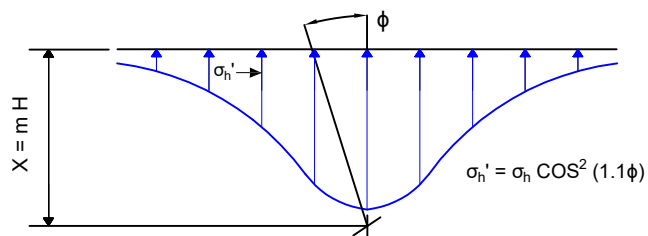

NOTES:

1. FIGURE SHOULD BE USED JOINTLY WITH RECOMMENDATIONS PRESENTED IN THE REPORT TEXT.
2. LATERAL EARTH PRESSURES ASSUME RIGID WALLS WITH BACKFILL MATERIALS HAVING A POISSON'S RATIO OF 0.5.
3. TOTAL LATERAL EARTH PRESSURES RESULTING FROM COMBINED LOADS MAY BE CALCULATED USING SUPERPOSITION.
4. DRAWING IS NOT TO SCALE.

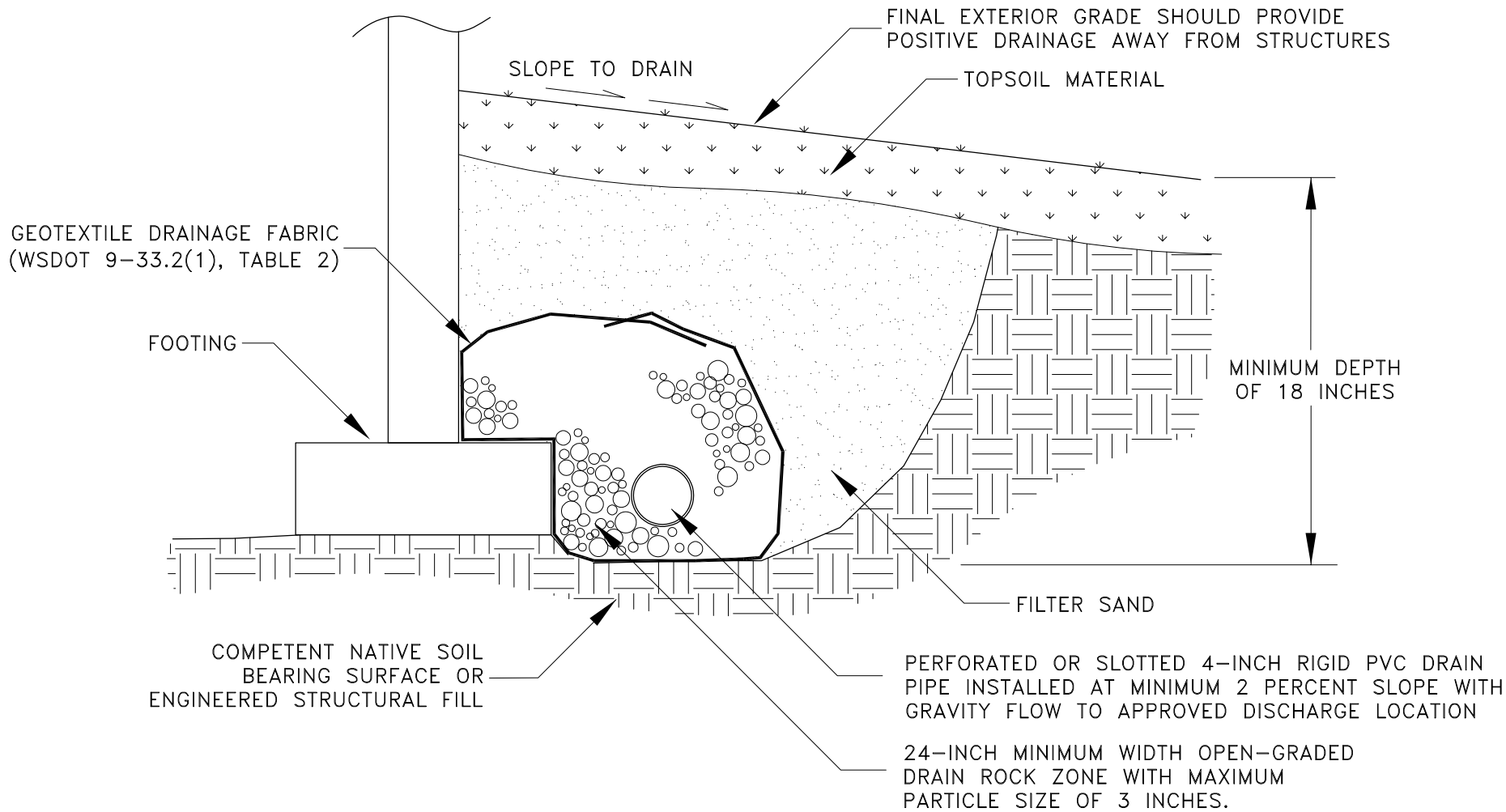

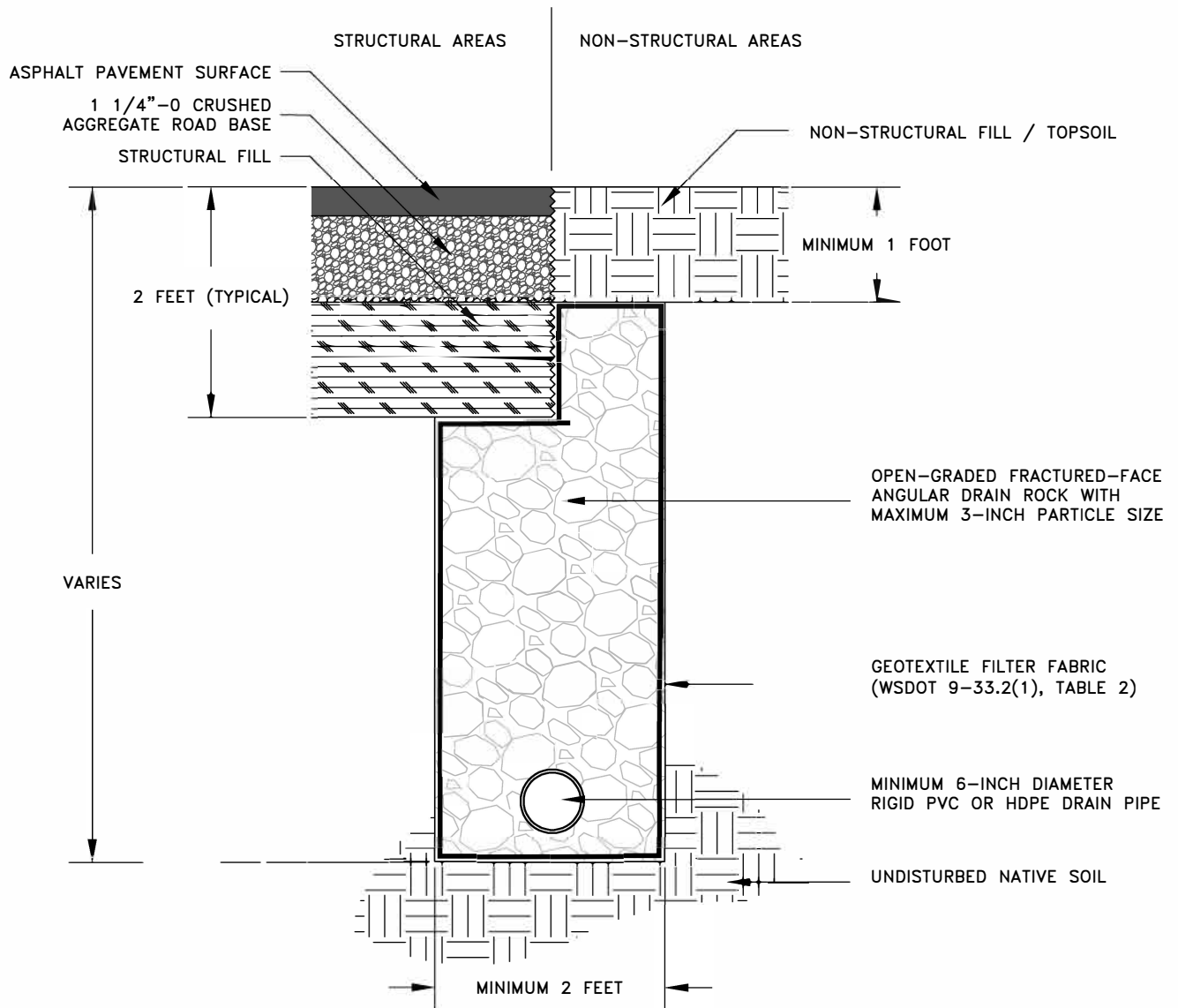

NOTE: LOCATION, INVERT ELEVATION, DEPTH OF TRENCH, AND EXTENT OF PERFORATED PIPE REQUIRED MAY BE MODIFIED BY THE GEOTECHNICAL ENGINEER DURING CONSTRUCTION BASED UPON FIELD OBSERVATION AND SITE-SPECIFIC SOIL CONDITIONS.

TYPICAL DRAINAGE MAT CROSS-SECTION

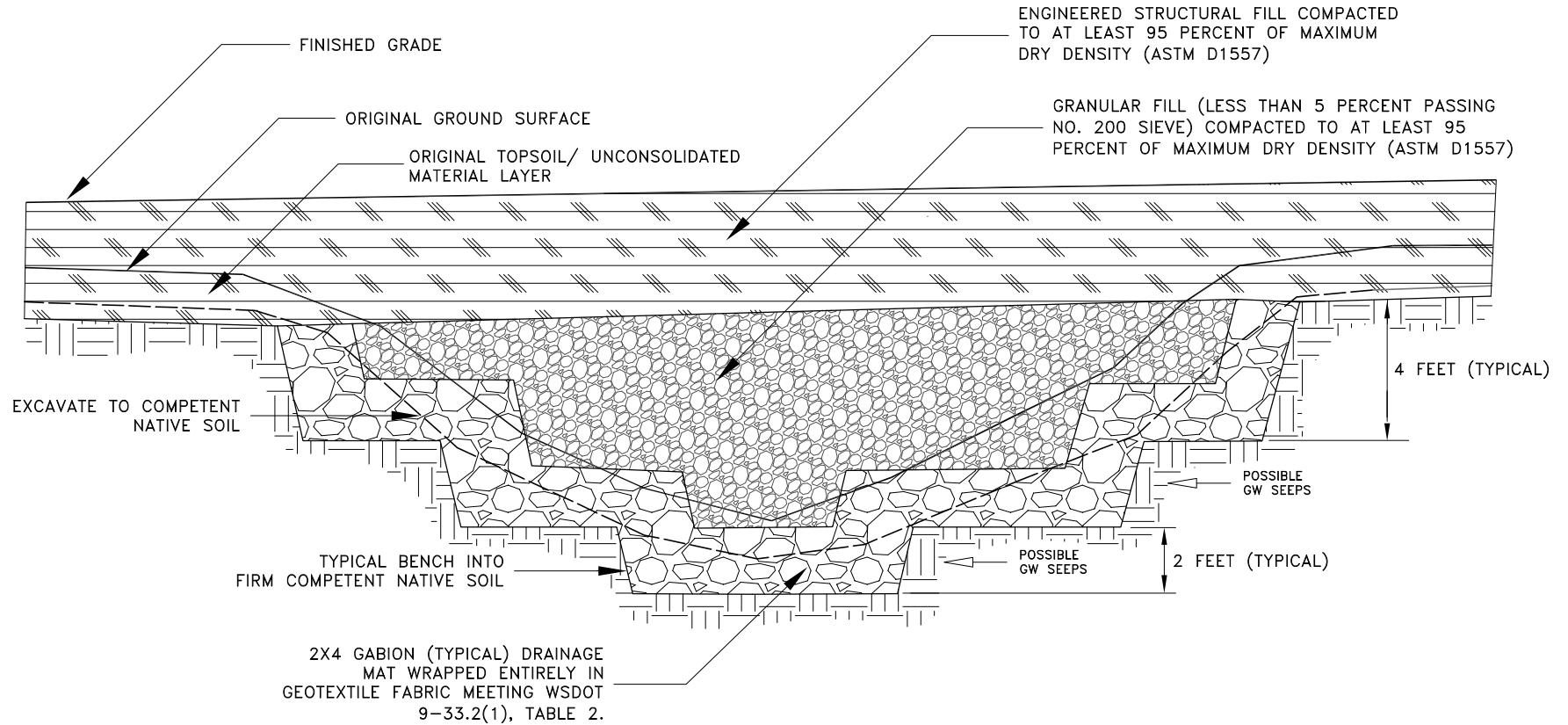

TYPICAL UNDER SLAB DRAINAGE DETAIL

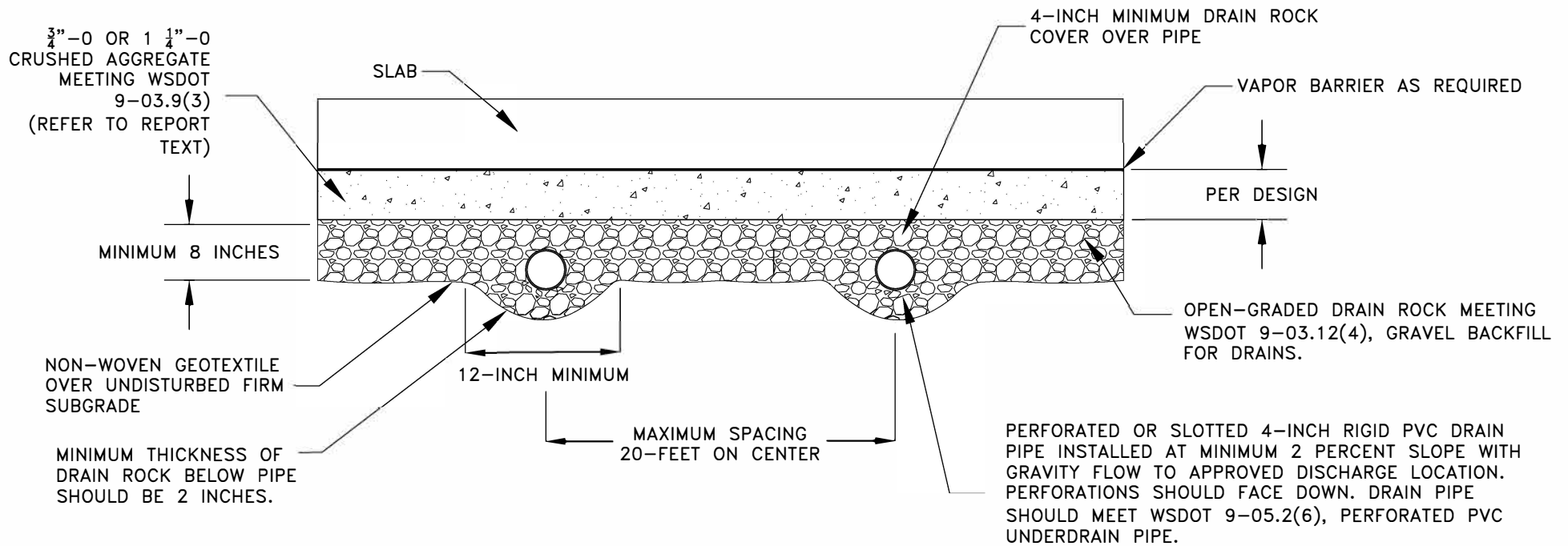

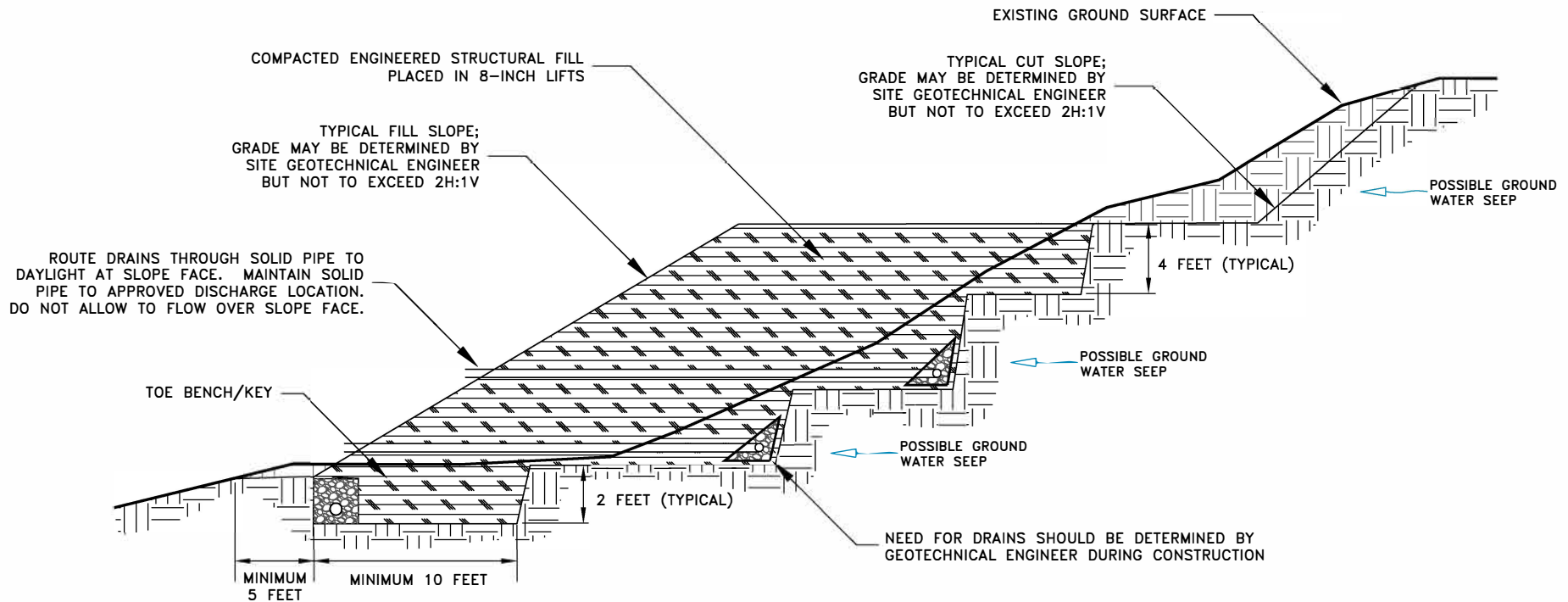

TYPICAL DRAIN SECTION DETAIL

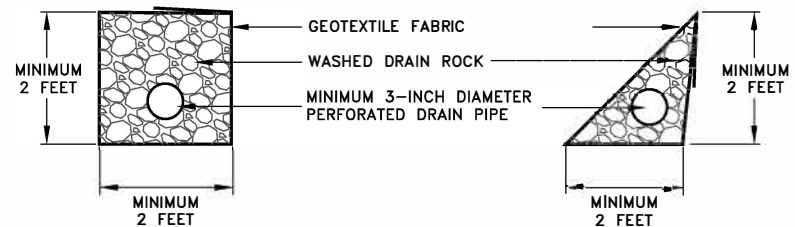

DRAIN SPECIFICATIONS

GEOTEXTILE FABRIC SHALL MEET WSDOT 9-33.2(1), TABLE 2, GEOTEXTILE FOR UNDERGROUND DRAINAGE FILTRATION PROPERTIES WITH AOS BETWEEN No. 70 AND No. 100 SIEVE. WATER PERMITIVITY SHOULD BE GREATER THAN 1.5/SEC.

WASHED DRAIN ROCK SHALL BE OPEN-GRADED ANGULAR DRAIN ROCK WITH LESS THAN 2 PERCENT PASSING THE No. 200 SIEVE AND A MAXIMUM PARTICLE SIZE OF 2 INCHES.

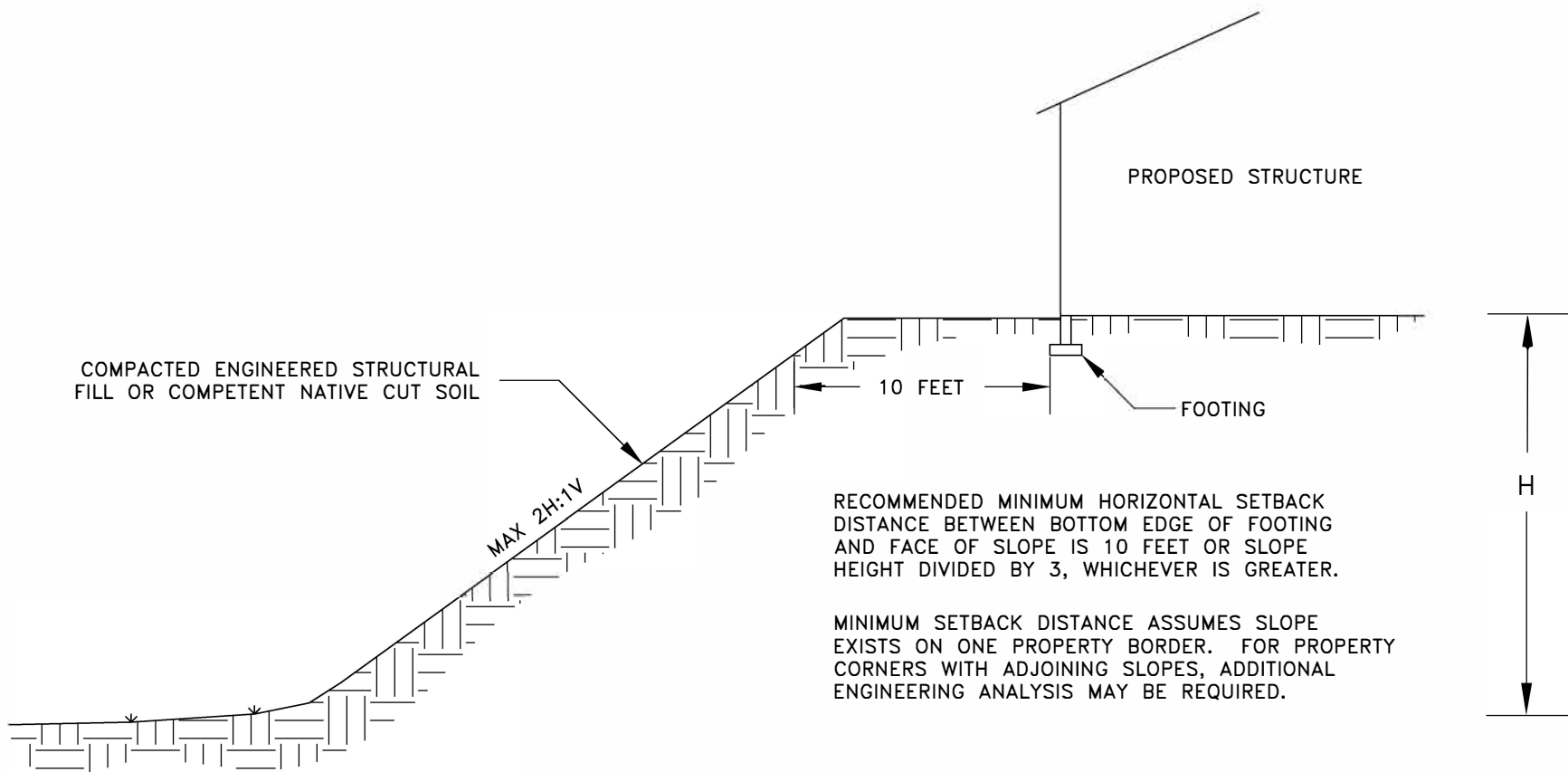

APPENDIX A

SUBSURFACE EXPLORATION PROGRAM

GENERAL

We explored subsurface conditions at the site by drilling three borings (B-1 through B-3) to depths between 31.5 and 56.5 feet BGS, excavating four test pits (TP-1 through TP-4) to depths between 3 inches and 10 feet BGS, and completed three CPTs (CPT-1 through CPT-3) to depths between approximately 60 and 80 feet BGS.

The borings were drilled by Western States Soil Conservation, Inc. of Hubbard, Oregon, on July 17 and 18, 2023, using a truck-mounted drill rig with mud-rotary drilling methods under the supervision of Columbia West. The test pits were excavated by L&S Excavating of Yaacolt, Washington on August 2, 2023. The test pits were logged by a member of our engineering staff. The CPTs were completed by ConeTec, Inc. of Seattle, Washington, on August 2, 2023 using a truck-mounted CPT rig.

Logs of the borings and test pits and results of the CPT's are presented in this appendix. The locations of the explorations are shown on Figure 2. The exploration locations were determined in the field by pacing from existing site features and should be considered accurate to the degree implied by the methods used. A member of our geotechnical staff observed the borings and test pits.

SOIL SAMPLING

Samples were collected from the borings using a 1½-inch- and/or 3-inch-inside diameter, split-barrel (SPT) samplers in general accordance with ASTM D1586. Some samples were also collected using a 3-inch-outer-diameter California split spoon sampler in general accordance with ASTM D3550. The sampler was driven into the soil with a 140-pound hammer free falling 30 inches. The sampler was driven a total distance of 18 inches. The number of blows required to drive the sampler the final 12 inches is recorded on the boring log, unless otherwise noted. Samples were generally collected at 2.5- to 5-foot intervals throughout the depth of the borings. Representative disturbed grab samples observed in the borings were collected from the soil cuttings. In addition, relatively undisturbed samples were collected by pushing thin-walled standard Shelby tubes into the base of the exploration in general accordance with ASTM D1587. Representative disturbed samples of soil observed in the test pit explorations were collected from the test pit walls and base using the backhoe bucket. Sampling methods and intervals are shown on the exploration logs.

SOIL CLASSIFICATION

The soil samples were classified in accordance with the Unified Soil Classification System presented in Appendix C. The exploration log indicates the depths at which the soil or their characteristics change, although the change actually could be gradual. If the change occurred between sample locations, the depth was interpreted. Soil classifications are shown on the exploration logs.

CONE PENETRATION TEST EXPLORATIONS

The CPT is an in situ test that provides characterizes subsurface stratigraphy. The testing includes advancing a 35.6-millimeter-diameter cone equipped with a load cell and a friction sleeve through the soil profile. The cone is advanced at a rate of approximately 2 centimeters per second. Tip resistance, sleeve friction, and pore pressure are typically recorded at 0.1-meter intervals. At selected depths, the CPT advancement can be suspended and pore water

EXPLORATION LEGEND

Symbol	Description
SPT	Sample obtained from the indicated depth in general accordance with ASTM D1586, <i>Standard Penetration Test and Split-Barrel Sampling of Soils</i>
SHELBY	Sample obtained from the indicated depth using thin-wall Shelby tube in general accordance with ASTM D1587, <i>Thin-Walled Tube Sampling of Fine-Grained Soils</i>
D&M 300	Sample obtained from the indicated depth using Dames & Moore sampler and 300-pound hammer or pushed
D&M 140	Sample obtained from the indicated depth using Dames & Moore sampler and 140-pound hammer or pushed
CSS	Sample obtained from the indicated depth using 3-inch-outer-diameter California split-spoon sampler and 140-pound hammer
GRAB	Grab sample obtained from the indicated depth
CORE	Rock core interval at the indicated depth
	Water level observed during exploration

Graphical Log of Subsurface Lithology

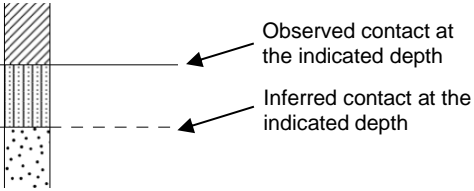

Geotechnical Acronyms			
AASHTO	American Association of State Highway and Transportation Officials	P	Push Sample
ASTM	American Society for Testing and Materials	PP	Pocket Penetrometer
ATT	Atterberg Limits	PSF	Pounds Per Square Foot
BGS	Below Ground Surface	P200	Percent Passing No. 200 Sieve
CBR	California Bearing Ratio	RES	Resilient Modulus
CON	Consolidation Test	SIEV	Sieve Analysis
DCPT	Dynamic Cone Penetration Test	SPT	Standard Penetration Test
DD	Dry Density	TS	Torvane Shear
DS	Direct Shear	UC	Unconfined Compressive Strength
HYD	Hydrometer	UU	Unconsolidated Undrained Triaxial Test
IR	Infiltration Rate	USCS	United Soil Classification System
MC	Moisture Content	VS	Vane Shear
MD	Moisture-Density Relationship	WD	Wet Density
OC	Organic Content		













BORING LOG

PROJECT NAME Season on Meeker	CLIENT Palindrome Puyallup, LLC	PROJECT NO. Palindrome-1-01-01	BORING NO. B-1
PROJECT LOCATION Puyallup, Washington	DRILLING CONTRACTOR Western States	DRILL RIG CME75 Truck 4	ENGINEER EMU
BORING LOCATION See Figure 2	DRILLING METHOD Mud Rotary	SAMPLING METHOD SPT/CSS	START DATE 7/17/2023
REMARKS None	GROUNDWATER DEPTH Unable to Observe	FINISH DATE 7/17/2023	FINISH TIME 1900

Depth (ft)	Field ID + Sample Type	SPT N-value (uncorrected) 0 20 40 60	DRIVE (in)	RECOVERY (in)	USCS Soil Type	Graphic Log	LITHOLOGIC DESCRIPTION AND REMARKS	AASHTO Soil Type	Moisture Content (%)	Passing No. 200 Sieve (%)	Liquid Limit	Plasticity Index
0					ML		3-inches asphalt underlain by 9-inches crushed aggregate.					
4	SPT B1.1	8	18	4			Sandy SILT, brown, moist, medium stiff to stiff, low plasticity, fine sand.		33			
8	SPT B1.2	2	18	6			Becomes very soft to soft and wet at 5 feet.					
8	SPT B1.3	3	18	1			Becomes soft and brown-gray at 7.5 feet.					
12	CSS B1.4	2	18	12			Becomes very soft to soft at 10 feet.		46			
16	SPT B1.5	8	18	12			Becomes medium stiff to stiff at 15 feet.					
20	SPT B1.6	4	18	18			With sand, soft to medium stiff, gray, with fine sand at 20 feet.		40	94		
24	SPT B1.7	7	18	10			Becomes medium stiff with fine to medium sand at 25 feet.					
32	SPT B1.8	4	18	6	SM		Silty SAND, gray-blue, wet, very loose to loose, low plasticity, fine to medium sand.		35			





BORING LOG

PROJECT NAME Season on Meeker	CLIENT Palindrome Puyallup, LLC	PROJECT NO. Palindrome-1-01-01	BORING NO. B-2
PROJECT LOCATION Puyallup, Washington	DRILLING CONTRACTOR Western States	DRILL RIG CME75 Truck 4	ENGINEER EMU
BORING LOCATION See Figure 2	DRILLING METHOD Mud Rotary	SAMPLING METHOD SPT/Shelby	START DATE 7/18/2023
REMARKS None	GROUNDWATER DEPTH Unable to Observe	FINISH DATE 7/18/2023	FINISH TIME 1010

Depth (ft)	Field ID + Sample Type	SPT N-value (uncorrected) 0 20 40 60	DRIVE (in)	RECOVERY (in)	USCS Soil Type	Graphic Log	LITHOLOGIC DESCRIPTION AND REMARKS	AASHTO Soil Type	Moisture Content (%)	Passing No. 200 Sieve (%)	Liquid Limit	Plasticity Index
0					ML		2-inches asphalt underlain by 2-inches of crushed aggregate underlain by 3-inch concrete slab.					
4	SPT B2.1	4	18	10			Sandy SILT, brown-tan, moist, soft to medium stiff, low plasticity, fine to medium sand.					
6	SPT B2.2	1	18	6			Becomes very soft at 5 feet.					
8	SPT B2.3	0	18	12			Fine sand at 7.5 feet.		39			
12	Shelby B2.4		24	24			Becomes very stiff with fine to coarse sand at 12 feet.					
16	SPT B2.5	19	18	15			Becomes soft to medium stiff with trace 1/8-inch wood fragments in sample at 15 feet.		42			
20	SPT B2.6	4	18	15			Very soft with minor sand at 20 feet.		49	94	35	7
26	Shelby B2.7		18	18								
28	SPT B2.8	20	18	18	SM		Silty SAND, blue-gray, wet, medium dense, low plasticity silt, fine to coarse sand.		25			
30	SPT B2.9	31	18	4			With gravel and dense at 30 feet.					
32	SPT B2.10											
34							Boring completed at 31.5 feet BGS. Groundwater not observed on 7/18/23 due to mud rotary drilling methods.					

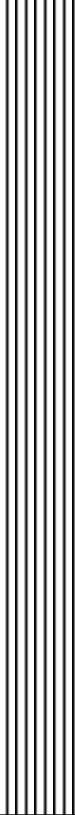
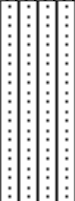

BORING LOG

PROJECT NAME Season on Meeker	CLIENT Palindrome Puyallup, LLC	PROJECT NO. Palindrome-1-01-01	BORING NO. B-3
PROJECT LOCATION Puyallup, Washington	DRILLING CONTRACTOR Western States	DRILL RIG CME75 Truck 4	ENGINEER EMU
BORING LOCATION See Figure 2	DRILLING METHOD Mud Rotary	SAMPLING METHOD SPT/Shelby	START DATE 7/18/2023
REMARKS None	GROUNDWATER DEPTH Unable to Observe	FINISH DATE 7/18/2023	FINISH TIME 1205

Depth (ft)	Field ID + Sample Type	SPT N-value (uncorrected) 0 20 40 60	DRIVE (in)	RECOVERY (in)	USCS Soil Type	Graphic Log	LITHOLOGIC DESCRIPTION AND REMARKS	AASHTO Soil Type	Moisture Content (%)	Passing No. 200 Sieve (%)	Liquid Limit	Plasticity Index
0							6-inches asphalt underlain by 6-inches of crushed aggregate.					
2	SPT B3.1	4	18	12	SM		Silty SAND, brown-gray, moist, very loose to loose, low plasticity silt, fine to medium sand.					
6	SPT B3.2	0	18	18	ML		SILT minor sand, blue-gray, wet, very soft, low plasticity, fine sand.		50	92		
8	Shelby B3.3		24	24								
10	SPT B3.4	9	18	18			Becomes gray-blue and stiff at 9.5 feet.					
16	SPT B3.5	3	18	18			With sand and soft at 15 feet.					
20	SPT B3.6	1	18	18			Becomes very soft at 20 feet.					
26	SPT B3.7	7	18	18	SM		Silty SAND, gray-blue-white, wet, loose, low plasticity silt, fine to medium sand.					
30	SPT B3.8	1	18	18	ML		Trace 1/8-inch wood chunks in fragments at 30 feet. SILT with sand, gray, wet, very soft, low plasticity, fine sand.					
32							Boring completed at 31.5 feet BGS.					
34							Groundwater not observed on 7/18/23 due to mud rotary drilling methods.					

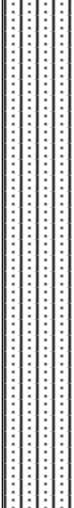
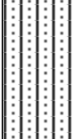
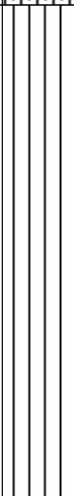

TEST PIT LOG

PROJECT NAME Season on Meeker	CLIENT Palindrome Puyallup, LLC	PROJECT NO. Palindrome-1-01-01	TEST PIT NO. TP-1
PROJECT LOCATION Puyallup, Washington	CONTRACTOR L&S Contractors	EQUIPMENT Mini Excavator	ENGINEER EMU
TEST PIT LOCATION See Figure 2	APPROX. SURFACE ELEVATION Not Surveyed	GROUNDWATER DEPTH 9 feet BGS	START TIME 0903
			FINISH TIME 1105

Depth (feet)	Sample Field ID	SCS Soil Survey Description	AASHTO Soil Type	USCS Soil Type	Graphic Log	LITHOLOGIC DESCRIPTION AND REMARKS	Moisture Content (%)	Passing No. 200 Sieve (%)	Liquid Limit	Plasticity Index	Infiltration Testing
0						2-inches of asphalt underlain by 7-inches of poorly-graded gravel with silt and sand, gray, damp, low plasticity silt, fine to coarse sand, fine to coarse rounded gravel.					
	TP1.2	Puyallup fine sandy loam		SM		Silty SAND, brown, moist, loose, nonplastic to low plasticity silt, fine to medium sand. Infiltration test performed at 2 feet.	16	26			
5	TP1.3					Slight caving at 4 feet. Infiltration test performed at 5 feet.	27	34	NP	NP	
	TP1.4			ML		SILT, blue-gray, moist to wet, soft, low plasticity.	47				
10						Bottom of test pit at 10 feet BGS. Groundwater observed at 9 feet BGS on 8/2/23.					

TEST PIT LOG

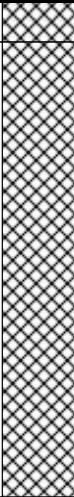
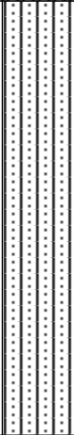
PROJECT NAME Season on Meeker	CLIENT Palindrome Puyallup, LLC	PROJECT NO. Palindrome-1-01-01	TEST PIT NO. TP-3
PROJECT LOCATION Puyallup, Washington	CONTRACTOR L&S Contractors	EQUIPMENT Mini Excavator	ENGINEER EMU
TEST PIT LOCATION See Figure 2	APPROX. SURFACE ELEVATION Not Surveyed	GROUNDWATER DEPTH Not Encountered	START TIME 1138
			FINISH TIME 1250

Depth (feet)	Sample Field ID	SCS Soil Survey Description	AASHTO Soil Type	USCS Soil Type	Graphic Log	LITHOLOGIC DESCRIPTION AND REMARKS	Moisture Content (%)	Passing No. 200 Sieve (%)	Liquid Limit	Plasticity Index	Infiltration Testing
0	TP3.2					3-inches of asphalt.	48				
						FILL. Silty SAND, gray-brown, moist, loose, nonplastic to low plasticity silt, fine sand.					
						Roots to 9 inches.					
						Significant caving at 2 feet.					
5		Puyallup fine sandy loam		SM		Becomes dark gray at 4 feet. Silty SAND, gray-brown, moist, loose, nonplastic to low plasticity silt, fine sand.					
				ML		SILT, gray, moist, soft, medium plasticity.					
10						Test pit terminated at 8 feet BGS due to caving. Groundwater not observed on 8/3/23.					

TEST PIT LOG

PROJECT NAME Season on Meeker	CLIENT Palindrome Puyallup, LLC	PROJECT NO. Palindrome-1-01-01	TEST PIT NO. TP-4
PROJECT LOCATION Puyallup, Washington	CONTRACTOR L&S Contractors	EQUIPMENT Mini Excavator	ENGINEER EMU
TEST PIT LOCATION See Figure 2	APPROX. SURFACE ELEVATION Not Surveyed	GROUNDWATER DEPTH 8.5 feet BGS	START TIME 1255
			FINISH TIME 1400

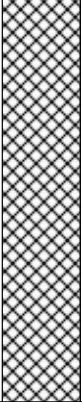
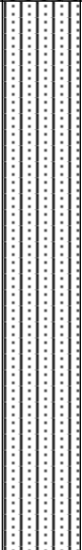
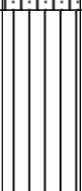
Depth (feet)	Sample Field ID	SCS Soil Survey Description	AASHTO Soil Type	USCS Soil Type	Graphic Log	LITHOLOGIC DESCRIPTION AND REMARKS	Moisture Content (%)	Passing No. 200 Sieve (%)	Liquid Limit	Plasticity Index	Infiltration Testing
0						2-inches of asphalt underlain by 6-inches 5/8"-0 crushed aggregate.					
						FILL. Silty SAND, gray-brown, moist, loose, nonplastic to low plasticity silt, fine sand. Minor caving at 2 feet.					
5	TP4.2	Puyallup fine sandy loam		SM		Silty SAND, gray-brown, moist, loose, nonplastic to low plasticity silt, fine sand. Infiltration test performed at 6 feet.	12	18			
	TP4.3			ML		SILT with sand, gray-blue, wet, soft, low plasticity.					
10						Bottom of test pit at 10 feet BGS. Groundwater observed at 8.5 feet BGS on 8/2/23.					

PRESENTATION OF SITE INVESTIGATION RESULTS

Seasons on Meeker CPT

Prepared for:

Columbia West Engineering, Inc.

ConeTec Job No: 23-59-26282

Project Start Date: 02-Aug-2023

Project End Date: 02-Aug-2023

Report Date: 10-Aug-2023



Prepared by:

ConeTec Inc.
1237 S Director St.
Seattle, WA 98108

Tel: (253) 397-4861

ConeTecWA@conetec.com
www.conetec.com
www.conetecdataservices.com



Introduction

The enclosed report presents the results of the site investigation program conducted by ConeTec Inc. for Columbia West Engineering, Inc. at 115 2nd St SE, Puyallup, WA 98372. The program consisted of two (2) cone penetration tests and one (1) seismic cone penetration test. Please note that this report, which also includes all accompanying data, are subject to the 3rd Party Disclaimer and Client Disclaimer that follow in the 'Limitations' section of this report.

Project Information

Project	
Client	Columbia West Engineering, Inc.
Project	Seasons on Meeker CPT
ConeTec project number	23-59-26282

An aerial overview from Google Earth including the CPTu test locations is presented below.

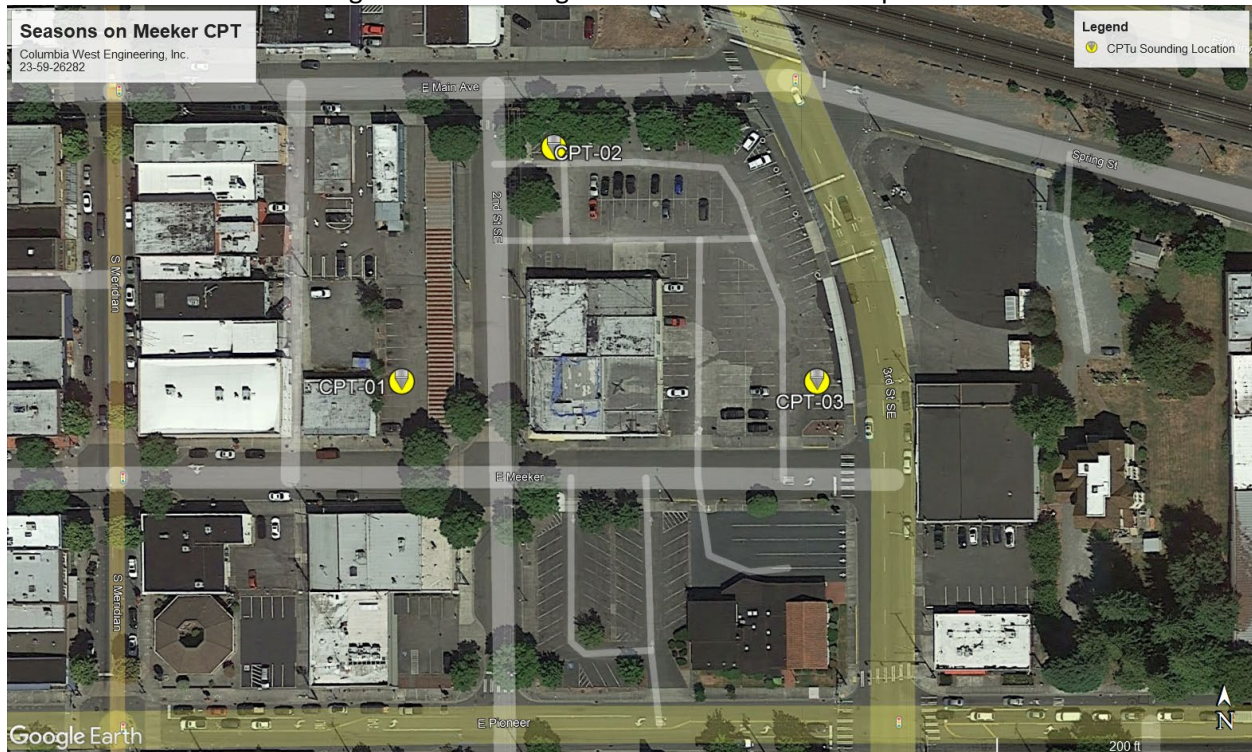

Rig Description	Deployment System	Test Type
C02-023_25-Ton Truck Rig	Integrated Push Cylinders	CPTu

Coordinates		
Test Type	Collection Method	EPSG Number
CPTu	Consumer grade GPS	4326

Cone Penetrometers Used for this Project						
Cone Description	Cone Number	Cross Sectional Area (cm ²)	Sleeve Area (cm ²)	Tip Capacity (bar)	Sleeve Capacity (bar)	Pore Pressure Capacity (bar)
921:T1500F15U35	921	15	225	1500	15	35
Cone 921 was used for all CPTu soundings						

Cone Penetration Test (CPTu)	
Depth reference	Depths are referenced to the existing ground surface at the time of each test.
Tip and sleeve data offset	0.1 meter This has been accounted for in the CPT data files.
Additional plots	<ul style="list-style-type: none"> Advanced plots with I_c, $S_u(N_{kt})/S_u(N_{du})$, Φ and $N(60)/N1(60)$ Soil Behaviour Type (SBT) scatter plots Seismic shear wave (V_s) plots Seismic shear wave (V_s) Wave Trace plots

Calculated Geotechnical Parameter Tables	
Additional information	<p>The Normalized Soil Behaviour Type Chart based on Q_{tn} (SBT Q_{tn}) (Robertson, 2009) was used to classify the soil for this project. A detailed set of calculated CPTu parameters have been generated and are provided in Excel format files in the release folder. The CPTu parameter calculations are based on values of corrected tip resistance (q_t) sleeve friction (f_s) and pore pressure (u_2).</p> <p>Effective stresses are calculated based on unit weights that have been assigned to the individual soil behaviour type zones and the assumed equilibrium pore pressure profile.</p> <p>Soils were classified as either drained or undrained based on the Q_{tn} Normalized Soil Behaviour Type Chart (Robertson, 2009). Calculations for both drained and undrained parameters were included for materials that classified as silt mixtures (zone 4).</p>

Limitations

3rd Party Disclaimer

This report titled "Seasons on Meeker CPT", referred to as the ("Report"), was prepared by ConeTec for Columbia West Engineering, Inc.. The Report is confidential and may not be distributed to or relied upon by any third parties without the express written consent of ConeTec. Any third parties gaining access to the Report do not acquire any rights as a result of such access. Any use which a third party makes of the Report, or any reliance on or decisions made based on it, are the responsibility of such third parties. ConeTec accepts no responsibility for loss, damage and/or expense, if any, suffered by any third parties as a result of decisions made, or actions taken or not taken, which are in any way based on, or related to, the Report or any portion(s) thereof.

Client Disclaimer

ConeTec was retained by Columbia West Engineering, Inc. to collect and provide the raw data ("Data") which is included in this report titled "Seasons on Meeker CPT", which is referred to as the ("Report"). ConeTec has collected and reported the Data in accordance with current industry standards. No other warranty, express or implied, with respect to the Data is made by ConeTec. In order to properly understand the Data included in the Report, reference must be made to the documents accompanying and other sources referenced in the Report in their entirety. Any analysis, interpretation, judgment, calculations and/or geotechnical parameters (collectively "Interpretations") included in the Report, including those based on the Data, are outside the scope of ConeTec's retainer and are included in the Report as a courtesy only. Other than the Data, the contents of the Report (including any Interpretations) should not be relied upon in any fashion without independent verification and ConeTec is in no way responsible for any loss, damage or expense resulting from the use of, and/or reliance on, such material by any party.

Cone penetration tests (CPTu) are conducted using an integrated electronic piezocone penetrometer and data acquisition system manufactured by Adara Systems Ltd., a subsidiary of ConeTec.

ConeTec's piezocone penetrometers are compression type designs in which the tip and friction sleeve load cells are independent and have separate load capacities. The piezocones use strain gauged load cells for tip and sleeve friction and a strain gauged diaphragm type transducer for recording pore pressure. The piezocones also have a platinum resistive temperature device (RTD) for monitoring the temperature of the sensors, an accelerometer type dual axis inclinometer and two geophone sensors for recording seismic signals. All signals are amplified and measured with minimum sixteen-bit resolution down hole within the cone body, and the signals are sent to the surface using a high bandwidth, error corrected digital interface through a shielded cable.

ConeTec penetrometers are manufactured with various tip, friction and pore pressure capacities in both 10 cm² and 15 cm² tip base area configurations in order to maximize signal resolution for various soil conditions. The specific piezocone used for each test is described in the CPT summary table presented in the first appendix. The 15 cm² penetrometers do not require friction reducers as they have a diameter larger than the deployment rods. The 10 cm² piezocones use a friction reducer consisting of a rod adapter extension behind the main cone body with an enlarged cross sectional area (typically 44 millimeters diameter over a length of 32 millimeters with tapered leading and trailing edges) located at a distance of 585 millimeters above the cone tip.

The penetrometers are designed with equal end area friction sleeves, a net end area ratio of 0.8 and cone tips with a 60 degree apex angle.

All ConeTec piezocones can record pore pressure at various locations. Unless otherwise noted, the pore pressure filter is located directly behind the cone tip in the "u₂" position ([ASTM Type 2](#)). The filter is six millimeters thick, made of porous plastic (polyethylene) having an average pore size of 125 microns (90-160 microns). The function of the filter is to allow rapid movements of extremely small volumes of water needed to activate the pressure transducer while preventing soil ingress or blockage.

The piezocone penetrometers are manufactured with dimensions, tolerances and sensor characteristics that are in general accordance with the current [ASTM D5778](#) standard. ConeTec's calibration criteria also meets or exceeds those of the current [ASTM D5778](#) standard. An illustration of the piezocone penetrometer is presented in [Figure CPTu](#).

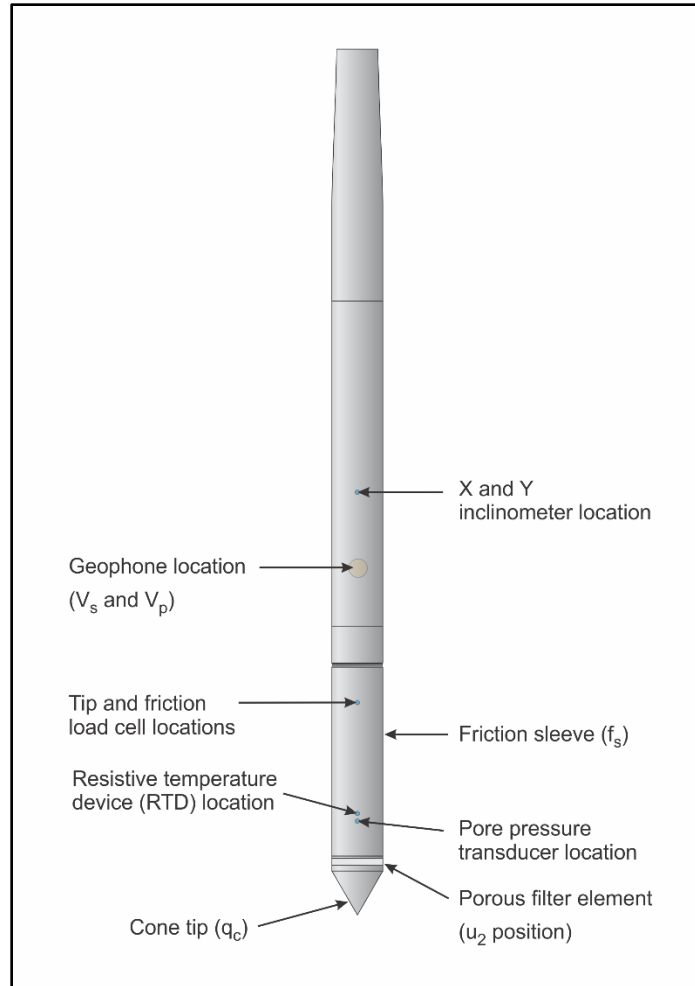

Figure CPTu. Piezocone Penetrometer (15 cm²)

The ConeTec data acquisition systems consist of a Windows based computer and a signal interface box and power supply. The signal interface combines depth increment signals, seismic trigger signals and the downhole digital data. This combined data is then sent to the Windows based computer for collection and presentation. The data is recorded at fixed depth increments using a depth wheel attached to the push cylinders or by using a spring loaded rubber depth wheel that is held against the cone rods. The typical recording interval is 2.5 centimeters; custom recording intervals are possible.

The system displays the CPTu data in real time and records the following parameters to a storage media during penetration:

- Depth
- Uncorrected tip resistance (q_c)
- Sleeve friction (f_s)
- Dynamic pore pressure (u)
- Additional sensors such as resistivity, passive gamma, ultra violet induced fluorescence, if applicable

All testing is performed in accordance to ConeTec's CPTu operating procedures which are in general accordance with the current [ASTM D5778](#) standard.

Prior to the start of a CPTu sounding a suitable cone is selected, the cone and data acquisition system are powered on, the pore pressure system is saturated with silicone oil and the baseline readings are recorded with the cone hanging freely in a vertical position.

The CPTu is conducted at a steady rate of two centimeters per second, within acceptable tolerances. Typically one meter length rods with an outer diameter of 1.5 inches (38.1 millimeters) are added to advance the cone to the sounding termination depth. After cone retraction final baselines are recorded.

Additional information pertaining to ConeTec's cone penetration testing procedures:

- Each filter is saturated in silicone oil under vacuum pressure prior to use
- Baseline readings are compared to previous readings
- Soundings are terminated at the client's target depth or at a depth where an obstruction is encountered, excessive rod flex occurs, excessive inclination occurs, equipment damage is likely to take place, or a dangerous working environment arises
- Differences between initial and final baselines are calculated to ensure zero load offsets have not occurred and to ensure compliance with [ASTM](#) standards

The interpretation of piezocone data for this report is based on the corrected tip resistance (q_t), sleeve friction (f_s) and pore water pressure (u). The interpretation of soil type is based on the correlations developed by [Robertson et al. \(1986\)](#) and [Robertson \(1990, 2009\)](#). It should be noted that it is not always possible to accurately identify a soil behavior type based on these parameters. In these situations, experience, judgment and an assessment of other parameters may be used to infer soil behavior type.

The recorded tip resistance (q_c) is the total force acting on the piezocone tip divided by its base area. The tip resistance is corrected for pore pressure effects and termed corrected tip resistance (q_t) according to the following expression presented in [Robertson et al. \(1986\)](#):

$$q_t = q_c + (1-a) \cdot u_2$$

where: q_t is the corrected tip resistance

q_c is the recorded tip resistance

u_2 is the recorded dynamic pore pressure behind the tip (u_2 position)

a is the Net Area Ratio for the piezocone (0.8 for ConeTec probes)

The sleeve friction (f_s) is the frictional force on the sleeve divided by its surface area. As all ConeTec piezocones have equal end area friction sleeves, pore pressure corrections to the sleeve data are not required.

The dynamic pore pressure (u) is a measure of the pore pressures generated during cone penetration. To record equilibrium pore pressure, the penetration must be stopped to allow the dynamic pore pressures to stabilize. The rate at which this occurs is predominantly a function of the permeability of the soil and the diameter of the cone.

The friction ratio (R_f) is a calculated parameter. It is defined as the ratio of sleeve friction to the tip resistance expressed as a percentage. Generally, saturated cohesive soils have low tip resistance, high friction ratios and generate large excess pore water pressures. Cohesionless soils have higher tip resistances, lower friction ratios and do not generate significant excess pore water pressure.

A summary of the CPTu soundings along with test details and individual plots are provided in the appendices. A set of files with calculated geotechnical parameters were generated for each sounding based on published correlations and are provided in Excel format in the data release folder. Information regarding the methods used is also included in the data release folder.

For additional information on CPTu interpretations and calculated geotechnical parameters, refer to [Robertson et al. \(1986\)](#), [Lunne et al. \(1997\)](#), [Robertson \(2009\)](#), [Mayne \(2013, 2014\)](#) and [Mayne and Peuchen \(2012\)](#).

Shear wave velocity (V_s) testing is performed in conjunction with the piezocone penetration test (SCPTu) in order to collect interval velocities. For some projects seismic compression wave velocity (V_p) testing is also performed.

ConeTec's 15 cm² piezocone penetrometers are manufactured with one horizontally active geophone (28 hertz) and one vertically active geophone (28 hertz). Both geophones are rigidly mounted in the body of the cone penetrometer, 0.2 meters behind the cone tip. The vertically mounted geophone is more sensitive to compression waves; however, it is often affected by the compression wave travelling through the cone rods.

Shear waves are typically generated by using an impact hammer horizontally striking a beam that is held in place by a normal load. In some instances, an auger source or an imbedded impulsive source may be used for both shear waves and compression waves. The hammer and beam act as a contact trigger that initiates the recording of the seismic wave traces. For impulsive devices an accelerometer trigger may be used. The traces are recorded in the memory of the cone using a fast analog to digital converter. The seismic trace is then transmitted digitally uphole to a Windows based computer through a signal interface box for recording and analysis. An illustration of the shear wave testing configuration is presented in [Figure SCPTu-1](#).

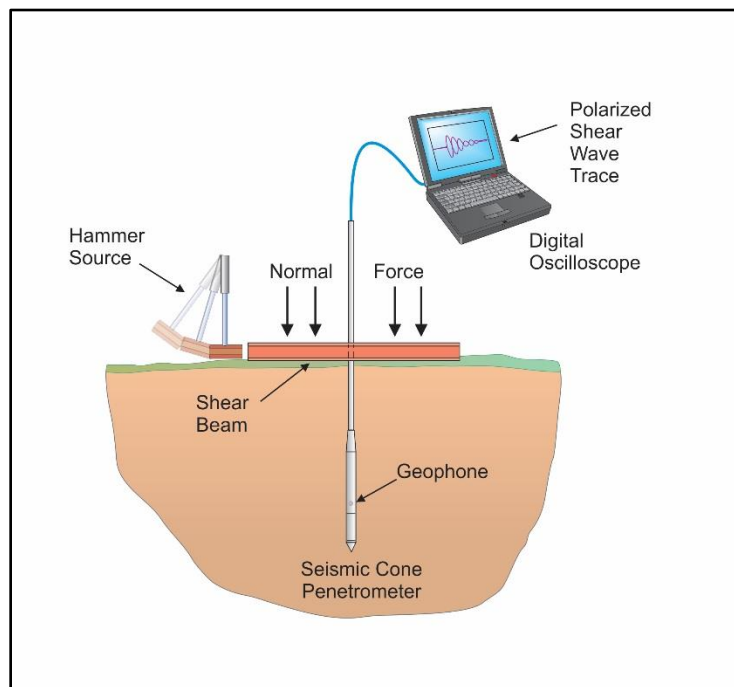

Figure SCPTu-1. Illustration of the SCPTu system

All testing is performed in accordance to ConeTec's SCPTu operating procedures which are in general accordance with the current [ASTM D5778](#) and [ASTM D7400](#) standards.

Prior to the start of a SCPTu sounding, the procedures described in the Cone Penetration Test section are followed. In addition, the active axis of the geophone is aligned parallel to the beam (or source) and the horizontal offset between the cone and the source is measured and recorded.

Prior to recording seismic waves at each test depth, cone penetration is stopped and the rods are decoupled from the rig to avoid transmission of rig energy down the rods. Typically, five wave traces for each orientation are recorded for quality control and uncertainty analysis purposes. After reviewing wave traces for consistency the cone is pushed to the next test depth (typically one meter intervals or as requested by the client). [Figure SCPTu-2](#) presents an illustration of a SCPTu test.

For additional information on seismic cone penetration testing refer to [Robertson et al. \(1986\)](#).

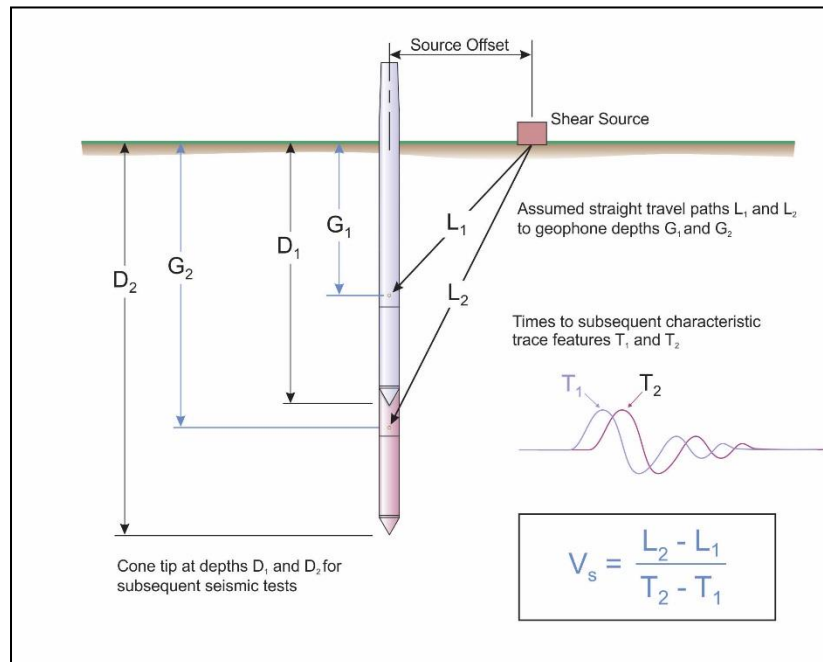

Figure SCPTu-2. Illustration of a seismic cone penetration test

For the determination of interval travel times the wave traces from all depths are displayed in analysis software. The results of the interval picks are supplied in the relevant appendix of this report. Standard practice for ConeTec is to record five wave traces for each source direction at each test depth. Outlier impacts are identified in the field and the impacts are repeated. For the final wave trace profile, the traces are stacked in the time domain to display a single average trace.

Determination of the shear wave interval velocities are performed by visually picking a common feature (e.g. the first characteristic peak, trough, or crossover) on all of the trace depths and taking the difference in ray path divided by the time difference between features at subsequent depths. The same process is used for compression waves, however the first break is most commonly used for selecting an arrival time. For velocity calculation, the ray path is defined as the straight-line distance from the seismic source to the geophone, accounting for beam offset, source depth and geophone offset from the cone tip.

In some cases, usually for shear wave velocity testing, more than one characteristic marker may be used. If there is an overlap between different sets of characteristic markers, then the average time value for those sets of interval times is applied to the determination of velocity.

Ideally, all depths are used for the determination of the velocity profile. However, an interval may be skipped if there is some ambiguity or quality concern with a particular depth, resulting in a larger interval.

Tabular velocity results and SCPTu plots are presented in the relevant appendix.

For all SCPTu soundings that have achieved a depth of at least 100 feet (30 meters), the average shear wave velocity to a depth of 100 feet (\bar{v}_s) has been calculated and provided for all applicable soundings using the following equation presented in [ASCE \(2010\)](#).

$$\bar{v}_s = \frac{\sum_{i=1}^n d_i}{\sum_{i=1}^n \frac{d_i}{v_{si}}}$$

where: \bar{v}_s = average shear wave velocity ft/s (m/s)
 d_i = the thickness of any layer between 0 and 100 ft (30 m)
 v_{si} = the shear wave velocity in ft/s (m/s)
 $\sum_{i=1}^n d_i$ = the total thickness of all layers between 0 and 100 ft (30 m)

Average shear wave velocity, \bar{v}_s is also referenced to V_{s100} or V_{s30} .

The layer travel times refers to the travel times propagating in the vertical direction, not the measured travel times from an offset source.

The cone penetration test is halted at specific depths to carry out pore pressure dissipation (PPD) tests, shown in Figure PPD-1. For each dissipation test the cone and rods are decoupled from the rig and the data acquisition system measures and records the variation of the pore pressure (u) with time (t).

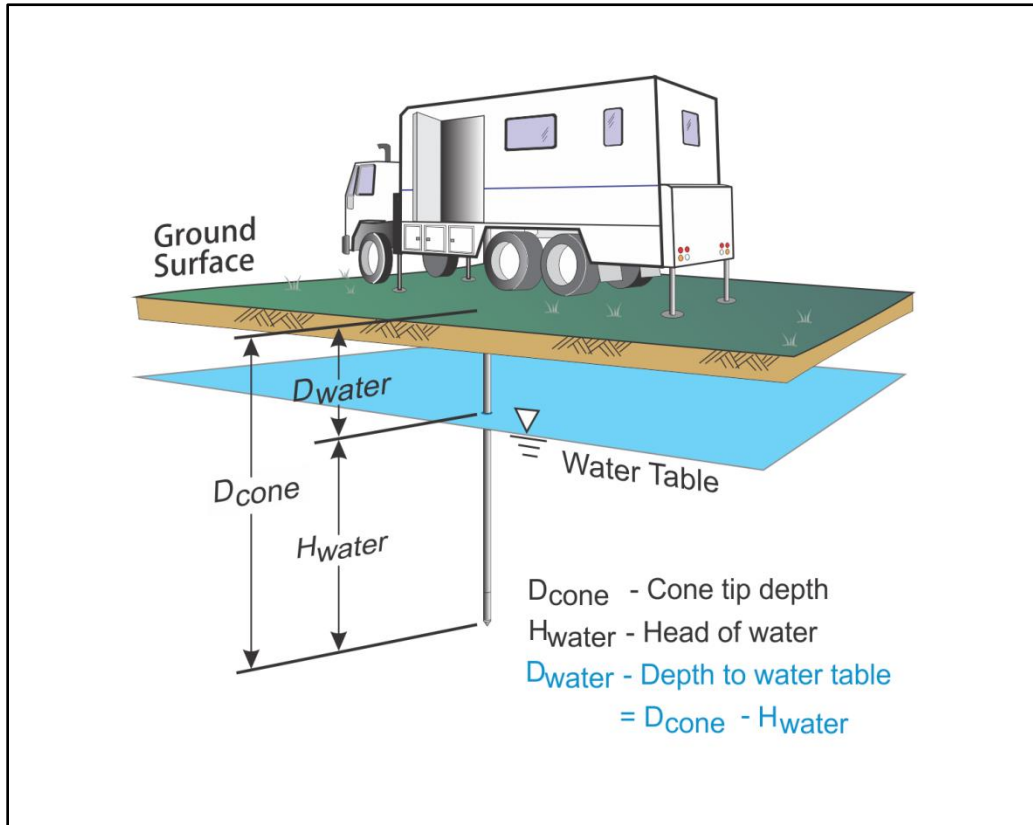

Figure PPD-1. Pore pressure dissipation test setup

Pore pressure dissipation data can be interpreted to provide estimates of ground water conditions, permeability, consolidation characteristics and soil behavior.

The typical shapes of dissipation curves shown in Figure PPD-2 are very useful in assessing soil type, drainage, in situ pore pressure and soil properties. A flat curve that stabilizes quickly is typical of a freely draining sand. Undrained soils such as clays will typically show positive excess pore pressure and have long dissipation times. Dilative soils will often exhibit dynamic pore pressures below equilibrium that then rise over time. Overconsolidated fine-grained soils will often exhibit an initial dilatory response where there is an initial rise in pore pressure before reaching a peak and dissipating.

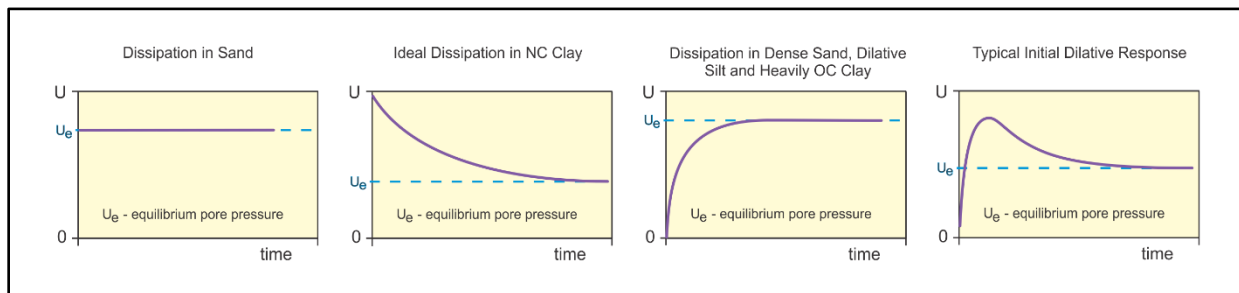

Figure PPD-2. Pore pressure dissipation curve examples

In order to interpret the equilibrium pore pressure (u_{eq}) and the apparent phreatic surface, the pore pressure should be monitored until such time as there is no variation in pore pressure with time as shown for each curve in [Figure PPD-2](#).

In fine grained deposits the point at which 100% of the excess pore pressure has dissipated is known as t_{100} . In some cases this can take an excessive amount of time and it may be impractical to take the dissipation to t_{100} . A theoretical analysis of pore pressure dissipations by [Teh and Houlsby \(1991\)](#) showed that a single curve relating degree of dissipation versus theoretical time factor (T^*) may be used to calculate the coefficient of consolidation (c_h) at various degrees of dissipation resulting in the expression for c_h shown below.

$$c_h = \frac{T^* \cdot a^2 \cdot \sqrt{l_r}}{t}$$

Where:

- T^* is the dimensionless time factor ([Table Time Factor](#))
- a is the radius of the cone
- l_r is the rigidity index
- t is the time at the degree of consolidation

Table Time Factor. T^* versus degree of dissipation ([Teh and Houlsby \(1991\)](#))

Degree of Dissipation (%)	20	30	40	50	60	70	80
$T^* (u_2)$	0.038	0.078	0.142	0.245	0.439	0.804	1.60

The coefficient of consolidation is typically analyzed using the time (t_{50}) corresponding to a degree of dissipation of 50% (u_{50}). In order to determine t_{50} , dissipation tests must be taken to a pressure less than u_{50} . The u_{50} value is half way between the initial maximum pore pressure and the equilibrium pore pressure value, known as u_{100} . To estimate u_{50} , both the initial maximum pore pressure and u_{100} must be known or estimated. Other degrees of dissipations may be considered, particularly for extremely long dissipations.

At any specific degree of dissipation the equilibrium pore pressure (u at t_{100}) must be estimated at the depth of interest. The equilibrium value may be determined from one or more sources such as measuring the value directly (u_{100}), estimating it from other dissipations in the same profile, estimating the phreatic surface and assuming hydrostatic conditions, from nearby soundings, from client provided information, from site observations and/or past experience, or from other site instrumentation.

For calculations of c_h ([Teh and Houlsby \(1991\)](#)), t_{50} values are estimated from the corresponding pore pressure dissipation curve and a rigidity index (l_r) is assumed. For curves having an initial dilatatory response in which an initial rise in pore pressure occurs before reaching a peak, the relative time from the peak value is used in determining t_{50} . In cases where the time to peak is excessive, t_{50} values are not calculated.

A summary of the pore pressure dissipation tests and dissipation plots are presented in the relevant appendix.

REFERENCES

American Society of Civil Engineers (ASCE), 2010, "Minimum Design Loads for Buildings and Other Structures", Standard ASCE/SEI 7-10, American Society of Civil Engineers, ISBN 978-0-7844-1085-1, Reston, Virginia. DOI: [10.1061/9780784412916](https://doi.org/10.1061/9780784412916).

ASTM D5778-20, 2020, "Standard Test Method for Performing Electronic Friction Cone and Piezocone Penetration Testing of Soils", ASTM International, West Conshohocken, PA. DOI: [10.1520/D5778-12](https://doi.org/10.1520/D5778-12).

ASTM D7400/D7400M-19, 2019, "Standard Test Methods for Downhole Seismic Testing", ASTM International, West Conshohocken, PA. DOI: [10.1520/D7400_D7400M-19](https://doi.org/10.1520/D7400_D7400M-19).

Lunne, T., Robertson, P.K. and Powell, J. J. M., 1997, "Cone Penetration Testing in Geotechnical Practice", Blackie Academic and Professional.

Mayne, P.W., 2013, "Evaluating yield stress of soils from laboratory consolidation and in-situ cone penetration tests", Sound Geotechnical Research to Practice (Holtz Volume) GSP 230, ASCE, Reston/VA: 406-420. DOI: [10.1061/9780784412770.027](https://doi.org/10.1061/9780784412770.027).

Mayne, P.W. and Peuchen, J., 2012, "Unit weight trends with cone resistance in soft to firm clays", Geotechnical and Geophysical Site Characterization 4, Vol. 1 (Proc. ISC-4, Pernambuco), CRC Press, London: 903-910.

Mayne, P.W., 2014, "Interpretation of geotechnical parameters from seismic piezocone tests", CPT'14 Keynote Address, Las Vegas, NV, May 2014.

Robertson, P.K., Campanella, R.G., Gillespie, D. and Greig, J., 1986, "Use of Piezometer Cone Data", Proceedings of InSitu 86, ASCE Specialty Conference, Blacksburg, Virginia.

Robertson, P.K., Campanella, R.G., Gillespie D and Rice, A., 1986, "Seismic CPT to Measure In-Situ Shear Wave Velocity", Journal of Geotechnical Engineering ASCE, Vol. 112, No. 8: 791-803. DOI: [10.1061/\(ASCE\)0733-9410\(1986\)112:8\(791\)](https://doi.org/10.1061/(ASCE)0733-9410(1986)112:8(791)).

Robertson, P.K., 1990, "Soil Classification Using the Cone Penetration Test", Canadian Geotechnical Journal, Volume 27: 151-158. DOI: [10.1139/T90-014](https://doi.org/10.1139/T90-014).

Robertson, P.K., 2009, "Interpretation of cone penetration tests – a unified approach", Canadian Geotechnical Journal, Volume 46: 1337-1355. DOI: [10.1139/T09-065](https://doi.org/10.1139/T09-065).

Teh, C.I., and Houlsby, G.T., 1991, "An analytical study of the cone penetration test in clay", Geotechnique, 41(1): 17-34. DOI: [10.1680/geot.1991.41.1.17](https://doi.org/10.1680/geot.1991.41.1.17).

The appendices listed below are included in the report:

- Cone Penetration Test Summary and Standard Cone Penetration Test Plots
- Advanced Cone Penetration Test Plots with I_c , $S_u(N_{kt})$, $S_u(N_{du})$, Φ , $N(60)$ and $N1(60)$
- Seismic Cone Penetration Test Plots
- Seismic Cone Penetration Test Shear Wave (V_s) Tabular Results
- Seismic Cone Penetration Test Shear Wave (V_s) Traces
- Soil Behavior Type (SBT) Scatter Plots
- Pore Pressure Dissipation Summary and Pore Pressure Dissipation Plots

Cone Penetration Test Summary and Standard Cone Penetration Test Plots



Job No: 23-59-26282
Client: Columbia West Engineering, Inc.
Project: Seasons on Meeker CPT
Start Date: 02-Aug-2023
End Date: 02-Aug-2023

CONE PENETRATION TEST SUMMARY

Sounding ID	File Name	Date	Cone	Assumed ¹ Phreatic Surface (ft)	Final Depth (ft)	Shear Wave Velocity Tests	Latitude ² (deg)	Longitude ² (deg)
CPT-01	23-59-26282_CP01	02-Aug-2023	921:T1500F15U35	9.6	60.6		47.19118	-122.29281
CPT-02	23-59-26282_SP02	02-Aug-2023	921:T1500F15U35	8.9	60.4	17	47.19168	-122.29234
CPT-03	23-59-26282_CP03	02-Aug-2023	921:T1500F15U35	7.3	80.4		47.19118	-122.29152
Totals	3 soundings				201.4	17		

1. Phreatic surface based on pore pressure dissipation test unless otherwise noted. Hydrostatic profile applied to interpretation tables
2. Coordinates were collected with a consumer grade GPS - WGS 84 Lat/Long

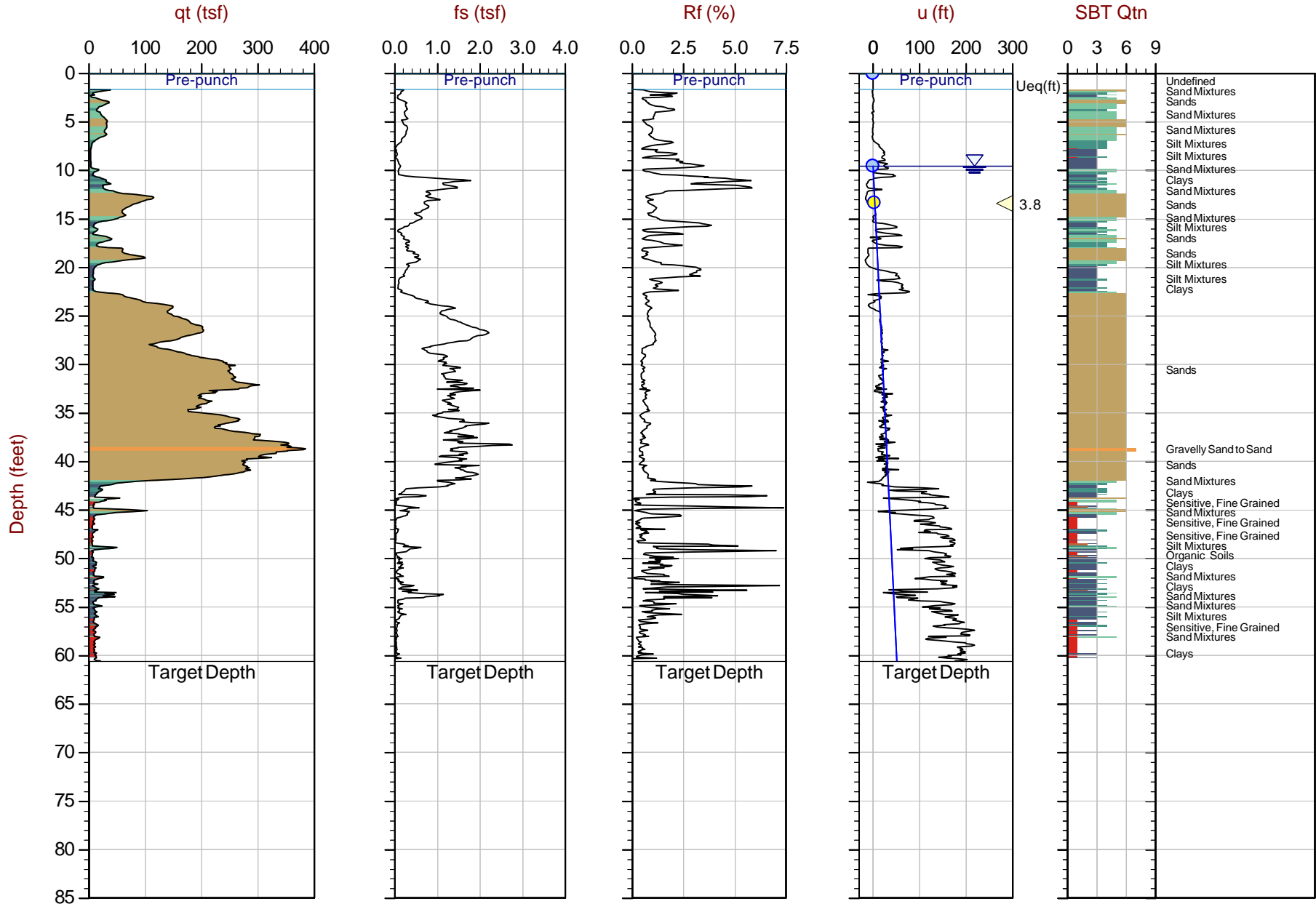

Max Depth: 18.475 m / 60.61 ft
 Depth Inc: 0.025 m / 0.082 ft
 Avg Int: Every Point

File: 23-59-26282_CP01.COR
 Unit Wt: SBTQtn(PKR2009)

SBT: Robertson, 2009 and 2010
 Coords: Lat: 47.19118 Long: -122.29281

● Equilibrium Pore Pressure (Ueq)
 ● Assumed Ueq
 ◁ Dissipation, Ueq achieved
 ◁ Dissipation, Ueq not achieved
 — Hydrostatic Line

The reported coordinates were acquired from consumer-grade GPS equipment and are only approximate locations. The coordinates should not be used for design purposes.

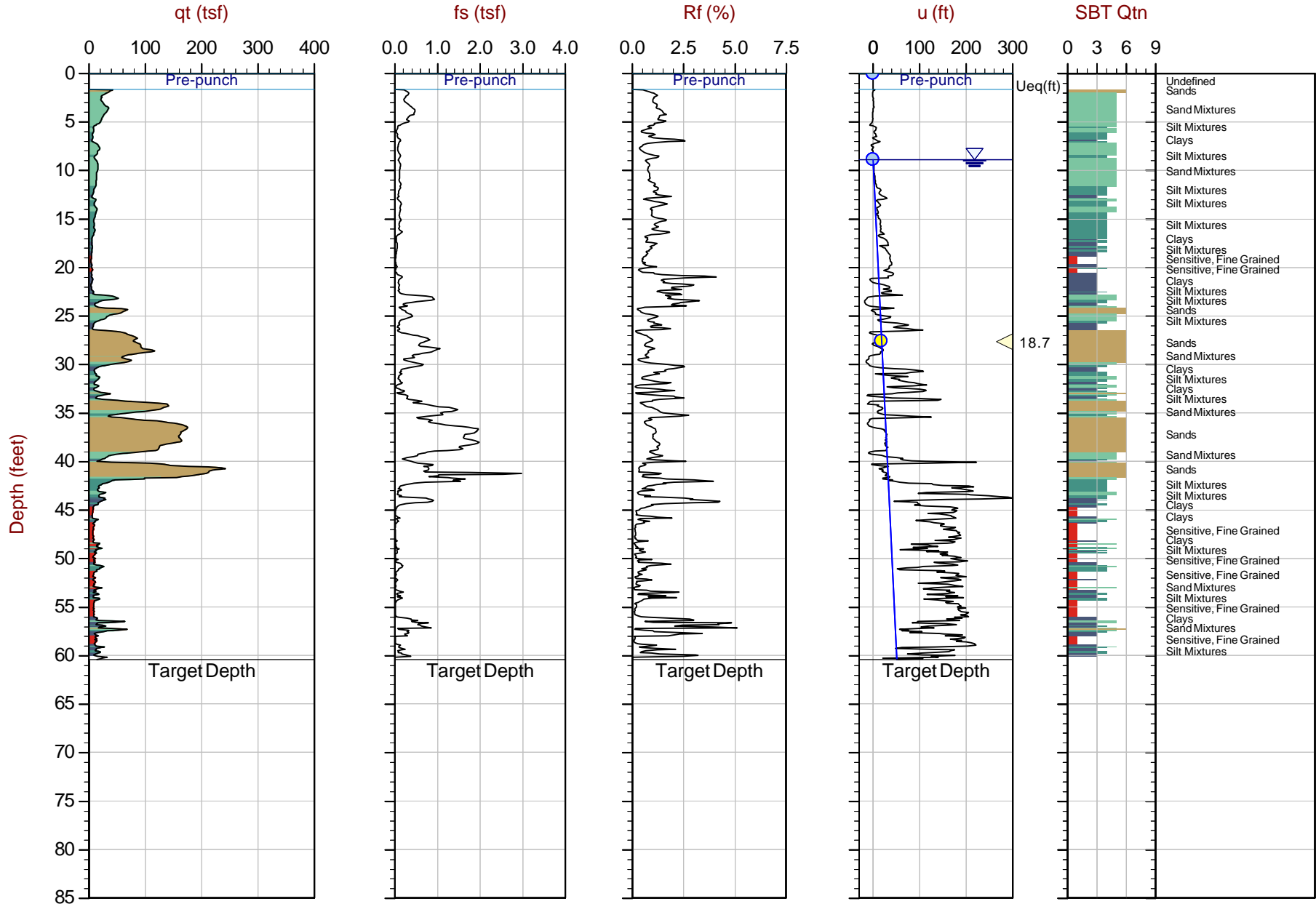

Max Depth: 18.425 m / 60.45 ft
 Depth Inc: 0.025 m / 0.082 ft
 Avg Int: Every Point

File: 23-59-26282_SP02.COR
 Unit Wt: SBTQtn(PKR2009)

SBT: Robertson, 2009 and 2010
 Coords: Lat: 47.19168 Long: -122.29234

● Equilibrium Pore Pressure (Ueq)
 ● Assumed Ueq
 ◁ Dissipation, Ueq achieved
 ◁ Dissipation, Ueq not achieved
 — Hydrostatic Line

The reported coordinates were acquired from consumer-grade GPS equipment and are only approximate locations. The coordinates should not be used for design purposes.

Advanced Cone Penetration Test Plots with I_c , $S_u(N_{kt})$, $S_u(N_{du})$, Φ ,
 $N(60)$ and $N1(60)$



Columbia West

Job No: 23-59-26282

Date: 2023-08-02 09:19

Site: Seasons on Meeker CPT

Sounding: CPT-01

Cone: 921:T1500F15U35

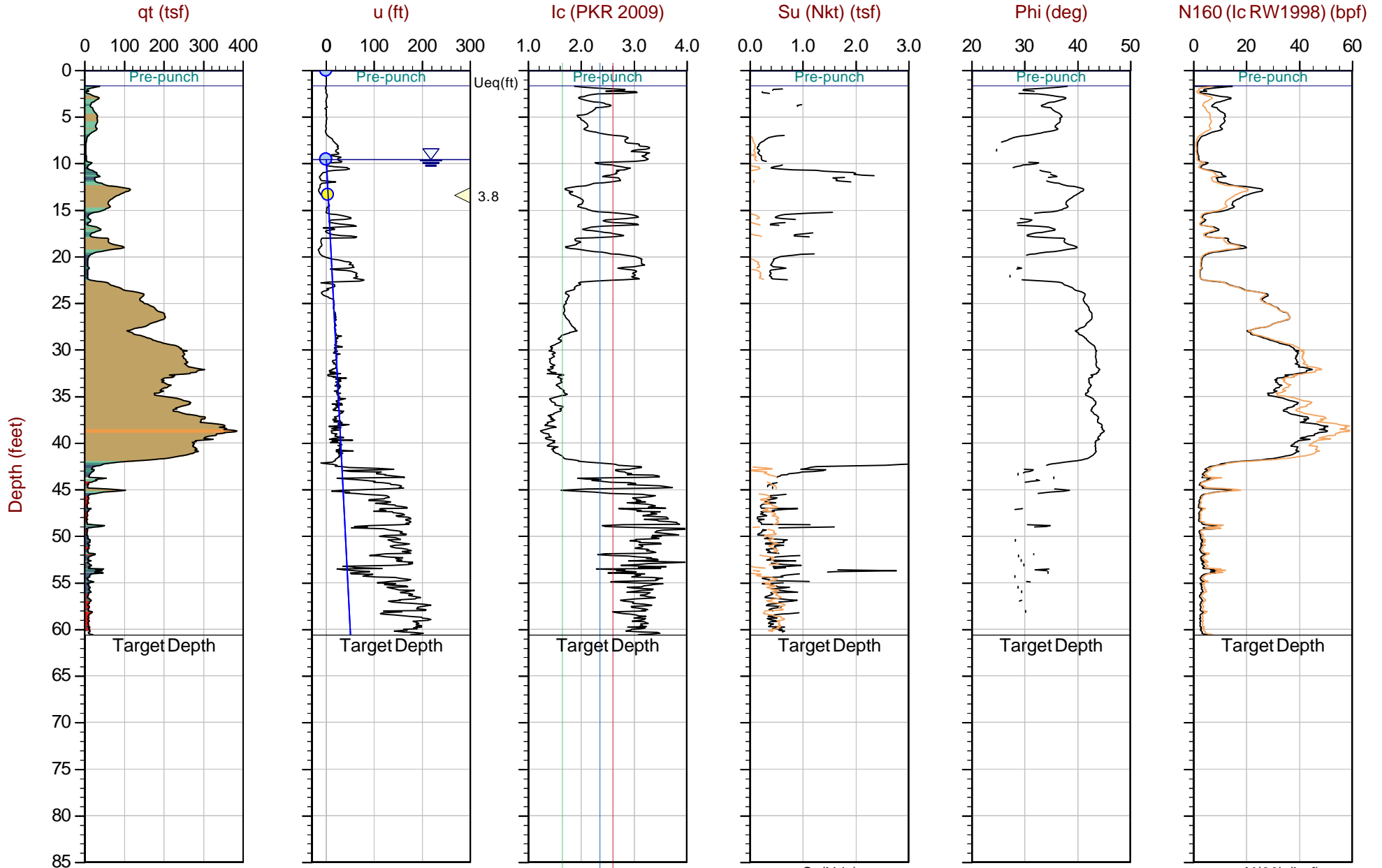

Max Depth: 18.475 m / 60.61 ft
 Depth Inc: 0.025 m / 0.082 ft
 Avg Int: Every Point

File: 23-59-26282_CP01.COR
 Unit Wt: SBTQtn(PKR2009)
 Su Nkt/Ndu: 15.0 / 8.0

SBT: Robertson, 2009 and 2010
 Coords: Lat: 47.19118 Long: -122.29281

● Equilibrium Pore Pressure (Ueq)
 ● Assumed Ueq
 ◁ Dissipation, Ueq achieved
 ◁ Dissipation, Ueq not achieved
 — Hydrostatic Line

The reported coordinates were acquired from consumer-grade GPS equipment and are only approximate locations. The coordinates should not be used for design purposes.

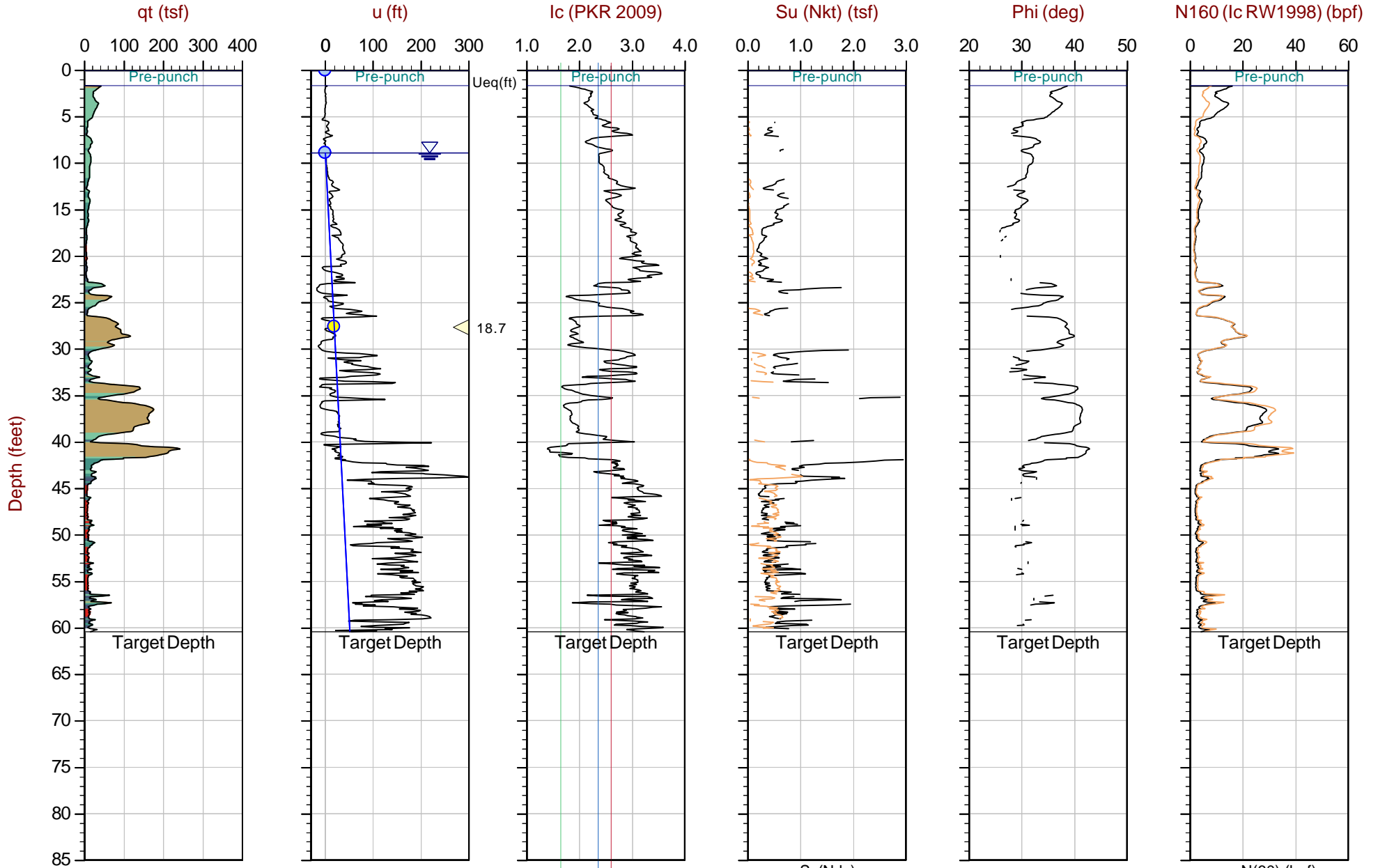

Max Depth: 18.425 m / 60.45 ft
 Depth Inc: 0.025 m / 0.082 ft
 Avg Int: Every Point

File: 23-59-26282_SP02.COR
 Unit Wt: SBTQn(PKR2009)
 Su Nkt/Ndu: 15.0 / 8.0

SBT: Robertson, 2009 and 2010
 Coords: Lat: 47.19168 Long: -122.29234

● Equilibrium Pore Pressure (Ueq)
 ● Assumed Ueq
 ◁ Dissipation, Ueq achieved
 ◁ Dissipation, Ueq not achieved
 — Hydrostatic Line

The reported coordinates were acquired from consumer-grade GPS equipment and are only approximate locations. The coordinates should not be used for design purposes.



Columbia West

Job No: 23-59-26282

Date: 2023-08-02 11:55

Site: Seasons on Meeker CPT

Sounding: CPT-03

Cone: 921:T1500F15U35

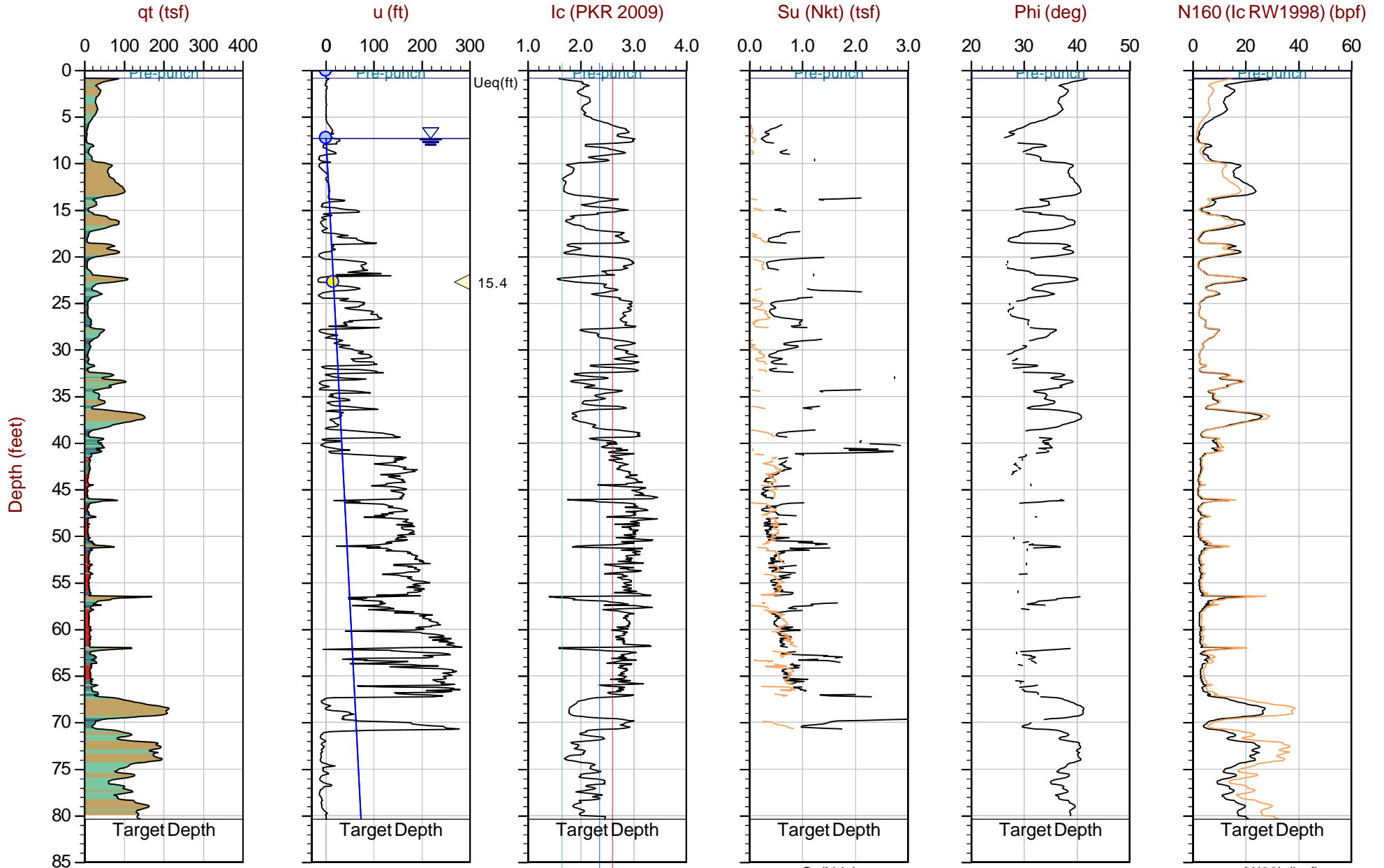

Max Depth: 24.500 m / 80.38 ft
 Depth Inc: 0.025 m / 0.082 ft
 Avg Int: Every Point

File: 23-59-26282_CP03.COR
 Unit Wt: SBTQtn(PKR2009)
 Su Nkt/Ndu: 15.0 / 8.0

SBT: Robertson, 2009 and 2010
 Coords: Lat: 47.19118 Long: -122.29152

● Equilibrium Pore Pressure (Ueq) ● Assumed Ueq ◁ Dissipation, Ueq achieved ◁ Dissipation, Ueq not achieved — Hydrostatic Line

The reported coordinates were acquired from consumer-grade GPS equipment and are only approximate locations. The coordinates should not be used for design purposes.

Seismic Cone Penetration Test Plots

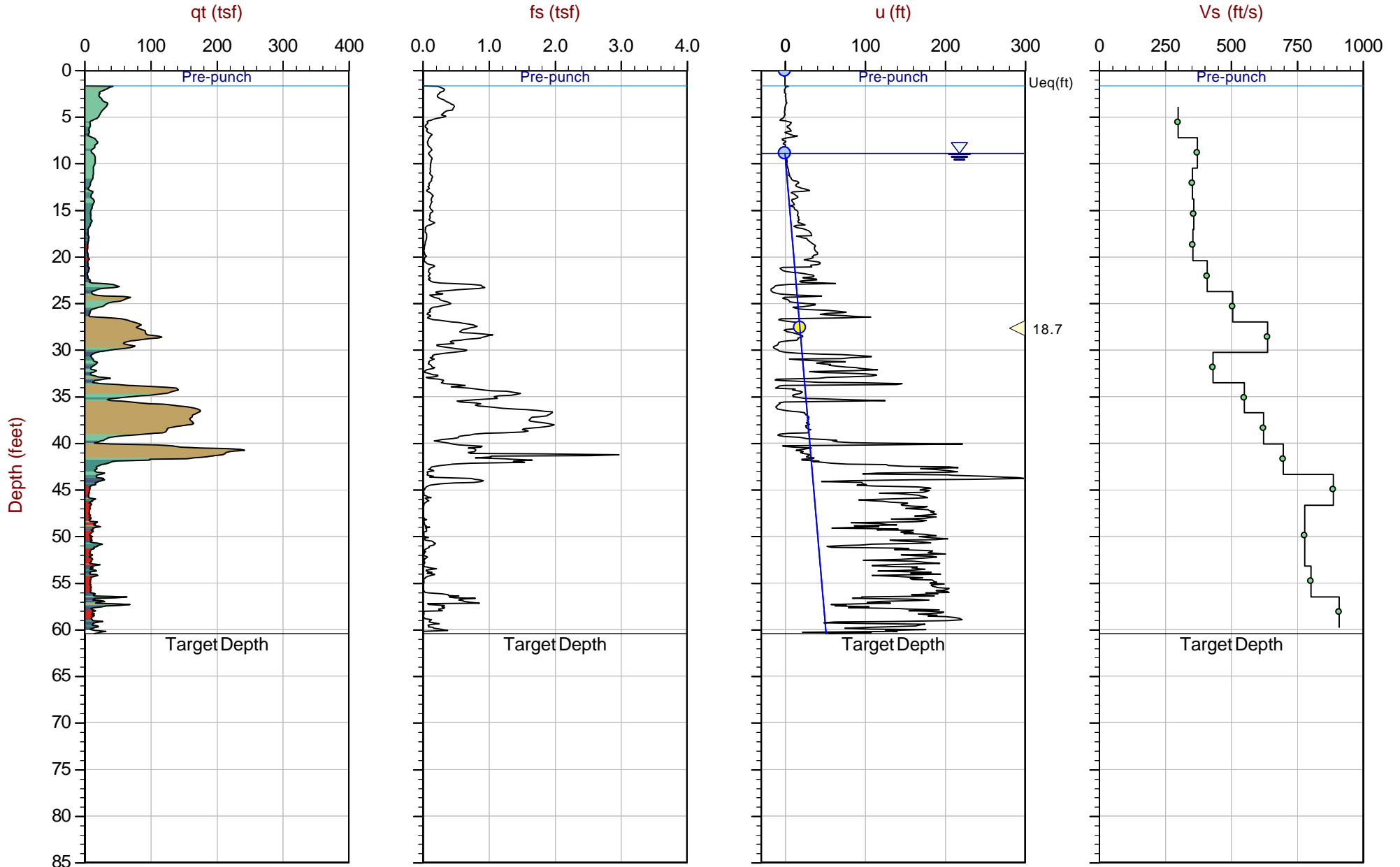

Max Depth: 18.425 m / 60.45 ft
 Depth Inc: 0.025 m / 0.082 ft
 Avg Int: Every Point

File: 23-59-26282_SP02.COR
 Unit Wt: SBTQtn(PKR2009)

SBT: Robertson, 2009 and 2010
 Coords: Lat: 47.19168 Long: -122.29234

● Equilibrium Pore Pressure (Ueq)
 ● Assumed Ueq
 ◁ Dissipation, Ueq achieved
 ◁ Dissipation, Ueq not achieved
 — Hydrostatic Line

The reported coordinates were acquired from consumer-grade GPS equipment and are only approximate locations. The coordinates should not be used for design purposes.

Seismic Cone Penetration Test Shear Wave (V_s) Tabular Results



Job No: 23-59-26282
Client: Columbia West Engineering, Inc.
Project: Seasons on Meeker CPT
Sounding ID: CPT-01
Date: 02-Aug-2023

Seismic Source: Beam
Source Offset (ft): 1.74
Source Depth (ft): 0.00
Geophone Offset (ft): 0.66

SCPT_u SHEAR WAVE VELOCITY TEST RESULTS - Vs

Tip Depth (ft)	Geophone Depth (ft)	Ray Path (ft)	Ray Path Difference (ft)	Travel Time Interval (ms)	Interval Velocity (ft/s)
4.59	3.94	4.30			
7.87	7.22	7.42	3.12	10.43	299
11.15	10.50	10.64	3.22	8.66	372
14.44	13.78	13.89	3.25	9.21	353
17.72	17.06	17.15	3.26	9.09	359
21.10	20.44	20.51	3.36	9.47	355
24.38	23.72	23.78	3.27	7.99	409
27.66	27.00	27.06	3.27	6.46	507
30.94	30.28	30.33	3.27	5.13	639
34.19	33.53	33.58	3.24	7.51	432
37.40	36.75	36.79	3.21	5.84	550
40.75	40.09	40.13	3.34	5.36	623
44.03	43.37	43.41	3.28	4.70	697
47.31	46.65	46.69	3.28	3.69	888
53.87	53.22	53.24	6.56	8.42	778
57.15	56.50	56.52	3.28	4.09	802
60.43	59.78	59.80	3.28	3.61	909

Seismic Cone Penetration Test Shear Wave (V_s) Traces

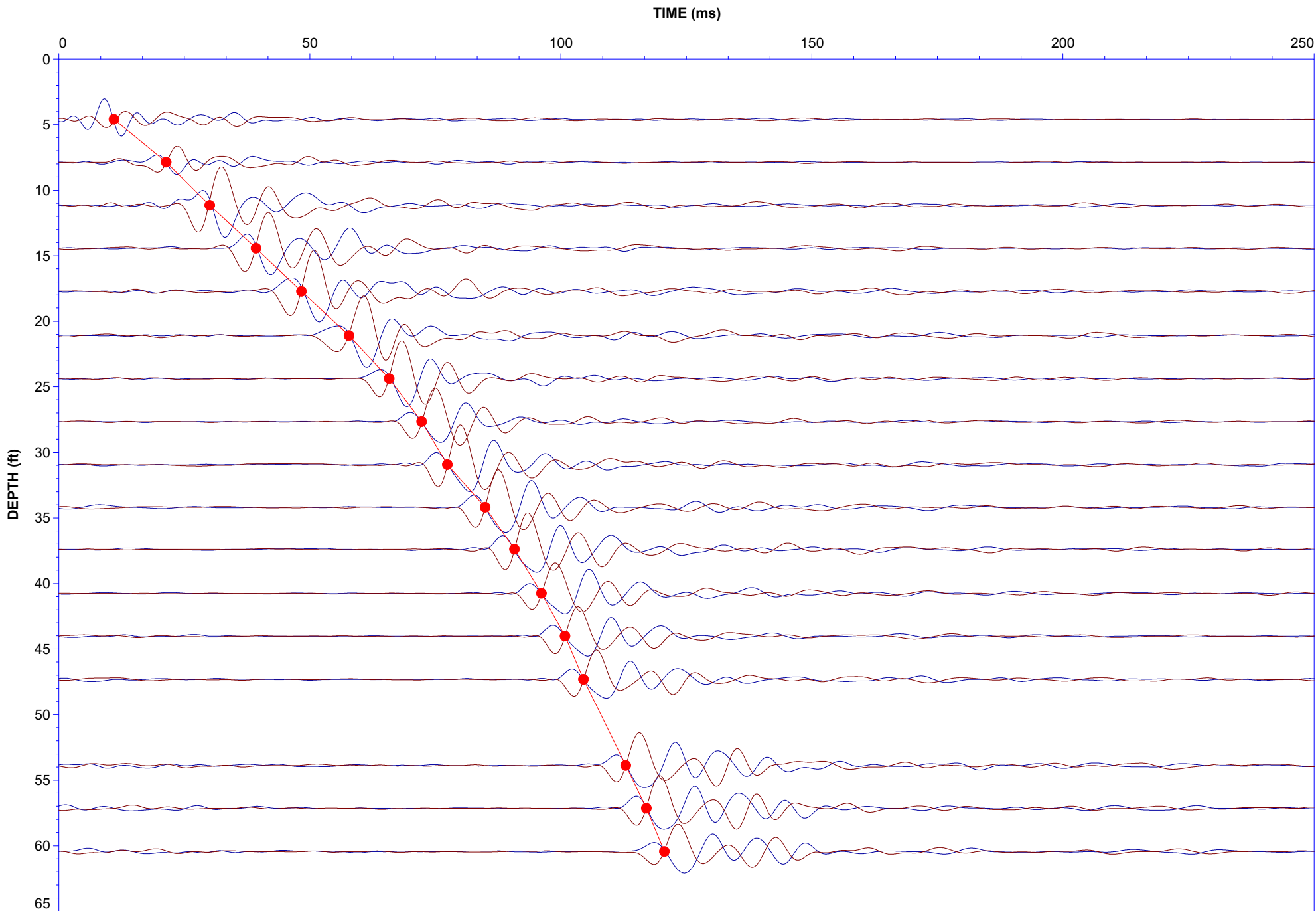

Soil Behavior Type (SBT) Scatter Plots

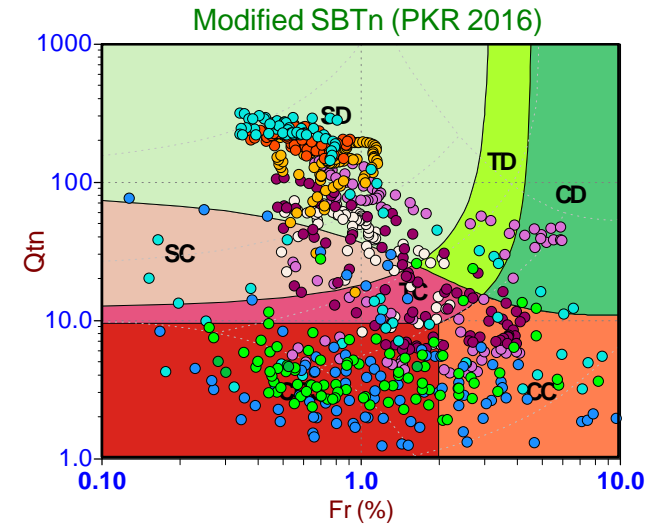
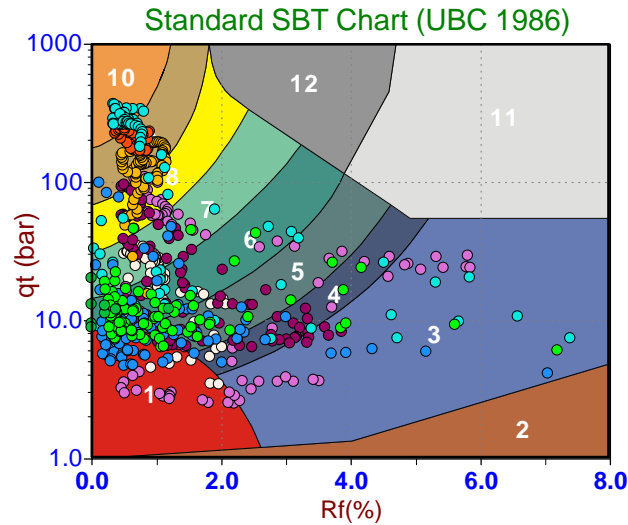
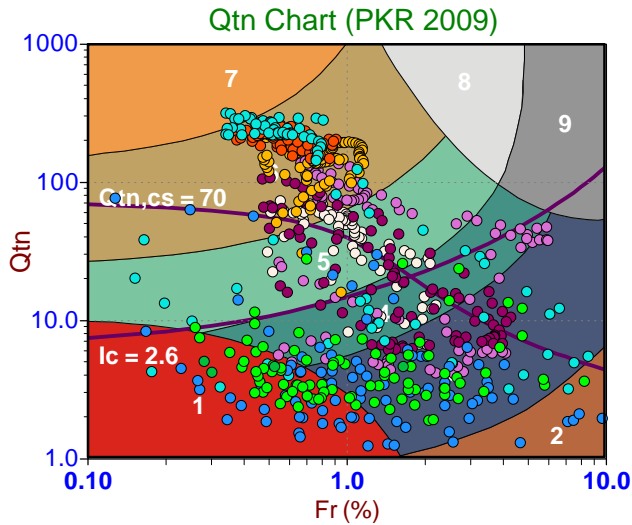

Depth Ranges

- >0.0 to 7.5 ft
- >7.5 to 15.0 ft
- >15.0 to 22.5 ft
- >22.5 to 30.0 ft
- >30.0 to 37.5 ft
- >37.5 to 45.0 ft
- >45.0 to 52.5 ft
- >52.5 to 60.0 ft
- >60.0 to 67.5 ft
- >67.5 to 75.0 ft
- >75.0 ft

Legend

- Sensitive, Fine Grained
- Organic Soils
- Clays
- Silt Mixtures
- Sand Mixtures
- Sands
- Gravelly Sand to Sand
- Stiff Sand to Clayey Sand
- Very Stiff Fine Grained

Legend

- Sensitive Fines
- Organic Soil
- Clay
- Silty Clay
- Clayey Silt
- Silt
- Sandy Silt
- Silty Sand/Sand
- Sand
- Gravelly Sand
- Stiff Fine Grained
- Cemented Sand

Legend

- CCS (Cont. sensitive clay like)
- CC (Cont. clay like)
- TC (Cont. transitional)
- SC (Cont. sand like)
- CD (Dil. clay like)
- TD (Dil. transitional)
- SD (Dil. sand like)

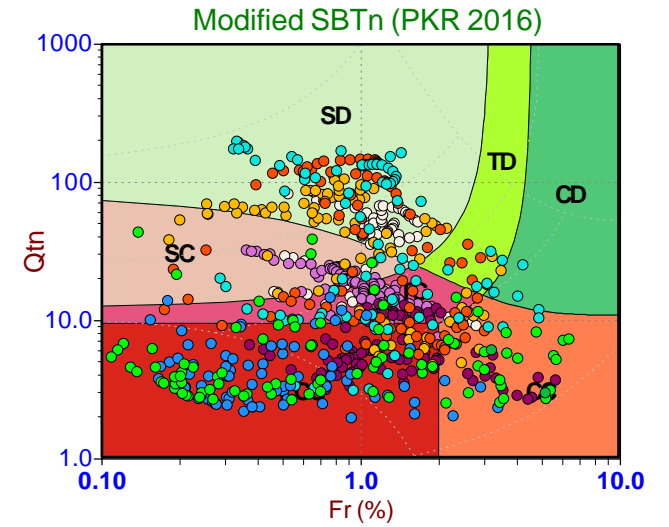
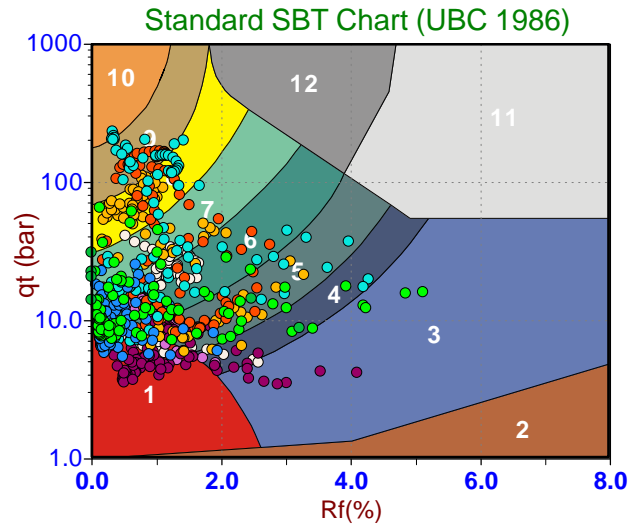
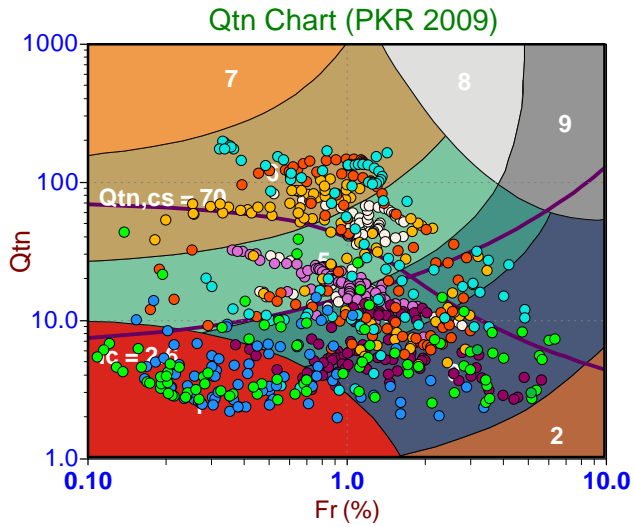

Depth Ranges

- >0.0 to 7.5 ft
- >7.5 to 15.0 ft
- >15.0 to 22.5 ft
- >22.5 to 30.0 ft
- >30.0 to 37.5 ft
- >37.5 to 45.0 ft
- >45.0 to 52.5 ft
- >52.5 to 60.0 ft
- >60.0 to 67.5 ft
- >67.5 to 75.0 ft
- >75.0 ft

Legend

- Sensitive, Fine Grained
- Organic Soils
- Clays
- Silt Mixtures
- Sand Mixtures
- Sands
- Gravelly Sand to Sand
- Stiff Sand to Clayey Sand
- Very Stiff Fine Grained

Legend

- Sensitive Fines
- Organic Soil
- Clay
- Silty Clay
- Clayey Silt
- Silt
- Sandy Silt
- Silty Sand/Sand
- Sand
- Gravelly Sand
- Stiff Fine Grained
- Cemented Sand

Legend

- CCS (Cont. sensitive clay like)
- CC (Cont. clay like)
- TC (Cont. transitional)
- SC (Cont. sand like)
- CD (Dil. clay like)
- TD (Dil. transitional)
- SD (Dil. sand like)

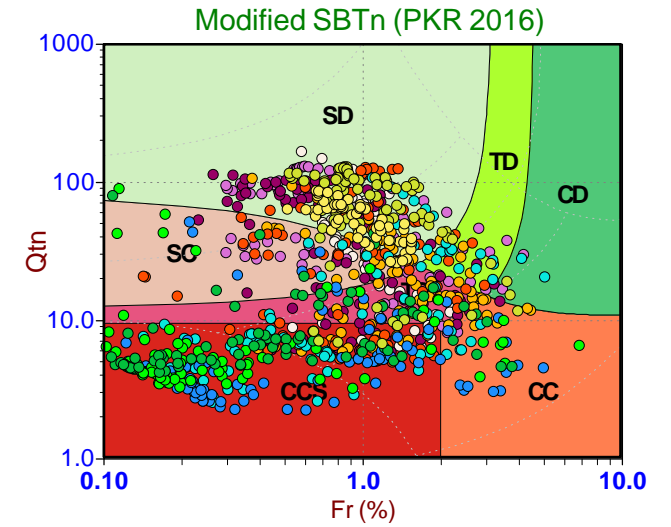
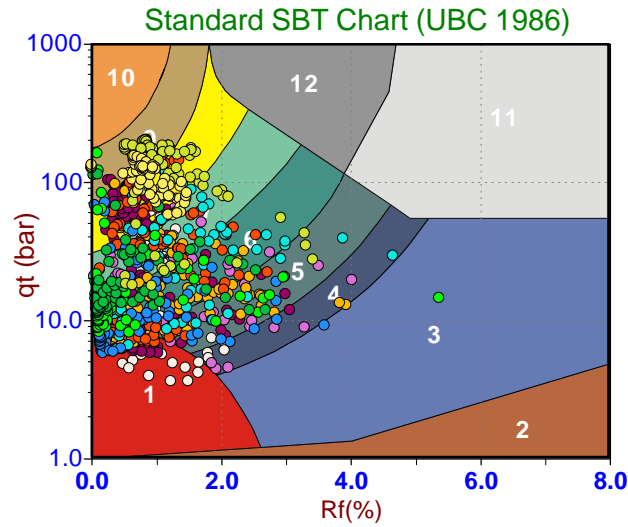
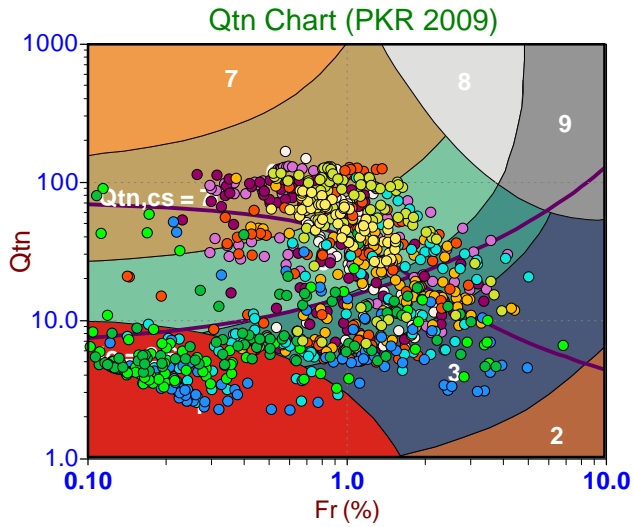

Depth Ranges

- >0.0 to 7.5 ft
- >7.5 to 15.0 ft
- >15.0 to 22.5 ft
- >22.5 to 30.0 ft
- >30.0 to 37.5 ft
- >37.5 to 45.0 ft
- >45.0 to 52.5 ft
- >52.5 to 60.0 ft
- >60.0 to 67.5 ft
- >67.5 to 75.0 ft
- >75.0 ft

Legend

- Sensitive, Fine Grained
- Organic Soils
- Clays
- Silt Mixtures
- Sand Mixtures
- Sands
- Gravelly Sand to Sand
- Stiff Sand to Clayey Sand
- Very Stiff Fine Grained

Legend

- Sensitive Fines
- Organic Soil
- Clay
- Silty Clay
- Clayey Silt
- Silt
- Sandy Silt
- Silty Sand/Sand
- Sand
- Gravelly Sand
- Stiff Fine Grained
- Cemented Sand

Legend

- CCS (Cont. sensitive clay like)
- CC (Cont. clay like)
- TC (Cont. transitional)
- SC (Cont. sand like)
- CD (Dil. clay like)
- TD (Dil. transitional)
- SD (Dil. sand like)

Pore Pressure Dissipation Summary and Pore Pressure Dissipation Plots



Job No: 23-59-26282
Client: Columbia West Engineering, Inc.
Project: Seasons on Meeker CPT
Start Date: 02-Aug-2023
End Date: 02-Aug-2023

CPT_u PORE PRESSURE DISSIPATION SUMMARY

Sounding ID	File Name	Cone Area (cm ²)	Duration (s)	Test Depth (ft)	Estimated Equilibrium Pore Pressure U _{eq} (ft)	Calculated Phreatic Surface (ft)
CPT-01	23-59-26282_CP01	15	365	13.4	3.8	9.6
CPT-02	23-59-26282_SP02	15	520	27.6	18.7	8.9
CPT-03	23-59-26282_CP03	15	840	22.7	15.4	7.3
Total Duration			28.8 min			



Columbia West

Job No: 23-59-26282
Date: 08/02/2023 09:11
Site: Seasons on Meeker CPT

Sounding: CPT-01
Cone: 921:T1500F15U35 Area=15 cm²

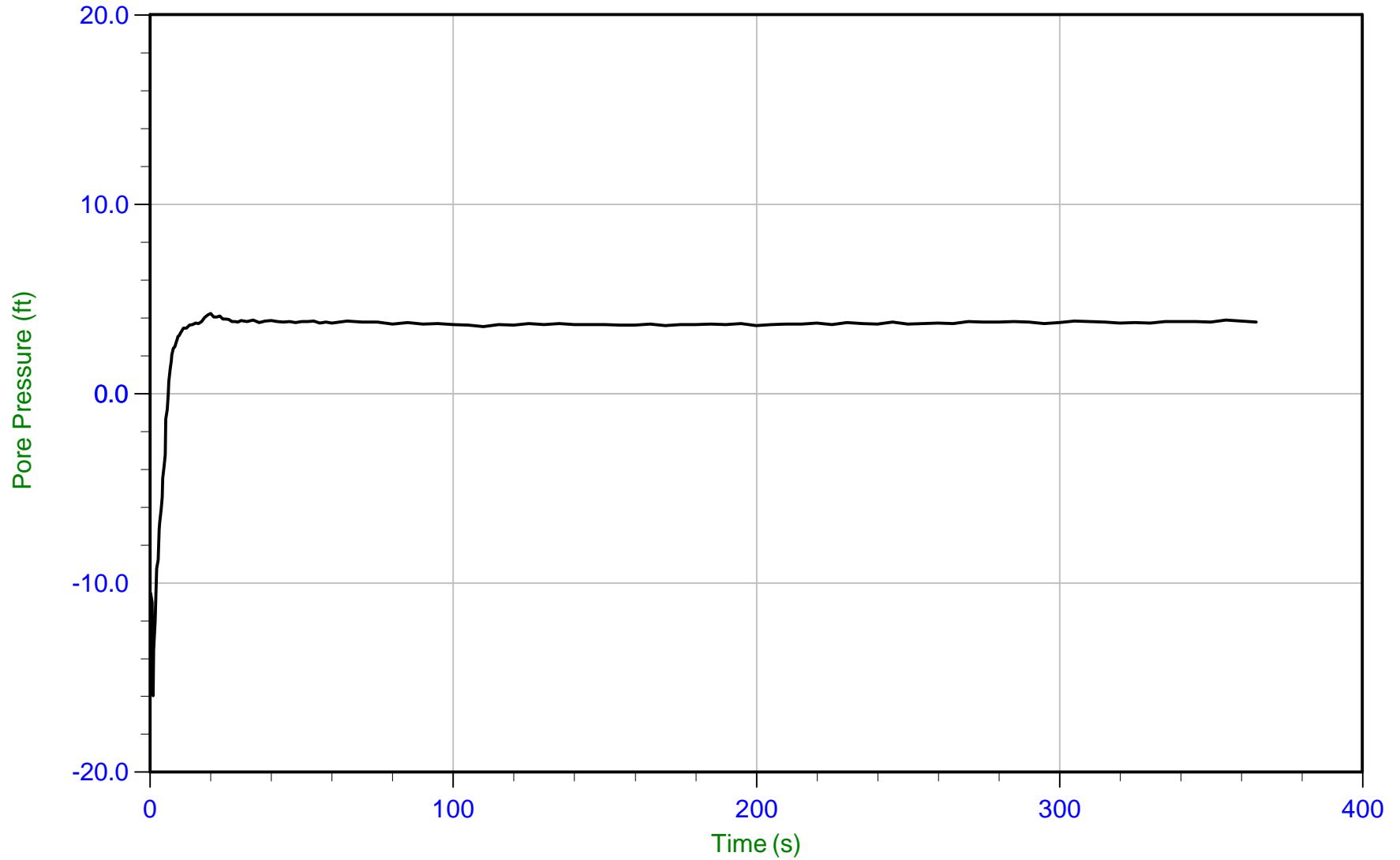

Trace Summary:

Filename: 23-59-26282_CP01.ppd2
Depth: 4.075 m / 13.369 ft
Duration: 365.0 s

u Min: -16.0 ft
u Max: 4.2 ft
u Final: 3.8 ft

WT: 2.914 m / 9.562 ft
Ueq: 3.8 ft



Columbia West

Job No: 23-59-26282
Date: 08/02/2023 10:16
Site: Seasons on Meeker CPT

Sounding: CPT-02
Cone: 921:T1500F15U35 Area=15 cm²

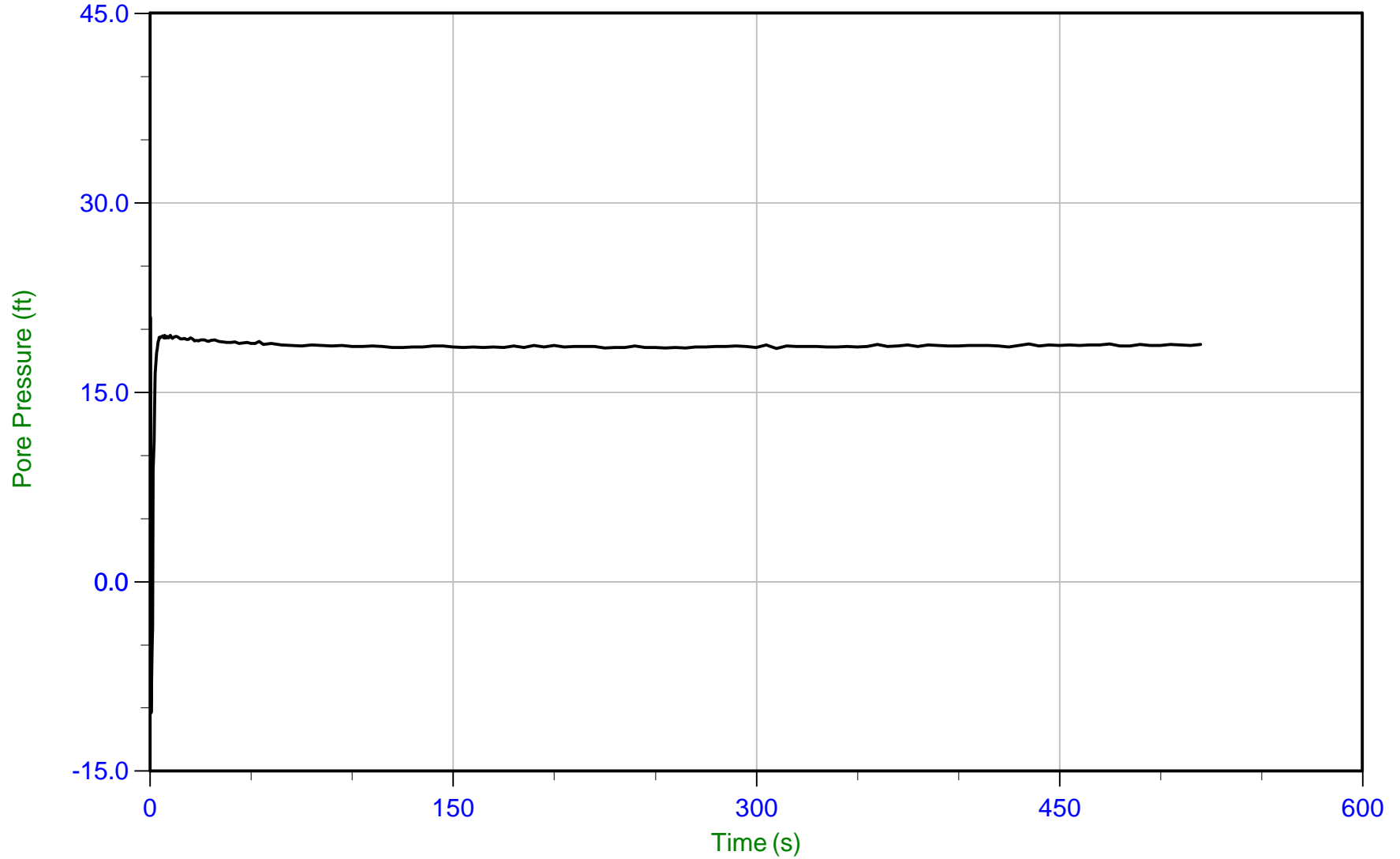

Trace Summary:

Filename: 23-59-26282_SP02.ppd2
Depth: 8.425 m / 27.641 ft
Duration: 520.0 s

u Min: -10.4 ft
u Max: 21.0 ft
u Final: 18.8 ft

WT: 2.713 m / 8.899 ft
Ueq: 18.7 ft



Columbia West

Job No: 23-59-26282
Date: 08/02/2023 11:55
Site: Seasons on Meeker CPT

Sounding: CPT-03
Cone: 921:T1500F15U35 Area=15 cm²

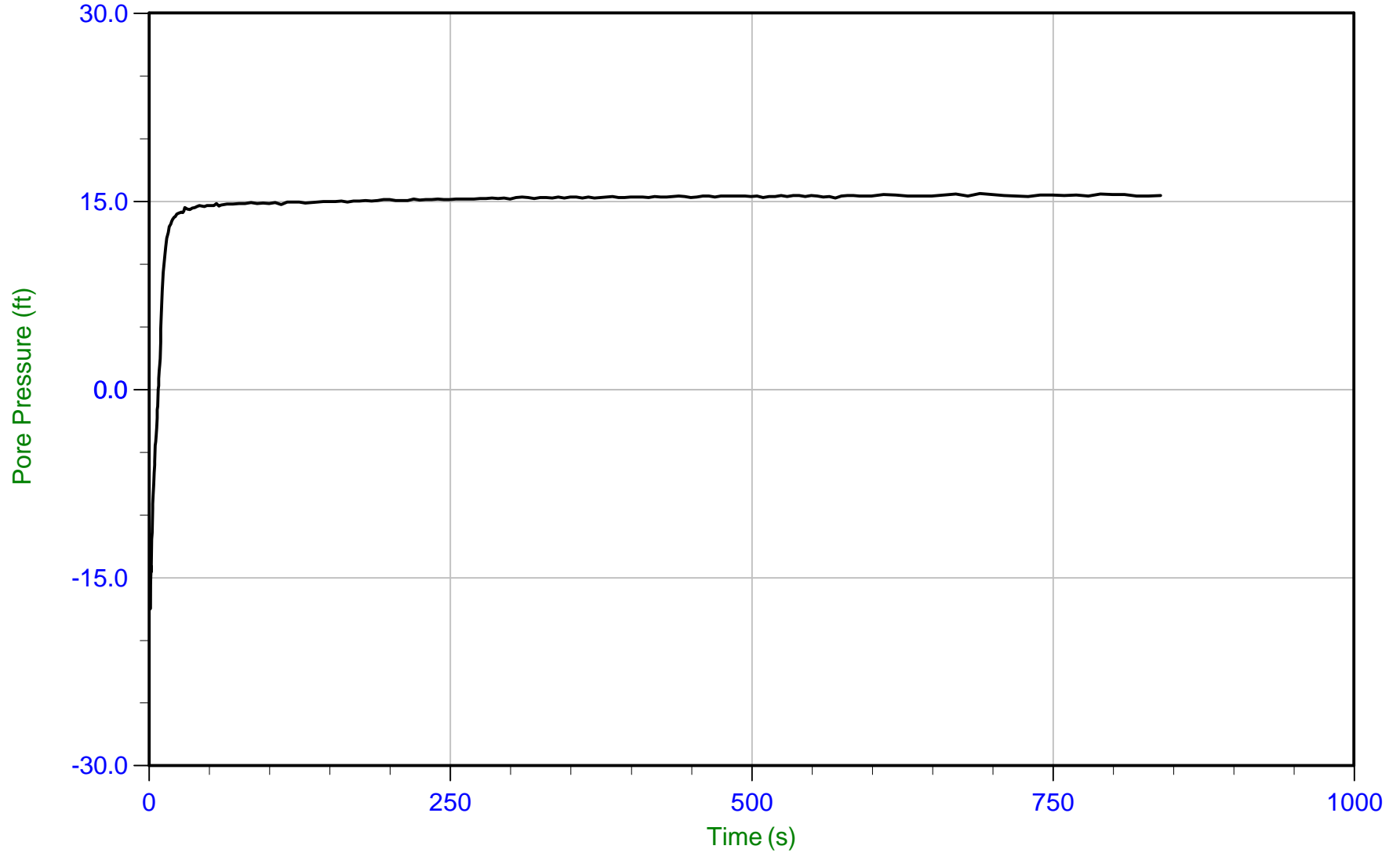

Trace Summary:

Filename: 23-59-26282_CP03.ppd2
Depth: 6.925 m / 22.720 ft
Duration: 840.0 s

u Min: -17.5 ft
u Max: 15.6 ft
u Final: 15.5 ft

WT: 2.223 m / 7.293 ft
Ueq: 15.4 ft

dissipation rates can be measured. Shear wave velocity of the subsurface soil can be measured, typically on increments of 1 meter to 2 meters.

APPENDIX B LABORATORY TESTING

CLASSIFICATION

The soil samples collected in the field were classified in the laboratory to confirm field classifications. The laboratory classifications are shown on the exploration logs if those classifications differed from the field classifications.

MOISTURE CONTENT

We determined the natural moisture content of select soil samples in general accordance with ASTM D2216. The natural moisture content is a ratio of the weight of the water to soil in a test sample and is expressed as a percentage. The test results are presented in this appendix.

PARTICLE-SIZE ANALYSIS

We completed particle-size analyses on select soil samples in general accordance with ASTM D6913. This test is a quantitative determination of the soil particle size distribution expressed as a percentage of dry soil weight. The test results are presented in this appendix.

ATTERBERG LIMITS

We determined the Atterberg Limits on selected samples in general accordance with ASTM D4318. Atterberg limits include the liquid limit, plastic limit, and the plasticity index of soils. These index properties are used to classify soils and for correlation with other engineering properties of soils. The test results are presented in this appendix.

MOISTURE CONTENT, PERCENT PASSING NO. 200 SIEVE BY WASHING

PROJECT Season on Meeker Puyallup, Washington	CLIENT Palindrome Puyallup, LLC 412 NW 5th Avenue, Suite 200 Portland, Oregon 97209	PROJECT NO. Palindrome-1-01-01	REPORT DATE 08/02/23
		DATE SAMPLED 07/17/23 & 07/18/23	
		SAMPLED BY EMU	

LABORATORY TEST DATA

TEST PROCEDURE ASTM D2216 - Method A, ASTM D1140

LAB ID	CONTAINER MASS	MOIST MASS + PAN	DRY MASS + PAN	AFTER WASH DRY MASS + PAN	MATERIAL DESCRIPTION	FIELD ID	SAMPLE DEPTH	MOISTURE CONTENT	PASSING NO. 200 SIEVE
S23-0909	87.00	254.73	213.46	-	brown Sandy SILT	B1.1	2.5 feet	33%	-
S23-0910	87.38	274.15	215.71	-	brown/gray SILT	B1.4	10 feet	46%	-
S23-0911	540.97	860.96	769.84	554.30	gray SILT	B1.6	20 feet	40%	94%
S23-0912	87.19	289.52	237.38	-	gray Silty SAND	B1.8	30 feet	35%	-
S23-0913	548.12	893.16	803.36	620.57	gray SILT with Sand	B1.9	35 feet	35%	72%
S23-0914	548.55	1,019.83	949.78	-	gray Silty SAND	B1.10	40 feet	17%	-
S23-0915	775.98	3,257.38	2,885.00	-	gray Silty SAND with Gravel	B1.11	45 feet	18%	-
S23-0916	556.07	877.14	815.87	sieved sample	gray Silty Clayey SAND	B1.12	50 feet	24%	31%
S23-0917	87.54	281.95	227.56	-	tan Silty SAND	B2.3	7.5 feet	39%	-
S23-0918	85.97	309.17	242.93	-	blue/gray Sandy SILT	B2.6	15 feet	42%	-
S23-0919	541.93	745.21	678.58	sieved sample	blue/gray SILT	B2.7	20 feet	49%	94%
S23-0920	85.80	287.92	247.01	-	blue/gray Silty SAND	B2.9	26.5 feet	25%	-
S23-0921	542.65	821.37	729.06	557.96	blue/gray SILT	B3.2	5 feet	50%	92%

NOTES: Sample weight received for Lab ID: S23-0916 did not meet the minimum size requirement; entire sample used for analysis.	DATE TESTED 07/28/23	TESTED BY MRS
		

MOISTURE CONTENT, PERCENT PASSING NO. 200 SIEVE BY WASHING

PROJECT Season on Meeker Puyallup, Washington	CLIENT Palindrome Puyallup, LLC 412 NW 5th Avenue, Suite 200 Portland, Oregon 97209	PROJECT NO. Palindrome-1-01-01	REPORT DATE 08/10/23
		DATE SAMPLED 08/02/23	
		SAMPLED BY EMU	

LABORATORY TEST DATA

TEST PROCEDURE
 ASTM D2216 - Method A, ASTM D1140

LAB ID	CONTAINER MASS	MOIST MASS + PAN	DRY MASS + PAN	AFTER WASH DRY MASS + PAN	MATERIAL DESCRIPTION	FIELD ID	SAMPLE DEPTH	MOISTURE CONTENT	PASSING NO. 200 SIEVE
S23-0970	542.67	703.68	680.97	645.09	brown Silty SAND	TP1.2	2 feet	16%	26%
S23-0971	540.91	779.28	729.24	sieved sample	brown Silty SAND	TP1.3	5 feet	27%	34%
S23-0972	86.11	179.39	149.75	-	blue/gray SILT	TP1.4	8 feet	47%	-
S23-0973	86.93	182.38	151.61	-	gray SILT	TP3.2	8 feet	48%	-
S23-0974	548.15	851.31	818.33	770.45	gray/brown Silty SAND	TP4.2	6 feet	12%	18%
S23-0975	87.88	227.83	189.98	-	gray/blue SILT with Sand	TP4.3	9 feet	37%	-

NOTES:	DATE TESTED	TESTED BY
	08/08/23	ANK/KMS
		

This report may not be reproduced except in full without prior written authorization by Columbia West Engineering, Inc. COLUMBIA WEST ENGINEERING, INC. authorized signature

PARTICLE-SIZE ANALYSIS REPORT

PROJECT Season on Meeker Puyallup, Washington	CLIENT Palindrome Puyallup, LLC 412 NW 5th Avenue, Suite 200 Portland, Oregon 97209	PROJECT NO. Palindrome-1-01-01	LAB ID S23-0916
		REPORT DATE 08/02/23	FIELD ID B1.12
		DATE SAMPLED 07/17/23	SAMPLED BY EMU

MATERIAL DATA		
MATERIAL SAMPLED gray Silty Clayey SAND	MATERIAL SOURCE Boring B-01 depth = 50 feet	USCS SOIL TYPE SC-SM, Silty, Clayey Sand
SPECIFICATIONS none		AASHTO CLASSIFICATION A-2-4(0)

LABORATORY TEST DATA	
LABORATORY EQUIPMENT Rainhart "Mary Ann" Sifter, air-dried prep, hand washed, composite sieve - #4 split	TEST PROCEDURE ASTM D6913, Method A

ADDITIONAL DATA initial dry mass (g) = 259.80 as-received moisture content = 24% liquid limit = 23 plastic limit = 18 plasticity index = 5 fineness modulus = n/a coefficient of curvature, C_c = n/a coefficient of uniformity, C_u = n/a effective size, $D_{(10)}$ = n/a $D_{(30)}$ = n/a $D_{(60)}$ = 0.409 mm NOTES: Entire sample used for analysis; did not meet minimum size required.	SIEVE DATA % gravel = 6.7% % sand = 62.3% % silt and clay = 31.0%
---	---

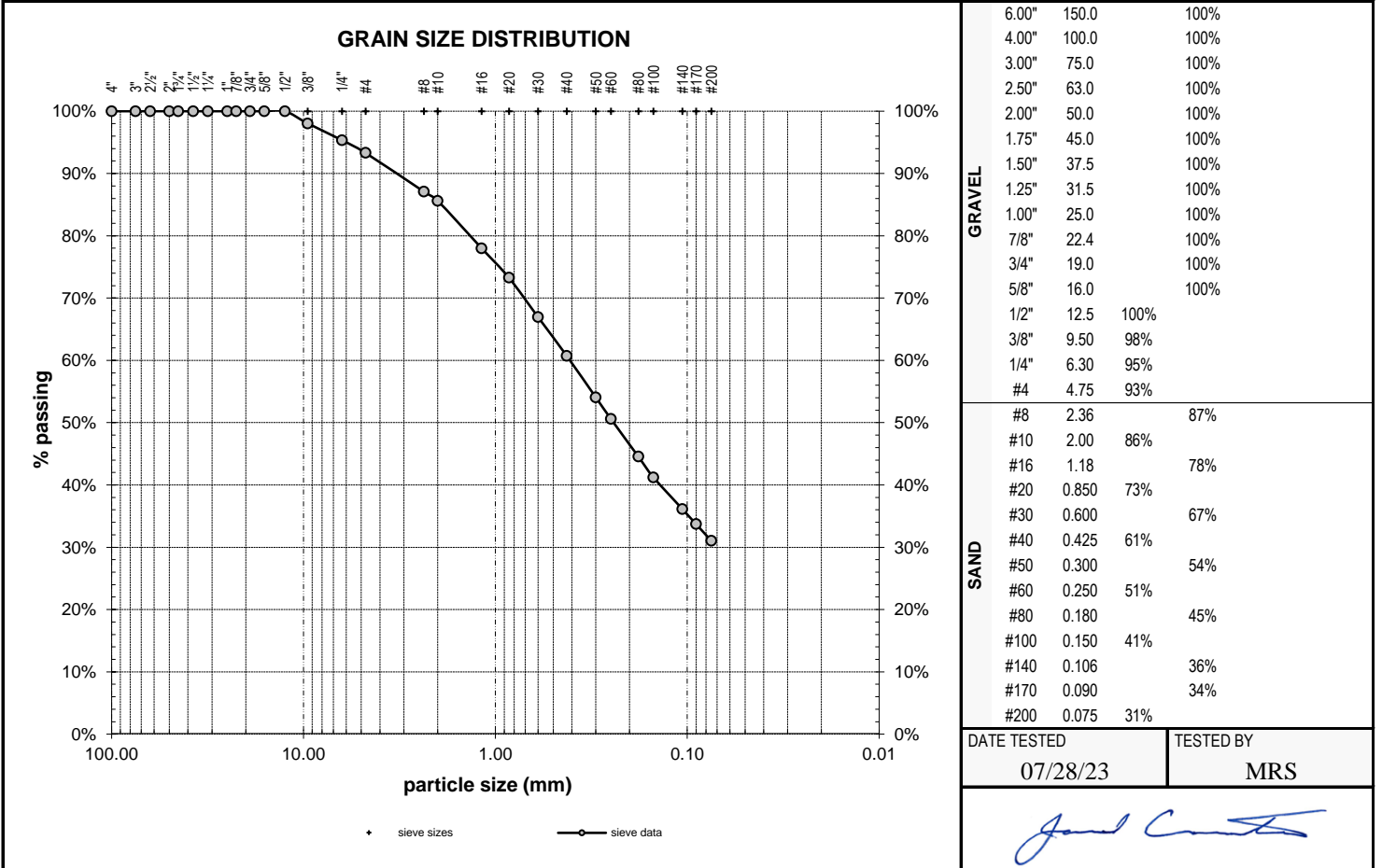

ATTERBERG LIMITS REPORT

PROJECT Season on Meeker Puyallup, Washington	CLIENT Palindrome Puyallup, LLC 412 NW 5th Avenue, Suite 200 Portland, Oregon 97209	PROJECT NO. Palindrome-1-01-01	LAB ID S23-0916
		REPORT DATE 08/02/23	FIELD ID B1.12
		DATE SAMPLED 07/17/23	SAMPLED BY EMU

MATERIAL DATA

MATERIAL SAMPLED gray Silty Clayey SAND	MATERIAL SOURCE Boring B-01 depth = 50 feet	USCS SOIL TYPE SC-SM, Silty, Clayey Sand
---	--	--

LABORATORY TEST DATA

LABORATORY EQUIPMENT Liquid Limit Machine, Hand Rolled	TEST PROCEDURE ASTM D4318
--	-------------------------------------

ATTERBERG LIMITS	LIQUID LIMIT DETERMINATION	①	②	③	④
liquid limit = 23	wet soil + pan weight, g =	32.10	32.81	34.53	32.81
plastic limit = 18	dry soil + pan weight, g =	30.06	30.62	31.96	30.48
plasticity index = 5	pan weight, g =	20.98	20.96	21.02	20.82
	N (blows) =	30	26	22	18
	moisture, % =	22.5 %	22.7 %	23.5 %	24.1 %

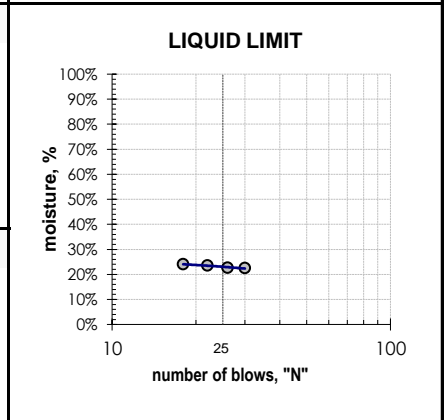

SHRINKAGE	PLASTIC LIMIT DETERMINATION	①	②	③	④
shrinkage limit = n/a	wet soil + pan weight, g =	27.93	27.65		
shrinkage ratio = n/a	dry soil + pan weight, g =	26.85	26.64		
	pan weight, g =	20.87	21.01		
	moisture, % =	18.1 %	17.9 %		

ADDITIONAL DATA

% gravel =	6.7%
% sand =	62.3%
% silt and clay =	31.0%
% silt =	n/a
% clay =	n/a
moisture content =	24%

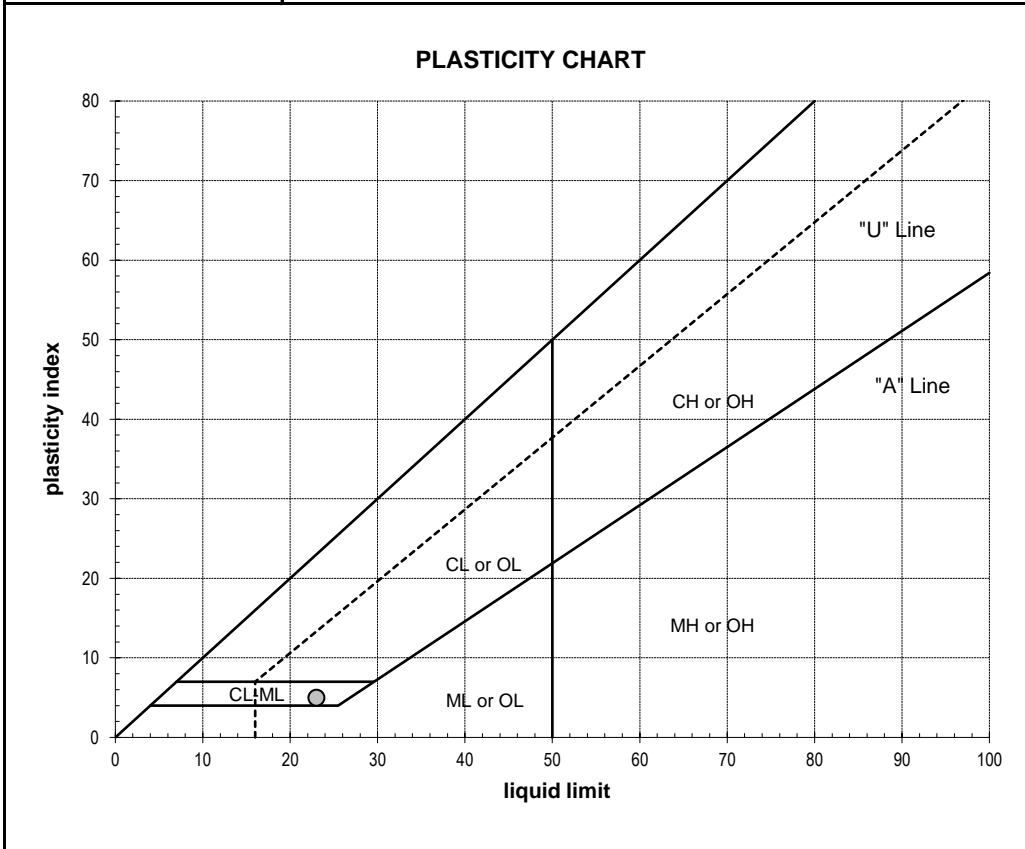

DATE TESTED 07/31/23	TESTED BY KMS
--------------------------------	-------------------------

James Smith

PARTICLE-SIZE ANALYSIS REPORT

PROJECT Season on Meeker Puyallup, Washington	CLIENT Palindrome Puyallup, LLC 412 NW 5th Avenue, Suite 200 Portland, Oregon 97209	PROJECT NO. Palindrome-1-01-01	LAB ID S23-0919
		REPORT DATE 08/02/23	FIELD ID B2.7
		DATE SAMPLED 07/18/23	SAMPLED BY EMU

MATERIAL DATA		
MATERIAL SAMPLED blue/gray SILT	MATERIAL SOURCE Boring B-02 depth = 20 feet	USCS SOIL TYPE ML, Silt
SPECIFICATIONS none		AASHTO CLASSIFICATION A-4(8)

LABORATORY TEST DATA	
LABORATORY EQUIPMENT Rainhart "Mary Ann" Sifter, moist prep, hand washed, 12" single sieve-set	TEST PROCEDURE ASTM D6913, Method A

ADDITIONAL DATA initial dry mass (g) = 136.65 as-received moisture content = 49% liquid limit = 35 plastic limit = 28 plasticity index = 7 fineness modulus = n/a coefficient of curvature, C_c = n/a coefficient of uniformity, C_u = n/a effective size, $D_{(10)}$ = n/a $D_{(30)}$ = n/a $D_{(60)}$ = n/a	SIEVE DATA % gravel = 0.0% % sand = 6.2% % silt and clay = 93.8%
---	--

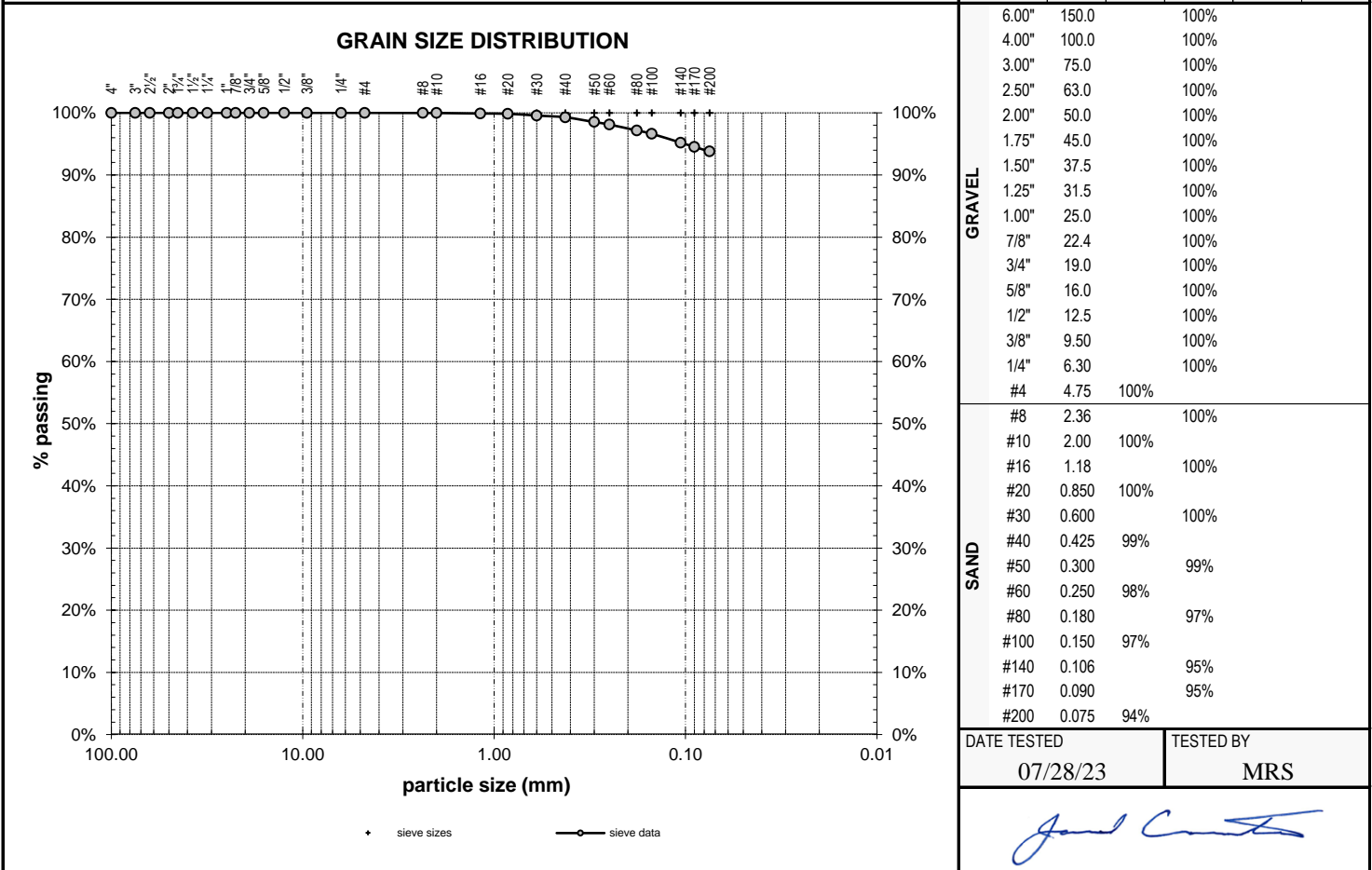

DATE TESTED 07/28/23	TESTED BY MRS

ATTERBERG LIMITS REPORT

PROJECT Season on Meeker Puyallup, Washington	CLIENT Palindrome Puyallup, LLC 412 NW 5th Avenue, Suite 200 Portland, Oregon 97209	PROJECT NO. Palindrome-1-01-01	LAB ID S23-0919
		REPORT DATE 08/02/23	FIELD ID B2.7
		DATE SAMPLED 07/18/23	SAMPLED BY EMU

MATERIAL DATA

MATERIAL SAMPLED blue/gray SILT	MATERIAL SOURCE Boring B-02 depth = 20 feet	USCS SOIL TYPE ML, Silt
------------------------------------	---	----------------------------

LABORATORY TEST DATA

LABORATORY EQUIPMENT Liquid Limit Machine, Hand Rolled	TEST PROCEDURE ASTM D4318
---	------------------------------

ATTERBERG LIMITS	LIQUID LIMIT DETERMINATION																															
liquid limit = 35		<table border="1" style="width: 100%; border-collapse: collapse;"> <tr> <td></td> <td style="text-align: center;">①</td> <td style="text-align: center;">②</td> <td style="text-align: center;">③</td> <td style="text-align: center;">④</td> </tr> <tr> <td>wet soil + pan weight, g =</td> <td style="text-align: center;">32.60</td> <td style="text-align: center;">32.18</td> <td style="text-align: center;">31.45</td> <td style="text-align: center;"></td> </tr> <tr> <td>dry soil + pan weight, g =</td> <td style="text-align: center;">29.50</td> <td style="text-align: center;">29.14</td> <td style="text-align: center;">28.54</td> <td style="text-align: center;"></td> </tr> <tr> <td>pan weight, g =</td> <td style="text-align: center;">20.43</td> <td style="text-align: center;">20.43</td> <td style="text-align: center;">20.56</td> <td style="text-align: center;"></td> </tr> <tr> <td>N (blows) =</td> <td style="text-align: center;">33</td> <td style="text-align: center;">28</td> <td style="text-align: center;">19</td> <td style="text-align: center;"></td> </tr> <tr> <td>moisture, % =</td> <td style="text-align: center;">34.2 %</td> <td style="text-align: center;">34.9 %</td> <td style="text-align: center;">36.5 %</td> <td style="text-align: center;"></td> </tr> </table>		①	②	③	④	wet soil + pan weight, g =	32.60	32.18	31.45		dry soil + pan weight, g =	29.50	29.14	28.54		pan weight, g =	20.43	20.43	20.56		N (blows) =	33	28	19		moisture, % =	34.2 %	34.9 %	36.5 %	
	①	②	③	④																												
wet soil + pan weight, g =	32.60	32.18	31.45																													
dry soil + pan weight, g =	29.50	29.14	28.54																													
pan weight, g =	20.43	20.43	20.56																													
N (blows) =	33	28	19																													
moisture, % =	34.2 %	34.9 %	36.5 %																													
plastic limit = 28																																
plasticity index = 7																																

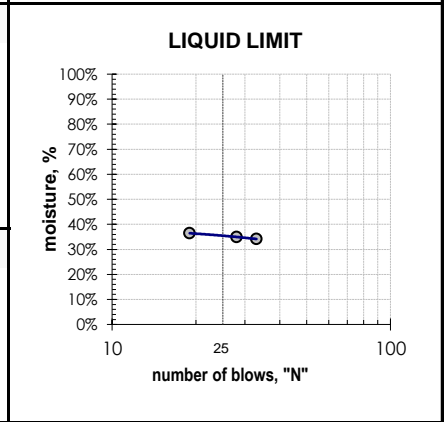

SHRINKAGE	PLASTIC LIMIT DETERMINATION																										
shrinkage limit = n/a		<table border="1" style="width: 100%; border-collapse: collapse;"> <tr> <td></td> <td style="text-align: center;">①</td> <td style="text-align: center;">②</td> <td style="text-align: center;">③</td> <td style="text-align: center;">④</td> </tr> <tr> <td>wet soil + pan weight, g =</td> <td style="text-align: center;">27.41</td> <td style="text-align: center;">28.72</td> <td style="text-align: center;"></td> <td style="text-align: center;"></td> </tr> <tr> <td>dry soil + pan weight, g =</td> <td style="text-align: center;">26.00</td> <td style="text-align: center;">26.99</td> <td style="text-align: center;"></td> <td style="text-align: center;"></td> </tr> <tr> <td>pan weight, g =</td> <td style="text-align: center;">20.93</td> <td style="text-align: center;">20.78</td> <td style="text-align: center;"></td> <td style="text-align: center;"></td> </tr> <tr> <td>moisture, % =</td> <td style="text-align: center;">27.8 %</td> <td style="text-align: center;">27.9 %</td> <td style="text-align: center;"></td> <td style="text-align: center;"></td> </tr> </table>		①	②	③	④	wet soil + pan weight, g =	27.41	28.72			dry soil + pan weight, g =	26.00	26.99			pan weight, g =	20.93	20.78			moisture, % =	27.8 %	27.9 %		
	①	②	③	④																							
wet soil + pan weight, g =	27.41	28.72																									
dry soil + pan weight, g =	26.00	26.99																									
pan weight, g =	20.93	20.78																									
moisture, % =	27.8 %	27.9 %																									
shrinkage ratio = n/a																											

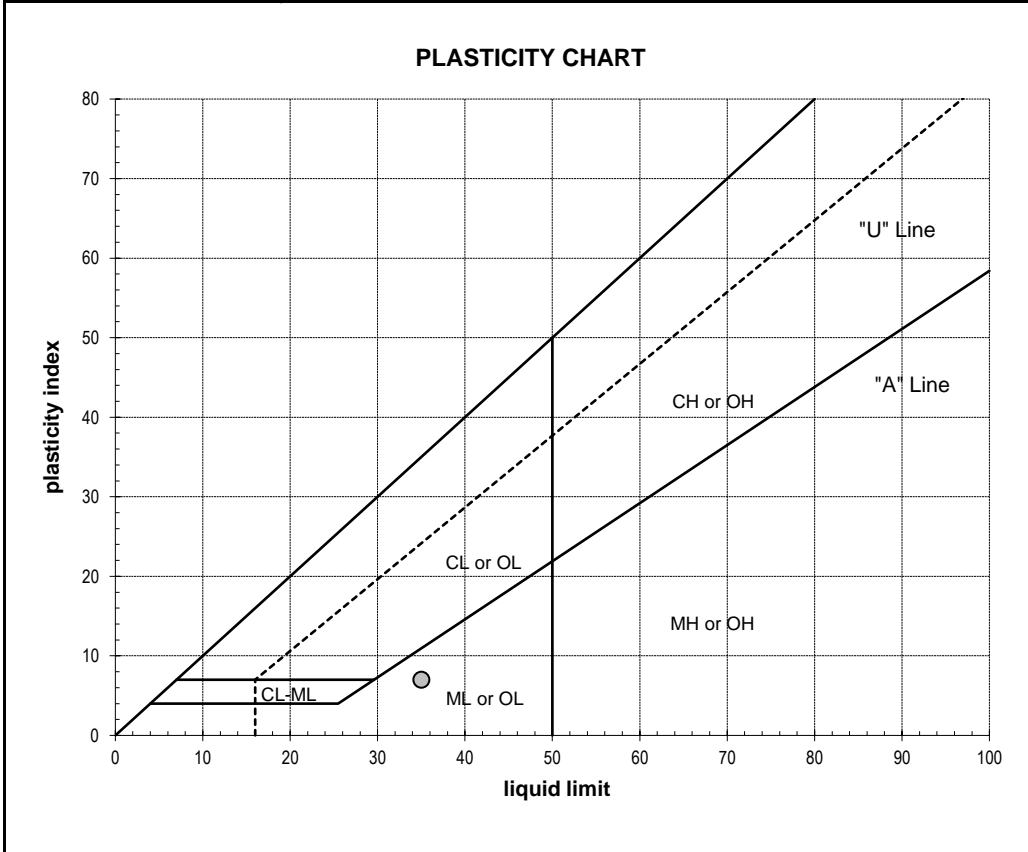

ADDITIONAL DATA	
% gravel = 0.0%	
% sand = 6.2%	
% silt and clay = 93.8%	
% silt = n/a	
% clay = n/a	
moisture content = 49%	

DATE TESTED 07/31/23	TESTED BY ANK/KMS
-------------------------	----------------------

Janet Curtis

PARTICLE-SIZE ANALYSIS REPORT

PROJECT Season on Meeker Puyallup, Washington	CLIENT Palindrome Puyallup, LLC 412 NW 5th Avenue, Suite 200 Portland, Oregon 97209	PROJECT NO.	LAB ID
		REPORT DATE	FIELD ID
		DATE SAMPLED	SAMPLED BY
		08/10/23	TP1.3
		08/02/23	EMU

MATERIAL DATA		
MATERIAL SAMPLED brown Silty SAND	MATERIAL SOURCE Test Pit TP-01 depth = 5 feet	USCS SOIL TYPE SM, Silty Sand
SPECIFICATIONS none		AASHTO CLASSIFICATION A-2-4(0)

LABORATORY TEST DATA	
LABORATORY EQUIPMENT Rainhart "Mary Ann" Sifter, moist prep, hand washed, 12" single sieve-set	TEST PROCEDURE ASTM D6913, Method A

ADDITIONAL DATA	
initial dry mass (g) = 188.33 as-received moisture content = 27% liquid limit = - plastic limit = - plasticity index = NP fineness modulus = n/a	coefficient of curvature, C_c = n/a coefficient of uniformity, C_u = n/a effective size, $D_{(10)}$ = n/a $D_{(30)}$ = n/a $D_{(60)}$ = 0.127 mm

SIEVE DATA					
			% gravel = 0.0%		
			% sand = 66.4%		
			% silt and clay = 33.6%		
SIEVE SIZE	PERCENT PASSING		SPECS		min
	US	mm	act.	interp.	

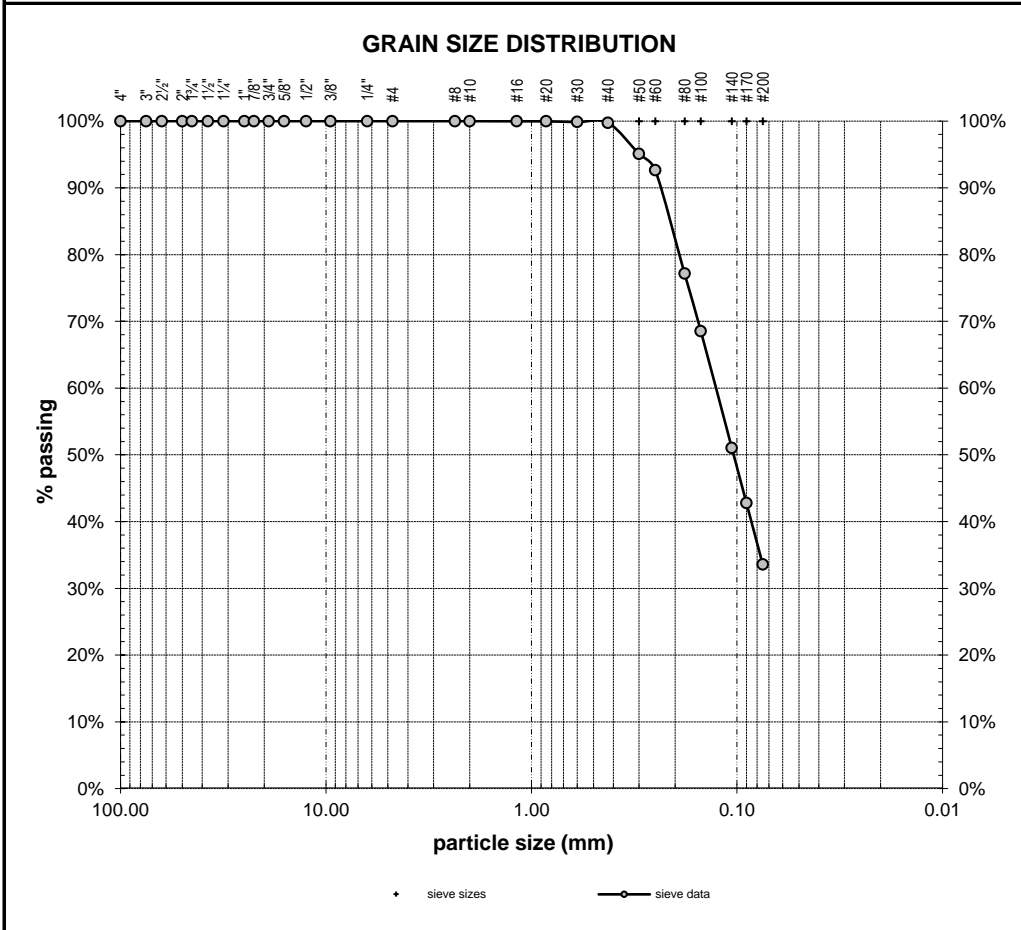

GRAVEL	6.00"	150.0	100%	
	4.00"	100.0	100%	
	3.00"	75.0	100%	
	2.50"	63.0	100%	
	2.00"	50.0	100%	
	1.75"	45.0	100%	
	1.50"	37.5	100%	
	1.25"	31.5	100%	
	1.00"	25.0	100%	
	7/8"	22.4	100%	
	3/4"	19.0	100%	
	5/8"	16.0	100%	
	1/2"	12.5	100%	
	3/8"	9.50	100%	
	1/4"	6.30	100%	
SAND	#4	4.75	100%	
	#8	2.36	100%	
	#10	2.00	100%	
	#16	1.18	100%	
	#20	0.850	100%	
	#30	0.600	100%	
	#40	0.425	100%	
	#50	0.300	95%	
	#60	0.250	93%	
	#80	0.180	77%	
#100	0.150	69%		
#140	0.106	51%		
#170	0.090	43%		
#200	0.075	34%		

DATE TESTED 08/09/23	TESTED BY KMS
-------------------------	------------------

James C. Smith

APPENDIX C
SOIL CLASSIFICATION INFORMATION

SOIL DESCRIPTION AND CLASSIFICATION

Particle-Size Classification

COMPONENT	ASTM / USCS		AASHTO	
	size range	sieve size range	size range	sieve size range
Boulders	Greater than 300 mm	Greater than 12 inches	-	-
Cobbles	75 mm to 300 mm	3 inches to 12 inches	Greater than 75 mm	Greater than 3 inches
Gravel	75 mm to 4.75 mm	3 inches to No. 4 sieve	75 mm to 2.00 mm	3 inches to No. 10 sieve
Coarse	75 mm to 19.0 mm	3 inches to 3/4-inch sieve	-	-
Fine	19.0 mm to 4.75 mm	3/4-inch to No. 4 sieve	-	-
Sand	4.75 mm to 0.075 mm	No. 4 to No. 200 sieve	2.00 mm to 0.075 mm	No. 10 to No. 200 sieve
Coarse	4.75 mm to 2.00 mm	No. 4 to No. 10 sieve	2.00 mm to 0.425 mm	No. 10 to No. 40 sieve
Medium	2.00 mm to 0.425 mm	No. 10 to No. 40 sieve	-	-
Fine	0.425 mm to 0.075 mm	No. 40 to No. 200 sieve	0.425 mm to 0.075 mm	No. 40 to No. 200 sieve
Fines (Silt and Clay)	Less than 0.075 mm	Passing No. 200 sieve	Less than 0.075 mm	Passing No. 200 sieve

Consistency for Cohesive Soil

CONSISTENCY	SPT N-VALUE (BLOWS PER FOOT)	D&M N-VALUE (BLOWS PER FOOT)	POCKET PENETROMETER (UNCONFINED COMPRESSIVE STRENGTH, tsf)
Very Soft	Less than 2	Less than 3	Less than 0.25
Soft	2 to 4	3 to 6	0.25 to 0.50
Medium Stiff	4 to 8	6 to 12	0.50 to 1.0
Stiff	8 to 15	12 to 25	1.0 to 2.0
Very Stiff	15 to 30	25 to 65	2.0 to 4.0
Hard	30 to 60	65 to 145	Greater than 4.0
Very Hard	Greater than 60	Greater than 145	-

Relative Density for Granular Soil

RELATIVE DENSITY	SPT N-VALUE (BLOWS PER FOOT)	D&M N-VALUE (BLOWS PER FOOT)
Very Loose	0 to 4	0 to 11
Loose	4 to 10	11 to 26
Medium Dense	10 to 30	26 to 74
Dense	30 to 50	74 to 120
Very Dense	Greater than 50	Greater than 120

Moisture Designations

Additional Constituents

TERM	FIELD IDENTIFICATION
Dry	No moisture. Dusty or dry.
Damp	Some moisture. Cohesive soils are usually below plastic limit and are moldable.
Moist	Grains appear darkened, but no visible water is present. Cohesive soils will clump. Sand will bulk. Soils are often at or near plastic limit.
Wet	Visible water on larger grains. Sand and silt exhibit dilatancy. Cohesive soil can be readily remolded. Soil leaves wetness on the hand when squeezed. Soil is much wetter than optimum moisture content and is above plastic limit.

Percent	Silt and Clay In:		Percent	Sand and Gravel In:	
	Fine-Grained Soil	Coarse-Grained Soil		Fine-Grained Soil	Coarse-Grained Soil
< 5	trace	trace	< 5	trace	trace
5 – 12	minor	with	5 – 15	minor	minor
> 12	some	silty/clayey	15 – 30	with	with
			> 30	sandy/gravelly	with (approx. percentage)

AASHTO SOIL CLASSIFICATION SYSTEM

TABLE 1. Classification of Soils and Soil-Aggregate Mixtures

General Classification	Granular Materials (35 Percent or Less Passing .075 mm)				Silt-Clay Materials (More than 35 Percent Passing 0.075)		
	A-1	A-3	A-2	A-4	A-5	A-6	A-7
Sieve analysis, percent passing:							
2.00 mm (No. 10)	-	-	-	-	-	-	-
0.425 mm (No. 40)	50 max	51 min	-	-	-	-	-
0.075 mm (No. 200)	25 max	10 max	35 max	36 min	36 min	36 min	36 min
<u>Characteristics of fraction passing 0.425 mm (No. 40)</u>							
Liquid limit				40 max	41 min	40 max	41 min
Plasticity index	6 max	N.P.		10 max	10 max	11 min	11 min
General rating as subgrade	Excellent to good				Fair to poor		

Note: The placing of A-3 before A-2 is necessary in the "left to right elimination process" and does not indicate superiority of A-3 over A-2.

TABLE 2. Classification of Soils and Soil-Aggregate Mixtures

General Classification	Granular Materials (35 Percent or Less Passing 0.075 mm)							Silt-Clay Materials (More than 35 Percent Passing 0.075 mm)			
	A-1		A-2					A-7			
Group Classification	A-1-a	A-1-b	A-3	A-2-4	A-2-5	A-2-6	A-2-7	A-4	A-5	A-6	A-7-5, A-7-6
Sieve analysis, percent passing:											
2.00 mm (No. 10)	50 max	-	-	-	-	-	-	-	-	-	-
0.425 mm (No. 40)	30 max	50 max	51 min	-	-	-	-	-	-	-	-
0.075 mm (No. 200)	15 max	25 max	10 max	35 max	35 max	35 max	35 max	36 min	36 min	36 min	36 min
<u>Characteristics of fraction passing 0.425 mm (No. 40)</u>											
Liquid limit				40 max	41 min	40 max	41 min	40 max	41 min	40 max	41 min
Plasticity index	6 max		N.P.	10 max	10 max	11 min	11 min	10 max	10 max	11 min	11 min
Usual types of significant constituent materials	Stone fragments, gravel and sand		Fine sand	Silty or clayey gravel and sand				Silty soils		Clayey soils	
General ratings as subgrade	Excellent to Good							Fair to poor			

Note: Plasticity index of A-7-5 subgroup is equal to or less than LL minus 30. Plasticity index of A-7-6 subgroup is greater than LL minus 30 (see Figure 2).

AASHTO = American Association of State Highway and Transportation Officials

UNIFIED SOIL CLASSIFICATION SYSTEM

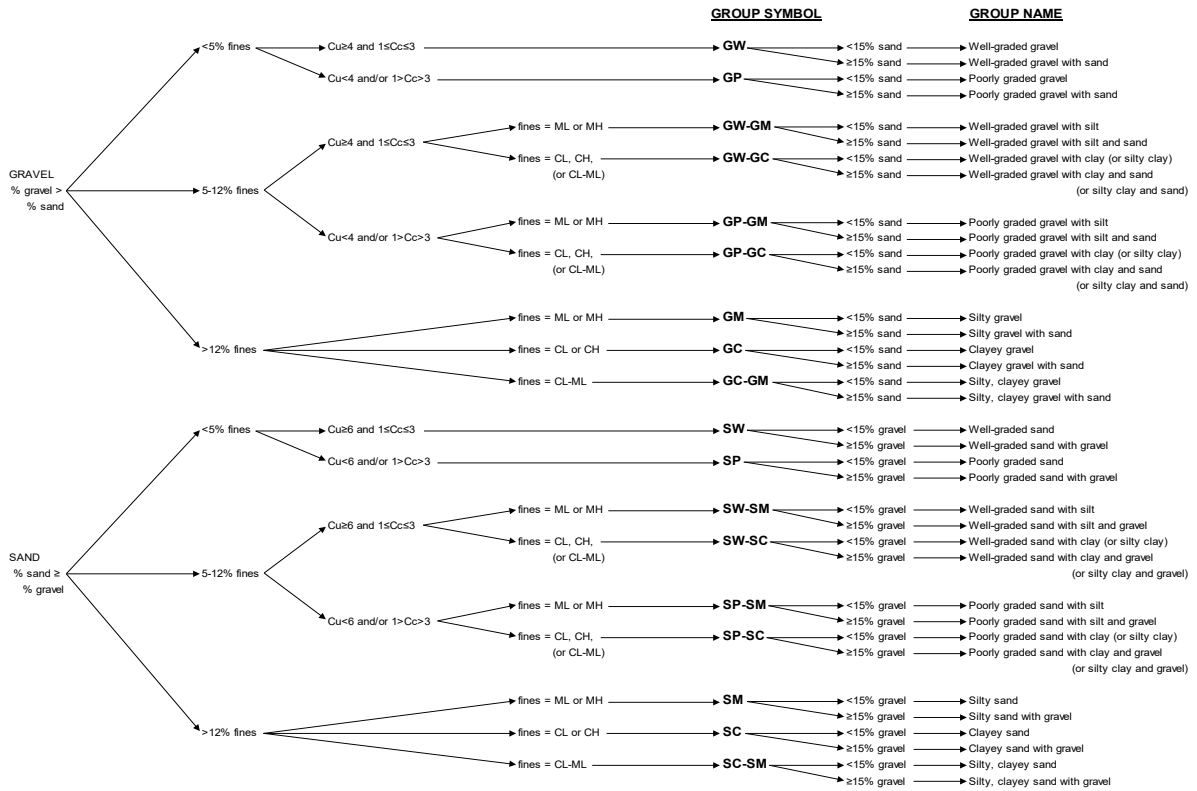

Flow Chart for Classifying Coarse-Grained Soils (More Than 50% Retained on No. 200 Sieve)

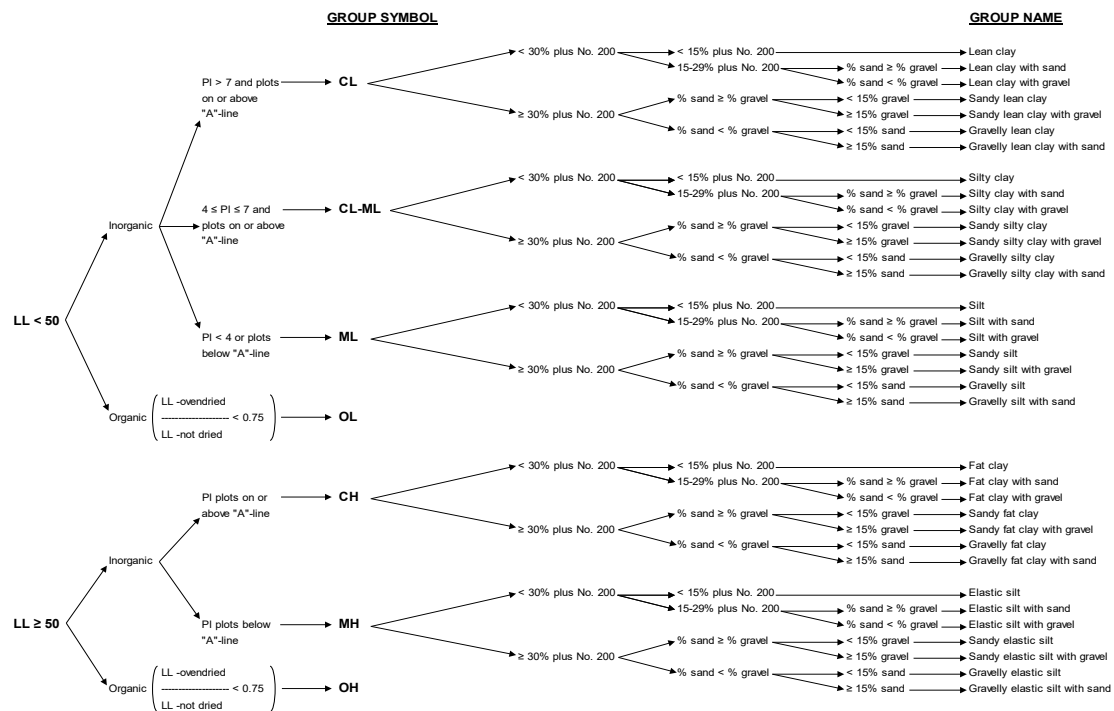

Flow Chart for Classifying Fine-Grained Soil (50% or More Passes No. 200 Sieve)

ROCK CLASSIFICATION SYSTEM

STRENGTH	DESCRIPTION	UNCONFINED COMPRESSIVE STRENGTH (PSI)
Extremely Weak (R0)	Easily indented by thumbnail	35 to 150
Very Weak (R1)	Scratched with fingernail, peeled by knife, indented by rock pick	150 to 275
Weak (R2)	Peeled by knife, indented by rock pick	725 to 3,500
Medium Strong (R3)	Cannot be peeled or scraped with a knife	3,500 to 7,250
Strong (R4)	Requires more than one blow with a rock hammer to fracture it	7,250 to 14,500
Very Strong (R5)	Requires many blows with a rock hammer to fracture it	14,500 to 36,250
Extremely Strong (R6)	Can only be chipped with a rock hammer	Greater than 36,250

WEATHERING	DESCRIPTION
Decomposed	A soil formed in place with original texture of rock destroyed
Completely Weathered	Rock wholly weathered but rock texture preserved
Highly Weathered	Rock weakened so that large pieces can be broken by hand
Moderately Weathered	Rock mass is decomposed locally
Slightly Weathered	Discoloration along discontinuities
Fresh	No visible signs of weathering or discoloring

JOINT SPACING	DESCRIPTION
Very Close	Less than 0.2 foot
Close	0.2 foot to 1 foot
Moderately Close	1 foot to 3 feet
Wide	3 feet to 10 feet
Very Wide	Greater than 10 feet

FRACTURING	FRACTURE SPACING
Very Intensely Fractured	Chips, fragments, with scattered short core lengths
Intensely Fractured	0.1 foot to 0.3 foot with scattered fragments
Moderately Fractured	0.3 foot to 1 foot
Slightly Fractured	1 foot to 3 feet
Very Slightly Fractured	Greater than 3 feet
Unfractured	No fractures observed

HEALING	DESCRIPTION
Not Healed	Discontinued surface, fractured zone, sheared material, filling is not cemented
Partly Healed	Less than 50% of fractures or sheared zone bonding
Moderately Healed	Greater than 50% fractures or sheared zone bonding
Totally Healed	All fragments are bonded

QUALITY	RQD (%)
Very poor	Less than 25%
Poor	25 to 50%
Fair	51 to 75%
Good	76 to 90%

Rock Quality Designation (RQD) is a measure of quality of rock core taken from a borehole. The length of core pieces is measured along center line of the pieces. All pieces of intact rock core equal to or greater than 100 mm (4 in.) long are summed and divided by the total length of the core run to obtain RQD value

**APPENDIX D
PHOTO LOG**

SEASON ON MEEKER PUYALLUP, WASHINGTON



Western Site View, Facing North, View from Southwest Corner

SEASON ON MEEKER PUYALLUP, WASHINGTON



Central Site View, Facing Southeast, View from North Central

SEASON ON MEEKER PUYALLUP, WASHINGTON



Eastern Site View, Facing South, View from Northeast Corner

SEASON ON MEEKER PUYALLUP, WASHINGTON



Southern Site View, Facing West, View form Southeast Corner



SEASON ON MEEKER PUYALLUP, WASHINGTON



Test Pit Profile, TP-1



SEASON ON MEEKER PUYALLUP, WASHINGTON



Test Pit Profile, TP-3

APPENDIX E
REPORT LIMITATIONS AND IMPORTANT
INFORMATION

Date: August 18, 2023
Project: Season on Meeker
Puyallup, Washington

Geotechnical and Environmental Report Limitations and Important Information

Report Purpose, Use, and Standard of Care

This report has been prepared in accordance with standard fundamental principles and practices of geotechnical engineering and/or environmental consulting, and in a manner consistent with the level of care and skill typical of currently practicing local engineers and consultants. This report has been prepared to meet the specific needs of specific individuals for the indicated site. It may not be adequate for use by other consultants, contractors, or engineers, or if change in project ownership has occurred. It should not be used for any other reason than its stated purpose without prior consultation with Columbia West Engineering, Inc. (Columbia West). It is a unique report and not applicable for any other site or project. If site conditions are altered, or if modifications to the project description or proposed plans are made after the date of this report, it may not be valid. Columbia West cannot accept responsibility for use of this report by other individuals for unauthorized purposes, or if problems occur resulting from changes in site conditions for which Columbia West was not aware or informed.

Report Conclusions and Preliminary Nature

This geotechnical or environmental report should be considered preliminary and summary in nature. The recommendations contained herein have been established by engineering interpretations of subsurface soils based upon conditions observed during site exploration. The exploration and associated laboratory analysis of collected representative samples identifies soil conditions at specific discreet locations. It is assumed that these conditions are indicative of actual conditions throughout the subject property. However, soil conditions may differ between tested locations at different seasonal times of the year, either by natural causes or human activity. Distinction between soil types may be more abrupt or gradual than indicated on the soil logs. This report is not intended to stand alone without understanding of concomitant instructions, correspondence, communication, or potential supplemental reports that may have been provided to the client.

Because this report is based upon observations obtained at the time of exploration, its adequacy may be compromised with time. This is particularly relevant in the case of natural disasters, earthquakes, floods, or other significant events. Report conclusions or interpretations may also be subject to revision if significant development or other manmade impacts occur within or in proximity to the subject property. Groundwater conditions, if presented in this report, reflect observed conditions at the time of investigation. These conditions may change annually, seasonally or as a result of adjacent development.

Additional Investigation and Construction QA/QC

Columbia West should be consulted prior to construction to assess whether additional investigation above and beyond that presented in this report is necessary. Even slight variations in soil or site conditions may produce impacts to the performance of structural facilities if not adequately addressed. This underscores the importance of diligent QA/QC construction observation and testing to verify soil conditions do not differ materially or significantly from the interpreted conditions utilized for preparation of this report.

Therefore, this report contains several recommendations for field observation and testing by Columbia West personnel during construction activities. Actual subsurface conditions are more readily observed and discerned during the earthwork phase of construction when soils are exposed. Columbia West cannot accept responsibility for deviations from recommendations described in this report or future

performance of structural facilities if another consultant is retained during the construction phase or Columbia West is not engaged to provide construction observation to the full extent recommended.

Collected Samples

Uncontaminated samples of soil or rock collected in connection with this report will be retained for thirty days. Retention of such samples beyond thirty days will occur only at client's request and in return for payment of storage charges incurred. All contaminated or environmentally impacted materials or samples are the sole property of the client. Client maintains responsibility for proper disposal.

Report Contents

This geotechnical or environmental report should not be copied or duplicated unless in full, and even then only under prior written consent by Columbia West, as indicated in further detail in the following text section entitled *Report Ownership*. The recommendations, interpretations, and suggestions presented in this report are only understandable in context of reference to the whole report. Under no circumstances should the soil boring or test pit excavation logs, monitor well logs, or laboratory analytical reports be separated from the remainder of the report. The logs or reports should not be redrawn or summarized by other entities for inclusion in architectural or civil drawings, or other relevant applications.

Report Limitations for Contractors

Geotechnical or environmental reports, unless otherwise specifically noted, are not prepared for the purpose of developing cost estimates or bids by contractors. The extent of exploration or investigation conducted as part of this report is usually less than that necessary for contractor's needs. Contractors should be advised of these report limitations, particularly as they relate to development of cost estimates. Contractors may gain valuable information from this report, but should rely upon their own interpretations as to how subsurface conditions may affect cost, feasibility, accessibility and other components of the project work. If believed necessary or relevant, contractors should conduct additional exploratory investigation to obtain satisfactory data for the purposes of developing adequate cost estimates. Clients or developers cannot insulate themselves from attendant liability by disclaiming accuracy for subsurface ground conditions without advising contractors appropriately and providing the best information possible to limit potential for cost overruns, construction problems, or misunderstandings.

Report Ownership

Columbia West retains the ownership and copyright property rights to this entire report and its contents, which may include, but may not be limited to, figures, text, logs, electronic media, drawings, laboratory reports, and appendices. This report was prepared solely for the client, and other relevant approved users or parties, and its distribution must be contingent upon prior express written consent by Columbia West. Furthermore, client or approved users may not use, lend, sell, copy, or distribute this document without express written consent by Columbia West. Client does not own nor have rights to electronic media files that constitute this report, and under no circumstances should said electronic files be distributed or copied. Electronic media is susceptible to unauthorized manipulation or modification, and may not be reliable.

Consultant Responsibility

Geotechnical and environmental engineering and consulting is much less exact than other scientific or engineering disciplines, and relies heavily upon experience, judgment, interpretation, and opinion often based upon media (soils) that are variable, anisotropic, and non-homogenous. This often results in unrealistic expectations, unwarranted claims, and uninformed disputes against a geotechnical or environmental consultant. To reduce potential for these problems and assist relevant parties in better understanding of risk, liability, and responsibility, geotechnical and environmental reports often provide definitive statements or clauses defining and outlining consultant responsibility. The client is encouraged to read these statements carefully and request additional information from Columbia West if necessary.

Appendix B – Documentation (Design Calculations)

WWHM2012
PROJECT REPORT

WATER QUALITY AND CONVEYANCE ONLY

General Model Information

WWHM2012 Project Name: 2025-11-24 Seasons on Meeker

Site Name: Seasons on Meeker
Site Address: 115 2nd St SE
City: Puyallup
Report Date: 12/3/2025
Gage: SPU 158 Year 5min
Data Start: 10/01/1901
Data End: 09/30/2059
Timestep: 15 Minute
Precip Scale: 1.000
Version Date: 2025/05/13
Version: 4.3.2

POC Thresholds

Low Flow Threshold for POC1:	50 Percent of the 2 Year
High Flow Threshold for POC1:	50 Year

Landuse Basin Data

Predeveloped Land Use

Basin A

Bypass:	No
GroundWater:	No
Pervious Land Use C, Forest, Flat	acre 1.827
Pervious Total	1.827
Impervious Land Use	acre
Impervious Total	0
Basin Total	1.827

Element Flow Componants:
Surface Interflow Groundwater
Componant Flows To:
POC 1 POC 1

Mitigated Land Use

Basin 1

Bypass:	No
GroundWater:	No
Pervious Land Use C, Pasture, Flat	acre 0.055
Pervious Total	0.055
Impervious Land Use	acre
ROOF TOPS FLAT	0.987
SIDEWALKS FLAT	0.207
PARKING FLAT	0.578
Impervious Total	1.772
Basin Total	1.827

Element Flow Components:
Surface Interflow Groundwater
Component Flows To:
POC 1 POC 1

Routing Elements
Predeveloped Routing

Mitigated Routing

Analysis Results

POC 1

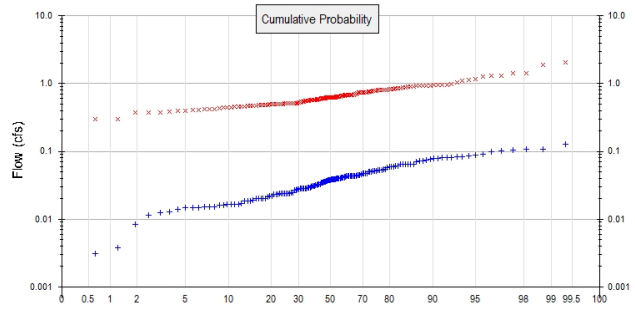
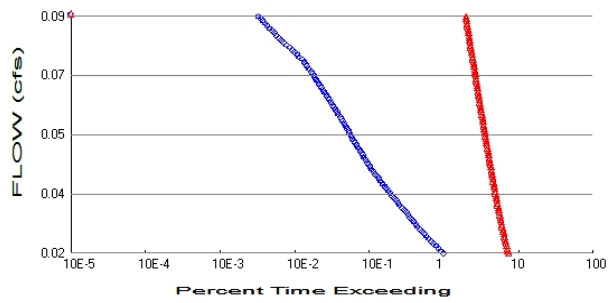

+ Predeveloped x Mitigated

Predeveloped Landuse Totals for POC #1

Total Pervious Area: 1.827
 Total Impervious Area: 0

Mitigated Landuse Totals for POC #1

Total Pervious Area: 0.055
 Total Impervious Area: 1.772

Flow Frequency Method: Log Pearson Type III 17B

Flow Frequency Return Periods for Predeveloped. POC #1

Return Period	Flow(cfs)
2 year	0.0385
5 year	0.059895
10 year	0.07152
25 year	0.083352
50 year	0.090385
100 year	0.096168

Flow Frequency Return Periods for Mitigated. POC #1

Return Period	Flow(cfs)
2 year	0.621605
5 year	0.834384
10 year	0.989031
25 year	1.200685
50 year	1.37055
100 year	1.551202

Annual Peaks

Annual Peaks for Predeveloped and Mitigated. POC #1

Year	Predeveloped	Mitigated
1902	0.028	0.734
1903	0.023	0.814
1904	0.038	0.924
1905	0.018	0.413
1906	0.008	0.462
1907	0.059	0.620
1908	0.044	0.509
1909	0.043	0.627
1910	0.060	0.599
1911	0.039	0.673

1912	0.128	1.120
1913	0.061	0.485
1914	0.015	2.038
1915	0.025	0.419
1916	0.038	0.782
1917	0.013	0.295
1918	0.041	0.626
1919	0.030	0.384
1920	0.039	0.510
1921	0.044	0.438
1922	0.044	0.687
1923	0.035	0.479
1924	0.016	0.904
1925	0.020	0.378
1926	0.037	0.737
1927	0.024	0.600
1928	0.030	0.446
1929	0.061	0.888
1930	0.039	0.930
1931	0.036	0.448
1932	0.028	0.484
1933	0.027	0.480
1934	0.081	0.781
1935	0.037	0.413
1936	0.033	0.578
1937	0.052	0.860
1938	0.032	0.420
1939	0.002	0.528
1940	0.035	0.932
1941	0.017	0.921
1942	0.053	0.694
1943	0.027	0.687
1944	0.050	0.987
1945	0.044	0.748
1946	0.024	0.581
1947	0.015	0.452
1948	0.083	0.623
1949	0.071	0.961
1950	0.020	0.544
1951	0.025	0.823
1952	0.108	0.926
1953	0.097	0.857
1954	0.035	0.506
1955	0.029	0.470
1956	0.014	0.463
1957	0.050	0.501
1958	0.104	0.623
1959	0.064	0.625
1960	0.017	0.495
1961	0.065	1.411
1962	0.035	0.607
1963	0.017	0.451
1964	0.018	1.307
1965	0.072	0.587
1966	0.020	0.491
1967	0.031	0.688
1968	0.032	0.579
1969	0.032	0.523

1970	0.050	0.595
1971	0.078	0.577
1972	0.051	1.903
1973	0.065	1.105
1974	0.035	0.800
1975	0.082	0.828
1976	0.043	0.882
1977	0.015	0.378
1978	0.073	0.640
1979	0.020	0.670
1980	0.041	0.661
1981	0.040	0.622
1982	0.016	0.507
1983	0.065	0.688
1984	0.026	0.684
1985	0.043	0.778
1986	0.039	0.396
1987	0.073	0.693
1988	0.047	0.414
1989	0.042	0.378
1990	0.047	0.501
1991	0.037	0.746
1992	0.053	0.710
1993	0.051	0.811
1994	0.077	0.555
1995	0.015	0.432
1996	0.085	0.579
1997	0.032	0.519
1998	0.039	0.617
1999	0.003	0.669
2000	0.029	0.589
2001	0.015	0.472
2002	0.054	0.859
2003	0.047	0.501
2004	0.043	0.750
2005	0.079	1.432
2006	0.024	0.672
2007	0.024	0.752
2008	0.041	0.620
2009	0.028	0.473
2010	0.024	0.607
2011	0.019	0.638
2012	0.028	0.593
2013	0.022	0.559
2014	0.016	0.541
2015	0.031	0.910
2016	0.012	0.568
2017	0.059	0.911
2018	0.108	0.549
2019	0.101	0.812
2020	0.033	0.662
2021	0.053	0.559
2022	0.022	0.948
2023	0.045	1.171
2024	0.084	1.257
2025	0.040	0.610
2026	0.065	0.670
2027	0.023	0.747

2028	0.020	0.292
2029	0.044	0.481
2030	0.081	0.962
2031	0.027	0.303
2032	0.015	0.512
2033	0.024	0.643
2034	0.023	0.504
2035	0.092	0.623
2036	0.048	0.503
2037	0.011	0.676
2038	0.038	0.644
2039	0.004	1.290
2040	0.021	0.505
2041	0.029	0.641
2042	0.089	0.739
2043	0.043	0.817
2044	0.058	0.562
2045	0.040	0.455
2046	0.046	0.504
2047	0.034	0.622
2048	0.044	0.513
2049	0.040	0.761
2050	0.028	0.568
2051	0.041	0.801
2052	0.024	0.610
2053	0.042	0.519
2054	0.054	1.031
2055	0.017	0.630
2056	0.019	0.813
2057	0.029	0.400
2058	0.037	0.766
2059	0.065	0.955

Ranked Annual Peaks

Ranked Annual Peaks for Predeveloped and Mitigated. POC #1

Rank	Predeveloped	Mitigated
1	0.1282	2.0378
2	0.1080	1.9025
3	0.1079	1.4321
4	0.1042	1.4110
5	0.1006	1.3068
6	0.0974	1.2900
7	0.0918	1.2573
8	0.0893	1.1713
9	0.0846	1.1200
10	0.0845	1.1049
11	0.0828	1.0308
12	0.0821	0.9866
13	0.0814	0.9621
14	0.0806	0.9613
15	0.0791	0.9546
16	0.0782	0.9480
17	0.0772	0.9324
18	0.0735	0.9298
19	0.0731	0.9258
20	0.0725	0.9238
21	0.0710	0.9212
22	0.0651	0.9111

23	0.0648	0.9105
24	0.0648	0.9041
25	0.0648	0.8883
26	0.0646	0.8819
27	0.0644	0.8596
28	0.0614	0.8589
29	0.0611	0.8566
30	0.0597	0.8281
31	0.0593	0.8228
32	0.0591	0.8175
33	0.0582	0.8140
34	0.0539	0.8132
35	0.0537	0.8123
36	0.0534	0.8108
37	0.0531	0.8008
38	0.0528	0.8001
39	0.0519	0.7818
40	0.0515	0.7812
41	0.0507	0.7783
42	0.0499	0.7655
43	0.0498	0.7612
44	0.0497	0.7519
45	0.0477	0.7495
46	0.0474	0.7476
47	0.0467	0.7470
48	0.0466	0.7462
49	0.0464	0.7392
50	0.0449	0.7366
51	0.0442	0.7343
52	0.0440	0.7095
53	0.0439	0.6942
54	0.0439	0.6928
55	0.0438	0.6882
56	0.0438	0.6881
57	0.0434	0.6873
58	0.0433	0.6865
59	0.0431	0.6839
60	0.0430	0.6765
61	0.0430	0.6727
62	0.0424	0.6718
63	0.0419	0.6700
64	0.0414	0.6696
65	0.0412	0.6689
66	0.0411	0.6624
67	0.0409	0.6607
68	0.0397	0.6436
69	0.0396	0.6433
70	0.0396	0.6408
71	0.0396	0.6395
72	0.0393	0.6384
73	0.0392	0.6303
74	0.0389	0.6268
75	0.0386	0.6260
76	0.0385	0.6248
77	0.0384	0.6231
78	0.0384	0.6226
79	0.0380	0.6226
80	0.0374	0.6222

81	0.0373	0.6218
82	0.0371	0.6197
83	0.0369	0.6196
84	0.0364	0.6170
85	0.0353	0.6104
86	0.0352	0.6097
87	0.0351	0.6068
88	0.0350	0.6068
89	0.0348	0.6001
90	0.0342	0.5991
91	0.0328	0.5951
92	0.0325	0.5933
93	0.0325	0.5888
94	0.0318	0.5873
95	0.0317	0.5810
96	0.0316	0.5794
97	0.0312	0.5788
98	0.0311	0.5785
99	0.0304	0.5769
100	0.0298	0.5678
101	0.0294	0.5677
102	0.0291	0.5621
103	0.0287	0.5593
104	0.0285	0.5590
105	0.0285	0.5546
106	0.0284	0.5487
107	0.0282	0.5439
108	0.0281	0.5406
109	0.0280	0.5284
110	0.0275	0.5230
111	0.0272	0.5187
112	0.0269	0.5186
113	0.0264	0.5130
114	0.0247	0.5121
115	0.0247	0.5104
116	0.0242	0.5087
117	0.0240	0.5067
118	0.0239	0.5063
119	0.0239	0.5055
120	0.0238	0.5041
121	0.0237	0.5037
122	0.0236	0.5028
123	0.0235	0.5014
124	0.0233	0.5005
125	0.0232	0.5005
126	0.0221	0.4945
127	0.0219	0.4908
128	0.0211	0.4854
129	0.0203	0.4844
130	0.0202	0.4810
131	0.0201	0.4800
132	0.0200	0.4787
133	0.0200	0.4726
134	0.0193	0.4716
135	0.0187	0.4700
136	0.0185	0.4635
137	0.0183	0.4619
138	0.0171	0.4552

139	0.0167	0.4524
140	0.0167	0.4506
141	0.0167	0.4485
142	0.0163	0.4460
143	0.0162	0.4384
144	0.0161	0.4316
145	0.0150	0.4204
146	0.0150	0.4186
147	0.0150	0.4138
148	0.0148	0.4131
149	0.0146	0.4130
150	0.0146	0.3998
151	0.0141	0.3958
152	0.0128	0.3836
153	0.0124	0.3785
154	0.0114	0.3779
155	0.0083	0.3779
156	0.0038	0.3027
157	0.0031	0.2953
158	0.0020	0.2924

Duration Flows

The Duration Matching **Failed**

Flow(cfs)	Predev	Mit	Percentage	Pass/Fail
0.0193	54276	405366	746	Fail
0.0200	50210	397832	792	Fail
0.0207	46603	390408	837	Fail
0.0214	43334	383428	884	Fail
0.0221	40271	376558	935	Fail
0.0228	37456	370076	988	Fail
0.0236	34908	363816	1042	Fail
0.0243	32587	357777	1097	Fail
0.0250	30343	351849	1159	Fail
0.0257	28276	346032	1223	Fail
0.0264	26432	340492	1288	Fail
0.0272	24792	335118	1351	Fail
0.0279	23285	329911	1416	Fail
0.0286	21928	324869	1481	Fail
0.0293	20648	319883	1549	Fail
0.0300	19429	314897	1620	Fail
0.0307	18288	310133	1695	Fail
0.0315	17224	305479	1773	Fail
0.0322	16155	300936	1862	Fail
0.0329	15141	296560	1958	Fail
0.0336	14266	292405	2049	Fail
0.0343	13451	288416	2144	Fail
0.0351	12670	284150	2242	Fail
0.0358	11944	280216	2346	Fail
0.0365	11246	276283	2456	Fail
0.0372	10559	272516	2580	Fail
0.0379	9972	268693	2694	Fail
0.0387	9374	264926	2826	Fail
0.0394	8853	261436	2953	Fail
0.0401	8332	257945	3095	Fail
0.0408	7861	254511	3237	Fail
0.0415	7462	251131	3365	Fail
0.0422	7030	247752	3524	Fail
0.0430	6609	244538	3700	Fail
0.0437	6271	241325	3848	Fail
0.0444	5978	238223	3984	Fail
0.0451	5701	235065	4123	Fail
0.0458	5437	231962	4266	Fail
0.0466	5197	228971	4405	Fail
0.0473	4942	225979	4572	Fail
0.0480	4703	223043	4742	Fail
0.0487	4513	220218	4879	Fail
0.0494	4338	217448	5012	Fail
0.0501	4158	214677	5162	Fail
0.0509	3958	211963	5355	Fail
0.0516	3764	209304	5560	Fail
0.0523	3577	206700	5778	Fail
0.0530	3411	204151	5985	Fail
0.0537	3265	201714	6178	Fail
0.0545	3134	199165	6354	Fail
0.0552	3027	196672	6497	Fail
0.0559	2926	194345	6642	Fail
0.0566	2813	191797	6818	Fail
0.0573	2682	189470	7064	Fail

0.0581	2555	187199	7326	Fail
0.0588	2451	184927	7544	Fail
0.0595	2359	182656	7742	Fail
0.0602	2256	180495	8000	Fail
0.0609	2140	178279	8330	Fail
0.0616	2038	176119	8641	Fail
0.0624	1952	173958	8911	Fail
0.0631	1859	171853	9244	Fail
0.0638	1778	169858	9553	Fail
0.0645	1690	167864	9932	Fail
0.0652	1619	165759	10238	Fail
0.0660	1561	163820	10494	Fail
0.0667	1482	161881	10923	Fail
0.0674	1407	159942	11367	Fail
0.0681	1338	158003	11808	Fail
0.0688	1270	156174	12297	Fail
0.0695	1217	154346	12682	Fail
0.0703	1163	152463	13109	Fail
0.0710	1103	150634	13656	Fail
0.0717	1055	148862	14110	Fail
0.0724	1005	147144	14641	Fail
0.0731	963	145371	15095	Fail
0.0739	919	143654	15631	Fail
0.0746	872	141936	16277	Fail
0.0753	814	140219	17225	Fail
0.0760	773	138557	17924	Fail
0.0767	737	136950	18582	Fail
0.0775	694	135288	19493	Fail
0.0782	636	133737	21027	Fail
0.0789	601	132186	21994	Fail
0.0796	553	130579	23612	Fail
0.0803	517	129083	24967	Fail
0.0810	478	127588	26692	Fail
0.0818	433	126092	29120	Fail
0.0825	394	124596	31623	Fail
0.0832	363	123100	33911	Fail
0.0839	339	121604	35871	Fail
0.0846	310	120164	38762	Fail
0.0854	295	118779	40264	Fail
0.0861	273	117394	43001	Fail
0.0868	252	116009	46035	Fail
0.0875	237	114624	48364	Fail
0.0882	223	113350	50829	Fail
0.0889	206	112020	54378	Fail
0.0897	194	110746	57085	Fail
0.0904	180	109472	60817	Fail

The development has an increase in flow durations from 1/2 Predeveloped 2 year flow to the 2 year flow or more than a 10% increase from the 2 year to the 50 year flow.

The development has an increase in flow durations for more than 50% of the flows for the range of the duration analysis.

Water Quality

Water Quality BMP Flow and Volume for POC #1

On-line facility volume: 0.0855 acre-feet

On-line facility target flow: 0.116 cfs.

Adjusted for 15 min: 0.116 cfs.

Off-line facility target flow: 0.0668 cfs.

Adjusted for 15 min: 0.0668 cfs.

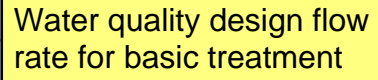

Water quality design flow
rate for basic treatment

Model Default Modifications

Total of 0 changes have been made.

PERLND Changes

No PERLND changes have been made.

IMPLND Changes

No IMPLND changes have been made.

Appendix
Predeveloped Schematic

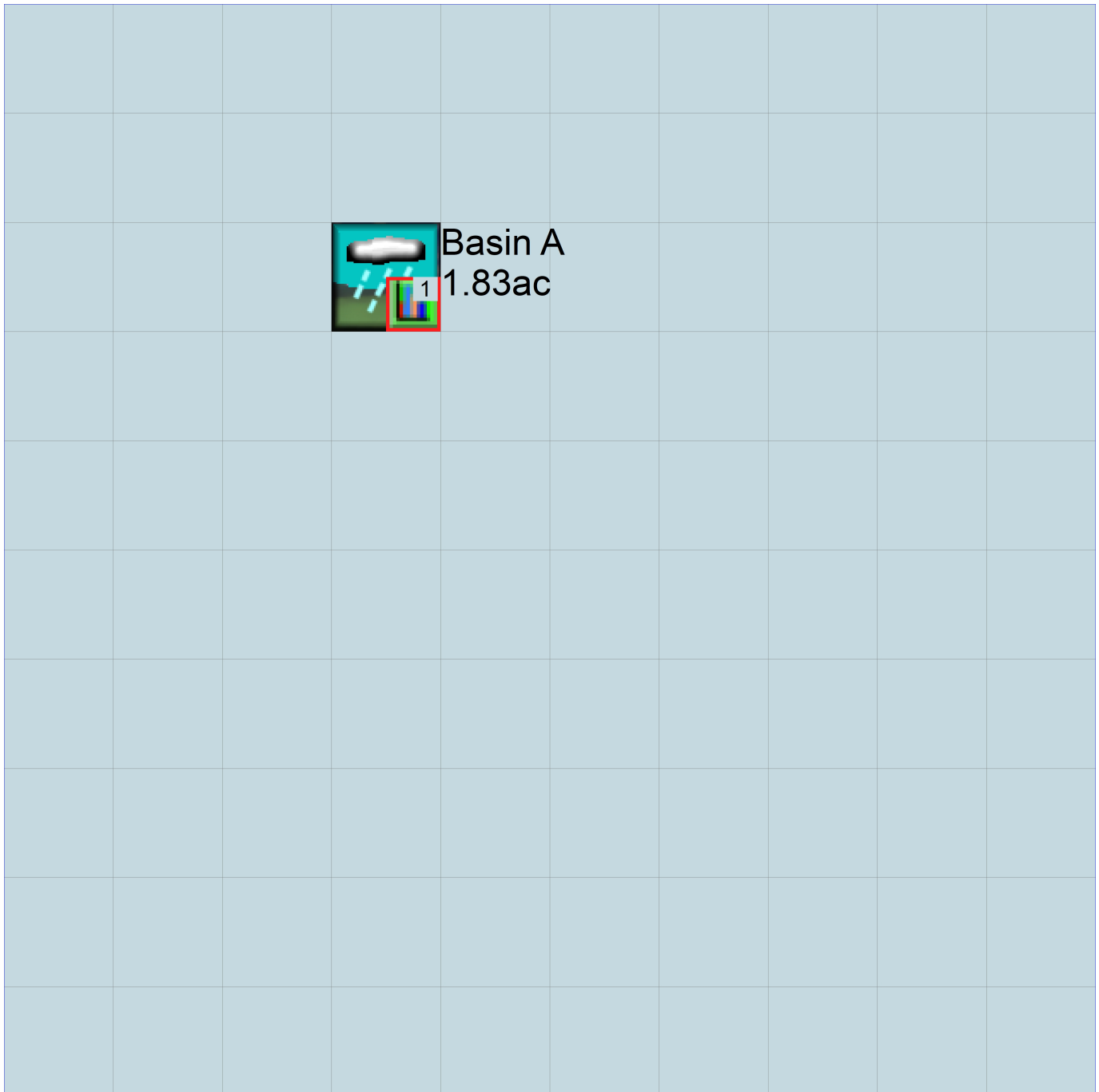

Mitigated Schematic

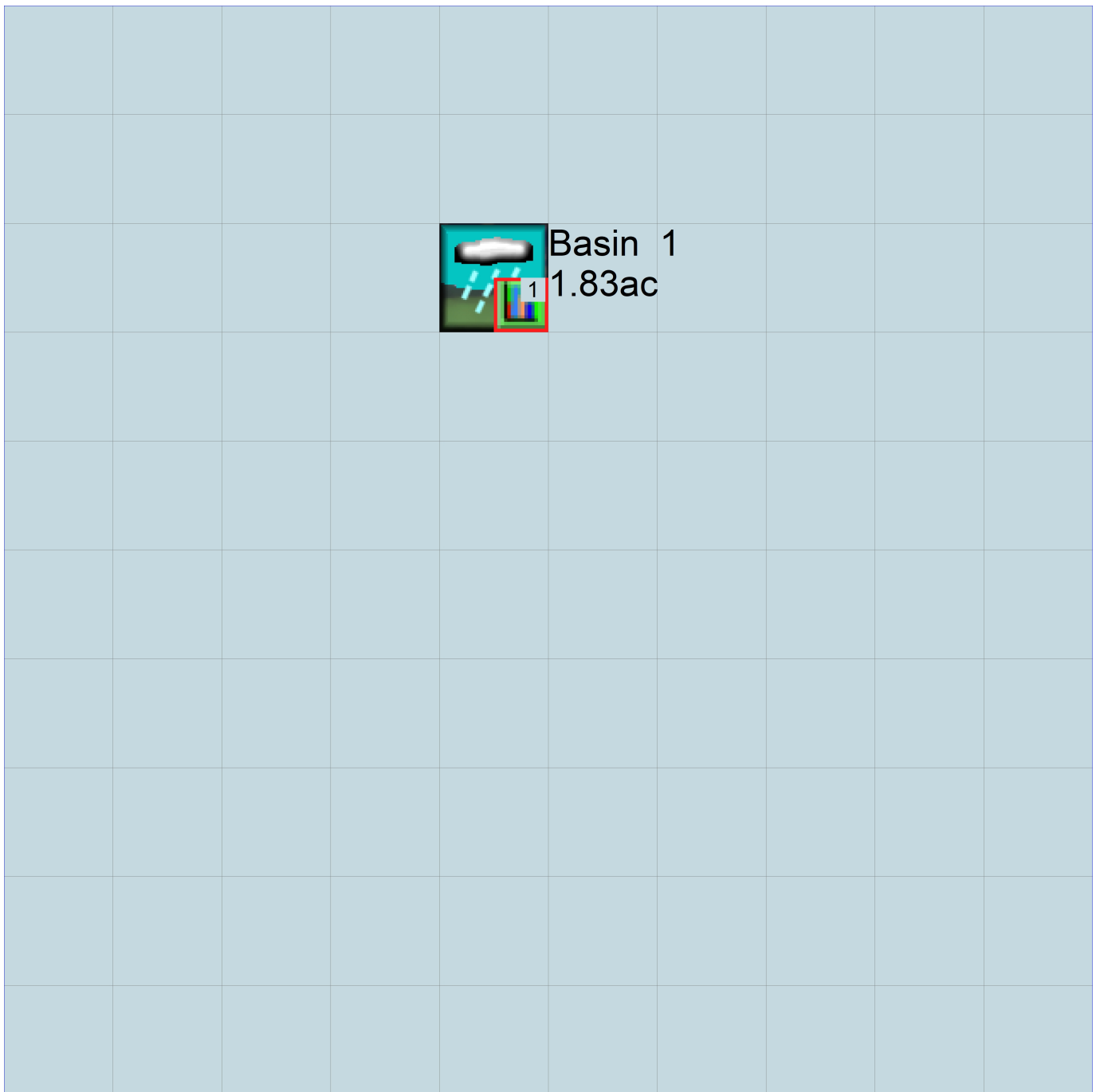

Mitigated UCI File

Predeveloped HSPF Message File

Mitigated HSPF Message File

Disclaimer

Legal Notice

This program and accompanying documentation is provided 'as-is' without warranty of any kind. The entire risk regarding the performance and results of this program is assumed by the user. Clear Creek Solutions, Inc. disclaims all warranties, either expressed or implied, including but not limited to implied warranties of program and accompanying documentation. In no event shall Clear Creek Solutions, Inc. be liable for any damages whatsoever (including without limitation to damages for loss of business profits, loss of business information, business interruption, and the like) arising out of the use of, or inability to use this program even if Clear Creek Solutions, Inc. has been advised of the possibility of such damages.

Clear Creek Solutions, Inc.
6200 Capitol Blvd. Ste F
Olympia, WA. 98501
Toll Free 1(866)943-0304
Local (360)943-0304

www.clearcreeksolutions.com

MANNING'S EQUATION FOR PIPE FLOW

Project:	Seasons on Meeker	Location:	115 2nd St SE
By:	WL	Date:	11/24/2025
Chk. By:	JAC	Date:	11/24/2025
		mdo	version 12.8.00

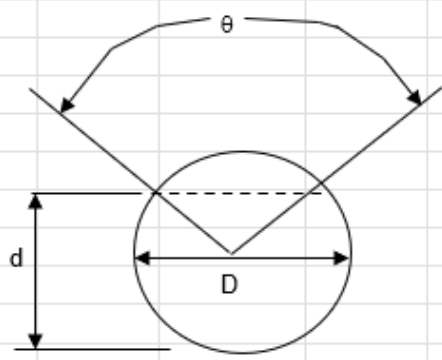

INPUT

D=	12 inches
d=	8 inches
n=	0.012 mannings coeff
θ=	141.1 degrees
S=	0.005 slope in/in

Mannings Formula

$$Q = (1.486/n) A R_h^{2/3} S^{1/2}$$

- R=A/P
- A=cross sectional area
- P=wetted perimeter
- S=slope of channel
- n=Manning's roughness coefficient

$$V = (1.49/n) R_h^{2/3} S^{1/2}$$

$$Q = V \times A$$

Solution to Mannings Equation					Manning's n-values	
Area, ft ²	Wetted Perimeter, ft	Hydraulic Radius, ft	velocity ft/s	flow, cfs		
0.56	1.91	0.29	3.85	2.14	PVC	0.01
					PE (<9" dia)	0.015
					PE (>12" dia)	0.02
					PE(9-12" dia)	0.017
					CMP	0.025
					ADS N12	0.012
					HCMP	0.023
					Conc	0.013





**Appendix C – Maintenance Report
(To be provided during permitting)**

**Appendix D – Covenants, Dedications, Easements
(To be provided during permitting)**

Appendix E – Plans & Exhibits

S:\Washington\puyallup\Palmdrome\115 2nd St SE\2DWCS\SUPPORT\AREAS\PYPA-AREA-E.dwg Dec 02, 2025 - 12:41pm



BASIN A	
 ROOF	17,678 SF = 0.406 ACRES
 PAVEMENT	57,199 SF = 1.313 ACRES
 SIDEWALK/MISC	4,076 SF = 0.094 ACRES
 LANDSCAPE	624 SF = 0.014 ACRES
TOTAL	79,577 SF = 1.827 ACRES

No.	Date	By	Revision Description

Designed By:	Issue Date:
WL	11/26/2025
Drawn By:	PRELIMINARY
WL	
Checked By:	Project No.:
JAC	10-152-001

PAC LAND
 6814 Greenwood Ave. N.
 Seattle, WA 98103
 T (206) 522-9510
 www.PacLand.com

SEASONS ON MEEKER
 115 2ND ST SE
 PUYALLUP, WA



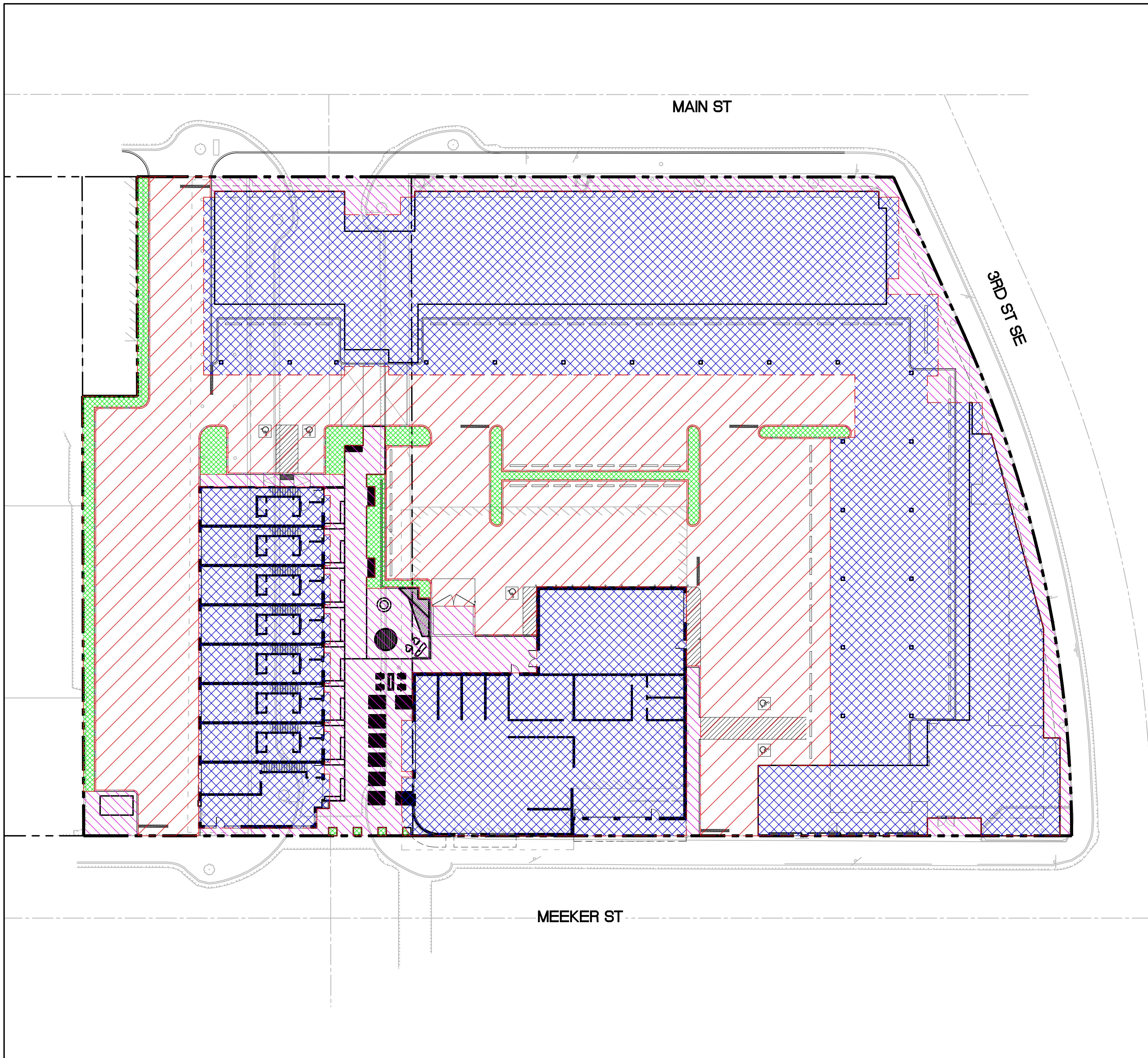

EXISTING BASIN

EX-1

S:\Washington\puyallup\Palindrome\115 2nd St SE\2DWCS\SUPPORT\AREAS\PPA-AREA-N.dwg Dec 02, 2025 - 12:45pm



BASIN 1

 ROOF	43,002 SF = 0.987 ACRES
 PAVEMENT	25,154 SF = 0.578 ACRES
 SIDEWALK/MISC	9,033 SF = 0.207 ACRES
 LANDSCAPE	2,388 SF = 0.055 ACRES
TOTAL	79,577 SF = 1.827 ACRES

No.	Date	By	Revision Description

Designed By:	Issue Date:
WL	11/26/2025
Drawn By:	PRELIMINARY
WL	
Checked By:	Project No.:
JAC	10-152-001

PAC LAND
 6814 Greenwood Ave. N.
 Seattle, WA 98103
 T (206) 522-9510
 www.PacLand.com

SEASONS ON MEEKER
 115 2ND ST SE
 PUYALLUP, WA

DEVELOPED BASIN

EX-2

S:\Washington\Puyallup\Palmadrome\115 2nd St SE\2DWCS\PPA1206.dwg Dec 03, 2025 - 4:14pm

LEGEND

- EX. CONTOUR
- RIDGE
- TYPE I CATCH BASIN
- STORM DRAIN PIPE
- ROOF DRAIN LEADER
- FOOTING DRAIN

STORM DRAINAGE NOTES

1. EXISTING DRAINAGE STRUCTURES TO BE INSPECTED AND REPAIRED AS NEEDED, AND EXISTING PIPES TO BE CLEANED OUT TO REMOVE ALL SILT AND DEBRIS.
2. IF ANY EXISTING STRUCTURES TO REMAIN ARE DAMAGED DURING CONSTRUCTION IT SHALL BE THE CONTRACTORS RESPONSIBILITY TO REPAIR AND/OR REPLACE THE EXISTING STRUCTURE AS NECESSARY TO RETURN IT TO EXISTING CONDITIONS OR BETTER.
3. STORM DRAINAGE PIPE WITH LESS THAN 2'-0" COVER SHALL BE DUCTILE IRON PIPE (AWWA C151) TO SUSTAIN H-20 LOADING.
4. ALL ON-SITE STORM DRAINAGE PIPE SHALL BE SMOOTH WALLED INTERIOR, MANUFACTURER'S VERIFICATION OF MANNING'S ROUGHNESS COEFFICIENT N=0.012 OR LESS.
5. PRECAST STRUCTURES MAY BE USED AT CONTRACTOR'S OPTION.
6. ALL CATCH BASINS AND AREA DRAINS ARE TO BE SITUATED SUCH THAT THE OUTSIDE EDGE OF GRATE FRAME IS AT TOE OF CURB OR FLOWLINE OF GUTTER (WHERE APPLICABLE).
7. CATCH BASIN INLET PROTECTION / EROSION CONTROL TO BE USED FOR ALL NEW INLETS.
8. ALL STORM PIPE ENTERING STRUCTURES SHALL BE GROUTED TO ASSURE CONNECTION AT STRUCTURE IS WATERTIGHT.
9. ALL STORM SEWER MANHOLES IN PAVED AREAS SHALL BE FLUSH WITH PAVEMENT, AND SHALL HAVE TRAFFIC BEARING RING AND COVERS. MANHOLES IN UNPAVED AREAS SHALL BE 6" ABOVE FINISH GRADE. LIDS SHALL BE LABELED "STORM SEWER".
10. CONTRACTOR SHALL CONNECT ROOF DRAIN LEADERS AND FOOTING DRAINS TO PROPOSED STORM DRAINS AS SHOWN.
11. CONTRACTOR SHALL CONFIRM STRUCTURE CONSTRUCTABILITY WITH MANUFACTURER PRIOR TO DELIVERY AND INSTALLATION.
12. PER COORDINATION WITH THE CITY OF PUYALLUP, THE PROJECT MAY DIRECTLY DISCHARGE TO THE CITY SYSTEM IN MEEKER ST WITHOUT THE NEED FOR ADDITIONAL FLOW CONTROL BMPS.

GRADING NOTES

1. THE SPOT ELEVATIONS INDICATED ON THIS PLAN REPRESENT THE DESIGN TOP OF PAVEMENT, UNLESS OTHERWISE NOTED.
2. CONTRACTOR IS RESPONSIBLE FOR DEMOLITION OF EXISTING STRUCTURES INCLUDING REMOVAL OF ANY EXISTING UTILITIES SERVING THE STRUCTURE. UTILITIES ARE TO BE REMOVED TO THE RIGHT-OF-WAY.
3. ALL UNSURFACED AREAS DISTURBED BY GRADING OPERATION SHALL RECEIVE 4 INCHES OF TOPSOIL OR AS OTHERWISE NOTED TO MEET LOW IMPACT DESIGN REQUIREMENTS. CONTRACTOR SHALL APPLY STABILIZATION FABRIC TO ALL SLOPES 3H:1V OR STEEPER. CONTRACTOR SHALL STABILIZE DISTURBED AREAS WITH GRASS IN ACCORDANCE WITH LOCAL SPECIFICATION UNTIL A HEALTHY STAND OF GRASS IS OBTAINED.
4. ALL CUT AND FILL SLOPES SHALL BE CONSTRUCTED PER THE IBC CODE AND APPLICABLE LOCAL REGULATION. ALL CUT AND FILL SLOPES SHALL BE 3:1 OR FLATTER UNLESS OTHERWISE NOTED.
5. CONTRACTOR SHALL ASSURE POSITIVE DRAINAGE AWAY FROM BUILDINGS FOR ALL NATURAL AND PAVED AREAS AND SHALL GRADE ALL AREAS TO PRECLUDE PONDING OF WATER.
6. ALL POLLUTANTS OTHER THAN SEDIMENT ON-SITE DURING CONSTRUCTION SHALL BE HANDLED AND DISPOSED OF IN A MANNER THAT DOES NOT CAUSE CONTAMINATION OF STORMWATER. THE CONTRACTOR SHALL ADHERE TO ALL TERMS AND CONDITIONS AS OUTLINED IN THE N.P.D.E.S. PERMIT FOR STORMWATER DISCHARGE ASSOCIATED WITH CONSTRUCTION ACTIVITIES.
7. PROPERTIES AND WATERWAYS DOWNSTREAM OF THE SITE SHALL BE PROTECTED FROM EROSION DUE TO INCREASES IN THE VOLUME, VELOCITY AND PEAK FLOW RATE OF STORMWATER RUNOFF FROM PROJECT SITE.
8. CONSTRUCTION SHALL COMPLY WITH ALL APPLICABLE GOVERNING CODES AND BE CONSTRUCTED TO SAME.
9. CONTRACTOR TO REMOVE UNSUITABLE SOILS LOCATED WITHIN THE BUILDINGS SPLAY LINE OF THE FOOTINGS.
10. PROPOSED GRADES SHALL BE LIMITED TO:
 - 10.1. ACCESSIBLE PARKING STALLS AND LANDINGS
 - 10.1.1. 2.0% IN ANY DIRECTION
 - 10.2. ACCESSIBLE PEDESTRIAN PATHS
 - 10.2.1. 2.0% CROSS-SLOPE
 - 10.2.2. 5.0% RUNNING SLOPE

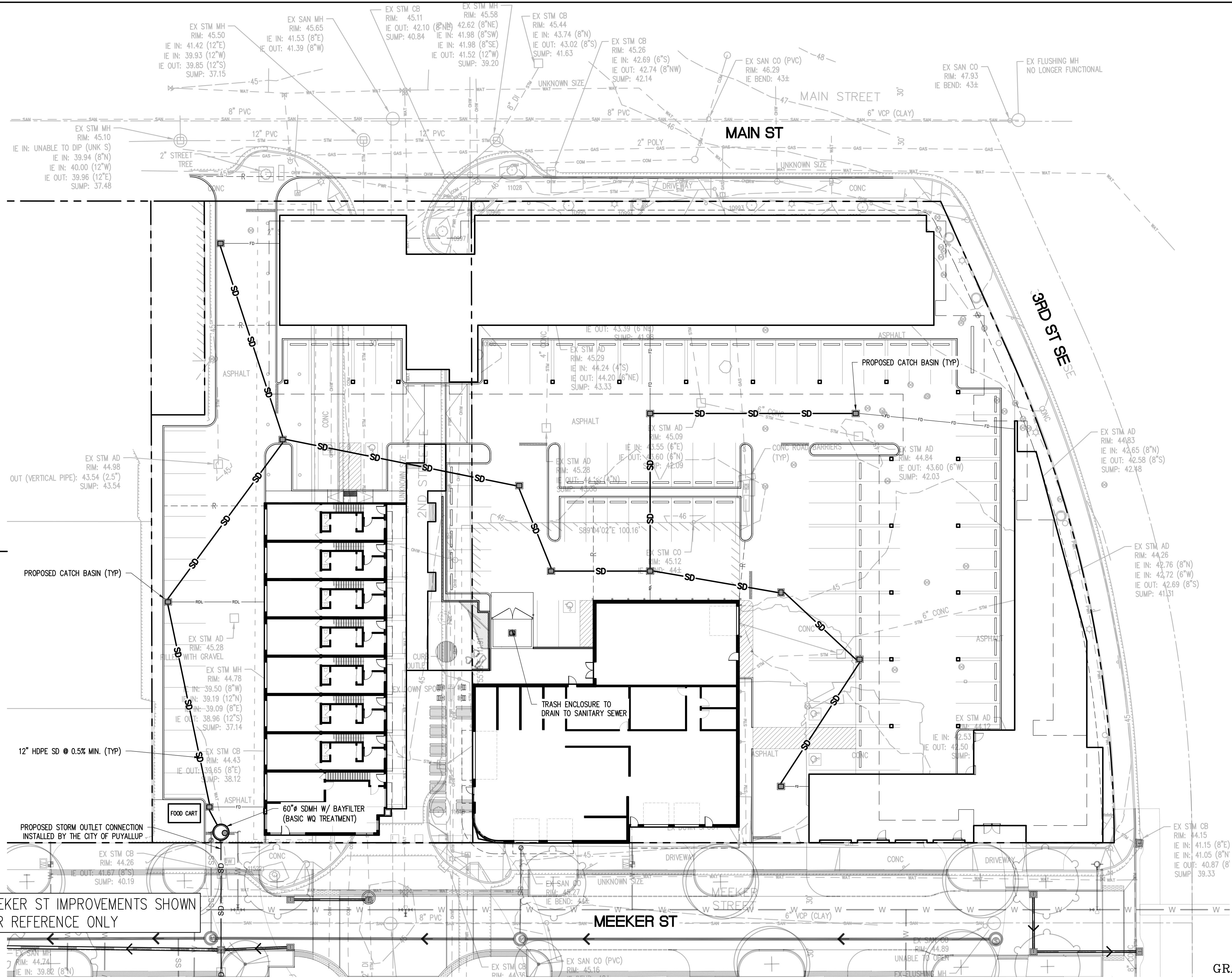

MEEKER ST IMPROVEMENTS SHOWN FOR REFERENCE ONLY

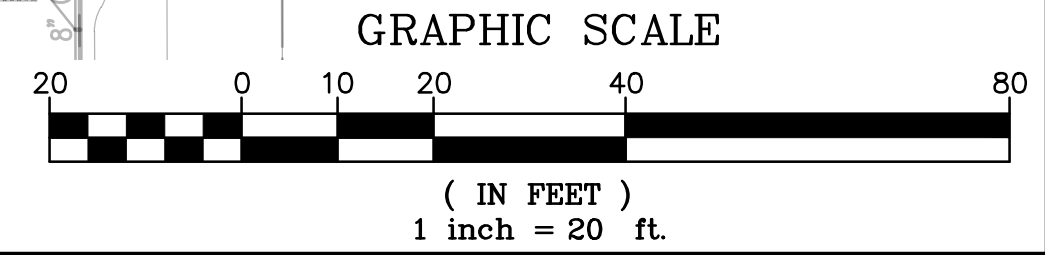

Know what's below. Call before you dig.

No.	Date	By	Revision Description

Designed By:	Issue Date:
WL	11/26/2025
Drawn By:	PRELIMINARY
WL	
Checked By:	Project No.:
JAC	10-152-001

PACLAND
 6814 Greenwood Ave N
 Seattle, WA 98103
 T (206) 522-9510
 www.PacLand.com

SEASONS ON MEEKER
 115 2ND ST SE
 PUYALLUP, WA

**PRELIMINARY
 STORMWATER SITE
 PLAN**

C-2.0

**Appendix F – CSWPPP
(To be provided during permitting)**